

papeo®

WP516

**NEW
2016**



WHEEL PARTS PIÈCES DE ROUE

paulin®

H. Paulin & Co., a division of The Hillman Group Canada ULC
55 Milne Ave., Toronto, ON Canada M1L 4N3

www.hpaulin.com

Tel: 416-694-3351 • Fax: 416-694-1869

VANCOUVER

3179 Thunderbird Cres.
Burnaby, BC
V5A 3G1
Tel: 604-421-3096
Fax: 604-421-3046

EDMONTON

11714 - 180th St.
Edmonton, AB
T5S 1N7
Tel: 780-450-1346
Fax: 780-463-3597

WINNIPEG

1670A Inkster Blvd.
Winnipeg, MB
R2X 2W8
Tel: 204-694-3802
Fax: 204-694-3804

MONTREAL

2591 Rue Debray
Laval, QC
H7S 2J4
Tel: 450-688-4292
Fax: 450-688-4750

MONCTON

159 Henri Dunant St.
Moncton, NB
E1E 1E4
Tel: 506-857-8658
Fax: 506-857-9338

WHEEL NUTS ÉCROUS DE ROUE

Passenger Car/Light Truck

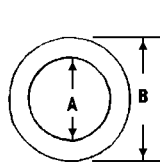

558-200

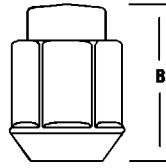

Chrome
Bulge Seat

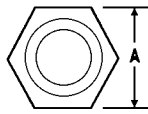

Across Flats
Reg. Mag & Acorn

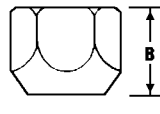

Zinc Plated
Reg. Nut

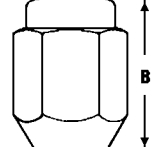

Chrome
Acorn Nut

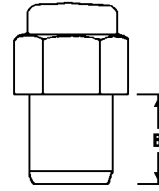

Chrome
Mag Nut

FINISHES
b = black
c = chrome
g = grey
s = stainless
z = zinc



A = Acorn B = Bulge C = Cover D = Dometop Capped E = External Thread F = Flattop Capped H = Flanged Flat M = Mag W = Wire Wheel S = Standard

Part No.	Diameter/Type	'A'	'B'	Type	St. Pkg.	Photo on Pg.	Part No.	Diameter/Type	'A'	'B'	Type	St. Pkg.	Photo on Pg.
558-014	7/16-20R Reg.	3/4	9/16	Sz	25	84	559-100	M12x1.5 Mag	13/16	3/4	Mc	10	90
558-016	1/2-20R Reg.	13/16	5/8	Sz	25	85	559-104	M12x1.5 Mag	21mm	5/16	Mc	10	90
558-027	1/2-20R Reg.	3/4	9/16	Sz	25	85	559-112	M14Rx1.5	21mm	34mm	D	10	91
558-044	5/8-18R Reg.	1-1/16	21/32	Sz	10	87	559-113	M12x1.25 Standard	21mm	16mm	Sc	10	88
558-045	5/8-18L Reg.	1-1/16	21/32	Sz	10	87	559-114	M12x1.25 Acorn	21mm	29mm	Ac	10	88
558-047	9/16-18R Reg.	1	11/16	Sz	10	86	559-117	M12x1.5 Flanged Flat	21mm	37mm	DHc	10	90
558-050	9/16-18L Reg.	1	11/16	Sz	10	86	559-125	M12x1.25 Reg.	21mm	16mm	Sz	10	88
558-055	5/8-18R Reg.	1	21/32	Sz	10	87	559-137	M12x1.5 Acorn Flanged	19mm	40mm	AHc	10	89
558-057	5/8-18R Flange	1-1/8	1-1/16	Hx	10	87	559-138	M12x1.5 Acorn Flanged	19mm	35mm	AHc	10	89
558-058	9/16-18R Reg.	1-1/16	21/32	Sz	10	86	559-141	M12x1.5 Acorn	21mm	27mm	Ac	10	89
558-061	9/16-18R Reg.	1-1/16	15/16	Sz	10	87	559-150	M12x1.5 Reg.	19mm	14mm	Sz	10	88
558-062	9/16-R Bulge	15/16	1-1/64	Bz	10	86	559-151	M12x1.5 External Thread	19mm	34mm	EHx	10	89
558-070	7/16-20 Dometop Capped	3/4	1-1/8	Ds	10	84	559-154	M14x1.5 Bulge	22mm	21mm	Bz	10	91
558-071	1/2-20 Dometop Capped	13/16	1-15/32	Ds	10	85	559-163	M12x1.5 Bulge	19mm	23mm	Bz	10	88
558-092	9/16-18R Wash. Nut	1-1/16	1	Hb	10	87	559-167	M12-1.5 Mag	21mm	47mm	Mc	10	90
558-094	1/2-20 Dometop Bulge	3/4	1-39/64	DBs	10	85	559-172	M12x1.5 Reg.	21mm	18mm	Sz	10	89
558-100	9/16-18R Reg.	7/8	3/4	Sz	10	86	559-174	M12x1.75 Flanged Flat	19mm	23mm	Hb	10	90
558-122	1/2-20 Dometop Capped	3/4	1-5/16	Ds	10	86	559-181	M12x1.5 Wirewheel	19mm	43mm	Ws	10	89
558-123	1/2-20 Dometop Capped	13/16	1-17/64	Db	10	85	559-190	M12x1.5 Dometop Capped	19mm	36mm	Ds	5	89
558-124	1/2-20 Dometop Bulge	13/16	1-9/32	DBs	10	86	559-191	M12x1.5 External Thread	19mm	28mm	Ez	5	88
558-127	9/16-18 Flanged Flat	7/8	1	Hb	10	86	559-192	M12x1.5 External Thread	19mm	31mm	Ez	5	89
558-140	7/16-20 Acorn	3/4	1-3/8	Ac	10	84	559-193	M14x1.5 External Thread	22mm	29mm	Ez	5	91
558-143	1/2-20 Dometop Capped	13/16	2-1/32	Ds	10	86	559-194	M14x1.5 External Thread	22mm	26mm	Ez	5	91
558-144	7/16-20 Acorn	13/16	1-3/8	Ac	10	84	559-196	M14x2.0 Flanged Flat	21mm	23mm	Hb	10	92
558-146	1/2-20 Acorn	13/16	1-3/8	Ac	10	85	559-200	M24x2.0 Cover Grey	18mm	29mm	Cg	5	92
558-148	1/2-20R Acorn Bulge	3/4	1-3/8	ABc	10	85	559-201	M24x2.0 Cover Stainless	19mm	39mm	Cs	5	93
558-160	1/2-20 External Thread	3/4	1-3/16	Ez	5	85	559-202	M24x2.0 Cover Black	19mm	40mm	Cb	5	92
558-162	1/2-20 Bulge	13/16	59/64	Bz	5	86	559-203	M24x2.0 Cover Grey	19mm	44mm	Cg	5	93
558-163	1/2-20 Bulge	3/4	29/32	Bz	10	85	559-204	M24x2.0 Cover Black	19mm	45mm	Cb	5	93
558-171	1/2-20 Wirewheel	3/4	1-1/4	Wz	10	85	559-205	M27x2.0 Cover Black	22mm	40mm	Cb	5	93
558-174	7/16-20 Mag	13/16	3/4	Mc	10	84	559-206	M27x2.0 Cover Black	23mm	40mm	Cg	5	93
558-176	1/2-20 Mag	13/16	3/4	Mc	10	85	559-209	M24x2.0 Cover Black	18mm	29mm	Cb	5	92
558-197	1/2-20 Wirewheel	13/16	1-5/32	Wz	10	85	559-210	M27x2.0 Cover Black	21mm	39mm	Cg	5	93
558-199	1/2-20R Wirewheel	3/4	1-1/4	Wz	10	85	559-211	M24x2.0 Cover Grey	19mm	33mm	Cg	5	92
558-200	Mag Washers	11/16	1	c	10	90	559-212	M27x2.0 Cover Black	22mm	36mm	Cb	5	93
558-204	9/16-18 Dometop Bulge	7/8	1-1/2	DBc	10	86	559-215	M24x2.0 Cover Black	19mm	33mm	Cb	5	92
558-222	1/2-20 External Thread	13/16	1.07	Sz	5	85	559-220	M24x2.0 Cover Black	19mm	33mm	Cb	5	92
558-292	1/2-20 Dometop Capped	13/16	1-1/2	Ds	10	85	559-236	M14x1.5 Flattop Capped	22mm	44.5mm	Fc	10	91
558-296	9/16-18 Flanged Flat	15/16	1-1/8	Hb	10	87	559-246	M14x1.5 Flanged Flat	21mm	23.2mm	Hb	10	91
559-060	M10x1.25 Acorn	17mm	21mm	Ac	10	87	559-257	M14-1.5 Bulge	21mm	24mm	Bz	10	91
559-064	M12x1.25 Reg.	19mm	16mm	Sc	10	88	559-259	M14-1.5 Dometop Capped	21mm	43.5mm	Dc	10	91
559-065	M12x1.25 Acorn	13/16	1-3/8	Ac	10	88	559-277	M14-1.5 Acorn	22mm	46mm	Ac	10	91
559-070	M12x1.5 Acorn	13/16	1-3/8	Ac	10	90	559-288	M14x2.0 Dometop Capped	21mm	54mm	Dc	10	92
559-074	M12x1.5 Dometop Capped	19mm	31mm	Ds	10	89	559-301	M12x1.5 Acorn Bulge	19mm	30mm	ABc	10	89
559-075	M12x1.5 Acorn	3/4	1-3/8	Ac	10	89	559-302	M14-1.5 Flanged Flat	22mm	34mm	Hb	10	91
559-077	M12x1.5 Acorn Bulge	19mm	35mm	ABc	10	89	559-305	M12x1.5 Dometop Capped	20mm	30mm	Ds	10	89
559-078	M12x1.25 Acorn	19mm	25mm	Ac	10	88	559-306	M14x2.0 Dometop Capped	20mm	50mm	Ds	10	92
559-085	M12x1.5 Wirewheel	19mm	22mm	Wb	10	88	559-308	M12x1.5 Acorn	21mm	38mm	Ac	10	90
559-087	M12x1.5 Dometop Capped	19mm	30mm	Ds	10	88	559-309	M12x1.5 Acorn	21mm	30mm	Ac	10	89
559-089	M12x1.5 Flattop Capped	19mm	32mm	Fs	10	89	559-310	M12x1.25 Dometop Capped	21mm	34mm	Dc	10	88
559-095	M12x1.25 Mag	13/16	3/4	Mc	10	88	559-323	M14x2.0 Wire Wheel	21mm	31mm	Ws	10	92

560 Series

papco®

WHEEL BOLTS BOULONS DE ROUE

Passenger Car/Light Truck
Specifications and/et Interchange.

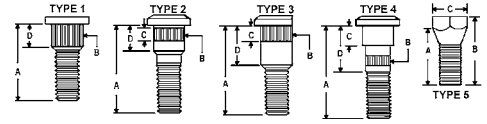

Bare Metal / Métal Nu

Standard Package / Contenant Régulier 10 pcs.

Part No.	Type	Diameter x 'A'		'B'	'C'	'D'	Factory No.	Photo on Page
560-009	5	1/2-20	R x 7/8	1-1/4	3/4 HEX	-	-	74
560-010	5	1/2-20	R x 1-1/8	1-1/2	3/4 HEX	-	-	74
560-011	5	1/2-20	R x 1-7/8	2-1/4	3/4 HEX	-	-	75
560-013	5	9/16-18	R x 1-7/16	1-13/16	7/8 HEX	-	-	77
560-014	5	9/16-18	R x 1-5/16	1-11/16	7/8 HEX	-	-	77
560-015	5	9/16-18	R x 1-5/8	2-1/16	7/8 HEX	-	-	77
560-016	5	9/16-18	R x 1-3/8	1-3/4	3/4 HEX	-	-	77
560-017	5	5/8-18	R x 1-9/16	2	7/8 HEX	-	-	78
560-018	5	1/2-20	R x 1-1/8	1-7/16	3/4 HEX	-	-	74
560-019	5	9/16-18	R x 1-1/4	1-9/16	3/4 HEX	-	-	77
560-032	1	1/2-20	R x 1-3/8	.630	-	.555	2405146	74
560-034	1	1/2-20	R x 1-1/2	.618	-	.312	1486230	74
560-039	2	1/2-20	R x 1-5/8	.620	.460	.500	2952858	74
560-090	2	1/2-20	R x 1-5/16	.625	.270	.438	539499	74
560-096	1	7/16-20	R x 1-7/16	.560	-	.530	2534754	74
560-102	2	1/2-20	R x 1-11/16	.562	.200	.630	3229187	75
560-103	2	1/2-20	R x 1-1/2	.665	.200	.590	2513744	74
560-105	2	1/2-20	R x 1-13/16	.560	.300	.640	3699680	75
560-110	4	1/2-20	R x 2	.623	.215	1.000	3736751	76
560-114	2	7/16-20	R x 1-1/2	.465	.140	.285	9590259/71	74
560-138	1	1/2-20	R x 1-5/8	.535	-	.325	1235137	74
560-148	2	1/2-20	R x 1-13/16	.620	.220	.780	3580693	75
560-155	1	1/2-20	R x 1-5/8	.630	-	.620	3961258	75
560-163	2	1/2-20	R x 1-7/16	.545	.270	.438	D3AZ-1107B	74
560-167	2	1/2-20	R x 1-15/16	.587	.220	.625	D6AZ-1107C	75
560-172	2	1/2-20	R x 1-7/8	.560	.300	.650	D6DZ-1107A	75
560-173	2	1/2-20	R x 1-3/4	.625	.280	.438	D6AZ-1107A	75
560-175	2	1/2-20	R x 1-3/4	.665	.312	.575	2959852	75
560-179	-	USE	560-181	-	-	-	-	-
560-180	4	5/8-18	R x 2-1/16	.655	.312	.906	3496564	78
560-181	2	5/8-18	R x 2-13/32	.652	.255	.813	3641576	79
560-182	4	5/8-18	R x 2-9/16	.655	.400	.875	2515316	79
560-183	4	5/8-18	R x 2-15/16	.650	.420	1.000	3637878	79
560-186	2	1/2-20	R x 1-7/8	.612	.250	.600	E0TZ-1107C	75
560-187	1	1/2-20	R x 1-5/8	.623	-	.650	5357196	75
560-269	2	1/2-20	R x 2-1/8	.623	.200	.600	D3TZ-1107A/E	76
560-277	4	1/2-20	R x 2-1/4	.625	.225	.965	-	76
560-280	4	9/16-18	R x 2-1/8	.625	.225	.935	-	77
560-286	4	1/2-20	R x 2-3/16	.723	.300	1.250	4116934	76
560-287	2	1/2-20	R x 1-29/32	.667	.375	.725	6032505	75
560-289	2	1/2-20	R x 1-29/32	.583	.325	.420	6033382	75
560-298	2	1/2-20	R x 2	.547	.215	.687	E6TZ-1107B	76
560-303	2	9/16-18	R x 3-9/32	.677	.435	.725	E5TZ-1107B	78
560-305	2	9/16-18	R x 2-1/8	.640	.275	.562	E6TZ-1107A	77
560-315	2	1/2-20	R x 1-9/16	.558	-	.313	E5TZ-1107A	74
560-345	2	1/2-20	R x 1-7/8	.570	.225	.625	-	75
560-348	4	1/2-20	R x 2-1/8	.658	-	.812	4383430	76
560-355	4	9/16-18	R x 2-13/16	.630	.180	1.125	D0TZ-1107A	78
560-356	4	9/16-18	L x 2-13/16	.630	.225	1.125	D0TZ-1119A	78
560-358	2	1/2-20	R x 2	.612	.340	.656	E9ZZ-1107A	76
560-363	4	1/2-20	R x 2-11/32	.651	.415	1.000	4030779	77
560-364	2	1/2-20	R x 1-15/32	.618	.210	.484	83503053	74
560-366	2	1/2-20	R x 1-3/4	.650	.370	.740	1229808-9	75
560-367	3	1/2-20	R x 2	.585	.190	.750	F1vZY-1107A	77
560-368	2	1/2-20	R x 1-31/32	.615	.312	.531	FOVY-1107A	75
560-376	2	9/16-18	R x 1-7/8	.620	.312	.700	3997956	77
560-386	2	7/16-20	R x 1-5/16	.555	.280	.400	9590258	74
560-389	2	9/16-18	R x 2-5/16	.666	-	.812	-	77
560-390	2	7/16-20	R x 1-1/2	.555	.300	.650	99785156	74
560-439	2	9/16-18	R x 2-7/16	.658	.270	.438	-	78
560-441	2	1/2-20	R x 2-3/16	.623	.250	.469	-	76
560-444	3	1/2-20	R x 2-1/16	.628	.188	.437	-	76
560-448	2	1/2-20	R x 1-15/16	.667	-	.875	6036424AA, 68003287AA	75
560-458	4	9/16-18	R x 2-13/32	.630	.325	.950	C9TZ-1107C	77
560-459	2	9/16-18	R x 2-1/8	.635	.280	.500	334388	77
560-460	2	9/16-18	R x 3	.630	.875	1.060	3988538	78
560-461	2	9/16-18	R x 3-9/16	.630	.875	1.675	355815	78
560-468	4	9/16-18	R x 2-1/8	.650	.300	.750	475988	77
560-469	4	9/16-18	R x 2-1/2	.650	.410	.925	14002236	78
560-470	4	1/2-20	R x 1-3/4	.625	.200	.740	2955940	75
560-472	2	9/16-18	R x 2	.623	.200	.585	C8TZ-1170E	77
560-473	4	9/16-18	R x 2-5/8	.622	.225	1.000	E0TZ-1107B	78
560-474	2	9/16-18	R x 2-1/2	.620	.240	.500	E4TZ-1107A	78
560-479	3	1/2-20	R x 2-3/32	.610	.312	.484	-	76
560-523	3	1/2-20	R x 2-5/16	.560	-	.490	4R3Z1107AA	77
560-529	2	9/16-18	R x 2-3/8	.645	.300	.425	2C2Z1107A	77
560-561	3	1/2-20	R x 2-3/16	.550	-	-	8A8Z1107A	76
560-604	4	7/16-20	R x 1-3/4	.575	.280	.860	3995841 8A8Z1107A	74

papco®

H. Paulin & Co., a division of The Hillman Group Canada ULC

561 Series**papco**

METRIC WHEEL BOLTS BOULONS DE ROUE MÉTRIQUE

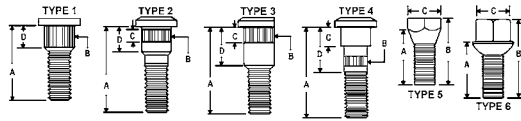
**Passenger Car / Light Truck
Specifications and/et Interchange.**

Bare Metal / Métal Nu

Standard Package / Contenant Régulier 10 pcs.

Part No.	Type	Diameter x 'A'	'B'	'C'	'D'	Factory No.	Photo on Page
561-100	2	M12 x 1.25R x 39mm	12.9mm	7mm	15.4mm	40222-A0800	79
561-102	2	M12 x 1.25R x 32mm	12.9mm	7mm	10.6mm	40222-2201	79
561-106	1	M12 x 1.5R x 38.5mm	14.7mm	-	10mm	6500352/073	80
561-108	2	M12 x 1.5R x 38.5mm	14.3mm	7mm	10mm	5204272	80
561-109	3	M12 x 1.5R x 40mm	14.8mm	7mm	13.5mm	-	80
561-110	2	M12 x 1.5R x 43mm	13mm	6mm	9.6mm	9590475/76	81
561-112	2	M12 x 1.5R x 40mm	12.5mm	8mm	10mm	94024217	80
561-114	1	M12 x 1.5R x 38mm	14.35mm	-	11mm	94025172	80
561-115	2	M12 x 1.5R x 35mm	12.7mm	5mm	9mm	-	80
561-118	5	M12 x 1.5R x 34mm	43mm	19mm Hex	-	3238138, D8RZ-1107B	80
561-122	1	M12 x 1.5R x 36mm	14.3mm	-	9mm	90942-02035	80
561-126	2	M12 x 1.5R x 41mm	14.2mm	5mm	8.5mm	90942-02037	81
561-130	6	M12 x 1.5R x 27mm	40mm	17mm Hex	-	321-601-139	80
561-132	6	M12 x 1.5R x 30mm	45mm	17mm Hex	-	321-601-139C	80
561-133	6	M14 x 1.5R x 35mm	50mm	17mm Hex	-	431/443-601-139A	82
561-139	2	M12 x 1.5R x 37mm	14mm	4mm	11mm	-	80
561-140	1	M12 x 1.5R x 37mm	14.4mm	-	6.4mm	MB057603	80
561-152	6	M12 x 1.5R x 30mm	48mm	19mm Hex	-	90304-692-920-921	80
561-154	2	M12 x 1.5R x 36mm	12mm	6.3mm	12mm	90113-SAO-003	80
561-155	1	M12 x 1.25R x 33mm	12mm	-	10mm	90113-634-003	79
561-166	1	M12 x 1.5R x 32mm	13mm	-	9mm	D5RY-1107C	80
561-167	6	M12 x 1.5R x 28mm	44mm	21mm Hex	-	-	80
561-168	2	M12 x 1.5R x 38mm	13mm	7mm	12mm	E07Z-1107A/C	80
561-169	2	M12 x 1.5R x 43mm	12.85mm	6.5mm	13.8mm	FOCZ-1107A	81
561-174	1	M12 x 1.25R x 34mm	12.24mm	-	10mm	96057612	79
561-175	2	M12 x 1.25R x 38mm	12.24mm	9.6mm	14mm	96057613	79
561-247	2	M12 x 1.5R x 46mm	13.41mm	6.5mm	11.2mm	F0DZ-1107A	81
561-248	2	M12 x 1.5R x 43mm	14.5mm	5.5mm	11mm	E43Z-1107A	81
561-249	2	M12 x 1.5R x 46mm	15.37mm	5.7mm	15mm	E9SZ-1107C	81
561-250	3	M12 x 1.5R x 47mm	13.34mm	6.5mm	14.3mm	E0SZ-1107A	81
561-251	2	M12 x 1.5R x 51mm	13.5mm	5mm	14.5mm	E3FZ-1107A	82
561-255	2	M12 x 1.5R x 52mm	12.9mm	13mm	26.5mm	FB05-26-113A	82
561-264	4	M12 x 1.5R x 52mm	14.33mm	5.5mm	25.12mm	90942-02053/044	82
561-309	3	M12 x 1.5R x 42.7mm	13.08mm	7mm	19.5mm	8596-33-062	81
561-312	2	M12 x 1.5R x 44mm	14.17mm	7mm	12mm	MB584750	81
561-322	1	M12 x 1.25R x 30mm	14.27mm	-	6.10mm	-	79
561-361	3	M12 x 1.5R x 41mm	16.50mm	5mm	13.3mm	6501268, 6501512	81
561-367	6	M12 x 1.5R x 36mm	52mm	17mm Hex	-	-	80
561-369	2	M12 x 1.5R x 46mm	15.00mm	6.6mm	18.00mm	6502311	81
561-370	2	M12 x 1.5R x 44mm	15.80mm	6mm	15.2mm	6502247	81
561-371	2	M12 x 1.5R x 43mm	17.00mm	6mm	15.00mm	6502330	81
561-376	3	M12 x 1.5R x 49mm	13.90mm	7.7mm	15.00mm	F3DZ-1107A	82
561-378	2	M12 x 1.25R x 42mm	14.35mm	7mm	13.5mm	-	79
561-380	2	M10 x 1.25R x 29mm	10mm	6mm	9mm	96055156	79
561-390	1	M12 x 1.75R x 51mm	14.73mm	-	8mm	-	82
561-393	2	M12 x 1.75R x 55mm	14.73mm	6mm	18mm	-	82
561-401	2	M12 x 1.25R x 42mm	14.43mm	6mm	14.5mm	-	79
561-410	2	M14 x 1.5R x 49mm	15.7mm	8mm	14.5mm	12338057	83
561-411	2	M14 x 1.5R x 76mm	15.7mm	23mm	27mm	15545356	83
561-413	2	M14 x 1.5R x 43mm	15.7mm	8.5mm	6mm	12338040	83
561-414	2	M14 x 1.5R x 43mm	15.7mm	8mm	16.5mm	15589423	83
561-415	2	M14 x 1.5R x 46mm	15.8mm	7mm	14mm	15589455	83
561-416	2	M12 x 1.5R x 52mm	14.8mm	8mm	15.3mm	-	82
561-417	4	M14 x 1.5R x 54mm	15.7mm	7mm	19mm	15589486	83
561-418	2	M14 x 1.5R x 91mm	15.7mm	22mm	33mm	15589493	84
561-424	2	M14 x 2.0R x 73mm	15.78mm	8mm	14.25mm	-	84
561-428	2	M14 x 1.5R x 65mm	15.7mm	7mm	17mm	-	83
561-431	2	M14 x 1.5R x 80mm	15.67mm	19mm	35mm	-	83
561-434	2	M14 x 1.5R x 58mm	16mm	6mm	18mm	-	83
561-436	2	M14 x 1.5R x 104mm	16mm	30mm	59mm	-	84
561-438	3	M12 x 1.5R x 44.5mm	16.23mm	7.9mm	12.7mm	6104381, 6504891AA	81
561-442	2	M14 x 2.0R x 58mm	15.5mm	4.6mm	12mm	-	84
561-445	1	M12 x 1.5R x 49mm	14.48mm	-	7mm	-	82
561-467	6	M14 x 1.5R x 36mm	50.5mm	17mm Hex	-	4D0601139A	82
561-490	2	M14 x 1.5R x 69.75mm	15.7mm	-	-	2C2Z1107AA	83
561-492	2	M12 x 1.5R x 48.3mm	12.84mm	5.5mm	7mm	22701519	81
561-502	3	M14 x 1.5R x 50mm	16.02mm	-	18mm	-	83
561-516	6	M14 x 1.5R x 36mm	49mm	17mm Hex	-	0009904907	82
561-522	6	M14 x 1.5R x 41mm	54.5mm	17mm Hex	-	36136758730	83
561-527	1	M14 x 1.5R x 45.5mm	16.5mm	-	9mm	90113-SHJ-A01	83
561-532	6	M14 x 1.25R x 36mm	49mm	17mm Hex	-	36136774896	82

565 Series

papeco

REAR WHEEL STUDS GOUJONS DE ROUE ARRIÈRE

Plated / Plaqué

Standard and Oversize / Régulier et Surépaisseur
Standard Package / Contenant Régulier 12 Pcs

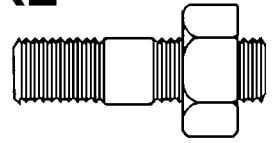
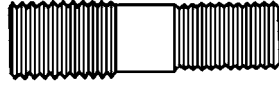

Stock No.	Description Thread x Thread x Length	Thread Length	Application
565-170	7/16-20 x 7/16-14 x 2	7/8 UNF 3/4 UNC	598766, Dodge
565-180	7/16-20 x 7/16-14 x 2 1/2	7/8 UNF 3/4 UNC	, Dodge
565-181	7/16-20 x 9/16-12 x 2 1/2	7/8 UNF 7/8 UNC	No.2023789, Oversize GMC Truck
565-191	7/16-20 x 1/2-13 x 1 3/4	1 UNF 1/2 UNC	No.352728-X Oversize
565-200	7/16-20 x 7/16-14 x 2 1/4	7/8 UNF 7/8 UNC	No.3651377 Chevy Truck 1940-53
565-201	7/16-20 x 1/2-13 x 2 1/4	7/8 UNF 7/8 UNC	No.3651377-X Oversize
565-210	5/8-11 x 5/8-11 x 2 3/4	1 1/2 UNC 1 UNC	Universal Truck Stud, Dayton Wheels
565-240	1/2-20 x 1/2-13 x 2 1/2	1UNF 3/4 UNC	55564H International
565-250	1/2-20 x 9/16-12 x 2 3/8	7/8 UNF 7/8 UNC	No. 10375VA, Oversize International
565-270	1/2-20 x 1/2-13 x 2 7/8	7/8 UNF 3/4 UNC	No.5846703 GM Mack 18AX405 Models B-60, B-61, M-35
565-337	3/4-10 x 3/4-10 x 2 13/16	1 1/2 UNC 1 UNC	Universal Truck Stud. Dayton Wheels
565-487	7/16-20 x 11/16 x 7/16	Hex Nut	No. 351025, use with both 565-190 & 565-191 Studs
565-488	5/8-11 x 1 1/16 x 39/64	Hex Nut	Use with 565-210 Stud
565-489	3/4-10 x 1 1/4 x 47/64	Hex Nut	Use with 565-337 Stud
565-497	7/16 Dowell Washer	(Sleeve) .740 O.D.	No.BB-1142B, use with both 565-190 & 565-191 Studs

558 Series

papeco

WHEEL NUTS ÉCROUS DE ROUE

Heavy Truck
Plated / Plaqué

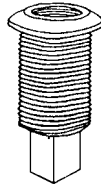
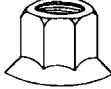
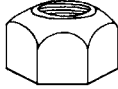
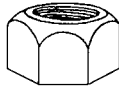
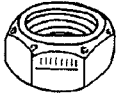

062-526
062-524

558-028
558-029

558-034
558-035

558-043

558-032
558-033

Standard Package / Contenant Régulier 10 Pcs

Part No.	Type	Size and Thread	Factory No.	Budd No.
062-526	Hex Conelock 'B'	3/4-16 Right Hand; 1-1/8 Hex.	Back Nut (H.T.)	
062-524	Hex Conelock 'B'	5/8-18 Right Hand; 1-15/16 Hex.	Back Nut (H.T.)	
558-028	Hex Bevelled	3/4-16 Right Hand; 1-1/2 Hex.	BB1120, 3729738	37888
558-029	Hex Bevelled	3/4-16 Left Hand; 1-1/2 Hex.	BB1121, 3729737	37889
558-032	In. & Out. Thd.	3/4-16 Right Hand 1-1/8-16 Right Hand	BB1132, 279672	10708
558-033	Same as above	3/4-16 Left Hand 1-1/8-16 Left Hand	BB1133, 279673	10709
558-034	Hex Bevelled	1-1/8-16 Right Hand; 1-1/2 Hex.	BB1134, 279670	37891-E
558-035	Hex Bevelled	1-1/8-16 Left Hand; 1-1/2 Hex.	BB1135, 279671	37 92-E

565 Series

papeco

WHEEL BOLTS and NUTS BOULONS et GOUJONS DE ROUE

Heavy Truck

Standard Package / Contenant Régulier 10 Pcs

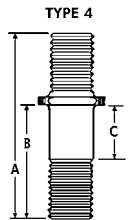

Stock No.	Type	Thread Diameter	DIMENSIONS			CROSS REFERENCE			
			A	B	C	BUDD	FORD	G.M.	OTHER
565-044	4	3/4-16	3-27/32	2-5/16	1-5/32	13990	TUAA-1118	244626	
565-045						1399-L	TUAA-1119-L	244627-L	
565-046	4	3/4-16	4-7/32	2-11/16	1-7/16	17123		2022806	
565-047						17124-L		2022807	
565-066	4	3/4-16	4-17/32	3"	1-15/16	16271			
565-068	4	3/4-16	4-1/32	2-1/2	1-9/32	19004			
565-069						19005-L			

INDEX

Applications	7 - 70	Affectations	Merchandisers	71, 73	Presentoirs
Assortments	71	Assortiments	Photo Index	74 - 92	Index Photo
Carded Kits	72, 73	Trousse	Specifications	2 - 6	Specifications

papeco

H. Paulin & Co., a division of The Hillman Group Canada ULC

WHEEL BOLTS and NUTS BOULONS et ÉCROUS DE ROUE

WARNING:

Due to changes that may occur by car manufacturers within a model year and because of variations in hubs and drums, it is highly recommended that the replacement bolt or nut be compared to the original before installation.

Unseated or improperly seated wheel bolts present a serious safety hazard as these bolts may fail due to fatigue. Wheel bolts must be **FULLY** seated by a hydraulic press.

Over-torquing of wheel nuts causes deformed threads and constitutes a serious safety hazard. Always use a reliable torque wrench on clean, gauged and dry threads. Torque to recommended values in proper nut tightening sequence (see owner's manual or vehicle dealer for this information).

A good practice to follow is an alternating or criss-cross tightening sequence that equalizes bolt pressure around the wheel. On dual wheels (truck), inner wheel should be tighter than the outer. Back off outer nut before tightening inner. Another procedure is to tighten each nut to half its specified torque and then repeat, bringing each nut up to its full torque. Recheck all nuts after first trip to take up any slack.

Installing A Wheel Bolt:

- 1) Remove wheel when it is cool to the touch.
- 2) Treat a broken wheel bolt as a warning. Check or replace remaining bolts.
- 3) Press out the damaged bolt.
- 4) Insert and hydraulically press into place the new wheel bolt until the head is firmly seated against the hub. NOTE: The bolt may fail if the head is not fully seated. Do not seat any wheel bolt by pulling them in with a wheel nut.

Tips For Installation:

- 1) Do not over-tighten bolts and nuts. Over-torquing may result in wheel warp, fracture of the stud, galling of the threads or hub distortion
- 2) Do not under-tighten bolts and nuts. Under-torquing will cause the fasteners to loosen and result in poor handling, damage to the stud, wheel bolt hole damage and/or wheel loss.
- 3) Do not fully torque any one fastener at a time. Uneven torquing may warp the rotor and wheel rim.

AVERTISSEMENT:

En raison des changements effectués par les fabricants d'automobiles au cours de l'année et à cause des variations aux moyeux et aux tambours, il est recommandé que les boulons de remplacement soient comparés aux boulons d'origine avant l'installation.

Les écrous de roues non assis ou improprement assis peuvent présenter un danger sérieux, car ces écrous peuvent s'user et ainsi se détériorer gravement. Les écrous de roues doivent être complètement assis en utilisant une presse hydraulique.

Un excès de torsion sur les écrous de roues peut entraîner une déformation des fils et s'avérer fort dangereux. Toujours, utiliser une clef dynamométrique (torque) de qualité sur des fils propres, secs et calibrés. Resserrer selon les normes recommandées et dans une séquence appropriée. Il faut consulter le guide d'utilisation du concessionnaire d'automobiles pour vérifier les renseignements nécessaires.

La bonne marche à suivre consiste à serrer les boulons en alternance; cette méthode contribue à équilibrer la pression du boulon autour de la roue. Pour ce qui est des roues jumelées (camions), la roue intérieure doit toujours être plus serrée que la roue extérieure. Il faut desserrer le boulon extérieur avant de serrer le boulon intérieur. Une autre bonne façon de procéder consiste à serrer chacun des boulons à la moitié du serrage requis, puis répéter cette procédure jusqu'à ce que tous les boulons soient bien serrés à fond selon les spécifications. À la suite du premier trajet effectué par le véhicule, il faut vérifier à nouveau tous les boulons et les resserrer pour éliminer le jeu qui pourrait s'être formé.

L'installation d'un boulon de roue:

- 1) Lorsque tout risque de brûlure est écarté, retirer la roue.
- 2) Chaque boulon brisé constitue un avertissement sérieux qu'il ne faut jamais négliger.
- 3) Retirer le boulon endommagé en le pressant.
- 4) Fixer le boulon de remplacement à l'aide d'une presse hydraulique jusqu'à ce que la tête soit bien assise sur le moyeu : un boulon peut se briser si sa tête n'est pas complètement assise. Ne jamais asseoir un boulon de roue en tirant dessus avec un écrou de roue.

Quelques conseils en ce qui concerne l'installation:

- 1) Ne jamais serrer indûment les boulons et les écrous. Un serrage exagéré peut faire gauchir la roue, causer une rupture de goujon, écorcher l'alésage ou encore causer une distorsion du moyeu.
- 2) Ne jamais serrer insuffisamment les boulons et les écrous. Un serrage insuffisant aura des effets néfastes : desserrage des attaches, perte de contrôle du véhicule, dommage causé au goujon ou au boulon de roue et, le cas échéant, perte de la roue.
- 3) Ne jamais serrer complètement un seul boulon à la fois. Un serrage inégal peut faire gauchir le rotor et la jante de roue.

WHEEL BOLTS and NUTS – Passenger Car BOULONS et ÉCROUS DE ROUE – pour Automobile

Year Année	Application	FRONT/AVANT		REAR/ARRIERE		Wheel Nut Ecrous	*Optional Nut * Ecrou Facultatif
		Wheel Bolt Boulon	Wheel Parts Kit Trousse	Wheel Bolt Boulon	Wheel Parts Kit Trousse		

*OPTIONAL NUTS / ECROUS FACULTATIF

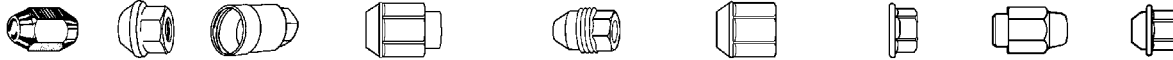

A=Acorn B=Bulge C=Cover D=DometopCapped E=External Thread F=FlattopCapped H=Flanged Flat M=Mag W=Wire Wheel S=Standard

FINISHES
b = black
c = chrome
g = grey
s = stainless
z = zinc

ACURA

CL (03-97), ILX (15-13), RSX (06-02), TL (03-96), Legend (95-86), Vigor (94-92)

2015-13	ILX	561-115	-	561-115	-	559-138	
2006-96	CL, RSX, TL, Vigor	561-112	-	561-154	562-354	559-163	(59)
1997	CL	561-115	-	561-154	562-354	559-163	
1995-86	Legend, Inc: (88-87) Sedan/Coupe	561-115	-	561-115	-	559-163	

Integra

2001-86	Integra (01-90)	561-154	562-354	561-154	562-354	559-163	(18)
1989-86	Integra	561-154	562-354	561-169	562-366	559-163	

NSX, RL, RLX (15-14), TL (14-09), TSX (14-04)

2015-04	RL, RLX, TL (Rear)	561-527	-	561-527	-	N/A	(1)
2014-91	NSX (05-91), RL (04-96), TSX (14-09, Front)	561-112	-	561-112	-	559-138	
2015-04	TSX (14-09 Rear) (08-04 Front & Rear)	561-154	562-354	561-154	562-354	N/A	

RDX, MDX, ZDX (13-10)

2013-07	MDX (13-07), ZDX (13-10)	561-527	-	561-527	-	N/A	
2012-01	RDX (12-11, Rear) (10-07), MDX (06-01)	561-112	-	561-112	-	559-301	

SLX

1999-96		561-114	562-214	561-126	562-226	559-074	
---------	--	---------	---------	---------	---------	---------	--

AM GENERAL

Hummer (See Light Truck Pg. 38)

AMERICAN MOTORS

Amx (80-78), Concord (83-78), Gremlin (78-77), Hornet (77), Matador (78-77), Pacer (80-77), Spirit (83-79)

1983-77	1-5/8" OE rear stud	560-102	562-172	560-090	-	558-027	(3)
1983-77	1-7/8" OE rear stud	560-102	562-172	560-148	562-248	558-027	(3)

Eagle

1988-84	1-5/8" OE rear stud	560-148	562-248	560-090	-	558-027	(3)
1988-84	1-7/8" OE rear stud	560-148	562-248	560-148	562-248	558-027	(3)

AUDI

100, 100 Quattro (94-89), 200, 200 Quattro (91-89)

1994-89		561-133	-	561-133	-	N/R	
---------	--	---------	---	---------	---	-----	--

4000, 4000S (87-85), 4000CS, Quattro, 4000S Quattro (87-84), 5000 Series (88-84)

1988-84	w/ aluminum wheels	561-133	-	561-133	-	N/R	
1988-84	w/ steel wheels	561-130	-	561-130	-	N/R	

80, 80 Quattro (92-88), 90, 90 Quattro

1995-88	w/ alloy wheels	561-133	-	561-133	-	N/R	
---------	-----------------	---------	---	---------	---	-----	--

A4, A4 Quattro, A6, A6 Quattro

2012-09		561-467	-	561-467	-	N/R	
2008-95		561-133	-	561-133	-	N/R	

A8 Quattro

2008-02		561-467	-	561-467	-	N/R	
2001-00	w/ alloy wheels	561-367	-	561-367	-	N/R	
2001-00	w/ steel wheels	561-133	-	561-133	-	N/R	

N/R – Not Required • N/A – Dealer Part

* (1) 558-070 Dc	(3) 558-094 Dc	(18) 559-138 Dc	(59) 559-075 Ac			
------------------	----------------	-----------------	-----------------	--	--	--

WHEEL BOLTS and NUTS – Passenger Car BOULONS et ÉCROUS DE ROUE – pour Automobile

Year Année	Application	FRONT/AVANT		REAR/ARRIERE		Wheel Nut Ecrous	*Optional Nut * Ecrou Facultatif
		Wheel Bolt Boulon	Wheel Parts Kit Trousse	Wheel Bolt Boulon	Wheel Parts Kit Trousse		

*OPTIONAL NUTS / ECROUS FACULTATIF

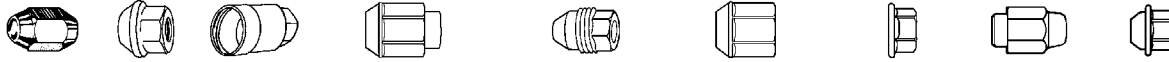

A= Acorn B= Bulge C= Cover D= DomestopCapped E= External Thread F= FlattopCapped H= Flanged Flat M= Mag W= Wire Wheel S= Standard

FINISHES
b = black
c = chrome
g = grey
s = stainless
z = zinc

AUDI (Cont'd)

A8							
2012-02		561-467	-	561-467	-	N/R	
2001-97		561-133	-	561-133	-	N/R	
All road Quattro							
2005-01		561-467	-	561-467	-	N/R	
2000-98		561-133	-	561-133	-	N/R	
S4 (08-92), S6, S8 (08-94)							
2012-92	w/ alloy wheels	561-467	-	561-467	-	N/R	
2012-92	w/ steel wheels	561-133	-	561-133	-	N/R	
TT, TT Quattro							
2012-01		561-467	-	561-467	-	N/R	
2000-98		561-133	-	561-133	-	N/R	

BMW

228i (15-14), 320i (15-12), 328i (15-12), 335i, 428i (15-14), 435i (15-14), 528i, 535i, 550i (15-10), 640i (15-12), 650i (15-12), 740i (15-11), 750i (15-09), 760Li (15-10), M5 (15-13), M6 (15-12), X3 (15-11), X4 (15), X5 (15-07), X6 (15-08)							
2015-06		561-532	-	561-532	-	N/R	
745i (05-02), 750i (06), 760i (06-04), X3 (06-04)							
2006-02		561-522	-	561-522	-	N/R	
All Except: Models Listed Above							
2012-77		561-367	-	561-367	-	N/R	

BUICK

Allure							
2010-05		561-110	562-310	561-110	562-310	559-070	(23)
Century							
2005-97	Aluminum and steel wheels	561-110	562-310	561-110	562-310	559-192	(21)
1996-82		561-110	562-310	561-110	562-310	559-150	(11) (23)
1981-73		560-386	562-126	560-114	562-114	558-014	(1)
Electra, Electra 225							
1990-85		561-110	562-310	561-110	562-310	559-150	(11) (23)
1984-71		560-155	562-155	560-138	562-138	558-016	(4)
Enclave							
2016-08		561-434	-	561-434	-	559-154	(32) (49)
Estate Wagon							
1990-71		560-155	562-155	560-138	562-138	558-016	(6)
LaCrosse							
2015-10		561-434	-	561-434	-	559-154	(32)
2009-05		561-110	562-310	561-110	562-310	559-190	(11) (23) (24)

N/R – Not Required

*(1) 558-070 DBc	(4) 558-124 DBs	(6) 558-162 Bz	(11) 559-085 Wb	(21) 559-163 Bz	(23) 559-190 Ds	(24) 559-191 Ez	(32) 559-193 Ez
(49) 559-236 Fc							

WHEEL BOLTS and NUTS – Passenger Car BOULONS et ÉCROUS DE ROUE – pour Automobile

Year Année	Application	FRONT/AVANT		REAR/ARRIERE		Wheel Nut Ecrous	*Optional Nut * Ecrou Facultatif
		Wheel Bolt Boulon	Wheel Parts Kit Trousse	Wheel Bolt Boulon	Wheel Parts Kit Trousse		

*OPTIONAL NUTS / ECROUS FACULTATIF

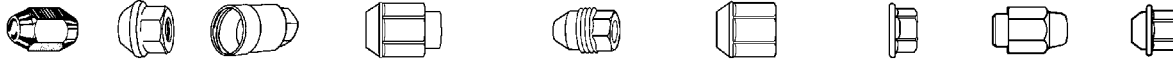

A=Acorn B=Bulge C=Cover D=DometopCapped E=External Thread F=FlattopCapped H=Flanged Flat M=Mag W=Wire Wheel S=Standard

FINISHES
b = black
c = chrome
g = grey
s = stainless
z = zinc

BUICK (Cont'd)

LeSabre (05-71), Lucerne (11-06), Rendezvous (07-02), Rainer (07-04), Terraza (07-05)

2011-86	Aluminum and steel wheels	561-110	562-310	561-110	562-310	559-150	(25) (39) (48)
2007-04	Rainer	561-110	562-310	561-110	562-310	559-163	(11) (23) (24)
1985-77	w/ 9.5" rear drums	560-155	562-155	560-138	562-138	558-016	(1)
1985-77	w/ 11" rear drums, or rear discs	560-386	562-126	560-114	562-114	558-014	
1976-71		560-155	562-155	560-138	562-138	558-016	

Park Avenue (05-91), Reatta (91-88), Regal (15-11) (04-82), Riviera (99-71), Roadmaster (96-91), Somerset (87-85)

2015-11	Regal	561-434	-	561-434	-	559-154	
2004-82	Aluminum and steel wheels (Note: std. wheel nut from 91-82 – 559-150)	561-110	562-310	561-110	562-310	559-163	(11) (13) (24) (25) (39) (48)
1981-73	Regal	560-386	562-126	560-114	562-114	558-014	(1)
1978-71	Riviera	560-155	562-155	560-138	562-138	558-016	

Skyhawk (89-75), Skylark, Special (98-71)

1998-80	Skyhawk (89-82), Skylark, Special (98-80)	561-110	562-310	561-110	562-310	559-150	(13) (20) (23)
1980-75	Skyhawk	560-386	562-126	560-114	562-114	558-014	(1)
1979-64	Skylark, Special w/drum brakes	560-386	562-126	560-114	562-114	558-014	(1)

Verano

2012		561-110	562-310	561-110	562-310	559-190	
------	--	---------	---------	---------	---------	---------	--

CADILLAC

Allanté (93-87), Fleetwood FWD (93-85)

1993-85		561-110	562-310	561-110	562-310	559-163	
---------	--	---------	---------	---------	---------	---------	--

Catera

2001-97		561-367	-	561-367	-	N/R	
---------	--	---------	---	---------	---	-----	--

Cimarron

1988-82		561-110	562-310	561-110	562-310	559-190	(11)
---------	--	---------	---------	---------	---------	---------	------

CTS (09-06), DTS, SRX (15-04), STS (11-06), XLR (09-04), XTS (15-13)

2015-10	CTS, SRX, XTS	561-434	-	561-434	-	559-154	
2010-03		561-110	562-310	561-110	562-310	559-163	(23) (49)

Deville, Concours (05-85), Eldorado (02-79)

2005-79	w/ 5 bolt pattern, inc.: Eldorado	561-110	562-310	561-110	562-310	559-163	(11) (23)
1984-72	Deville	560-155	562-155	560-138	562-138	558-016	
1978-67	Eldorado	560-138	562-138	560-138	562-138	558-016	
1971-60	Deville (71-60), Eldorado (66-60)	560-034	-	560-034	-	558-016	

Escalade, Escalade ESV (15-02), Escalade EXT (13-02), XTS (15-13)

2015-02	Steel Wheels use 559-193E Nuts	561-428	-	561-434	-	559-154	(32) (49)
2000		N/A	-	561-428	-	559-154	(32)

N/R – Not Required • N/A – Dealer Part

* (1) 558-070 Ds	(11) 559-085 Wb	(13) 559-089 Fs	(20) 559-151 EH	(23) 559-190 Ds	(24) 559-191 Ez	(25) 559-192 Ez	(32) 559-193 Ez
(39) 559-200 Cg	(48) 559-211 Cg	(49) 559-236 Fc					

WHEEL BOLTS and NUTS – Passenger Car BOULONS et ÉCROUS DE ROUE – pour Automobile

Year Année	Application	FRONT/AVANT		REAR/ARRIERE		Wheel Nut Ecrous	*Optional Nut * Ecrou Facultatif
		Wheel Bolt Boulon	Wheel Parts Kit Trousse	Wheel Bolt Boulon	Wheel Parts Kit Trousse		

*OPTIONAL NUTS / ECROUS FACULTATIF

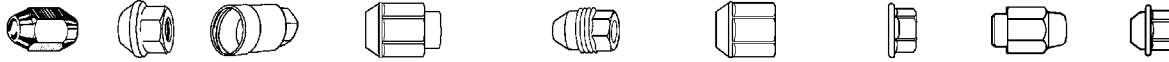

A= Acorn B= Bulge C= Cover D= DomestopCapped E= External Thread F= FlattopCapped H= Flanged Flat M= Mag W= Wire Wheel S= Standard

FINISHES
b = black
c = chrome
g = grey
s = stainless
z = zinc

CADILLAC (Cont'd)

Fleetwood RWD

1996-91	w/ ABS (96-95), w/2" rear drums (94-91)	561-110	562-310	561-110	562-310	559-163	(11)
1996-91	w/o ABS (96-95), w/2.75" rear drums (94-91)	560-155	562-155	560-138	562-138	558-016	(6)
1990-72	all	560-155	562-155	560-138	562-138	558-016	

Seville

2004-80		561-110	562-310	561-110	562-310	559-163	(11) (24) (25)
1979-77		560-155	562-155	560-138	562-138	558-016	
1976		560-386	562-126	560-114	562-114	558-014	

CHEVROLET

Chevrolet/GMC Truck (See Light Truck Pg. 38)

Aveo, Aveo 5 (11-06), Captiva Sport (15-11)

2015-04		561-112	-	561-112	-	559-163	
---------	--	---------	---	---------	---	---------	--

Beretta (96-87), Cavalier (05-00) (99-82 see below), Corsica (96-87 w/ steel wheels - for aluminum wheels - see below)

2005-87		561-110	562-310	561-110	562-310	559-190	(20) (23) (24) (39)
---------	--	---------	---------	---------	---------	---------	------------------------

Camaro, Caprice (15-11)

2015-10		561-434	-	561-434	-	559-193	
2002-97	Aluminum, chrome and steel wheels	561-110	562-310	561-110	562-310	559-192	(48)
1996-89		561-110	562-310	561-110	562-310	559-163	(24) (25)
1988-82		561-110	562-310	561-110	562-310	559-150	(23) (24) (39)
1981-70		560-386	562-126	560-114	562-114	558-014	(1)
1969-67	w/o 4 wheel discs	560-114	562-114	560-114	562-114	558-014	(1)

Caprice (96-66)

1996-91		561-110	562-310	561-110	562-310	559-150	(11) (23)
1990-77	w/ 9.5" rear drums	560-386	562-126	560-114	562-114	558-014	
1990-71	all inc: 11" rear drums	560-155	562-155	560-138	562-138	558-016	
1970-66	w/ front drums	560-114	562-114	560-114	562-114	558-014	

Cavalier (99-88), Corsica (93-89 w/ Aluminum wheels)

1999-88		561-110	562-310	561-110	562-310	559-163	(23) (24) (27) (29) (39)
---------	--	---------	---------	---------	---------	---------	--------------------------------

Cavalier (87-82), Celebrity (90-82), Chevelle (86-82), Citation (85-80), El Camino (87-82)

1990-82		561-110	562-310	561-110	562-310	559-150	(12) (13) (24)
---------	--	---------	---------	---------	---------	---------	-------------------

Chevelle (73-64), El Camino (81-64), Chevy II (66-64)

1981-67	w/ front discs	560-386	562-126	560-114	562-114	558-014	(1)
1972-64	w/ front drums	560-114	562-114	560-114	562-114	558-014	

Cobalt (10-05), HHR, Equinox (06-05)

2010-05		561-110	562-310	561-110	562-310	559-191	(23)
2010-05	w/ clipped head bolt front or rear	561-492	562-310	561-492	-	559-191	

*(1) 558-070 Ds	(6) 558-162 Bz	(11) 559-085 Wb	(12) 559-087 Ds	(13) 559-089 Fs	(20) 559-151 EHz	(23) 559-190 Ds	(24) 559-191 Ez
(25) 559-192 Ez	(27) 559-203 Cg	(29) 559-209 Cb	(39) 559-200 Cg	(48) 559-211 Cg			

WHEEL BOLTS and NUTS – Passenger Car BOULONS et ÉCROUS DE ROUE – pour Automobile

Year Année	Application	FRONT/AVANT		REAR/ARRIERE		Wheel Nut Ecrous	*Optional Nut * Ecrou Facultatif
		Wheel Bolt Boulon	Wheel Parts Kit Trousse	Wheel Bolt Boulon	Wheel Parts Kit Trousse		

*OPTIONAL NUTS / ECROUS FACULTATIF

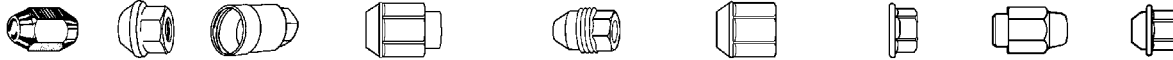

A= Acorn B= Bulge C= Cover D= DometopCapped E= External Thread F= FlattopCapped H= Flanged Flat M= Mag W= Wire Wheel S= Standard

FINISHES
b= black
c= chrome
g= grey
s= stainless
z= zinc

CHEVROLET (Cont'd)

Corvette

2015-02		561-110	562-310	561-110	562-310	N/A	(48)
2001-97		561-110	562-310	561-110	562-310	559-163	(24) (25)
1996		561-110	562-310	561-110	562-310	559-191	(39)
1995-84		561-110	562-310	561-110	562-310	559-163	(29)
1982-61		560-114	562-114	560-114	562-114	558-014	(24) (39)

Cruze, Trax (15-13)

2015-11		561-110	562-310	561-110	562-310	559-190	-
---------	--	---------	---------	---------	---------	---------	---

Impala (15-14), Impala Limited (15-14), Impala SS (15-14)

2015-14		-	-	-	-	559-236	-
---------	--	---	---	---	---	---------	---

Impala, Impala SS, Kingswood, Townsman (08-00), Lumina (01-95), MonteCarlo (08-95), Malibu (12-97), Malibu Classic (05-04), Malibu Maxx (08-04), Venture (05-97)

2013-02	Impala, Impala SS, Malibu, Townsman	561-110	562-310	561-110	562-310	559-163	(23) (24) (25) (26) (48)
2004-02	Monte Carlo, steel & aluminum wheels	561-110	562-310	561-110	562-310	559-163	(23) (25) (48)
2004-97	Malibu, Venture	561-110	562-310	561-110	562-310	559-163	(25)
2001-00	Impala, Impala SS, Kingswood, Townsman	561-115	-	561-115	-	559-163	(23) (25)
2001-95	Lumina Incl.: '98-'95 aluminum wheels	561-115	-	561-115	-	559-163	(23) (25) (26)
2001-95	Monte Carlo, all wheels	561-115	-	561-115	-	559-163	(23) (25) (26) (31) (48)
1998-95	Lumina w/out aluminum wheels	561-115	-	561-115	-	559-191	(25) (31)

Impala, Impala SS, Kingswood, Townsman (96-94), Lumina (94-90), MonteCarlo (88-82), Malibu (83-82)

1996-82		561-110	562-310	561-110	562-310	559-150	(21) (23) (11) (25) (28)
---------	--	---------	---------	---------	---------	---------	--------------------------------

Impala, Impala SS, Kingswood, Townsman (85-60)

1985-77	w/ 9.5" rear drums	560-386	562-126	560-114	562-114	558-014	
1985-71	Inc: 11" rear drums	560-155	562-155	560-138	562-138	558-016	
1970-60		560-114	562-114	560-114	562-114	558-014	

Lumina APV

1996-92		561-110	562-310	561-110	562-310	559-192	(39)
1991-90		561-110	562-310	561-110	562-310	559-150	(23) (24) (28)

Malibu (81-73), Monza (80-75), Vega (77-71)

1981-71		560-386	562-126	560-114	562-114	558-014	(1)
1967-64	w/ front drums	560-114	562-114	560-114	562-114	558-014	

Metro

2001-99	w/ ABS - 00-99	561-175	562-275	561-175	562-275	559-064	
2000-99	w/o ABS	561-175	562-275	561-174	562-274	559-064	

N/A – Dealer Part

* (1) 558-070 Ds	(11) 559-085 Wb	(21) 559-163 Bz	(23) 559-190 Ds	(24) 559-191 Ez	(25) 559-192 Ez	(26) 559-201 Cs	(28) 559-204 Cb
(29) 559-209 Cb	(31) 559-202 Cb	(39) 559-200 Cg	(48) 559-211 Cg				

WHEEL BOLTS and NUTS – Passenger Car BOULONS et ÉCROUS DE ROUE – pour Automobile

Year Année	Application	FRONT/AVANT		REAR/ARRIERE		Wheel Nut Ecrous	*Optional Nut * Ecrou Facultatif
		Wheel Bolt Boulon	Wheel Parts Kit Trousse	Wheel Bolt Boulon	Wheel Parts Kit Trousse		

*OPTIONAL NUTS / ECROUS FACULTATIF

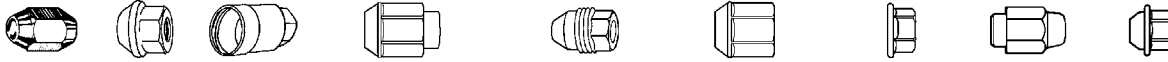

A= Acorn B= Bulge C= Cover D= DometopCapped E= External Thread F= FlattopCapped H= Flanged Flat M= Mag W= Wire Wheel S= Standard

FINISHES
b = black
c = chrome
g = grey
s = stainless
z = zinc

CHEVROLET (Cont'd)

Nova							
1988-85		561-126	562-226	561-126	562-226	559-172	
1979-71	Inc: front discs	560-386	562-126	560-114	562-114	558-014	(1)
1975-62	Inc. front drums	560-114	562-114	560-114	562-114	558-014	
Prism							
2002-98		561-126	562-226	561-126	562-226	559-150	
Spectrum							
1988-85		561-112	-	561-112	-	559-150	(9)
Sprint							
1988-85		561-380	562-480	561-380	562-480	559-060	
Uplander							
2008-05	w/ steel wheels	561-110	562-310	561-110	562-310	559-191	
Volt							
2013-11		561-110	562-310	561-110	562-310	559-190	(23)

CHRYSLER

200							
2015-11		561-445	-	561-445	-	559-100	
300							
2015-05	Serrated Stud w/ Clip Head	561-502	-	561-502	-	559-154	(55) (66) (67)
300M (04-99), Concorde (04-98), LHS (01-98)							
2009-07		560-389	-	560-389	-	558-204	(9)
2004-02		561-249	562-249	561-438	-	559-181	
2001-98		561-249	562-249	561-249	562-249	559-181	(9)
Aspen							
2009-07		560-389	-	560-389	-	558-204	
Concorde (97-93), LHS (97-94)							
1997-93		561-249	562-249	561-249	562-249	559-150	(9)
Cirrus							
2000-95		561-109	562-209	561-109	562-209	559-150	(9) (21)
Conquest							
1989-88		N/A	-	561-126	562-226	559-172	
1987		561-126	562-226	561-126	562-226	559-172	
Cordoba							
1988-80, 1976	Motor Wheel Rotor	560-039	-	560-103	562-173	558-027	
1983-79	Kelsey Hayes Rotor	560-155	562-155	560-103	562-173	558-027	
E Class Executive Limo, Executive Sedan							
1985-83		561-109	562-209	561-108	562-208	559-150	(9)
Fifth Avenue							
1989-83	Inc: (85-83) Kelsey Hayes rotor	560-155	562-155	560-103	562-173	558-027	
1985-83	Motor Wheel rotor	560-039	-	560-103	562-173	558-027	

N/A – Dealer Part

* (1) 558-070 Ds (9) 559-074 Ds (21) 559-163 Bz (23) 559-190 Ds (55) 559-112 D (66) 559-257 Bz (67) 559-259 Dc

WHEEL BOLTS and NUTS – Passenger Car BOULONS et ÉCROUS DE ROUE – pour Automobile

Year Année	Application	FRONT/AVANT		REAR/ARRIERE		Wheel Nut Ecrous	*Optional Nut * Ecrou Facultatif
		Wheel Bolt Boulon	Wheel Parts Kit Trousse	Wheel Bolt Boulon	Wheel Parts Kit Trousse		

*OPTIONAL NUTS / ECROUS FACULTATIF

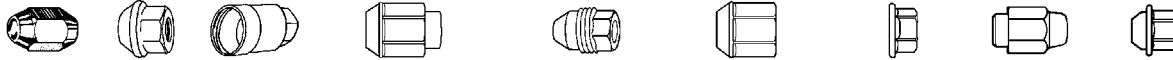

A=Acorn B=Bulge C=Cover D=DometopCapped E=External Thread F=FlattopCapped H=Flanged Flat M=Mag W=Wire Wheel S=Standard

FINISHES
b = black
c = chrome
g = grey
s = stainless
z = zinc

CHRYSLER (Cont'd)

Imperial

1993-90	Inc: (90) Bendix brakes	561-109	562-209	561-251	562-351	559-150	
1990	Bosch brakes	561-109	562-209	561-361	562-461	559-150	(9)
1983-81	Kelsey Hayes rotor	560-155	562-155	560-103	562-173	558-027	(9)
1983-81	Motor Wheel rotor	560-039	-	560-103	562-173	558-027	

Laser

1986-84	w/ rear discs	561-109	562-209	561-109	562-209	559-150	(9)
1986-84	w/ rear drums	561-109	562-209	561-108	562-208	559-150	(9)

LeBaron, LeBaron GTS (89-85)

1995-90	w/rear discs	561-109	562-209	561-251	562-351	559-150	(9) (21)
1995-83	w/ rear drums, GTS (89-88)	561-109	562-209	561-108	562-208	559-150	(9) (21)
1989	w/ rear discs, GTS (87-85)	561-109	562-209	561-109	562-209	559-150	(9)
1981-77	Kelsey Hayes rotor	560-155	562-155	560-103	562-173	558-027	
1981-77	Motor Wheel rotor	560-039	-	560-103	562-173	558-027	

NewYorker, Newport

1996-94		561-249	562-249	561-249	562-249	559-150	(9)
1993-90	w/ rear discs Inc: (90) Bendix	561-109	562-209	561-251	562-351	559-150	(9)
1993-83	w/ rear drums	561-109	562-209	561-108	562-208	559-150	(9)
1990-88	w/ rear discs	561-109	562-209	561-361	562-461	559-150	(9)
1981-74	Kelsey Hayes Rotor (81-79), Budd rotors (78-74)	560-155	562-155	560-103	562-173	558-027	

Pacifica

2008-04		561-369	-	561-369	-	559-163	
---------	--	---------	---	---------	---	---------	--

Prowler

2002-01		561-369	-	561-249	562-249	559-163	
---------	--	---------	---	---------	---------	---------	--

PT Cruiser

2010-01		561-109	562-209	561-108	562-208	559-163	(9)
2002-01		561-109	562-209	561-108	562-208	559-191	(9)

Sebring (08-95)

2010-09		561-445	-	561-445	-	559-100	
2008-07		-	-	561-312	562-412	559-172	(7)
2006-96	Convertible & Sedan	561-109	562-209	561-109	562-209	559-163	(9) (24)
2005-95	Coupe	561-126	562-226	561-126	562-226	559-172	(16)

Town & Country

1988-82		561-109	562-209	561-108	562-208	559-150	(9)
1981-78	Kelsey Hayes rotor	560-155	562-155	560-103	562-173	558-027	
1981-78	Motor Wheel rotor	560-039	-	560-103	562-173	558-027	
1977-74	Budd & Kelsey Hayes rotors	560-105	562-125	560-103	562-173	558-027	

* (7) 558-070 Ac (9) 559-074 Ds (16) 559-117 DHc (21) 559-163 Bz (24) 559-191 Ez

WHEEL BOLTS and NUTS – Passenger Car BOULONS et ÉCROUS DE ROUE – pour Automobile

Year Année	Application	FRONT/AVANT		REAR/ARRIERE		Wheel Nut Ecrous	*Optional Nut * Ecrou Facultatif
		Wheel Bolt Boulon	Wheel Parts Kit Trousse	Wheel Bolt Boulon	Wheel Parts Kit Trousse		

*OPTIONAL NUTS / ECROUS FACULTATIF

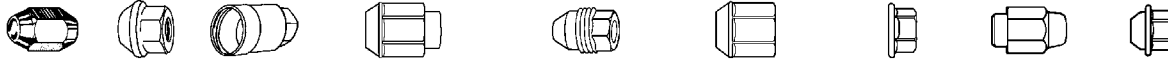

A=Acorn B=Bulge C=Cover D=Domestop Capped E=External Thread F=Flattop Capped H=Flanged Flat M=Mag W=Wire Wheel S=Standard

FINISHES
b = black
c = chrome
g = grey
s = stainless
z = zinc

CHRYSLER (Cont'd) DODGE

Town & Country Van (15-97), Voyager (07-95), Grand Voyager (03-00)

2015-98	Steel wheels	-	-	-	-	559-181	(54)
1997	w/ rear discs or 15" wheels	561-369	-	561-369	-	559-150	(9)
1997-96	w/ rear drums or 15" wheels	561-369	-	561-312	562-412	559-150	(9)
1997	14" wheel w/rear discs	561-109	562-209	561-369	-	559-150	(9)
1997-96	14" wheel w/rear drums	561-109	562-209	561-312	562-412	559-150	(9)
1995-93	15" wheel, 2WD	561-369	-	561-108	562-208	559-150	(9) (21)
1995-93	15" wheel, 4WD	561-369	-	561-371	-	559-150	(9) (21)
1992-91	15" wheel, 2WD	561-370	-	561-108	562-208	559-150	(9) (21)
1992-91	15" wheel, 4WD	561-370	-	561-371	-	559-150	(9) (21)
1995-91	14" wheel, 2WD	561-109	562-209	561-108	562-208	559-150	(9) (21)
1995-91	14" wheel, 4WD	561-109	562-209	561-371	-	559-150	(9) (21)
1990		561-109	562-209	561-108	562-208	559-150	(9) (21)

DODGE

Dodge Truck (See Light Truck Pg. 43)

400, 600

1988-83		561-109	562-209	561-108	562-208	559-150	(9) (21)
---------	--	---------	---------	---------	---------	---------	----------

Aries

1989-81	Inc : 220mm rear drums	561-109	562-209	561-108	562-208	559-150	(9)
1987-85	w/ 200mm rear drums	561-109	562-209	561-109	562-209	559-150	(9) (21)

Aspen

1980-76	Kelsey Hayes rotor	560-155	562-155	560-103	562-173	558-027	(3)
1980-76	Motor Wheel rotor	560-039	-	560-103	562-173	558-027	(3)

Avenger (14-95), Caliber (12-07)

2014-95		561-126	562-226	561-126	562-226	559-172	(16) (19)
---------	--	---------	---------	---------	---------	---------	-----------

Caravan (07-84), Grand Caravan (15-87), Mini Ram Van, Royal Mini Ram, Voyager (07-95)

2015-97	w/ rear discs and 15" wheels	561-369	-	561-369	-	559-150	(9) (22)
2015-96	w/ rear drums and 15" wheels	561-369	-	561-312	562-412	559-150	(9) (22)
1997	w/ 14" wheel, rear discs	561-109	562-209	561-369	-	559-150	(9)
1997-91	w/ 14" wheel, 4WD	561-109	562-209	561-371	-	559-150	(9) (21)
1996	w/ 14" wheel	561-109	562-209	561-312	562-412	559-150	(9)
1995-93	w/ 15" wheel, 2WD	561-369	-	561-108	562-208	559-150	(9) (21)
1995-90	w/ 14" wheel, 2WD, (1990 all)	561-109	562-209	561-108	562-208	559-150	(9) (21)
1992-91	w/ 15" wheel, 2WD	561-370	-	561-108	562-208	559-150	(9) (21)
1989-84	Exc: 1988	561-109	562-209	561-109	562-209	559-150	(9) (21)
1988		561-109	562-209	561-108	562-208	559-150	(9) (21)

Challenger

2015-08		561-502	-	561-502	-	559-154	(67)
2007-84	Exc: 1988	561-109	562-209	561-109	562-209	559-150	(9) (21)
1988		561-109	562-209	561-108	562-208	559-150	(9) (21)
1983-78		561-126	562-226	561-126	562-226	559-172	

* (3) 558-094 DBs (9) 559-074 Ds (16) 559-117 DHc (19) 559-141 Ac (21) 559-163 Bz (22) 559-181 Ws (54) 559-150 Sz (67) 559-259 Dc

WHEEL BOLTS and NUTS – Passenger Car BOULONS et ÉCROUS DE ROUE – pour Automobile

Year Année	Application	FRONT/AVANT		REAR/ARRIERE		Wheel Nut Ecrous	*Optional Nut * Ecrou Facultatif
		Wheel Bolt Boulon	Wheel Parts Kit Trousse	Wheel Bolt Boulon	Wheel Parts Kit Trousse		

*OPTIONAL NUTS / ECROUS FACULTATIF

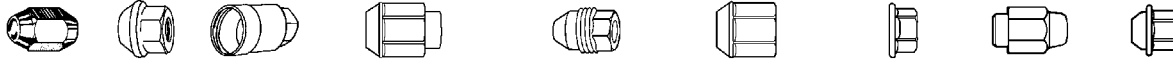

A=Acorn B=Bulge C=Cover D=DometopCapped E=External Thread F=FlattopCapped H=Flanged Flat M=Mag W=Wire Wheel S=Standard

FINISHES
b = black
c = chrome
g = grey
s = stainless
z = zinc

DODGE (Cont'd)

Charger

2015-06		561-502	-	561-502	-	559-154	(55) (66) (67)
1987-85	w/ 200mm rear drums	561-109	562-209	561-109	562-209	559-150	(9) (21)
1987-84	Inc: 220mm, rear drums	561-109	562-209	561-108	562-208	559-150	(9) (21)
1978	Budd rotor	560-102	562-172	560-103	562-173	558-027	
1978-74	Inc: Kelsey Hayes rotor	560-155	562-155	560-103	562-173	558-027	(3)
1976-73	Inc: Motor Wheel rotor	560-039	-	560-103	562-173	558-027	
1972-71	w/ front discs	560-110	562-210	560-103	562-173	558-027	
1972-71	w/ front drums, Kelsey Hayes	560-148	562-248	560-103	562-173	558-027	
1972-71	w/ front drums, Motor Wheel	560-366	-	560-103	562-173	558-027	

Colt

1994-91		561-126	562-226	561-126	562-226	559-172	
1990-86	w/ rear drums	561-126	562-226	561-126	562-226	559-172	
1985-79	Inc: FWD (80-79)	561-140	562-240	561-140	562-240	559-172	
1980-71	Inc: RWD (80-79)	561-126	562-226	561-126	562-226	559-172	

Colt Vista

1991-86	2WD	561-126	562-226	561-126	562-226	559-172	
1991-85	4WD (91-85), 2WD (85)	561-126	562-226	561-140	562-240	559-172	
1984		561-140	562-240	561-140	562-240	559-172	

Conquest

1986-85	w/ Intercooled Turbo	N/A	-	561-126	562-226	559-172	
1986-84	w/o Intercooled Turbo	561-126	562-226	561-126	562-226	559-172	

Daytona

1993-90	w/ rear discs	561-109	562-209	561-251	562-351	559-150	(9) (21)
1993-84	w/ rear drums	561-109	562-209	561-108	562-208	559-150	(9) (21)
1989-84	w/ rear discs	561-109	562-209	561-109	562-209	559-150	(9)

Diplomat

1989-77	Inc: Kelsey Hayes rotor	560-155	562-155	560-103	562-173	558-027	
1985-77	w/ Motor Wheel rotor	560-039	-	560-103	562-173	558-027	

Dynasty

1993-90	w/ rear discs Inc: Bendix	561-109	562-209	561-251	562-351	559-150	(9)
1993-88	w/ rear drums	561-109	562-209	561-108	562-208	559-150	(9)
1990-88	w/ rear discs, Inc: (90) Bosch	561-109	562-209	561-361	562-461	559-150	(9)

Intrepid

2004-02		561-249	562-249	561-438	-	559-181	(9)
2001-98		561-249	562-249	561-249	562-249	559-181	(9)
1997-93		561-249	562-249	561-249	562-249	559-150	(9)

Journey

2015-09		N/A	-	N/A	-	559-181	
---------	--	-----	---	-----	---	---------	--

Lancer

1989-88		561-109	562-209	561-108	562-208	559-150	(9)
1987-85		561-109	562-209	561-109	562-209	559-150	(9)

N/A – Dealer Part

* (3) 558-094 DBc | (9) 559-074 Ds | (21) 559-163 Bz | (24) 559-191 Ez | (55) 559-112 D | (60) 558-122 Ds | (66) 559-257 Bz | (67) 559-259 Dc

WHEEL BOLTS and NUTS – Passenger Car BOULONS et ÉCROUS DE ROUE – pour Automobile

Year Année	Application	FRONT/AVANT		REAR/ARRIERE		Wheel Nut Ecrous	*Optional Nut * Ecrou Facultatif
		Wheel Bolt Boulon	Wheel Parts Kit Trousse	Wheel Bolt Boulon	Wheel Parts Kit Trousse		

*OPTIONAL NUTS / ECROUS FACULTATIF

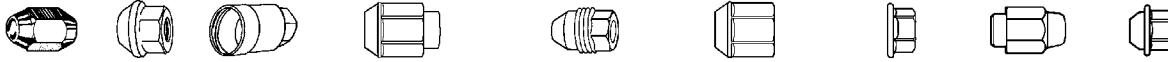

A= Acorn B= Bulge C= Cover D= DomestopCapped E= External Thread F= FlattopCapped H= Flanged Flat M= Mag W= Wire Wheel S= Standard

FINISHES
b = black
c = chrome
g = grey
s = stainless
z = zinc

DODGE (Cont'd)

Magnum, Mirada (83-78), Monaco, Polara (78-77)

2008-05	Magnum	561-502	-	561-502	-	559-154	(55) (66) (67)
1983-80	w/ Motor Wheel rotor	560-039	-	560-103	562-173	558-027	
1983-78	w/ Kelsey Hayes	560-155	562-155	560-103	562-173	558-027	
1979-78	w/ Budd rotor	560-102	562-172	560-103	562-173	558-027	

Neon

2005-00		561-109	562-209	561-108	562-208	559-074	(24)
1999-95		561-109	562-209	561-108	562-208	559-150	(9) (21)

Nitro

2012-07		N/A	-	N/A	-	558-094	(60)
---------	--	-----	---	-----	---	---------	------

Omni, 24, Rampage

1990-84	Inc: 220mm rear drums	561-109	562-209	561-108	562-208	559-150	(9)
1987-85	200mm rear drums	561-109	562-209	561-109	562-209	559-150	(9)
1983-78		561-239	-	561-108	562-208	559-150	(9) (21)

Shadow (94-87), Spirit (95-89)

1995-89	w/ rear discs, Exc: (89) Spirit	561-109	562-209	561-251	562-351	559-150	(9) (21)
1995-88	w/ rear drums	561-109	562-209	561-108	562-208	559-150	(9) (21)
1989-87	w/ rear discs (88-87) Shadow, (89) Spirit	561-109	562-209	561-109	562-209	559-150	(9) (21)

Stealth

1996-91	Inc: 2WD + 4WD	561-126	562-226	561-126	562-226	559-141	
---------	----------------	---------	---------	---------	---------	---------	--

Stratus

2006-01	Sedan	561-109	562-209	N/A	-	559-163	
2005-01	Coupe	561-126	562-226	561-126	562-226	559-172	(16)
2000-95		561-109	562-209	561-109	562-209	559-150	(9) (21)

Viper

2010-92		560-444		560-444		558-163	(60)
---------	--	---------	--	---------	--	---------	------

EAGLE

Summit (95-89), Talon (98-90)

1998-90	all	561-126	562-226	561-126	562-226	559-172	(16)
---------	-----	---------	---------	---------	---------	---------	------

Vision

1997-93		561-249	562-249	561-249	562-249	559-150	(9)
---------	--	---------	---------	---------	---------	---------	-----

FORD

Ford Truck (See Light Truck Pg. 47)

Aspire, Festiva (93-88)

1997-88		N/A	-	N/A	-	N/R	
---------	--	-----	---	-----	---	-----	--

Contour

2000-98		561-169	562-366	561-169	562-366	559-163	(9)
1997-95		561-169	562-366	561-169	562-366	559-150	(21)

N/R – Not Required • N/A – Dealer Part

* (9) 559-074 Ds	(16) 559-117 DHc	(19) 559-141 Ac	(21) 559-163 Bz	(24) 559-191 Ez	(55) 559-112 D	(60) 558-122 Ds	(66) 559-257 Bz
(67) 559-259 Dc							

WHEEL BOLTS and NUTS – Passenger Car BOULONS et ÉCROUS DE ROUE – pour Automobile

Year Année	Application	FRONT/AVANT		REAR/ARRIERE		Wheel Nut Ecrous	*Optional Nut * Ecrou Facultatif
		Wheel Bolt Boulon	Wheel Parts Kit Trousse	Wheel Bolt Boulon	Wheel Parts Kit Trousse		

*OPTIONAL NUTS / ECROUS FACULTATIF

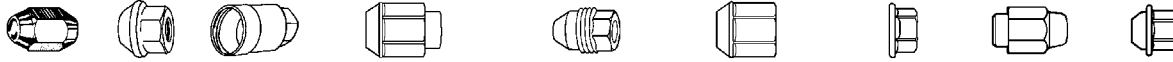

A=Acorn B=Bulge C=Cover D=DometopCapped E=External Thread F=FlattopCapped H=Flanged Flat M=Mag W=Wire Wheel S=Standard

FINISHES
b = black
c = chrome
g = grey
s = stainless
z = zinc

FORD (Cont'd)

Crown Victoria, Country Sedan, Country Squire, Courier

2011-07		561-367	562-367	560-368	562-468	558-016	(2) (6) (61) (62) (63)
2006-02		561-367	562-367	561-367	562-367	558-016	(2) (6)
1997-92		560-367	562-367	560-367	562-367	558-016	(2) (6)
1991-77	Inc: (77-76) rear drums	560-167	562-267	560-173	562-273	558-016	(2) (6)
1977-76	w/ rear discs from 3/1/76	560-167	562-267	560-172	562-272	558-016	(2)

Edge, Flex (15-09), Five Hundred (07-05)

2015-07	Bolt: Edge (15-11) rear only, Flex (15-09)	560-561	-	560-561	-	558-146	
---------	--	---------	---	---------	---	---------	--

Escort, EXP

2002-91		561-169	562-366	561-169	562-366	559-172	(43)
1990-83	from 2/1/83	561-251	562-351	561-248	562-348	559-150	
1983-81	to 1/31/83	560-172	562-272	560-173	562-273	558-146	

Focus

2015-00		561-169	562-366	561-168	562-368	559-075	
---------	--	---------	---------	---------	---------	---------	--

Fusion

2015-06		561-169	562-366	561-169	562-366	559-070	(19) (43)
---------	--	---------	---------	---------	---------	---------	-----------

LTD, LTDII, Maverick (77-74)

1986-83	(77-74) Maverick w/ front discs	560-172	562-272	560-173	562-273	558-016	(5) (6)
1982-76	LTD, LTDII w/rear drums	560-167	562-267	560-173	562-273	558-016	(2) (6)
1977-76	w/ rear discs	560-167	562-267	560-172	562-272	558-016	(2)

Mustang, Pinto (80-74)

2016-15		-	-	-	-	559-257	
2014-05		560-523	-	560-441	-	558-016	(6) (58) (61) (63)
2004-94		560-367	562-367	560-368	562-468	558-016	(2) (5)
1993-90	4 cyl.	560-172	562-272	560-173	562-273	558-016	(2) (5)
1993-87	8 cyl.	560-167	562-267	560-173	562-273	558-016	(2) (5)
1986-76		560-172	562-272	560-173	562-273	558-016	(2) (5) (6)
1975-74		560-172	562-272	560-167	562-267	558-016	(2)
1973-72	w/ front discs	560-148	562-248	560-173	562-273	558-016	(2)
1973-64	w/ front drums Exc: Full cast	560-034	562-171	560-173	562-273	558-016	
1971-68	w/ front discs	560-110	562-211	560-173	562-273	558-016	
1970-64	w/ front drums Full cast	560-155	562-155	560-173	562-273	558-016	

Probe

1997-93		561-169	562-366	561-169	562-366	559-070	(46)
1992-89		561-169	562-366	561-168	562-368	559-070	(46)

Taurus

2015-08		560-523	-	560-523	-	558-163	
2007-98	w/ rear drums	561-416	-	561-247	-	559-163	(9)
2007-98	w/ rear discs	561-416	-	561-376	562-476	559-163	(9)
1995-93	w/ rear discs	561-251	562-351	561-376	562-476	559-150	(9) (21)
1995-90	w/ rear drums	561-251	562-351	561-247	-	559-150	(9) (21)
1989-86		561-251	562-351	561-248	562-348	559-150	(9) (21)

N/A – Dealer Part

* (2) 558-071 Ds	(5) 558-143 Ds	(6) 558-162 Bz	(9) 559-074 Ds	(19) 559-141 Ac	(21) 559-163 Bz	(43) 559-305 Ds	(46) 559-172 Sz
(58) 558-146 Ac	(61) 558-197 Wz	(62) 558-222 Sz	(63) 558-292 Ds				

WHEEL BOLTS and NUTS – Passenger Car BOULONS et ÉCROUS DE ROUE – pour Automobile

Year Année	Application	FRONT/AVANT		REAR/ARRIERE		Wheel Nut Ecrous	*Optional Nut * Ecrou Facultatif
		Wheel Bolt Boulon	Wheel Parts Kit Trousse	Wheel Bolt Boulon	Wheel Parts Kit Trousse		

*OPTIONAL NUTS / ECROUS FACULTATIF

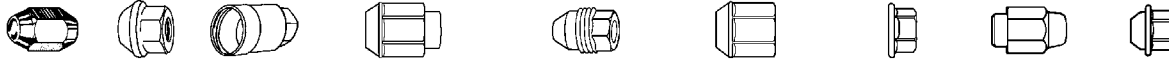

A= Acorn B= Bulge C= Cover D= DomestopCapped E= External Thread F= FlattopCapped H= Flanged Flat M= Mag W= Wire Wheel S= Standard

FINISHES
b = black
c = chrome
g = grey
s = stainless
z = zinc

FORD (Cont'd)

Tempo							
1994-84		561-251	562-351	561-248	562-348	559-150	(9)

Thunderbird, ZX2 (03-98)							
2005-03		561-247	-	561-247	-	N/A	(19) (43)
2001-99		561-169	562-366	561-169	562-366	559-070	(19) (43)
1997-91		561-251	562-351	561-249	562-249	559-150	(9) (21)
1990-89		561-250	-	561-249	562-249	559-150	(21)
1988-87		560-167	562-267	560-173	562-273	558-016	(2) (5) (6)
1986-80		560-172	562-272	560-173	562-273	558-016	(2) (5) (6)
1979-76	w/ drums from 3/1/76	560-167	562-267	560-173	562-273	558-016	(2) (5) (6)
1975	w/ rear discs	560-148	562-248	560-172	562-272	558-016	(2)
1975-73	Inc: (75) rear drums	560-148	562-248	560-167	562-267	558-016	(2)
1972-69		560-148	562-248	560-173	562-273	558-016	
1968-65		560-110	562-211	560-173	562-273	558-016	
1964-61	Exc: Full cast drums	560-034	562-171	560-173	562-273	558-016	
1964-61	Full cast drums	560-155	562-155	560-173	562-273	558-016	
1960-55		560-173	562-273	560-173	562-273	558-016	

GEO

Metro							
1998-95	w/ ABS	561-175	562-275	561-175	562-275	559-064	
1998-90	w/o ABS	561-175	562-275	561-174	562-274	559-064	
1994-89	w/10mm studs	561-380	562-480	561-380	562-480	559-060	

Prizm							
1997-89		561-126	562-226	561-126	562-226	559-172	

Spectrum (89), Storm (93-90)							
1993-89		561-112	-	561-112	-	559-150	(9)

Tracker							
1997-96		561-175	562-275	561-175	562-275	559-064	
1995-89		561-175	562-275	561-174	562-274	559-064	(10)

HONDA

Accord, Accord Hybrid (08-05)							
2015-03	Accord, Accord Hybrid	561-154	-	561-154	-	559-138	(42)
2002-99		561-169	562-366	561-154	-	559-075	(42)
1998		561-169	562-366	561-154	-	559-138	(42)
1997-90		561-169	562-366	561-154	-	559-075	(18)
1989-82		561-154	-	561-154	-	559-075	(18)
1981-76		561-155	-	561-155	-	559-078	

Civic, Civic Del Sol, Civic Hybrid (08-03), CRX (91-88), S2000 (08-00)							
2015-80		561-154	-	561-154	-	559-075	(18) (42)
1979-73		561-155	-	561-155	-	559-078	

N/A – Dealer Part

* (2) 558-071 Ds	(5) 558-143 Ds	(6) 558-162 Bz	(9) 559-074 Ds	(10) 559-078 Ac	(18) 559-138 AHc	(19) 559-141 Ac	(21) 559-163 Bz
(42) 559-301 ABc	(43) 559-305 Ds						

WHEEL BOLTS and NUTS – Passenger Car BOULONS et ÉCROUS DE ROUE – pour Automobile

Year Année	Application	FRONT/AVANT		REAR/ARRIERE		Wheel Nut Ecrous	*Optional Nut * Ecrou Facultatif
		Wheel Bolt Boulon	Wheel Parts Kit Trousse	Wheel Bolt Boulon	Wheel Parts Kit Trousse		

*OPTIONAL NUTS / ECROUS FACULTATIF

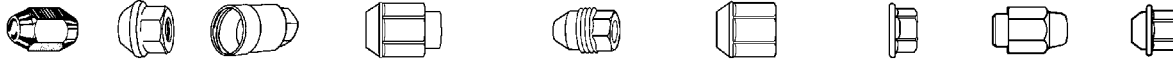

A=Acorn B=Bulge C=Cover D=DometopCapped E=External Thread F=FlattopCapped H=Flanged Flat M=Mag W=Wire Wheel S=Standard

FINISHES
b = black
c = chrome
g = grey
s = stainless
z = zinc

HONDA (Cont'd)

CR-V, CR-Z (15-11)							
2015-97		561-112	-	561-112		559-075	
Crosstour (15-10), Fit							
2015-07		561-112	-	561-112	-	559-163	(1)
Element (11-03), Insight (13-00)							
2013-00		561-112	-	561-112		559-075	(18)
Odyssey (04-95), Pilot (08-03)							
2008-95		561-112	-	561-169	562-366	559-138	(42)
Odyssey (15-05), Pilot (15-09), Ridgeline (14-06)							
2015-05		561-527	-	561-527	-	N/A	
Passport							
2002-96		561-106	562-306	561-312	562-412	559-074	(17)
1995-94	2WD, DX models	561-106	562-306	561-110	562-310	559-074	(17)
1995-94	2WD, EX, LX models, 4WD	561-106	562-306	561-312	562-412	559-074	(17)
Prelude							
2001-92		561-168	562-368	561-154	562-354	559-138	
1991-83		561-154	562-354	561-154	562-354	559-075	(18)
1982-79		561-152	-	561-152	-	N/R	
Wagovan							
1989-82		561-154	562-354	561-154	562-354	559-075	

HYUNDAI

Accent							
2015-07		561-169	562-366	N/A	-	559-172	(19)
2006-00		561-126	562-226	561-169	562-366	559-172	(19)
1999-95		561-140	562-240	N/A	-	559-070	(19)
Azera							
2015-06		561-169	562-366	561-169	562-366	559-172	(19)
Elantra (05-92), Excel (94-87), Scoupe (95-91)							
2005-99	w/ ABS	561-126	562-226	561-169	562-366	559-172	(19)
2001-99	w/o ABS	561-126	562-226	561-126	562-226	559-172	(19)
1998-94	Inc: (95-94) w/ABS	561-140	562-240	561-126	562-226	559-070	(44)
1995-87	Inc: (95-94) w/o ABS, (94-87) Excel, (95-91) Scoupe	561-140	562-240	561-140	562-240	559-070	(19) (44)
Elantra (15-06), Elantra Coupe (15-13), Elantra GT (15-13), Entourage (10-07), Equus (15-11)							
2015-06		561-169	562-366	561-169	562-366	559-141	
Genesis (15-10), Genesis Coupe (15-10), Veloster (15-06), Veracruz (12-07)							
2015-07		561-169	562-366	561-169	562-366	559-172	(19)
Santa Fe, Santa Fe XL							
2015-01		561-169	-	561-169	-	559-172	(19)

N/A – Dealer Part

* (1) 558-070 Ds	(17) 559-137 Ahc	(18) 559-138 Ahc	(19) 559-141 Ac	(42) 559-301 Abc	(44) 559-308 Ac		
------------------	------------------	------------------	-----------------	------------------	-----------------	--	--

WHEEL BOLTS and NUTS – Passenger Car BOULONS et ÉCROUS DE ROUE – pour Automobile

Year Année	Application	FRONT/AVANT		REAR/ARRIERE		Wheel Nut Ecrous	*Optional Nut * Ecrou Facultatif
		Wheel Bolt Boulon	Wheel Parts Kit Trousse	Wheel Bolt Boulon	Wheel Parts Kit Trousse		

*OPTIONAL NUTS / ECROUS FACULTATIF

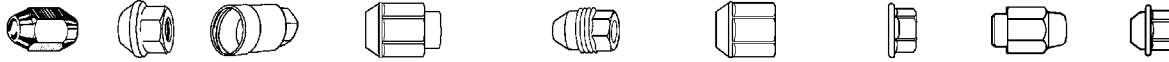

A= Acorn B= Bulge C= Cover D= DometopCapped E= External Thread F= FlattopCapped H= Flanged Flat M= Mag W= Wire Wheel S= Standard

FINISHES
b = black
c = chrome
g = grey
s = stainless
z = zinc

HYUNDAI (Cont'd)

Sonata							
2015-04		561-169	562-366	N/A	-	559-172	(19)
2003-99		561-126	562-226	561-126	562-226	559-172	(19)
1998-94	13mm rear knurl dia.	561-126	562-226	561-169	562-366	559-070	(44)
1998-94	14.3mm rear knurl dia.	561-126	562-226	561-126	562-226	559-070	(44)
Tiburon							
2008-05		561-247	-	N/A	-	559-172	(19)
2004-03		561-126	562-226	N/A	-	559-172	(19)
2001-97		561-140	562-240	561-169	562-366	559-172	(19)
Tucson							
2015-05		561-169	562-366	561-169	562-366	559-172	(19)
XG 300, XG 350							
2005-02		561-126	562-226	561-126	562-226	559-172	
2001		561-126	562-226	561-445	-	559-172	

INFINITI

EX35 (12-08), EX37 (15-13), FX35 (12-08), FX37 (15-13), FX45 (08-03), FX50 (13-09), G20 (02-91), G25 (12-11), G35 (08-03), G37 (14-07), I30 (01-96), I35 (04-02), M45 (10-03), QX56 (13-04)							
2015-91	I30, G20 (02-96)	561-378	562-478	561-378	562-478	559-114	
1995-91	G20	561-378	562-478	561-100	562-200	559-125	(15)
J30							
1997-93		561-100	562-200	561-378	562-478	559-125	
M30							
1992-90		561-100	562-200	561-100	562-200	559-125	
M35 (10-06), M37 (13-11), Q45 (06-90)							
2013-02	Aluminum wheels use 559-125 Nut	561-378	562-478	561-100	562-200	559-114	
2001-97		561-100	562-200	561-378	562-478	559-114	
1996-90		561-378	562-478	561-100	562-200	559-125	
QX4							
2003-97		561-102	562-302	561-100	562-200	559-114	

ISUZU

Isuzu Truck (See Light Truck Pg. 51)							
Ascender							
2008-06		561-110	562-310	N/A	-	559-190	
2005-02		561-169	562-366	N/A	-	559-163	
I-Mark, Impulse, Stylus							
1993-81		561-112	-	561-112	-	559-150	(9)
Oasis							
1999-96		561-169	562-366	561-169	562-366	559-138	

N/A – Dealer Part

* (9) 559-074 Ds (15) 559-114 Ac (19) 559-141 Ac (44) 559-308 Ac

WHEEL BOLTS and NUTS – Passenger Car BOULONS et ÉCROUS DE ROUE – pour Automobile

Year Année	Application	FRONT/AVANT		REAR/ARRIERE		Wheel Nut Ecrous	*Optional Nut * Ecrou Facultatif
		Wheel Bolt Boulon	Wheel Parts Kit Trousse	Wheel Bolt Boulon	Wheel Parts Kit Trousse		

*OPTIONAL NUTS / ECROUS FACULTATIF

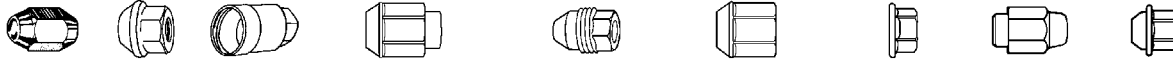

A=Acorn B=Bulge C=Cover D=DometopCapped E=External Thread F=FlattopCapped H=Flanged Flat M=Mag W=Wire Wheel S=Standard

FINISHES
b = black
c = chrome
g = grey
s = stainless
z = zinc

JEEP

Cherokee

2001-00		N/A	-	560-364	562-464	558-148	(60)
1999-90	Inc: (96-93) w/ rear drums, (92-90) 4WD	560-173	562-273	560-364	562-464	558-148	
1996-93	w/ rear discs	560-173	562-273	560-155	562-155	558-148	
1992-87	2WD	560-102	562-172	560-364	562-464	558-148	
1989-86	4WD Inc: Dana rear axle	560-148	562-248	560-364	562-464	558-148	
1986-84	Inc: (86) AMC rear axle	560-148	562-248	560-032	-	558-148	
1983-74	Inc: (76-74) w/ front discs	560-604	562-204	560-114	562-114	558-014	

CJ Series, DJ Series,

1986-77	Inc : (77) w/ front discs	560-187	-	560-103	562-173	558-016	
1977-74	Inc : (77) w/ front drums	560-173	562-273	560-103	562-173	558-016	
1973-72		560-173	562-273	560-173	562-273	558-016	

Comanche, Wagoneer

1992-90	4WD	560-173	562-273	560-364	562-464	558-148	
1992-88	2WD	560-102	562-172	560-364	562-464	558-148	
1989-88	4WD	560-148	562-248	560-364	562-464	558-148	
1987	2WD Front	560-102	562-172	-	-	558-148	
1987	4WD Front	560-148	562-248	-	-	558-148	
1987	Rear Dana 35 axle	-	-	560-364	562-464	558-148	
1987	Rear Dana 44 axle	-	-	560-032	-	558-148	
1986	Rear AMC axle	560-148	562-248	560-032	-	558-148	
1986	Rear Dana 35 axle	560-148	562-248	560-364	562-464	558-148	
1986	Rear Dana 44 axle	560-148	562-248	N/A	-	558-148	

Commander

2010-06		560-287	-	560-287	-	558-094	(60)
---------	--	---------	---	---------	---	---------	------

Compass

2015-07		561-445	-	561-445	-	559-172	(16) (19)
---------	--	---------	---	---------	---	---------	-----------

Grand Cherokee

2016-11		-	-	-	-	559-236	
2010-02		560-175	-	560-175	-	558-148	(60)
1999-93	w/ rear discs	560-173	562-273	560-155	562-156	558-148	
1999-93	w/ rear drums	560-173	562-273	560-364	562-464	558-148	

Grand Wagoneer

1991-84		560-604	562-204	560-114	562-114	558-140	
---------	--	---------	---------	---------	---------	---------	--

J-Series, Pickup, Gladiator

1988-74	J10 Exc : (76-74) w/ front drums	560-604	562-204	560-114	562-114	558-014	
1988-74	J20	N/A	-	560-472	-	558-100	

Liberty

2012-08		N/A	-	N/A	-	558-094	(60)
2007-03		560-444	-	560-175	-	558-094	
2002		560-444	-	560-175	-	558-094	

Patriot

2015-07		561-445	-	561-445	-	559-074	
---------	--	---------	---	---------	---	---------	--

N/A – Dealer Part

* (16) 559-117 DHc	(19) 559-141 Ac	(60) 558-122 Ds	
--------------------	-----------------	-----------------	--

WHEEL BOLTS and NUTS – Passenger Car BOULONS et ÉCROUS DE ROUE – pour Automobile

Year Année	Application	FRONT/AVANT		REAR/ARRIERE		Wheel Nut Ecrous	*Optional Nut * Ecrou Facultatif
		Wheel Bolt Boulon	Wheel Parts Kit Trousse	Wheel Bolt Boulon	Wheel Parts Kit Trousse		

*OPTIONAL NUTS / ECROUS FACULTATIF

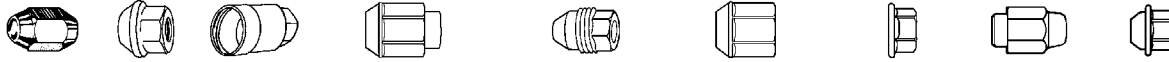

A= Acorn B= Bulge C= Cover D= Domestop Capped E= External Thread F= Flattop Capped H= Flanged Flat M= Mag W= Wire Wheel S= Standard

FINISHES
b = black
c = chrome
g = grey
s = stainless
z = zinc

JEEP (Cont'd)

Scrambler							
1985-81		560-187	-	560-103	562-173	558-016	
Wrangler							
2015-08		560-444	-	560-448	-	559-074	(60)
2005-03	w/ Trulok Differential	560-444	-	560-448	-	N/A	
1999-90		560-173	562-273	560-364	562-464	558-148	
1989-87		560-148	562-248	560-364	562-464	558-148	

KIA

Amanti							
2009-06		561-169	-	561-169	-	559-172	(19)
2005-04		561-126	562-226	N/A	-	559-163	
Borrego (11-09), Cadenza (15-14), Forte, Forte 5 (15-10), Forte Koup (15-10)							
2015-09		561-169	-	N/A	-	559-141	
Optima							
2015-07		561-169	-	561-169	-	559-141	
2006-01		561-126	562-226	561-126	562-226	559-172	(45)
Rio, Rio 5							
2015-03		561-169	-	561-169	-	559-141	
2002-01		N/A	-	N/A	-	N/A	
Rondo							
2010-07		561-169	-	561-169	-	559-141	
Sedona (12-02), Spectra (09-00), Spectra 5 (09-07)							
2012-02	Sedona	561-169	-	561-169	-	559-141	(45)
2009-07	Spectra 5	561-169	-	N/A	-	559-172	(19)
2009-00	Spectra	561-169	-	561-169	-	559-172	(19) (45)
Sephia							
2001-98		561-169	-	N/A	-	559-141	(45)
1997-93	w/ rear discs	561-169	562-366	N/A	-	559-141	(45) (46)
1997-93	w/ rear drums	561-169	562-366	561-169	562-366	559-141	(45) (46)
Sorento							
2015-03		561-169	562-366	561-169	562-366	559-141	
Soul							
2015-10		561-169	-	561-169	-	559-141	
Sportage							
2015-05		561-169	-	561-169	-	559-141	
2002-95		561-169	562-366	561-168	562-368	559-141	

LEXUS

CT200h (15-11), ES300h (15-13), ES330 (06-04), ES350 (15-07)							
2015-04		561-126	562-226	561-126	562-226	559-117	

N/A – Dealer Part

*	(19) 559-141 Ac	(45) 559-309 Ac	(46) 559-172 Sz	(60) 558-122 Ds			
---	-----------------	-----------------	-----------------	-----------------	--	--	--

WHEEL BOLTS and NUTS – Passenger Car BOULONS et ÉCROUS DE ROUE – pour Automobile

Year Année	Application	FRONT/AVANT		REAR/ARRIERE		Wheel Nut Ecrous	*Optional Nut * Ecrou Facultatif
		Wheel Bolt Boulon	Wheel Parts Kit Trousse	Wheel Bolt Boulon	Wheel Parts Kit Trousse		

*OPTIONAL NUTS / ECROUS FACULTATIF

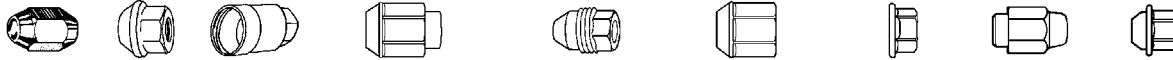

A=Acorn B=Bulge C=Cover D=DometopCapped E=External Thread F=FlattopCapped H=Flanged Flat M=Mag W=Wire Wheel S=Standard

FINISHES
b = black
c = chrome
g = grey
s = stainless
z = zinc

LEXUS (Cont'd)

ES250, ES300

2003-02		561-126	562-226	561-126	562-226	559-117	(65)
2001-90		561-126	562-226	561-122	562-372	559-117	

GS300 (06-93), GS350 (15-07), GS400 (00-98), GS430 (07-01), GS450h (15-07), GS460 (11-98)

2015-93		561-126	562-226	561-126	562-226	559-117	
---------	--	---------	---------	---------	---------	---------	--

GX460 (15-10), GX470 (09-03)

2015-03		561-126	562-226	561-126	562-226	559-117	(65)
---------	--	---------	---------	---------	---------	---------	------

HS250h (12-10), ISF (14-08), IS250 (13-06), IS300 (05-01), IS350 (15-06)

2015-06		561-126	562-226	561-126	562-226	559-117	
---------	--	---------	---------	---------	---------	---------	--

LS460 (15-07), LS600h (15-08), LX470 (07-98), LX570 (15-08), NX200t (15-14), NX300h (15-14)

2015-98		561-527	-	561-527	-	559-277	
2015-14	NX200t / NX300h	561-126	-	561-126	-	559-117	

RX300 (03-99), RX330 (05-04), RX350 (15-07), RX450h (15-10)

2012-99		561-126	562-226	561-126	562-226	559-117	
---------	--	---------	---------	---------	---------	---------	--

SC300 (00-92), SC400 (00-92), SC430 (10-02)

2010-92		561-126	562-226	561-126	562-226	559-117	(65)
---------	--	---------	---------	---------	---------	---------	------

LINCOLN

Aviator

2005-03		560-444	-	560-444	-	558-199	
---------	--	---------	---	---------	---	---------	--

Blackwood

2002		561-442	-	561-442	-	559-196	
------	--	---------	---	---------	---	---------	--

Continental

2002-01		561-416	-	N/A	-	559-163	(9)
2000-95		561-416	-	561-376	562-476	559-163	(9)
1994-93		561-251	562-351	561-376	562-476	559-163	
1992-90		561-251	562-351	561-247	-	559-163	
1989-88		561-251	562-351	561-248	562-248	559-150	(21)
1987-80		560-167	-	560-173	562-273	558-016	(2) (6)
1979-76	w/ rear discs	560-167	-	560-172	562-272	558-016	(6)
1979-76	w/ rear drums	560-167	-	560-173	562-273	558-016	(6)

LS

2006-00		561-110	562-310	561-110	562-310	559-163	
---------	--	---------	---------	---------	---------	---------	--

Mark Series

1998-93		561-251	562-351	561-249	562-249	559-163	(9)
1992-80		560-167	-	560-173	562-273	558-016	(2) (5) (6)
1979-76	w/ rear discs	560-167	-	560-172	562-272	558-016	(6)
1979-76	w/ rear drums	560-167	-	560-173	562-273	558-016	(6)

MKC, MKS, MKT, MKX, MKZ

2015-07		560-561	-	560-561	-	558-094	
---------	--	---------	---	---------	---	---------	--

MKZ

2012-07		561-169	562-366	561-169	562-366	559-190	
---------	--	---------	---------	---------	---------	---------	--

N/A – Dealer Part

* (2) 558-071 Ds	(5) 558-143 Ds	(6) 558-162 Bz	(9) 559-074 Ds	(21) 559-163 Bz	(65) 559-167 Mc	
------------------	----------------	----------------	----------------	-----------------	-----------------	--

WHEEL BOLTS and NUTS – Passenger Car BOULONS et ÉCROUS DE ROUE – pour Automobile

Year Année	Application	FRONT/AVANT		REAR/ARRIERE		Wheel Nut Ecrous	*Optional Nut * Ecrou Facultatif
		Wheel Bolt Boulon	Wheel Parts Kit Trousse	Wheel Bolt Boulon	Wheel Parts Kit Trousse		

*OPTIONAL NUTS / ECROUS FACULTATIF

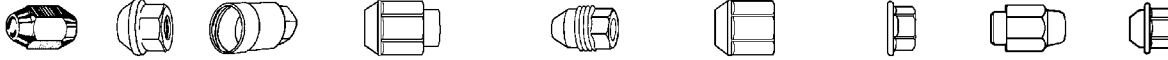

A= Acorn B= Bulge C= Cover D= DomestopCapped E= External Thread F= FlattopCapped H= Flanged Flat M= Mag W= Wire Wheel S= Standard

FINISHES
b = black
c = chrome
g = grey
s = stainless
z = zinc

LINCOLN (Cont'd)

Navigator, Mark LT (08-06)

2015-03		561-442	-	561-442	-	559-323	(53)
2008-03	Mark LT	561-442	-	561-442	-	559-323	(47)
2002-01		561-442	-	561-442	-	559-196	
2000	14mm, all	561-442	-	561-442	-	559-196	
2000-98	12mm, all	561-390	-	561-390	-	559-174	

TownCar

2011-91		560-367	562-367	560-368	562-468	558-016	
1990-82		560-167	-	560-173	562-273	558-016	(2) (6)

Versailles

1980-77		560-172	562-272	560-172	562-272	558-016	
---------	--	---------	---------	---------	---------	---------	--

MAZDA

Mazda Truck (See Light Truck Pg. 52)

2 (15-10), 3 (15-03) (incl. Sport, Touring, Grand Touring)

2013-10	2	N/A	-	N/A	-	559-172	(19)
2013-03	3 (13-03)	N/A	-	561-168	562-368	559-141	

323, MX-3 (95-92)

1995-92	323 from 3/9/93	561-109	562-309	561-169	562-366	559-172	(19)
1993-90	323 to 3/8/93	561-169	562-366	561-169	562-366	559-172	(19)
1989-88	4WD	561-166	-	561-166	-	559-172	(19)
1989-86	Inc: (89-88) 2WD	561-166	-	561-168	562-368	559-172	(19)

5, MX5 Miata (15-06)

2015-07		561-110	-	561-169	562-366	559-172	(19)
2006		561-169	562-366	561-169	562-366	559-172	(19)

6, CX7 (12-07), CX9 (15-07)

2015-03	6	N/A	-	N/A	-	559-141	
2013-07	CX7, CX9	561-110	-	N/A	-	559-172	(19)

626 (02-79), MPV (04-89)

2004-93		561-169	562-366	561-169	562-366	559-172	
1992-88	MPV rear stud use 561-169	561-169	562-366	561-168	562-368	559-172	(19)
1987-83		561-166	-	561-168	562-368	559-172	(19)
1982-79		561-167	-	561-167	-	N/R	

929

1995-92		561-169	562-366	561-169	562-366	559-172	
1991-88		561-168	562-368	561-169	562-366	559-172	(19)

GLC

1985-81	Sedan or Hatchback	561-166	-	561-168	562-368	559-172	(19)
1985-77	Inc: (85-81) Wagon	561-167	-	561-167	-	N/R	

Miata, MX-3 (95-92)

2005-93	from 6/1/93	561-169	562-366	561-109	562-209	559-172	(19)
1993-90	to 5/31/93	561-169	562-366	561-169	562-366	559-172	(19)

N/R – Not Required • N/A – Dealer Part

* (2) 558-071 Ds	(6) 558-162 Bz	(19) 559-141 Ac	(47) 559-306 Ds	(53) 559-288 Dc		
------------------	----------------	-----------------	-----------------	-----------------	--	--

WHEEL BOLTS and NUTS – Passenger Car BOULONS et ÉCROUS DE ROUE – pour Automobile

Year Année	Application	FRONT/AVANT		REAR/ARRIERE		Wheel Nut Ecrous	*Optional Nut * Ecrou Facultatif
		Wheel Bolt Boulon	Wheel Parts Kit Trousse	Wheel Bolt Boulon	Wheel Parts Kit Trousse		

*OPTIONAL NUTS / ECROUS FACULTATIF

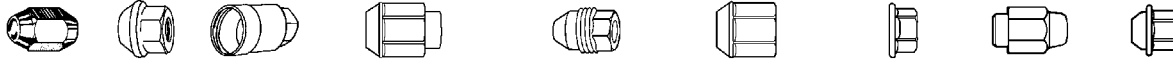

A=Acorn B=Bulge C=Cover D=DometopCapped E=External Thread F=FlattopCapped H=Flanged Flat M=Mag W=Wire Wheel S=Standard

FINISHES
b = black
c = chrome
g = grey
s = stainless
z = zinc

MAZDA (Cont'd)

Millenia (02-95), MX-6 (97-88)

2002-93	Inc : Millenia (02-95)	561-169	562-366	561-169	562-366	559-172	(19)
1992-88	MX-6	561-169	562-366	561-168	562-368	559-172	(19)

Protégé, Protégé 5

2003-02	w/ rear disc brakes	561-169	562-366	N/A	-	559-172	(19)
2003-93	w/ rear drum brakes, from 3/9/93	561-109	562-209	561-169	562-366	559-172	(19)
1993-90	to 3/8/93	561-169	562-366	561-169	562-366	559-172	(19)

RX-7

1995-93		561-169	562-366	561-169	562-366	559-141	
1992-86	Inc: (88-86) Convertible, Coupe	561-255	-	561-168	562-368	559-172	(19)
1985-84	w/ Carburetor	561-167	-	561-167	-	N/R	
1985-84	w/ EFI	561-168	562-368	561-168	562-368	559-172	(19)
1983-79		561-167	-	561-167	-	N/R	

RX-8

2011-04		N/A	-	561-250	-	559-141	
---------	--	-----	---	---------	---	---------	--

Tribute

2006-01		561-251	562-351	N/A	-	559-085	
---------	--	---------	---------	-----	---	---------	--

MERCEDES-BENZ

190 Series

1985-84		561-132	-	561-132	-	N/R	
---------	--	---------	---	---------	---	-----	--

380 Series, 500SEL (85-84)

1985-81		561-132	-	561-132	-	N/R	
---------	--	---------	---	---------	---	-----	--

C250 (13-10), C300 (13-08), C350 (13-08), C63AMG (15-08), CLA45 AMG (15-14), CLK63 AMG (09-08), CLS500 (06), CLS55 AMG (06), CLS63 AMG (14-07), E320 (09-06), E350 (12-06), E500 (06), E55 AMG (06), E550 (12-07), E63 AMG (2015-07), ML 320 (03-00), ML 350 (05-03), ML 430 (01-00), ML 500 (05-02), ML55 AMG (03-00), R320 (09-07), R350 (12-06), R500 (07-06), R63 AMG (07), SL55 AMG (08), SL550 (13-08), SL600 (11-08), SL63 AMG (15-09), SL65 AMG (15-08), SLK250 (15-14), SLK350 (15-14), SLK55 AMG (15-13), SLR McLaren (2009)

2015-00	Exc. 19 in. Multi-Spoke	561-516	-	561-516	-	N/R	-
---------	-------------------------	---------	---	---------	---	-----	---

MERCURY

Capri

1994-91		561-166	-	561-168	562-368	559-070	
1986-79		560-345	-	560-173	562-273	558-016	(2) (5) (6)
1977-76		561-110	562-310	561-110	562-310	559-150	

Colony Park, Commuter, Country Cruiser

1991-76	Inc: (76) from 3/1/76 w/ rear drums	560-167	-	560-173	562-273	558-016	(2) (6) (61) (62) (63)
1976	from 3/1/76 w/ rear discs	560-167	-	560-172	562-272	558-016	(2)
1976-75	to 2/29/76 w/ rear discs	560-148	562-248	560-172	562-273	558-016	(2)
1975	w/ rear drums	560-148	562-248	560-163	-	558-016	

Cougar (See FORD THUNDERBIRD)

2002-99		561-169	562-366	561-169	562-366	559-070	(43)
---------	--	---------	---------	---------	---------	---------	------

N/R – Not Required • N/A – Dealer Part

* (2) 558-071 Ds	(5) 558-143 Ds	(6) 558-162 Bz	(19) 559-141 Ac	(43) 559-305 Ds	(61) 558-197 Wz	(62) 558-222 Sz	(63) 558-292 Ds
------------------	----------------	----------------	-----------------	-----------------	-----------------	-----------------	-----------------

WHEEL BOLTS and NUTS – Passenger Car BOULONS et ÉCROUS DE ROUE – pour Automobile

Year Année	Application	FRONT/AVANT		REAR/ARRIERE		Wheel Nut Ecrous	*Optional Nut * Ecrou Facultatif
		Wheel Bolt Boulon	Wheel Parts Kit Trousse	Wheel Bolt Boulon	Wheel Parts Kit Trousse		

*OPTIONAL NUTS / ECROUS FACULTATIF

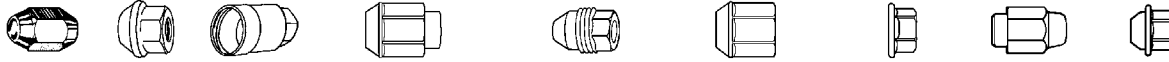

A= Acorn B= Bulge C= Cover D= DometopCapped E= External Thread F= FlattopCapped H= Flanged Flat M= Mag W= Wire Wheel S= Standard

FINISHES
b = black
c = chrome
g = grey
s = stainless
z = zinc

MERCURY (Cont'd)

Grand Marquis, Marauder (04-03)							
2011-01		560-367	562-367	560-368	562-468	558-016	(2) (6)
2001-92	w/o Sport Pkg	560-367	562-367	560-368	562-468	558-016	(2) (6)
1991-77	Inc : (77) w/ rear drums	560-167	-	560-173	562-273	558-016	(2) (6)
1977-76	from 3/1/76 w/ rear discs	560-167	-	560-172	562-272	558-016	(2)

Lynx, LN7 (See FORD ESCORT)

Mariner, Milan							
2011-05		561-251	562-351	561-251	562-351	559-074	(11)

Marquis, Marauder, MontClair, Monterey, Park Lane (See FORD LTD)

Mountaineer (10-95)							
2010-02		560-479	-	560-444	-	558-199	(3)
2001-95	2WD	560-345	-	560-368	562-468	558-163	(8)
2001-95	4WD	560-287	-	560-368	562-468	558-163	(8)

Mystique (See FORD CONTOUR)

Sable (See FORD TAURUS)

Topaz (See FORD TEMPO)

Tracer							
1999-91		561-169	562-366	561-169	562-366	559-070	(43)
1989-87		561-166	-	561-168	562-368	559-070	

Villager, Voyager

2002-93		561-378	562-478	561-378	562-478	559-125	
---------	--	---------	---------	---------	---------	---------	--

MERKUR

Scorpio, XRATI

1989-85		561-110	562-310	561-110	562-310	559-150	
---------	--	---------	---------	---------	---------	---------	--

MINI

Cooper, Cooper Countryman (15-11), Cooper Paceman (15-13)

2015-02		561-532	-	561-532	-	N/R	
---------	--	---------	---	---------	---	-----	--

MITSUBISHI

3000GT

1999-91		561-126	562-226	561-126	562-226	559-117	
---------	--	---------	---------	---------	---------	---------	--

Cordia, Tredia

1988-85	from 1/1/85	561-126	562-226	561-126	562-226	559-172	(19)
1985-84	to 12/31/84	561-140	562-240	561-126	562-226	559-141	
1983		561-140	562-240	561-140	562-240	559-141	

Diamante (04-92), Eclipse (12-90), Eclipse Spyder (05-90), Expo, Expo LRV, Galant (12-85), Lancer (15-02), Mirage (02-85), Sigma (90-88)

2015-83		561-126	562-226	561-126	562-226	559-172	(16) (19)
---------	--	---------	---------	---------	---------	---------	-----------

Endeavor

2011-04		561-126	562-226	561-126	562-226	559-163	(16) (19)
---------	--	---------	---------	---------	---------	---------	-----------

N/R – Not Required • N/A – Dealer Part

* (2) 558-071 Ds (3) 558-094 DBs (6) 558-162 Bz (8) 558-171 Wz (11) 559-085 Wb (16) 559-117 DHc (19) 559-141 Ac (43) 559-305 Ds

WHEEL BOLTS and NUTS – Passenger Car BOULONS et ÉCROUS DE ROUE – pour Automobile

Year Année	Application	FRONT/AVANT		REAR/ARRIERE		Wheel Nut Ecrous	*Optional Nut * Ecrou Facultatif
		Wheel Bolt Boulon	Wheel Parts Kit Trousse	Wheel Bolt Boulon	Wheel Parts Kit Trousse		

*OPTIONAL NUTS / ECROUS FACULTATIF

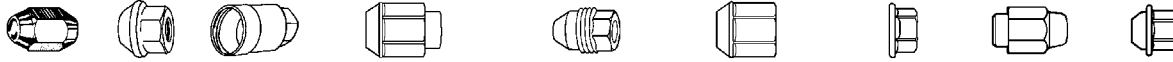

A=Acorn B=Bulge C=Cover D=DometopCapped E=External Thread F=FlattopCapped H=Flanged Flat M=Mag W=Wire Wheel S=Standard

FINISHES
b = black
c = chrome
g = grey
s = stainless
z = zinc

MITSUBISHI (Cont'd)

Mighty Max Pickup

1996-87		561-106	562-206	561-312	562-412	559-172	
1986-83	2WD from 3/1/86, 4WD from 1/1/83	561-106	562-206	N/A	-	559-172	
1986-83	2WD to 2/28/86, 4WD to 12/31/82	561-140	562-240	N/A	-	559-172	

Montero

2006-01		561-126	562-226	561-126	562-226	559-163	
2000-95		561-114	562-114	561-312	562-412	559-117	(19)
1994-92		561-126	562-206	561-312	562-412	559-070	(16) (19)
1991-87		561-114	562-114	561-312	562-412	559-070	(16) (19)
1986-83		561-114	562-114	561-126	562-226	559-070	

Montero Sport

2004-00		561-106	562-206	561-312	562-412	559-117	(19)
1999-97		561-126	562-226	561-312	562-412	559-117	(19)

Outlander, Outlander Sport (15-11), RVR (15-11)

2015-03		561-126	562-226	561-126	562-226	559-141	
---------	--	---------	---------	---------	---------	---------	--

Precis

1993-87		561-140	562-240	561-140	562-240	559-141	
---------	--	---------	---------	---------	---------	---------	--

Raider

2009-06		560-389	-	560-389	-	559-204	
---------	--	---------	---	---------	---	---------	--

Starion

1989-83	Exc: ESI	561-126	562-226	561-126	562-226	559-172	
---------	----------	---------	---------	---------	---------	---------	--

NISSAN

Nissan Truck (See Light Truck Pg.52)

200SX

1998-95		561-378	562-478	561-378	562-478	559-125	(15)
1988-84		561-102	562-302	561-100	562-201	559-125	(14) (15)
1983-77		561-100	562-201	561-100	562-201	559-125	

240SX

1998-95		561-378	562-478	561-100	562-201	559-125	
1994-89		561-100	562-201	561-100	562-201	559-125	

240Z, 260Z, 280Z, 280ZX, 300ZX

1996-90		561-378	562-478	561-100	562-201	559-114	
1989-87	w/ turbo	561-100	562-201	561-100	562-201	559-113	
1989-87	w/o turbo	561-102	562-302	561-100	562-201	559-113	
1986-70		561-102	562-302	561-100	562-201	559-125	(15)

370Z, Rogue (15-08), Rogue Select (15-14)

2015-09		561-378	562-478	561-378	562-478	559-125	(15)
---------	--	---------	---------	---------	---------	---------	------

Altima

2015-97	Aluminum wheels use 559-114 nuts	561-378	562-478	561-378	562-478	559-125	(15)
1996-93		561-378	562-478	561-100	562-201	559-125	(14)

N/A – Dealer Part

* (14) 559-113 Sc	(15) 559-114 Ac	(16) 559-117 DhC	(19) 559-141 Ac			
-------------------	-----------------	------------------	-----------------	--	--	--

WHEEL BOLTS and NUTS – Passenger Car BOULONS et ÉCROUS DE ROUE – pour Automobile

Year Année	Application	FRONT/AVANT		REAR/ARRIERE		Wheel Nut Ecrous	*Optional Nut * Ecrou Facultatif
		Wheel Bolt Boulon	Wheel Parts Kit Trousse	Wheel Bolt Boulon	Wheel Parts Kit Trousse		

*OPTIONAL NUTS / ECROUS FACULTATIF

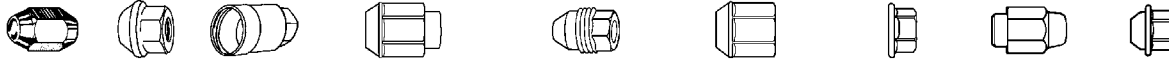

A = Acorn B = Bulge C = Cover D = Dometop Capped E = External Thread F = Flattop Capped H = Flanged Flat M = Mag W = Wire Wheel S = Standard

FINISHES
b = black
c = chrome
g = grey
s = stainless
z = zinc

NISSAN (Cont'd)

Axxess							
1990		561-100	562-201	561-100	562-201	559-125	
Cube							
2015-09		N/A	-	N/A	-	559-114	
GT-R							
2015-09		561-378	562-478	561-378	562-478	559-125	
Juke, Leaf							
2015-11		561-378	562-478	561-378	562-478	559-114	
Maxima (13-82), Murano (15-03), 350Z (09-03)							
2015-95		561-378	562-478	561-378	562-478	559-125	(15)
1994-92		561-378	562-478	561-100	562-201	559-125	(14) (15)
1991-89		561-100	562-201	561-100	562-201	559-113	(15)
1988-85		561-100	562-201	561-102	562-302	559-125	(14) (15)
1984-82		561-102	562-302	561-100	562-201	559-114	
NX1600, NX2000							
1993-91		561-378	562-478	561-378	562-478	559-125	(14) (15)
Pulsar, Pulsar NX							
1990-87		561-100	562-201	561-102	562-302	559-125	(14)
1986-83		561-102	562-302	561-102	562-302	559-125	(15)
Quest							
2015-99		561-378	562-478	561-378	562-478	559-125	
1998-93		561-378	562-478	561-100	562-201	559-125	(14)
Sentra							
2015-91		561-378	562-478	561-378	562-478	559-125	(14) (15)
1990-86	4WD	561-100	562-201	561-100	562-201	559-125	(15)
1990-84	Inc: (90-86) 2WD	561-100	562-201	561-102	562-302	559-125	(15)
1985-82		561-102	562-302	561-102	562-302	559-125	(15)
Stanza							
1992-91		561-378	562-478	561-100	562-201	559-113	
1990		561-100	562-201	561-100	562-201	559-113	
1989-87		561-100	562-201	561-102	562-302	559-125	(15)
1986	Wagon	561-100	562-201	561-102	562-302	559-125	(15)
1986-82	Exc: (86) Wagon	561-102	562-302	561-102	562-302	559-125	(15)
Versa, Versa Note (15-14)							
2015-07		561-378	562-478	561-378	562-478	559-125	(15)

OLDSMOBILE

98							
1996-85		561-110	562-310	561-110	562-310	559-150	(11) (21)
1984-71		560-155	562-155	560-138	562-138	558-016	(23)

N/A – Dealer Part

* (11) 559-085 Wb (14) 559-113 Sc (15) 559-114 Ac (21) 559-163 Bz (23) 559-190 Ds

WHEEL BOLTS and NUTS – Passenger Car BOULONS et ÉCROUS DE ROUE – pour Automobile

Year Année	Application	FRONT/AVANT		REAR/ARRIERE		Wheel Nut Ecrous	*Optional Nut * Ecrou Facultatif
		Wheel Bolt Boulon	Wheel Parts Kit Trousse	Wheel Bolt Boulon	Wheel Parts Kit Trousse		

*OPTIONAL NUTS / ECROUS FACULTATIF

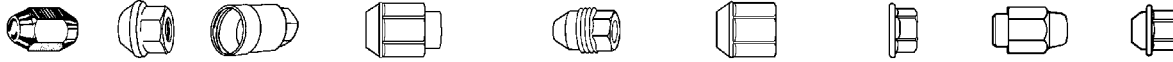

A= Acorn B= Bulge C= Cover D= DometopCapped E= External Thread F= FlattopCapped H= Flanged Flat M= Mag W= Wire Wheel S= Standard

FINISHES
b= black
c= chrome
g= grey
s= stainless
z= zinc

OLDSMOBILE (Cont'd)

Achieva (98-92), Alero (04-99), Aurora (03-95), Bravada (04-91)

2004-91		561-110	562-310	561-110	562-310	559-163	(20) (23) (24) (25) (27) (28) (51)
---------	--	---------	---------	---------	---------	---------	---

Calais, Cutlass Calais

1991-82		561-110	562-310	561-110	562-310	559-150	(11) (12) (23)
1981-78		560-386	562-186	560-114	562-114	558-014	

Ciera, Cutlass Ciera

1996-82		561-110	562-310	561-110	562-310	559-150	(11) (24) (25) (27) (28)
---------	--	---------	---------	---------	---------	---------	--------------------------------

Custom Cruiser

1992-91		561-110	562-310	561-110	562-310	559-150	(21)
1990-71		560-155	562-155	560-138	562-138	558-016	(21)

Cutlass

1999-85		561-110	562-310	561-110	562-310	559-150	(11) (21) (23) (25)
1981-73		560-386	562-126	560-114	562-114	558-014	(1)

Cutlass Supreme

1997-95		561-110	562-310	561-110	562-310	559-191	(25) (28)
1997-95	For replacement w/o front hub removal	561-115	-	561-110	562-310	559-191	(25) (28)
1994-82		561-110	562-310	561-110	562-310	559-150	(13) (21) (24) (28)
1994-82	For replacement w/o front hub removal	561-115	-	561-110	562-310	559-150	(13) (21) (24) (28)
1981-73		560-386	562-126	560-114	562-114	558-014	(1)

Delta 88, Delmont 88, Dynamic 88, EightyEight, Fiesta, Holiday, Royale, Super 88

1999-95		561-110	562-310	561-110	562-310	559-163	(24) (25)
1994-86		561-110	562-310	561-110	562-310	559-150	(11) (21) (23) (24)
1985-71	Inc: (85-77) w/ 11" drums	560-155	562-155	560-138	562-138	558-016	
1985-77	w/ 9.5" rear drums	560-386	562-126	560-114	562-114	558-014	(1)

Firenza

1988-82		561-110	562-310	561-110	562-310	559-150	(11) (12)
---------	--	---------	---------	---------	---------	---------	-----------

Intrigue

2002-98		561-110	562-310	561-110	562-310	559-192	
2002-98	for replacement front w/o hub removal	561-115	-	561-110	562-310	559-192	

LSS

1999-96		561-110	562-310	561-110	562-310	559-163	(24) (25)
---------	--	---------	---------	---------	---------	---------	-----------

Omega

1984-80		561-110	562-310	561-110	562-310	559-190	(11) (12)
---------	--	---------	---------	---------	---------	---------	-----------

* (1) 558-070 Ds	(11) 559-085 Wb	(12) 559-087 Ds	(13) 559-089 Fs	(20) 559-151 EHz	(21) 559-163 Bz	(23) 559-190 Ds	(24) 559-191 Ez
(25) 559-192 Ez	(26) 559-201 Cs	(27) 559-203 Cg	(28) 559-204 Cb	(51) 559-215 Cb			

WHEEL BOLTS and NUTS – Passenger Car BOULONS et ÉCROUS DE ROUE – pour Automobile

Year Année	Application	FRONT/AVANT		REAR/ARRIERE		Wheel Nut Ecrous	*Optional Nut * Ecrou Facultatif
		Wheel Bolt Boulon	Wheel Parts Kit Trousse	Wheel Bolt Boulon	Wheel Parts Kit Trousse		

*OPTIONAL NUTS / ECROUS FACULTATIF

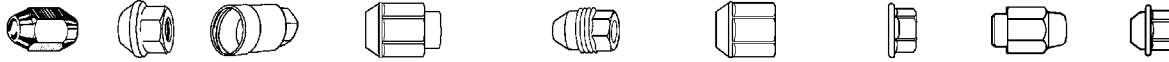

A= Acorn B= Bulge C= Cover D= DomestopCapped E= External Thread F= FlattopCapped H= Flanged Flat M= Mag W= Wire Wheel S= Standard

FINISHES
b = black
c = chrome
g = grey
s = stainless
z = zinc

OLDSMOBILE (Cont'd)

Silhouette							
2004-98		561-110	562-310	561-110	562-310	559-163	(25) (29)
1997-90		561-110	562-310	561-110	562-310	559-192	(28) (30)
Toronado							
1992-79		561-110	562-310	561-110	562-310	559-163	(11) (23)
1978-66		560-138	562-138	560-138	562-138	558-016	

PASSPORT

I-Mark (89-88), Impulse (92-89), Stylus (93-91)							
1993-88	Canadian	561-112	-	561-112	-	559-150	(9)

PLYMOUTH

Plymouth Truck (See Light Truck Pg. 53)							
Acclaim							
1995-90	w/ rear discs	561-109	562-209	561-251	562-351	559-150	(9)
1995-89	w/ rear drums	561-109	562-209	561-108	562-208	559-150	(9)
1989	w/ rear discs	561-109	562-209	561-109	562-209	559-150	(9)
Barracuda							
1974	Kelsey Hayes rotor	560-155	562-155	560-103	562-173	558-027	(3)
1974-73	Inc : Motor Wheel rotor	560-039	-	560-103	562-173	558-027	(3)
1972-71	w/ front discs	560-110	562-310	560-103	562-173	558-027	
1972-71	w/ front drums Kelsey Hayes	560-155	562-155	560-103	562-173	558-027	
1972-71	w/ front drums Motor Wheel	560-366	-	560-103	562-173	558-027	
Breeze							
2000-96		561-109	562-209	561-109	562-209	559-150	(9) (21)
Caravelle							
1988-85		561-109	562-209	561-108	562-208	559-150	(9) (21)
Colt (94-83), Champ (82-79)							
1994-86	all	561-126	562-226	561-126	562-226	559-172	(19)
1985-79	Inc: Champ (82-79)	561-140	562-240	561-140	562-240	559-172	(19)
Colt Vista							
1994-86	2WD+4WD	561-126	562-226	561-126	562-226	559-172	(16) (19)
1985	2WD+4WD	561-126	562-226	561-140	562-240	559-141	
1984		561-140	562-240	561-140	562-240	559-141	
Conquest (See DODGE CONQUEST)							
Duster (See DODGE DART)							
Gran Fury							
1989-80	Inc: Kelsey Hayes rotor	560-155	562-155	560-103	562-173	558-027	
1985-82	Motor Wheel rotor	560-039	-	560-103	562-173	558-027	
1981-80	Budd rotor	560-102	562-172	560-103	562-173	558-027	
1977-74	Budd rotor + Kelsey Hayes rotor	560-105	562-175	560-103	562-173	558-027	

* (3) 558-094 DBs (9) 559-074 Ds (11) 559-085 Wb (16) 559-117 DHc (19) 559-141 Ac (21) 559-163 Bz (23) 559-190 Ds (25) 559-192 Ez
(28) 559-204 Cb (29) 559-209 Cb (30) 559-210 Cg

WHEEL BOLTS and NUTS – Passenger Car BOULONS et ÉCROUS DE ROUE – pour Automobile

Year Année	Application	FRONT/AVANT		REAR/ARRIERE		Wheel Nut Ecrous	*Optional Nut * Ecrou Facultatif
		Wheel Bolt Boulon	Wheel Parts Kit Trousse	Wheel Bolt Boulon	Wheel Parts Kit Trousse		

*OPTIONAL NUTS / ECROUS FACULTATIF

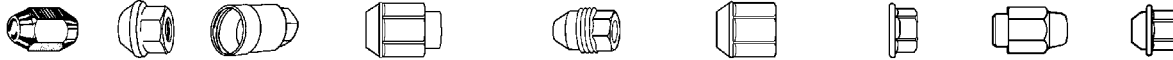

A=Acorn B=Bulge C=Cover D=DometopCapped E=External Thread F=FlattopCapped H=Flanged Flat M=Mag W=Wire Wheel S=Standard

FINISHES
b = black
c = chrome
g = grey
s = stainless
z = zinc

PLYMOUTH (Cont'd)

Horizon

1990-84	Inc: 220mm rear drums	561-109	562-209	561-108	562-208	559-150	(9)
1987-85	200mm rear drums	561-109	562-209	561-109	562-209	559-150	(9)
1983-78		N/A	-	561-108	562-208	559-150	(9)

Laser

1994-90		561-126	562-226	561-126	562-226	559-172	(16)
---------	--	---------	---------	---------	---------	---------	------

Neon (See DODGE NEON)

Prowler

2001-97		561-369	-	561-249	562-249	559-163	
---------	--	---------	---	---------	---------	---------	--

Reliant

1989-81	Inc: 220mm rear drums	561-109	562-209	561-108	562-208	559-150	(9) (21)
1987-85	200mm rear drums	561-109	562-209	561-109	562-209	559-150	(9) (21)

Sapporo

1983-78		561-126	562-226	561-126	562-226	559-070	
---------	--	---------	---------	---------	---------	---------	--

Satellite, Roadrunner, Superbird, Scamp, Valiant (See DODGE FURY)

Sundance

1994-89	w/ rear discs	561-109	562-209	561-251	562-351	559-150	(9) (21)
1994-88	w/ rear drums	561-109	562-209	561-108	562-208	559-150	(9) (21)
1988-87	w/ rear discs, 87 all	561-109	562-209	561-109	562-209	559-150	(9) (21)

Voyager, Grand Voyager (See DODGE CARAVAN)

PONTIAC

6000 (91-82), Bonneville (05-77), Catalina, Executive, Fiero (88-84)

2005-02		561-110	562-310	561-110	562-310	559-192	
2001-00		561-110	562-310	561-110	562-310	559-163	(11) (25)
1999-94		561-110	562-310	561-110	562-310	559-191	
1993-91		561-110	562-310	561-110	562-310	559-163	
1990-82		561-110	562-310	561-110	562-310	559-150	(11) (23)
1981-77	w/ 9.5" rear drums	560-386	562-126	560-114	562-114	558-016	(1)
1981-71	w/ 11" rear drums	560-155	562-155	560-138	562-138	558-016	

Aztek

2005-04	w/ aluminum wheels	561-110	562-310	561-110	562-310	559-190	
2005-01	w/ steel wheels	561-110	562-310	561-110	562-310	559-192	(23) (50)

Firebird, Firefly (00-95)

2002-88	2001 Aluminum Wheels use 559-211 caps	561-110	562-310	561-110	562-310	559-191	(29) (31)
1987-82		561-110	562-310	561-110	562-310	559-150	
1981-70		560-386	562-126	560-114	562-114	558-014	
1969	w/ front discs 1pc. hub+rotor	560-390	-	560-114	562-114	558-014	
1969-67	w/ front discs 2pc. hub+rotor	560-386	562-126	560-114	562-114	558-014	
1969-67	w/ front drums	N/A	-	560-114	562-114	558-014	(1)
1968	w/ front drums	560-114	562-114	560-114	562-114	558-014	

N/A – Dealer Part

* (1) 558-070 Ds	(9) 559-074 Ds	(11) 559-085 Wb	(16) 559-117 DHc	(21) 559-163 Bz	(23) 559-190 Ds	(25) 559-192 Ez	(29) 559-209 Cb
(31) 559-202 Cb	(50) 559-220 Cb						

WHEEL BOLTS and NUTS – Passenger Car BOULONS et ÉCROUS DE ROUE – pour Automobile

Year Année	Application	FRONT/AVANT		REAR/ARRIERE		Wheel Nut Ecrous	*Optional Nut * Ecrou Facultatif
		Wheel Bolt Boulon	Wheel Parts Kit Trousse	Wheel Bolt Boulon	Wheel Parts Kit Trousse		

*OPTIONAL NUTS / ECROUS FACULTATIF

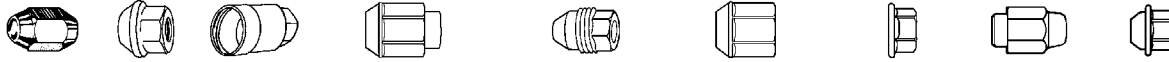

A=Acorn B=Bulge C=Cover D=DomestopCapped E=External Thread F=FlattopCapped H=Flanged Flat M=Mag W=Wire Wheel S=Standard

FINISHES
b = black
c = chrome
g = grey
s = stainless
z = zinc

PONTIAC (Cont'd)

G3 (10-09), G5 (10-07), G6 (10-05), Montana SV6 (10-05), Pursuit (06-05), Solstice (09-06), Torrent (09-06)

2010-05	w/ steel wheels	561-110	562-310	561-110	562-310	559-163	(1) (23) (24) (50)
---------	-----------------	---------	---------	---------	---------	---------	-----------------------

Grand Am

2005-99	w/ aluminum wheels	561-110	562-310	561-110	562-310	559-190	(24) (29)
2005-99	w/ steel wheels	561-110	562-310	561-110	562-310	559-191	(31)
1998-96		561-110	562-310	561-110	562-310	559-190	(20) (24) (29)
1995-94		561-110	562-310	561-110	562-310	559-163	(20) (23) (24) (29)
1993-92	w/ aluminum wheels	561-110	562-310	561-110	562-310	559-190	(24) (29)
1993-85	w/ steel wheels	561-110	562-310	561-110	562-310	559-150	(20) (26)
1980-73		560-386	562-126	560-114	562-114	558-014	(1)

Grand LeMans

1981-75		560-386	562-126	560-114	562-114	558-014	(1)
---------	--	---------	---------	---------	---------	---------	-----

Grand Prix

2008-91		561-110	562-310	561-110	562-310	559-191	(23) (29)
2008-91	For replacement w/o front hub removal	561-115	-	561-110	562-310	559-191	(23) (29)
1990-88	For replacement w/o front hub removal	561-115	-	561-110	562-310	559-150	(11) (23)
1990-82		561-110	562-310	561-110	562-310	559-150	(21) (24)
1981-73		560-386	562-126	560-114	562-126	558-014	(1)

GTO

2006-04		N/A	-	N/A	-	559-070	
---------	--	-----	---	-----	---	---------	--

J2000

1985-82		561-110	562-310	561-110	562-310	559-150	(11) (12) (23)
---------	--	---------	---------	---------	---------	---------	-------------------

LeMans

1993-88		561-367	-	561-367	-	N/R	
1981-73		560-386	562-126	560-114	562-114	558-014	(1)

Montana

2004-99	(excludes 2002)	561-110	562-310	561-110	562-310	559-191	(23) (29) (50)
---------	-----------------	---------	---------	---------	---------	---------	-------------------

Parisienne

1986-83	w/ 11" rear drums	560-155	562-155	560-138	562-138	558-016	
1986-83	w/ 9.5" rear drums	560-386	562-126	560-114	562-114	558-014	(1)

Phoenix

1984-80		561-110	562-310	561-110	562-310	559-150	(11) (12) (13) (23)
1979-77		560-386	562-126	560-114	562-114	558-014	(1)

Safari

1989-87		560-155	562-155	560-138	562-138	558-016	
---------	--	---------	---------	---------	---------	---------	--

N/R – Not Required • N/A – Dealer Part

* (1) 558-070 Ds	(11) 559-085 Wb	(12) 559-087 Ds	(13) 559-089 Fs	(20) 559-151 EHZ	(23) 559-190 Ds	(24) 559-191 Ez	(26) 559-201 Cs
(29) 559-209 Cb	(50) 559-220 Cb						

WHEEL BOLTS and NUTS – Passenger Car BOULONS et ÉCROUS DE ROUE – pour Automobile

Year Année	Application	FRONT/AVANT		REAR/ARRIERE		Wheel Nut Ecrous	*Optional Nut * Ecrou Facultatif
		Wheel Bolt Boulon	Wheel Parts Kit Trousse	Wheel Bolt Boulon	Wheel Parts Kit Trousse		

*OPTIONAL NUTS / ECROUS FACULTATIF

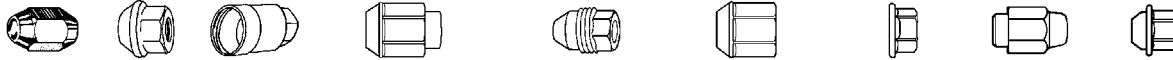

A=Acorn B=Bulge C=Cover D=DometopCapped E=External Thread F=FlattopCapped H=Flanged Flat M=Mag W=Wire Wheel S=Standard

FINISHES
b = black
c = chrome
g = grey
s = stainless
z = zinc

PONTIAC (Cont'd)

Sunbird, Sunfire (05-95)

2005-00		561-110	562-310	561-110	562-310	559-191	(23) (50)
1999-92		561-110	562-310	561-110	562-310	559-163	(20) (23) (24) (29)
1991-85		561-110	562-310	561-110	562-310	559-150	(11) (12) (23) (29)
1980-76		560-386	562-126	560-114	562-114	558-014	(1)

T1000

1987-81		561-108	562-208	561-139	562-339	559-190	(12)
---------	--	---------	---------	---------	---------	---------	------

Trans Sport

1998-92		561-110	562-310	561-110	562-310	559-191	(29)
1991-90		561-110	562-310	561-110	562-310	559-150	(24) (29)

Vibe

2010-03		561-126	562-226	561-126	562-226	559-070	
---------	--	---------	---------	---------	---------	---------	--

PORSCHE

924

1983-77	all	561-133	-	561-133	-	N/R	
---------	-----	---------	---	---------	---	-----	--

Boxster (10-97), Cayenne (10-03), Cayman (09-06), 911 (09-94), 928, 968

2010-94		N/A	-	N/A	-	N/R	
---------	--	-----	---	-----	---	-----	--

RENAULT

Alliance, Encore

1987-83		561-114	562-214	561-140	562-240	559-087	
---------	--	---------	---------	---------	---------	---------	--

SAAB

9-3, 9-3X, 9-5, 9-5X

2011-99		561-367	-	561-367	-	N/R	
---------	--	---------	---	---------	---	-----	--

9-7X

2009-05		561-110	562-310	561-110	562-310		(23)
---------	--	---------	---------	---------	---------	--	------

900

1998-94		561-367	-	561-367	-	N/R	
1993-88		N/A	-	N/A	-	N/R	
1987-79		560-172	562-272	560-172	562-272	558-027	

9000

1998-86		N/A	-	N/A	-	N/R	
---------	--	-----	---	-----	---	-----	--

99 (80-71), Sonett (74-71)

1980-71		560-172	562-272	560-172	562-272	558-027	
---------	--	---------	---------	---------	---------	---------	--

SATURN

Astra (09-08), Aura (09-07), Relay (07-05)

2009-05		561-110	562-310	561-110	562-310	559-163	(1) (23) (24) (50)
---------	--	---------	---------	---------	---------	---------	-----------------------

N/R – Not Required • N/A – Dealer Part

* (1) 558-070 Ds	(11) 559-085 Wb	(12) 559-087 Ds	(20) 559-151 EHz	(23) 559-190 Ds	(24) 559-191 Ez	(29) 559-209 Cb	(50) 559-200 Cb
------------------	-----------------	-----------------	------------------	-----------------	-----------------	-----------------	-----------------

WHEEL BOLTS and NUTS – Passenger Car BOULONS et ÉCROUS DE ROUE – pour Automobile

Year Année	Application	FRONT/AVANT		REAR/ARRIERE		Wheel Nut Ecrous	*Optional Nut * Ecrou Facultatif
		Wheel Bolt Boulon	Wheel Parts Kit Trousse	Wheel Bolt Boulon	Wheel Parts Kit Trousse		

*OPTIONAL NUTS / ECROUS FACULTATIF

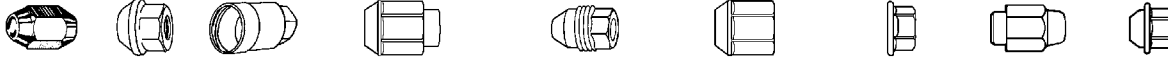

A=Acorn B=Bulge C=Cover D=DomestopCapped E=External Thread F=FlattopCapped H=Flanged Flat M=Mag W=Wire Wheel S=Standard

FINISHES
b = black
c = chrome
g = grey
s = stainless
z = zinc

SATURN (Cont'd)

Ion (07-02), Vue (10-02), Sky (10-07)

2010-02		561-110	562-310	561-110	562-310	559-192	(23)
2007-03	OEM w/ clipped head bolt front	561-492	-	561-110	-	569-192	

L, SC, SL, SW Series (04-91)

2004-91		561-110	562-310	561-110	562-310	559-191	
---------	--	---------	---------	---------	---------	---------	--

Outlook

2010-07		561-434	-	561-434	-	559-236	
---------	--	---------	---	---------	---	---------	--

SCION

FR-S (15-13), IQ (15-12), TC (15-05), XB (15-04), XD (13-07), XA (06-04)

2015-04		561-126	562-226	561-126	562-226	559-172	
---------	--	---------	---------	---------	---------	---------	--

SMART

Fortwo

2014-05		N/A	-	N/A	-	N/A	
---------	--	-----	---	-----	---	-----	--

STERLING

825 (88-87), 827 (91-89)

1991-87		561-110	562-310	561-110	562-310	559-150	
---------	--	---------	---------	---------	---------	---------	--

SUBARU

B9 Tribeca (07-06), Tribeca (10-08)

2014-06		561-401	-	561-401	-	559-125	
---------	--	---------	---	---------	---	---------	--

BRZ (15-13), Baja (06-03), Forester (15-98), Impreza (12-95), Outback (15-93), Legacy, Legacy Outback (15-95), Outback (15-00), SVX (97-92), WRX (15-13), WRX-STI (15-13), XV Crosstrek (15-13)

2015-90		561-401	-	561-401	-	559-125	
---------	--	---------	---	---------	---	---------	--

Brat (87-78), Deluxe, DL, FE, GF, GL, GL-10, RX, Standard, Star (89-72)

1989-72		561-322	562-422	561-322	562-422	559-078	
---------	--	---------	---------	---------	---------	---------	--

GLF (82-80), Justy (94-87), Loyale (94-90), XT (91-85)

1994-80		561-322	562-422	561-322	562-422	559-125	(10)
---------	--	---------	---------	---------	---------	---------	------

SUZUKI

Aerio, Aerio SX (07-02), Esteem (02-95), Grand Vitara (13-99), Kizashi (13-10), Samurai (95-89), Sidekick (98-89), SX4 (13-08)

2013-95	Exc: Samurai (95), Sidekick (95)	561-175	562-275	561-175	562-275	559-065	(10)
1995-89	Samurai (95-89), Sidekick (95-89)	561-175	562-275	561-174	562-274	559-065	(10)

Swift

2001-95	w/ ABS	561-175	562-275	561-175	562-275	559-065	
2001-95	w/o ABS	561-175	562-275	561-174	562-274	559-065	
1994-89	w/ rear discs + rear drums, 4-door	561-175	562-275	561-175	562-275	559-065	
1994-89	w/ rear drums 3-door	561-175	562-275	561-174	562-274	559-065	

Vitara (06-99), X-90 (98-96), XL-7 (06-02)

2006-96		561-175	562-275	561-175	562-275	559-065	(10)
---------	--	---------	---------	---------	---------	---------	------

N/A – Dealer Part

*	(10) 559-078 Ac	(23) 559-190 Ds					
---	-----------------	-----------------	--	--	--	--	--

WHEEL BOLTS and NUTS – Passenger Car BOULONS et ÉCROUS DE ROUE – pour Automobile

Year Année	Application	FRONT/AVANT		REAR/ARRIERE		Wheel Nut Ecrous	*Optional Nut * Ecrou Facultatif
		Wheel Bolt Boulon	Wheel Parts Kit Trousse	Wheel Bolt Boulon	Wheel Parts Kit Trousse		

*OPTIONAL NUTS / ECROUS FACULTATIF

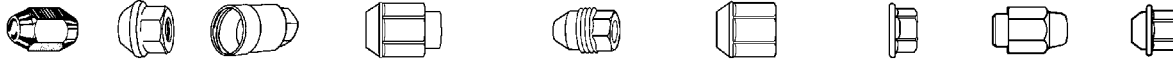

A= Acorn B= Bulge C= Cover D= DometopCapped E= External Thread F= FlattopCapped H= Flanged Flat M= Mag W= Wire Wheel S= Standard

FINISHES
b = black
c = chrome
g = grey
s = stainless
z = zinc

TOYOTA

Toyota Truck (See Light Truck Pg. 53)

Avalon (15-95), Camry (12-83), Camry Solara (08-99), Echo (05-00), Previa (97-91), Sienna (15-98)

2015-89	w/ 36mm front or rear bolt	561-122	562-322	561-122	562-322	559-172	(16) (65)
2015-89	w/ 41mm front or rear bolt	561-126	562-226	561-126	562-226	559-172	(65)

Celica

2005-00		561-126	562-226	561-122	562-322	559-070	(16)
1999-94	w/ 36mm rear bolt	561-126	562-226	561-122	562-322	559-070	
1999-94	w/ 41mm rear bolt	561-126	562-226	561-126	562-226	559-070	
1993-90		561-126	562-226	561-122	562-322	559-172	
1989-71		561-122	562-322	561-122	562-322	559-172	(16)

Corolla (15-68), Matrix (14-03)

2015-02	w/ 36mm front or rear bolt	561-122	562-322	561-122	562-322	559-172	(16) (65)
2015-02	w/ 41mm front or rear bolt	561-126	562-226	561-126	562-226	559-172	(65)
2001-91	from 5/1/91	561-126	562-226	561-122	562-322	559-172	(16)
1991-68	to 4/30/91	561-122	562-322	561-122	562-322	559-172	(16)

Cressida

1992-89		561-126	562-226	561-122	562-322	N/A	
1988-78		561-122	562-322	561-122	562-322	559-172	

FJ

2008-07		561-126	562-226	561-126	562-226	559-172	(16)
---------	--	---------	---------	---------	---------	---------	------

MR2, MR2-Spyder (05-00)

2005-85		561-126	562-226	561-126	562-226	559-172	(16)
---------	--	---------	---------	---------	---------	---------	------

Paseo (99-92), Starlet (84-81)

1998-81		561-122	562-322	561-122	563-322	559-172	(16)
---------	--	---------	---------	---------	---------	---------	------

Prius, Prius C, Prius V

2015-01		561-126	562-226	561-122	562-322	559-117	
---------	--	---------	---------	---------	---------	---------	--

Supra

1998-87		561-126	562-226	561-126	562-226	N/A	
1986-79		561-122	562-322	561-122	562-322	559-172	

Tercel

1999-83		561-122	562-322	561-122	562-322	559-172	(16)
1982-80		561-122	562-322	561-122	562-322	559-070	

Van

1989-84		561-122	562-322	561-122	562-322	559-070	
---------	--	---------	---------	---------	---------	---------	--

Venza

2015-09	w/ 36mm front or rear bolt	561-122	562-322	561-122	562-322	559-117	
2015-09	w/ 41mm front or rear bolt	561-126	562-226	561-126	562-226	559-117	

Yaris

2015-07	w/ 36mm front or rear bolt	561-122	562-322	561-122	562-322	559-163	(1) (17)
2015-07	w/ 41mm front or rear bolt	561-126	562-226	561-126	562-226	559-163	

N/A – Dealer Part

* (1) 558-070 Ds	(16) 559-117 DHc	(17) 559-137 AHc	(65) 559-167 Mc			
------------------	------------------	------------------	-----------------	--	--	--

WHEEL BOLTS and NUTS – Passenger Car BOULONS et ÉCROUS DE ROUE – pour Automobile

Year Année	Application	FRONT/AVANT		REAR/ARRIERE		Wheel Nut Ecrous	*Optional Nut * Ecrou Facultatif
		Wheel Bolt Boulon	Wheel Parts Kit Trousse	Wheel Bolt Boulon	Wheel Parts Kit Trousse		

*OPTIONAL NUTS / ECROUS FACULTATIF

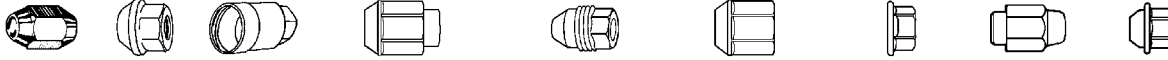

A=Acorn B=Bulge C=Cover D=DometopCapped E=External Thread F=FlattopCapped H=Flanged Flat M=Mag W=Wire Wheel S=Standard

FINISHES
b = black
c = chrome
g = grey
s = stainless
z = zinc

VOLKSWAGEN

Beetle, Type 1, CC (15-09), EOS (15-07), GTI (15-06), Tiguan (15-09), Routan (11-09)

2015-98		561-133	-	561-133	-	N/R	
---------	--	---------	---	---------	---	-----	--

Cabrio (02-95), Cabriolet (93-85)

2002-85		561-132	-	561-132	-	N/R	
---------	--	---------	---	---------	---	-----	--

Corrado

1994-92	Inc: (92) 5 bolt	561-133	-	561-133	-	N/R	
1992-90	Inc: (92) 4 bolt	561-132	-	561-132	-	N/R	

Fox (93-87), Quantum (88-82)

1993-82		561-133	-	561-133	-	N/R	
---------	--	---------	---	---------	---	-----	--

Golf, Golf GTI (05-85), Jetta (15-80)

2015-93	Inc: (99-93) 5 bolt	561-133	-	561-133	-	N/R	
1999-85	Inc: (99-93) 4 bolt	561-132	-	561-132	-	N/R	
1984-80	Jetta w/ aluminum wheels	561-132	-	561-132	-	N/R	
1984-80	Jetta w/ steel wheels	561-130	-	561-130	-	N/R	

Passat

2015-90	Inc: (97-90) 5 bolt	561-133	-	561-133	-	N/R	
1997-90	4 bolt	561-132	-	561-132	-	N/R	

Phaeton

2006-04	Alloy Wheels	561-467	-	561-467	-	N/R	
---------	--------------	---------	---	---------	---	-----	--

Rabbit (09-06), Rabbit (84-75), Scirocco (88-75)

2009-06		561-133	-	561-133	-	N/R	
1988-75	w/ aluminum wheels	561-132	-	561-132	-	N/R	
1988-75	w/ steel wheels	561-130	-	561-130	-	N/R	

Touareg

2015-04		N/A	-	N/A	-	N/R	
---------	--	-----	---	-----	---	-----	--

N/R – Not Required • N/A – Dealer Part

papco® TORQUE GUIDE

It is recommended that Wheel Nuts be torqued to specifications with a reliable torque wrench to prevent damage and distortion to wheels, discs and drums. Hub face, wheel face and ball seat should be free of dirt or excess paint.

A good practice to follow is an alternating or crisscross tightening sequence that equalizes bolt pressure around the wheel. On dual wheels (truck) inner wheel should be tighter than outer. Back off outer nut before tightening inner.

Another procedure is to tighten each nut to half its specified torque and then repeat, bringing each nut up to its full torque. Recheck all nuts after first trip to take up any slack.

GUIDE DYNAMOMÉTRIQUE

Il est recommandé de serrer les écrous de roue en suivant bien les spécifications et en utilisant une bonne clef dynamométrique afin d'éliminer tout risque de dommage et de convulsion aux roues, rondelles et tambours. La face du moyeu et de la roue ainsi que les balles du siège doivent être propres et débarrassés de tout excès de peinture.

Un bon moyen d'installation est de suivre un alternation ou de serrer tranquillement l'écrou pour égaliser la pression avec la roue. Pour des roues jumelées (camion) la roue intérieure doit être plus serrée que la roue extérieure.

Une autre procédure est de serrer chaque écrou juste la moitié de ce qu'elle doit être et répéter pour ensuite serrer chaque écrou complètement et revérifier chaque écrou après le premier voyage pour éviter que les écrous se démanchent.

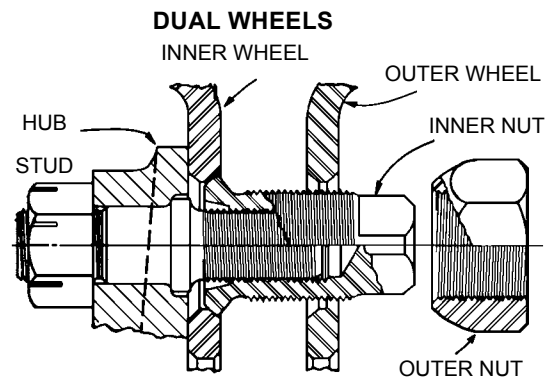
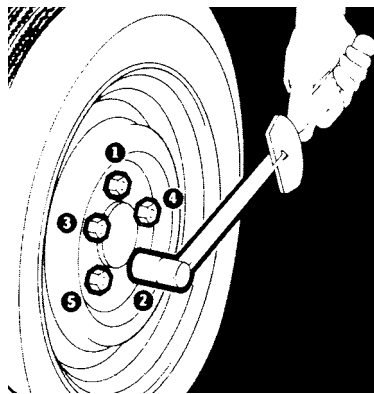

Application	Stud Size	Torque Ft. Pounds
Passenger Cars and Light Trucks	7/16-20-M10	75-85
	1/2-20-M12	75-85
	9/16-18-M14	80-90
Highway Vehicles Budd Std. Mtg., steel Back Nuts, inner end	5/8-18	175-200
	3/4-16	450-500
	3/4-16	175-200

WHEEL BOLTS and NUTS – Light Truck BOULONS et ÉCROUS DE ROUE – Camion Léger

Year Année	Application	FRONT/AVANT		REAR/ARRIERE		Wheel Nut Ecrous	*Optional Nut * Ecrou Facultatif
		Wheel Bolt Boulon	Wheel Parts Kit Trousse	Wheel Bolt Boulon	Wheel Parts Kit Trousse		

*OPTIONAL NUTS / ECROUS FACULTATIF

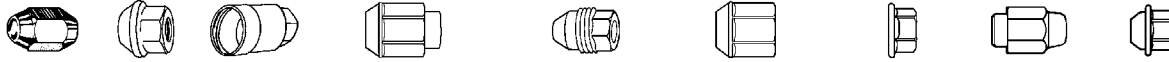

A= Acorn B= Bulge C= Cover D= DometopCapped E= External Thread F= FlattopCapped H= Flanged Flat M= Mag W= Wire Wheel S= Standard

FINISHES
b = black
c = chrome
g = grey
s = stainless
z = zinc

AM GENERAL

Hummer H1							
1999-92		560-376	-	560-376	-	N/A	
Hummer H2							
2008-05		561-428	-	561-428	-	559-154	(55)
Hummer H3, H3T (10-09)							
2010-06		561-110	562-310	561-110	562-310	559-163	(1)

CHEVROLET/GMC TRUCK

Acadia							
2016-07		561-434	-	561-434	-	559-154	(49)
Astro, Safari Van							
2005-03	w/ aluminum wheels or without	N/A	-	561-434	-	559-193	(38)
2002-90	4WD	560-034	562-171	560-138	562-138	558-016	(6) (30) (40) (41)
2002-85	Inc: (02-90) 2WD	560-155	562-155	560-138	562-138	558-016	(6) (30) (40) (41)
Avalanche (13-07), Avalanche 1500 (06-02)							
2013-01		561-428	-	561-434	-	559-154	(32) (38) (49)
Avalanche 2500 (06-02)							
2006-02	w/ 65mm rear studs	561-428	-	561-428	-	559-154	(32) (38)
2006-02	w/ 80mm rear studs	561-428	-	561-431	-	559-154	(32) (38)
2006-02	w/ 104mm rear studs	561-428	-	561-436	-	559-154	(32) (38)
Blazer							
1994	Diesel Eng.	561-417	-	561-413	-	559-154	(32) (33)
1994	2WD Gas Engine	561-415	-	561-413	-	559-154	(32) (33)
1994-92	Inc: (94) 4WD Gas Eng.	561-413	-	561-413	-	559-154	(32) (33)
1991-71	Inc: (86-71) 4WD	560-604	562-204	560-114	562-114	558-014	(1)
1986-71	2WD	560-155	562-155	560-138	562-138	558-016	
C, R 10/15/1500 Pickup/Suburban (1/2 ton 2WD)							
1999-96	w/ 11.5" rear drums	561-415	-	561-414	-	559-154	(32) (33)
1999-96	w/ 13" rear drums	561-415	-	561-410	-	559-154	(32) (33)
1995-92	w/ 11.86" front rotor JB/JD5 brake	561-415	-	561-413	-	559-154	(32) (33)
1995-92	w/ 12.5" front rotor JB/JD6-7 brake	561-415	-	561-410	-	559-154	(32) (33)
1991-88	Pickup w/ 10" rear drums	561-415	-	561-413	-	559-154	(32) (33)
1991-88	Pickup w/ 11.15" rear drums	561-415	-	561-410	-	559-154	(32) (33)
1991-71	Inc: (91-88) Suburban	560-155	562-155	560-138	562-138	558-016	(2)
1970-67		560-114	562-114	560-114	562-114	558-014	

N/A – Dealer Part

*(1) 558-070 Ds	(2) 558-071 Ds	(6) 558-162 Bz	(30) 559-210 Cg	(32) 559-193 Ez	(33) 559-206 Cg	(38) 559-212 Cb	(40) 558-123 Db
(41) 558-160 Ez	(49) 559-236 Fc	(55) 559-112 D					

WHEEL BOLTS and NUTS – Light Truck BOULONS et ÉCROUS DE ROUE – Camion Léger

Year Année	Application	FRONT/AVANT		REAR/ARRIERE		Wheel Nut Ecrous	*Optional Nut * Ecrou Facultatif
		Wheel Bolt Boulon	Wheel Parts Kit Trousse	Wheel Bolt Boulon	Wheel Parts Kit Trousse		

*OPTIONAL NUTS / ECROUS FACULTATIF

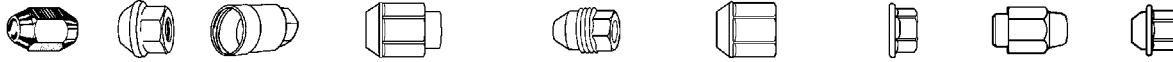

A= Acorn B= Bulge C= Cover D= DometopCapped E= External Thread F= FlattopCapped H= Flanged Flat M= Mag W= Wire Wheel S= Standard

FINISHES
b= black
c= chrome
g= grey
s= stainless
z= zinc

CHEVROLET/GMC TRUCK (Cont'd)

C, R20/25/2500 Pickup/Suburban (3/4 ton 2WD)

2000-90	Pickup 8600lb. GVW	561-415	-	561-411	-	559-193	(33)
2000-89	Pickup, 7200lb., GVW, C2500	561-415	-	561-410	-	559-193	(33)
1991-88	Suburban, R20/25 w/ 10.5" ring gear	560-376	-	560-460	-	558-100	
1991-88	Suburban, R20/25 w/ 9.5" ring gear	560-376	-	560-376	-	558-100	
1989-88	Pickup C2500 7200lb., 8600lb. GVW	561-415	-	561-410	-	559-154	
1987-74	all	560-376	-	560-376	-	558-100	

C, R30/35/3500 Pickup (1 Ton 2WD)

2002-88	SRW Exc: (89-88) R30/35/3500	561-415	-	561-411	-	559-193	(33) (35)
2001-96	DRW w/ rear drums	561-410	-	561-418	-	559-194	(33)
1995-94	DRW w/ rear drums limited slip rear	561-410	-	561-418	-	559-194	(33)
1995-94	DRW w/ rear drums w/o limited slip rear	561-410	-	561-461	-	559-194	(33)
1994-91	DRW w/ rear discs, 5/8 front bolt	N/A	-	560-183	-	558-055	
1993-92	DRW w/ rear drums	561-410	-	561-418	-	559-194	(33)
1991	C3500, DRW rear drums w/ 14mm front bolt	561-410	-	561-418	-	559-194	(33) (35)
1991	C3500, DRW rear drums w/ 5/8 front bolt	N/A	-	561-418	-	559-194	
1991-90	R3500 DRW	560-459	-	560-461	-	558-047	
1990-88	C3500 DRW	561-410	-	561-418	-	N/A	(34)
1990-88	C3500 DRW	560-410	-	560-418	-	558-047	(34) (33)
1989-88	R30/35/3500 SRW	560-376	-	560-460	-	558-100	
1989-75	R30/35/3500 DRW, (87-85) DRW	560-459	-	560-461	-	558-047	
1987-75	DRW	560-459	-	560-461	-	558-047	
1987-74	SRW	560-376	-	560-460	-	558-100	

Caballero

1987-82		561-110	562-310	561-110	562-310	559-150	(11) (13)
1981-78		560-386	562-126	560-114	562-114	558-014	(1)

Canyon (2015, 12-09), Colorado (2015, 12-04)

2015		-	N/A	-	N/A	559-236	
2012-04		561-110	562-310	561-110	562-310	559-191	(50)

Equinox (15-05), Envoy (09-02)

2015-10		561-434	-	561-434	-	559-193	
2008-05		561-110	562-310	561-110	562-310	559-191	(23) (36)

Express 1500

2015-03		561-428	-	561-434	-	559-154	(32) (38)
2002-96		561-415	-	561-413	-	559-154	(32) (33)

Express 2500

2015-03	w/ 65mm rear studs	561-428	-	561-428	-	559-193	
2015-03	w/ 80mm rear studs	561-428	-	561-431	-	559-193	
2002-96	w/ 11.5" rear drums	561-415	-	561-411	-	559-193	(33)
2002-96	w/ 13" rear drums	561-415	-	561-410	-	559-193	(33)

N/A – Dealer Part

* (1) 558-070 Ds	(11) 559-085 Wb	(13) 559-089 Fs	(23) 559-190 Ds	(32) 559-193 Ez	(33) 559-206 Cg	(34) 559-194 Ez	(35) 559-205 Cb
(36) 559-163 Bz	(38) 559-212 Cb	(49) 559-236 Fc	(50) 559-220 Cb				

WHEEL BOLTS and NUTS – Light Truck BOULONS et ÉCROUS DE ROUE – Camion Léger

Year Année	Application	FRONT/AVANT		REAR/ARRIERE		Wheel Nut Ecrous	*Optional Nut * Ecrou Facultatif
		Wheel Bolt Boulon	Wheel Parts Kit Trousse	Wheel Bolt Boulon	Wheel Parts Kit Trousse		

*OPTIONAL NUTS / ECROUS FACULTATIF

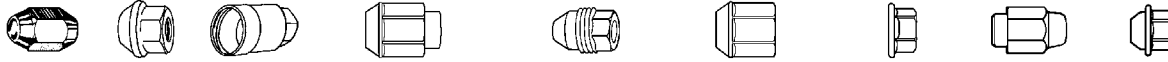

A=Acorn B=Bulge C=Cover D=DomestopCapped E=External Thread F=FlattopCapped H=Flanged Flat M=Mag W=Wire Wheel S=Standard

FINISHES
b = black
c = chrome
g = grey
s = stainless
z = zinc

CHEVROLET/GMC TRUCK (Cont'd)

Express 3500

2015-03	w/ 80mm rear studs	561-428	-	561-431	-	559-302	(33)
2015-03	w/ 104mm rear studs	561-428	-	561-436	-	559-302	(33)
2002-96	SRW	561-415	-	561-411	-	559-193	(33)
2002-96	DRW	561-410	-	561-418	-	559-194	(33)

G10/15 Van

1995-75		560-155	562-155	560-138	562-138	558-016	
---------	--	---------	---------	---------	---------	---------	--

G20/25 Van

1995-72		560-155	562-155	560-138	562-138	558-016	(6)
---------	--	---------	---------	---------	---------	---------	-----

G30/35 Van

1996-85	w/ 13x2½ rear drumJB/JD7 brake	560-376	-	560-376	-	558-100	
1996-85	w/ 13x3½ rear drumJB8 brake DRW	560-459	-	560-461	-	558-047	
1996-85	w/ 13x3½ rear drumJB/8 brake SRW	560-459	-	560-460	-	558-100	
1984-75	SRW	560-376	-	560-376	-	558-100	
1984-75	DRW	560-459	-	560-461	-	558-047	

Jimmy

1991-87		560-604	562-204	560-114	562-114	558-014	(1)
1986-71	2WD	560-155	562-155	560-138	562-138	558-016	
1986-71	4WD	560-604	562-204	560-114	562-114	558-014	(1)

K, V10/15/1500 Pickup/Suburban ½ Ton 4WD

1999-92	Pickup w/ 11.86" front rotor JB/JD5 brake	561-413	-	561-413	-	559-154	(32) (33)
1999-92	Pickup w/ 12.5" front rotor JB/JD6-7 brake	561-413	-	561-410	-	559-154	(32) (33)
1999-92	Suburban Gas engine w/ 11.15" rear drum	561-413	-	561-413	-	559-154	(32) (33)
1999-92	Suburban Gas engine w/ 13" rear drum	561-413	-	561-410	-	559-154	(32) (33)
1999-92	Suburban Diesel engine	561-417	-	561-410	-	559-154	(32) (33)
1991-88	Pickup w/ 10" rear drum	561-413	-	561-413	-	559-193	(33) (35)
1991-88	Pickup w/ 11.15" rear drum	561-413	-	561-410	-	559-193	(33) (35)
1991-88	Suburban	560-604	562-204	560-114	562-114	558-014	(1)
1987	all	560-604	562-204	560-114	562-114	558-014	(1)

K, V20/25/2500 Pickup/Suburban (¾ Ton 4WD)

2000-92	w/ 11.5 and 13" rear drums, 7200lb GVW	561-413	-	561-410	-	559-193	(33)
2000-92	w/ 13" rear drum, 8600lb GVW	561-417	-	561-411	-	559-193	(33)
1991-90	Pickup w/ 13" rear drum	561-417	-	561-410	-	559-193	(35)
1991-88	(91-90) Pickup w/ 11.15" rear drum, (89-88) Pickup	561-417	-	561-410	-	559-193	(35)
1991-88	Suburban w/ 10.5" ring gear	560-280	-	560-460	-	558-100	
1991-88	Suburban w/ 9.5" ring gear	560-280	-	560-376	-	558-100	
1987-81	w/ 11.15" rear drums (81) 2" bolt	560-280	-	560-376	-	558-100	
1987-81	w/ 13" rear drum, 9.5" ring gear	560-280	-	560-376	-	558-100	
1987-74	w/ 13" rear drum, 10.5" ring gear	560-280	-	560-460	-	558-100	
1980-74	w/ 13" rear drum	560-280	-	560-460	-	558-100	

* (1) 558-070 Ds (6) 558-162 Bz (32) 559-193 Ez (33) 559-206 Cg (35) 559-205 Cb

WHEEL BOLTS and NUTS – Light Truck BOULONS et ÉCROUS DE ROUE – Camion Léger

Year Année	Application	FRONT/AVANT		REAR/ARRIERE		Wheel Nut Ecrous	*Optional Nut * Ecrou Facultatif
		Wheel Bolt Boulon	Wheel Parts Kit Trousse	Wheel Bolt Boulon	Wheel Parts Kit Trousse		

*OPTIONAL NUTS / ECROUS FACULTATIF

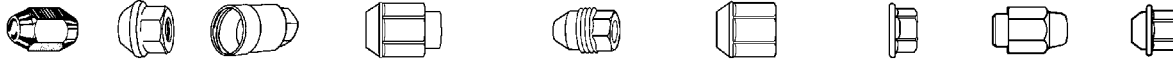

A= Acorn B= Bulge C= Cover D= DometopCapped E= External Thread F= FlattopCapped H= Flanged Flat M= Mag W= Wire Wheel S= Standard

FINISHES
b = black
c = chrome
g = grey
s = stainless
z = zinc

CHEVROLET/GMC TRUCK (Cont'd)

K, V30/35/3500 Pickup (1 Ton, 4WD)

2000-92	DRW	561-417	-	561-418	-	559-194	(33)
1991	K3500 DRW w/ rear discs	561-417	-	560-183	-	558-055	
1991-89	V3500	560-469	-	560-460	-	558-100	
1991-88	K3500 DRW w/ rear drums	561-417	-	561-418	-	559-194	(33) (35)
1991-88	K3500 SRW	561-417	-	561-411	-	559-193	(33)
1988	V30/35 DRW	560-468	-	560-461	-	558-047	
1988	V30/35 SRW	560-469	-	560-460	-	558-100	
1987-79	DRW	560-468	-	560-461	-	558-047	
1987-77	SRW	560-469	-	560-460	-	558-100	

LLV Postal Vehicle

1995-87		561-110	562-310	561-110	562-310	559-150	
---------	--	---------	---------	---------	---------	---------	--

P20/25 Forward Control ¾ Ton Chassis

1989-81		560-376	-	560-376	-	558-100	
1980-71	w/ 11.15" rear drum	560-376	-	N/A	-	558-100	
1980-71	w/ 13" rear drum	560-376	-	560-189	-	558-100	

P30/35 Forward Control 1 Ton Chassis

1999-95	SRW	560-376	-	560-460	-	558-100	
1999-75	DRW w/ rear drums	560-459	-	560-461	-	558-047	
1994-91	SRW	560-459	-	560-460	-	558-100	
1990-75		560-376	-	560-460	-	558-100	

S10/15 Blazer (04-82), TrailBlazer, Jimmy, Pickup, Sonoma (04-91), Cyclone, Typhoon, Venture Van (05-97)

2009-02		561-110	562-310	561-110	562-310	559-163	(23) (24)
2002-89		561-110	562-310	561-110	562-310	559-150	(23) (24) (29)
1988-82		561-110	562-310	561-110	562-310	559-077	(23) (24) (29)

Savana 1500, Sonoma (04-03), S10 Blazer (04-03)

2015-03		561-428	-	561-434	-	559-154	(32) (33) (38) (49)
2002-96		561-415	-	561-414	-	559-154	(32) (33)

Savana 2500

2015-03	w/ 65mm rear studs	561-428	-	561-428	-	559-193	(33)
2015-03	w/ 80mm rear studs	561-428	-	561-431	-	559-193	(33)
2002-96	w/ 11.15" rear drum	561-415	-	561-414	-	559-193	(33)
2002-96	w/ 13" rear drum	561-415	-	561-410	-	559-193	(33)

Savana 3500

2015-03	w/ 80mm rear studs	561-428	-	561-431	-	559-302	(33)
2012-03	w/ 104mm rear studs	561-428	-	561-436	-	559-302	(33)
2002-96	DRW	561-410	-	561-418	-	559-194	(33)
2002-96	SRW	561-415	-	561-411	-	559-193	(33)

N/A – Dealer Part

* (23) 559-190 Ds	(24) 559-191 Ez	(29) 559-209 Cb	(32) 559-193 Ez	(33) 559-206 Cg	(35) 559-205 Cb	(38) 559-212 Cb	(49) 559-236 Fc
-------------------	-----------------	-----------------	-----------------	-----------------	-----------------	-----------------	-----------------

WHEEL BOLTS and NUTS – Light Truck BOULONS et ÉCROUS DE ROUE – Camion Léger

Year Année	Application	FRONT/AVANT		REAR/ARRIERE		Wheel Nut Ecrous	*Optional Nut * Ecrou Facultatif
		Wheel Bolt Boulon	Wheel Parts Kit Trousse	Wheel Bolt Boulon	Wheel Parts Kit Trousse		

***OPTIONAL NUTS / ECROUS FACULTATIF**

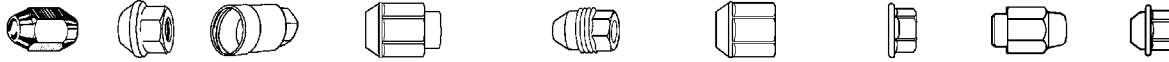

A= Acorn B= Bulge C= Cover D= DometopCapped E= External Thread F= FlattopCapped H= Flanged Flat M= Mag W= Wire Wheel S= Standard

FINISHES
b = black
c = chrome
g = grey
s = stainless
z = zinc

CHEVROLET/GMC TRUCK (Cont'd)

Sierra 1500/ Sierra 1500HD, Silverado 1500, Suburban 1500

2015-99	w/ 60mm rear studs	561-428	-	561-434	-	559-154	(32) (38) (49)
2015-99	w/ 80mm rear studs	561-428	-	561-431	-	559-154	(32) (38) (49)
2015-99	w/ 65mm rear studs	561-428	-	561-428	-	559-154	(32) (38) (49)

Sierra 2500/Sierra 2500HD, Silverado 2500/Silverado 2500HD, Suburban 2500

2015-99	w/ 65mm rear studs	561-428	-	561-428	-	559-154	(32) (38) (49)
2015-99	w/ 80mm rear studs	561-428	-	561-431	-	559-154	(32) (38) (49)
2015-99	w/ 104mm rear studs	561-428	-	561-436	-	559-154	(32) (38) (49)

Sierra 3500/Sierra 3500HD, Silverado 3500/Silverado 3500HD, Sierra C3 (01)

2015-01		561-428	-	561-428	-	559-302	(38) (49)
2015-01	w/ 80mm rear studs	561-428	-	561-431	-	559-302	(38) (49)
2015-01	w/ 104mm rear studs	561-428	-	561-436	-	559-302	(38) (49)

Sierra Denali

2015-02		561-428	-	561-434	-	559-154	(32) (38)
2015-02	w/ 80 mm rear studs	561-428	-	561-431	-	559-154	(32) (38)

Tahoe, Yukon (incl. Denali)

2015-01		561-428	-	561-434	-	559-154	(32) (38) (49)
2000		561-428	-	561-428	-	559-154	(32) (33)
1999-95	2WD Gas+Diesel Engine	561-415	-	561-413	-	559-154	(32) (33)
1999-95	4WD Diesel Engine	561-417	-	561-413	-	559-154	(32) (33)
1999-95	4WD Gas Engine	561-414	-	561-413	-	559-154	(32) (33)

Terrain (15-10), Traverse (15-09)

2015-09		561-434	-	561-434	-	559-154	(49)
---------	--	---------	---	---------	---	---------	------

Tracker

2004-98		561-175	562-275	561-175	562-275	559-064	
---------	--	---------	---------	---------	---------	---------	--

Yukon XL 1500 (incl. Denali XL)

2015-00		561-428	-	561-434	-	559-154	(32) (38) (49)
---------	--	---------	---	---------	---	---------	-------------------

Yukon XL 2500

2015-01	w/ 65mm rear studs	561-428	-	561-428	-	559-154	(32) (38)
2015-01	w/ 80mm rear studs	561-428	-	561-431	-	559-154	(32) (38)
2015-01	w/ 104mm rear studs	561-428	-	561-436	-	559-154	(32) (38)

* (32) 559-193 Ez (33) 559-206 Cg (38) 559-212 Cb (49) 559-236 Fc

WHEEL BOLTS and NUTS – Light Truck BOULONS et ÉCROUS DE ROUE – Camion Léger

Year Année	Application	FRONT/AVANT		REAR/ARRIERE		Wheel Nut Ecrous	*Optional Nut * Ecrou Facultatif
		Wheel Bolt Boulon	Wheel Parts Kit Trousse	Wheel Bolt Boulon	Wheel Parts Kit Trousse		

*OPTIONAL NUTS / ECROUS FACULTATIF

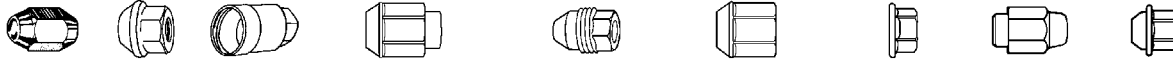

A=Acorn B=Bulge C=Cover D=DometopCapped E=External Thread F=FlattopCapped H=Flanged Flat M=Mag W=Wire Wheel S=Standard

FINISHES
b = black
c = chrome
g = grey
s = stainless
z = zinc

DODGE TRUCK

B100/150/1500 Van (1/2 Ton)

1998-78	Inc: (85-78) Budd rotor	560-102	562-172	560-103	562-173	558-027	(36) (60)
1985-75	Inc: (85-78) Kelsey Hayes rotor	560-148	562-248	560-103	562-173	558-027	

B200/250/2500 Van (3/4 Ton)

1998-90	w/ 8.25" ring gear	560-102	562-172	560-103	562-173	558-027	(36)
1998-90	w/ 9.25" ring gear	560-102	562-172	560-175	-	558-027	(36)
1989-78	Inc: (85-78) Budd rotor	560-102	562-172	560-103	562-173	558-027	
1985-78	Inc: (85-78) Kelsey Hayes rotor	560-148	562-248	560-103	562-173	558-027	

B300/350/3500 Van (1 Ton)

1998	Front	560-468	-	-	-	558-062	(60)
1998-97	Rear w/ 12"x2½" drum, Chrysler axle	-	-	560-175	-	558-016	
1998-97	Rear w/ 12"x3" drum, Dana 5500lb axle	-	-	N/A	-	558-055	
1998-97	Rear w/ 12"x3" drum, Dana 6200lb axle	-	-	N/A	-	558-055	
1997	Front	560-181	-	-	-	558-055	
1996-95	Front 1/2" Studs	560-286	-	-	-	558-016	(36)
1996-90	Front 5/8" Studs	560-181	-	-	-	558-055	
1996-86	Rear, Chrysler axle	-	-	560-175	-	558-016	
1996-86	Rear, Dana axle, 12"x2½" drum	-	-	560-470	-	558-016	
1996-86	Rear, Dana axle, 12"x3" drum	-	-	560-180	-	558-055	
1994-90	Front 1/2" Studs	560-148	562-248	-	-	558-016	
1994-90	Rear, Cutaway Cab, w/DRW	-	-	560-180	-	558-057	
1989-86	Front w/o 4000lb axle, 1/2" 5-Stud	560-148	562-248	-	-	558-027	
1989-86	Front w/o 4000lb axle, 5/8" Stud	560-286	-	-	-	558-016	
1989-86	Front w/ 4000lb axle, 5/8" Stud	N/A	-	-	-	558-055	
1989-86	Rear, Cutaway Cab, w/DRW	-	-	560-183	-	558-057	
1985-84	w/ 9000lb GVW	560-181	-	560-180	-	558-055	
1985-84	w/ 9000lb GVW	560-181	-	560-180	-	558-055	
1985-84	w/o 9000lb GVW	560-286	-	560-175	-	558-016	
1985-84	w/o 9000lb GVW	560-286	-	560-175	-	558-016	
1983	Rear, w/ 9000lb GVW	-	-	560-180	-	558-055	
1983-82	Rear, w/o 9000lb GVW	-	-	560-470	-	558-016	
1983-78	Front w/ 9000lb GVW, 1/2" Studs	560-286	-	-	-	558-016	
1983-78	Front w/ 9000lb GVW, 5/8" Studs	560-181	-	-	-	558-055	
1983-78	Front w/o 9000lb GVW w/ Budd rotor	560-102	562-172	-	-	558-016	
1983-78	Front w/o 9000lb GVW w/ Kelsey Hayes rotor	560-148	562-248	-	-	558-016	
1981-78	Rear w/ 12 1/8"x2" rear Budd drum	-	-	560-155	562-156	558-016	
1981-78	Rear w/ 12 1/8"x2" rear Motor Wheel drum	-	-	560-039	-	558-016	
1981-74	Rear w/ 12"x2½" rear drum	-	-	560-470	-	558-016	
1981-74	Rear w/ 12x3" rear drum	-	-	560-180	-	558-055	
1977-74	Front 3300lb axle	560-148	562-248	-	-	558-016	
1977-74	Front 3800lb axle	560-181	-	-	-	558-055	

N/A – Dealer Part

*	(36) 558-163 Bz	(60) 558-122 Ds					
---	-----------------	-----------------	--	--	--	--	--

WHEEL BOLTS and NUTS – Light Truck BOULONS et ÉCROUS DE ROUE – Camion Léger

Year Année	Application	FRONT/AVANT		REAR/ARRIERE		Wheel Nut Ecrous	*Optional Nut * Ecrou Facultatif
		Wheel Bolt Boulon	Wheel Parts Kit Trousse	Wheel Bolt Boulon	Wheel Parts Kit Trousse		

*OPTIONAL NUTS / ECROUS FACULTATIF

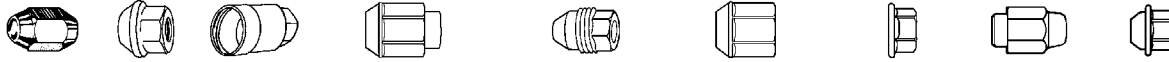

A= Acorn B= Bulge C= Cover D= DomestopCapped E= External Thread F= FlattopCapped H= Flanged Flat M= Mag W= Wire Wheel S= Standard

FINISHES
b = black
c = chrome
g = grey
s = stainless
z = zinc

DODGE TRUCK (Cont'd)

Caravan, Grand Caravan

2015-08	Steel wheels	561-445	-	561-445	-	559-181	(54)
2007-98		561-312	-	561-312	-	559-150	(9)
2005-97	Rear Front Disc/Rear Drums	561-370	-	561-312	562-412	559-150	(9)
2005-97	Rear 4 wheel discs	561-370	-	561-369	-	559-150	(9)
1997-84	Inc: 14" wheels	561-109	562-209	N/A	-	559-150	(9)
1996		561-370	-	561-312	562-412	559-150	(9)
1995-91	Rear All Wheel Drive	561-370	-	561-371	-	559-150	(9)
1995-91	Rear All Wheel Drive	561-370	-	561-108	562-208	559-150	(9)
1992-91	Inc: 15" wheels	561-370	-	N/A	-	559-150	(9)
1990-84		561-370	-	561-109	562-209	559-150	(9)

D100/150 Pickup (1/2 Ton 2WD)

1993-78	Inc: (85-78) Budd rotor	560-102	562-172	560-103	562-173	558-027	
1985-79	Kelsey Hayes rotor	560-148	562-248	560-103	562-173	558-027	

D200/250 Pickup (3/4 Ton 2WD)

1993-90	Front Diesel Engine	560-286	-	-	-	558-016	
1993-90	Front Gas Engine	560-148	562-248	-	-	558-016	
1993-86	Rear, Chrysler axle	-	-	560-175	-	558-016	
1993-86	Rear, Dana 5500lb axle	-	-	560-470	-	558-016	
1993-86	Rear, Dana 6200lb axle	-	-	560-348	-	558-016	
1989-86	Front 5-Stud	560-148	562-248	-	-	558-027	
1989-86	Front 8-Stud	560-286	-	-	-	558-016	
1985-84	w/ Chrysler rear axle	560-286	-	560-175	-	558-016	
1985-84	w/ Chrysler rear axle	560-286	-	560-175	-	558-016	
1985-84	w/ Dana rear axle	560-286	-	560-470	-	558-016	
1985-84	w/ Dana rear axle	560-286	-	560-470	-	558-016	
1983-82	w/ 4000lb Front axle	560-286	-	560-470	-	558-016	
1983-82	w/o 4000lb Front axle, Budd rotor	560-102	562-172	560-470	-	558-016	
1983-82	w/o 4000lb, Front axle, Kelsey Hayes rotor	560-148	562-248	560-470	-	558-016	
1981-79	Front w/ 4000lb axle	560-286	-	-	-	558-016	
1981-78	Front w/o 4000lb axle, Budd rotor	560-102	562-172	-	-	558-016	
1981-78	Front w/o 4000lb axle, Kelsey Hayes rotor	560-148	562-248	-	-	558-016	
1981-78	Rear 12"x2 1/2" drum	-	-	560-470	-	558-016	
1981-78	Rear 12 1/8" x 2" Budd drum	-	-	560-155	562-155	558-016	
1981-78	Rear 12 1/8" x 2" Motor Wheel drum	-	-	560-039	-	558-016	
1978	Front w/ 4000lb axle	560-181	-	-	-	558-055	

N/A – Dealer Part

*	(9) 559-074 Ds	(54) 559-150 Sz				
---	----------------	-----------------	--	--	--	--

WHEEL BOLTS and NUTS – Light Truck BOULONS et ÉCROUS DE ROUE – Camion Léger

Year Année	Application	FRONT/AVANT		REAR/ARRIERE		Wheel Nut Ecrous	*Optional Nut * Ecrou Facultatif
		Wheel Bolt Boulon	Wheel Parts Kit Trousse	Wheel Bolt Boulon	Wheel Parts Kit Trousse		

*OPTIONAL NUTS / ECROUS FACULTATIF

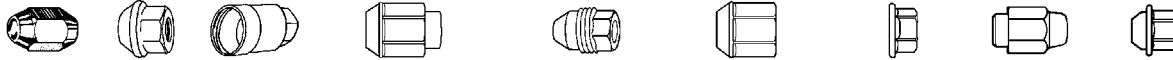

A= Acorn B= Bulge C= Cover D= DometopCapped E= External Thread F= FlattopCapped H= Flanged Flat M= Mag W= Wire Wheel S= Standard

FINISHES
b = black
c = chrome
g = grey
s = stainless
z = zinc

DODGE TRUCK (Cont'd)

D300/350 Pickup (1 Ton 2WD)

1993-90	Front SRW, Diesel Engine	560-286	-	-	-	558-016	
1993-90	Rear SRW, 12" x 3" drum	-	-	560-348	-	558-016	
1993-90	Rear SRW, 12" x 2 1/2" drum	-	-	560-470	-	558-016	
1993-86	Front SRW, Gas Engine	560-148	562-248	-	-	558-016	
1993-74	Rear DRW, 12" x 3"	-	-	560-183	-	558-016	
1993-73	Front, DRW	560-181	-	-	-	558-016	
1989-88	Rear SRW, 12" x 2 1/2" drum, 5800lb axle	-	-	560-470	-	558-016	
1989-88	Rear SRW, 12" x 2 1/2" drum, 6200lb axle	-	-	560-348	-	558-016	
1987-78	Rear SRW, 12" x 2 1/2" drum	-	-	560-470	-	558-016	
1985-74	Front SRW w/ 1/2" Studs	560-286	-	-	-	558-016	
1985-74	Front SRW w/ 5/8 Studs	560-181	-	-	-	558-055	
1982-74	Rear SRW, 12" x 3" drum	-	-	560-180	-	558-055	
1981-78	Rear SRW, 12 1/8" x 2" Budd drum	-	-	560-155	562-155	558-016	
1981-78	Rear SRW, 12 1/8" x 2" Motor Wheel drum	-	-	560-039	-	558-016	

Dakota

2011-05		560-389	-	560-389	-	558-204	
2004-01		560-367	562-367	560-175	-	558-163	
2000		560-367	562-367	560-175	-	558-027	
1999-98		560-367	562-367	560-367	562-367	558-027	(60)
1997-91	Inc: (96-91) 4WD	560-367	562-367	560-103	562-173	558-027	
1996-87	2WD	560-102	562-172	560-103	562-173	558-027	
1990-87	4WD	560-289	-	560-103	562-173	558-027	

Durango

2015-12		-	-	-	-	559-236	
2011-04		560-389	-	560-389	-	558-204	
2003-98		560-367	562-367	560-175	-	558-148	(36) (60)

Raider

1989-87		561-114	562-214	561-312	562-412	559-070	
---------	--	---------	---------	---------	---------	---------	--

Ram 1500 Pickup (1/2 Ton)

2015-12		-	-	-	-	559-236	
2011-02		560-389	-	560-389	-	558-204	(60)
2001-00		560-269	562-369	560-287	-	558-148	(36)
1999-94	2WD	560-172	562-272	560-287	-	558-148	
1999-94	4WD	560-269	562-369	560-287	-	558-148	

Ram 1500 Van (1/2 Ton)

2003-95		560-102	562-172	N/A	-	558-027	(36)
---------	--	---------	---------	-----	---	---------	------

N/A – Dealer Part

* (36) 558-163 Bz	(60) 558-122 Ds						
-------------------	-----------------	--	--	--	--	--	--

WHEEL BOLTS and NUTS – Light Truck BOULONS et ÉCROUS DE ROUE – Camion Léger

Year Année	Application	FRONT/AVANT		REAR/ARRIERE		Wheel Nut Ecrous	*Optional Nut * Ecrou Facultatif
		Wheel Bolt Boulon	Wheel Parts Kit Trousse	Wheel Bolt Boulon	Wheel Parts Kit Trousse		

***OPTIONAL NUTS / ECROUS FACULTATIF**

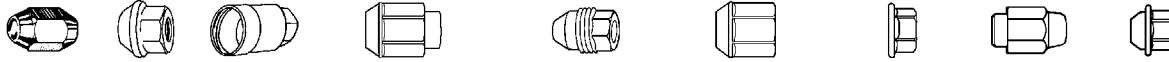

A=Acorn B=Bulge C=Cover D=DomestopCapped E=External Thread F=FlattopCapped H=Flanged Flat M=Mag W=Wire Wheel S=Standard

FINISHES
b = black
c = chrome
g = grey
s = stainless
z = zinc

DODGE TRUCK (Cont'd)

Ram 2500 Pickup (3/4 Ton)

2015-12		-	-	-	-	559-236	
2010-03		560-439	-	N/A	-	558-204	(60)
2002-01		560-439	-	560-472	-	558-062	
2000		560-472	-	560-472	-	558-062	
1999-94	Front, 2WD	560-468	-	N/A	-	558-062	
1999-94	Front, 4WD, 7500lb GVW	N/A	-	N/A	-	558-062	
1999-94	Front, 4WD, 8800 lb GVW	N/A	-	N/A	-	558-062	
1999-94	Rear, w/ Chrysler axle	N/A	-	560-468	-	558-062	
1999-94	Rear, w/ Dana axle	N/A	-	560-472	-	558-062	

Ram 2500 Van (3/4 Ton), 3500 Van (1 Ton)

2003-99	w/ Chrysler rear axle	560-468	-	560-468	-	558-062	
2002-99	w/ Dana rear axle	560-468	-	560-472	-	558-062	

Ram 3500 Pickup (1 Ton)

2015-12		-	-	-	-	559-236	
2011-03		560-439	-	560-355	-	558-204	(60) (64)
2002-01	SRW, DRW	560-439	-	560-355	-	558-204	
1999-94	SRW, 2WD	560-474	-	560-355	-	558-062	
1999-94	SRW, 4WD + DRW	N/A	-	560-355	-	558-062	

Ram 50 Pickup

1993-92		561-114	562-214	561-126	562-226	559-070	(19)
1991-87		561-114	562-214	561-312	562-412	559-172	(19)
1986-85	2WD	561-126	562-226	561-126	562-226	559-172	(19)
1986-85	4WD	561-114	562-214	561-126	562-226	559-172	(19)
1984-83		561-140	562-240	561-126	562-226	559-172	(19)

Ramcharger

1993-82	4WD Exc: (85-84) 4WD	560-277	-	560-103	562-173	558-027	
1993-78	2WD Inc: Budd rotor	560-102	562-172	560-103	562-173	558-027	
1985-84	4WD	560-363	-	560-103	562-173	558-027	
1985-75	2WD Inc: Kelsey Hayes rotor	560-148	562-248	560-103	562-173	558-027	
1981-78	4WD, w/ locking hubs	560-277	-	560-103	562-173	558-027	
1981-75	4WD, Inc: (81-78) w/o locking hubs	560-110	-	560-103	562-173	558-027	

W100/150 Pickup (1/2 Ton 4WD)

1993-86		560-277	-	560-103	562-173	558-027	
1985-84		560-363	-	560-103	562-173	558-027	
1983-78	Inc: (81-78) w/ locking hubs	560-277	-	560-103	562-173	558-027	
1981-75	Inc: (81-78) w/o locking hubs	560-110	-	560-103	562-173	558-027	

N/A – Dealer Part

* (19) 559-141 Ac	(60) 558-122 Ds	(64) 558-296 Hb	
-------------------	-----------------	-----------------	--

WHEEL BOLTS and NUTS – Light Truck BOULONS et ÉCROUS DE ROUE – Camion Léger

Year Année	Application	FRONT/AVANT		REAR/ARRIERE		Wheel Nut Ecrous	*Optional Nut * Ecrou Facultatif
		Wheel Bolt Boulon	Wheel Parts Kit Trousse	Wheel Bolt Boulon	Wheel Parts Kit Trousse		

*OPTIONAL NUTS / ECROUS FACULTATIF

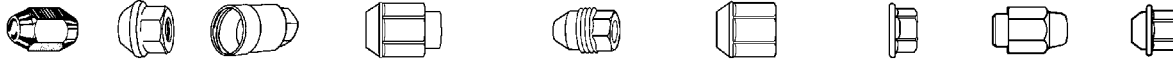

A=Acorn B=Bulge C=Cover D=DometopCapped E=External Thread F=FlattopCapped H=Flanged Flat M=Mag W=Wire Wheel S=Standard

FINISHES
b = black
c = chrome
g = grey
s = stainless
z = zinc

DODGE TRUCK (Cont'd)

W200/250 Pickup (3/4 Ton 4WD)

1993-86	Rear, Chrysler axle	N/A	-	560-175	-	558-016	
1993-86	Rear, Dana 5500 lb axle	N/A	-	560-470	-	558-016	
1993-86	Rear, Dana 6200 lb axle	N/A	-	560-348	-	558-016	
1993-86 + 81	Front 3500 lb axle	560-277	-	N/A	-	558-016	
1993-86 + 81-75	Front 4500 lb axle	560-363	-	N/A	-	558-016	
1985-84	Chrysler rear axle	560-363	-	560-175	-	558-016	
1985-84	Dana rear axle	560-363	-	560-470	-	558-016	
1983-82	w/ 3500 lb axle	560-277	-	560-470	-	558-016	
1983-82	w/ 4500 lb axle	560-363	-	560-470	-	558-016	
1981-74	Rear, 12" x 2½" drum	N/A	-	570-470	-	558-016	
1981-74	Rear, 12 1/8" x 2" Budd drum	N/A	-	560-155	562-155	558-016	
1981-74	Rear, 12 1/8" x 2" Motor Wheel drum	N/A	-	560-039	-	558-016	
1980-75	Front, w/3500 lb axle	560-110	-	N/A	-	558-016	

W300/350 Pickup (1 Ton, 4WD)

1993-90	SRW, 12" x 2½" rear drum	560-363	-	560-470	-	558-016	
1993-90	SRW, 12" x 3" rear drum	560-363	-	560-348	-	558-016	
1993-90	DRW, 12" x 3" rear drum	N/A	-	560-183	-	558-057	
1989-88	Rear, SRW 12" x 2½" drum 5800 lb axle	N/A	-	560-470	-	558-016	
1989-88	Rear, SRW 12 x 2½" drum, 6200 lb axle	N/A	-	560-348	-	558-016	
1989-86	Front, SRW	560-363	-	N/A	-	558-016	
1989-78	Front, DRW	560-181	-	N/A	-	558-057	
1989-78	Rear, DRW 12" x 3" drum	N/A	-	560-183	-	558-057	
1987-78	Rear, SRW 12" x 2½" drum	N/A	-	560-470	-	558-016	
1987-78	Rear, SRW 12" x 3" drum	N/A	-	560-180	-	558-016	
1985-78	Front, SRW	560-182	-	N/A	-	558-016	
1977-75	SRW	560-182	-	560-180	-	558-055	
1977-75	DRW	560-181	-	560-183	-	558-057	

FORD TRUCK

Aerostar

1997-89	4WD	560-358	-	560-173	562-273	558-027	(3) (36)
1997-86	Exc: (97-89) 4WD	560-172	562-272	560-173	562-273	558-027	(3) (36)

Bronco

1996-76	all Exc: (89) w/ HD Front end + snow plow (88-87) w/ manual lock hubs to 4/30/88, (85) 4.10 ratio, w/ auto lock hubs	560-470	-	560-173	562-273	558-016	(2)
1989	3-54 ratio, w/ manual lock hubs w/ HD Front end + snow plow	560-172	562-272	560-173	562-273	558-016	(2)
1988-87	w/ manual lock hubs to 4/30/88	560-172	562-272	560-173	562-273	558-016	(2)
1985	4.10 ratio, w/ auto lock hubs	560-172	562-272	560-173	562-273	558-016	(2)
1975-73		560-148	562-248	560-173	562-273	558-016	

N/A – Dealer Part

* (2) 558-071 Ds	(3) 558-094 DBs	(36) 558-163 Bz					
------------------	-----------------	-----------------	--	--	--	--	--

WHEEL BOLTS and NUTS – Light Truck BOULONS et ÉCROUS DE ROUE – Camion Léger

Year Année	Application	FRONT/AVANT		REAR/ARRIERE		Wheel Nut Ecrous	*Optional Nut * Ecrou Facultatif
		Wheel Bolt Boulon	Wheel Parts Kit Trousse	Wheel Bolt Boulon	Wheel Parts Kit Trousse		

*OPTIONAL NUTS / ECROUS FACULTATIF

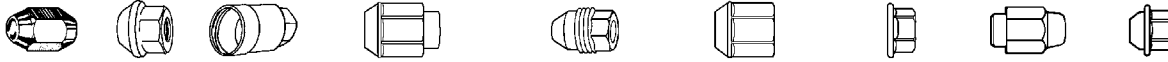

A= Acorn B= Bulge C= Cover D= Domestop Capped E= External Thread F= Flattop Capped H= Flanged Flat M= Mag W= Wire Wheel S= Standard

FINISHES
b = black
c = chrome
g = grey
s = stainless
z = zinc

FORD TRUCK (Cont'd)

Bronco II							
1990-84		560-172	562-272	560-173	562-273	558-027	(3) (36)

E-100, E-150, Econoline Van (1/2 Ton)							
2014-08		N/A	-	560-529	-	558-016	
2007-01		560-474	562-369	560-441	-	558-016	(6)
2000-80		560-269	562-369	560-173	562-273	558-016	(6) (5)
1979-75		560-148	562-248	560-173	562-273	558-016	(2)

E-200, E-250, Econoline Van (3/4 Ton)							
2014-08		N/A	-	560-529	-	558-016	
2007-01		560-474	-	560-529	-	558-016	
2000-90	Inc: (91-90) 12" x 2½" rear brakes	560-474	-	560-305	-	558-061	
1991-90	12" x 3" rear brakes	560-474	-	560-303	-	558-061	
1989-86	Front	560-474	-	N/A	-	558-016	
1989-86	Rear, 12" x 2½" brakes, 8.8" ring gear	N/A	-	560-305	-	558-061	
1989-84	Rear, 12" x 2½" brakes, 9.75" ring gear	N/A	-	560-298	-	558-016	
1989-84	Rear, 12" x 3 brakes	N/A	-	560-355	-	558-061	
1985-84	Front	560-269	562-369	N/A	-	558-016	
1983-81		560-269	562-369	560-186	560-386	558-016	
1980-75		560-269	562-369	560-470	-	558-016	

E-300, E-350 Econoline Van (1 Ton), E-450 (1 Ton) (08-03)							
2008-92	SRW, DRW	560-474	-	560-303	-	558-100	
2002-87	DRW, Exc: (89-87) 12" x 3" brakes	560-474	-	560-303	-	558-092	(37)
1991-90	SRW, DRW	560-474	-	560-303	-	558-061	
1989-87	DRW, 12" x 3" brakes	560-474	-	560-355	-	558-092	
1989-85	SRW	560-474	-	560-355	-	558-061	
1986-85	DRW	560-474	-	560-355	-	558-092	
1984	Front, DRW from 1/1/84	560-474	-	N/A	-	558-092	
1984	Rear, DRW from 1/1/84	N/A	-	560-355	-	558-092	
1984-75	Front, DRW to 12/31/83	560-472	-	N/A	-	558-058	
1984-75	Front SRW	560-474	-	N/A	-	558-061	
1984-75	Rear, DRW to 12/31/83 RH	N/A	-	560-355	-	558-100	
1984-75	Rear, DRW to 12/31/83 LH	N/A	-	560-356	-	N/A	
1984-75	Rear, SRW Inc: (79-75) RH	N/A	-	560-355	-	558-061	
1979-75	Rear, SRW LH	N/A	-	560-356	-	N/A	

E-350, E-450, E-550, Super Duty Pickup (1 ton) See F-350, etc.

E-Super Duty Van							
2002-99		560-474	562-351	561-251	560-303	559-074	

Escape							
2015-11		N/A	-	561-251	-	559-190	
2010-01		561-251	-	561-251	-	559-190	(7)

Excursion							
2005-00	2WD, 4WD	561-424	-	561-424	-	559-196	

N/A – Dealer Part

* (2) 558-071 Ds (3) 558-094 DBc (5) 558-143 Ds (6) 558-162 Bz (7) 559-070 Ac (36) 559-163 Bz (37) 558-127 Hb (61) 558-197 Wz

WHEEL BOLTS and NUTS – Light Truck BOULONS et ÉCROUS DE ROUE – Camion Léger

Year Année	Application	FRONT/AVANT		REAR/ARRIERE		Wheel Nut Ecrous	*Optional Nut * Ecrou Facultatif
		Wheel Bolt Boulon	Wheel Parts Kit Trousse	Wheel Bolt Boulon	Wheel Parts Kit Trousse		

*OPTIONAL NUTS / ECROUS FACULTATIF

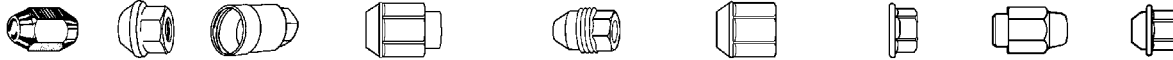

A= Acorn B= Bulge C= Cover D= DometopCapped E= External Thread F= FlattopCapped H= Flanged Flat M= Mag W= Wire Wheel S= Standard

FINISHES
b = black
c = chrome
g = grey
s = stainless
z = zinc

FORD TRUCK (Cont'd)

Expedition

2016-01		561-442	-	561-442	-	559-196	(53)
2000-97	12mm, 2WD + 4WD	561-390	-	561-390	-	559-174	

Explorer

2016-04	2WD	560-444	-	560-444	-	558-016	(58)
2005-02	2WD	560-479	-	560-444	-	558-199	(3)
2001-02	4WD	560-269	562-369	560-479	-	558-199	(3)
2001-95	2WD	560-172	562-272	560-368	562-468	558-163	(8)
2001-95	4WD	560-269	562-369	560-368	562-468	558-163	(8)
1994-91	2WD, 4WD	560-172	562-272	560-173	562-273	558-027	(3) (36)

Explorer Sport Trac

2010-06	2WD	560-444	-	560-444	-	558-016	(58)
2005-01	Rear Wheel Drive	560-345	-	560-368	562-468	558-094	(21)(52)
2005-01	Four Wheel Drive	560-269	562-369	560-368	562-468	558-094	(21)(52)

F-100, F-150 Pickup (1/2 Ton)

2015-09		N/A	-	561-442	-	559-323	(53)
2010-01	14mm 5 bolt	561-442	-	561-442	-	559-196	(47) (53)
2005-97	4WD 12mm, 5 + 7 bolt	561-393	-	561-390	-	559-174	
2000	2WD Exc: 8 bolt	561-390	-	561-390	-	559-174	
1999-97	2WD	561-390	-	561-390	-	559-174	
1996-84	4WD Exc: (88) w/ manual lock hubs	560-470	-	560-173	562-273	558-016	(2)
1996-80	2WD Exc: (83-80) F100 4600-4700 lb GVW	560-269	562-369	560-173	562-273	558-016	(2)
1988	4WD w/ manual lock hubs 3.54 or 4.09 ratio	560-172	562-272	560-173	562-273	558-016	(2)
1983-80	F100 w/ manual brakes	560-269	562-369	560-173	562-273	558-016	(2)
1983-80	F100 w/ power brakes, 4600-4700 lb GVW	560-315	-	560-173	562-273	558-016	(2)
1983-80	F100 w/ power brakes, 5000-5100 lb GVW	560-269	562-369	560-173	562-273	558-016	(2)
1983-80	F150 2WD	560-269	562-369	560-173	562-273	558-016	(2)
1983-80	F150 4WD	560-470	-	560-173	562-273	558-016	(2)
1979-76	4WD	560-470	-	560-173	562-273	558-016	(2)
1979-75	2WD	560-148	562-248	560-173	562-273	558-016	(2)

F-250 Pickup (3/4 Ton)

2015-97	2WD under 8500lb GVW	561-390	-	561-390	-	559-174	
2002-97	4WD under 8500 lb GVW	561-393	-	561-390	-	559-174	
1997	2WD over 8500 lb GVW	560-474	-	560-303	-	558-052	
1997	4WD over 8500 lb GVW	561-473	-	560-303	-	558-052	
1996-90	Front 4WD	560-473	-	-	-	558-061	
1996-87	Rear 12" x 2½" brakes	-	-	560-305	-	558-052	
1996-86	Front 2WD	560-474	-	-	-	558-061	
1996-85	Rear 12" x 3" brakes Inc: (89-85) 10.25" ring gear	-	-	560-303	-	558-052	
1989-86	Front 4WD, 3850 lb axle	560-473	-	-	-	558-061	
1989-85	Rear 12" x 3" brake Exc: 10.25" ring gear	-	-	560-355	-	558-061	
1986	Rear 12" x 2½" brakes, 8.8 or 10.25 ring gear	-	-	560-305	-	558-061	

N/A – Dealer Part

* (2) 558-071 Ds	(3) 558-094 DBs	(21) 559-163 Bz	(36) 558-163 Bz	(47) 559-306 Ds	(52) 558-199 Wz	(53) 559-288 Dc	(58) 558-146 Ac
------------------	-----------------	-----------------	-----------------	-----------------	-----------------	-----------------	-----------------

WHEEL BOLTS and NUTS – Light Truck BOULONS et ÉCROUS DE ROUE – Camion Léger

Year Année	Application	FRONT/AVANT		REAR/ARRIERE		Wheel Nut Ecrous	*Optional Nut * Ecrou Facultatif
		Wheel Bolt Boulon	Wheel Parts Kit Trousse	Wheel Bolt Boulon	Wheel Parts Kit Trousse		

*OPTIONAL NUTS / ECROUS FACULTATIF

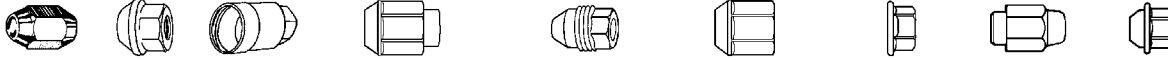

A=Acorn B=Bulge C=Cover D=DomestopCapped E=External Thread F=FlattopCapped H=Flanged Flat M=Mag W=Wire Wheel S=Standard

FINISHES
b = black
c = chrome
g = grey
s = stainless
z = zinc

FORD TRUCK (Cont'd)

F-250 Pickup (3/4 Ton) (Cont'd)

1986	Rear 12" x 2½" brakes, 9.75" ring gear	-	-	560-298	-	558-016	(2)
1985-84	Front 4WD, 3850 lb axle w/o 4.10 ratio	560-473	-	-	-	558-061	
1985-84	Front 4WD, 3850 lb axle w/ 4.10 ratio	560-277	-	-	-	558-016	
1985-84	Front 4WD, 4600 lb axle	560-277	-	-	-	558-016	(2)
1985-73	Front 2WD Inc: (79-73) Dual Piston caliper	560-269	562-369	-	-	558-016	
1984	Rear 12" x 2½" brakes	-	-	560-298	-	558-016	(2)
1984	rear 12" x 3" brakes	-	-	560-355	-	558-061	
1984-81	Front 4WD, under 8500 lb GVW	560-277	-	-	-	558-016	
1984-81	Front 4WD, over 8500 lb GVW	560-473	-	-	-	558-061	
1983-82	Rear 12" x 3" brakes RH	-	-	560-468	-	558-061	
1983-80	Rear 12" x 2½" brakes	-	-	560-186	-	558-016	(2)
1981	Front 4WD, 4500 lb axle, 3.54 ratio	560-277	-	-	-	558-016	
1981	Front 4WD, 4500 lb axle, 4.10 ratio	560-473	-	-	-	558-061	
1981	Front 4WD, 3800 lb axle	560-277	-	-	-	558-016	
1981-80	Rear 12" x 3" brakes RH	-	-	560-355	-	558-061	
1980	Front 4WD	560-277	-	-	-	558-016	
1979-78	4WD	560-470	-	560-470	-	558-016	
1979-73	2WD w/ single piston caliper	560-148	562-248	560-470	-	558-016	(2)
1979-73	2WD w/ dual piston caliper	560-269	562-369	560-470	-	558-016	(2)
1979-73	4WD	N/A	-	560-470	-	558-016	(2)

F-250 Super Duty Pickup (3/4 Ton), F53 (14-03)

2015-03	14mm	561-490	-	561-490	-	559-246	
2005-01	9/16"	N/A	-	560-303	-	N/A	
2000-99	2WD 12mm	561-390	-	561-390	-	N/A	
2000-99	4WD 12mm	561-393	-	561-390	-	N/A	
2000-99	14 mm	561-424	-	561-424	-	559-196	
2000-99	9/16"	N/A	-	560-303	-	N/A	

F-350 Pickup (1 Ton)

2012-90	2WD, SRW	560-474	-	560-303	-	558-100	
1997-90	2WD, DRW	560-474	-	560-303	-	558-092	(37)
1997-90	4WD, DRW	560-473	-	560-303	-	558-092	(37)
1997-90	4WD, SRW	560-473	-	560-303	-	558-100	
1989-85	Front 4WD Inc: (85) 5000lb axle	560-473	-	-	-	558-061	
1989-85	Rear, SRW, 10.75" ring gear	-	-	560-303	-	558-061	
1989-85	Rear, DRW, 10.25" ring gear	-	-	560-303	-	558-092	
1989-85	Rear, SRW, Exc: 10.75" ring gear	-	-	560-355	-	558-061	
1989-85	Rear, DRW Exc: 10.25" ring gear	-	-	560-355	-	558-092	
1989-84	Front 2WD, DRW from 1/1/84	560-474	-	-	-	558-092	
1989-79	Front 2WD, SRW	560-474	-	-	-	558-061	
1985-84	Front 4WD, 4600 lb axle from 10/1/83	560-277	-	-	-	558-016	
1984	Front 4WD, 4500, 4600 lb axle to 9/30/83	560-473	-	-	-	558-061	
1984-80	Rear, SRW to 1/31/83 RH	-	-	560-355	-	558-061	

N/A – Dealer Part

* (2) 558-071 Ds (37) 558-127 Hb

WHEEL BOLTS and NUTS – Light Truck BOULONS et ÉCROUS DE ROUE – Camion Léger

Year Année	Application	FRONT/AVANT		REAR/ARRIERE		Wheel Nut Ecrous	*Optional Nut * Ecrou Facultatif
		Wheel Bolt Boulon	Wheel Parts Kit Trousse	Wheel Bolt Boulon	Wheel Parts Kit Trousse		

*OPTIONAL NUTS / ECROUS FACULTATIF

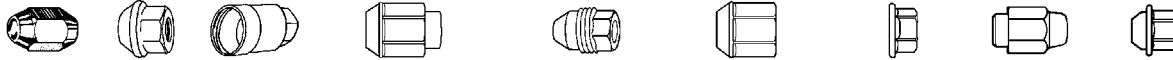

A=Acorn B=Bulge C=Cover D=DometopCapped E=External Thread F=FlattopCapped H=Flanged Flat M=Mag W=Wire Wheel S=Standard

FINISHES
b = black
c = chrome
g = grey
s = stainless
z = zinc

FORD TRUCK (Cont'd)

F-350 Pickup (1 Ton) (Cont'd)

1984-79	Front 2WD, DRW to 12/31/83	560-472	-	-	-	558-092	
1984-73	Rear DRW to 12/31/83 RH	-	-	560-355	-	558-058	
1984-73	Rear DRW to 12/31/83 LH	-	-	560-356	-	N/A	
1983-80	Front 4WD	560-473	-	-	-	558-061	
1983	Rear, SRW from 2/1/83 RH	-	-	N/A	-	558-061	
1983	Rear, SRW from 2/1/83 LH	-	-	560-305	-	N/A	
1983	Rear SRW to 1/31/83 LH	-	-	560-356	-	N/A	
1979	Front 4WD	560-470	-	-	-	558-016	
1979	Rear, 4WD	-	-	560-470	-	558-016	
1979-73	Rear, 2WD, SRW LH	-	-	560-356	-	N/A	
1979-73	Rear, 2WD, SRW, RH	-	-	560-355	-	558-061	
1978-73	Front 2WD	560-472	-	-	-	558-058	
1978-73	Front 4WD	560-474	-	-	-	558-061	

F-350, F-450, F-550 Super Duty

2015-98	all (04-01), 2WD (00-98)	561-490	-	561-490	-	559-246	
1997-90	Front, 2WD	560-474	-	N/A	-	N/A	
1997-90	Front, 4WD	560-473	-	N/A	-	N/A	
1997-90	Rear, 8 bolt	N/A	-	560-303	-	N/A	
1997-90	Rear, 10 bolt	N/A	-	560-474	-	N/A	
1989-88		560-474	-	560-474	-	558-092	

Ranger

2011-83	2WD	560-173	562-273	560-173	562-273	558-171	
2009-98	4WD	560-269	562-369	560-173	562-273	558-171	
1997-83	4WD	560-172	562-272	560-173	562-273	558-027	(8)

Windstar

2003-99		561-416	-	561-416	-	559-150	(9) (21)
1998-97	from 8/4/97	561-251	562-351	561-376	562-476	559-150	(9) (21)
1997-95	to 8/3/97	561-251	562-351	561-251	562-351	559-150	(21)

ISUZU TRUCK

Amigo, Pickup

2000-99	Amigo	561-114	562-214	561-312	562-412	559-074	(17)
1995-81	Inc: Pickup w/ 14.4mm rear knurl	561-114	562-214	561-126	562-226	559-074	(17)
1994-90	2WD w/ 12.7mm rear knurl dia.	561-114	562-214	561-110	562-310	559-074	(17)

Ascender (08-06), I-290 (08-06), I-350 (06), I-370 (08-07), Hombre (00-96)

2008-96		561-110	562-310	561-110	562-310	559-191	
2005-02		561-169	562-366	N/A	-	559-163	

Axiom

2004-03		561-312	562-412	561-312	562-412	559-301	
2002		561-114	562-214	561-312	562-412	559-074	

N/A – Dealer Part

* (8) 558-171 Wz	(9) 559-074 Ds	(17) 559-137 AHc	(21) 559-163 Bz			
------------------	----------------	------------------	-----------------	--	--	--

WHEEL BOLTS and NUTS – Light Truck BOULONS et ÉCROUS DE ROUE – Camion Léger

Year Année	Application	FRONT/AVANT		REAR/ARRIERE		Wheel Nut Ecrous	*Optional Nut * Ecrou Facultatif
		Wheel Bolt Boulon	Wheel Parts Kit Trousse	Wheel Bolt Boulon	Wheel Parts Kit Trousse		

*OPTIONAL NUTS / ECROUS FACULTATIF

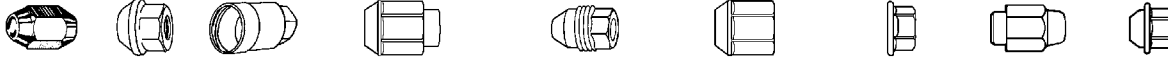

A= Acorn B= Bulge C= Cover D= DomestopCapped E= External Thread F= FlattopCapped H= Flanged Flat M= Mag W= Wire Wheel S= Standard

FINISHES
b = black
c = chrome
g = grey
s = stainless
z = zinc

ISUZU TRUCK (Cont'd)

Rodeo, Rodeo Sport (04-98)

2004-02		561-312	562-412	561-312	562-412	559-075	
2001-91	Inc : 6 cyl.	561-114	562-214	561-312	562-412	559-074	(17)
1997-91	4 cyl.	561-114	562-214	561-110	562-310	559-074	(17)

Trooper, Vehicross (02-99)

2002-01		561-114	562-214	N/A	-	559-074	
2000-84		561-114	562-214	561-126	562-226	559-074	(17)

MAZDA TRUCK

B2000, B2200, B2600 Pickup

1993-86		561-168	562-368	561-309	562-409	559-070	
1984-80	from 8/79	561-168	562-368	561-168	562-368	559-172	
1979	to 7/79	N/A	-	561-168	562-368	559-172	

B2300, B2500, B3000, B4000 Pickup

2010-98	4WD	560-269	562-369	560-368	562-468	558-094	(8)
2010-94	2WD	560-345	-	560-345	-	558-094	(8)
1997-94	4WD	560-172	562-272	560-368	562-468	558-094	(8)

Navajo

1994-91	2WD	560-345	-	560-368	562-468	558-094	
1994-91	4WD	560-172	562-272	560-368	562-468	558-094	

NISSAN TRUCK

Armada

2015-04		561-378	562-478	561-378	562-478	559-114	
---------	--	---------	---------	---------	---------	---------	--

Frontier (15-99), Xterra (15-00)

2015-05		561-100	562-200	561-100	562-200	559-125	(15)
2004-99		561-100	562-200	561-100	562-200	559-114	
1998		561-102	562-302	561-100	562-200	559-114	

NV1500, NV2500, NV3500

2015-12		N/A	-	N/A	-	N/A	
---------	--	-----	---	-----	---	-----	--

Pathfinder (15-87)

2015-05		561-378	562-478	561-378	562-478	559-125	(15)
2004-87		561-102	562-302	561-100	562-200	559-125	(15)

Pickup, Frontier (15-98), Titan (15-11)

2015-99		561-100	562-200	561-100	562-200	559-125	(15)
1998-90		561-102	562-302	561-100	562-200	559-125	(15)
1989-86	D21, SRW	561-102	562-302	561-100	562-200	559-114	
1989-86	D21, DRW	561-102	562-302	N/A	-	559-125	
1989-77	D21, SRW (89-86), 720 (86-80), (77) w/ front discs	561-102	562-302	561-100	562-200	559-125	(15)
1986-77	Inc: (86-80) 720 Pickup	561-102	562-302	561-100	562-200	559-125	
1977-72	Inc: (77) front drums	561-100	562-200	561-100	562-200	559-125	

Titan

2010-04		561-378	562-478	561-378	562-478	559-310	
---------	--	---------	---------	---------	---------	---------	--

N/A – Dealer Part

* (8) 558-171 Wz | (15) 559-114 Ac | (17) 559-137 AHc

WHEEL BOLTS and NUTS – Light Truck BOULONS et ÉCROUS DE ROUE – Camion Léger

Year Année	Application	FRONT/AVANT		REAR/ARRIERE		Wheel Nut Ecrous	*Optional Nut * Ecrou Facultatif
		Wheel Bolt Boulon	Wheel Parts Kit Trousse	Wheel Bolt Boulon	Wheel Parts Kit Trousse		

*OPTIONAL NUTS / ECROUS FACULTATIF

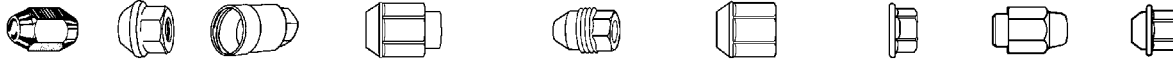

A= Acorn B= Bulge C= Cover D= DometopCapped E= External Thread F= FlattopCapped H= Flanged Flat M= Mag W= Wire Wheel S= Standard

FINISHES
b= black
c= chrome
g= grey
s= stainless
z= zinc

PLYMOUTH TRUCK

PB100/150 Full Size Van, Voyager (1/2 Ton) See DODGE D100/150

PB200/250 Full Size Van, Voyager (3/4 Ton) See DODGE D100/150

TOYOTA TRUCK

4Runner, Sequoia (15-01)

2015-84		561-126	562-226	561-312	562-412	559-070	
---------	--	---------	---------	---------	---------	---------	--

FJ Cruiser

2012-07		561-126	562-226	561-126	562-226	559-070	(17) (21) (65)
---------	--	---------	---------	---------	---------	---------	-------------------

Highlander

2015-01		561-126	562-226	561-126	562-226	559-070	(17) (21) (65)
---------	--	---------	---------	---------	---------	---------	-------------------

Land Cruiser

2015-98		561-527	-	561-527	-	559-277	
1997-84		561-126	562-226	561-312	562-412	559-070	
1990-81		561-264	-	561-312	562-412	559-172	
1980-69		561-122	562-322	561-122	562-322	559-172	

Pickup

1995-79	2WD 5-lug Inc: (83-82) Gas Eng.	561-122	562-322	561-126	562-226	559-172	
1995-84	4WD	561-126	562-226	561-312	562-412	559-070	
1983-81	4WD	561-264	-	561-312	562-412	559-172	
1980-79	4WD	561-122	562-322	561-312	562-412	559-172	

Rav 4

2015-97	2WD, Inc: (97) 2WD w/o ABS	561-126	562-226	561-126	562-226	559-070	(17) (21)
2015-97	4WD	561-126	562-226	561-122	562-322	559-070	(17) (21)
1997-96	(97) 2WD w/ ABS, (96)all	561-126	562-226	561-122	562-322	559-070	

T100

1998-93		561-126	562-226	561-312	562-412	559-172	
---------	--	---------	---------	---------	---------	---------	--

Tacoma (15-95), Tundra (15-00)

2015-98	2WD 6-lug.	561-126	562-226	561-312	562-412	559-070	
2015-95	2WD, Inc: (02-98) 2WD 5-lug	561-122	562-322	561-126	562-226	559-172	
2015-95	4WD, Tundra (03-00)	561-126	562-226	561-312	562-412	559-070	

N/A – Dealer Part

* (17) 559-137 AHc	(21) 559-163 Bz	(65) 559-167 Mc				
--------------------	-----------------	-----------------	--	--	--	--

SPINDLE and AXLE NUTS ÉCROUS D'ESSIEU et FUSSE

New Axle or Spindle Nuts are recommended whenever a wheel hub, rotor, drum or CV joint is removed. Since the spindle or axle nut is relied upon to hold the wheel on the vehicle these fasteners should be replaced each time for safety.

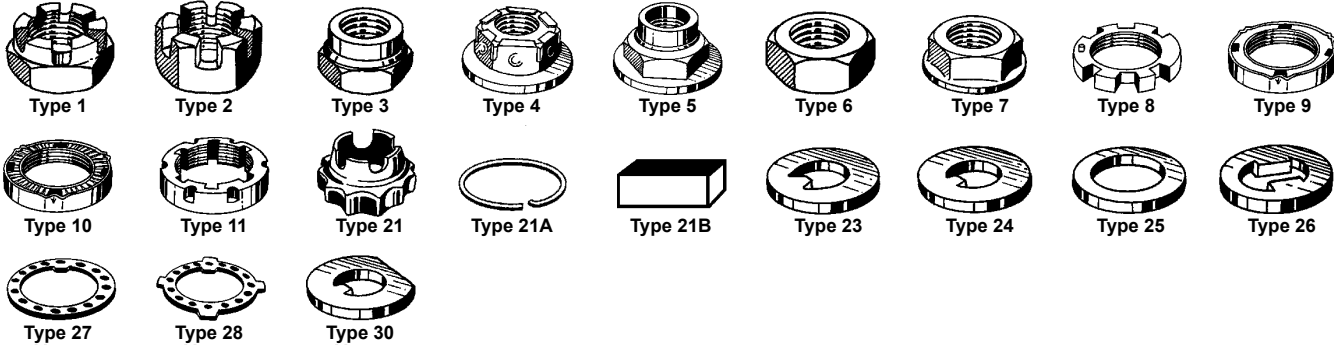

Order by Stock Number

AXLE & SPINDLE NUTS

Stock No.	Type	Size	Hex	Height	Std.Pkg.
566-057	1	27/32-20	1-1/4	13/16	5
566-065	2	3/4-20	1-1/16	1/2	5
566-072	6	3/4-16	1-1/16	3/8	5
566-074	6	13/16-20	1-1/8	3/8	5
566-079	6	22mm-1.5	32mm	18mm	5
566-089	3	20mm-1.5	29mm	19mm	5
566-091	5	22mm-1.5	32mm	20mm	5
566-095	3	24mm-2.0	36mm	21mm	5
566-097	5	22mm-1.5	32mm	21mm	5
566-098	4	24mm-2.0	36mm	21mm	5
566-099	4	24mm-2.0	36mm	20mm	5
566-101	6	20mm-1.5	30mm	8mm	5
566-105	1	22mm-1.5	32mm	21mm	2
566-110	5	24mm-1.5	36mm	23mm	2
566-113	6	24mm-1.5	35mm	18mm	2
566-119	7	22mm-1.5	30mm	14mm	2
566-120	8	1 5/8-16	2-3/16	3/8	2
566-122	8	2-16	2-1/2	11/32	2
566-128	9	1 5/8-16	2-5/8	13/16	2
566-132	11	2-16	2-5/8	37/64	2
566-133	10	2-16R	3	3/4	2
566-134	10	2-16L	3	3/4	2
566-142	8	38mm-1.5	55.3mm	8mm	2
566-144	7	27mm-2.0	34mm	18mm	2
566-145	5	20mm-1.5	29mm	23mm	2
566-148	2	20mm-1.25	30mm	14mm	2

RETAINERS

Stock No.	Type	Size	Application	Std.Pkg.
566-151	21	N/A	Retainer for 556-150	2
566-073	21	N/A	Retainer for 556-072	5
566-075	21	N/A	Retainer for 566-074	5
566-080	21	N/A	Retainer for 566-079	5
566-102	21	N/A	Retainer for 566-101	5
566-140	21B	N/A	Key for 566-101	2
566-141	21A	N/A	Retainer for 556-132	2
566-149	21	N/A	Retainer for 566-113	2

WASHERS

Stock No.	Type	I.D.	O.D.	Thick	Pkg.
566-205	24	3/4	1-21/32	3/32	5
566-207	23	27/32	2-1/16	11/64	5
566-215	25	21.5mm	36.0mm	3.7mm	5
566-217	25	23mm	38.0mm	3.6mm	5
566-219	23	3/4	1-21/32	3/32	5
566-226	25	20.2mm	39.8mm	4.1mm	5
566-227	25	24.7mm	45.1mm	4.7mm	5
566-228	25	24.9mm	49.0mm	6.1mm	5
566-229	23	20.1mm	41.8mm	3.0mm	5
566-232	29	20.1mm	44mm	2.6mm	5
566-233	26	3/4	1-21/32	3/32	5
566-234	24	23.5mm	46.9mm	4.6mm	5
566-237	25	22.7mm	42.7mm	5.4mm	5
566-240	27	1-5/8	2-3/16	1/8	2
566-241	28	1-5/8	2-1/2	7/64	2
566-242	28	2	2-17/32	7/64	2
566-253	27	1-1/2	2-3/16	1/8	2
566-261	25	19.1mm	41.6mm	2.6mm	2

papco[®] WHEEL HUB DUST CAPS



'Papco' Wheel Hub Dust Caps prolong bearing life by preventing road grime, dust, dirt, or road salt from entering the wheel bearing.

Order by Stock Number

Individually Carded

Stock No.	O.D.	Description
566-301	1-25/32	GM, Ford, Chrysler, Honda, Nissan, AMC
566-302	2-3/32	General Motors
566-303	1-31/32	Ford Pickups and Vans with light duty brakes

SPINDLE and AXLE NUTS ÉCROUS D'ESSIEU et FUSSE

Year Année	Application	Nut / Ecrous Location		Washer / Rondelle Location		Retainer / Retenue Location	
		Front Avant	Rear Arriere	Front Avant	Rear Arriere	Front Avant	Rear Arriere

ACURA

CL

2003-01		566-110	N/R	N/R	N/R	N/R	N/R
1999-97		566-110	566-110	N/R	N/A	N/R	N/R

Integra

2001-86		566-091	566-091	N/R	566-234	N/R	N/R
---------	--	---------	---------	-----	---------	-----	-----

Legend (95-86), NSX (05-91)

2005-91		566-146	566-146	N/R	-	N/R	N/R
1990-86		566-110	566-110	N/R	N/A	N/R	N/R

MDX (14-01), RL, RSX (06-02), RDX (12-07)

2014-96		566-110	566-110	N/R	N/A	N/R	N/R
---------	--	---------	---------	-----	-----	-----	-----

TL, TSX (14-04)

2014-99		566-110	N/R	N/R	N/R	N/R	N/R
1998-95		566-110	566-091	N/R	566-234	N/R	N/R

Vigor

1994-92		566-110	566-091	N/R	566-234	N/R	N/R
---------	--	---------	---------	-----	---------	-----	-----

AMERICAN MOTORS

AMX, Concord

1983-79		566-072	N/A	N/A	566-217	566-073	N/R
1978		566-074	N/A	N/A	566-217	566-075	N/R
1974	Bendix	566-074	N/A	N/A	N/A	566-075	N/R
1974	Kelsey Hayes	566-072	N/A	N/A	N/A	566-073	N/R

Eagle

1988-84		N/A	N/A	566-227	566-217	566-149	N/R
1983-80		N/R	N/A	N/R	566-217	N/R	N/R

Spirit

1983-79		566-072	N/A	N/A	566-217	566-073	N/R
---------	--	---------	-----	-----	---------	---------	-----

BUICK

Century

2005-94		566-144	N/R	N/R	N/R	N/R	N/R
1993-82	Inc: 10.4" rotors	566-095	N/R	566-227	N/R	N/R	N/R
1990-82	9.86" rotors	566-089	N/R	566-226	N/R	N/R	N/R
1981-73		566-065	N/R	566-205	N/R	N/R	N/R

Electra, Electra 225

1990-85		566-095	N/R	566-227	N/R	N/R	N/R
1984-63		566-065	N/R	566-205	N/R	N/R	N/R

Estate Wagon

1990-71		566-065	N/R	566-205	N/R	N/R	N/R
---------	--	---------	-----	---------	-----	-----	-----

Le Sabre, LaCrosse (12-05)

2012-92		566-144	N/R	N/R	N/R	N/R	N/R
1991-86		566-095	N/R	566-227	N/R	N/R	N/R
1985-63		566-065	N/R	566-205	N/R	N/R	N/R

Park Avenue (05-91), Rendezvous (07-02)

2007-91		566-144	N/R	N/R	N/R	N/R	N/R
---------	--	---------	-----	-----	-----	-----	-----

Regal

1995-88		566-095	N/R	566-228	N/R	N/R	N/R
1987-73		566-065	N/R	566-205	N/R	N/R	N/R

N/R – Not Required • N/A – Dealer Part

SPINDLE and AXLE NUTS ÉCROUS D'ESSIEU et FUSSE

Year Année	Application	Nut / Ecrous Location		Washer / Rondelle Location		Retainer / Retenue Location	
		Front Avant	Rear Arriere	Front Avant	Rear Arriere	Front Avant	Rear Arriere

BUICK (Cont'd)

Riviera, Reatta							
1999-92		566-144	N/R	N/R	N/R	N/R	N/R
1991-90		566-095	N/R	566-228	N/R	N/R	N/R
1989-86		566-095	N/R	566-227	N/R	N/R	N/R
1985-79		N/A	N/R	566-227	N/R	566-149	N/R
1978-63		566-065	N/R	566-205	N/R	N/R	N/R
Roadmaster							
1996-91		566-065	N/R	566-205	N/R	N/R	N/R
Skyhawk							
1989-82		566-089	N/R	566-226	N/R	N/R	N/R
1980-75		N/A	N/R	N/A	N/R	N/R	N/R
Skylark, Somerset, Special, Sportwagon							
1998-80		566-089	N/R	566-226	N/R	N/R	N/R
1979-63		566-065	N/R	566-205	N/R	N/R	N/R
Terraza							
2007-05		566-144	566-144	N/R	N/R	N/R	N/R

CADILLAC

Allante							
1993		566-144	N/R	N/R	N/R	N/R	N/R
1992-90		566-095	N/R	566-228	N/R	N/R	N/R
1989-87		566-095	N/R	566-227	N/R	N/R	N/R
Cimarron							
1988-82		566-089	N/R	566-205	N/R	N/R	N/R
CTS (11-03), DeVille, DeVille Concours, DTS (11-06), STS (11-05), XLR (09-04)							
2011-93	Exc: HD suspension	566-144	N/R	N/R	N/R	N/R	N/R
1999-91	HD, Hoarse, Limo	566-095	N/R	N/R	N/R	N/R	N/R
1992		566-144	N/R	566-228	N/R	N/R	N/R
1991-85		566-095	N/R	566-228	N/R	N/R	N/R
1984-67		566-065	N/R	566-205	N/R	N/R	N/R
Eldorado							
2002-92		566-144	N/R	N/R	N/R	N/R	N/R
1991-90		566-095	N/R	566-228	N/R	N/R	N/R
1989-86		566-095	N/R	566-227	N/R	N/R	N/R
1985-79		N/A	N/R	566-227	N/R	566-149	N/R
Fleetwood (FWD)							
1993		566-144	N/R	N/A	N/R	N/R	N/R
1992		566-144	N/R	566-228	N/R	N/R	N/R
1991	w/ HD brakes	566-095	N/R	566-228	N/R	N/R	N/R
1991-85	Inc: 91 w/o HD brakes	566-095	N/R	566-227	N/R	N/R	N/R
Fleetwood (RWD)							
1996-67		566-065	N/R	566-205	N/R	N/R	N/R
Seville							
2004-92		566-144	N/R	N/R	N/R	N/R	N/R
1991-90		566-095	N/R	566-228	N/R	N/R	N/R
1989-86		566-095	N/R	566-227	N/R	N/R	N/R
1985-80		N/A	N/R	566-227	N/R	N/R	N/R

N/R – Not Required • N/A – Dealer Part

SPINDLE and AXLE NUTS ÉCROUS D'ESSIEU et FUSSE

Year Année	Application	Nut / Ecrous Location		Washer / Rondelle Location		Retainer / Retenue Location	
		Front Avant	Rear Arriere	Front Avant	Rear Arriere	Front Avant	Rear Arriere

CHEVROLET

Berretta (96-87), Cavalier (05-82), Corsica (96-87), Citation (85-80)

2005-82		566-089	N/R	566-226	N/R	N/R	N/R
---------	--	---------	-----	---------	-----	-----	-----

Camaro

1992-91		N/A	N/R	566-205	N/R	566-154	N/R
1990-67		566-065	N/R	566-205	N/R	N/R	N/R

Impala

2014-04		566-144	N/R	N/R	N/R	N/R	N/R
---------	--	---------	-----	-----	-----	-----	-----

Caprice, Impala, Impala SS, Kingswood, Townsman

1996-66	Inc: 69-68 w/o manual disc brakes	566-065	N/R	566-205	N/R	N/R	N/R
---------	-----------------------------------	---------	-----	---------	-----	-----	-----

Celebrity (See BUICK CENTURY)

Chevelle (73-64), Chevy II (69-64), El Camino (87-64), Malibu, Laguna (83-64), Nova (79-64) (See CAPRICE)

Corvette

2013-97		N/R	566-144	N/R	N/R	N/R	N/R
1996-84		N/R	N/A	N/R	566-227	N/R	566-149
1968-63		N/A	N/R	566-205	N/R	N/R	N/R

Cobalt (10-05), Equinox (12-05)

2012-05		566-144	566-089	N/R	566-266	N/R	N/R
---------	--	---------	---------	-----	---------	-----	-----

Lumina

1996-90		566-095	N/R	566-228	N/R	N/R	N/R
---------	--	---------	-----	---------	-----	-----	-----

Lumina APV

1996-92		566-144	N/R	N/R	N/R	N/R	N/R
1991-90		566-095	N/R	566-227	N/R	N/R	N/R

MonteCarlo

2007-04		566-144	N/R	N/R	N/R	N/R	N/R
1996-95		566-095	N/R	566-228	N/R	N/R	N/R
1988-70		566-065	N/R	566-205	N/R	N/R	N/R

Venture, Uplander (05)

2005-97		566-144	566-144	N/R	N/R	N/R	N/R
---------	--	---------	---------	-----	-----	-----	-----

CHRYSLER

300m (04-99), Concorde (04-93), LHS (01-94)

2004-93		566-144	N/R	N/A	N/A	N/A	N/A
---------	--	---------	-----	-----	-----	-----	-----

Cirrus

2000-95		566-079	N/R	566-217	N/R	566-080	N/R
---------	--	---------	-----	---------	-----	---------	-----

Cordoba

1983-75		566-072	N/R	N/A	N/R	566-073	N/R
---------	--	---------	-----	-----	-----	---------	-----

E Class, Executive Sedan

1984-83		566-079	566-072	566-217	566-261	566-080	566-073
---------	--	---------	---------	---------	---------	---------	---------

Fifth Avenue

1989-83		566-072	N/R	N/A	N/R	566-073	N/R
---------	--	---------	-----	-----	-----	---------	-----

Imperial (93-66), LeBaron, LeBaron GTC, LeBaron GTS (95-77)

1995-90		566-079	566-072	566-217	566-261	566-080	566-073
1983-66		566-072	N/R	N/A	N/R	566-073	N/R

Laser (86-84), TC Maserati (91-89)

1991-84		566-079	566-072	566-217	566-261	566-080	566-073
---------	--	---------	---------	---------	---------	---------	---------

NewYorker, Newport

1996-94		566-144	N/R	N/A	N/R	N/A	N/R
1993-83		566-079	566-072	566-217	566-261	566-080	566-073
1982-66		566-072	N/R	566-261	N/R	566-073	N/R

N/R – Not Required • N/A – Dealer Part

SPINDLE and AXLE NUTS ÉCROUS D'ESSIEU et FUSSE

Year Année	Application	Nut / Ecrous Location		Washer / Rondelle Location		Retainer / Retenue Location	
		Front Avant	Rear Arriere	Front Avant	Rear Arriere	Front Avant	Rear Arriere

CHRYSLER (Cont'd)

Sebring

1998-96	convertible	566-079	N/R	566-217	N/R	566-080	N/R
1998-96	Coupe	566-105	N/R	566-237	N/R	N/R	N/R

Town & Country, Voyager, Grand Voyager

2007-96	2WD	566-079	566-079	566-217	566-217	566-080	566-080
2007-96	4WD	566-079	566-079	566-217	566-217	566-080	N/R
1995	2WD Rear	566-079	566-072	566-217	566-261	566-073	566-080
1995	4WD Rear	566-079	566-079	566-217	566-261	566-080	N/R
1994-92	2WD Rear	566-079	566-072	566-217	566-261	566-080	566-073
1994-92	4WD Rear	566-079	566-079	566-217	566-217	566-080	566-073
1991-82		566-079	566-072	566-217	566-217	566-073	566-073
1991-66		566-072	N/R	566-261	N/R	566-073	N/R

DAIHATSU

Charade

1992-88		566-105	N/A	566-237	566-237	N/A	N/A
---------	--	---------	-----	---------	---------	-----	-----

DODGE

400, 600 (88-82), Aries (89-81), Daytona (93-84), Dynasty (93-88), Lancer (89-85), Shadow, Spirit (95-87)

1995-81		566-079	566-072	566-217	566-261	566-080	566-073
---------	--	---------	---------	---------	---------	---------	---------

Avenger (98-95), Stealth (96-91)

1998-91		566-105	N/R	566-237	N/R	N/R	N/R
---------	--	---------	-----	---------	-----	-----	-----

Caravan, Grand Caravan, Mini Ram Van (See CHRYSLER TOWN & COUNTRY)

Charger

1987-83		566-079	566-072	566-217	566-261	566-080	566-073
1978-66		566-072	N/R	566-261	N/R	566-073	N/R

Colt, Colt Vista

1994-91		566-105	N/A	566-237	N/R	N/R	N/R
1990-89	DL Model	566-105	N/A	566-237	N/A	N/R	N/A
1990-89	Exc: DL Model Rear	566-105	N/A	566-237	N/R	N/R	N/R
1988-85		566-105	N/R	566-237	N/R	N/R	N/R
1984-81		566-105	N/A	566-237	N/A	N/R	N/A

Diplomat (89-77), Magnum, Mirada (83-78), St Regis (81-79)

1989-78		566-072	N/R	566-261	N/R	566-073	N/R
---------	--	---------	-----	---------	-----	---------	-----

Intrepid (See CHRYSLER CONCORDE)

Neon

2005-00		566-079	N/R	566-217	N/R	566-080	N/R
---------	--	---------	-----	---------	-----	---------	-----

Omni, Rampage

1990-79		566-079	566-072	566-217	566-261	566-080	566-261
---------	--	---------	---------	---------	---------	---------	---------

Stratus (99-95) (See CHRYSLER CIRRUS)

EAGLE

Summit

1996-89		566-105	N/A	566-237	N/R	N/R	N/R
---------	--	---------	-----	---------	-----	-----	-----

Talon

1998		566-105	N/R	566-237	N/R	N/R	N/R
1997-95		566-105	566-105	566-237	566-237	N/R	N/R
1994-90		566-105	N/R	566-237	N/R	N/R	N/R

Vision

1997-93		566-144	N/R	N/A	N/R	N/A	N/R
---------	--	---------	-----	-----	-----	-----	-----

N/R – Not Required • N/A – Dealer Part

SPINDLE and AXLE NUTS ÉCROUS D'ESSIEU et FUSSE

Year Année	Application	Nut / Ecrous Location		Washer / Rondelle Location		Retainer / Retenue Location	
		Front Avant	Rear Arriere	Front Avant	Rear Arriere	Front Avant	Rear Arriere

FORD

Cobra

1971-70		566-074	N/R	N/A	N/R	566-075	N/R
1969		566-072	N/R	566-205	N/R	566-073	N/R

Crown Victoria, Country Squire, Country Sedan, Custom, Custom 500

2011-92		566-098	N/R	N/R	N/R	N/R	N/R
1991-70		566-074	N/R	N/A	N/R	566-075	N/R
1969-65		566-072	N/R	566-205	N/R	566-073	N/R

Escort, EXP

2002-91		566-097	566-097	N/R	N/R	N/R	N/R
1990		566-094	566-101	566-226	566-229	N/R	N/R
1989-84		566-094	566-101	566-226	566-229	N/R	566-102
1983-81		566-094	N/R	566-226	N/A	N/R	N/A

Fairmont (83-78) (See CROWN VICTORIA)

Festiva

1993-90		566-145	N/A	566-215	N/A	N/R	N/R
1989-88	from 2/1/89	566-145	N/A	566-215	N/A	N/R	N/R

Galaxie, Galaxie 500 (74-65) (See CROWN VICTORIA)

Gran Torino (76-72) (See CROWN VICTORIA)

Granada (82-75) (See CROWN VICTORIA)

LTD, LTD II (86-67) (See CROWN VICTORIA)

Maverick (77-70) (See CROWN VICTORIA)

Mustang

2014-94		566-098	N/R	N/R	N/R	N/R	N/R
1993-70		566-074	N/R	N/A	N/R	566-075	N/R
1969-67		566-072	N/R	566-205	N/R	566-073	N/R

Probe

1997-89		566-097	566-097	N/R	N/R	N/R	N/R
---------	--	---------	---------	-----	-----	-----	-----

Ranch Wagon (76-65) (See CROWN VICTORIA)

Ranchero (79-65) (See CROWN VICTORIA)

Taurus

2013-99		566-089	566-089	N/R	N/R	N/R	N/R
1998-90		566-089	566-099	566-226	N/R	N/R	N/R
1989-86		566-089	566-101	566-226	566-229	N/R	566-102

Tempo

1994-84		566-094	566-101	N/R	566-229	N/R	566-102
---------	--	---------	---------	-----	---------	-----	---------

Thunderbird

1997-89		566-098	N/A	N/R	N/R	N/R	N/R
1988-70		566-074	N/R	N/A	N/R	566-075	N/R
1969-55		566-072	N/R	566-205	N/R	566-073	N/R

Torino (76-68) (See CROWN VICTORIA)

GEO

Prizm

1997-92		566-119	N/R	N/R	N/R	N/A	N/R
1991-89	29mm Nut	566-119	N/R	N/R	N/R	N/A	N/R

N/R – Not Required • N/A – Dealer Part

SPINDLE and AXLE NUTS ÉCROUS D'ESSIEU et FUSSE

Year Année	Application	Nut / Ecrous Location		Washer / Rondelle Location		Retainer / Retenue Location	
		Front Avant	Rear Arriere	Front Avant	Rear Arriere	Front Avant	Rear Arriere

HONDA

Accord

2008-98	Std trans uses 566-110 *Auto trans*	566-091	N/R	N/R	N/R	N/R	N/R
1997-92	4 cyl. exc. wagon	566-110	566-091	N/R	566-234	N/R	N/R
1997-92	4 cyl. wagon	566-110	566-110	N/R	N/A	N/R	N/R
1997-92	V6 Sedan	566-110	566-110	N/R	N/A	N/R	N/R
1991-89		566-110	566-091	N/R	566-234	N/R	N/R
1988-86		566-091	566-091	N/R	566-234	N/R	N/R
1985-80		566-091	N/A	N/R	N/A	N/R	N/R

Civic, Civic Del Sol, CRX, Wagovan (89-82)

2013-84		566-091	566-091	N/R	566-234	N/R	N/R
1983-80		566-091	N/A	N/R	N/A	N/R	N/R

CR-V, Element (11-03)

2012-97		566-110	566-091	N/R	N/R	N/R	N/R
---------	--	---------	---------	-----	-----	-----	-----

Insight

2013-00		566-091	N/R	N/R	N/R	N/R	N/R
---------	--	---------	-----	-----	-----	-----	-----

Odyssey (12-95), S2000 (05-00), Pilot (13-03)

2005-98	Inc: 05 Pilot	566-110	N/R	N/R	N/R	N/R	N/R
1998-96	Inc: 04-03 Pilot	566-110	566-110	N/R	N/A	N/R	N/R
1995		566-110	566-091	N/R	N/A	N/R	N/R

Prelude

2001-97		566-110	N/R	N/R	N/R	N/R	N/R
1996-92		566-110	566-110	N/R	566-234	N/R	N/R
1991-90		566-110	566-110	N/R	N/A	N/R	N/R
1989-88		566-091	566-110	N/R	N/A	N/R	N/R
1987-79		566-091	N/A	N/R	N/A	N/A	N/A

HYUNDAI

Accent

2012-95		566-105	N/R	566-237	N/R	N/R	N/R
---------	--	---------	-----	---------	-----	-----	-----

Elantra (12-92) (See SONATA)

Excel (94-87), Scoupe (95-91)

1995-87		566-105	N/A	566-237	N/R	N/R	N/R
---------	--	---------	-----	---------	-----	-----	-----

Sonata (14-89), Tiburon (08-97), Tucson (14-05), Santa Fe (14-01), XG350 (05-01)

2014-92		566-105	N/R	566-237	N/R	N/R	N/R
1991-89		566-105	N/A	566-237	N/R	N/R	N/R

INFINITI

G20, I30 (99-96)

2001-99		566-113	N/R	566-227	N/R	566-149	N/R
1996-91	G20	566-079	566-150	566-227	N/A	566-149	N/R
1998-96	I30	566-113	566-150	566-227	N/A	566-149	N/R

J30

1997-93		N/R	566-113	N/R	566-227	N/R	566-149
---------	--	-----	---------	-----	---------	-----	---------

Q45

2001-97		N/R	566-113	N/R	566-227	N/R	566-149
1996-90		N/R	N/A	N/R	566-227	N/R	566-149

N/R – Not Required • N/A – Dealer Part

SPINDLE and AXLE NUTS ÉCROUS D'ESSIEU et FUSSE

Year Année	Application	Nut / Ecrous Location		Washer / Rondelle Location		Retainer / Retenue Location	
		Front Avant	Rear Arriere	Front Avant	Rear Arriere	Front Avant	Rear Arriere

LEXUS

ES300

1998-92		566-119	N/R	N/R	N/R	566-151	N/R
---------	--	---------	-----	-----	-----	---------	-----

LINCOLN

Continental

2002-90		566-089	566-099	566-226	N/R	N/R	N/R
1989-88		566-089	566-101	566-226	566-229	N/R	N/R
1987-70		566-074	N/R	N/A	N/R	566-075	N/R
1969-65		566-072	N/R	566-205	N/R	566-073	N/R

Mark Series

1998-93		566-098	N/A	N/R	N/R	N/R	N/R
1992-70		566-074	N/R	N/A	N/R	566-075	N/R

Navigator 2WD (02-98), Blackwood (04-02)

2004-98		566-072	N/R	566-233	N/R	566-073	N/R
---------	--	---------	-----	---------	-----	---------	-----

Town Car

2011-91		566-098	N/R	N/R	N/R	N/R	N/R
1990-82		566-074	N/R	N/R	N/R	566-075	N/R

MAZDA

3 (13-04), 5 (13-06), 6 (13-03), MPV (05-00)

2013-00		566-097	N/A	N/R	N/R	N/R	N/R
---------	--	---------	-----	-----	-----	-----	-----

323

1995-90		566-097	566-097	N/R	N/R	N/R	N/R
1989	from VIN 361094	566-145	N/R	566-215	N/R	N/R	N/R

626

2002-88		566-097	566-097	N/R	N/R	N/R	N/R
---------	--	---------	---------	-----	-----	-----	-----

Miata

2005-99		566-145	566-097	N/R	N/R	N/R	N/R
1997-90		566-145	566-145	N/R	N/R	N/R	N/R

Millenia (02-95), Protege (03-90)

2003-90		566-097	566-097	N/R	N/R	N/R	N/R
---------	--	---------	---------	-----	-----	-----	-----

MX-3, MX-6

1997-88		566-097	566-097	N/R	N/R	N/R	N/R
---------	--	---------	---------	-----	-----	-----	-----

MERCURY

Bobcat (80-75), Capri (86-79), Colony Park, Brougham, Commuter (91-70), Comet, Cyclone (77-71)

1991-70		566-074	N/R	N/A	N/R	566-075	N/R
---------	--	---------	-----	-----	-----	---------	-----

Cougar

1997-89		566-098	N/A	N/R	N/R	N/R	N/R
1988-70		566-074	N/R	N/A	N/R	566-075	N/R
1969-67		566-072	N/R	566-205	N/R	566-073	N/R

Grand Marquis, Maurader (03)

2011-92	Exc: Twin Turbo	566-098	N/R	N/R	N/R	N/R	N/R
1991-75		566-074	N/R	N/A	N/R	566-075	N/R

Lynx

1983-91		566-094	N/A	566-226	N/A	N/R	N/A
---------	--	---------	-----	---------	-----	-----	-----

Lynx, LN7

1987-84	4WD	566-094	566-101	566-226	566-229	N/R	566-102
---------	-----	---------	---------	---------	---------	-----	---------

N/R – Not Required • N/A – Dealer Part

SPINDLE and AXLE NUTS ÉCROUS D'ESSIEU et FUSSE

Year Année	Application	Nut / Ecrous Location		Washer / Rondelle Location		Retainer / Retenue Location	
		Front Avant	Rear Arrière	Front Avant	Rear Arrière	Front Avant	Rear Arrière

MERCURY (Cont'd)

Marquis, Marauder, Montclair, Monterey, Parklane (See COLONY PARK)

Monarch (See BOBCAT)

Montego (See COUGAR)

Mountaineer 2WD

2010-97		566-072	N/R	N/A	N/R	566-073	N/R
---------	--	---------	-----	-----	-----	---------	-----

Sable, Monterey (07-04)

2009-99		566-089	566-089	566-226	566-266	N/R	N/R
1998-90		566-089	566-099	566-226	N/R	N/R	N/R
1989-86		566-089	566-101	566-226	566-229	N/R	566-102

Topaz

1994-84		566-094	566-101	566-226	566-229	N/R	566-102
---------	--	---------	---------	---------	---------	-----	---------

Tracer

1999-91		566-097	566-097	N/R	N/R	N/R	N/R
---------	--	---------	---------	-----	-----	-----	-----

Villager

1998-93		566-132	566-132	N/A	N/A	N/R	N/R
---------	--	---------	---------	-----	-----	-----	-----

Zephyr (See COUGAR)

MITSUBISHI

3000GT

1999-91		566-105	N/R	566-237	N/R	N/R	N/R
---------	--	---------	-----	---------	-----	-----	-----

Cordia

1988-83		566-105	N/A	566-237	N/A	N/R	N/A
---------	--	---------	-----	---------	-----	-----	-----

Diamante

2004-92		566-105	N/R	566-237	N/R	N/R	N/R
---------	--	---------	-----	---------	-----	-----	-----

Eclipse, Endeavor (11-04)

2012-95		566-105	566-105	566-237	566-237	N/R	N/R
1994-90		566-105	N/R	566-237	N/R	N/R	N/R

Expo, Expo LRV

1995-92		566-105	566-105	566-237	566-237	N/R	N/R
---------	--	---------	---------	---------	---------	-----	-----

Galant, Lancer (12-02)

2012-94		566-105	N/R	566-237	N/R	N/R	N/R
1993-85		566-105	N/A	566-237	N/A	N/R	N/A

Mirage

2002-89		566-105	N/A	566-237	N/R	N/R	N/R
1988-85		566-105	N/R	566-237	N/R	N/R	N/R

Precis, Sigma, Tredia (See GALANT)

NISSAN

200SX

1998-95		566-079	N/A	566-217	N/A	N/A	N/R
---------	--	---------	-----	---------	-----	-----	-----

240SX

1998-95		N/R	566-113	N/R	566-227	N/R	566-149
1994-89		N/A	566-113	N/A	566-227	N/A	566-149

240Z, 260Z, 280Z, 280ZX, 300ZX

1996-90	Exc: Twin Turbo	N/R	566-113	N/R	566-227	N/R	566-149
---------	-----------------	-----	---------	-----	---------	-----	---------

Altima

2001-98		566-113	N/R	566-227	N/R	N/R	N/R
1997-93		566-113	N/A	566-227	N/A	566-149	N/R

N/R – Not Required • N/A – Dealer Part

SPINDLE and AXLE NUTS ÉCROUS D'ESSIEU et FUSSE

Year Année	Application	Nut / Ecrous Location		Washer / Rondelle Location		Retainer / Retenue Location	
		Front Avant	Rear Arriere	Front Avant	Rear Arriere	Front Avant	Rear Arriere

NISSAN (Cont'd)

Axxess							
1990	4WD	566-113	566-113	566-227	566-227	566-149	566-149
Maxima							
1999-97		566-113	N/A	566-227	N/A	566-149	N/R
1996-89		566-113	566-150	566-227	N/A	566-149	N/R
1988-85		566-113	N/A	566-227	N/A	566-149	566-073
NX1600, NX2000							
1993-91		566-079	566-150	566-217	N/A	N/A	N/R
Pulsar, Pulsar NX							
1990-87		566-079	566-150	566-217	N/A	N/A	N/A
Quest							
2001-97		566-132	566-132	566-227	N/A	N/R	N/R
1996-93		566-132	566-132	566-227	N/A	566-149	N/R
Sentra							
2000-91		566-079	566-150	566-217	N/A	N/A	N/R
1990-87	4WD	566-079	566-113	566-217	566-227	N/A	566-149
Stanza							
1992-90		566-113	N/A	566-227	N/A	566-149	N/R
1989-86	4WD, Wagon	566-113	566-113	566-227	566-227	566-149	566-149

OLDSMOBILE

88							
1999-92		566-144	N/R	N/R	N/R	N/R	N/R
1991-89		566-095	N/R	566-227	N/R	N/R	N/R
98							
1996-92		566-144	N/R	N/R	N/R	N/R	N/R
1991-85		566-095	N/R	566-227	N/R	N/R	N/R
1984-71		566-065	N/R	566-205	N/R	N/R	N/R
Achieva							
1998-92		566-089	N/R	566-226	N/R	N/R	N/R
Aurora (03-95), Alero (04-99), Bravada (04-91)							
2004-91		566-144	N/R	N/R	N/R	N/R	N/R
Calais, Cutlass, Ciera							
1991-85		566-089	N/R	566-226	N/R	N/R	N/R
1984-78		566-065	N/R	566-205	N/R	N/R	N/R
Ciera, Cutlass Ciera							
1996-94		566-144	N/R	N/R	N/R	N/R	N/R
1993-92	w/ HD brakes	566-095	N/R	566-227	N/R	N/R	N/R
1993-82	w/o HD brakes	566-089	N/R	566-226	N/R	N/R	N/R
Custom Cruiser							
1992-71		566-065	N/R	566-205	N/R	N/R	N/R
Cutlass, Cutlass Cruiser							
1987-65		566-065	N/R	566-205	N/R	N/R	N/R
Cutlass Supreme							
1996-88	FWD	566-095	N/R	566-228	N/R	N/R	N/R
1988-71	RWD	566-065	N/R	566-205	N/R	N/R	N/R
Delta88, Delmont88, Dynamic (See 98)							
Firenza							
1988-82		566-089	N/R	566-226	N/R	N/R	N/R

N/R – Not Required • N/A – Dealer Part

SPINDLE and AXLE NUTS ÉCROUS D'ESSIEU et FUSSE

Year Année	Application	Nut / Ecrous Location		Washer / Rondelle Location		Retainer / Retenue Location	
		Front Avant	Rear Arriere	Front Avant	Rear Arriere	Front Avant	Rear Arriere

OLDSMOBILE (Cont'd)

LSS (See 88)

Omega

1984-80		566-089	N/R	566-226	N/R	N/R	N/R
1979-73		566-065	N/R	566-205	N/R	N/R	N/R

Silhouette, Intrigue (02-98)

2004-92		566-144	N/R	N/R	N/R	N/R	N/R
1991-90		566-095	N/R	566-227	N/R	N/R	N/R

Toronado, Trofeo

1992		566-144	N/R	N/R	N/R	N/R	N/R
1991-90		566-095	N/R	566-228	N/R	N/R	N/R
1989-86		566-095	N/R	566-227	N/R	N/R	N/R

PLYMOUTH

Acclaim

1995-89		566-079	566-072	566-217	N/A	N/A	566-073
---------	--	---------	---------	---------	-----	-----	---------

Barracuda

1974-66		566-072	N/R	N/A	N/R	566-073	N/R
---------	--	---------	-----	-----	-----	---------	-----

Breeze

2000-96		566-079	N/R	566-217	N/R	566-080	N/R
---------	--	---------	-----	---------	-----	---------	-----

Caravelle

1988-85		566-079	566-072	566-217	N/A	566-080	566-073
---------	--	---------	---------	---------	-----	---------	---------

Colt, Colt, Vista

1994-92	SE model, 4WD	566-105	566-105	566-237	566-237	N/R	N/R
1991		566-105	N/A	566-237	N/R	N/R	N/R
1990-89		566-105	N/A	566-237	N/A	N/R	N/A
1988-85		566-105	N/R	566-237	N/R	N/R	N/R
1984-83		566-105	N/A	566-237	N/A	N/R	N/A

Fury, Fury I/II/III, GranFury

1989-66		566-072	N/R	N/A	N/R	566-073	N/R
---------	--	---------	-----	-----	-----	---------	-----

Horizon

1990-79		566-079	566-072	566-217	N/A	566-080	566-073
---------	--	---------	---------	---------	-----	---------	---------

Laser (94-90) (See COLT)

Neon

2001-95		N/A	N/R	N/A	N/R	566-080	N/R
---------	--	-----	-----	-----	-----	---------	-----

Prowler

2001-97		566-144	N/R	N/R	N/R	N/R	N/R
---------	--	---------	-----	-----	-----	-----	-----

Reliant (89-81) (See HORIZON)

Sundance

1994-87		566-079	566-072	566-217	N/A	566-080	566-023
---------	--	---------	---------	---------	-----	---------	---------

Volare (80-76) (See FURY)

Voyager, Grand Voyager

2001-96	2WD	566-079	566-079	566-217	566-217	566-080	566-080
2001-96	4WD	566-079	566-079	566-217	566-217	566-080	N/R
1995-91	2WD	566-079	566-072	566-217	N/A	566-080	566-073
1995-91	4WD	566-079	566-079	566-217	566-217	566-080	566-080
1990-84		566-079	566-072	566-217	N/A	566-080	566-073

N/R – Not Required • N/A – Dealer Part

SPINDLE and AXLE NUTS ÉCROUS D'ESSIEU et FUSSE

Year Année	Application	Nut / Ecrous Location		Washer / Rondelle Location		Retainer / Retenue Location	
		Front Avant	Rear Arriere	Front Avant	Rear Arriere	Front Avant	Rear Arriere

PONTIAC

6000

1991-82	w/ HD brakes	566-095	N/R	566-227	N/R	N/R	N/R
1991-82	w/o HD brakes	566-089	N/R	566-226	N/R	N/R	N/R

Aztec

2005-01		566-144	566-144	N/R	N/R	N/R	N/R
---------	--	---------	---------	-----	-----	-----	-----

Bonneville, Catalina, Executive

2005-92		566-144	N/R	N/R	N/R	N/R	N/R
1991-87		566-095	N/R	566-227	N/R	N/R	N/R
1986-67		566-065	N/R	566-205	N/R	N/R	N/R

Fiero

1987-84		N/A	566-089	N/A	566-226	N/R	N/R
---------	--	-----	---------	-----	---------	-----	-----

Firebird (See CHEVROLET CAMARO)

Grand AM, Grand Lemans, GTO

1998-85		566-089	N/R	N/R	N/R	N/R	N/R
1981-67		566-065	N/R	N/R	N/R	N/R	N/R

Grand Prix

2008-04		566-144	N/R	N/R	N/R	N/R	N/R
1996-88		566-095	N/R	N/R	N/R	N/R	N/R
1987-67		566-065	N/R	566-205	N/R	N/R	N/R

J2000 (See 6000)

Lemans

1993-88		N/A	N/A	N/A	N/A	N/R	N/R
1981-67		566-065	N/R	566-205	N/R	N/R	N/R

Montana

2005-99		566-144	566-144	N/R	N/R	N/R	N/R
---------	--	---------	---------	-----	-----	-----	-----

Parisienne

1986-83		566-065	N/R	566-205	N/R	N/R	N/R
---------	--	---------	-----	---------	-----	-----	-----

Phoenix

1984-80		566-089	N/R	566-226	N/R	N/R	N/R
1979-77		566-065	N/R	566-205	N/R	N/R	N/R

Safari

1989-87		566-065	N/R	566-205	N/R	N/R	N/R
---------	--	---------	-----	---------	-----	-----	-----

Sunbird, Sunfire, J2000

2005-82		566-089	N/R	566-226	N/R	N/R	N/R
---------	--	---------	-----	---------	-----	-----	-----

N/R – Not Required • N/A – Dealer Part

SPINDLE and AXLE NUTS ÉCROUS D'ESSIEU et FUSSE

Year Année	Application	Nut / Ecrous Location		Washer / Rondelle Location		Retainer / Retenue Location	
		Front Avant	Rear Arrière	Front Avant	Rear Arrière	Front Avant	Rear Arrière

CHEVROLET/GMC TRUCK-2WD

Astro 2WD

2002-85		566-065	N/R	566-205	N/R	N/R	N/R
---------	--	---------	-----	---------	-----	-----	-----

Astro 4WD

2005-90		566-095	N/R	N/R	N/R	N/R	N/R
---------	--	---------	-----	-----	-----	-----	-----

Blazer 2WD

1984-73		566-065	N/R	566-205	N/R	N/R	N/R
---------	--	---------	-----	---------	-----	-----	-----

C, R10/15/1500 Pickup, P20/25 Forward Control Van

2000-87	Rect. Hdlights	566-148	N/R	566-232	N/R	N/R	N/R
1988-73	Rnd. Hdlights	566-057	N/R	566-207	N/R	N/R	N/R

C, R20/25/2500, Suburban, Savana 1500/2500/3500 Van

2002-88		566-148	N/R	566-232	N/R	N/R	N/R
1989-73		566-057	N/R	566-207	N/R	N/R	N/R

C, R30, 35, 3500 Pickup, Express 1500, 2500, 3500 Van (02-96), P30/35 Forward Control Van

2002-92	w/o 15, 000lb GVWR	566-148	N/R	566-232	N/R	N/R	N/R
2000-92	w/ 15, 000lb GVWR	566-057	N/R	566-207	N/R	N/R	N/R
1991-88	Rect. Hdlights	566-148	N/R	566-232	N/R	N/R	N/R
1991-73	Rnd. Hdlights	566-057	N/R	566-207	N/R	N/R	N/R

Caballero

1987-78		566-065	N/R	566-205	N/R	N/R	N/R
---------	--	---------	-----	---------	-----	-----	-----

G10/15/1500 Van

1995	27/32-20 Nut	566-057	N/R	566-207	N/R	N/R	N/R
1995-73	3/4-20 Nut	566-065	N/R	566-205	N/R	N/R	N/R

G20/25/2500 Van

1995-84	27/32-20 Nut	566-057	N/R	566-207	N/R	N/R	N/R
1995-80	3/4-20 Nut	566-065	N/R	566-205	N/R	N/R	N/R

G30/35/3500 Van

1996-73		566-057	N/R	566-207	N/R	N/R	N/R
---------	--	---------	-----	---------	-----	-----	-----

S10/15 Blazer, Jimmy, S10/15 Pickup, Sonoma (02-82), Safari 2WD (02-85)

2002-83		566-065	N/R	566-205	N/R	N/R	N/R
---------	--	---------	-----	---------	-----	-----	-----

Tahoe, Yukon

2000-95		566-148	N/R	566-232	N/R	N/R	N/R
---------	--	---------	-----	---------	-----	-----	-----

DODGE TRUCK-2WD

B100, 150, 1500 Ram, 1500 Van, B200, 250, 2500 Ram, 2500 Van, B300, 350, 3500 Ram, 3500 Van, CB300 Cutaway Cab, D100/150 Pickup, D200/250 Pickup, D300/350 Pickup, D400/450 Conventional Cab

2003-71		566-072	N/R	N/A	N/R	566-073	N/R
---------	--	---------	-----	-----	-----	---------	-----

Dakota (96-87), Ram 1500 Pickup (99-94), Ramcharger (93-74)

1998-74		566-072	N/R	N/A	N/R	566-073	N/R
---------	--	---------	-----	-----	-----	---------	-----

N/R – Not Required • N/A – Dealer Part

SPINDLE and AXLE NUTS ÉCROUS D'ESSIEU et FUSSE

Year Année	Application	Nut / Ecrous Location		Washer / Rondelle Location		Retainer / Retenue Location	
		Front Avant	Rear Arrière	Front Avant	Rear Arrière	Front Avant	Rear Arrière

FORD TRUCK-2WD

Aerostar, Bronco II-2WD

1997-84		566-072	N/R	566-233	N/R	566-073	N/R
---------	--	---------	-----	---------	-----	---------	-----

E100/150 Econoline, E200/250/300/350 Econoline (03-69), F100/150 Pickup-2WD, F250 Pickup Superduty, F350 Pickup Superduty, F450/550 Superduty

2012-87		566-072	N/R	566-233	N/R	566-073	N/R
1986-75		566-072	N/R	566-219	N/R	566-073	N/R

Expedition, Explorer, Excursion (05-00)

2013-91		566-072	N/R	566-233	N/R	566-073	N/R
1989-87		566-072	N/R	566-219	N/R	566-073	N/R

Ranger

2011-83	from 7/18/83	566-072	N/R	566-233	N/R	566-073	N/R
1983	to 7/17/83	566-072	N/R	566-219	N/R	566-073	N/R

Windstar

2003-99		N/R	566-099	N/R	N/R	N/R	N/R
1998-97	rear from 8/6/97	566-089	566-099	566-226	N/R	N/R	N/R
1997-95	to 8/5/97	566-089	566-101	566-226	566-229	N/R	566-102

JEEP-2WD

Cherokee, Comanche

1992-86	Type 2	566-072	N/R	566-233	N/R	566-073	N/R
---------	--------	---------	-----	---------	-----	---------	-----

MAZDA TRUCK

B2300, B2500, B3000, B4000, Pickup

2010-94		566-072	N/R	566-233	N/R	566-073	N/R
---------	--	---------	-----	---------	-----	---------	-----

PLYMOUTH TRUCK

PB100/150, PB200/250, PB300/350, Voyager Van, Trailduster

1983-74		566-072	N/R	N/A	N/R	566-073	N/R
---------	--	---------	-----	-----	-----	---------	-----

IMPORTANT:

- Follow all manufacturer's specifications for installation, adjustment and torquing.
- Some provinces now require that even the prevailing torque/nylon insert nut be replaced and not reused.
- Spindle/axle nuts are an integral part of any suspension, CV joint, brake and wheel bearing repairs.
- Some applications will require specialty (deep) sockets for the removal and installation of some nuts.

REMARQUES IMPORTANTES:

- Il faut toujours se conformer aux directives du manufacturier lorsqu'on procède à l'installation d'une pièce, à l'ajustement d'une pièce, ou au serrage d'une pièce.
- Dorénavant, quelques provinces exigent que même la vis trilobée et l'insert en nylon soient remplacés: ils ne doivent jamais être réutilisés.
- Le remplacement de l'écrou d'opercule et de l'écrou de fusée fait partie intégrante de l'entretien et réparation de toute suspension, de tout joint homocinétique ("CV") et de tout coussinet à frein.
- Certaines applications nécessiteront des douilles longues (de spécialité) pour retirer et réinstaller divers types d'écrou.

N/R – Not Required • N/A – Dealer Part

SPINDLE and AXLE NUTS ÉCROUS D'ESSIEU et FUSSE

Year Année	Description	Nut / Ecrous Location		Washer Retenue	Retainer Retenue
		Inner / Interne	Outer / Externe		

CHEVROLET/GMC TRUCK-4WD

Avalanche, Blazer, Express Jimmy-4WD, Suburban, Safari, Savana, Sierra, Silverado, Tahoe, Yukon

2003-92		N/R	566-095	566-227	N/R
1991-81		566-120	566-120	N/R	566-241
1980-69		566-120	566-120	N/R	566-240

K, V10/15/1500 Pickup-4WD, K, V20/25/2500 Pickup-4WD, K, V30/35/3500 Pickup-4WD

2000-88		N/R	566-095	N/R	N/R
1987-81		566-120	566-120	N/R	566-241
1981-67		566-120	566-120	N/R	566-240

S10/15 Blazer, Jimmy, Pickup, Sonoma-4WD, Syclone, Typhoon

2001-96	21mm high nut	N/R	566-095	566-227	N/R
1996-82	14mm high nut	N/R	566-113	566-227	566-149

DODGE TRUCK-4WD

Ramcharger, W100/150 Pickup-4WD

1993-84		566-120	566-120	N/R	566-240
---------	--	---------	---------	-----	---------

W200/250 Pickup-4WD

1993-92	4500lb axle	566-122	566-122	N/R	566-242
1993-84	3500lb axle	566-120	566-120	N/R	566-240

W300/350 Pickup-4WD

1993-92		566-122	566-122	N/R	566-242
---------	--	---------	---------	-----	---------

Dakota, Durango

2000-91		N/R	N/R	N/R	566-080
1990-88		N/R	566-079	566-227	566-080

FORD TRUCK-4WD

Bronco-4WD

1996-81	w/ auto lock hubs	566-120	566-120	N/R	566-241
1994-90	w/ manual lock hubs	566-128	566-128	N/R	N/R
1989-83	All	566-120	566-120	N/R	566-241
1982-66	All	566-120	566-120	N/R	566-240

Bronco II-4WD

1990-84	w/ manual lock hubs	566-142	566-142	N/R	566-253
---------	---------------------	---------	---------	-----	---------

Explorer-4WD

1994-91	w/ manual lock hubs, 3:45 + 4:10 ratio	566-142	566-142	N/R	566-253
---------	--	---------	---------	-----	---------

F100/150 Pickup-4WD

1996-80	Exc: 94-86 manual lock hubs	566-120	566-120	N/R	566-241
1994-86	w/ manual lock hubs	566-128	566-128	N/R	N/R
1982-64	All	566-120	566-120	N/R	566-240

F250 Pickup-4WD

1998-91	3850lb axle	566-120	566-120	N/R	566-241
1998-88	4600lb axle	566-122	566-122	N/R	566-242
1991	3850lb w/ manual lock hubs	566-128	566-128	N/R	N/R
1987-86	4600lb 4:10 ratio	566-122	566-122	N/R	566-242
1986	4600lb 3:55 ratio to 9/30/85	566-122	566-122	N/R	566-242
1985-83	3800-3850lb axle	566-120	566-120	N/R	566-241
1982-81	3800lb w/ auto lock hubs	566-120	566-120	N/R	566-241
1982-81	3800lb w/ manual lock hubs	566-120	566-120	N/R	566-240
1980-78	3800-3850lb axle	566-120	566-120	N/R	566-240

N/R – Not Required

SPINDLE and AXLE NUTS ÉCROUS D'ESSIEU et FUSSE

Year Année	Description	Nut / Ecrous Location		Washer Retenue	Retainer Retenue
		Inner / Interne	Outer / Externe		

FORD TRUCK-4WD (Cont'd)

F350 Pickup-4WD

1997-87		566-122	566-122	N/R	566-242
1986-85	5000lb axle	566-122	566-122	N/R	566-242
1981	3800lb axle	566-120	566-120	N/R	566-240
1979	4500lb 4:09 ratio	566-120	566-120	N/R	566-240

Ranger

1994-90	3:45 ratio	566-142	566-142	566-253	N/R
1990	3:73 + 4:10 ratio	566-142	566-142	566-253	N/R
1989-83	w/ manual lock hubs	566-142	566-142	566-253	N/R

JEEP-4WD

Cherokee, Comanche-4WD, Wrangler (01-87)

2001-84		N/R	566-113	N/R	566-149
1983-74		566-120	566-120	566-240	N/R

Grand Cherokee

2000-93		N/R	566-113	566-227	566-149
---------	--	-----	---------	---------	---------

Grand Wagoneer-4WD

1998-87		566-120	566-120	566-240	N/R
---------	--	---------	---------	---------	-----

"J" Series, Gladiator Pickup-4WD

1988-74		566-120	566-120	566-240	N/R
---------	--	---------	---------	---------	-----

Wagoneer-4WD

1983-74		566-120	566-120	566-240	N/R
---------	--	---------	---------	---------	-----

N/R – Not Required

SPINDLE and AXLE NUTS ÉCROUS D'ESSIEU et FUSSE

Year Année	Description	Nut / Ecrous Location		Washer Retenue	Retainer Retenue
		Inner / Interne	Outer / Externe		

CHEVROLET/GMC-Floating Axle

C, K, R, V20/25/2500 Pickup, Suburban 2WD-4WD					
2002-80		566-132	566-141	N/R	566-140
C, R30 /35/3500 Pickup-2WD					
2002-92	w/ rear drum brakes	566-132	566-141	N/R	566-140
1991-80	Inc: 91 w/o 12" ring gear	566-132	566-141	N/R	566-140
Express 3500					
2005-96		566-132	566-141	N/R	566-140
K, V30/35/3500 Pickup -4WD, P20/25 Van					
2002-80		566-132	566-141	N/R	566-140
P30/35 Van					
1999-82	w/ rear drum brakes	566-132	566-141	N/R	566-140
1981-80	w/ 13" rear brakes	566-132	566-141	N/R	566-140
Savana, Silverado, Sierra 2500/3500 Pickup					
2005-96		566-132	566-141	N/R	566-140

FORD TRUCK-Floating Axle

E250, E350, E450 Econoline					
2005-90		566-133	N/R	N/R	N/R
1989-87	RH	566-133	N/R	N/R	N/R
1989-87	LH	566-134	N/R	N/R	N/R
Excursion					
2005-00	RH	566-133	N/R	N/R	N/R
2005-00	LH	566-134	N/R	N/R	N/R
F250 Pickup					
1999-87	RH	566-133	N/R	N/R	N/R
1999-85	LH	566-134	N/R	N/R	N/R
1986-85	w/ 10.25" ring gear RH	566-133	N/R	N/R	N/R
F250 Super Duty Pickup					
2005-99	RH	566-133	N/R	N/R	N/R
2005-99	LH	566-134	N/R	N/R	N/R
F350 Pickup					
1997-87	RH	566-133	N/R	N/R	N/R
1997-87	LH	566-134	N/R	N/R	N/R
1986-85	w/ 10.25" ring gear RH	566-133	N/R	N/R	N/R
F350 Super Duty Pickup					
2005-99	RH	566-133	N/R	N/R	N/R
2005-99	LH	566-134	N/R	N/R	N/R
F450 Super Duty Pickup					
1991-88	RH	566-133	N/R	N/R	N/R
1991-88	LH	566-134	N/R	N/R	N/R

N/R – Not Required



WHEEL BOLT and NUT ASSORTMENTS ASSORTIMENTS DE BOULON et ÉCROUS DE ROUE

MERCHANDISER No. 022-056

'Papco' 'Mega-Paks' are uniformly priced packages of the most popular inch & metric Wheel Bolts and Nuts. Each 'Mega-Pak' features an illustrated, colour coded label, suggested selling price and a double strength drawer box. 'Papco' 'Mega-Paks' are available individually or in a factory prepared Merchandiser No. 022-056 containing 35 sizes of the fastest selling sizes of GM, Ford, Chrysler and Import Wheel Parts.

- Sturdy, Heavy Gauge, Reinforced Steel Cabinet
- Use on Work Bench or Hang on Wall
- Colourful-Durable-Efficient
- Includes handy Bolt measuring Gauge

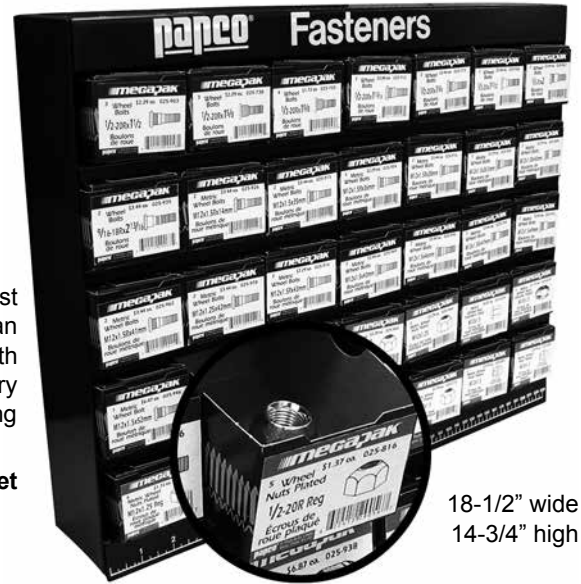

18-1/2" wide
14-3/4" high

WHEEL PARTS MERCHANDISER No. 022-056

Part No.	Cat. No.	Pcs.	Part No.	Cat. No.	Pcs.	Part No.	Cat. No.	Pcs.	Part No.	Cat. No.	Pcs.
025-714	(558-014)	8	025-777	(559-077)	4	025-838	(560-138)	4	025-945	(559-248)	4
025-716	(558-016)	6	025-800	(558-100)	3	025-848	(560-148)	4	025-948	(558-148)	4
025-718	(560-018)	3	025-803	(560-130)	4	025-850	(559-018)	7	025-950	(561-250)	3
025-727	(558-027)	6	025-808	(561-108)	3	025-854	(561-154)	3	025-951	(561-251)	4
025-734	(560-034)	4	025-809	(561-109)	4	025-855	(560-155)	5	025-955	(560-355)	2
025-744	(558-057)	2	025-810	(561-110)	5	025-863	(559-163)	2	025-961	(560-461)	2
025-747	(558-047)	3	025-814	(560-114)	4	025-872	(560-172)	2	025-972	(559-172)	4
025-760	(559-060)	5	025-822	(561-122)	4	025-873	(560-173)	2	025-986	(560-386)	4
025-764	(559-064)	4	025-825	(559-125)	4	025-904	(560-604)	3			



12" w. x 18" l. x 3" d.



9-3/4" w. x 13-3/4" l. x 2" d.



020-802

A 'Super-Service' Assortment containing 32 of the most popular Wheel Bolts and Nuts for GM, Ford, Chrysler, AMC and Imports.

CONTENTS OF THE ASSORTMENT No. 020-802

Part No.	Pcs	Part No.	Pcs	Part No.	Pcs
560-102	5	560-186	5	561-167	5
560-103	5	560-386	5	561-248	5
560-105	5	561-100	5	561-251	5
560-110	5	561-102	5	561-380	5
560-114	5	561-106	5	558-014	10
560-138	5	561-108	5	558-016	10
560-148	5	561-109	5	558-027	10
560-155	5	561-110	5	559-125	10
560-167	5	561-122	5	559-150	10
560-172	5	561-154	5		
560-173	5	561-166	5		

020-658

A Master Assortment containing 20 sizes of the most popular Wheel Bolts and Nuts for GM, Ford, Chrysler, AMC and Imports.

CONTENTS OF THE ASSORTMENT No. 020-658

Part No.	Pcs	Part No.	Pcs	Part No.	Pcs
560-103	5	560-173	5	561-248	5
560-114	5	560-386	5	561-251	5
560-138	5	561-108	5	558-014	10
560-148	5	561-109	5	558-016	10
560-155	5	561-110	10	558-027	10
560-167	5	561-122	5	559-150	10
560-172	5	561-154	5		

020-311

This Utility Assortment contains 8 sizes of the fastest moving 'Papco' Wheel Nuts.

CONTENTS OF THE ASSORTMENT No. 020-311

Part No.	Pcs	Part No.	Pcs	Part No.	Pcs
558-014	5	558-044	5	559-125	5
558-016	5	558-047	5	559-150	5
558-027	5	558-100	5		



CARDED WHEEL NUTS ÉCROUS DE ROUE SUR CARTE

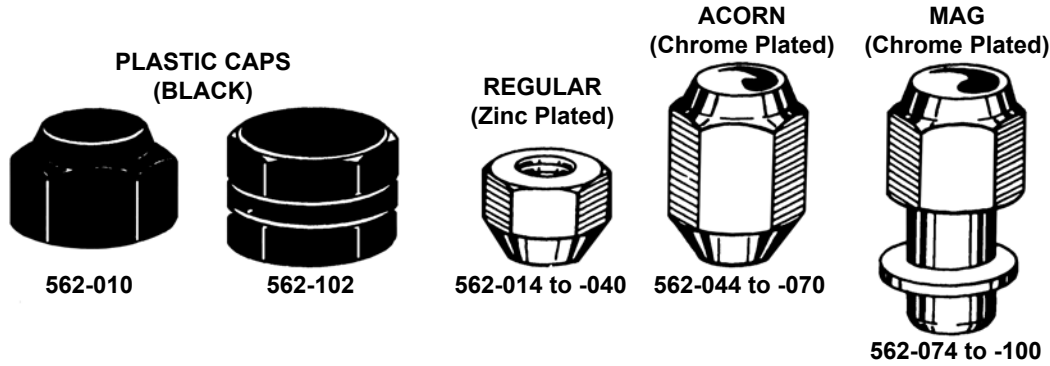

Inch Nuts & caps packed 5 pcs. per card

Card No.	Cat. No.	Size	Type	Application
562-010	Fits 13/16	Ford Nuts	Cap	Ford
562-012	Fits 3/4	Chrysler Nuts	Cap	Chrysler, GMC
562-014	(558-014)	7/16-20R	Reg.	Chrysler, GMC
562-016*	(558-016)	1/2-20R	Reg.	AMC, Ford, GMC
562-027**	(558-027)	1/2-20R	Reg.	Chrysler
562-035	(559-125)	M12 x 1.25R	Reg.	Datsun
562-040	(559-150)	M12 x 1.5R	Reg.	All
562-044*	(558-144)	7/16-20R	Acorn	Chrysler, GMC
562-045**	(558-140)	7/16-20R	Acorn	GMC
562-046	(558-146)	1/2-20R	Acorn	AMC, Ford, GMC
562-048*	(558-148)	1/2-20R	Acorn	AMC, Ford, GMC
562-060**	(559-060)	M10 x 1.25R	Acorn	Geo, GMC

Metric Nuts packed 4 pcs. per card

Card No.	Cat. No.	Size	Type	Application
562-063	(559-163)	M12 x 1.5R	Reg.	Chrysler, Imports
562-064	(559-064)	M12 x 1.25R	Reg.	Imports
562-065	(559-065)	M12 x 1.25R	Acorn	Datsun
562-070	(559-070)	M12 x 1.5R	Acorn	All
562-072	(559-172)	M12 x 1.5R	Reg.	Ford, Imports
562-074	(558-174)	7/16-20R	Mag	Chrysler, GMC
562-076	(558-176)	1/2-20R	Acorn	AMC, Ford, GMC
562-077	(559-077)	M12 x 1.5R	Mag	Imports
562-095	(559-095)	M12 x 1.25R	Mag	Datsun
562-100	(559-100)	M12 x 1.5R	Mag	All
562-154	(559-154)	M14 x 1.5R	Reg.	GM

* 13/16 AF Nuts, ** 3/4 AF Nuts - For dimensions of Wheel Nuts see page 2

CARDED WHEEL PARTS KIT PRÉSENTOIRS DE PIÈCES DE ROUE SUR CARTE

'Papco' Wheel Parts Kits provide 95% coverage of today's car and truck applications. Each Kit includes one Wheel Bolt and Nut skin-packed on an attractive, three colour, point-of-purchase display card. Each card features easy to follow installation instructions, application and illustration - plus a price code system for faster check-out service.



Card No.	Cat. No.	Size	Application
562-018	(560-018)	1/2-20R x 1-7/16	Trailer Bolt (2/card)
562-019	(560-019)	9/16-18R x 1-7/16	Trailer Bolt (2/card)
562-114	(560-114)	7/16-20R x 1-1/2	GMC & Truck, Jeep
562-126	(560-386)	7/16-20R x 1-5/16	GMC & Truck
562-138	(560-138)	1/2-20R x 1-5/8	GMC & Truck
562-155*	(560-155)	1/2-20R x 1-5/8	GMC & Truck
562-156**	(560-155)	1/2-20R x 1-5/8	Chrysler
562-172	(560-102)	1/2-20R x 1-5/8	AMC, Dodge Truck, Ford
562-173	(560-103)	1/2-20R x 1-1/2	Chrysler, Dodge Truck
562-175	(560-105)	1/2-20R x 1-13/16	AMC, Chrysler, Dodge
562-200	(561-100)	M12 x 1.25R x 39mm	Nissan Truck
562-201	(561-100)	M12 x 1.25R x 39mm	Nissan
562-204	(560-604)	7/16-20R x 1-3/4	GMC Truck, Jeep
562-206	(561-106)	M12 x 1.5R x 38.5mm	Dodge, Chrysler
562-208	(561-108)	M12 x 1.5R x 38.5mm	Dodge, Chrysler Truck
562-209	(561-109)	M12 x 1.5R x 40mm	Chrysler
562-210**	(560-110)	1/2-20R x 2	Chrysler, Dodge Truck
562-211*	(560-110)	1/2-20R x 2	Ford
562-214	(561-114)	M12 x 1.5R x 38mm	GM
562-226	(561-126)	M12 x 1.5R x 41mm	Geo, Toyota Truck
562-240	(561-140)	M12 x 1.5R x 37mm	Chrysler Imports
562-248	(560-148)	1/2-20R x 1-13/16	AMC, Ford, GMC, Intern.
562-249	(561-249)	M12 x 1.5R x 46mm	Ford
562-267	(560-167)	1/2-20R x 1-15/16	Ford
562-272	(560-172)	1/2-20R x 1-13/16	Ford & Truck
562-273	(560-173)	1/2-20R x 1-3/4	Ford & Truck

Card No.	Cat. No.	Size	Application
562-274	(561-174)	M12 x 1.25R x 34mm	Geo, Suzuki Truck
562-275	(561-175)	M12 x 1.5R x 46mm	GM
562-302	(561-102)	M12 x 1.25R x 39mm	Datsun/Nissan
562-306	(561-306)	M12 x 1.5R x 38.5mm	Chrysler, Renault
562-308	(561-108)	M12 x 1.5R x 38.5mm	GMC, Chrysler, Dodge
562-309	(561-109)	M12 x 1.5R x 40mm	Chrysler, Dodge Truck
562-310	(561-110)	M12 x 1.5R x 43mm	GMC & Truck
562-322	(561-122)	M12 x 1.5R x 36mm	GMC, Toyota
562-339	(561-139)	M12 x 1.5R x 37mm	GMC
562-348	(561-248)	M12 x 1.5R x 43mm	Ford
562-351	(561-251)	M12 x 1.5R x 51mm	Ford
562-354	(561-354)	M12 x 1.5R x 36mm	Honda
562-366	(561-169)	M12 x 1.5R x 43mm	Ford, Mazda
562-367	(560-367)	1/2-20R x 2	Ford, Mercury
562-368	(561-168)	M12 x 1.5R x 38mm	Ford, Mazda
562-369	(560-269)	1/2-20R x 2-1/8	Ford Truck
562-386	(560-186)	1/2-20R x 1-7/8	Ford Truck
562-409	(561-309)	M12 x 1.5 x 42mm	Mazda Truck
562-412	(561-312)	M12 x 1.5R x 44mm	Chrysler
562-422	(561-322)	M12 x 1.25 x 30mm	Subaru
562-461	(561-361)	M12 x 1.5 x 41mm	Chrysler
562-464	(560-364)	1/2-20R x 1-15/32	Chrysler
562-468	(560-368)	1/2-20R x 1-31/32	Ford
562-476	(561-376)	M12 x 1.5 x 49mm	Ford, Mercury
562-478	(561-378)	M12 x 1.25R x 42mm	Infiniti, Nissan
562-480	(561-380)	M10 x 1.25 x 29mm	GM, Geo

* 13/16 AF Nuts, ** 3/4 AF Nuts - For dimensions of Wheel Nuts see page 2



WHEEL PARTS MERCHANTISERS

PRÉSENTOIRS DE PIÈCES DE ROUE SUR CARTE

'Papco' Wheel Parts are merchandised on three easy to stock, space-saving display racks designed for countertop, pegboard wall, gondola or pylon displays. Modular metal display rack measures 16" x 24" and features a bilingual, reversible header sign, 20 safety hooks, inventory control system and a planogram for product layout. Merchandisers No. 022-144 and 145 include a 40 card starter stock and Merchandiser No. 022-146 includes a 20 card starter stock. Bonus cards are included with each merchandiser to offset the cost of the rack.

- 95% vehicle coverage
- Modular self-serve displays
- Inventory control system
- Applications on each card



GM and IMPORTS WHEEL PARTS MERCHANTISER No. 022-144

Card No.	Cat. No.	Description
562-018	(560-018)	Trailer Bolts (2/card)
562-019	(560-019)	Trailer Bolts (2/card)
562-114	(560-114)	Gm & Truck, Jeep
562-126	(560-386)	Gm & Truck
562-138	(560-138)	Gm & Truck
562-155	(560-155)	Gm & Truck
562-200	(561-100)	Datsun/Nissan & Truck
562-201	(561-100)	Datsun/Nissan & Truck
562-204	(560-604)	GM & Truck Jeep
562-214	(561-114)	GM

Card No.	Cat. No.	Description
562-226	(561-126)	Geo, Toyota
562-274	(561-174)	Geo, Suzuki
562-275	(561-175)	GM
562-308	(561-108)	GM
562-310	(561-110)	GM & Truck
562-322	(561-122)	Toyota
562-339	(561-139)	GM
562-354	(561-154)	Honda
562-422	(561-322)	Subaru
562-480	(561-380)	Geo, GM

CHRYSLER and FORD WHEEL PARTS MERCHANTISER No. 022-145

Card No.	Cat. No.	Description
562-173	(560-103)	Chrysler, Dodge & Truck
562-206	(561-106)	Chrysler, Dodge
562-208	(561-108)	Chrysler, Dodge & Truck
562-209	(561-109)	Chrysler, Dodge & Truck
562-240	(561-140)	Chrysler Imports
562-249	(561-249)	Ford
562-272	(560-172)	Ford & Truck
562-273	(560-173)	Ford & Truck
562-348	(561-248)	Ford
562-351	(561-251)	Ford

Card No.	Cat. No.	Description
562-366	(561-169)	Ford
562-367	(560-367)	Ford
562-368	(561-168)	Ford
562-369	(560-269)	Ford & Truck
562-386	(560-186)	Ford & Truck
562-409	(561-309)	Mazda
562-412	(561-312)	Chrysler
562-461	(561-361)	Chrysler
562-468	(560-368)	Ford
562-476	(561-376)	Ford

WHEEL NUTS MERCHANTISER No. 022-146

Card No.	Cat. No.	Description	Type
562-010		For 13/16AF Nuts	Caps
562-012		For 3/4AF Nuts	Caps
562-014	(558-014)	7/16-20R Chrysler, GM	Reg.
562-016	(558-016)	1/2-20R AMC, Ford, GM	Reg.
562-027	(558-027)	1/2-20R Chrysler	Reg.
562-040	(559-150)	M12 x 1.5R All	Reg.
562-044	(558-144)	7/16-20R Chrysler, GM	Acorn
562-045	(558-140)	7/16-20R GM	Acorn
562-048	(558-148)	1/2-20R AMC, Ford, GM	Acorn
562-060	(559-060)	M10 x 1.25 Geo, GM	Acorn

Card No.	Cat. No.	Description	Type
562-063	(559-163)	M12 x 1.5R Chrysler Imports	Reg.
562-064	(559-064)	M12 x 1.25R Imports	Reg.
562-065	(559-065)	M12 x 1.25R Datsun/Nissan	Acorn
562-072	(559-172)	M12 x 1.5R Ford, Imports	Reg.
562-074	(558-174)	7/16-20R Chrysler, GM	Mag
562-077	(559-077)	M12 x 1.5R Imports	Acorn
562-095	(559-095)	M12 x 1.25R Datsun/Nissan	Mag
562-100	(559-100)	M12 x 1.5R All	Mag
562-154	(559-154)	M14 x 1.5R GM	Reg.



ACTUAL SIZE ILLUSTRATIONS

7/16-20



560-386
7/16-20R x 1-5/16"
Knurl diameter: .555
(Code: DN)



560-096
7/16-20R x 1-7/16"
Knurl diameter: .560
(Code: G)



560-114
7/16-20R x 1-1/2"
Knurl diameter: .465
(Code: J)



560-390
7/16-20R x 1-1/2"
Knurl diameter: .555
(Code: ET)



560-604
7/16-20R x 1-3/4"
Knurl diameter: .575
(Code: EY)

1/2-20

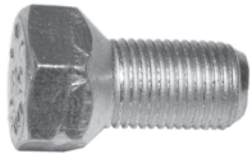

560-009
1/2-20R x 7/8"

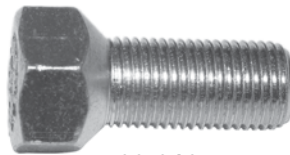

560-010
1/2-20R x 1-1/8"

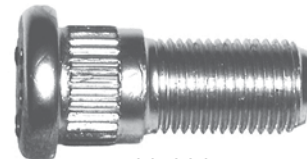

560-090
1/2-20R x 1-5/16"
Knurl diameter: .625
(Code: AF)



560-032
1/2-20R x 1-3/8"
Knurl diameter: .630
(Code: A)



560-018
1/2-20R x 1-7/16"
(Code: KK)



560-364
1/2-20R x 1-15/32"
Knurl diameter: .618

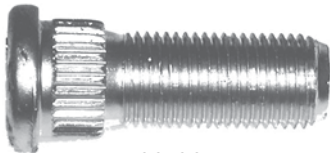

560-034
1/2-20R x 1-1/2"
Knurl diameter: .618
(Code: F)

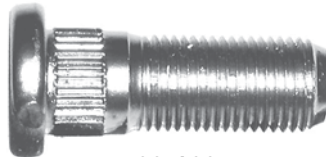

560-163
1/2-20R x 1-1/2"
Knurl diameter: .545
(Code: BT)



560-103
1/2-20R x 1-1/2"
Knurl diameter: .665
(Code: TT)



560-315
1/2-20R x 1-9/16"
Knurl diameter: .558

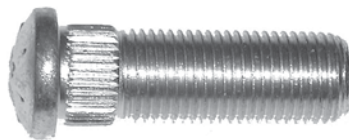

560-138
1/2-20R x 1-5/8"
Knurl diameter: .535
(Code: AB)



560-039
1/2-20R x 1-5/8"
Knurl diameter: .620
(Code: BH)

ACTUAL SIZE ILLUSTRATIONS

1/2-20



560-187
1/2-20R x 1-5/8"
Knurl diameter: .623
(Code: JP)



560-155
1/2-20R x 1-5/8"
Knurl diameter: .630
(Code: ES)



560-102
1/2-20R x 1-11/16"
Knurl diameter: .562
(Code: CL)



560-011
1/2-20R x 1-7/8"



560-175
1/2-20R x 1-3/4"
Knurl diameter: .665
(Code: JE)



560-173
1/2-20R x 1-3/4"
Knurl diameter: .625
(Code: FR)



560-366
1/2-20R x 1-3/4"
Knurl diameter: .650
(Code: VO)



560-470
1/2-20R x 1-3/4"
Knurl diameter: .625
(Code: CA)



560-148
1/2-20R x 1-13/16"
Knurl diameter: .620
(Code: DE)



560-105
1/2-20R x 1-7/8"
Knurl diameter: .560
(Code: FA)



560-172
1/2-20R x 1-7/8"
Knurl diameter: .560
(Code: FD)



560-186
1/2-20R x 1-7/8"
Knurl diameter: .612
(Code: GM)



560-345
1/2-20R x 1-7/8"
Knurl diameter: .570



560-289
1/2-20R x 1-29/32"
Knurl diameter: .583



560-287
1/2-20R x 1-29/32"
Knurl diameter: .667



560-167
1/2-20R x 1-15/16"
Knurl diameter: .587



560-448
1/2-20R x 1-15/16"
Knurl diameter: .667



560-368
1/2-20R x 1-31/32"
Knurl diameter: .615

ACTUAL SIZE ILLUSTRATIONS

1/2-20



560-110
1/2-20R x 2"
Knurl diameter: .625
(Code: CO)



560-298
1/2-20R x 2"
Knurl diameter: .547



Clipped
Head



560-367
1/2-20R x 2"
Knurl diameter: .585

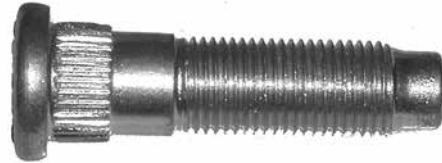

560-358
1/2-20R x 2"
Knurl diameter: .612

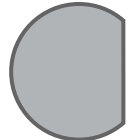

Clipped
Head



560-444
1/2-20R x 2-1/16"
Knurl diameter: .628



Clipped
Head



560-479
1/2-20R x 2-3/32"
Knurl diameter: .610



560-269
1/2-20R x 2-1/8"
Knurl diameter: .623
(Code: UP)



560-348
1/2-20R x 2-1/8"
Knurl diameter: .658

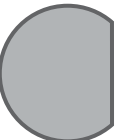

Clipped
Head



560-561
1/2-20R x 2-3/16"
Knurl diameter: .550



560-441
1/2-20R x 2-3/16"
Knurl diameter: .623



560-286
1/2-20R x 2-3/16"
Knurl diameter: .723



560-277
1/2-20R x 2-1/4"
Knurl diameter: .625

ACTUAL SIZE ILLUSTRATIONS

1/2-20

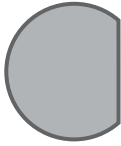

Clipped
Head



560-523
1/2-20R x 2-5/16"
Knurl diameter: .560



560-363
1/2-20R x 2-11/32"
Knurl diameter: .651

9/16-18

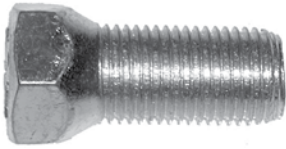

560-019
9/16-18R x 1-1/4"
(Code:KG)



560-014
9/16-18R x 1-5/16"

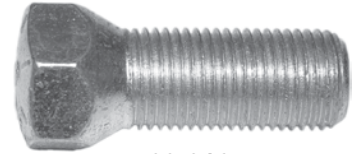

560-016
9/16-18R x 1-3/8"

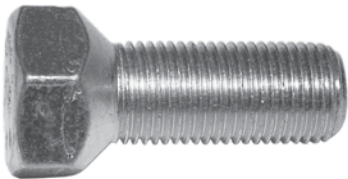

560-013
9/16-18R x 1-7/16"

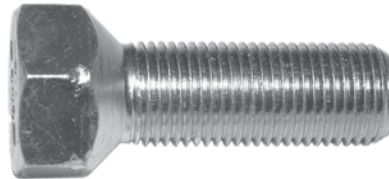

560-015
9/16-18R x 1-5/8"

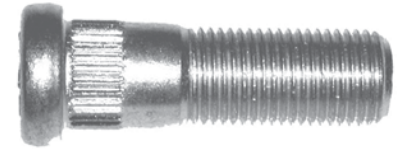

560-376
9/16-18R x 1-7/8"
Knurl diameter: .620
(Code:DR)

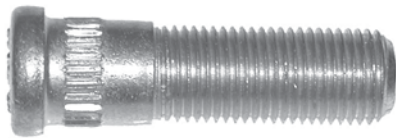

560-472
9/16-18R x 2"
Knurl diameter: .623
(Code:GR)



560-280
9/16-18R x 2-1/8"
Knurl diameter: .625

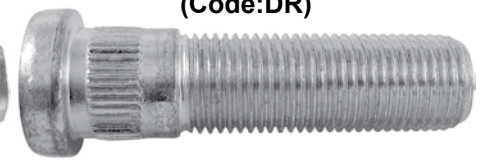

560-459
9/16-18R x 2-1/8"
Knurl diameter: .635
(Code:EC)



560-305
9/16-18R x 2-1/8"
Knurl diameter: .640

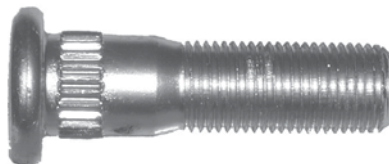

560-468
9/16-18R x 2-1/8"
Knurl diameter: .650
(Code:KR)



560-529
9/16-18R x 2-3/8"
Knurl diameter: .645



560-389
9/16-18R x 2-5/16"
Knurl diameter: .666



560-458
9/16-18R x 2-13/32"
Knurl diameter: .630
(Code: ZH)

ACTUAL SIZE ILLUSTRATIONS

9/16-18

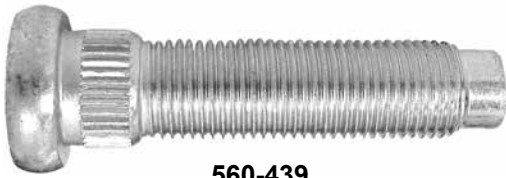

560-439
9/16-18R x 2-7/16"
Knurl diameter: .658



560-469
9/16-18R x 2-1/2"
Knurl diameter: .650
(Code: LP)



560-474
9/16-18R x 2-1/2"
Knurl diameter: .620
(Code: FK)



560-473
9/16-18R x 2-5/8"
Knurl diameter: .622
(Code: CX)



560-355
9/16-18R x 2-13/16"
Knurl diameter: .630
(Code: BW)



560-356
9/16-18L x 2-13/16"
Knurl diameter: .630
(Code: BO)



560-460
9/16-18R x 3"
Knurl diameter: .630
(Code: JR)

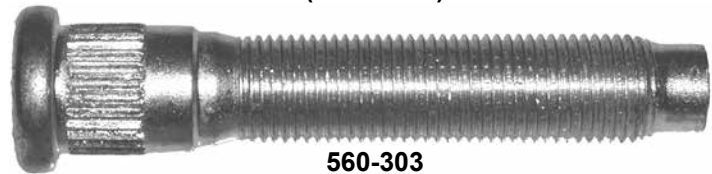

560-303
9/16-18R x 3-3/32"
Knurl diameter: .677
(Code: GE)



560-461
9/16-18R x 3-9/16"
Knurl diameter: .630
(Code: CN)

5/8-18



560-017
5/8-18R x 1-9/16"



560-180
5/8-18R x 2-1/16"
Knurl diameter: .655
(Code: GI)

ACTUAL SIZE ILLUSTRATIONS

5/8-18



560-181
5/8-18R x 2-13/32"
Knurl diameter: .652
(Code: GN)



560-182
5/8-18R x 2-9/16"
Knurl diameter: .655
(Code: FY)



560-183
5/8-18R x 2-15/16"
Knurl diameter: .650
(Code: FM)

M10 x 1.25

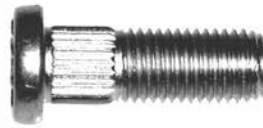

561-380
M10 X 1.25 x 29mm
Knurl diameter: 10.0mm
(Code: CS)

M12 x 1.25



561-322
M12 x 1.25 x 30.2mm
Knurl diameter: 14.27mm



561-102
M12 X 1.25 x 32mm
Knurl diameter: 12.9mm
(Code: D.2.0)



561-155
M12 x 1.25 x 33mm
Knurl diameter: .12mm
(Code: H.1.0)



561-174
M12 X 1.25 x 34mm
Knurl diameter: 12.24mm
(Code: BA)



561-175
M12 x 1.25 x 38mm
Knurl diameter: .12.24mm
(Code: BC)



561-100
M12 x 1.25 x 39mm
Knurl diameter: .12.9mm
(Code: D.1.0)



561-378
M12 x 1.25 x 42mm
Knurl diameter: 14.35mm



561-401
M12 X 1.25 x 42mm
Knurl diameter: 14.43mm

ACTUAL SIZE ILLUSTRATIONS

M12 x 1.5



561-130
M12 x 1.5 x 27mm
17mm Hex
(Code VW.1.0)



561-167
M12 x 1.5 x 28mm
21mm Hex
(Code M.3.3)



561-132
M12 x 1.5 x 30mm
17mm Hex
(Code VW.2.0)



561-152
M12 x 1.5 x 30mm
19mm Hex
(Code M.7.0)



561-166
M12 x 1.5 x 32mm
Knurl diameter: 13mm
(Code M.3.5)



561-118
M12 x 1.5 x 34mm
19mm Hex



561-115
M12 x 1.5 x 35mm
Knurl diameter: 12.7mm



561-367
M12 x 1.5 x 36mm
17mm Hex



561-122
M12 x 1.5 x 36mm
Knurl diameter: 14.3mm
(Code T.5.0)



561-154
M12 x 1.5 x 36mm
Knurl diameter: 12mm
(Code H.3.0)



561-139
M12 x 1.5 x 37mm
Knurl diameter: 14mm
(Code M.3.0)



561-140
M12 x 1.5 x 37mm
Knurl diameter: 14.4mm
(Code M.1.8)



561-114
M12 x 1.5 x 38mm
Knurl diameter: 14.35mm
(Code C.U.1)



561-168
M12 x 1.5 x 38mm
Knurl diameter: 13mm
(Code M.Z.3)

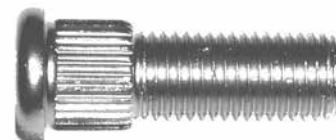

561-106
M12 x 1.5 x 38.5mm
Knurl diameter: 14.7mm
(Code M.2.0)



561-108
M12 x 1.5 x 38mm
Knurl diameter: 14.3mm
(Code M.1.0)



Clipped Head
561-109
M12 x 1.5 x 40mm
Knurl diameter: 14.8mm
(Code M.7.8)



561-112
M12 x 1.5 x 40mm
Knurl diameter: 12.5mm
(Code M.4.6)

ACTUAL SIZE ILLUSTRATIONS

M12 x 1.5



Clipped Head
561-361
 M12 x 1.5 x 41.0mm
 Knurl diameter: 16.5mm

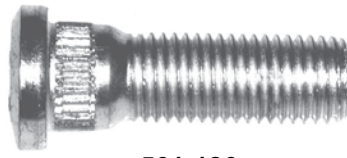

561-126
 M12 x 1.5 x 41mm
 Knurl diameter: 14.2mm
 (Code T.6.0)

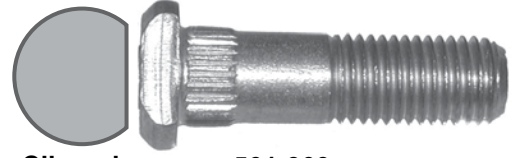

Clipped Head
561-309
 M12 x 1.5 x 42.7mm
 Knurl diameter: 13.08mm

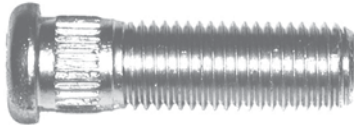

561-110
 M12 x 1.5 x 43mm
 Knurl diameter: 13mm
 (Code M.1.7)

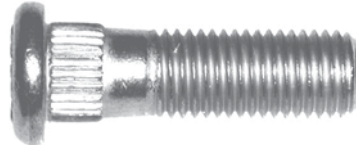

561-169
 M12 x 1.5 x 43mm
 Knurl diameter: 12.85mm
 (Code CI)



561-248
 M12 x 1.5 x 43mm
 Knurl diameter: 14.5mm
 (Code Fm1)



561-371
 M12 x 1.5 x 43.8mm
 Knurl diameter: 17mm



561-370
 M12 x 1.5 x 44mm
 Knurl diameter: 15.8mm



561-312
 M12 x 1.5 x 44.4mm
 Knurl diameter: 14.17mm



Clipped Head
561-438
 M12 x 1.5 x 44.5mm
 Knurl diameter: 16.23mm

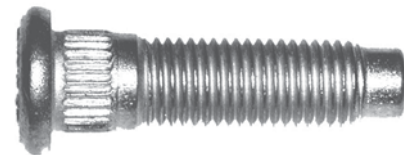

561-247
 M12 x 1.5 x 46mm
 Knurl diameter: 13.41mm

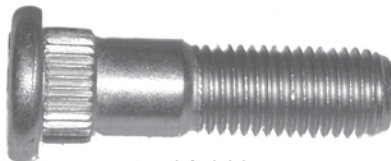

561-369
 M12 x 1.5 x 46mm
 Knurl diameter: 15mm



561-249
 M12 x 1.5 x 46mm
 Knurl diameter: 15.37mm

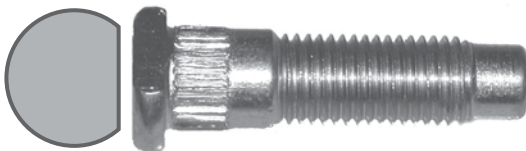

Clipped Head
561-250
 M12 x 1.5 x 47mm
 Knurl diameter: 13.34mm

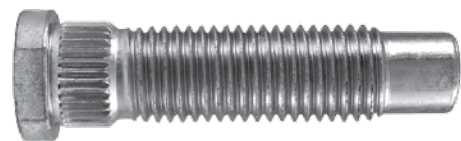

561-492
 M12 x 1.5 x 48.3mm
 Knurl diameter: 12.84mm

ACTUAL SIZE ILLUSTRATIONS

M12 x 1.75

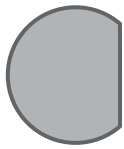

Clipped
Head



561-376
M12 x 1.5 x 49mm
Knurl diameter: 13.9mm



561-445
M12 x 1.5 x 49mm
Knurl diameter: 14.5



561-251
M12 x 1.5 x 51mm
Knurl diameter: 13.5mm
(Code F.1.1)



561-255
M12 x 1.5 x 52mm
Knurl diameter: 12.9mm
(Code M.Z.2)



561-416
M12 x 1.5 x 52mm
Knurl diameter: 14.8mm



561-264
M12 x 1.5 x 52.6mm
Knurl diameter: 14.33mm



561-390
M12 x 1.75 x 51mm
Knurl diameter: 14.73mm

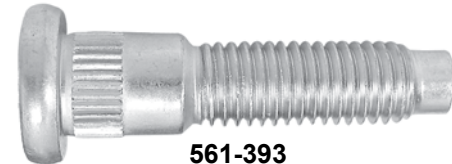

561-393
M12 x 1.75 x 55mm
Knurl diameter: 14.6mm

M14 x 1.25



561-532
M14R x 1.25 x 36mm
17mm Hex

M14 x 1.5



561-133
M14 x 1.5 x 35mm
17mm Hex

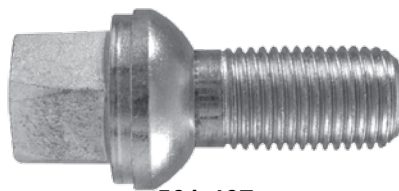

561-467
M14 x 1.5R x 36mm
17mm Hex

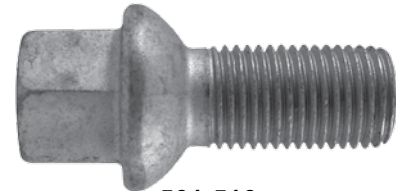

561-516
M14 x 1.5R x 36mm
17mm Hex

ACTUAL SIZE ILLUSTRATIONS

M14 x 1.5



561-522
M14 x 1.5R x 41mm
17mm Hex

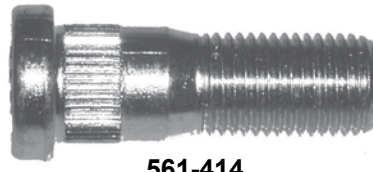

561-414
M14 x 1.5 x 43mm
Knurl diameter: 15.7mm
(Code DP)



561-413
M14 x 1.5 x 43mm
Knurl diameter: 15.7mm
(Code PU)



561-527
M14 x 1.5 x 45.5mm
Knurl diameter: 16.5mm



561-415
M14 x 1.5 x 46mm
Knurl diameter: 15.8mm
(Code DO)



561-410
M14 x 1.5 x 49mm
Knurl diameter: 15.7mm
(Code DT)

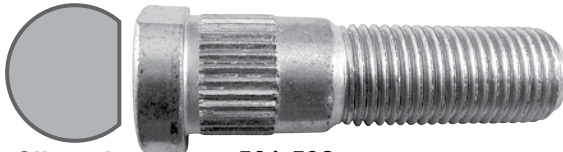

Clipped
Head
561-502
M14 x 1.5 x 50mm
Knurl diameter: 16.02mm



561-417
M14 x 1.5 x 54mm
Knurl diameter: 15.7mm
(Code DK)



561-434
M14 x 1.5 x 58mm
Knurl diameter: 16mm



561-428
M14 x 1.5 x 65mm
Knurl diameter: 15.7mm



561-490
M14 x 1.5 x 69.75mm
Knurl diameter: 15.7mm



561-411
M14 x 1.5 x 76mm
Knurl diameter: 15.7mm
(Code DA)

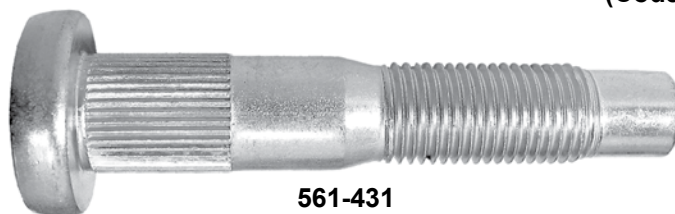

561-431
M14 x 1.5 x 80mm
Knurl diameter: 15.7mm

ACTUAL SIZE ILLUSTRATIONS

M14 x 2.0



561-442
M14 x 2.0 x 58mm
Knurl diameter: 15.5mm



561-424
M14 x 2.0 x 73mm
Knurl diameter: 15.78mm



561-418
M14 x 1.5 x 91mm
Knurl diameter: 15.7mm
(Code DL)



561-436
M14 x 1.5 x 104mm
Knurl diameter: 16mm

7/16-20



558-014
7/16-20R
3/4" Hex
9/16" Height
60° - Zinc



558-174
7/16-20R
13/16" Hex
3/4" Shank
Chrome



558-140
7/16-20R
3/4" Hex
1-3/8" Height
60° - Chrome



558-070
7/16-20R
3/4" Hex
1-1/8" Height
Stainless Steel Capped



558-144
7/16-20R
13/16" Hex
1-3/8" Height
60° - Chrome

ACTUAL SIZE ILLUSTRATIONS

1/2-20



558-027
1/2-20R
3/4" Hex
9/16" Height
60° - Zinc



558-148
1/2-20R
3/4" Hex
1-3/8" Height
Cone Angle: 60° - Chrome



558-016
1/2-20R
13/16" Hex
5/8" Height
60° - Zinc



558-176
1/2-20R
13/16" Hex
3/4" Shank
Chrome



558-197
1/2-20R
13/16" Hex
1-5/32" Height
60° - Zinc



558-146
1/2-20R
13/16" Hex
1-3/8" Height
60° - Chrome



558-094
1/2-20R
3/4" Hex
1-39/64" Height
Stainless Steel
Capped



558-160
1/2-20R
3/4" Hex
1-3/16" Height
60° - Zinc



558-163
1/2-20R
3/4" Hex
29/32" Height
60° - Zinc



558-222
1/2-20R
13/16" Hex
1-1/16" Height



558-171
1/2-20R
3/4" Hex
1-1/4" Height
60° - Yellow Zinc



558-199
1/2-20R
3/4" Hex
1-1/4" Height
60° - Zinc



558-071
1/2-20R
13/16" Hex
1-15/32" Height
Stainless Steel
Capped



558-292
1/2-20R
13/16" Hex
1-1/2" Height
Dometop Capped



558-123
1/2-20R
13/16" Hex
1-17/64" Height
60° - Black

ACTUAL SIZE ILLUSTRATIONS

1/2-20



558-122
1/2-20R
3/4" Hex
1-5/16" Height
Dometop Capped



558-124
1/2-20R
13/16" Hex
1-9/32" Height
Stainless Steel Capped

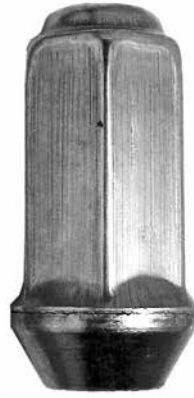

558-143
1/2-20R
13/16" Hex
2-1/32" Height
Stainless Steel Capped



558-162
1/2-20R
13/16" Hex
59/64" Height
60° - Zinc

9/16-18



558-100
9/16-18R
7/8" Hex
3/4" Height
60° - Zinc



558-127
9/16-18R
7/8" Hex
1" Height
Flange



558-204
9/16-18
7/8" Hex
1-1/2" Height
Stainless Steel Capped



558-062
9/16-18R
15/16" Hex
1-1/64" Height
60° - Zinc



558-047
9/16-18R
1" Hex
11/16" Height
60° - Zinc



558-050
9/16-18L
1" Hex
11/16" Height
60° - Zinc



558-058
9/16-18R
1-1/16" Hex
21/32" Height
Cone Angle: 90° - Zinc

ACTUAL SIZE ILLUSTRATIONS

9/16-18



558-061
9/16-18
1-1/16" Hex
15/16" Height
Cone Angle:
60°Black



558-092
9/16-18
1-1/16" Hex
1" Height
1.60" dia. flg. - Black



558-296
9/16-18
15/16" Hex
1-1/8" Height
Flanged Flat

5/8-18



558-055
5/8-18R
1" Hex
21/32" Height
Cone Angle 90° -
Zinc



558-044
5/8-18R
1-1/16" Hex
21/32" Height
90° - Zinc



558-045
5/8-18L
1-1/16" Hex
21/32" Height
90° - Zinc



558-057
5/8-18
1-1/8" Hex
1-1/16" Height
1.62" dia. flg. - Zinc

M10 x 1.25



559-060
M10 x 1.25
17mm Hex
21mm Height
60° - Chrome

ACTUAL SIZE ILLUSTRATIONS

M12 x 1.25



559-064
M12 x 1.25
19mm (3/4") Hex
16mm Height
Cone Angle: 60°
Chrome



559-078
M12R x 1.25
19mm Hex
25mm Height
60° - Chrome



559-125
M12 x 1.25
21mm Hex
16mm Height
60° - Zinc

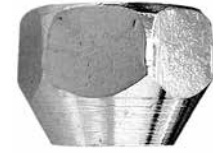

559-113
M12R x 1.25
21mm Hex
16mm Height
60° - Chrome



559-095
M12 x 1.25
21mm (13/16") Hex
3/4" Shank
Chrome



559-114
M12R x 1.25
21mm Hex
29mm Height
60° - Chrome



559-310
M12 x 1.25
21mm Hex
34mm Height
Dometop Capped



559-065
M12 x 1.25
21mm (13/16") Hex
1-3/8" Height
60° - Chrome

M12 x 1.5



559-150
M12 x 1.5
19mm Hex
14mm Height
60° - Zinc



559-085
M12R x 1.5
19mm Hex
22mm Height
60° - Black



559-163
M12 x 1.5
19mm (3/4") Hex
23mm Height
Cone Angle: 60° - Zinc



559-191
M12R x 1.5
19mm Hex
28mm Height
60° - Zinc



559-087
M12R x 1.5
19mm Hex
29.5mm Height
Stainless Steel
Capped

ACTUAL SIZE ILLUSTRATIONS

M12 x 1.5



559-301
M12R x 1.5
19mm Hex
29.5mm Height
Acorn Chrome



559-074
M12R x 1.5
19mm Hex
31mm Height
Dometop Capped
Stainless Steel



559-192
M12R x 1.5
19mm Hex
31mm Height
60° - Zinc



559-089
M12R x 1.5
19mm (3/4") Hex
32mm Height
Flattop Capped
Stainless Steel



559-151
M12R x 1.5
19mm Hex
34mm Height
60° - Flanged Flat
Yellow Zinc



559-075
M12 x 1.5
19mm (3/4") Hex
1-3/8" (35mm) Height
60° - Acorn
Chrome



559-077
M12 x 1.5
19mm (3/4") Hex
35mm Height
Cone Angle: 60°
Acorn Bulge
Chrome



559-138
M12R x 1.5
19mm Hex
35mm Height
11.91mm rad.
Chrome



559-190
M12R x 1.5
19mm Hex
36mm Height
Dometop Capped
Stainless Steel



559-137
M12R x 1.5
19mm Hex
40mm Height
18.0mm rad. x 15.0 lg.
Chrome



559-181
M12 x 1.5
19mm Hex
43mm Height



559-305
M12 x 1.5
20mm Hex
29.5mm Height



559-172
M12 x 1.5
21mm (13/16") Hex
18mm Height
Cone Angle: 60°
Zinc



559-141
M12R x 1.5
21mm Hex
27.5mm Height
60° - Chrome



559-309
M12 x 1.5
21mm Hex
30mm Height

ACTUAL SIZE ILLUSTRATIONS

M12 x 1.5



559-104
M12 x 1.5
21mm (13/16") Hex
5/16" Shank
Chrome



559-100
M12 x 1.5
21mm (13/16") Hex
3/4" Shank
Chrome



559-070
M12 x 1.5
21mm Hex
35mm Height
60° - Chrome



559-117
M12R x 1.5
21mm Hex
37mm Height
18.4 dia. flg. x 11.9 lg.
Chrome



559-308
M12 x 1.5
21mm Hex
38.5mm Height



559-167
M12 x 1.5
21mm Hex
47mm Height

M12 x 1.75



559-174
M12R x 1.75
19mm Hex
22.5mm Height
27.8 dia. flg. - Black



558-200
11/16" I.D. x 1" O.D.
Mag Nut Washers
Chrome
For 558 and 559 series
Mag Type Wheel Nuts

ACTUAL SIZE ILLUSTRATIONS

M14 x 1.5



559-246
M14R x 1.5
21mm Hex
23.2mm Height
Flanged Flat



559-112
M14R x 1.5
21mm Hex
34mm Height



559-154
M14R x 1.5
22mm Hex
21mm Height
60° - Zinc



559-194
M14R x 1.5
22mm Hex
25.5mm Height
90° - Zinc



559-193
M14R x 1.5
22mm Hex
28.5mm Height
60° - Zinc



559-257
M14R x 1.5
21mm Hex
24mm Height
Bulge



559-259
M14R x 1.5
21mm Hex
43.5mm Height
Dometop Capped
Chrome



559-302
M14R x 1.5
22mm Hex
34mm Height
Flanged Flat



559-236
M14R x 1.5
22mm Hex
44.5mm Height
Flattop Capped
Chrome



559-277
M14R x 1.5
22mm Hex
46mm Height
Acorn

ACTUAL SIZE ILLUSTRATIONS

M14 x 2.0



559-306
M14R x 2.0
20mm Hex
50mm Height



559-196
M14R x 2.0
21mm Hex
22.6mm Height
29.8mm Seat - Black



559-323
M14R x 2.0
21mm Hex
31mm Height



559-288
M14R x 2.0
21mm Hex
54mm Height
Dometop Capped

M24 x 2.0



559-200
M24 x 2.0 Thread
18mm Hex
Grey



559-209
M24 x 2.0 Thread
18mm Hex
Black



559-211
M24 x 2.0 Thread
19mm Hex
Grey



559-202
M24 x 2.0 Thread
19mm Hex
Black

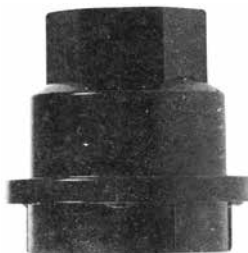

559-215
M24 x 2.0 Thread
19mm Hex
Black

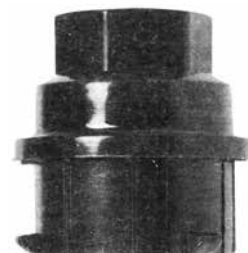

559-220
M24 x 2.0 Thread
19mm Hex
Black

ACTUAL SIZE ILLUSTRATIONS

M24 x 2.0



559-201
M24 x 2.0 Thread
19mm Hex
Stainless Steel



559-203
M24 x 2.0 Thread
19mm Hex
Grey



559-204
M24 x 2.0 Thread
19mm Hex
Black

M27 x 2.0



559-210
M27 x 2.0 Thread
21mm Hex
Black



559-205
M27 x 2.0 Thread
22mm Hex
Black



559-212
M27 x 2.0 Thread
22mm Hex
Black



559-206
M27 x 2.0 Thread
23mm Hex
Black

Other product catalogues available . . .

NEW
papeco® **Automotive and Industrial Fasteners No. 415**
Automotive Aftermarket and Industrial Fasteners in Inch and Metric

- Cap Screws • Nuts • Washers • Screws
- Body shop Fasteners
- Wheel Parts • Brake lines
- Battery Parts • Grease Fittings
- Merchandisers and Kits included

papeco® **Body Shop Fasteners No. BSF-712**

- Standard Steel Fasteners in Inch and Metric
- Body Bolts • Nuts • Clips
- Reveal Windshield Retainers
- Moulding Clips
- Trim Screws
- Domestic and Import coverage

Dominion **Fluid Flow Components No. 6011**

- Fluid Flow Brass & Steel Fittings
- Compression • Flare
 - Pipes • Valves
 - Hose and Tubing
 - Gas regulators, valves and assemblies
 - Merchandisers and Kits included

papecoflex **Brake Lines No. BL107**

- Steel Brake Lines & Fittings
- Poly-V Brake Line
- 'No Tools Required' Fuel Line Repair
- Coolant & Transmission Fittings
- Merchandisers and Kits included

papeco® **Expansion Plugs No. EP410**

- Standard, Cup and Shallow Cup Types
- Inch and Metric sizes
- Complete coverage for most Domestic and Import engines
- Merchandisers and Kits included

papeco® **Oil Drain Plugs No. DP616**

- Standard and Magnetic Drain Plugs with Gaskets
- Inch and Metric sizes
 - Complete coverage for most Domestic and Import vehicles
 - Oversized plugs for stripped holes
 - Merchandisers and Kits included



Distributed By / Distribué par :

**For additional copies and other requests, email us at: canadiansales@hillmangroup.com,
or to download a copy of this catalogue, please visit our website at www.hpaulin.com**

**Pour copies additionnelles et d'autres informations, envoyer nous un courriel à :
canadiansales@hillmangroup.com, ou pour télécharger une copie de ce catalogue,
voir notre site web à www.hpaulin.com**

WP516



H. Paulin & Co., a division of The Hillman Group Canada ULC