



---

## DISTRIBUTOR CATALOG

---

 **flexfab**<sup>®</sup>

Engineering trust. Around the world.<sup>™</sup>

[www.flexfab.com](http://www.flexfab.com)







## THE FLEXFAB CREED

### VALUE FOR CUSTOMERS:

We believe our first commitment is to our customers. In meeting their needs, everything we do must be of high quality. We must constantly strive to reduce our costs, and improve our quality and productivity. Customers' orders must be serviced promptly and accurately.

### QUALITY OF LIFE FOR EMPLOYEES:

We are committed to the general welfare of our employees and the belief that each must be treated as an individual. We must respect their dignity and recognize their merit. There must be a sense of security in their employment and compensation must be fair. Employees must feel free to make suggestions and complaints. Working conditions must be safe, clean, and orderly. There must be equal opportunity for employment, personal development, and advancement for those qualified. The worth of an employee must be recognized by providing challenging work. Adequately trained and educated employees are necessary in maintaining our quality of work life. We must provide competent management, whose responsibility is to accomplish our long term goals and objectives. Their actions must be just and ethical.

### SERVICE FOR COMMUNITY:

We are committed to the communities in which we live and work. We must be good citizens by supporting community projects and charities both financially and with time and talents of employees. We must encourage civic improvements and better health and education. We must maintain, in good order, our property and protect the environment and natural resources.

### BENEFIT FOR SHAREHOLDERS:

Our final commitment is to our shareholders. The long term viability of the corporation must be assured. New products and capabilities must be developed. New ideas must be encouraged and experimented with. Research must be carried on and innovative programs developed. Facilities and equipment must be properly maintained and replaced when necessary. To meet this commitment, adequate profits are necessary, as well as reserves for adverse times. With a fair price for our products and keeping costs under control, the shareholders will realize a fair return.

**Engineering trust. Around the world.™**



Flexfab GR 4440 44th St. SE, Kentwood, MI 49512, USA,  
Phone: 888-353-9323, Fax: 888-353-9344,  
[www.flexfab.com](http://www.flexfab.com)

All rights reserved. ©2017 Flexfab Horizons International, Inc.

A member of the FHI® family of companies.

Flexfab® does not assume any liability for errors or omissions.  
ZZZ-34693G – June, 2019



# BENEFITS AND APPLICATIONS OF SILICONE RUBBER

## ***WHY USE SILICONE RUBBER WHEN SO MANY OTHER ELASTOMERS ARE AVAILABLE?***

### **STABILITY:**

Silicone rubber components have a useful life far superior to other elastomers under conditions that would cause those other materials to deteriorate. It has excellent resistance to many chemicals and fluids commonly encountered in service, which is particularly useful at temperatures which prevent the use of other materials.

## ***SILICONE'S STRENGTH IN HARSH CONDITIONS:***

---

### **RELIABILITY:**

Silicone rubber consistently offers better performance under normal conditions, but it really shows its strength under the most extreme conditions industry can dish out. No matter the application, silicone rubber is the obvious choice for stability, reliability, and value. Visit [Flexfab.com](http://Flexfab.com) to learn how Flexfab's range of Silicone products can improve your company's systems...and your bottom line.

### **FLEXFAB SILICONE PRODUCTS:**

The uniqueness of silicone rubber provides its users with mechanical, thermal, electrical, and chemical attributes not found in other elastomers. Resistant to hostile environments and damaging elements; strong yet flexible; long service life; are the key ingredients in setting silicone rubber products above the rest.

From flexible hose, ducts and sleeves, to high temperature gaskets, electric heat tapes, conveyor belting, etc.... silicone rubber products have proven to provide above average protection from potentially harmful elements.

### **SNAPSHOT: FEATURES AND BENEFITS**

- Resistant to a wide range of temperatures
- Resistant to hardening, cracking, ozone attack, sunlight
- Resistant to moisture, steam, dust, aging, various pressure ranges
- Resistant to many chemicals
- Retains flexibility in hostile engine environments
- Excellent electrical insulating properties
- Longer life than EPDM (black rubber)



Engineering trust. Around the world.™

---

## CONTENTS

---

5515 and 5500 Series 3-Ply Coolant Hose	4-5	7851 Series Meta-Aramid Reinforced Turbo Sleeves	38-39
5581 and 5501 Series 4-Ply Coolant Hose	6-7	2563 Series Sil-Fab2™ Nylon Rod Reinforced Duct	40-41
5415 Series 3-Ply Glossy Coolant Hose	8-9	2005 Series Sil-Fab2™ Wire Reinforced Duct	42-43
5508 Series Wire Reinforced Coolant Hose	10-11	7884 and 7896 Series 3-Ply Silicone Elbows	44-45
High Temp Coolant Hose	12-13	7903 Series Reducers	46-47
5526 Series Standard Heater Hose	14-15	5584 Series Marine Wet Exhaust Sleeves	48-49
5521 and 5834 Series Premium Heater Hose	16-17	7901 Series Marine Wet Exhaust Bellows	50-51
Pre-Cut Hoses and Color Comparison	18-19	5531 Series Low Pressure Silicone Tubing	52-53
Specialty Hoses	20-21	36519 Series Beaded Connectors	54-55
5001 Series Heater Hose Repair Kit	22-23	2582 Series Lined Worm Gear Clamps	56-57
Charge Air Connector (CAC): Convolution Reducers	24-25	2584 Series Constant Tension Clamps	58-59
Charge Air Connector (CAC): Hot and Cold Side	26-27	2583 Series T-Bolt Clamps	60-61
Heavy-Wall Charge Air Connector (CAC)	28-29	2588 Series Spring Loaded T-Bolt Clamps	62-63
4000 Series Charge Air Connector Hose and Clamp Kits	30-31	Cooling System and Charge Air System	
Large ID Charge Air Connector (CAC)	32-33	General Information	64-65
7701 Series Fiberglass Reinforced Turbo Sleeves	34-35		
7703 Series Heavy Duty Fiberglass Reinforced Turbo Sleeves	36-37		



# 5515 AND 5500 SERIES:

## 3-PLY COOLANT HOSE

To order (3 foot stick) reference part number: FLX5515-300  
To order (12 foot stick) reference part number: FLX5515-300x12





Engineered for hostile engine environments, this coolant hose is ideal for extreme temperature and pressure ranges where high performance levels are required. It resists hardening, cracking, cold leaks, aging, and a number of chemicals, making it a durable, long-lasting solution for your applications.

### CONSTRUCTION:

- + Silicone hose with 3-ply of polyester reinforcement
- + Available in: 
- + Stocked in 3' lengths
- + 12' lengths also available (call for availability)

### SPECIFICATIONS:

- + Meets or exceeds the operating requirements of SAE J20 R1 Class A 
- + Meets or exceeds the operating requirements of TMC RP303B Class I Grade II 
- + Custom wall thickness is .140"/.190"
- + Working pressure is 1/3 of the burst pressure
- + Resists hardening, cracking, cold leaks, aging, and many chemicals
- + Ideal for extreme temperature and various pressure ranges where high performance levels are required

## BENEFITS

- ✓ Extreme Temperature Resistance
- ✓ Extreme Duty Cycle Tested for Hostile Engine Environments
- ✓ Durable Construction for Various Pressure Ranges
- ✓ Long Life Design

### CUSTOM ENGINEERED TO WITHSTAND:



### TEMPERATURE RANGE:

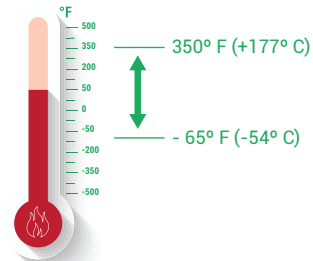

# 5515 AND 5500 SERIES: 3-PLY COOLANT HOSE

Blue Series Part Number	Green Series Part Number	Inside Diameter		Outside Diameter		Actual Burst Pressure - PSI	Burst Pressure - PSI		Weight (LB/FT)	Clamp
		Inch	MM	Inch	MM		SAE J20 R1	TMC		
5515-038	5500-038	0.38	10	0.70	18	500	425	125	0.12	-
5515-050	5500-050	0.50	13	0.82	21	500	425	125	0.16	2582-0006
5515-062	5500-062	0.63	16	0.95	24	485	425	125	0.20	2582-0010
5515-075	5500-075	0.75	19	1.07	27	475	325	125	0.24	2582-0012
5515-087	5500-087	0.88	22	1.20	30	465	300	125	0.28	2582-0012
5515-100	5500-100	1.00	25	1.32	34	450	300	125	0.32	2582-0016
5515-112	5500-112	1.13	29	1.45	37	435	300	125	0.36	2582-0016 or 2584-0175
5515-125	5500-125	1.25	32	1.57	40	425	275	125	0.40	2582-0020 or 2584-0175
5515-138	5500-138	1.38	35	1.70	43	400	250	125	0.44	2582-0020 or 2584-0212
5515-150	5500-150	1.50	38	1.82	46	375	250	125	0.48	2582-0024 or 2584-0212
5515-162	5500-162	1.63	41	1.95	50	350	225	125	0.52	2582-0024 or 2584-0212
5515-175	5500-175	1.75	44	2.07	53	300	225	125	0.56	2582-0028 or 2584-0262
5515-187	5500-187	1.88	48	2.20	56	250	200	100	0.60	2582-0032 or 2584-0262
5515-200	5500-200	2.00	51	2.32	59	250	200	100	0.64	2582-0032 or 2584-0262
5515-212	5500-212	2.13	54	2.45	62	235	175	100	0.68	2582-0032 or 2584-0262
5515-225	5500-225	2.25	57	2.57	65	225	175	100	0.72	2582-0036 or 2584-0312
5515-238	5500-238	2.38	60	2.70	69	210	150	100	0.76	2582-0040 or 2584-0312
5515-250	5500-250	2.50	64	2.82	72	200	150	100	0.80	2582-0040 or 2584-0312
5515-262	5500-262	2.63	67	2.95	75	200	125	100	0.84	2582-0040 or 2584-0312
5515-275	5500-275	2.75	70	3.07	78	200	125	100	0.88	2582-0044 or 2584-0362
5515-287	5500-287	2.88	73	3.20	81	200	100	100	0.92	2582-0044 or 2584-0362
5515-300	5500-300	3.00	76	3.32	84	200	100	100	0.96	2582-0048 or 2584-0362
5515-312	5500-312	3.13	80	3.45	88	175	75	100	1.00	2582-0048 or 2584-0362
5515-325	5500-325	3.25	83	3.57	91	175	75	100	1.04	2582-0052 or 2584-0412
5515-338	5500-338	3.38	86	3.70	94	150	75	100	1.08	2582-0052 or 2584-0412
5515-350	5500-350	3.50	89	3.82	97	150	75	100	1.12	2582-0056 or 2584-0412
5515-375	5500-375	3.75	95	4.07	103	135	50	100	1.20	2582-0060 or 2584-0412
5515-387	5500-387	3.88	99	4.20	107	125	50	100	1.24	2582-0060 or 2584-0462
5515-400	5500-400	4.00	102	4.32	110	125	50	100	1.28	2582-0064 or 2584-0462
5515-450	5500-450	4.50	114	4.82	122	100	N/A	N/A	1.44	2582-0072 or 2584-0512
5515-500	5500-500	5.00	127	5.32	135	90	N/A	N/A	1.60	2584-0562
5515-550	5500-550	5.50	140	5.82	148	75	N/A	N/A	1.76	2584-0612
5515-600	5500-600	6.00	152	6.32	161	75	N/A	N/A	1.92	2584-0662

\*Specifications for reference only. Specific test data available on request.



# 5581 AND 5501 SERIES:

## 4-PLY COOLANT HOSE





To order (3 foot stick) reference part number: FLX5581-300  
To order (12 foot stick) reference part number: FLX5581-300x12

Put this 4-ply silicone polyester coolant hose to work in your extreme temperature and pressure range environments. You'll find its reliable construction resists many of the issues other hoses present, including hardening, cracking, and aging. Ideal for diesel powered city transit, school buses, and refuse vehicles.





### CONSTRUCTION:

- + Silicone hose with 4-plyes of polyester reinforcement
- + Available in: 
- + Stocked in 3' lengths
- + 12' lengths also available (call for availability)

### SPECIFICATIONS:

- + Meets or exceeds the operating requirements of SAE J20 R1 Class A 
- + Meets or exceeds the operating requirements of TMC RP303B Class I Grade II 
- + Standard wall thickness is .170"/.220"
- + Working pressure is 1/3 of the burst pressure
- + Resists hardening, cracking, cold leaks, aging, and many chemicals
- + Ideal for extreme temperature and various pressure ranges where high performance levels are required
- + Ideal for diesel powered city transit, school buses, and refuse vehicles

## BENEFITS

-  Extreme Temperature Resistance
-  Extreme Duty Cycle Tested for Hostile Engine Environments
-  Durable Construction for Various Pressure Ranges
-  Long Life Design

### CUSTOM ENGINEERED TO WITHSTAND:



### TEMPERATURE RANGE:

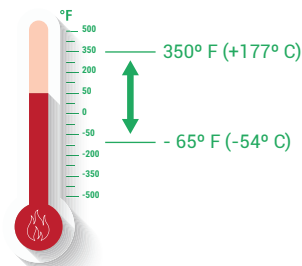



# 5581 AND 5501 SERIES: 4-PLY COOLANT HOSE

Blue Series Part Number	Green Series Part Number	Inside Diameter		Outside Diameter		Actual Burst Pressure - PSI	Burst Pressure - PSI		Weight (LB/FT)	Clamp
		Inch	MM	Inch	MM		SAE J20 R1	TMC		
5581-038	5501-038	0.38	10	0.77	20	600	425	125	0.16	2582-0006
5581-050	5501-050	0.50	13	0.89	23	600	425	125	0.20	2582-0008
5581-062	5501-062	0.63	16	1.02	26	585	425	125	0.24	2582-0010
5581-075	5501-075	0.75	19	1.14	29	575	325	125	0.29	2582-0012
5581-087	5501-087	0.88	22	1.27	32	560	300	125	0.34	2582-0016
5581-100	5501-100	1.00	25	1.39	35	550	300	125	0.39	2582-0016 or 2584-0175
5581-112	5501-112	1.13	29	1.52	39	525	300	125	0.44	2582-0020 or 2584-0175
5581-125	5501-125	1.25	32	1.64	42	500	275	125	0.49	2582-0020 or 2584-0212
5581-138	5501-138	1.38	35	1.77	45	475	250	125	0.54	2582-0024 or 2584-0212
5581-150	5501-150	1.50	38	1.89	48	450	250	125	0.59	2582-0024 or 2584-0212
5581-162	5501-162	1.63	41	2.02	51	425	225	125	0.63	2582-0028 or 2584-0262
5581-175	5501-175	1.75	44	2.14	54	400	225	125	0.68	2582-0028 or 2584-0262
5581-187	5501-187	1.88	48	2.27	58	400	200	100	0.73	2582-0032 or 2584-0262
5581-200	5501-200	2.00	51	2.39	61	400	200	100	0.78	2582-0032 or 2584-0262
5581-212	5501-212	2.13	54	2.52	64	375	175	100	0.83	2582-0036 or 2584-0312
5581-225	5501-225	2.25	57	2.64	67	350	175	100	0.88	2582-0036 or 2584-0312
5581-238	5501-238	2.38	60	2.77	70	325	150	100	0.93	2582-0040 or 2584-0312
5581-250	5501-250	2.50	64	2.89	73	300	150	100	0.98	2582-0040 or 2584-0312
5581-262	5501-262	2.63	67	3.02	77	285	125	100	1.02	2582-0044 or 2584-0362
5581-275	5501-275	2.75	70	3.14	80	275	125	100	1.07	2582-0044 or 2584-0362
5581-287	5501-287	2.88	73	3.27	83	250	100	100	1.12	2582-0048 or 2584-0362
5581-300	5501-300	3.00	76	3.39	86	250	100	100	1.17	2582-0048 or 2584-0362
5581-312	5501-312	3.13	80	3.52	89	225	75	100	1.22	2582-0052 or 2584-0412
5581-325	5501-325	3.25	83	3.64	92	225	75	100	1.27	2582-0052 or 2584-0412
5581-338	5501-338	3.38	86	3.77	96	200	75	100	1.32	2582-0056 or 2584-0412
5581-350	5501-350	3.50	89	3.89	99	200	75	100	1.37	2582-0056 or 2584-0412
5581-375	5501-375	3.75	95	4.14	105	175	50	100	1.46	2582-0060 or 2584-0462
5581-400	5501-400	4.00	102	4.39	112	150	50	100	1.56	2582-0064 or 2584-0462
5581-450	5501-450	4.50	114	4.89	124	150	N/A	N/A	1.76	2582-0072 or 2584-0512
5581-500	5501-500	5.00	127	5.39	137	125	N/A	N/A	1.95	2584-0562
5581-550	5501-550	5.50	140	5.89	150	100	N/A	N/A	2.16	2584-0612
5581-600	5501-600	6.00	152	6.39	162	100	N/A	N/A	2.34	2584-0662

\*Specifications for reference only. Specific test data available on request.





# 5415 SERIES: 3-PLY GLOSSY COOLANT HOSE



Ideal for high-performance environments where oil splash is present, Flexfab's 3-ply glossy lined polyester coolant hose stands out for its strength and durability. It won't harden, crack, or leak, and resists aging, a range of chemicals, ozone, and UV rays.

## CONSTRUCTION:

- + Silicone hose with 3-ply of polyester reinforcement
- + Available in:
- + Stocked in 3' lengths

## SPECIFICATIONS:

- + Meets or exceeds the operating requirements of SAE J20 R1 Class A
- + Meets or exceeds the operating requirements of TMC RP303B Class I Grade II
- + Standard wall thickness is .140"/.190"
- + Working pressure is 1/3 of the burst pressure
- + Resists hardening, cracking, cold leaks, aging, and many chemicals
- + Ideal for extreme temperature and various pressure ranges where high performance levels are required

## BENEFITS

- Extreme Temperature Resistance
- Extreme Duty Cycle Tested for Hostile Engine Environments
- Durable Construction for Various Pressure Ranges
- Glossy Exterior Ideal Where Oil Splash is Present

## CUSTOM ENGINEERED TO WITHSTAND:



## TEMPERATURE RANGE:

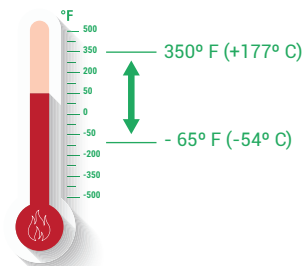

## 5415 SERIES: 3-PLY GLOSSY COOLANT HOSE

Part Number	Inside Diameter		Outside Diameter		Actual Burst Pressure - PSI	Burst Pressure - PSI		Weight (LB/FT)	Clamp
	Inch	MM	Inch	MM		SAE J20 R1	TMC		
5415-038	0.38	10	0.70	18	500	425	125	0.12	-
5415-050	0.50	13	0.82	21	500	425	125	0.16	2582-0006
5415-062	0.63	16	0.95	24	485	425	125	0.20	2582-0010
5415-075	0.75	19	1.07	27	475	325	125	0.24	2582-0012
5415-087	0.88	22	1.20	30	465	300	125	0.28	2582-0012
5415-100	1.00	25	1.32	34	450	300	125	0.32	2582-0016
5415-112	1.13	29	1.45	37	435	300	125	0.36	2582-0016 or 2584-0175
5415-125	1.25	32	1.57	40	425	275	125	0.40	2582-0020 or 2584-0175
5415-138	1.38	35	1.70	43	400	250	125	0.44	2582-0020 or 2584-0212
5415-150	1.50	38	1.82	46	375	250	125	0.48	2582-0024 or 2584-0212
5415-162	1.63	41	1.95	50	350	225	125	0.52	2582-0024 or 2584-0212
5415-175	1.75	44	2.07	53	300	225	125	0.56	2582-0028 or 2584-0262
5415-187	1.88	48	2.20	56	250	200	100	0.60	2582-0032 or 2584-0262
5415-200	2.00	51	2.32	59	250	200	100	0.64	2582-0032 or 2584-0262
5415-212	2.13	54	2.45	62	235	175	100	0.68	2582-0032 or 2584-0262
5415-225	2.25	57	2.57	65	225	175	100	0.72	2582-0036 or 2584-0312
5415-238	2.38	60	2.70	69	210	150	100	0.76	2582-0040 or 2584-0312
5415-250	2.50	64	2.82	72	200	150	100	0.80	2582-0040 or 2584-0312
5415-262	2.63	67	2.95	75	200	125	100	0.84	2582-0040 or 2584-0312
5415-275	2.75	70	3.07	78	200	125	100	0.88	2582-0044 or 2584-0362
5415-287	2.88	73	3.20	81	200	100	100	0.92	2582-0044 or 2584-0362
5415-300	3.00	76	3.32	84	200	100	100	0.96	2582-0048 or 2584-0362
5415-312	3.13	80	3.45	88	175	75	100	1.00	2582-0048 or 2584-0362
5415-325	3.25	83	3.57	91	175	75	100	1.04	2582-0052 or 2584-0412
5415-338	3.38	86	3.70	94	150	75	100	1.08	2582-0052 or 2584-0412
5415-350	3.50	89	3.82	97	150	75	100	1.12	2582-0056 or 2584-0412
5415-375	3.75	95	4.07	103	135	50	100	1.20	2582-0060 or 2584-0412
5415-387	3.88	99	4.20	107	125	50	100	1.24	2582-0060 or 2584-0462
5415-400	4.00	102	4.32	110	125	50	100	1.28	2582-0064 or 2584-0462
5415-450	4.50	114	4.82	122	100	N/A	N/A	1.44	2582-0072 or 2584-0512
5415-500	5.00	127	5.32	135	90	N/A	N/A	1.60	2584-0562
5415-550	5.50	140	5.82	148	75	N/A	N/A	1.76	2584-0612
5415-600	6.00	152	6.32	161	75	N/A	N/A	1.92	2584-0662

\*Specifications for reference only. Specific test data available on request.



# 5508 SERIES:

## WIRE REINFORCED COOLANT HOSE



This coolant hose is reinforced with two plies of polyester reinforcement, with helical wire that allows for some forced curvature. This design makes it an ideal solution for heavy duty pressure connections in hostile engine environments.

### CONSTRUCTION:

- + Silicone hose with 2-ply of polyester reinforcement, with helical wire
- + Available in: 
- + Stocked in 3' lengths
- + 12' lengths also available (call for availability)

### SPECIFICATIONS:

- + Meets or exceeds the operating requirements of SAE J20 R2 Class A 
- + Wall thickness at Hose ends exclusive of Wire Gauge .130"/.180"
- + Working pressure is 1/3 of the burst pressure
- + Negative pressure is -10 PSI

## BENEFITS

- ✓ Extreme Temperature Resistance
- ✓ Helical Wire Construction
- ✓ Withstand Vacuum Pressures
- ✓ Extreme Duty Cycle Tested for Hostile Engine Environments
- ✓ Engineered for Heavy Duty Pressure Connections
- ✓ Wire Reinforced Coolant Hoses are Designed to Handle Vacuum and/or Some Forced Curvature

### CUSTOM ENGINEERED TO WITHSTAND:



### TEMPERATURE RANGE:

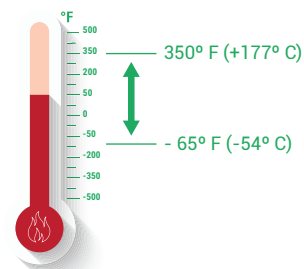

# 5508 SERIES: WIRE REINFORCED COOLANT HOSE

Part Number	Inside Diameter		Outside Diameter		Burst Pressure PSI	Max Neg. PSI	Bend Radius (Inch)	Weight (LB/FT)
	Inch	MM	Inch	MM				
5508-050	0.50	13	0.92	23	600	10	2.00	0.17
5508-062	0.63	16	1.05	27	600	10	2.25	0.21
5508-075	0.75	19	1.17	30	600	10	2.50	0.23
5508-087	0.88	22	1.30	33	550	10	2.75	0.26
5508-100	1.00	25	1.42	36	550	10	3.00	0.30
5508-125	1.25	32	1.67	42	525	10	3.50	0.36
5508-150	1.50	38	1.92	49	500	10	4.00	0.43
5508-175	1.75	44	2.17	55	475	10	4.50	0.51
5508-200	2.00	51	2.42	61	450	10	5.00	0.56
5508-225	2.25	57	2.67	68	400	10	5.50	0.65
5508-250	2.50	64	2.92	74	350	10	6.00	0.74
5508-275	2.75	70	3.17	81	325	10	6.50	0.79
5508-300	3.00	76	3.42	87	300	10	7.00	0.85
5508-350	3.50	89	3.92	100	275	10	8.00	1.09
5508-400	4.00	102	4.42	112	250	10	9.00	1.19
5508-600	6.00	152	6.42	163	125	10	13.00	1.84

\*Specifications for reference only. Specific test data available on request.





# HIGH TEMP COOLANT HOSE



## BENEFITS

Our high temperature coolant hose features a thicker wall that offers higher pressure handling than standard hoses. Strong and reliable, it withstands the hardening, cracking, and leaks that can be present in hostile engine environments. Plus, it's resistant to aging and chemicals, including coolant additives.

### CONSTRUCTION:

- + Silicone
- + Meta-Aramid
- + Available in various standard lengths\*

### SPECIFICATIONS:

- + Meets or exceeds SAE J20 R1 H.T.
- + Standard wall thickness available in 3/8" - 2 1/2" diameter
- + Heavy wall thickness available in 2 5/8" - 6" diameter
- + Extreme pressure resistance up to 175 PSIG

- ✓ Extreme Temperature Resistance
- ✓ Extreme Duty Cycle Tested for Hostile Engine Environments
- ✓ Pressure Endurance
- ✓ Available in Various Lengths

### CUSTOM ENGINEERED TO WITHSTAND:



### TEMPERATURE RANGE:

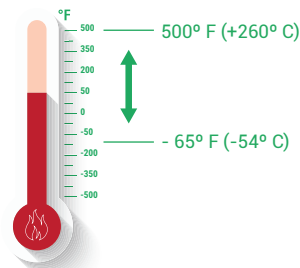

# HIGH TEMP COOLANT HOSE:

Part Number	Wall Thickness		Inside Diameter		Outside Diameter		Pressure Ratings	
	Min	Max	Inch	MM	Inch	MM	Working (PSI)	Burst (PSI)
5780-038	0.170	0.220	0.38	10	0.77	20	175	600
5780-050	0.170	0.220	0.50	13	0.89	23	175	600
5780-062	0.170	0.220	0.63	16	1.02	26	175	575
5780-075	0.170	0.220	0.75	19	1.14	29	175	575
5780-087	0.170	0.220	0.88	22	1.27	32	150	550
5780-100	0.170	0.220	1.00	25	1.39	35	150	550
5780-112	0.170	0.220	1.13	29	1.52	39	150	500
5780-125	0.170	0.220	1.25	32	1.64	42	150	500
5780-138	0.170	0.220	1.38	35	1.77	45	150	450
5780-150	0.170	0.220	1.50	38	1.89	48	150	450
5780-162	0.170	0.220	1.62	41	2.01	51	125	400
5780-175	0.170	0.220	1.75	44	2.14	54	125	400
5780-187	0.170	0.220	1.88	48	2.27	58	125	400
5780-200	0.170	0.220	2.00	51	2.39	61	125	400
5780-212	0.170	0.220	2.13	54	2.52	64	100	350
5780-225	0.170	0.220	2.25	57	2.64	67	100	350
5780-238	0.170	0.220	2.38	60	2.77	70	100	300
5780-250	0.170	0.220	2.50	64	2.89	73	100	300
5780-262	0.220	0.279	2.63	67	3.13	79	80	275
5780-275	0.220	0.279	2.75	70	3.25	83	80	275
5780-287	0.220	0.279	2.88	73	3.38	86	80	250
5780-300	0.220	0.279	3.00	76	3.50	89	80	250
5780-312	0.220	0.279	3.13	80	3.63	92	60	200
5780-325	0.220	0.279	3.25	83	3.75	95	60	200
5780-338	0.220	0.279	3.38	86	3.88	99	60	200
5780-350	0.220	0.279	3.50	89	4.00	102	60	200
5780-375	0.220	0.279	3.75	95	4.25	108	50	150
5780-400	0.220	0.279	4.00	102	4.50	114	50	150
5780-450	0.220	0.279	4.50	114	5.00	127	40	120
5780-500	0.220	0.279	5.00	127	5.50	140	35	105
5780-550	0.220	0.279	5.50	140	6.00	152	30	100
5780-600	0.220	0.279	6.00	152	6.50	165	30	100



# 5526 SERIES:

## STANDARD HEATER HOSE





Engineered with superior flexibility and durability, Flexfab's standard heater hose is resistant to coolant additives, as well as hardening, cracking, cold leaks, and aging. It's extreme duty cycle tested.

### CONSTRUCTION:

- + Silicone hose with 1-ply of nylon fiber reinforcement
- + Available in: 
- + Stocked in 25' and 50' boxes
- + Available in longer lengths on standard wooden spools\*  
\*Continuous lengths are not guaranteed, if continuous lengths are required please contact a sales rep for price and availability

### SPECIFICATIONS:

- + Meets or exceeds the operating requirements of SAE J20 R3 Class A 
- + Meets or exceeds the operating requirements of TMC RP303B Class I Grade II 
- + Standard wall thickness is .140"/.170"
- + Working pressure is 1/3 of the burst pressure
- + Bend radius is 5 times the ID of the hose
- + Resists hardening, cracking, cold leaks, aging, and many chemicals

## BENEFITS

- ✓ Box and Spool Lengths Available
- ✓ Extreme Temperature Resistance
- ✓ Superior Flexibility
- ✓ Extreme Duty Cycle Tested for Hostile Engine Environments
- ✓ Durable Construction
- ✓ Resistant to Coolant Additives

### CUSTOM ENGINEERED TO WITHSTAND:



### TEMPERATURE RANGE:

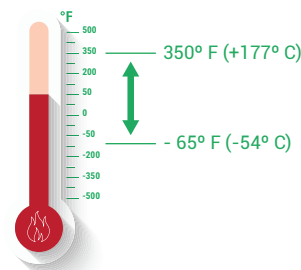

## 5526 SERIES: STANDARD HEATER HOSE

Part Number	Inside Diameter		Outside Diameter		Actual Burst Pressure - PSI	Burst Pressure - PSI		Weight (LB/FT)	Overall Length (Feet)	Clamp
	Inch	MM	Inch	MM		SAE J20 R1	TMC			
5526-025x25	0.25	6	0.58	15	320	250	125	0.111	25' Box	
5526-025x50	0.25	6	0.58	15	320	250	125	0.111	50' Box	-
5526-025x250	0.25	6	0.58	15	320	250	125	0.111	250' Spool	-
5526-025x800	0.25	6	0.58	15	320	250	125	0.111	800' Spool	-
5526-031x25	0.31	8	0.64	16	310	250	125	0.128	25' Box	-
5526-031x50	0.31	8	0.64	16	310	250	125	0.128	50' Box	-
5526-031x600	0.31	8	0.64	16	310	250	125	0.128	600' Spool	-
5526-038x25	0.38	10	0.71	18	310	250	125	0.145	25' Box	2582-0006
5526-038x50	0.38	10	0.71	18	310	250	125	0.145	50' Box	2582-0006
5526-038x250	0.38	10	0.71	18	310	250	125	0.145	250' Spool	2582-0006
5526-038x600	0.38	10	0.71	18	310	250	125	0.145	600' Spool	2582-0006
5526-050x25	0.50	13	0.83	21	310	250	125	0.181	25' Box	2582-0006
5526-050x50	0.50	13	0.83	21	310	250	125	0.181	50' Box	2582-0006
5526-050x250	0.50	13	0.83	21	310	250	125	0.181	250' Spool	2582-0006
5526-050x500	0.50	13	0.83	21	310	250	125	0.181	500' Spool	2582-0006
5526-062x25	0.63	16	0.96	24	300	250	125	0.216	25' Box	2582-0008
5526-062x50	0.63	16	0.96	24	300	250	125	0.216	50' Box	2582-0008
5526-062x250	0.63	16	0.96	24	300	250	125	0.216	250' Spool	2582-0008
5526-062x400	0.63	16	0.96	24	300	250	125	0.216	400' Spool	2582-0008
5526-075x25	0.75	19	1.08	27	300	200	125	0.25	25' Box	2582-0010
5526-075x50	0.75	19	1.08	27	300	200	125	0.25	50' Box	2582-0010
5526-075x250	0.75	19	1.08	27	300	200	125	0.25	250' Spool	2582-0010
5526-075x300	0.75	19	1.08	27	300	200	125	0.25	300' Spool	2582-0010
5526-087x25	0.88	22	1.21	31	250	175	125	0.287	25' Box	2582-0012
5526-087x50	0.88	22	1.21	31	250	175	125	0.287	50' Box	2582-0012
5526-087x200	0.88	22	1.21	31	250	175	125	0.287	200' Spool	2582-0012
5526-100x25	1.00	25	1.33	34	250	175	125	0.324	25' Box	2582-0016
5526-100x50	1.00	25	1.33	34	250	175	125	0.324	50' Box	2582-0016
5526-100x200	1.00	25	1.33	34	250	175	125	0.324	200' Spool	2582-0016
5526-125x25	1.25	32	1.58	40	200	175	125	0.385	25' Box	2582-0020
5526-125x50	1.25	32	1.58	40	200	175	125	0.385	50' Box	2582-0020
5526-125x150	1.25	32	1.58	40	200	175	125	0.385	150' Spool	2582-0020

\*Specifications for reference only. Specific test data available on request.







# 5521 AND 5834 SERIES:

## PREMIUM HEATER HOSE





Our premium heater hose features a thicker wall that offers higher pressure handling than standard hoses. Strong and reliable, it withstands the hardening, cracking, and leaks that can be present in hostile engine environments. Plus, it's resistant to aging and chemicals, including coolant additives.

### CONSTRUCTION:

- + 5521 Series: silicone hose with 1-ply of nylon fiber reinforcement. Green cover, red liner
  - + Available in: 
  - + 5834 Series: silicone hose with 1-ply of para-aramid fiber reinforcement. Blue cover, red liner
  - + Available in: 
  - + Stocked in 25' and 50' boxes
  - + Available in longer lengths on standard wooden spools\*
- \*Continuous lengths are not guaranteed, if continuous lengths are required please contact a sales rep for price and availability

### SPECIFICATIONS:

- + Meets or exceeds the operating requirements of SAE J20 R3 Class A 
- + Meets or exceeds the operating requirements of TMC RP303B Class I Grade II 
- + Standard wall thickness is .170"/.220"
- + Working pressure is 1/3 of the burst pressure
- + Resists hardening, cracking, cold leaks, aging, and many chemicals

## BENEFITS

- ✓ Box and Spool Lengths\*
- ✓ Extreme Temperature Resistance
- ✓ Extreme Duty Cycle Tested for Hostile Engine Environments
- ✓ Superior Flexibility
- ✓ Bend Radius is 5 x ID
- ✓ Durable Construction
- ✓ Resistant to Coolant Additives
- ✓ Pressure Endurance
- ✓ Thicker Wall Offers Higher Pressure Handling

### CUSTOM ENGINEERED TO WITHSTAND:



### TEMPERATURE RANGE:

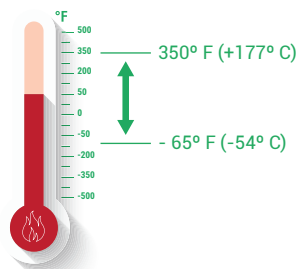

## 5521 SERIES: PREMIUM HEATER HOSE (GREEN)

Part Number	Inside Diameter		Outside Diameter		Actual Burst Pressure - PSI	Burst Pressure - PSI		Weight (LB/FT)	Overall Length (Feet)	Clamp
	Inch	MM	Inch	MM		SAE J20 R1	TMC			
5521-025x50	0.25	6	0.64	16	475	475	125	0.121	50' Box	-
5521-025x800	0.25	6	0.64	16	475	475	125	0.121	800' Spool	-
5521-031x25	0.31	8	0.70	18	475	475	125	0.151	25' Box	-
5521-031x50	0.31	8	0.70	18	475	475	125	0.151	50' Box	-
5521-031x600	0.31	8	0.70	18	475	475	125	0.151	500' Spool	-
5521-038x25	0.38	10	0.77	20	475	475	125	0.181	25' Box	2582-0006
5521-038x50	0.38	10	0.77	20	475	475	125	0.181	50' Box	2582-0006
5521-038x500	0.38	10	0.77	20	475	475	125	0.181	600' Spool	2582-0006
5521-050x25	0.50	13	0.89	23	425	425	125	0.226	25' Box	2582-0006
5521-050x50	0.50	13	0.89	23	425	425	125	0.226	50' Box	2582-0006
5521-050x500	0.50	13	0.89	23	425	425	125	0.226	500' Spool	2582-0006
5521-062x25	0.63	16	1.02	26	375	375	125	0.258	25' Box	2582-0010
5521-062x50	0.63	16	1.02	26	375	375	125	0.258	50' Box	2582-0010
5521-062x400	0.63	16	1.02	26	375	375	125	0.258	400' Spool	2582-0010
5521-075x25	0.75	19	1.14	29	325	325	125	0.301	25' Box	2582-0012
5521-075x50	0.75	19	1.14	29	325	325	125	0.301	50' Box	2582-0012
5521-075x300	0.75	19	1.14	29	325	325	125	0.301	300' Spool	2582-0012
5521-087x25	0.88	22	1.27	32	300	300	125	0.346	25' Box	2582-0012
5521-087x50	0.88	22	1.27	32	300	300	125	0.346	50' Box	2582-0012
5521-087x200	0.88	22	1.27	32	300	300	125	0.346	150' Spool	2582-0012
5521-100x25	1.00	25	1.39	35	300	300	125	0.391	25' Box	2582-0016
5521-100x50	1.00	25	1.39	35	300	300	125	0.391	50' Box	2582-0016
5521-100x200	1.00	25	1.39	35	300	300	125	0.391	200' Spool	2582-0016
5521-125x25	1.25	32	1.64	42	200	275	125	0.491	25' Box	2582-0020
5521-125x50	1.25	32	1.64	42	200	275	125	0.491	50' Box	2582-0020
5521-125x150	1.25	32	1.64	42	200	275	125	0.491	150' Spool	2582-0020

\*Specifications for reference only. Specific test data available on request.

## 5834 SERIES: PREMIUM HEATER HOSE (BLUE)

Part Number	Inside Diameter		Outside Diameter		Actual Burst Pressure - PSI	Burst Pressure - PSI		Weight (LB/FT)	Overall Length (Feet)	Clamp
	Inch	MM	Inch	MM		SAE J20 R1	TMC			
5834-112x50	1.13	29	1.52	38	250	275	125	0.438	50' Box	2582-0020
5834-112x150	1.13	29	1.52	38	250	275	125	0.438	150' Spool	2582-0020

\*Specifications for reference only. Specific test data available on request.

# PRE-CUT HOSE

*OUR RELIABLE AND DURABLE STICK-HOSES CAN BE PRE-CUT WHEN YOU ORDER.*

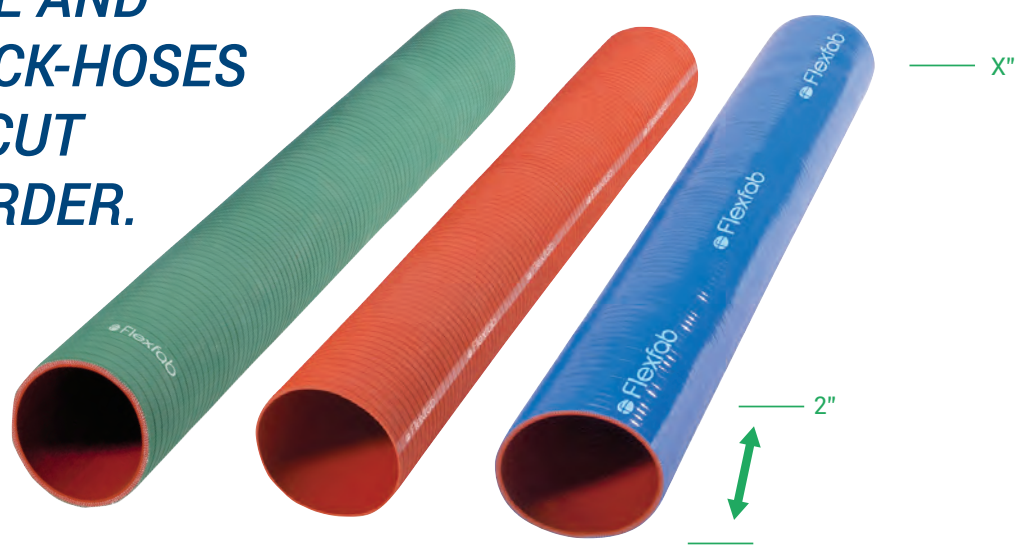

## PRE-CUT OPTIONS:

Hoses are 3'-12' long.  
Offered for our 3 & 4 ply hoses.  
Minimum length as small as 2".  
Pre-cut charges are applicable.

## PRODUCT SKUS AVAILABLE:

5500, 5501, 5515, 5381, 5415, 7703, 7701, 7851

**FOR MORE INFORMATION CALL (888)-353-9344 OR  
EMAIL US AT [DISTRIBUTION@FLEXFAB.COM](mailto:distribution@flexfab.com).**

# COLOR COMPARISON

## COOLANT HOSE

You can order our coolant hose in blue and green. In this instance, the color is only about preference. Each version provides the same reliability.



## HEATER HOSE

Hoses can be purchased in blue or green. There is a difference between them. The green heater hose features a thicker wall that offers higher pressure handling than standard hoses. The blue offers the same great quality, with a thinner wall.





# SPECIALTY HOSES:



A.



B.



C.



D.

Designed for unique applications, Flexfab's specialty hoses are durable, long lasting, and built to withstand extreme temperature environments. Their maximum operating pressure ranges from 30 PSI for the coolant sleeve to 55 PSI for the charge air 45° elbow.

## A. 7730-0001: Coolant Sleeve

- + Specially designed coolant hose for unique applications. Sales should be consulted before use in new applications as pressure ratings are very specific.
- + Hose can also be used for a cold side charge air-cooler application
- + 4-ply polyester reinforced hose
- + Maximum operating pressure is 30 PSI
- + Temperature range is -65°F (-54°C) to +350°F (+177°C)

### CUSTOM ENGINEERED TO WITHSTAND:



## B. 7967: Coolant Bellows

- + Meets or exceeds the operating requirements of SAE J20 R1 Class A
- + Once installed, the hose can handle up to 1.00" of lateral movement in the application
- + 3-Ply Polyester reinforced hose
- + Maximum operating pressure is 50 PSI
- + Temperature range is -65°F (-54°C) to +350°F (+177°C)

### CUSTOM ENGINEERED TO WITHSTAND:



### C. 7965: Coolant Elbow

- + Meets or exceeds the operating requirements of SAE J20 R1 Class A 
- + Used for a 90° coolant connection between pipes
- + Tighter bend radius than most other 90° elbows
- + 4-ply polyester reinforced hose
- + Maximum operating pressure is 50 PSI
- + Temperature range is -65°F (-54°C) to +350°F (+177°C)

#### CUSTOM ENGINEERED TO WITHSTAND:



### D. 7902: Charge Air 45° Elbow

- + Used for a 45° hot side charge air connection between pipes
- + 6-ply meta-aramid reinforced hose
- + Maximum operating pressure is 55 PSI
- + Temperature range is - 65°F (54°C) to +450°F (+232°C)

#### CUSTOM ENGINEERED TO WITHSTAND:



## SPECIALTY HOSES:

Part Number	Inside Diameter		Outside Diameter		Overall Length Inches	Stainless Steel Rings	Burst Pressure - PSI	Weight LBS	Clamp
	Inch	MM	Inch	MM					
A. 7730-0001	3.00	76	3.23	82	6.00	No	90	0.5	2582-0043 or 2584-0362
B. 7967	2.50	64	2.82	72	8.50	Yes	150	0.5	2582-0040 or 2584-0312
C. 7965	2.50	64	2.92	74	10.00	No	150	0.5	2582-0040 or 2584-0312
D. 7902	3.50/4.00	89/102	4.17/4.67	106/119	8.75	No	165	0.5	2583-0350/2583-0400

\*Specifications for reference only. Specific test data available on request.



# 5001 SERIES:

## HEATER HOSE REPAIR KIT



Reduce engine downtime and make quick repairs on the road with this heater hose repair kit. The kit contains 300-grade stainless steel lined worm gear clamps, 5/16" clamp head, and 9/16" clamp band.



### CONSTRUCTION:

- + Anodized aluminum construction
- Corrosion resistance

### SPECIFICATIONS:

- + Bead height per AS5131 specification
- + Meets anodized aluminum specification MIL-A8625 
- + 300 grade stainless steel lined worm gear clamps
- + Clamp hex head 5/16"
- + Clamp band width 9/16"

### BENEFITS

-  Quick Repairs on the Road  
-Reduce Engine Downtime
-  Lasts Until Next Service

## 5001 SERIES: HEATER HOSE REPAIR KIT

Part Number	Connector and Clamp	Outside Diameter		Bead Height (AS5131)	Overall Length (Feet)	Use With
	Provided in Kit	Inch	MM			
KIT5001D	DEA-36519-0625	0.63	16	.047-.087	3.00	5526-062
	FLX2582-0008	N/A	N/A	N/A	N/A	-
KIT5002D	DEA-36519-0750	0.75	19	.047-.087	3.00	5526-075
	FLX2582-0010	N/A	N/A	N/A	N/A	-
KIT5003D	DEA-36519-1000	1.00	25	.047-.087	3.00	5526-100
	FLX2582-0016	N/A	N/A	N/A	N/A	-

\*Specifications for reference only.





# CHARGE AIR CONNECTOR (CAC)

## CONVOLUTED REDUCERS



Get great value with Flexfab's charge air convoluted (CAC) reducers. They can be used on both hot side and cold side of the CAC system and are constructed with 4-ply silicone coated meta-aramid fabric. Custom engineered to withstand harsh environments, they are resistant to extreme temperatures and pressures.

### CONSTRUCTION:

+ 4-ply silicone coated meta-aramid fabric with stainless steel pressure retention rings where noted

### SPECIFICATIONS:

+ Wall thickness is .092"/.132"

## BENEFITS

- ✓ Can be Used on Both Hot Side and Cold Side of the CAC System
- ✓ Extreme Temperature Resistance
- ✓ Extreme Duty Cycle Tested for Hostile Engine Environments
- ✓ High Pressure Resistance

### CUSTOM ENGINEERED TO WITHSTAND:



COOL TEMPS



HOT TEMPS



OIL SPLASH RESISTANCE



OZONE RESISTANT



DIRECT SUNLIGHT

### TEMPERATURE RANGE:

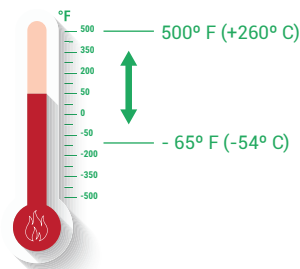

# CHARGE AIR CONNECTOR (CAC) CONVOLUTED REDUCERS

Part Number	Inside Diameter		Outside Diameter		Overall Length Inches	Convolute (Humps)	Stainless Steel Rings	Max Operating Pressure - PSI	Weight LBS	Clamp
	Inch	MM	Inch	MM						
7868	2.50/3.00	64/76	2.73/3.23	69/82	4.00	1	None	40	0.5	2583-0250/2583-0300 2584-0312/2584-0362
7726	3.00/3.50	76/89	3.23/3.73	82/95	5.00	1	2	55	0.5	2583-0300/2583-0350 2584-0362/2584-0412
7766	3.00/4.00	76/102	3.23/4.23	82/107	6.30	1	2	50	0.5	2583-0300/2583-0400 2584-0362/2584-0462
7880	3.50/4.00	89/102	3.73/4.23	95/107	6.00	2	2	50	0.5	2583-0350/2583-0400 2584-0412/2584-0462
7711	4.00/4.50	102/114	4.23/4.73	107/120	6.00	1	None	30	0.5	2583-0400/2583-0450 2584-0462/2584-0512
7866	4.00/4.50	102/114	4.23/4.73	107/120	7.00	2	3	45	0.6	2583-0400/2583-0450 2584-0462/2584-0512

\*Specifications for reference only. Specific test data available on request.



# CHARGE AIR CONNECTOR (CAC)

## HOT SIDE AND COLD SIDE



This charge air connector for the hot side features 4-ply silicone coated meta-aramid fabric with stainless steel pressure retention rings.

This charge air connector for the cold side features 3-ply silicone coated polyester fabric with stainless steel pressure retention rings.

### CONSTRUCTION:

- + Hot Side: 4-ply silicone coated meta-aramid fabric with stainless steel pressure retention rings
- + Cold Side: 3-ply silicone coated polyester fabric with stainless steel pressure retention rings

### SPECIFICATIONS:

- + Hot Side: wall thickness is .085"/.135"
- + Cold Side: wall thickness is .084"/.130"

## BENEFITS

- ✓ Extreme Temperature Resistance
- ✓ Extreme Duty Cycle Tested for Hostile Engine Environments
- ✓ High Pressure Resistance

### CUSTOM ENGINEERED TO WITHSTAND:



### TEMPERATURE RANGE: HOT SIDE      TEMPERATURE RANGE: COLD SIDE

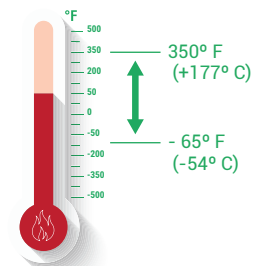
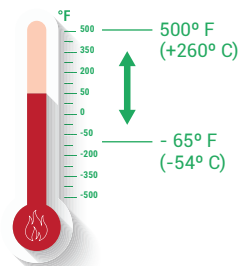



## CHARGE AIR CONNECTOR (CAC) – HOT SIDE

Part Number	Inside Diameter		Outside Diameter		Overall Length Inches	Convolutes (Humps)	Stainless Steel Rings	Max Operating Pressure - PSI	Weight LBS	Clamp
	Inch	MM	Inch	MM						
7887	2.50	64	2.73	69	6.00	2	3	60	0.5	2583-0250 or 2584-0312
7731-0001	3.00	76	3.23	82	6.00	2	3	60	0.5	2583-0300 or 2584-0362
7732-0001	3.50	89	3.73	95	6.00	2	3	55	0.5	2583-0350 or 2584-0412
7717	3.50	89	3.73	95	7.50	2	3	55	0.5	2583-0350 or 2584-0462
7715-0002	4.00	102	4.23	107	6.00	2	3	50	0.5	2583-0400 or 2584-0462
7723	4.00	102	4.23	107	6.00	1	2	50	0.5	2583-0400 or 2584-0462
1020-0001	4.00	102	4.23	107	6.50	2	3	50	0.5	2583-0400 or 2584-0462
7716	4.00	102	4.23	107	7.00	2	3	50	0.6	2583-0400 or 2584-0462
7728	4.00	102	4.23	107	7.50	2	3	50	0.6	2583-0400 or 2584-0462
7727-0001	4.00	102	4.23	107	8.00	2	3	50	0.7	2583-0400 or 2584-0462
7742-0001	4.50	114	4.73	120	6.00	2	3	45	0.5	2583-0450 or 2584-0512
7797	5.00	127	5.23	133	6.00	2	3	35	0.5	2583-0500 or 2584-0562

\*Specifications for reference only. Specific test data available on request.



## CHARGE AIR CONNECTOR (CAC) – COLD SIDE

Part Number	Inside Diameter		Outside Diameter		Overall Length Inches	Convolutes (Humps)	Stainless Steel Rings	Max Operating Pressure - PSI	Weight LBS	Clamp
	Inch	MM	Inch	MM						
7758-0001	3.00	76	3.23	82	6.00	2	3	60	0.5	2583-0300 or 2584-0362
7753-0001	3.50	89	3.73	95	6.00	2	3	55	0.5	2583-0350 or 2584-0412
7755-0002	4.00	102	4.23	107	6.00	2	3	50	0.5	2583-0400 or 2584-0462
7759-0001	4.50	114	4.73	120	6.00	2	3	45	0.5	2583-0450 or 2584-0512

\*Specifications for reference only. Specific test data available on request.



# HEAVY-WALL CHARGE AIR CONNECTOR (CAC)

## HOT SIDE AND COLD SIDE



Exclusive to Flexfab, these heavy-wall charge air connectors feature clamp saddle design for proper clamp alignment, along with chamfered ID for easy installation. They are temperature and high pressure resistant.

### CAC CONSTRUCTION:

+ 4-ply heavy duty silicone coated meta-aramid fabric with heavy duty stainless steel pressure retention rings

### CAC SPECIFICATIONS:

+ Wall thickness is .117"/.163"

## FLUOROCARBON LINED CHARGE AIR CONNECTOR

These connectors have a fluorocarbon liner that the other heavy wall hoses don't have. They're designed to meet EPA 2007 and EURO IV & V reduced emissions requirements.

### CONSTRUCTION:

+ High temperature fluorocarbon elastomeric liner  
+ 4-ply heavy duty silicone coated meta-aramid fabric with heavy duty stainless steel pressure retention rings

### SPECIFICATIONS:

+ Wall thickness is .117"/.163"

## BENEFITS

- ✓ Extreme Temperature Resistance
- ✓ Extreme Duty Cycle Tested for Hostile Engine Environments
- ✓ Custom Design
- ✓ Clamp Saddle Design Allows for Proper Clamp Alignment
- ✓ Chamfered ID is Easy to Install

### CUSTOM ENGINEERED TO WITHSTAND:



### TEMPERATURE RANGE:

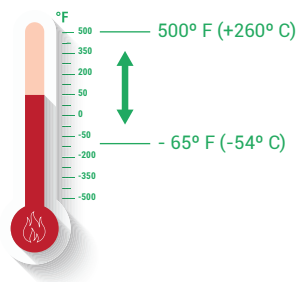



## HEAVY-WALL CHARGE AIR CONNECTOR (CAC) – HOT SIDE

Part Number	Inside Diameter		Outside Diameter		Overall Length Inches	Convolutes (Humps)	Stainless Steel Rings	Max Operating Pressure - PSI	Weight LBS	Clamp
	Inch	MM	Inch	MM						
4076-0001	2.50	64	2.73	69	6.00	2	3	80	0.5	2583-0250
4074-0001	3.00	76	3.23	82	6.00	2	3	70	0.5	2588-0306
4073-0001	3.50	89	3.73	95	6.00	2	3	70	0.5	2588-0356
4070-0001	4.00	102	4.23	107	6.00	2	3	70	0.5	2588-0406
4075-0001	4.50	114	4.73	120	6.00	2	3	60	0.5	2588-0456

\*Specifications for reference only. Specific test data available on request.



## HEAVY-WALL CHARGE AIR CONNECTOR (CAC) – COLD SIDE

Part Number	Inside Diameter		Outside Diameter		Overall Length Inches	Convolutes (Humps)	Stainless Steel Rings	Max Operating Pressure - PSI	Weight LBS	Clamp
	Inch	MM	Inch	MM						
4076-0002	2.50	64	2.73	69	6.00	2	3	80	0.5	2583-0250
4074-0002	3.00	76	3.23	82	6.00	2	3	70	0.5	2588-0306
4073-0002	3.50	89	3.73	95	6.00	2	3	70	0.5	2588-0356
4070-0002	4.00	102	4.23	107	6.00	2	3	70	0.5	2588-0406
4075-0002	4.50	114	4.73	120	6.00	2	3	60	0.5	2588-0456

\*Specifications for reference only. Specific test data available on request.



## FLUOROCARBON LINED CHARGE AIR CONNECTOR

Part Number	Inside Diameter		Outside Diameter		Overall Length Inches	Convolutes (Humps)	Stainless Steel Rings	Max Operating Pressure - PSI	Weight LBS	Clamp
	Inch	MM	Inch	MM						
1076-0003	2.50	64	2.73	69	6.00	2	3	80	0.5	2583-0250
1074-0003	3.00	76	3.23	82	6.00	2	3	70	0.5	2588-0306
1073-0003	3.50	89	3.73	95	6.00	2	3	70	0.5	2588-0356
1070-0003	4.00	102	4.23	107	6.00	2	3	70	0.5	2588-0406
1075-0003	4.50	114	4.73	120	6.00	2	3	60	0.5	2588-0456

\*Specifications for reference only. Specific test data available on request.





# 4000 SERIES:

## CHARGE AIR CONNECTOR HOSE AND CLAMP KITS



Flexfab's 4000 series CAC hose and clamp kits feature 4-ply silicone coated meta-aramid fabric with stainless steel pressure retention rings. They perform well in extreme temperatures and have all stainless steel spring-loaded T-bolt clamps. The clamps resist salt water and can be used in marine applications.

### APPLICATION:

+ Flexfab 4000 series clamp kits provide a CAC hose and 2 spring-loaded T-bolt clamps with each kit. Hoses provided in these kits are compatible with both hot or cold side of the charge air cooler system.

### CONSTRUCTION:

- + Charge air connector hose, 4-ply silicone coated meta-aramid fabric with stainless steel pressure retention rings
- + All stainless steel spring-loaded T-bolt clamps

### SPECIFICATIONS:

- + Charge air connector wall thickness is .085"/.135"
- + Spring-loaded T-bolt clamps: resists salt water and may be used in marine applications

## BENEFITS

- ✓ Extreme Temperature Resistance
- ✓ Extreme Duty Cycle Tested for Hostile Engine Environments
- ✓ High Pressure Resistance
- ✓ Salt Water Resistant Clamps

### CUSTOM ENGINEERED TO WITHSTAND:



### TEMPERATURE RANGE:

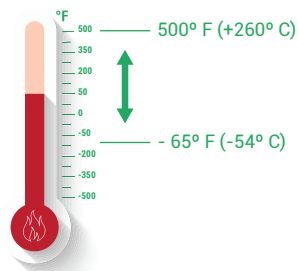

## 4000 SERIES: CHARGE AIR CONNECTOR HOSE AND CLAMP KITS

Part Number	Hose and Clamp Provided in Kit	Inside Diameter		Outside Diameter		Length Inches	Convulutes (Humps)	Stainless Steel Rings	Max Operating Pressure - PSI
		Inch	MM	Inch	MM overall				
KIT4001D	4070-0001	4.00	102	4.23	107	6.00	2	3	70
	FLX2588-0406	4.06	103	4.38	111	N/A	N/A	N/A	N/A
KIT4002D	4070-0002	4.00	102	4.23	107	6.00	2	3	70
	FLX2588-0406	4.06	103	4.38	111	N/A	N/A	N/A	N/A
KIT4003D	7727-0001	4.00	102	4.23	107	8.00	2	3	50
	FLX2588-0406	4.06	103	4.38	111	N/A	N/A	N/A	N/A
KIT4004D	4073-0001	3.50	89	3.73	95	6.00	2	3	70
	FLX2588-0356	3.56	91	3.88	98	N/A	N/A	N/A	N/A
KIT4005D	4074-0001	3.00	76	3.23	82	6.00	2	3	70
	FLX2588-0306	3.06	78	3.38	86	N/A	N/A	N/A	N/A

\*Specifications for reference only. Specific test data available on request.



# LARGE ID CHARGE AIR CONNECTOR (CAC)



Notice: Flexfab recommends double clamping at each end for proper installation.

Designed for use on both hot and cold sides of the charge air cooler systems, this connector has 6-ply silicone coated meta-aramid fabric with stainless steel pressure retention rings. It's engineered for extreme temperatures, and is both ozone and UV resistant. Used on diesel truck engines to deliver pressurized intake air to the charge air intercooler and intake manifold.

## CONSTRUCTION:

+ 6-ply silicone coated meta-aramid fabric with stainless steel pressure retention ring

## SPECIFICATIONS:

+ Wall thickness is .138"/.198"

## BENEFITS

- ✓ Extreme Temperature Resistance
- ✓ Can be Used on Both Hot Side or Cold Side of the Charge Air Cooler System
- ✓ Fuel and Oil Splash Resistant

## CUSTOM ENGINEERED TO WITHSTAND:



## TEMPERATURE RANGE:

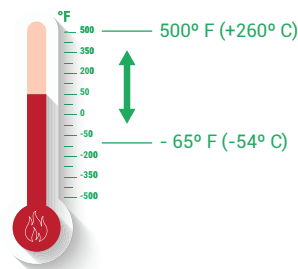

# LARGE ID CHARGE AIR CONNECTOR (CAC)

Part Number	Inside Diameter		Outside Diameter		Overall Length Inches	Convolutes (Humps)	Stainless Steel Rings	Max Operating Pressure - PSI	Weight LBS	Clamp
	Inch	MM	Inch	MM						
7968	6.00	152	6.34	161	8.00	2	3	50	1.42	2584-0662
7969	7.00	178	7.34	186	8.00	2	3	40	1.68	2584-0762
7970	8.00	203	8.34	212	8.00	2	3	40	1.92	2584-0862

\*Specifications for reference only. Specific test data available on request.



# 7701 SERIES:

## FIBERGLASS REINFORCED TURBO SLEEVES



To order (3 foot stick) reference part number: FLX7701-300  
To order (12 foot stick) reference part number: FLX7701-300x12

Flexfab's fiberglass reinforced turbo sleeves resist chemicals, steam, coolants and ozone. They are engineered with 3-ply silicone coated fiberglass reinforcement and can withstand extreme temperatures.

### CONSTRUCTION:

- + 3-ply silicone coated fiberglass fabric reinforcement
- + Stocked in 3' lengths
- + 12' lengths also available (please call for availability)

### SPECIFICATIONS:

- + Standard wall thickness is .080"/.110"

### APPLICATIONS:

- + For connection between the turbocharger and the engine (where no vibration is present)

## BENEFITS

- ✓ Resists Chemicals, Steam, Ozone, Coolants, and Aging Conditions
- ✓ Extreme Temperature Resistance

### CUSTOM ENGINEERED TO WITHSTAND:



### TEMPERATURE RANGE:

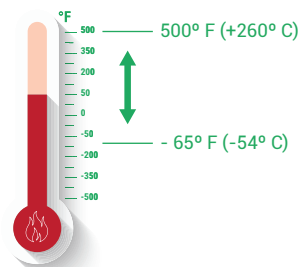

## 7701 SERIES: FIBERGLASS REINFORCED TURBO SLEEVES

Part Number	Inside Diameter		Outside Diameter		Burst Pressure (PSI)	Max Operating Pressure - PSI	Weight (LB/FT)	Clamp
	Inch	MM	Inch	MM				
7701-075	0.75	19	0.94	24	135	45	0.450	2582-0010
7701-087	0.88	22	1.07	27	135	45	0.475	2582-0010
7701-100	1.00	25	1.19	30	135	45	0.500	2582-0012
7701-112	1.12	28	1.31	33	120	40	0.525	2582-0016
7701-125	1.25	32	1.44	37	120	40	0.550	2583-0138 or 2584-0175
7701-138	1.38	35	1.57	40	120	40	0.575	2583-0138 or 2584-0175
7701-150	1.50	38	1.69	43	120	40	0.600	2583-0150 or 2584-0212
7701-162	1.63	41	1.82	46	105	35	0.625	2583-0162 or 2584-0212
7701-175	1.75	44	1.94	49	105	35	0.650	2583-0175 or 2584-0212
7701-187	1.88	48	2.07	53	105	35	0.675	2583-0187 or 2584-0212
7701-200	2.00	51	2.19	56	105	35	0.700	2583-0200 or 2584-0262
7701-212	2.13	54	2.32	59	90	30	0.725	2583-0212 or 2584-0262
7701-225	2.25	57	2.44	62	90	30	0.750	2583-0225 or 2584-0262
7701-238	2.38	60	2.57	65	90	30	0.775	2583-0238 or 2584-0312
7701-250	2.50	64	2.69	68	90	30	0.800	2583-0250 or 2584-0312
7701-262	2.63	67	2.82	72	75	25	0.825	2583-0262 or 2584-0312
7701-275	2.75	70	2.94	75	75	25	0.850	2583-0275 or 2584-0312
7701-287	2.88	73	3.07	78	75	25	0.875	2583-0287 or 2584-0362
7701-300	3.00	76	3.19	81	75	25	0.900	2583-0300 or 2584-0362
7701-312	3.13	80	3.32	84	60	20	0.925	2583-0312 or 2584-0362
7701-325	3.25	83	3.44	87	60	20	0.950	2583-0325 or 2584-0362
7701-338	3.38	86	3.57	91	60	20	0.975	2583-0338 or 2584-0412
7701-350	3.50	89	3.69	94	60	20	1.000	2583-0350 or 2584-0412
7701-375	3.75	95	3.94	100	45	15	1.050	2583-0375 or 2584-0412
7701-400	4.00	102	4.19	106	45	15	1.100	2583-0400 or 2584-0462
7701-425	4.25	108	4.44	113	30	10	1.150	2583-0425 or 2584-0462
7701-450	4.50	114	4.69	119	30	10	1.175	2583-0450 or 2584-0512
7701-500	5.00	127	5.19	132	30	10	1.200	2583-0500 or 2584-0562
7701-600	6.00	152	6.19	157	30	10	1.300	2584-0662

\*Specifications for reference only. Specific test data available on request.





# 7703 SERIES:

## HEAVY DUTY FIBERGLASS REINFORCED TURBO SLEEVES



Constructed with 6-ply heavy duty silicone coated fiberglass reinforcement, these sleeves provide resistance to extreme temperatures, chemicals, steam, ozone, and coolants.

### CONSTRUCTION:

- + 6-ply heavy duty silicone coated fiberglass fabric reinforcement
- + Stocked in 3' lengths only
- + Limited sizes available

### SPECIFICATIONS:

- + Standard wall thickness is .140"/.183"

### APPLICATIONS:

- + For connection between the turbocharger and the engine (where no vibration is present)

## BENEFITS

- ✓ Resists Chemicals, Steam, Ozone, Coolants, and Aging Conditions
- ✓ Extreme Temperature Resistance

### CUSTOM ENGINEERED TO WITHSTAND:



### TEMPERATURE RANGE:

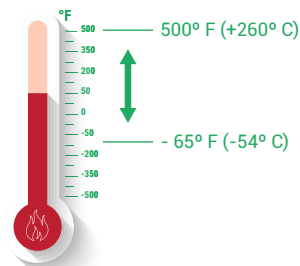

## 7703 SERIES: HEAVY DUTY FIBERGLASS REINFORCED TURBO SLEEVES

Part Number	Inside Diameter		Outside Diameter		Burst Pressure (PSI)	Max Operating Pressure - PSI	Weight (LB/FT)	Clamp
	Inch	MM	Inch	MM				
7703-200	2.00	51	2.63	67	210	70	1.4	2583-0212 or 2584-0262
7703-250	2.50	64	3.13	80	180	60	1.6	2583-0262 or 2584-0312
7703-300	3.00	76	3.63	92	150	50	1.8	2583-0312 or 2584-0362
7703-350	3.50	89	4.13	105	120	40	2.0	2583-0375 or 2584-0412
7703-400	4.00	102	4.63	118	90	30	2.2	2583-0400 or 2584-0462

\*Specifications for reference only. Specific test data available on request.

## COMPARE 7701 VS. 7703

Flexfab Turbo Sleeve Comparison Chart					
FLX7701 Series Turbo Sleeves					
Inside Diameter	7701-200	7701-250	7701-300	7701-350	7701-400
Operating Pressure PSIG	35	30	25	20	15
Burst Pressure PSIG	105	90	75	60	45

Flexfab Turbo Sleeve Comparison Chart					
FLX7703 Series Heavy Duty Turbo Sleeves					
Inside Diameter	7703-200	7703-250	7703-300	7703-350	7703-400
Operating Pressure PSIG	70	60	50	40	30
Burst Pressure PSIG	210	180	150	120	90

The 7703 series turbo sleeves were designed to handle higher pressure standards in certain applications. The chart above references the pressure details between the standard turbo sleeves 7701 series and the heavy duty version 7703 series.

\*Specifications for reference only. Specific test data available on request.



# 7851 SERIES:

## META-ARAMID REINFORCED TURBO SLEEVES



Built to resist extreme temperatures, ozone, and UV, Flexfab's meta-aramid reinforced turbo sleeves withstand the aging conditions that can be found in hostile engine environments.

### CONSTRUCTION:

- + 4-ply silicone coated meta-aramid fabric reinforcement
- + Stocked in 3' lengths only

### SPECIFICATIONS:

- + Standard wall thickness is .090"/.135"

### APPLICATIONS:

- + For connection between the turbocharger and the engine

## BENEFITS

- ✓ Resists Chemicals, Steam, Ozone, Coolants, and Aging Conditions
- ✓ Engineered for Hostile Engine Environments
- ✓ Extreme Temperature Resistance

### CUSTOM ENGINEERED TO WITHSTAND:



COOL TEMPS



HOT TEMPS



OIL SPLASH  
RESISTANCE



OZONE  
RESISTANT



DIRECT  
SUNLIGHT

### TEMPERATURE RANGE:

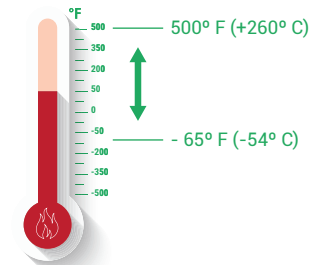

## 7851 SERIES: META-ARAMID REINFORCED TURBO SLEEVES

Part Number	Inside Diameter		Outside Diameter		Burst Pressure (PSI)	Max Operating Pressure - PSI	Weight (LB/FT)	Clamp
	Inch	MM	Inch	MM				
7851-100	1.00	25	1.23	31	135	45	0.50	2582-0012
7851-150	1.50	38	1.73	44	120	40	0.60	2583-0150 or 2584-0212
7851-200	2.00	51	2.23	57	105	35	0.70	2583-0200 or 2584-0262
7851-250	2.50	64	2.73	69	90	30	0.80	2583-0250 or 2584-0312
7851-300	3.00	76	3.23	82	75	25	0.90	2583-0300 or 2584-0362
7851-350	3.50	89	3.73	95	60	20	1.00	2583-0350 or 2584-0412
7851-400	4.00	102	4.23	107	45	15	1.10	2583-0400 or 2584-0462
7851-500	5.00	127	5.23	133	30	10	1.20	2583-0500 or 2584-0562
7851-600	6.00	152	6.23	158	30	10	1.30	2584-0662

\*Specifications for reference only. Specific test data available on request.



# 2563 SERIES:

## INDUSTRIAL SIL-FAB2™ NYLON ROD REINFORCED DUCT



Lightweight and non-kinking, Flexfab's nylon rod reinforced duct is vulcanized for long service life. It's resistant to extreme temperatures, ozone, and UV rays.

### CONSTRUCTION:

- + 2-ply silicone coated fiberglass fabric with nylon rod reinforcement (no cuffs)
- + Stocked in 12' lengths only
- + Helically wound nylon fiber for flexibility

### SPECIFICATIONS:

- + Vulcanized for long service life
- + Lightweight, non-kinking
- + Bend radius equals the inside diameter for hoses up to 2.50" ID
- + Bend radius equals 2 times the inside diameter for hoses 3.00" ID and over
- + Working pressure is 1/3 of the burst pressure
- + Ideal for brake duct cooling in race cars
- + Not recommended for handling liquids or abrasive materials
- + Not recommended for charge air applications

## BENEFITS

- ✓ Designed for Medium Pressure Handling of Air, Dust, Fumes, and Light Powders
- ✓ For Applications in Which Metal Wire May Interfere

### CUSTOM ENGINEERED TO WITHSTAND:



### TEMPERATURE RANGE:

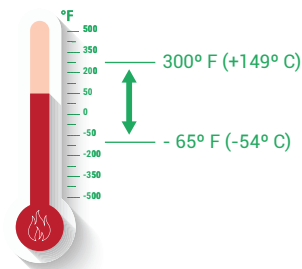

## 2563 SERIES: INDUSTRIAL SIL-FAB2™ NYLON ROD REINFORCED DUCT

Part Number	Inside Diameter		Outside Diameter		Burst Pressure (PSI)	Max. Neg. PSI	Max. Leakage CFM Bend Radius	Weight (Inch)	(LBS)
	Inch	MM	Inch	MM					
2563-125	1.25	32	1.65	42	27	-1	0.02	1.25	1.08
2563-200	2.00	51	2.40	61	15	-1	0.02	2.00	1.73
2563-250	2.50	64	2.90	74	15	-1	0.02	2.50	2.16
2563-300	3.00	76	3.40	86	12	-1	0.02	6.00	2.59
2563-350	3.50	89	3.90	99	12	-1	0.02	7.00	3.02
2563-400	4.00	102	4.40	112	9	-1	0.02	8.00	3.46

\*Specifications for reference only. Specific test data available on request.



# 2005 SERIES:

## INDUSTRIAL SIL-FAB2™ WIRE REINFORCED DUCT



Industrial SIL-FAB2™ wire reinforced duct is manufactured for extreme temperature resistance. Lightweight and non-kinking, it's vulcanized to last longer in hot air exhaust applications.

### CONSTRUCTION:

- + 2-ply silicone coated fiberglass fabric with wire reinforcement (no cuffs)
- + Stocked in 12' lengths only
- + Chemically treated, helically wound, spring steel wire for flexibility
- + Double, continuous filament, silicone treated fiberglass cord

### SPECIFICATIONS:

- + Vulcanized for long service life
- + Lightweight, non-kinking
- + Bend radius is equal to the inside diameter of the hose
- + Working pressure is 1/3 of the burst pressure
- + Ideal for hot air exhaust
- + Used in engine service bays for engine exhaust
- + Used to exhaust hot air in injection molding processes
- + Not recommended for handling liquids or abrasive materials
- + Not recommended for charge air applications

### BENEFITS

- ✓ Designed for Medium Pressure Handling of Air, Dust, Fumes, and Light Powders
- ✓ Extreme Temperature Resistance

### CUSTOM ENGINEERED TO WITHSTAND:



COOL TEMPS



HOT TEMPS



OIL SPLASH  
RESISTANCE



OZONE  
RESISTANT



DIRECT  
SUNLIGHT

### TEMPERATURE RANGE:

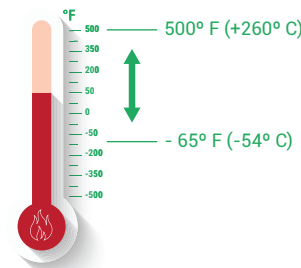



# 2005 SERIES: INDUSTRIAL SIL-FAB2™ WIRE REINFORCED DUCT

Part Number	Inside Diameter		Outside Diameter		Burst Pressure (PSI)	Max. Leakage CFM Max. Neg.	PSI Wall	Thickness Weight	(OZ/FT)
	Inch	MM	Inch	MM					
2005-100	1.00	25	1.14	29	180	0.015	15	0.07	2.00
2005-125	1.25	32	1.39	35	180	0.015	15	0.07	2.50
2005-150	1.50	38	1.64	42	165	0.015	13	0.07	3.00
2005-175	1.75	44	1.89	48	165	0.02	13	0.07	3.50
2005-200	2.00	51	2.14	54	150	0.02	10	0.07	4.00
2005-225	2.25	57	2.39	61	150	0.02	10	0.07	4.50
2005-250	2.50	64	2.64	67	135	0.025	8	0.07	5.00
2005-275	2.75	70	2.89	73	135	0.025	8	0.07	6.00
2005-300	3.00	76	3.14	80	135	0.03	7	0.07	6.20
2005-325	3.25	83	3.39	86	135	0.03	6	0.07	6.70
2005-350	3.50	89	3.64	92	120	0.035	6	0.07	7.20
2005-375	3.75	95	3.89	99	120	0.035	5	0.07	7.80
2005-400	4.00	102	4.14	105	120	0.04	5	0.08	8.40
2005-450	4.50	114	4.64	118	105	0.05	4	0.08	9.60
2005-500	5.00	127	5.14	131	105	0.06	4	0.08	10.70
2005-550	5.50	140	5.64	143	90	0.08	3	0.08	11.80
2005-600	6.00	152	6.14	156	90	0.1	3	0.08	13.00
2005-800	8.00	203	8.14	207	45	0.15	3	0.08	17.80
2005-1000	10.00	254	10.14	258	24	0.2	2	0.08	22.60
2005-1200	12.00	305	12.14	308	12	0.3	2	0.08	27.10

\*Specifications for reference only. Specific test data available on request.

## DIAGRAM OF AIRFLOW SIL-FAB2™

Unrestricted inside diameter in bends or axial compression is only available by using SIL-FAB2™. Other flexible hoses create restricted inside diameter in bends or axial compression.

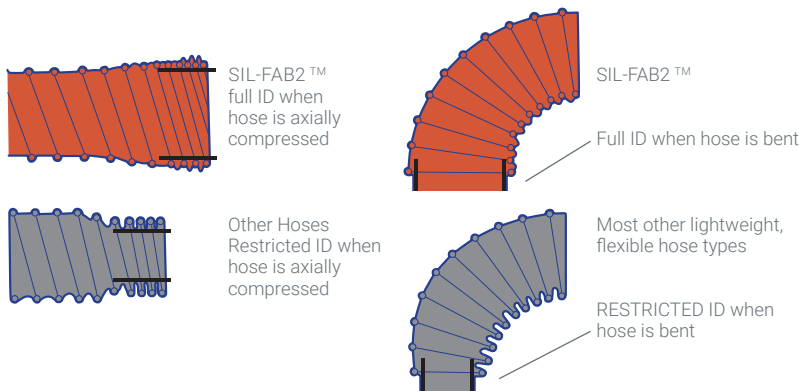



# 7884 AND 7896 SERIES:

## 90° AND 45° SILICONE ELBOWS



With dual purpose design for coolant and charge air connector systems, these silicone elbows are extreme duty cycle tested for hostile engine environments. They're constructed with low dilation design to prevent expansion.

### FLEXFAB 7884 AND 7896 SERIES SERVE A DUAL PURPOSE.

- + Can be used as a coolant hose
- + Can be used as a charge air connector (CAC)

### CONSTRUCTION:

- + Silicone hose with 3-ply of meta-aramid reinforcement
- + Stocked in standard lengths

### SPECIFICATIONS:

- + Meets or exceeds the operating requirements of SAE J20 R1 Class A
- + Meets or exceeds the operating requirements of TMC RP303B Class I Grade II
- + Standard wall thickness is .140"/.190"
- + Working pressure is 1/3 of the burst pressure

## BENEFITS

- Extreme Temperature Resistance
- Extreme Duty Cycle Tested for Hostile Engine Environments
- Low Dilation Design
- Prevents Expansion
- Engineered for Coolant and Charge Air Connector Systems

### CUSTOM ENGINEERED TO WITHSTAND:



### TEMPERATURE RANGE:

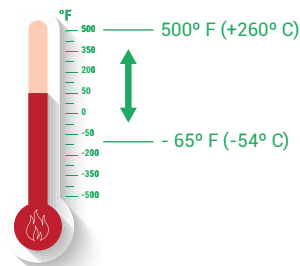



## 7884 SERIES: 90° SILICONE ELBOWS

Part Number	Inside Diameter		Outside Diameter		Leg Length - Inches (Avail. Clamp Space)	Bend Radius Inches	Burst Pressure - PSI		Weight LBS	Clamp
	Inch	MM	Inch	MM			SAE J20 R1	TMC		
7884-075	0.75	19	1.07	27	6.00	1.50	325	125	0.50	2582-0012
7884-100	1.00	25	1.32	34	6.00	2.00	300	125	0.50	2582-0016
7884-125	1.25	32	1.57	40	6.00	2.50	275	125	0.50	2582-0020 or 2584-0212
7884-150	1.50	38	1.82	46	6.00	3.00	250	125	0.50	2582-0024 or 2584-0212
7884-175	1.75	44	2.07	53	6.00	3.50	225	125	0.50	2582-0028 or 2584-0262
7884-200	2.00	51	2.32	59	6.00	4.00	200	100	0.50	2582-0032 or 2584-0262
7884-225	2.25	57	2.57	65	6.00	3.38	175	100	1.00	2582-0036 or 2584-0312
7884-250	2.50	64	2.82	72	6.50	3.75	150	100	1.00	2582-0040 or 2584-0312
7884-275	2.75	70	3.07	78	7.00	4.13	125	100	1.00	2582-0044 or 2584-0362
7884-300	3.00	76	3.32	84	7.50	4.50	100	100	1.00	2582-0048 or 2584-0362
7884-350	3.50	89	3.82	97	8.50	5.25	75	100	1.50	2582-0056 or 2584-0412
7884-400	4.00	102	4.32	110	9.50	6.00	50	100	1.50	2582-0064 or 2584-0462
7884-500	5.00	127	5.32	135	13.50	7.50	N/A	N/A	1.50	2584-0562

\*Specifications for reference only. Specific test data available on request.



## 7896 SERIES: 45° SILICONE ELBOWS

Part Number	Inside Diameter		Outside Diameter		Leg Length - Inches (Avail. Clamp Space)	Bend Radius Inches	Burst Pressure - PSI		Weight LBS	Clamp
	Inch	MM	Inch	MM			SAE J20 R1	TMC		
7896-075	0.75	19	1.07	27	6.00	4.00	325	125	0.50	2582-0012
7896-100	1.00	25	1.32	34	6.00	4.00	300	125	0.50	2582-0016
7896-125	1.25	32	1.57	40	6.00	4.00	275	125	0.50	2582-0020 or 2584-0212
7896-150	1.50	38	1.82	46	6.00	4.00	250	125	0.50	2582-0024 or 2584-0212
7896-175	1.75	44	2.07	53	6.00	4.00	225	125	0.50	2582-0028 or 2584-0262
7896-200	2.00	51	2.32	59	6.00	4.00	200	100	0.50	2582-0032 or 2584-0262
7896-225	2.25	57	2.57	65	6.00	4.00	175	100	1.00	2582-0036 or 2584-0312
7896-250	2.50	64	2.82	72	6.50	4.00	150	100	1.00	2582-0040 or 2584-0312
7896-275	2.75	70	3.07	78	7.00	4.00	125	100	1.00	2582-0044 or 2584-0362
7896-300	3.00	76	3.32	84	7.50	4.00	100	100	1.50	2582-0048 or 2584-0362
7896-350	3.50	89	3.82	97	8.50	4.00	75	100	2.00	2582-0056 or 2584-0412
7896-400	4.00	102	4.32	110	9.50	4.00	50	100	2.50	2582-0064 or 2584-0462

\*Specifications for reference only. Specific test data available on request.



# 7903 SERIES: REDUCERS



These reducers have dual purpose design for coolant and charge air connector systems, and are constructed for extreme temperature and pressure resistance. They withstand oil, ozone, and UV rays.

## FLEXFAB 7903 SERIES REDUCERS SERVE A DUAL PURPOSE.

- + Can be used as a coolant hose
- + Can be used as a charge air connector (CAC)

## CONSTRUCTION:

- + Silicone hose with 4-ply of meta-aramid reinforcement
- + Stocked in standard 6" lengths

## SPECIFICATIONS:

- + Meets or exceeds the operating requirements of SAE J20 R1 Class A
- + Meets or exceeds the operating requirements of TMC RP303B Class I Grade II
- + Standard wall thickness is .170"/.220"
- + Working pressure is 1/3 of the burst pressure
- + Resists hardening, cracking, cold leaks, aging, and many chemicals
- + Ideal for extreme temperature and various pressure ranges where high performance levels are required
- + Resists chemicals, steam, ozone, coolants, and aging conditions normally found in the engine environment

## BENEFITS

- Extreme Temperature Resistance
- Extreme Duty Cycle Tested for Hostile Engine Environments
- High Pressure Resistance
- Engineered for Coolant and Charge Air Connector Systems

## CUSTOM ENGINEERED TO WITHSTAND:



## TEMPERATURE RANGE:

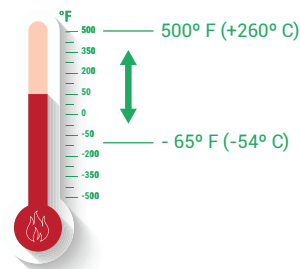

## 7903 SERIES: REDUCERS

Part Number	Inside Diameter		Outside Diameter		Overall Length Inches	Burst Pressure - PSI		Weight (LBS)	Clamp
	Inch	MM	Inch	MM		SAE J20 R1	TMC		
FLX7903-100125	1.00/1.25	25/32	1.39/1.64	35/42	6.00	275	125	0.5	2582-0016/2582-0020 2584-0175/2584-0212
FLX7903-100150	1.00/1.50	25/38	1.39/1.89	35/48	6.00	250	125	0.5	2582-0016/2582-0024 2584-0175/2584-0212
FLX7903-100175	1.00/1.75	25/44	1.39/2.14	35/54	6.00	225	125	0.5	2582-0016/2582-0028 2584-0175/2584-0262
FLX7903-100200	1.00/2.00	25/51	1.39/2.39	35/61	6.00	200	100	0.5	2582-0016/2582-0032 2584-0175/2584-0262
FLX7903-125200	1.25/2.00	32/51	1.64/2.39	42/61	6.00	200	100	0.5	2582-0020/2582-0032 2584-0175/2584-0262
FLX7903-150200	1.50/2.00	38/51	1.89/2.39	48/61	6.00	200	100	0.5	2582-0024/2582-0032 2584-0212/2584-0262
FLX7903-175200	1.75/2.00	44/51	2.14/2.39	54/61	6.00	200	100	0.5	2582-0028/2582-0032 2584-0262/2584-0262
FLX7903-200225	2.00/2.25	51/57	2.39/2.64	61/67	6.00	175	100	0.5	2582-0032/2582-0036 2584-0262/2584-0312
FLX7903-200250	2.00/2.50	51/64	2.39/2.89	61/73	6.00	150	100	0.5	2582-0032/2582-0040 2584-0262/2584-0312
FLX7903-200275	2.00/2.75	51/70	2.39/3.14	61/80	6.00	125	100	0.5	2582-0032/2582-0044 2584-0262/2584-0362
FLX7903-200300	2.00/3.00	51/76	2.39/3.39	61/86	6.00	100	100	0.5	2582-0032/2582-0048 2584-0262/2584-0362
FLX7903-225250	2.25/2.50	57/64	2.64/2.89	67/73	6.00	150	100	0.5	2582-0036/2582-0040 2584-0312/2584-0312
FLX7903-225275	2.25/2.75	57/70	2.64/3.14	67/80	6.00	125	100	0.5	2582-0036/2582-0044 2584-0312/2584-0362
FLX7903-225300	2.25/3.00	57/76	2.64/3.39	67/86	6.00	100	100	0.5	2582-0036/2582-0048 2584-0312/2584-0362
FLX7903-250275	2.50/2.75	64/70	2.89/3.14	73/80	6.00	125	100	0.5	2582-0040/2582-0044 2584-0312/2584-0362
FLX7903-250300	2.50/3.00	64/76	2.89/3.39	73/86	6.00	100	100	0.5	2582-0040/2582-0048 2584-0312/2584-0362
FLX7903-250350	2.50/3.50	64/89	2.89/3.89	73/99	6.00	75	100	0.5	2582-0040/2582-0056 2584-0312/2584-0412
FLX7903-275300	2.75/3.00	70/76	3.14/3.39	80/86	6.00	100	100	0.5	2582-0044/2582-0048 2584-0362/2584-0362
FLX7903-300350	3.00/3.50	76/89	3.39/3.89	86/99	6.00	75	100	0.5	2582-0048/2582-0056 2584-0362/2584-0412
FLX7903-300400	3.00/4.00	76/102	3.39/4.39	86/112	6.00	50	100	0.5	2582-0048/2582-0064 2584-0362/2584-0462
FLX7903-350400	3.50/4.00	89/102	3.89/4.39	99/112	6.00	50	100	0.5	2582-0056/2582-0064 2584-0412/2584-0462
FLX7903-400500	4.00/5.00	102/127	4.39/5.39	112/137	6.00	N/A	N/A	0.5	2584-0462/2584-0562

\*Specifications for reference only. Specific test data available on request.



# 5584 SERIES:

## MARINE WET EXHAUST SLEEVES



Constructed for marine applications, Flexfab's wet exhaust sleeves don't corrode or crack. They absorb the vibration of engine movement and resist extreme temperatures for long-lasting use.

### CONSTRUCTION:

- + 0.875" ID up to 2" ID: 3-ply polyester reinforcement, wall thickness is .155"/.200"
- + 2.25" ID up to 8" ID: 4-ply polyester reinforcement, wall thickness is .175"/.240"
- + 10" ID up to 16" ID: 6-ply polyester reinforcement, wall thickness is .245"/.320"
- + Stocked in 3' lengths
- + Limited availability please call

### SPECIFICATIONS:

- + Meets or exceeds the operating requirements of SAE J2006 R3, ISO33660, SAE J1942
- + Working pressure is 1/3 of the burst pressure
- + Silicone can replace rigid pipe

## BENEFITS

- Marine Wet Exhaust
- Resists Corrosion, Stress, and Cracking
- Absorbs Engine Movement and Vibration
- Easier to Run than Rigid Pipe

### CUSTOM ENGINEERED TO WITHSTAND:



### TEMPERATURE RANGE:

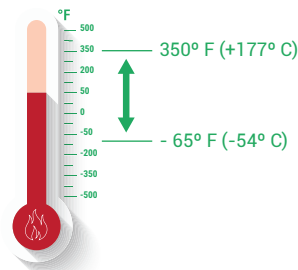

## 5584 SERIES: MARINE WET EXHAUST SLEEVES

Part Number	Inside Diameter		Outside Diameter		Burst Pressure - PSI SAE J20 R1	Weight (LB/FT)	Clamp
	Inch	MM	Inch	MM			
5584-087	0.88	22	1.11	28	36	1.00	2582-0012
5584-100	1.00	25	1.24	31	36	1.00	2582-0016
5584-125	1.25	32	1.49	38	36	1.50	2582-0020 or 2584-0212
5584-150	1.50	38	1.74	44	36	1.50	2582-0024 or 2584-0212
5584-175	1.75	44	1.99	50	36	1.50	2582-0028 or 2584-0262
5584-200	2.00	51	2.24	57	36	2.00	2582-0032 or 2584-0262
5584-225	2.25	57	2.67	68	36	2.50	2582-0036 or 2584-0312
5584-250	2.50	64	2.92	74	36	2.75	2582-0040 or 2584-0312
5584-275	2.75	70	3.17	80	36	3.00	2582-0044 or 2584-0362
5584-287	2.88	73	3.30	84	36	3.00	2582-0044 or 2584-0362
5584-300	3.00	76	3.42	87	36	3.00	2582-0048 or 2584-0362
5584-350	3.50	89	3.92	99	36	3.75	2582-0056 or 2584-0412
5584-400	4.00	102	4.42	112	36	4.50	2582-0064 or 2584-0512
5584-450	4.50	114	4.92	125	36	4.75	2582-0072 or 2584-0512
5584-500	5.00	127	5.42	138	36	5.00	2584-0562
5584-600	6.00	152	6.42	163	36	9.00	2584-0662
5584-800	8.00	203	8.57	218	36	9.50	2584-0862
5584-1000	10.00	254	10.57	268	36	17.00	-
5584-1200	12.00	305	12.57	319	36	20.50	-
5584-1400	14.00	356	14.57	370	36	23.50	-
5584-1600	16.00	406	16.57	421	36	29.00	-

\*Specifications for reference only. Specific test data available on request.

### MARINE WET EXHAUST SYSTEMS:

Water is injected into the exhaust system to cool the gasses, which are then passed through the outlet. The injected water lowers the temperature of the exhaust gasses from as high as 2000°F to below 250°F. This cools the gasses sufficiently enough for the use of flexible silicone hose. The water cooled exhaust does not cause a fire hazard, and needs no insulation.





# 7901 SERIES: MARINE WET EXHAUST BELLOWS



These marine wet exhaust bellows are designed with 6 plies of polyester reinforcement. They don't corrode or crack, and are durable enough to absorb engine movement and vibration.

## CONSTRUCTION:

- + Silicone hose with 6 plies of polyester reinforcement
- + Limited availability please call

## SPECIFICATIONS:

- + Meets or exceeds the operating requirements of SAE J2006 R3, ISO33660, SAE J1942
- + Working pressure is 1/3 of the burst pressure
- + Wall thickness is .225"/.300"
- + Silicone can replace rigid pipe

## BENEFITS

- Marine Wet Exhaust
- Resists Corrosion, Stress, and Cracking
- Absorbs Engine Movement and Vibration
- Easier to Run than Rigid Pipe

## CUSTOM ENGINEERED TO WITHSTAND:



## TEMPERATURE RANGE:

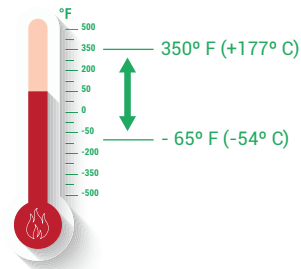

## 7901 SERIES: MARINE WET EXHAUST BELLOWS

Part Number	Inside Diameter		Outside Diameter		Overall Length Inches	Bellows (Humps)	Burst Pressure - PSI SAE J2006 R3	Weight LBS	Clamp
	Inch	MM	Inch	MM					
7901-0009	6.00	152	6.53	166	8.00	One	36	3	2584-0662
7901-0010	8.00	203	8.53	217	8.00	One	36	3.5	2584-0862
7901-0011	10.00	254	10.53	267	8.00	One	36	4	-
7901-0012	10.00	254	10.53	267	12.00	One	36	5.5	-
7901-0013	10.00	254	10.53	267	14.00	Two	36	7	-
7901-0001	12.00	305	12.53	318	12.00	One	36	7.5	-
7901-0002	12.00	305	12.53	318	14.00	Two	36	8	-
7901-0003	14.00	356	14.53	369	14.00	Two	36	9	-
7901-0006	14.00	356	14.53	369	20.00	Two	36	12.5	-
7901-0004	16.00	406	16.53	420	14.00	Two	36	12	-
7901-0007	16.00	406	16.53	420	20.00	Two	36	14	-
7901-0005	18.00	457	18.53	471	18.00	Two	36	16	-

\*Specifications for reference only. Specific test data available on request.



### MARINE WET EXHAUST SYSTEMS:

Water is injected into the exhaust system to cool the gasses, which are then passed through the outlet. The injected water lowers the temperature of the exhaust gasses from as high as 2000°F to below 250°F. This cools the gasses sufficiently enough for the use of flexible silicone hose. The water cooled exhaust does not cause a fire hazard, and needs no insulation.



# 5531 SERIES:

## LOW PRESSURE SILICONE TUBING



Flexfab's durable low pressure silicone tubing withstands extreme temperatures in low pressure vacuum advance, windshield washer fluid, transmission modulator, and emission control applications.

### APPLICATION:

+ Designed for low pressure vacuum advance, windshield washer fluid, transmission modulator and emission control

### CONSTRUCTION:

- + Silicone hose without reinforcement
- + Available in:
- + Stocked in 25' boxes

## BENEFITS

- ✓ Long Life Silicone
- ✓ Extreme Temperature Resistance
- ✓ Durable and Long Lasting

### CUSTOM ENGINEERED TO WITHSTAND:



### TEMPERATURE RANGE:

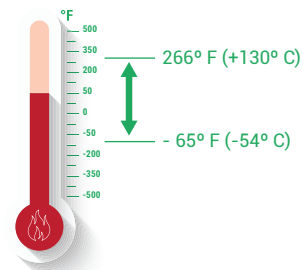

## 5531 SERIES: LOW PRESSURE SILICONE TUBING

Part Number	Inside Diameter		Outside Diameter		Wall Thickness	Weight (LB/FT)
	Inch	MM	Inch	MM		
5531-018	0.19	4.75	0.35	9	.075/.085	0.0379
5531-012	0.13	3.18	0.23	6	.045/.055	0.0162
5531-025	0.25	6.35	0.45	11	.095/.105	0.0609
5531-031	0.31	7.92	0.55	14	.115/.125	0.0892
5531-038	0.38	9.53	0.68	17	.145/.155	0.1342

\*Specifications for reference only. Specific test data available on request.

Temperature in Fahrenheit	Temperature in Celsius	Expected Life
<266°F	<130°C	Several Years
302°F	150°C	1.5 Years
392°F	200°C	8 Months
482°F	250°C	3 Months
572°F	300°C	10 Days

Media: hot air with continuous exposure  
This information is for reference ONLY and is not a guarantee.



# 36519 SERIES:

## BEADED CONNECTORS



Use Flexfab's beaded connectors in coolant, charge air and marine applications. They're constructed with anodized aluminum to resist salt water damage and withstand extreme temperatures, oil, ozone, and UV rays. These beaded connectors feature anodized aluminum construction and are corrosion resistant.

### BENEFITS

- ✓ Customizable Capabilities - Add to Hose Length or Change Hose Shape
- ✓ Anodized Aluminum Construction Corrosion Resistance
- ✓ Extreme Temperature Resistance

### CONSTRUCTION:

- + Bead height per AS5131 specification
- + Meets anodized aluminum specification MIL-A8625 ✓

## 36519 SERIES: *BEADED CONNECTORS*

Part Number Beaded Con- nectors	Outside Diameter		Bead Height (AS5131)	Overall Length Inches	Weight LBS
	Inch	MM			
DEA-36519-0625	0.63	16	.047 - .087	3.00	0.50
DEA-36519-0750	0.75	19	.047 - .087	3.00	0.50
DEA-36519-1000	1.00	25	.047 - .087	3.00	0.50
DEA-36519-1250	1.25	32	.047 - .087	3.00	0.50
DEA-36519-1500	1.50	38	.047 - .087	3.00	0.50
DEA-36519-1750	1.75	44	.047 - .087	3.00	0.50
DEA-36519-2000	2.00	51	.047 - .087	3.00	0.50
DEA-36519-2250	2.25	57	.047 - .087	3.00	0.50
DEA-36519-2500	2.50	64	.047 - .087	3.00	0.50
DEA-36519-2750	2.75	70	.047 - .087	3.00	0.50
DEA-36519-3000	3.00	76	.047 - .087	3.00	0.50
DEA-36519-3500	3.50	89	.047 - .087	3.00	0.50
DEA-36519-4000	4.00	102	.047 - .087	3.00	0.50

\*Specifications for reference only.



# 2582 SERIES:

## LINED WORM GEAR CLAMPS



Constructed with all 300 grade stainless steel, the lining of these clamps protects the hose surface and prevents silicone from shearing through band notches. The clamps are salt water resistant, making them an ideal solution for marine applications.

### APPLICATION:

+ For charge air connector (CAC) applications

### CONSTRUCTION:

+ Lined clamps are designed for use with silicone rubber and other soft hose applications. The liner protects the hose surface and prevents it from extruding or shearing through the band notches as the clamp is tightened.

+ Please call for availability

### SPECIFICATIONS:

+ All 300 grade stainless steel lined worm gear clamps

+ Hex Head: 5/16"

+ Band Width: 9/16"

## BENEFITS

- ✓ Recommended for Silicone Coolant Hose, Heater Hose, Marine, and Silicone Tubing
- ✓ Durable and Long Lasting
- ✓ Salt Water Resistant

## 2582 SERIES: LINED WORM GEAR CLAMPS

Part Number - Clamps Lined Worm Gear	Min. Dia. (in.)	Max. Dia. (in.)	Min. Dia. (mm)	Max. Dia. (mm)	Pack Size	Weight LBS- Per 10
FLX2582-0006	0.50	0.88	13	22	10	0.5
FLX2582-0008	0.63	1.00	16	25	10	0.5
FLX2582-0010	0.75	1.06	19	27	10	0.5
FLX2582-0012	0.88	1.25	22	32	10	0.5
FLX2582-0016	1.00	1.50	26	38	10	0.5
FLX2582-0020	1.13	1.75	29	44	10	0.5
FLX2582-0024	1.25	2.00	32	51	10	0.5
FLX2582-0028	1.31	2.25	33	57	10	0.5
FLX2582-0032	1.56	2.50	40	63	10	0.5
FLX2582-0036	1.81	2.75	46	70	10	0.5
FLX2582-0040	2.06	3.00	52	76	10	0.5
FLX2582-0044	2.31	3.25	59	82	10	0.5
FLX2582-0048	2.56	3.50	65	89	10	0.5
FLX2582-0052	2.81	3.75	72	95	10	0.5
FLX2582-0056	3.06	4.00	78	101	10	0.5
FLX2582-0060	3.31	4.25	84	108	10	0.5
FLX2582-0064	3.56	4.50	91	114	10	1
FLX2582-0072	4.06	5.00	103	127	10	1

\*Specifications for reference only.

### COOLANT AND HEATER HOSE CLAMPING INSTRUCTIONS:

Worm gear or constant torque type stainless steel clamps with inner liner are recommended for silicone heater and coolant hose. Initial clamp torque should be 40 inch-lbs. If re-torquing is required, it should be limited to 20 inch-lbs. Do not use serrated, slotted, or wire type clamps.

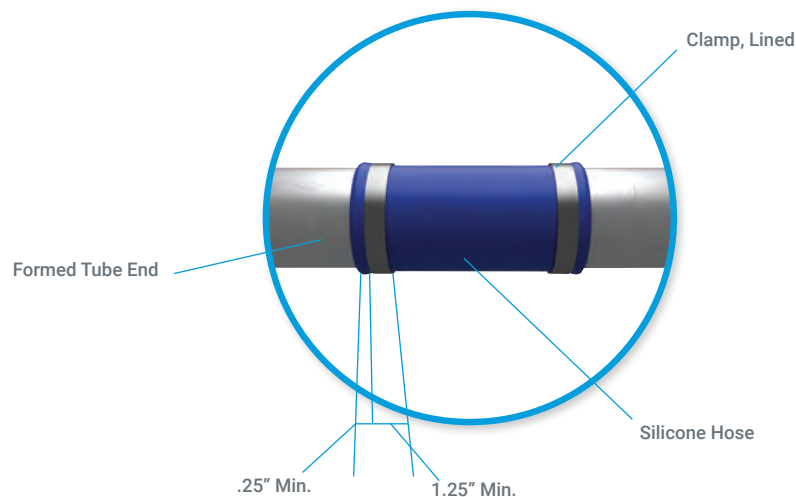





# 2584 SERIES:

## CONSTANT TENSION CLAMPS



An ideal solution for silicone coolant hose, heater hose, and marine connections, constant tension clamps provide a uniform 360° seal. They are constructed to respond to constant temperature fluctuations and resist extreme temperatures.

### APPLICATION:

+ For charge air connector (CAC) applications

### CONSTRUCTION:

- + All 300 grade stainless steel constant tension lined clamps
- + Hex Head: 3/8"
- + Band Width: 5/8"
- + Resists salt water and may be used in marine applications
- + Liner protects the hose surface and prevents silicone from shearing through band notches

### BENEFITS

- ✓ Lined Clamp Design
- ✓ Belleville Spring and Clamp Construction is Designed to Respond to Constant Temperature Fluctuations
- ✓ Ideal for Silicone Coolant Hose, Heater Hose, and Marine Connections
- ✓ Provides Uniform 360° Seal

## 2584 SERIES: CONSTANT TENSION CLAMPS

Part Number - Clamps Constant Tension	Min. Dia. (in.)	Max. Dia. (in.)	Min. Dia. (mm)	Max. Dia. (mm)	Pack Size	Weight LBS- Per 10
FLX2584-0175	1.00	1.75	25	45	10	2
FLX2584-0212	1.25	2.13	32	54	10	2
FLX2584-0262	1.75	2.63	45	67	10	2
FLX2584-0312	2.25	3.13	57	79	10	2
FLX2584-0362	2.75	3.63	70	92	10	2
FLX2584-0412	3.25	4.13	83	105	10	2.5
FLX2584-0462	3.75	4.63	95	117	10	2.5
FLX2584-0512	4.25	5.13	108	130	10	2.5
FLX2584-0562	4.75	5.63	121	143	10	2.5
FLX2584-0612	5.25	6.13	133	155	10	2.5
FLX2584-0662	5.75	6.63	146	168	10	3
FLX2584-0712	6.25	7.13	159	181	10	3
FLX2584-0762	6.75	7.63	172	193	10	3
FLX2584-0812	7.25	8.13	184	206	10	3
FLX2584-0862	7.75	8.63	197	219	10	3
FLX2584-0912	8.25	9.13	210	232	10	3.5

\*Specifications for reference only.

### COOLANT AND HEATER HOSE CLAMPING INSTRUCTIONS:

Worm gear or constant torque type stainless steel clamps with inner liner are recommended for silicone heater and coolant hose. Initial clamp torque should be 40 inch-lbs. If re-torquing is required, it should be limited to 20 inch-lbs. Do not use serrated, slotted, or wire type clamps.

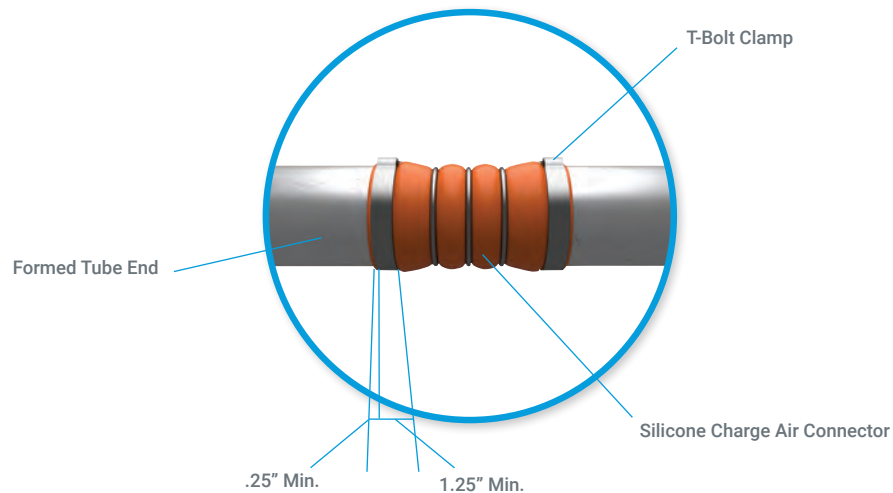



# 2583 SERIES: T-BOLT CLAMPS



These clamps provide a positive, uniform seal for high-vibration applications, including marine.

## APPLICATION:

- + For charge air connector (CAC) applications and turbo charger sleeves
- + Heavy-duty T-bolt clamps provide uniform sealing pressure for a positive, reliable seal. Designed for use in high vibration applications in heavy-duty trucks, industrial machinery, off-road equipment, agricultural irrigation equipment and machinery.

## CONSTRUCTION:

- + Features a 3/4" wide stainless steel band with welded construction for reliability.
- + All 300 grade stainless steel T-bolt clamps
- + Please call for availability

## SPECIFICATIONS:

- + Hex Head: 7/16" with nylon insert
- + Band Width: 3/4"
- + Resists salt water and may be used in marine applications

## BENEFITS

- ✓ Recommended for Coolant Hose, CAC hose, Turbo Sleeves, Marine Hose, 90° and 45° Degree Elbows, and SILFAB™ Ducting sleeves
- ✓ Salt Water Resistant
- ✓ Clamp Provides a Uniform 360° Seal

## 2583 SERIES: T-BOLT CLAMPS

Part Number - Clamps T-Bolt	Min. Dia. (in.)	Max. Dia. (in.)	Min. Dia. (mm)	Max. Dia. (mm)	Pack Size	Weight LBS- Per 10
FLX2583-0138	1.38	1.56	35	39	10	1
FLX2583-0150	1.50	1.63	38	42	10	1.5
FLX2583-0163	1.63	1.88	41	46	10	1.5
FLX2583-0175	1.75	2.00	45	51	10	1.5
FLX2583-0188	1.88	2.19	48	56	10	1.5
FLX2583-0200	2.00	2.31	51	59	10	1.5
FLX2583-0213	2.13	2.44	54	62	10	1.5
FLX2583-0225	2.25	2.56	57	65	10	1.5
FLX2583-0238	2.38	2.69	61	68	10	1.5
FLX2583-0250	2.50	2.81	64	71	10	1.5
FLX2583-0263	2.63	2.94	67	75	10	1.5
FLX2583-0275	2.75	3.06	70	78	10	1.5
FLX2583-0288	2.88	3.19	73	81	10	1.5
FLX2583-0300	3.00	3.31	76	84	10	1.5
FLX2583-0313	3.13	3.44	80	87	10	1.5
FLX2583-0325	3.25	3.56	83	90	10	1.5
FLX2583-0338	3.38	3.69	86	94	10	1.5
FLX2583-0350	3.50	3.81	89	97	10	1.5
FLX2583-0363	3.63	3.94	92	100	10	1.5
FLX2583-0375	3.75	4.06	95	103	10	1.5
FLX2583-0400	4.00	4.31	102	110	10	2
FLX2583-0425	4.25	4.56	108	116	10	2
FLX2583-0450	4.50	4.81	114	122	10	2
FLX2583-0475	4.75	5.06	121	129	10	2
FLX2583-0500	5.00	5.31	127	135	10	2

\*Specifications for reference only.

### CAC AND TURBO CHARGER HOSE CLAMPING INSTRUCTIONS:

Use only T-bolt style clamps. Constant torque T-bolt style clamps may help retain clamp load. Torque clamps to 70-75 inch-lbs.

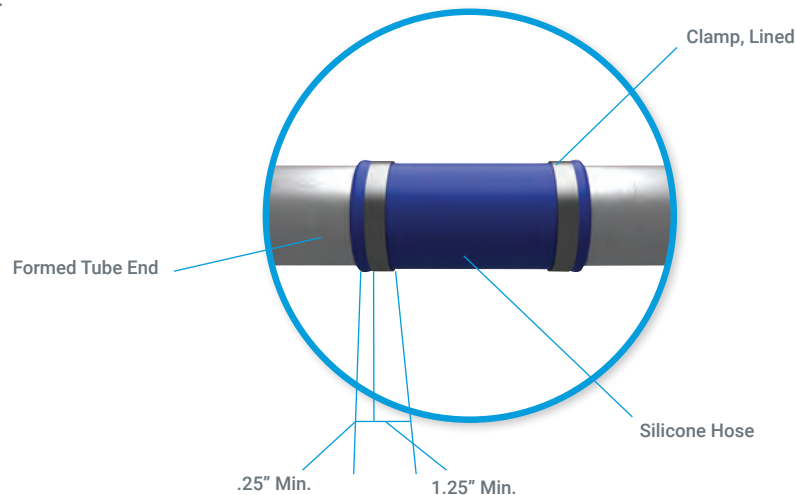



# 2588 SERIES:

## SPRING LOADED T-BOLT CLAMPS



These T-Bolt Clamps provide consistent band tension and compensate for fluctuations that can happen in hose line assemblies. They resist salt water, and temperature and/or pressure changes.

### APPLICATION:

+ For charge air connector (CAC) applications

### SPECIFICATIONS:

- + All 316 grade stainless steel spring-loaded T-bolt clamps
- + Hex Head: 5/16"
- + Band Width: 3/4"
- + Resists salt water and may be used in marine applications

### BENEFITS

- ✓ Spring Loaded T-Bolt Clamps are Designed to Compensate for Fluctuations in Hose Line Assemblies
- ✓ Spring Loaded T-Bolt Clamps Adjust to Temperature and/or Pressure Changes to Provide Constant Band Tension
- ✓ Recommended for Silicone Coolant Hose, CAC Hose, Turbo Sleeves, Marine Hose, 90° and 45° Degree Elbows, and SILFAB™ Ducting

## 2588 SERIES: SPRING LOADED T-BOLT CLAMPS

Part Number - Clamps Spring Loaded T-Bolt	Min. Dia. (in.)	Max. Dia. (in.)	Min. Dia. (mm)	Max. Dia. (mm)	Pack Size	Weight LBS- Per 10
FLX2588-0306	3.0625	3.375	77.8	85.7	10	2
FLX2588-0356	3.562	3.875	90.5	98.4	10	2
FLX2588-0406	4.0625	4.375	103.2	111.1	10	2
FLX2588-0456	4.562	4.875	115.9	123.8	10	2
FLX2588-0506	5.0652	5.375	128.59	136.53	10	2

\*Specifications for reference only.

### CAC AND TURBO CHARGER HOSE CLAMPING INSTRUCTIONS:

Use only T-bolt style clamps. Constant torque T-bolt style clamps may help retain clamp load. Torque clamps to 70-75 inch-lbs.

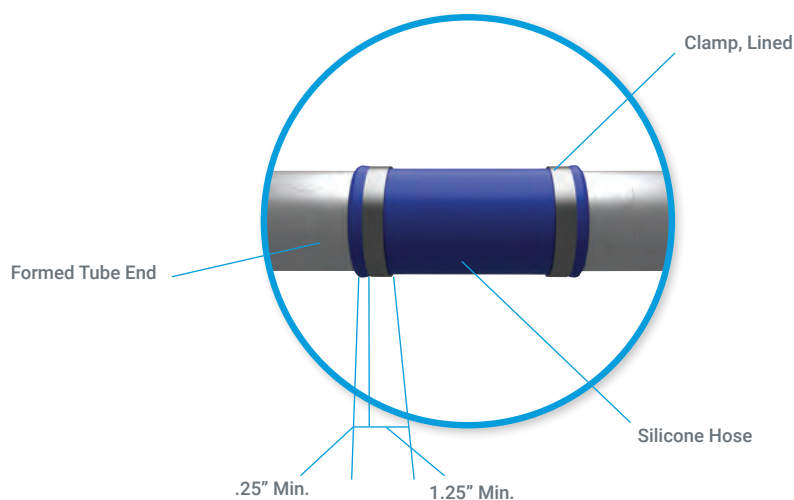

# HOW DOES A COOLING SYSTEM WORK?

The cooling system is made up of the passages inside the engine block and heads, a pump to circulate the coolant, a thermostat to control the temperature of the coolant, a radiator to cool the coolant, a radiator cap to control the pressure in the system, and some plumbing consisting of interconnecting hoses (Flexfab hoses). These hoses transfer the coolant from the engine to radiator and also to the heater system, where hot coolant is used to warm up the vehicle interior on a cold day. The diagram below shows the flow of coolant with a down flow radiator:

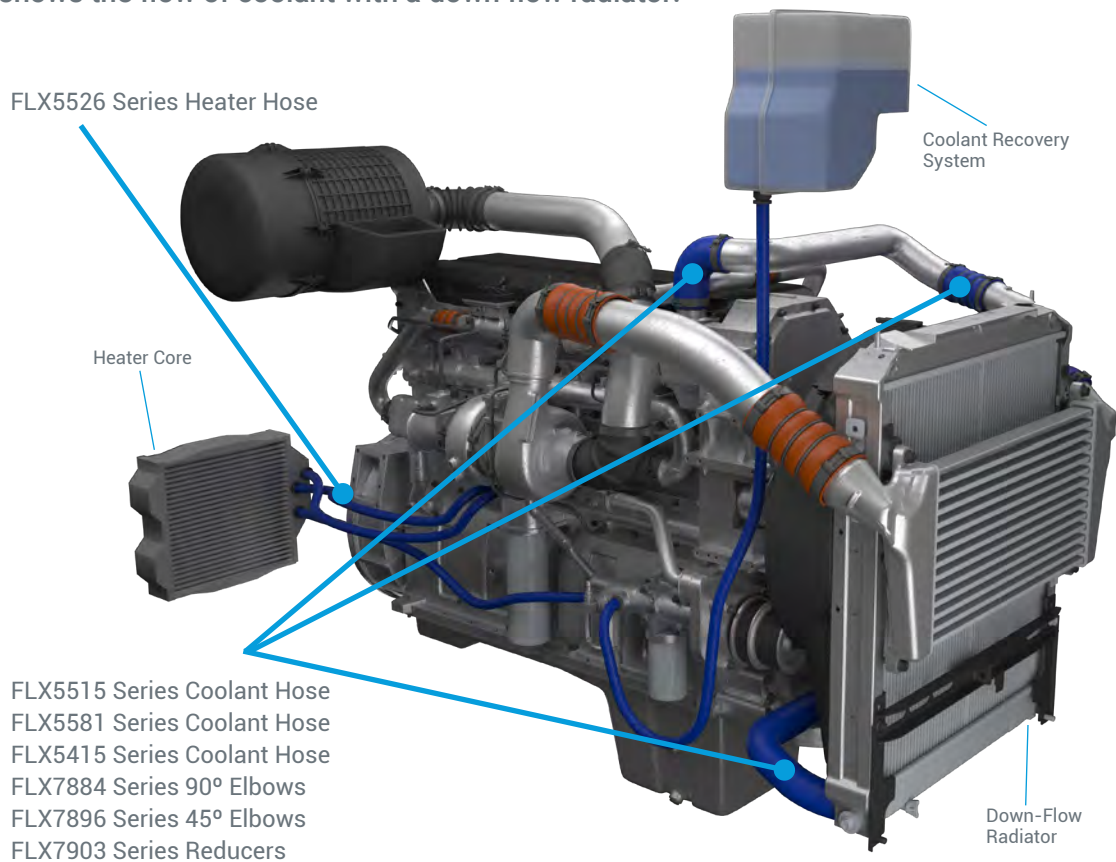

There are several hoses that make up the plumbing to connect the components of the cooling system. The main hoses are called the upper and lower radiator hoses. These two hoses direct coolant between the engine and the radiator. Two additional hoses, called heater hoses, supply hot coolant from the engine to the heater core. These hoses are designed to withstand the pressure inside the cooling system. Because of this, they are subject to wear and tear and eventually may require replacing as part of routine maintenance.

## FOR REFERENCE ONLY

# CHARGE AIR COOLING PROCESS

A very important component to overall engine efficiency

The charge air cooler and turbocharger are part of a high tech induction system that increases engine combustion efficiency. The turbocharger uses exhaust gases to compress air before it enters the charge air cooler. The compressed air going through the charge air cooler is then cooled by the ambient air flowing across the cooler fins. The cooled air is denser than warm air, so when it flows into the intake side of the engine, the increased density improves horsepower, fuel economy and reduces emissions. The following illustration provides a clear view of the components associated with the charge air cooler and how the air flows through the system:

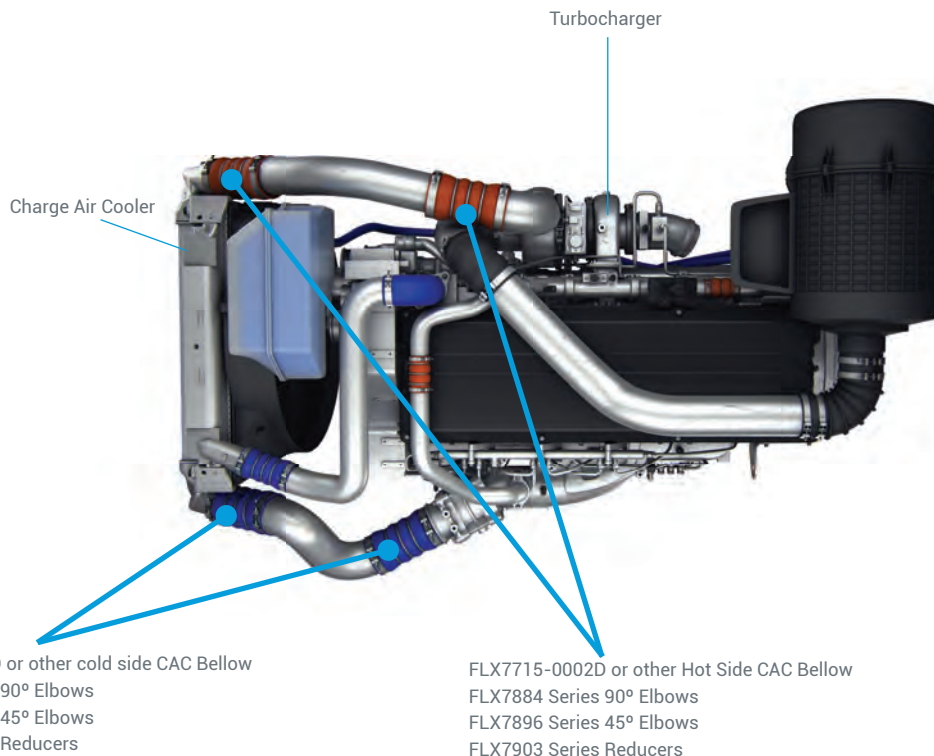

Charge air cooler systems can develop leaks and can fail if the leaks are not caught. A leaking charge air cooler system can cause the engine to lose up to ½ mpg in fuel economy. To maintain engine power and fuel efficiency, it is important to properly maintain all charge air cooler systems.

**FOR REFERENCE ONLY**