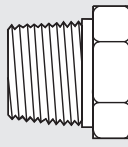
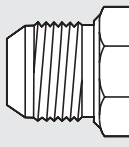
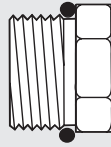
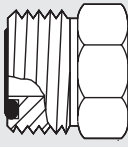
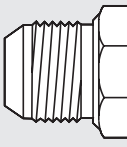
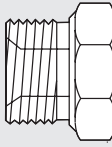

TABLE DES MATIÈRES TABLE OF CONTENTS

Identification des filets / Thread identification	I
Guide visuel / Visual guide	page II
NPTF (pipe thread)	page 1
NPSM (pipe swivel)	page 5
JIC (37° flare)	page 8
BSPP	page 29
Métrique / Metric	page 37
ORFS (o'ring face)	page 42
ORB (o'ring boss)	page 48
Adaptateur tube / Adapter tube	page 51
SAE 45 (45° flare)	page 56
Compression / Flareless	page 57
Métrique compression / Flareless metric	page 58
Jointts tournants droits / Inline swivels	page 60
Jointts tournants 90° / 90° swivels	page 61
Jointts d'étanchéité et écrous / O'rings and nuts	page 66
Ensembles / Kits	page 69

IDENTIFICATION DES FILETS / THREAD IDENTIFICATION









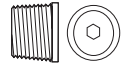
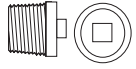

						
Dimension Size	NPTF PIPE	JIC 37° Flare	O'ring boss	O'ring face	SAE 45° Flare	BSPP
1/8	0.400 1/8-27	0.313 5/16-24	0.313 5/16-24	-----	0.313 5/16-24	0.370 1/8-28
3/16	-----	0.375 3/8-24	0.375 3/8-24	-----	0.375 3/8-24	-----
1/4	0.530 1/4-18	0.438 7/16-20	0.438 7/16-20	0.563 9/16-18	0.438 7/16-20	0.510 1/4-19
5/16	-----	0.500 1/2-20	0.500 1/2-20	-----	0.500 1/2-20	-----
3/8	0.675 3/8-18	0.563 9/16-18	0.563 9/16-18	0.688 11/16-16	0.625 5/8-18	0.645 3/8-19
1/2	0.825 1/2-14	0.750 3/4-16	0.750 3/4-16	0.813 13/16-16	0.750 3/4-16	0.825 1/2-14
5/8	-----	0.875 7/8-14	0.875 7/8-14	1.000 1-14	0.875 7/8-14	0.895 5/8-14
3/4	1.040 3/4-14	1.063 1 1/16-12	1.063 1 1/16-12	1.188 1 3/16-12	1.063 1 1/16-14	1.040 3/4-14
7/8	-----	1.188 1 3/16-12	1.188 1 3/16-12	-----	-----	-----
1	1.300 1-11 1/2	1.313 1 5/16-12	1.313 1 5/16-12	1.438 1 7/16-12	-----	1.300 1-11
1 1/4	1.650 1 1/4-11 1/2	1.625 1 5/8-12	1.625 1 5/8-12	1.688 1 11/16-12	-----	1.640 1 1/4-11
1 1/2	1.885 1 1/2-11 1/2	1.875 1 7/8-12	1.875 1 7/8-12	2.000 2-12	-----	1.880 1 1/2-11
2	2.360 2-11 1/2	2.500 2 1/2-12	2.500 2 1/2-12	-----	-----	2.340 2-11

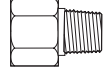
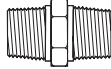
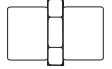
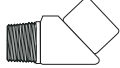
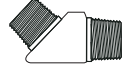
MÉTRIQUE / METRIC

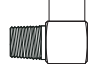
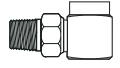
LÉGÈRE LIGHT		LOURDE HEAVY	
Tube	Filetage Thread	Tube	Filetage Thread
6MM	M12X1.5	6MM	M14X1.5
8MM	M14X1.5	8MM	M16X1.5
10MM	M16X1.5	10MM	M18X1.5
12MM	M18X1.5	12MM	M20X1.5
15MM	M22X1.5	14MM	M22X1.5
18MM	M26X1.5	16MM	M24X1.5
22MM	M30X2.0	20MM	M30X2.0
28MM	M36X2.0	25MM	M36X2.0
35MM	M45X2.0	30MM	M42X2.0
42MM	M52X2.0	38MM	M52X2.0

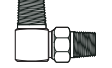

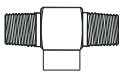
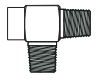
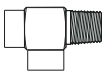

NPTF (PIPE THREAD)

NPTF-NPTF

 24ST Plug hex. head M-NPTF page 1	 24SR Plug hex. socket M-NPTF page 1	 25SP Plug square head M-NPTF page 1	 24SF Plug F-NPTF page 1	 24SB M-NPTF F-NPTF page 1	 24SG F-NPTF M-NPTF page 2	 24SA M-NPTF M-NPTF page 2	 24SJ F-NPTF F-NPTF page 2
 25TG M-NPTF F-NPTF page 2	 25TA M-NPTF M-NPTF page 3	 25TJ F-NPTF F-NPTF page 3	 25UG M-NPTF F-NPTF page 3	 25UGSW M-NPTF swivel F-NPTF page 3	 25UJ F-NPTF F-NPTF page 3	 25UA M-NPTF M-NPTF page 3	 25UASW M-NPTF M-NPTF swivel page 4
 25VC TE F-M-F NPTF page 4	 25VJ TE F-F-F NPTF page 4	 25VG TE M-F-M NPTF page 4	 25VT TE F-M-M NPTF page 4	 25VK TE F-F-M NPTF page 4	 25VA TE M-M-M NPTF page 5	 25WJ Cross F-F-F-F NPTF page 5	

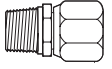
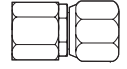
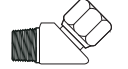
NPSM (PIPE SWIVEL)

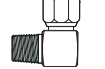
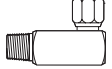
NPSM-NPTF

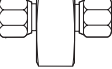
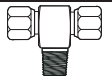
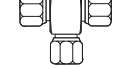













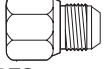
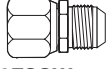
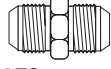

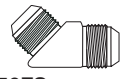

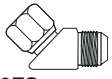
 60SA-61SA M-NPTF F-NPSM swivel page 5	 60SG F-NPTF F-NPSM swivel page 5	 60TA M-NPTF F-NPSM swivel page 6	 60TG F-NPTF F-NPSM swivel page 6	 60UA M-NPTF F-NPSM swivel page 6	 60UC M-NPTF long F-NPSM swivel page 6	 60UG F-NPTF F-NPSM swivel page 7	 60VH TE-F-F-F F-NPTF/F-NPSM swivel page 7
 60VC TE-F-M-F M-NPTF/F-NPSM swivel page 7	 60VJ TE-F-F-F F-NPSM swivel page 7						

NPSM-ORB

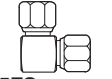
 60SB M-ORB F-NPSM swivel page 7	 60TB M-ORB F-NPSM swivel page 8	 60UB M-ORB F-NPSM swivel page 8					
--	--	--	--	--	--	--	--

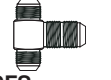

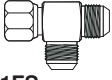
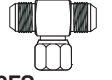
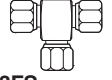



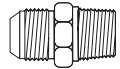
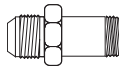
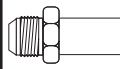
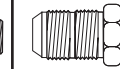
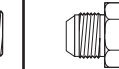
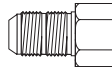

JIC (37° FLARE)

JIC-JIC

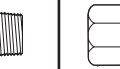
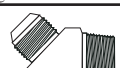
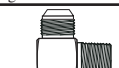
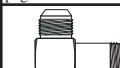
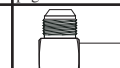
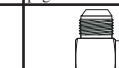

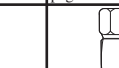
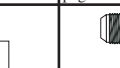
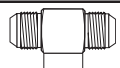
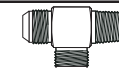
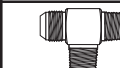
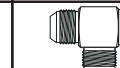

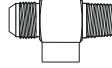

 830FS Plug F-JIC page 8	 839FS Plug M-JIC page 8	 840FS Sleeve JIC page 9	 841FS Nut JIC page 9	 883FS F-JIC solid M-JIC page 9	 883FSSW F-JIC swivel M-JIC page 10	 842FS M-JIC M-JIC page 10	 832FS M-JIC M-JIC bulkhead page 10
 880FS F-JIC swivel F-JIC swivel page 10	 856FS M-JIC M-JIC page 11	 854BHFS M-JIC M-JIC bulkhead page 11	 889FS F-JIC swivel M-JIC page 11	 855FS M-JIC M-JIC page 11	 855BHFS M-JIC M-JIC bulkhead page 11	 879FS F-JIC swivel M-JIC page 11	 875FS F-JIC swivel F-JIC swivel page 12
 844FS TE M-M-M JIC page 12	 870FS TE M-M-M M-JIC bulkhead page 12	 861FS TE M-M-M M-JIC bulkhead page 12	 871FS TE F-M-M M-JIC / F-JIC swivel page 12	 872FS TE M-F-M M-JIC / F-JIC swivel page 13	 873FS TE F-F-F F-JIC swivel page 13	 852FS Cross M-JIC page 13	

JIC (37° FLARE)

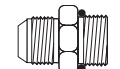
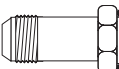
JIC-NPTF

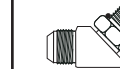
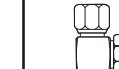
 848FS M-JIC M-NPTF page 13	 848LFS M-JIC M-NPTF long page 14	 848LLFS M-JIC M-NPTF X-long page 14	 848BHFS M-JIC bulkhead M-NPTF page 14	 846FS M-JIC F-NPTF page 14	 847FS M-JIC bulkhead F-NPTF page 15	 881FS F-JIC swivel M-NPTF page 15	 882FS F-JIC swivel F-NPTF page 15
 854FS M-JIC M-NPTF page 15	 849FS M-JIC M-NPTF page 16	 849LFS M-JIC M-NPTF long page 16	 849LLFS M-JIC M-NPTF X-long page 16	 850FS M-JIC F-NPTF page 17	 878FS F-JIC swivel M-NPTF page 17	 877FS F-JIC swivel F-NPTF page 17	 845FS TE M-M-M M-JIC / M-NPTF page 17
 858FS TE M-F-M M-JIC / F-NPTF page 18	 851FS TE M-M-M M-JIC / M-NPTF page 18	 853FS TE M-M-M M-JIC / M-NPTF page 18	 857FS TE M-M-F M-JIC / F-NPTF page 18	 860FS TE M-M-F M-JIC / (M/F)-NPTF page 18	 859FS TE M-F-M M-JIC / (M/F)-NPTF page 19	 862FS TE F-M-F M-JIC / F-NPTF page 19	 863FS TE M-F-F M-JIC / F-NPTF page 19

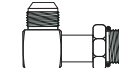
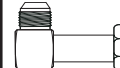
JIC-ORB

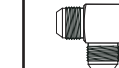
 848FSO M-JIC M-ORB page 19	 848LFSO M-JIC M-ORB long page 20	 881FSO F-JIC swivel M-ORB page 20	 854FSO M-JIC M-ORB page 20	 878FSO F-JIC swivel M-ORB page 20
 849FSO M-JIC M-ORB page 21	 849LFSO M-JIC M-ORB long page 21	 849LLFSO M-JIC M-ORB X-long page 21	 845FSO TE M-M-M M-JIC / M-ORB page 21	 851FSO TE M-M-M M-JIC / M-ORB page 22

JIC-INV.

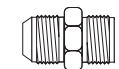
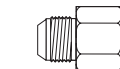
 848FSV M-JIC M-inverted flare page 22	 846FSV M-JIC F-inverted flare page 22



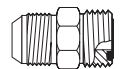
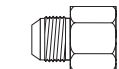
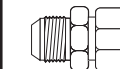
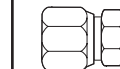





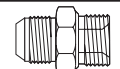
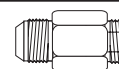
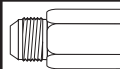
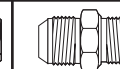

JIC-ORFS

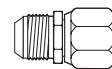
 848TTJ M-JIC M-ORFS page 22	 846TTJ M-JIC F-ORFS solid page 22	 846TTJSW M-JIC F-ORFS swivel page 22	 881TTJ F-JIC swivel M-ORFS page 23
--	--	---	---

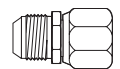
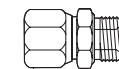
JIC-BANJO

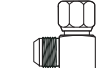

 848FSBJ M-JIC Banjo page 23		
--	--	--

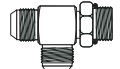
JIC-BSPP

 848FSB M-JIC M-BSPP page 23	 848FSBL M-JIC M-BSPP long page 23	 848FSBLL M-JIC M-BSPP X-long page 24	 848FSJ M-JIC M-JIS page 24	 846FSB M-JIC F-BSPP solid page 24	 846FSBSW M-JIC F-BSPP swivel page 24	 846FSJ M-JIC F-JIS page 24	 846FSH M-JIC F-BSPP flat-face solid page 24
 846FSHSW M-JIC F-BSPP flat-face swivel page 25	 881FSB F-JIC swivel M-BSPP page 25	 882FSB F-JIC swivel F-BSPP swivel page 25	 854FSB M-JIC M-BSPP adj. page 25	 849FSB M-JIC M-BSPP adj. page 25	 850FSB M-JIC F-BSPP swivel page 25	 878FSB F-JIC swivel M-BSPP page 26	 845FSB TE M-M-M M-JIC / M-BSPP adj. page 26
 851FSB TE M-M-M M-JIC / M-BSPP adj. page 26							

JIC (37° FLARE)

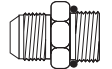
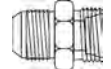
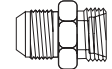
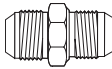
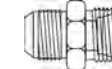
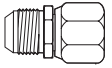
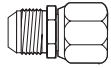
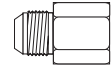
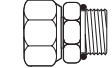
JIC-METRIC





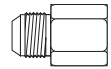
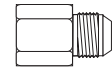





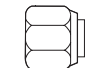
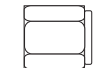

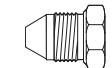

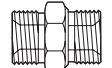
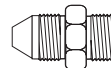
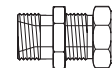
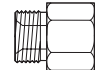
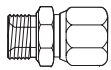
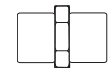
 848FSM (port only) M-JIC M-METRIC page 26	 848FSML (port and tube) M-JIC M-METRIC light (P.26)	 848FSMH (port and tube) M-JIC M-METRIC heavy(P.27)	 848FSK M-JIC M-KOMATSU page 27	 848FSKB M-JIC M-KOBELCO page 27
 846FSML M-JIC F-METRIC swivel light page 27	 846FSMH M-JIC F-METRIC swivel heavy page 28	 846FSK M-JIC F-KOMATSU page 28	 881FSM F-JIC swivel M-METRIC page 28	 849FSM M-JIC M-METRIC adj. page 28

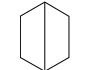
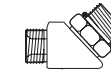
JIC-SAE45

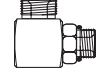
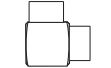
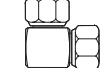
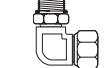
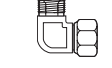
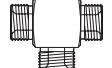

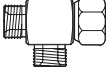
 835FS M-JIC F-SAE45 solid page 28	 836FS F-JIC solid M-SAE45 page 29
--	--

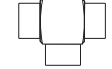
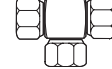
BSPP

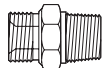
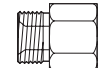
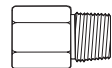
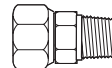
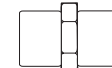

BSPP-BSPP

 630FS Plug F-BSPP swivel page 29	 630FSJ Plug F-JIS page 29	 639FS Plug M-BSPP hex. head page 29	 639FSJ Plug M-JIS page 29	 639FSR Plug M-BSPP hex. socket page 29	 642FS M-BSPP M-BSPP page 30	 642FSJ M-JIS M-JIS page 30	 632FS M-BSPP M-BSPP bulkhead page 30
 683FS M-BSPP F-BSPP solid page 30	 683FSSW M-BSPP F-BSPP swivel page 31	 680FS F-BSPP solid F-BSPP solid page 31	 680FSSW F-BSPP swivel F-BSPP swivel page 31	 698FS BSPP flat-face Sealing seat page 32	 699FS BSPP-JIS Sealing seat page 32	 656FSA M-BSPP M-BSPP adj. page 32	 655FS M-BSPP M-BSPP page 32
 655FSA M-BSPP M-BSPP adj. page 32	 674FS F-BSPP solid F-BSPP solid page 32	 675FS F-BSPP swivel F-BSPP swivel page 33	 679FS M-BSPP adj. F-BSPP swivel page 33	 679FSB M-BSPP F-BSPP swivel page 33	 644FS TE M-M-M M-BSPP page 33	 670FS TE M-M-M M-BSPP/M-BSPP adj. page 33	 661FS TE M-M-M M-BSPP/M-BSPP adj. page 33
 671FS TE M-M-F M-BSPP/F-BSPP swivel page 34	 672FS TE M-F-M M-BSPP/F-BSPP swivel page 34	 673FS TE F-F-F F-BSPP solid page 34	 673FSSW TE F-F-F F-BSPP swivel page 34	 677FS TE M-F-F M-BSPP/F-BSPP swivel page 34			



BSPP-NPTF

 648FS M-BSPP M-NPTF page 34	 646FS M-BSPP F-NPTF page 35	 681FS F-BSPP solid M-NPTF page 35	 681FSSW F-BSPP swivel M-NPTF page 35	 682FS F-BSPP solid F-NPTF page 35	 649FS M-BSPP M-NPTF page 36		
--	--	--	---	--	--	--	--

BSPP-METRIC

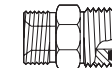
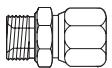

 648FSM M-BSPP M-METRIC page 36	 681FSM F-BSPP swivel M-METRIC page 36	 646FSM M-BSPP F-METRIC swivel page 36
---	--	--

BSPP-ORFS

 648TT M-BSPP M-ORFS page 36	 646TT M-BSPP F-ORFS swivel page 36	 649TT M-BSPP adj. M-ORFS page 37
--	---	---













BSPP

BSPP-ORB



 648FSO M-BSPP M-ORB page 37	 646FSO M-BSPP F-ORB page 37	 681FSO F-BSPP solid F-ORB page 37					
--	--	--	--	--	--	--	--

METRIC



METRIC-METRIC

 630FSM Plug F-METRIC page 37	 639FSM Plug M-METRIC page 38	 639FSMR Plug M-METRIC socket page 38	 639FSMO Plug M-METRIC o'ring page 38	 630FSK Plug F-Komatsu page 39	 639FSK Plug M-Komatsu page 39	 642FSM M-METRIC M-METRIC page 39	 642FSK M-Komatsu M-Komatsu page 39
 680FSM F-METRIC swivel F-METRIC swivel page 39	 683FSML M-METRIC F-METRIC swivel light page 39	 683FSMH M-METRIC F-METRIC swivel heavy page 40	 683FSMS M-METRIC F-METRIC solid page 40				

METRIC-ORB

 626FSO M-METRIC F-ORB page 40	 623FSO F-METRIC solid F-ORB page 40	
---	---	--

METRIC-ORFS

















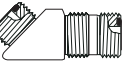

 618TT M-METRIC M-ORFS page 40	 619TT M-METRIC adj. M-ORFS page 41		
---	--	--	--

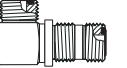
METRIC-NPTF

 626FS M-METRIC F-NPTF page 41	 622FS F-METRIC solid M-NPTF page 41	 628FS M-METRIC M-NPTF page 41					
--	--	--	--	--	--	--	--





ORFS (O'RING FACE)

ORFS-ORFS



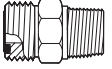
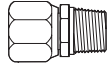
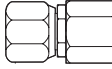

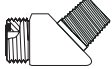

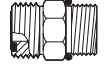
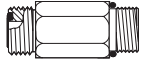

 841TT Nut ORFS page 42	 883TT (2 pieces) F-ORFS swivel M-ORFS page 42	 883TTR F-ORFS solid M-ORFS page 42	 830TT Plug F-ORFS page 42	 839TT Plug M-ORFS page 42	 842TT M-ORFS M-ORFS page 42	 832TT M-ORFS M-ORFS bulkhead page 43	 880TT F-ORFS swivel F-ORFS swivel page 43
 889TT M-ORFS F-ORFS swivel page 43	 854BH TT M-ORFS M-ORFS bulkhead page 43	 855TT M-ORFS M-ORFS page 43	 855BH TT M-ORFS M-ORFS bulkhead page 44	 879TT M-ORFS F-ORFS swivel page 44	 844TT TE M-M-M M-ORFS page 44	 870TT TE M-M-M M-ORFS bulkhead page 44	 861TT TE M-M-M M-ORFS bulkhead page 44
 871TT TE F-M-M M-ORFS / F-ORFS swivel page 44	 872TT TE M-F-M M-ORFS / F-ORFS swivel page 45	 852TT Cross M-ORFS page 45					

ORFS (O'RING FACE)

ORFS-NPTF







 848TT M-ORFS M-NPTF page 45	 881TT F-ORFS swivel M-NPTF page 45	 882TT F-ORFS swivel F-NPTF page 45	 846TT M-ORFS F-NPTF page 46	 854TT M-ORFS M-NPTF page 46	 849TT M-ORFS M-NPTF page 46		
--	---	---	--	--	--	--	--

ORFS-ORB

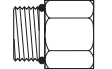

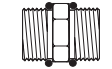

 848TTO M-ORFS M-ORB page 46	 848LTTO M-ORFS M-ORB long page 47	 846TTO M-ORFS F-ORB page 47	 881TTO F-ORFS swivel M-ORB page 47	 854TTO M-ORFS M-ORB adj. page 47	 878TTO F-ORFS swivel M-ORB adj. page 47	 849TTO M-ORFS M-ORB adj. page 48	 845TTO TE M-M-M M-ORFS / M-ORB adj. page 48
 851TTO TE M-M-M M-ORFS / M-ORB adj. page 48							

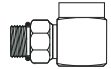
ORB (O'RING BOSS)

ORB-ORB

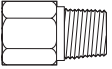
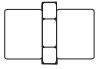
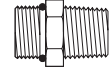

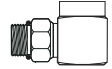
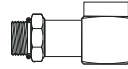
 719FSO M-ORB F-ORB page 48	 721FSO Plug M-ORB hex. head page 49	 723FSO Plug M-ORB hex. socket page 49	 780FSO F-ORB F-ORB page 49	 742FSO M-ORB M-ORB page 49	 755FSO M-ORB adj. M-ORB adj. page 49	 779FSO M-ORB adj. F-ORB page 49	
---	--	--	---	---	---	--	--

ORB-NPTF

 728FSO F-ORB M-NPTF page 50	 726FSO F-ORB F-NPTF page 50	 722FSO M-ORB M-NPTF page 50	 720FSO M-ORB F-NPTF page 50	 725FSO M-ORB adj. F-NPTF page 51	 725LFSO M-ORB adj. long F-NPTF page 51	 729FSO M-ORB adj. M-NPTF page 51	
--	--	--	--	---	---	---	--

ADAPTER TUBE

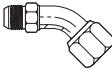
JIC-JIC





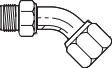
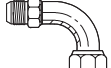

 63TA M-JIC F-JIC swivel page 51	 63UA M-JIC F-JIC swivel page 51	 63UC M-JIC F-JIC swivel page 51					
--	--	--	--	--	--	--	--

JIC-BSPP

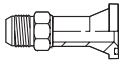
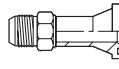
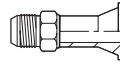
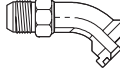
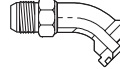
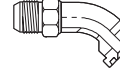
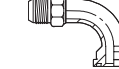
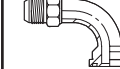

 61TA M-JIC F-BSPP swivel page 52	 61UA M-JIC F-BSPP swivel page 52						
---	---	--	--	--	--	--	--

ADAPTER TUBE

JIC-FLANGE

 63SB M-JIC FLANGE (code 61) page 52	 63SE M-JIC FLANGE (code 61 HD) page 52	 63SF M-JIC FLANGE (code 62) page 52	 63TB M-JIC FLANGE (code 61) page 53	 63TE M-JIC FLANGE (code 61 HD) page 53	 63TF M-JIC FLANGE (code 62) page 53	 63UB M-JIC FLANGE (code 61) page 53	 63UE M-JIC FLANGE (code 61 HD) page 53
 63UF M-JIC FLANGE (code 62) page 54	 PA Split flange Code 61 page 54	 PH Split flange Code 62 page 54	 PA77 O'ring flange 90 duro page 67	 PA77V O'ring flange Viton page 67			

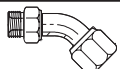

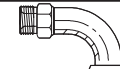
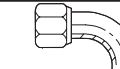

BSPP-BSPP

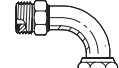
 62TA M-BSPP F-BSPP swivel page 54	 62TD F-BSPP swivel F-BSPP swivel page 54	 62UA M-BSPP F-BSPP swivel page 55	 62UD F-BSPP swivel F-BSPP swivel page 55				
--	---	--	---	--	--	--	--

ORFS-ORFS

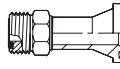
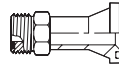
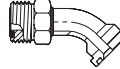
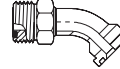
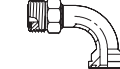
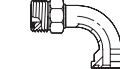

 64TA M-ORFS F-ORFS swivel page 55	 64UA M-ORFS F-ORFS swivel page 55	 64UC M-ORFS F-ORFS swivel long page 55					
---	---	--	--	--	--	--	--

ORFS-FLANGE





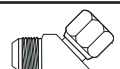

 64SB M-ORFS FLANGE (code 61) page 55	 64SF M-ORFS FLANGE (code 62) page 56	 64TB M-ORFS FLANGE (code 61) page 56	 64TF M-ORFS FLANGE (code 62) page 56	 64UB M-ORFS FLANGE (code 61) page 56	 64UF M-ORFS FLANGE (code 62) page 56		
 PA Split flange Code 61 page 54	 PH Split flange Code 62 page 54	 PA77 O'ring flange 90 duro page 67	 PA77V O'ring flange Viton page 67				

SAE 45 (45° FLARE)



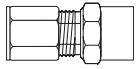
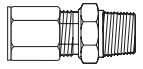
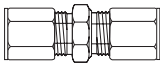

SAE45-SAE45

 589FS M-SAE45 F-SAE45 swivel page 56	 579FS M-SAE45 F-SAE45 swivel page 57						
---	---	--	--	--	--	--	--

FLARELESS (COMPRESSION)

 1960FS Tube sleeve page 57	 1961FS Tube nut page 57	 1946FS Tube F-NPTF page 57	 1948FS Tube M-NPTF page 57	 1942FS Tube Tube page 57	 1954FS Tube M-NPTF page 58	 1949FS Tube M-NPTF page 58	 1955FS Tube Tube page 58
--	---	---	---	---	---	---	---

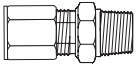
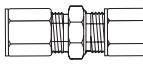





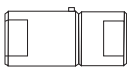
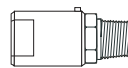
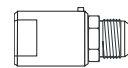
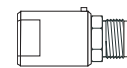
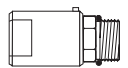
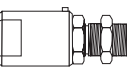
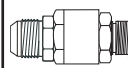
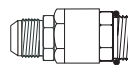
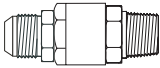
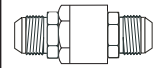
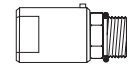



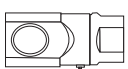
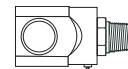
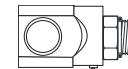
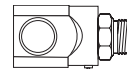
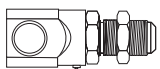
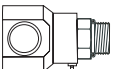

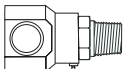
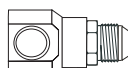
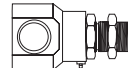
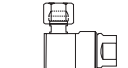
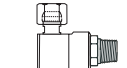
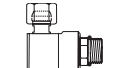
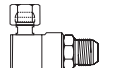
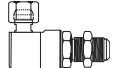
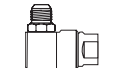
FLARELESS METRIC (COMPRESSION)

 1960FSM Tube sleeve page 58	 1961FSM Tube nut page 58	 1946FSM Tube M-NPTF page 59	 1942FSM Tube Tube page 59	 1949FSM Tube M-NPTF page 59	 1955FSM Tube Tube page 59		
---	--	--	--	--	--	--	--

















INLINE HYDRAULIC SWIVELS

 59SP F-NPTF F-NPTF page 60	 59SS F-NPTF M-NPTF page 60	 59SL F-NPTF M-JIC page 60	 59SX F-JIC M-JIC page 60	 59ST F-NPTF M-ORB page 60	 59SXBH F-JIC M-JIC bulkhead page 60	 59SJBH M-JIC M-JIC bulkhead page 61	 59SB M-JIC M-ORB page 61
 59SA M-JIC M-NPTF page 61	 59SJ M-JIC M-JIC page 61	 59SZ F-JIC M-ORB page 61					

90° HYDRAULIC SWIVELS

 59UP F-NPTF F-NPTF 90° page 61	 59US F-NPTF M-NPTF 90° page 62	 59UT F-NPTF M-ORB 90° page 62	 59UL F-NPTF M-JIC 90° page 62	 59ULBH F-NPTF M-JIC bulkhead 90° page 62	 59UR F-ORB M-ORB 90° page 62	 59UO F-ORB F-NPTF 90° page 62	 59UQ F-ORB M-NPTF 90° page 63
 59UI F-ORB M-JIC 90° page 63	 59UIBH F-ORB M-JIC bulkhead 90° page 63	 59UE F-NPSM F-NPTF 90° page 63	 59UC F-NPSM M-NPTF 90° page 63	 59UD F-NPSM M-ORB 90° page 63	 59UK F-NPSM M-JIC 90° page 64	 59UKBH F-NPSM M-JIC bulkhead 90° page 64	 59UH M-JIC F-NPTF 90° page 64
 59UA M-JIC M-NPTF 90° page 64	 59UB M-JIC M-ORB 90° page 64	 59UJ M-JIC M-JIC 90° page 64	 59UJBH M-JIC M-JIC bulkhead 90° page 65	 59UF M-NPTF F-NPTF 90° page 65	 59UG M-NPTF M-NPTF 90° page 65	 59UV M-NPTF M-ORB 90° page 65	 59UN M-NPTF M-JIC 90° page 65
 59UNBH M-NPTF M-JIC bulkhead 90° page 65							

O'RINGS AND NUTS

 <p>711FSO Nut bulkhead JIC-ORB page 66</p>	 <p>711TTO Nut bulkhead ORFS page 66</p>	 <p>711BPO Nut bulkhead BSPP page 66</p>	 <p>710FSO O'ring boss ORB page 66</p>	 <p>710FSM O'ring boss Metric page 66</p>	 <p>710TTO O'ring face ORFS page 66</p>	 <p>710ORO O'ring (retainer) BSPP page 67</p>	 <p>710ORM O'ring (retainer) Metric page 67</p>
 <p>PA77 O'ring flange PA-PH (90 duro) page 67</p>	 <p>PA77V O'ring flange PA-PH (viton) page 67</p>	 <p>710RRO Retainer ring BSPP page 67</p>	 <p>710RRM Retainer ring Metric page 68</p>	 <p>710BSB Bonded seal BSPP page 68</p>	 <p>710BSM Bonded seal Metric page 68</p>	 <p>712BSP Copper washer BSPP page 68</p>	 <p>712MET Copper washer Metric page 68</p>

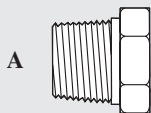
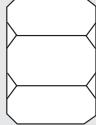
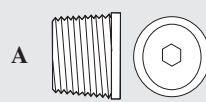
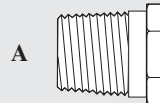
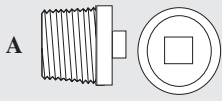
 24ST Bouchon mâle NPTF tête hexagone Hexagone head NPTF male plug		 24SF Bouchon femelle NPTF NPTF female plug		
Numéro Part number	A (")	Numéro Part number	A (")	
24ST02	1/8	24SF02	1/8	
24ST04	1/4	24SF04	1/4	
24ST06	3/8	24SF06	3/8	
24ST08	1/2	24SF08	1/2	
24ST12	3/4	24SF12	3/4	
24ST16	1			
24ST20	1-1/4			
24ST24	1-1/2			
24ST32	2			
 24SR Bouchon mâle NPTF type Allen Allen type NPTF male plug		 24SB Mâle NPTF / Femelle NPTF Male NPTF / Female NPTF		
Numéro Part number	A (")	Numéro Part number	A (")	B (")
24SR01	1/16	24SB04X02	1/4	1/8
24SR02	1/8	24SB06X02	3/8	1/8
24SR04	1/4	24SB06X04	3/8	1/4
24SR06	3/8	24SB08X02	1/2	1/8
24SR08	1/2	24SB08X04	1/2	1/4
24SR12	3/4	24SB08X06	1/2	3/8
24SR16	1	24SB12X02	3/4	1/8
24SR20	1-1/4	24SB12X04	3/4	1/4
24SR24	1-1/2	24SB12X06	3/4	3/8
24SR32	2	24SB12X08	3/4	1/2
		24SB16X04	1	1/4
		24SB16X06	1	3/8
		24SB16X08	1	1/2
		24SB16X12	1	3/4
		24SB20X08	1-1/4	1/2
		24SB20X12	1-1/4	3/4
		24SB20X16	1-1/4	1
		24SB24X12	1-1/2	3/4
		24SB24X16	1-1/2	1
		24SB24X20	1-1/2	1-1/4
		24SB32X12	2	3/4
		24SB32X16	2	1
		24SB32X20	2	1-1/4
		24SB32X24	2	1-1/2
 25SP Bouchon mâle NPTF tête carrée Square head NPTF male plug				
Numéro Part number	A (")			
25SP02	1/8			
25SP04	1/4			
25SP06	3/8			
25SP08	1/2			
25SP12	3/4			
25SP16	1			
25SP20	1-1/4			

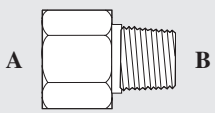
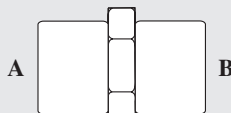
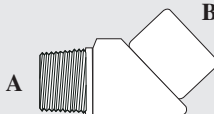
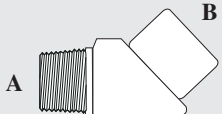
			Numéro Part number	A (")	B (")			
24SG Femelle NPTF / Mâle NPTF Female NPTF / Male NPTF			24SA16X12	1	3/4			
			24SA16X16	1	1			
			24SA20X12	1-1/4	3/4			
			24SA20X16	1-1/4	1			
			24SA20X20	1-1/4	1-1/4			
			24SA24X12	1-1/2	3/4			
			24SA24X16	1-1/2	1			
			24SA24X20	1-1/2	1-1/4			
			24SA24X24	1-1/2	1-1/2			
			24SA32X32	2	2			
						24SJ Femelle NPTF / Femelle NPTF Female NPTF / Female NPTF		
						Numéro Part number	A (")	B (")
						24SJ02X02	1/8	1/8
						24SJ04X02	1/4	1/8
24SJ04X04	1/4	1/4						
24SJ06X02	3/8	1/8						
24SJ06X04	3/8	1/4						
24SJ06X06	3/8	3/8						
24SJ08X04	1/2	1/4						
24SJ08X06	1/2	3/8						
24SJ08X08	1/2	1/2						
24SJ12X08	3/4	1/2						
24SJ12X12	3/4	3/4						
24SJ16X12	1	3/4						
24SJ16X16	1	1						
24SJ20X20	1-1/4	1-1/4						
24SJ24X24	1-1/2	1-1/2						
24SJ32X32	2	2						
			24SA Mâle NPTF / Mâle NPTF Male NPTF / Male NPTF					
			Numéro Part number	A (")	B (")			
			24SA02X02	1/8	1/8			
			24SA04X02	1/4	1/8			
			24SA04X04	1/4	1/4			
			24SA06X02	3/8	1/8			
			24SA06X04	3/8	1/4			
			24SA06X06	3/8	3/8			
			24SA08X04	1/2	1/4			
			24SA08X06	1/2	3/8			
			24SA08X08	1/2	1/2			
			24SA12X06	3/4	3/8			
			24SA12X08	3/4	1/2			
			24SA12X12	3/4	3/4			
24SA16X08	1	1/2						
			25TG Mâle NPTF / Femelle NPTF Male NPTF / Female NPTF					
			Numéro Part number	A (")	B (")			
			25TG02X02	1/8	1/8			
			25TG04X04	1/4	1/4			
			25TG06X06	3/8	3/8			
			25TG08X08	1/2	1/2			
			25TG12X12	3/4	3/4			
			25TG16X16	1	1			
			25TG20X20	1-1/4	1-1/4			
			25TG24X24	1-1/2	1-1/2			
			25TG32X32	2	2			

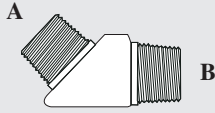
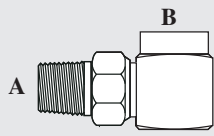
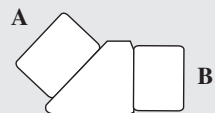
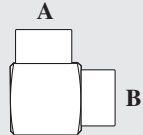
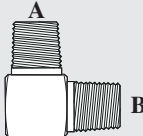
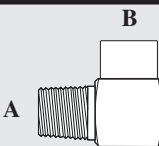
 <p>25TA Mâle NPTF / Mâle NPTF Male NPTF / Male NPTF</p>			Numéro Part number	A (")	B (")			
			25UG20X20	1-1/4	1-1/4			
			25UG24X24	1-1/2	1-1/2			
			25UG32X32	2	2			
 <p>25UGSW Mâle NPTF tournant / Femelle NPTF Male NPTF swivel / Female NPTF</p>			Numéro Part number	A (")	B (")			
			25UGSW04X04	1/4	1/4			
			25UGSW06X06	3/8	3/8			
			25UGSW08X08	1/2	1/2			
			25UGSW12X12	3/4	3/4			
			25UGSW16X16	1	1			
			 <p>25TJ Femelle NPTF / Femelle NPTF Female NPTF / Female NPTF</p>			Numéro Part number	A (")	B (")
						25TJ04X04	1/4	1/4
25TJ06X06	3/8	3/8						
25TJ08X08	1/2	1/2						
25TJ12X12	3/4	3/4						
25TJ16X16	1	1						
 <p>25UJ Femelle NPTF / Femelle NPTF Female NPTF / Female NPTF</p>			Numéro Part number	A (")	B (")			
			25UJ02X02	1/8	1/8			
			25UJ04X02	1/4	1/8			
			25UJ04X04	1/4	1/4			
			25UJ06X04	3/8	1/4			
			25UJ06X06	3/8	3/8			
			25UJ08X06	1/2	3/8			
			25UJ08X08	1/2	1/2			
			25UJ12X08	3/4	1/2			
			25UJ12X12	3/4	3/4			
			25UJ16X12	1	3/4			
			25UJ16X16	1	1			
			25UJ20X20	1-1/4	1-1/4			
			25UJ24X24	1-1/2	1-1/2			
25UJ32X32	2	2						
 <p>25UA Mâle NPTF / Mâle NPTF Male NPTF / Male NPTF</p>			Numéro Part number	A (")	B (")			
			25UA02X02	1/8	1/8			
			25UA04X02	1/4	1/8			
			 <p>25UG Mâle NPTF / Femelle NPTF Male NPTF / Female NPTF</p>			Numéro Part number	A (")	B (")
						25UG02X02	1/8	1/8
						25UG02X04	1/8	1/4
						25UG04X02	1/4	1/8
						25UG04X04	1/4	1/4
						25UG04X06	1/4	3/8
						25UG06X04	3/8	1/4
						25UG06X06	3/8	3/8
						25UG06X08	3/8	1/2
						25UG08X06	1/2	3/8
						25UG08X08	1/2	1/2
						25UG08X12	1/2	3/4
						25UG12X08	3/4	1/2
						25UG12X12	3/4	3/4
						25UG12X16	3/4	1
25UG16X16	1	1						

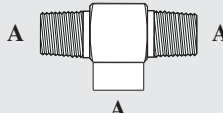
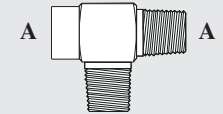
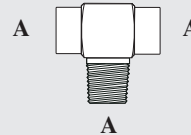
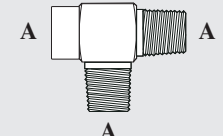
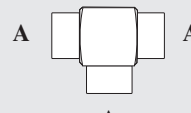
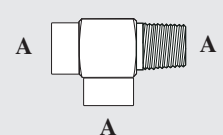

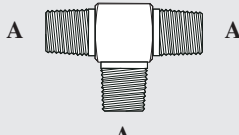
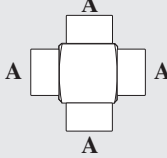
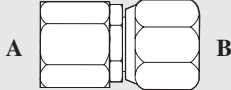
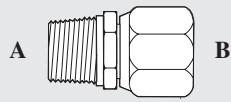
Numéro Part number	A (")	B (")	Numéro Part number	A (")																		
25UA04X04	1/4	1/4	25VJ06	3/8																		
25UA06X04	3/8	1/4	25VJ08	1/2																		
25UA06X06	3/8	3/8	25VJ12	3/4																		
25UA08X06	1/2	3/8	25VJ16	1																		
25UA08X08	1/2	1/2	25VJ20	1-1/4																		
25UA12X08	3/4	1/2	25VJ24	1-1/2																		
25UA12X12	3/4	3/4	25VJ32	2																		
25UA16X12	1	3/4																				
25UA16X16	1	1																				
25UA20X20	1-1/4	1-1/4																				
25UA24X24	1-1/2	1-1/2																				
			25VG Mâle NPTF / Femelle NPTF / Mâle NPTF Male NPTF / Female NPTF / Male NPTF																			
			<table border="1"> <thead> <tr> <th>Numéro Part number</th> <th>A (")</th> </tr> </thead> <tbody> <tr> <td>25VG02</td> <td>1/8</td> </tr> <tr> <td>25VG04</td> <td>1/4</td> </tr> <tr> <td>25VG06</td> <td>3/8</td> </tr> <tr> <td>25VG08</td> <td>1/2</td> </tr> <tr> <td>25VG12</td> <td>3/4</td> </tr> <tr> <td>25VG16</td> <td>1</td> </tr> </tbody> </table>	Numéro Part number	A (")	25VG02	1/8	25VG04	1/4	25VG06	3/8	25VG08	1/2	25VG12	3/4	25VG16	1					
Numéro Part number	A (")																					
25VG02	1/8																					
25VG04	1/4																					
25VG06	3/8																					
25VG08	1/2																					
25VG12	3/4																					
25VG16	1																					
25UASW Mâle NPTF / Mâle NPTF tournant Male NPTF / Male NPTF swivel			<table border="1"> <thead> <tr> <th>Numéro Part number</th> <th>A (")</th> </tr> </thead> <tbody> <tr> <td>25VT02</td> <td>1/8</td> </tr> <tr> <td>25VT04</td> <td>1/4</td> </tr> <tr> <td>25VT06</td> <td>3/8</td> </tr> <tr> <td>25VT08</td> <td>1/2</td> </tr> <tr> <td>25VT12</td> <td>3/4</td> </tr> <tr> <td>25VT16</td> <td>1</td> </tr> <tr> <td>25VT20</td> <td>1-1/4</td> </tr> <tr> <td>25VT24</td> <td>1-1/2</td> </tr> </tbody> </table>		Numéro Part number	A (")	25VT02	1/8	25VT04	1/4	25VT06	3/8	25VT08	1/2	25VT12	3/4	25VT16	1	25VT20	1-1/4	25VT24	1-1/2
Numéro Part number	A (")																					
25VT02	1/8																					
25VT04	1/4																					
25VT06	3/8																					
25VT08	1/2																					
25VT12	3/4																					
25VT16	1																					
25VT20	1-1/4																					
25VT24	1-1/2																					
<table border="1"> <thead> <tr> <th>Numéro Part number</th> <th>A (")</th> <th>B (")</th> </tr> </thead> <tbody> <tr> <td>25UASW04X04</td> <td>1/4</td> <td>1/4</td> </tr> <tr> <td>25UASW06X06</td> <td>3/8</td> <td>3/8</td> </tr> <tr> <td>25UASW08X08</td> <td>1/2</td> <td>1/2</td> </tr> <tr> <td>25UASW12X12</td> <td>3/4</td> <td>3/4</td> </tr> </tbody> </table>	Numéro Part number	A (")	B (")	25UASW04X04	1/4	1/4	25UASW06X06	3/8	3/8	25UASW08X08	1/2	1/2	25UASW12X12	3/4	3/4			25VT Femelle NPTF / Mâle NPTF / Mâle NPTF Female NPTF / Male NPTF / Male NPTF				
Numéro Part number	A (")	B (")																				
25UASW04X04	1/4	1/4																				
25UASW06X06	3/8	3/8																				
25UASW08X08	1/2	1/2																				
25UASW12X12	3/4	3/4																				
25VC Femelle NPTF / Mâle NPTF / Femelle NPTF Female NPTF / Male NPTF / Female NPTF			<table border="1"> <thead> <tr> <th>Numéro Part number</th> <th>A (")</th> </tr> </thead> <tbody> <tr> <td>25VC02</td> <td>1/8</td> </tr> <tr> <td>25VC04</td> <td>1/4</td> </tr> <tr> <td>25VC06</td> <td>3/8</td> </tr> <tr> <td>25VC08</td> <td>1/2</td> </tr> <tr> <td>25VC12</td> <td>3/4</td> </tr> <tr> <td>25VC16</td> <td>1</td> </tr> <tr> <td>25VC20</td> <td>1-1/4</td> </tr> <tr> <td>25VC24</td> <td>1-1/2</td> </tr> </tbody> </table>		Numéro Part number	A (")	25VC02	1/8	25VC04	1/4	25VC06	3/8	25VC08	1/2	25VC12	3/4	25VC16	1	25VC20	1-1/4	25VC24	1-1/2
Numéro Part number	A (")																					
25VC02	1/8																					
25VC04	1/4																					
25VC06	3/8																					
25VC08	1/2																					
25VC12	3/4																					
25VC16	1																					
25VC20	1-1/4																					
25VC24	1-1/2																					
																						
25VJ Femelle NPTF / Femelle NPTF / Femelle NPTF Female NPTF / Female NPTF / Female NPTF			25VK Femelle NPTF / Femelle NPTF / Mâle NPTF Female NPTF / Female NPTF / Male NPTF																			
<table border="1"> <thead> <tr> <th>Numéro Part number</th> <th>A (")</th> </tr> </thead> <tbody> <tr> <td>25VJ02</td> <td>1/8</td> </tr> <tr> <td>25VJ04</td> <td>1/4</td> </tr> </tbody> </table>	Numéro Part number	A (")	25VJ02	1/8	25VJ04	1/4	<table border="1"> <thead> <tr> <th>Numéro Part number</th> <th>A (")</th> </tr> </thead> <tbody> <tr> <td>25VK02</td> <td>1/8</td> </tr> <tr> <td>25VK04</td> <td>1/4</td> </tr> <tr> <td>25VK06</td> <td>3/8</td> </tr> <tr> <td>25VK08</td> <td>1/2</td> </tr> </tbody> </table>		Numéro Part number	A (")	25VK02	1/8	25VK04	1/4	25VK06	3/8	25VK08	1/2				
Numéro Part number	A (")																					
25VJ02	1/8																					
25VJ04	1/4																					
Numéro Part number	A (")																					
25VK02	1/8																					
25VK04	1/4																					
25VK06	3/8																					
25VK08	1/2																					

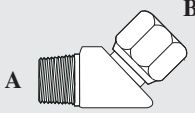
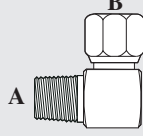
Numéro Part number	A (")		Numéro Part number	A (")	B (")						
25VK12	3/4		60SA04X06	1/4	3/8						
25VK16	1		60SA04X08	1/4	1/2						
25VK20	1-1/4		60SA06X04	3/8	1/4						
25VK24	1-1/2		60SA06X06	3/8	3/8						
 25VA Mâle NPTF / Mâle NPTF / Mâle NPTF Male NPTF / Male NPTF / Male NPTF			60SA06X08	3/8	1/2						
			60SA08X04	1/2	1/4						
			60SA08X06	1/2	3/8						
			60SA08X08	1/2	1/2						
			60SA08X12	1/2	3/4						
			60SA12X08	3/4	1/2						
			60SA12X12	3/4	3/4						
			60SA12X16	3/4	1						
			60SA16X12	1	3/4						
			60SA16X16	1	1						
			60SA16X20	1	1-1/4						
			60SA20X16	1-1/4	1						
60SA20X20	1-1/4	1-1/4									
60SA24X24	1-1/2	1-1/2									
60SA32X32	2	2									
 25WJ Croix femelle NPTF Cross female NPTF			 60SG Femelle NPTF / Femelle NPSM tournant Female NPTF / Female NPSM swivel								
						Numéro Part number	A (")		Numéro Part number	A (")	B (")
						25WJ02	1/8		60SG02X02	1/8	1/8
						25WJ04	1/4		60SG04X04	1/4	1/4
						25WJ06	3/8		60SG04X06	1/4	3/8
						25WJ08	1/2		60SG04X08	1/4	1/2
						25WJ12	3/4		60SG06X04	3/8	1/4
						25WJ16	1		60SG06X06	3/8	3/8
						25WJ20	1-1/4		60SG06X08	3/8	1/2
						25WJ24	1-1/2		60SG08X04	1/2	1/4
						25WJ32	2		60SG08X06	1/2	3/8
						NPSM (pipe swivel)  60SA 61SA (Restriction / Restricted orifice) Mâle NPTF / Femelle NPSM tournant Male NPTF / Female NPSM swivel			60SG08X08 1/2 1/2 60SG12X12 3/4 3/4 60SG12X16 3/4 1 60SG16X12 1 3/4 60SG16X16 1 1 60SG20X20 1-1/4 1-1/4 60SG24X24 1-1/2 1-1/2 60SG32X32 2 2		
Numéro Part number	A (")	B (")									
60SA02X02	1/8	1/8									
60SA02X04	1/8	1/4									
60SA04X02	1/4	1/8									
60SA04X04	1/4	1/4									

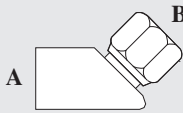
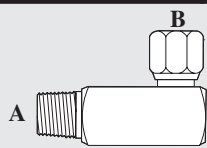
					
60TA Mâle NPTF / Femelle NPSM tournant Male NPTF / Female NPSM swivel			60UA Mâle NPTF / Femelle NPSM tournant Male NPTF / Female NPSM swivel		
Numéro Part number	A (")	B (")	Numéro Part number	A (")	B (")
60TA02X02	1/8	1/8	60UA02X02	1/8	1/8
60TA02X04	1/8	1/4	60UA02X04	1/8	1/4
60TA04X04	1/4	1/4	60UA04X02	1/4	1/8
60TA04X06	1/4	3/8	60UA04X04	1/4	1/4
60TA06X06	3/8	3/8	60UA04X06	1/4	3/8
60TA06X08	3/8	1/2	60UA04X08	1/4	1/2
60TA08X06	1/2	3/8	60UA06X04	3/8	1/4
60TA08X08	1/2	1/2	60UA06X06	3/8	3/8
60TA08X12	1/2	3/4	60UA06X08	3/8	1/2
60TA12X08	3/4	1/2	60UA08X04	1/2	1/4
60TA12X12	3/4	3/4	60UA08X06	1/2	3/8
60TA12X16	3/4	1	60UA08X08	1/2	1/2
60TA16X12	1	3/4	60UA08X12	1/2	3/4
60TA16X16	1	1	60UA12X06	3/4	3/8
60TA16X20	1	1-1/4	60UA12X08	3/4	1/2
60TA20X16	1-1/4	1	60UA12X12	3/4	3/4
60TA20X20	1-1/4	1-1/4	60UA12X16	3/4	1
60TA24X24	1-1/2	1-1/2	60UA16X08	1	1/2
60TA32X32	2	2	60UA16X12	1	3/4
			60UA16X16	1	1
			60UA16X20	1	1-1/4
			60UA20X16	1-1/4	1
			60UA20X20	1-1/4	1-1/4
			60UA24X24	1-1/2	1-1/2
			60UA32X32	2	2

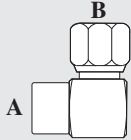
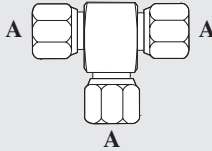
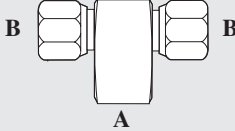
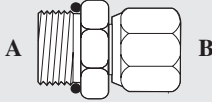
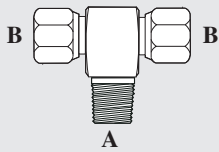
					
60TG Femelle NPTF / Femelle NPSM tournant Female NPTF / Female NPSM swivel			60UC Mâle NPTF long / Femelle NPSM tournant Male NPTF long / Female NPSM swivel		
Numéro Part number	A (")	B (")	Numéro Part number	A (")	B (")
60TG02X02	1/8	1/8	60UC02X02	1/8	1/8
60TG02X04	1/8	1/4	60UC04X04	1/4	1/4
60TG04X04	1/4	1/4	60UC06X06	3/8	3/8
60TG06X04	3/8	1/4	60UC08X08	1/2	1/2
60TG06X06	3/8	3/8	60UC12X12	3/4	3/4
60TG08X06	1/2	3/8	60UC16X16	1	1
60TG08X08	1/2	1/2			
60TG12X08	3/4	1/2			
60TG12X12	3/4	3/4			
60TG16X12	1	3/4			
60TG16X16	1	1			
60TG20X20	1-1/4	1-1/4			
60TG24X24	1-1/2	1-1/2			
60TG32X32	2	2			

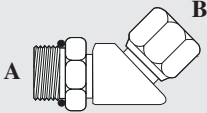
 <p>60UG Femelle NPTF / Femelle NPSM tournant Female NPTF / Female NPSM swivel</p>			Numéro Part number	A (")	B (")			
			60VC12X12	3/4	3/4			
			60VC16X16	1	1			
			60VC20X20	1-1/4	1-1/4			
 <p>60VJ Femelle NPSM tourn. / Fem. NPSM tourn. / Fem. NPSM tourn. Female NPSM swiv. / Female NPSM swiv. / Female NPSM swiv.</p>			Numéro Part number	A (")				
			60VJ02	1/8				
			60VJ04	1/4				
			60VJ06	3/8				
			60VJ08	1/2				
			60VJ12	3/4				
			60VJ16	1				
			60VJ20	1-1/4				
			 <p>60VH Femelle NPSM tourn. / Femelle NPTF / Femelle NPSM tourn. Female NPSM swivel / Female NPTF / Female NPSM swivel</p>			Numéro Part number	A (")	B (")
						60VH02X02	1/8	1/8
60VH04X04	1/4	1/4						
60VH06X06	3/8	3/8						
60VH08X08	1/2	1/2						
60VH12X08	3/4	1/2						
60VH12X12	3/4	3/4						
60VH16X16	1	1						
60VH20X20	1-1/4	1-1/4						
 <p>60SB Mâle o'ring boss / Femelle NPSM tournant Male o'ring boss / Female NPSM swivel</p>						Numéro Part number	A (")	B (")
			60SB04X02	1/4	1/8	710FSO04		
			60SB04X04	1/4	1/4	710FSO04		
			60SB04X06	1/4	3/8	710FSO04		
			60SB05X04	5/16	1/4	710FSO05		
			60SB06X04	3/8	1/4	710FSO06		
			60SB06X06	3/8	3/8	710FSO06		
			60SB06X08	3/8	1/2	710FSO06		
			60SB08X04	1/2	1/4	710FSO08		
			60SB08X06	1/2	3/8	710FSO08		
			60SB08X08	1/2	1/2	710FSO08		
			60SB08X12	1/2	3/4	710FSO08		
			60SB10X06	5/8	3/8	710FSO10		
			60SB10X08	5/8	1/2	710FSO10		
			60SB10X12	5/8	3/4	710FSO10		
			60SB12X08	3/4	1/2	710FSO12		
			60SB12X12	3/4	3/4	710FSO12		
			60SB14X12	7/8	3/4	710FSO14		
			60SB16X12	1	3/4	710FSO16		
			60SB16X16	1	1	710FSO16		
60SB20X16	1-1/4	1	710FSO20					
60SB20X20	1-1/4	1-1/4	710FSO20					
60SB24X24	1-1/2	1-1/2	710FSO24					
60SB32X32	2	2	710FSO32					
 <p>60VC Femelle NPSM tourn. / Mâle NPTF / Femelle NPSM tourn. Female NPSM swivel / Male NPTF / Female NPSM swivel</p>			Numéro Part number	A (")	B (")			
			60VC02X02	1/8	1/8			
			60VC04X04	1/4	1/4			
			60VC06X06	3/8	3/8			
			60VC06X08	3/8	1/2			
			60VC08X06	1/2	3/8			
			60VC08X08	1/2	1/2			
			60VC12X08	3/4	1/2			

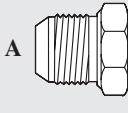
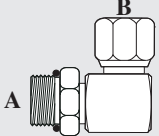
 60TB Mâle o'ring boss / Femelle NPSM tournant Male o'ring boss / Female NPSM swivel				Numéro Part number	A (")	B (")	O'ring
				60UB20X20	1-1/4	1-1/4	710FSO20
60UB24X24	1-1/2	1-1/2	710FSO24				
60UB32X32	2	2	710FSO32				
				JIC (37° flare)			
 830FS Bouchon femelle JIC Female JIC plug				Numéro Part number	A (")		
				830FS02	1/8		
830FS03	3/16						
830FS04	1/4						
830FS05	5/16						
830FS06	3/8						
830FS08	1/2						
830FS10	5/8						
830FS12	3/4						
830FS14	7/8						
830FS16	1						
830FS20	1-1/4						
830FS24	1-1/2						
830FS32	2						
 839FS Bouchon mâle JIC Male JIC plug				Numéro Part number	A (")		
				839FS02	1/8		
839FS03	3/16						
839FS04	1/4						
839FS05	5/16						
839FS06	3/8						
839FS08	1/2						
839FS10	5/8						
839FS12	3/4						
839FS14	7/8						
839FS16	1						
839FS20	1-1/4						
839FS24	1-1/2						
839FS32	2						
 60UB Mâle o'ring boss / Femelle NPSM tournant Male o'ring boss / Female NPSM swivel				Numéro Part number	A (")	B (")	O'ring
				60UB04X04	1/4	1/4	710FSO04
60UB04X06	1/4	3/8	710FSO04				
60UB06X04	3/8	1/4	710FSO06				
60UB06X06	3/8	3/8	710FSO06				
60UB06X08	3/8	1/2	710FSO06				
60UB08X04	1/2	1/4	710FSO08				
60UB08X06	1/2	3/8	710FSO08				
60UB08X08	1/2	1/2	710FSO08				
60UB08X12	1/2	3/4	710FSO08				
60UB10X04	5/8	1/4	710FSO10				
60UB10X06	5/8	3/8	710FSO10				
60UB10X08	5/8	1/2	710FSO10				
60UB10X12	5/8	3/4	710FSO10				
60UB12X08	3/4	1/2	710FSO12				
60UB12X12	3/4	3/4	710FSO12				
60UB12X16	3/4	1	710FSO12				
60UB14X12	7/8	3/4	710FSO14				
60UB16X12	1	3/4	710FSO16				
60UB16X16	1	1	710FSO16				

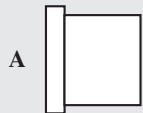
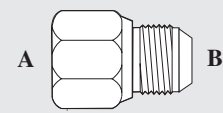
				
840FS Bague JIC Sleeve JIC		883FS Femelle JIC fixe / Mâle JIC Female JIC solid / Male JIC		
Numéro Part number	A (")	Numéro Part number	A (")	B (")
840FS02	1/8	883FS04X06	1/4	3/8
840FS03	3/16	883FS05X04	5/16	1/4
840FS04	1/4	883FS06X04	3/8	1/4
840FS05	5/16	883FS06X05	3/8	5/16
840FS06	3/8	883FS06X08	3/8	1/2
840FS08	1/2	883FS08X04	1/2	1/4
840FS10	5/8	883FS08X05	1/2	5/16
840FS12	3/4	883FS08X06	1/2	3/8
840FS14	7/8	883FS08X10	1/2	5/8
840FS16	1	883FS08X12	1/2	3/4
840FS20	1-1/4	883FS10X04	5/8	1/4
840FS24	1-1/2	883FS10X06	5/8	3/8
840FS32	2	883FS10X08	5/8	1/2
		883FS10X12	5/8	3/4
		883FS12X04	3/4	1/4
		883FS12X06	3/4	3/8
		883FS12X08	3/4	1/2
		883FS12X10	3/4	5/8
		883FS12X16	3/4	1
		883FS14X06	7/8	3/8
		883FS14X08	7/8	1/2
		883FS14X10	7/8	5/8
		883FS14X12	7/8	3/4
		883FS16X04	1	1/4
		883FS16X06	1	3/8
		883FS16X08	1	1/2
		883FS16X12	1	3/4
		883FS16X14	1	7/8
		883FS16X20	1	1-1/4
		883FS20X08	1-1/4	1/2
		883FS20X12	1-1/4	3/4
		883FS20X16	1-1/4	1
		883FS20X24	1-1/4	1-1/2
		883FS24X12	1-1/2	3/4
		883FS24X16	1-1/2	1
		883FS24X20	1-1/2	1-1/4
		883FS32X24	2	1-1/2

	
841FS Écrou JIC Nut JIC	
Numéro Part number	A (")
841FS02	1/8
841FS03	3/16
841FS04	1/4
841FS05	5/16
841FS06	3/8
841FS08	1/2
841FS10	5/8
841FS12	3/4
841FS14	7/8
841FS16	1
841FS20	1-1/4
841FS24	1-1/2
841FS32	2

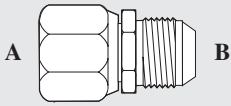
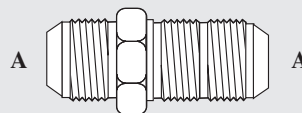
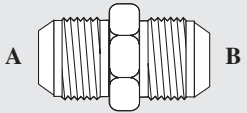
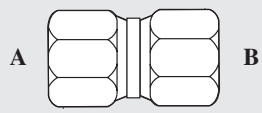
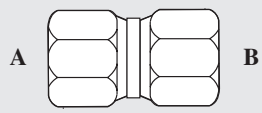
			Numéro Part number	A (")	B (")
883FSSW Femelle JIC tournant / Mâle JIC Female JIC swivel / Male JIC			842FS12X12	3/4	3/4
			842FS14X12	7/8	3/4
			842FS14X14	7/8	7/8
			842FS16X08	1	1/2
			842FS16X10	1	5/8
			842FS16X12	1	3/4
			842FS16X14	1	7/8
			842FS16X16	1	1
			842FS20X12	1-1/4	3/4
			842FS20X16	1-1/4	1
			842FS20X20	1-1/4	1-1/4
			842FS24X16	1-1/2	1
			842FS24X20	1-1/2	1-1/4
			842FS24X24	1-1/2	1-1/2
			842FS32X16	2	1
			842FS32X20	2	1-1/4
			842FS32X24	2	1-1/2
			842FS32X32	2	2
					
832FS Mâle JIC / Mâle JIC cloison Male JIC / Male JIC bulkhead					
			Numéro Part number	A (")	Écrou Nut
842FS Mâle JIC / Mâle JIC Male JIC / Male JIC			832FS04	1/4	711FSO04
			832FS05	5/16	711FSO05
			832FS06	3/8	711FSO06
			832FS08	1/2	711FSO08
			832FS10	5/8	711FSO10
			832FS12	3/4	711FSO12
			832FS16	1	711FSO16
			832FS20	1-1/4	711FSO20
			832FS24	1-1/2	711FSO24
					
880FS Femelle JIC tournant / Femelle JIC tournant Female JIC swivel / Female JIC swivel					
			Numéro Part number	A (")	B (")
			880FS04X04	1/4	1/4
			880FS05X05	5/16	5/16
			880FS06X06	3/8	3/8
			880FS08X08	1/2	1/2
			880FS10X10	5/8	5/8
			880FS12X12	3/4	3/4
			880FS16X16	1	1
Numéro Part number	A (")	B (")			
883FSSW04X04	1/4	1/4			
883FSSW04X06	1/4	3/8			
883FSSW05X05	5/16	5/16			
883FSSW06X06	3/8	3/8			
883FSSW06X08	3/8	1/2			
883FSSW08X06	1/2	3/8			
883FSSW08X08	1/2	1/2			
883FSSW08X10	1/2	5/8			
883FSSW10X10	5/8	5/8			
883FSSW12X10	3/4	5/8			
883FSSW12X12	3/4	3/4			
883FSSW16X16	1	1			
883FSSW16X20	1	1-1/4			
883FSSW20X16	1-1/4	1			
883FSSW20X20	1-1/4	1-1/4			
883FSSW20X24	1-1/4	1-1/2			
883FSSW24X24	1-1/2	1-1/2			
883FSSW32X32	2	2			
842FS02X02	1/8	1/8			
842FS03X03	3/16	3/16			
842FS04X04	1/4	1/4			
842FS05X04	5/16	1/4			
842FS05X05	5/16	5/16			
842FS06X04	3/8	1/4			
842FS06X05	3/8	5/16			
842FS06X06	3/8	3/8			
842FS08X04	1/2	1/4			
842FS08X05	1/2	5/16			
842FS08X06	1/2	3/8			
842FS08X08	1/2	1/2			
842FS10X06	5/8	3/8			
842SF10X08	5/8	1/2			
842FS10X10	5/8	5/8			
842FS12X06	3/4	3/8			
842FS12X08	3/4	1/2			
842FS12X10	3/4	5/8			

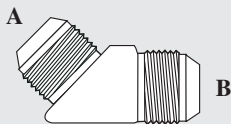
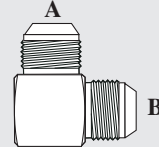
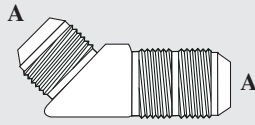
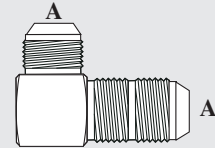
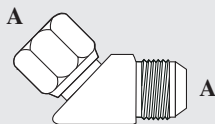
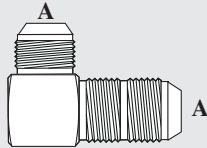
					
856FS Mâle JIC / Mâle JIC Male JIC / Male JIC			855FS Mâle JIC / Mâle JIC Male JIC / Male JIC		
Numéro Part number	A (")	B (")	Numéro Part number	A (")	B (")
856FS04X04	1/4	1/4	855FS04X04	1/4	1/4
856FS06X06	3/8	3/8	855FS05X05	5/16	5/16
856FS08X08	1/2	1/2	855FS06X06	3/8	3/8
856FS10X10	5/8	5/8	855FS06X04	3/8	1/4
856FS12X12	3/4	3/4	855FS08X06	1/2	3/8
			855FS08X08 1/2 1/2 855FS10X08 5/8 1/2 855FS10X10 5/8 5/8 855FS12X12 3/4 3/4 855FS14X14 7/8 7/8 855FS16X12 1 3/4 855FS16X16 1 1 855FS20X20 1-1/4 1-1/4 855FS24X24 1-1/2 1-1/2 855FS32X32 2 2		
854BHFS Mâle JIC / Mâle JIC cloison Male JIC / Male JIC bulkhead			855BHFS Mâle JIC / Mâle JIC cloison Male JIC / Male JIC bulkhead		
Numéro Part number	A (")	Écrou Nut			
854BHFS04	1/4	711FSO04	855BHFS Mâle JIC / Mâle JIC cloison Male JIC / Male JIC bulkhead		
854BHFS05	5/16	711FSO05	Numéro Part number	A (")	Écrou Nut
854BHFS06	3/8	711FSO06	855BHFS04	1/4	711FSO04
854BHFS08	1/2	711FSO08	855BHFS05	5/16	711FSO05
854BHFS10	5/8	711FSO10	855BHFS06	3/8	711FSO06
854BHFS12	3/4	711FSO12	855BHFS08	1/2	711FSO08
854BHFS16	1	711FSO16	855BHFS10	5/8	711FSO10
854BHFS20	1-1/4	711FSO20	855BHFS12	3/4	711FSO12
			855BHFS16 1 711FSO16 855BHFS20 1-1/4 711FSO20		
889FS Femelle JIC tournant / Mâle JIC Female JIC swivel / Male JIC			879FS Femelle JIC tournant / Mâle JIC Female JIC swivel / Male JIC		
Numéro Part number	A (")				
889FS04	1/4		Numéro Part number	A (")	B (")
889FS05	5/16		879FS03X03	3/16	3/16
889FS06	3/8		879FS04X04	1/4	1/4
889FS08	1/2		879FS04X06	1/4	3/8
889FS10	5/8				
889FS12	3/4				
889FS14	7/8				
889FS16	1				
889FS20	1-1/4				
889FS24	1-1/2				
889FS32	2				

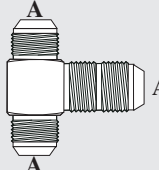
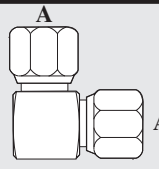
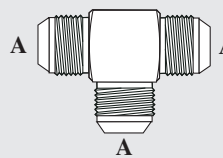
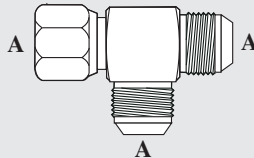
Numéro Part number	A (")	B (")			
879FS05X05	5/16	5/16	870FS Mâle JIC / Mâle JIC cloison / Mâle JIC Male JIC / Male JIC bulkhead / Male JIC		
879FS06X06	3/8	3/8			
879FS08X06	1/2	3/8			
879FS08X08	1/2	1/2			
879FS08X10	1/2	5/8			
879FS10X08	5/8	1/2			
879FS10X10	5/8	5/8			
879FS12X10	3/4	5/8			
879FS12X12	3/4	3/4			
879FS14X14	7/8	7/8			
879FS16X16	1	1			
879FS20X20	1-1/4	1-1/4			
879FS24X24	1-1/2	1-1/2			
879FS32X32	2	2			
					
875FS Femelle JIC tournant / Femelle JIC tournant Female JIC swivel / Female JIC swivel			861FS Mâle JIC / Mâle JIC / Mâle JIC cloison Male JIC / Male JIC / Male JIC bulkhead		
Numéro Part number	A (")	Numéro Part number		A (")	Écrou Nut
875FS04	1/4	861FS06	3/8	711FSO06	
875FS05	5/16	861FS08	1/2	711FSO08	
875FS06	3/8	861FS10	5/8	711FSO10	
875FS08	1/2	861FS12	3/4	711FSO12	
875FS10	5/8	861FS16	1	711FSO16	
875FS12	3/4				
875FS16	1				
					
844FS Mâle JIC / Mâle JIC / Mâle JIC Male JIC / Male JIC / Male JIC			871FS Femelle JIC tournant / Mâle JIC / Mâle JIC Female JIC swivel / Male JIC / Male JIC		
Numéro Part number	A (")	Numéro Part number	A (")		
844FS04	1/4	871FS04	1/4		
844FS05	5/16	871FS05	5/16		
844FS06	3/8	871FS06	3/8		
844FS08	1/2	871FS08	1/2		
844FS10	5/8	871FS10	5/8		
844FS12	3/4	871FS12	3/4		
844FS14	7/8	871FS16	1		
844FS16	1	871FS20	1-1/4		
844FS20	1-1/4	871FS24	1-1/2		
844FS24	1-1/2				
844FS32	2				

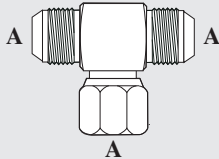
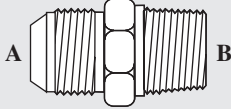
 872FS Mâle JIC / Femelle JIC tournant / Mâle JIC Male JIC / Female JIC swivel / Male JIC		 848FS Mâle JIC / Mâle NPTF Male JIC / Male NPTF		
Numéro Part number	A (")	Numéro Part number	A (")	B (")
872FS04	1/4	848FS02X02	1/8	1/8
872FS05	5/16	848FS03X02	3/16	1/8
872FS06	3/8	848FS04X02	1/4	1/8
872FS08	1/2	848FS04X04	1/4	1/4
872FS10	5/8	848FS04X06	1/4	3/8
872FS12	3/4	848FS04X08	1/4	1/2
872FS16	1	848FS05X02	5/16	1/8
872FS20	1-1/4	848FS05X04	5/16	1/4
872FS24	1-1/2	848FS05X06	5/16	3/8
		848FS05X08	5/16	1/2
		848FS06X02	3/8	1/8
		848FS06X04	3/8	1/4
		848FS06X06	3/8	3/8
		848FS06X08	3/8	1/2
		848FS06X12	3/8	3/4
		848FS08X02	1/2	1/8
		848FS08X04	1/2	1/4
		848FS08X06	1/2	3/8
		848FS08X08	1/2	1/2
		848FS08X12	1/2	3/4
		848FS08X16	1/2	1
		848FS10X04	5/8	1/4
		848FS10X06	5/8	3/8
		848FS10X08	5/8	1/2
		848FS10X12	5/8	3/4
		848FS10X16	5/8	1
		848FS12X06	3/4	3/8
		848FS12X08	3/4	1/2
		848FS12X12	3/4	3/4
		848FS12X16	3/4	1
		848FS12X20	3/4	1-1/4
		848FS12X24	3/4	1-1/2
		848FS14X12	7/8	3/4
		848FS16X08	1	1/2
		848FS16X12	1	3/4
		848FS16X16	1	1
		848FS16X20	1	1-1/4
		848FS16X24	1	1-1/2
		848FS20X12	1-1/4	3/4
		848FS20X16	1-1/4	1
		848FS20X20	1-1/4	1-1/4
		848FS20X24	1-1/4	1-1/2
		848FS24X16	1-1/2	1
		848FS24X20	1-1/2	1-1/4
		848FS24X24	1-1/2	1-1/2
		848FS24X32	1-1/2	2

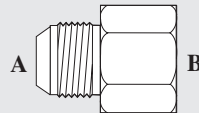
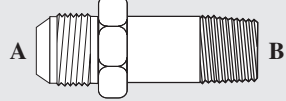
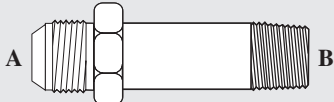
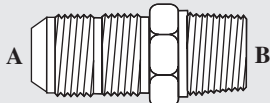
Numéro Part number	A (")	B (")				
848FS32X20	2	1-1/4				
848FS32X24	2	1-1/2				
848FS32X32	2	2				
			846FS Mâle JIC / Femelle NPTF Male JIC / Female NPTF			
Numéro Part number	A (")	B (")				
848LFS			846FS02X02	1/8	1/8	
Mâle JIC / Mâle NPTF long			846FS03X02	3/16	1/8	
Male JIC / Male NPTF long			846FS04X02	1/4	1/8	
Numéro Part number	A (")	B (")	846FS04X04	1/4	1/4	
848LFS04X02	1/4	1/8	846FS04X06	1/4	3/8	
848LFS04X04	1/4	1/4	846FS04X08	1/4	1/2	
848LFS06X06	3/8	3/8	846FS05X02	5/16	1/8	
848LFS08X08	1/2	1/2	846FS05X04	5/16	1/4	
848LFS12X12	3/4	3/4	846FS05X06	5/16	3/8	
			846FS06X02	3/8	1/8	
848LLFS			846FS06X04	3/8	1/4	
			Mâle JIC / Mâle NPTF X-long			846FS06X06
Male JIC / Male NPTF X-long			846FS06X08	3/8	1/2	
Numéro Part number	A (")	B (")	846FS08X04	1/2	1/4	
848LLFS04X02	1/4	1/8	846FS08X06	1/2	3/8	
848LLFS04X04	1/4	1/4	846FS08X08	1/2	1/2	
848LLFS06X04	3/8	1/4	846FS08X12	1/2	3/4	
848LLFS06X06	3/8	3/8	846FS10X06	5/8	3/8	
848LLFS08X08	1/2	1/2	846FS10X08	5/8	1/2	
848LLFS12X12	3/4	3/4	846FS10X12	5/8	3/4	
			846FS12X08	3/4	1/2	
848BHFS			846FS12X12	3/4	3/4	
			Mâle JIC cloison / Mâle NPTF			846FS12X16
Male JIC bulkhead / Male NPTF			846FS14X12	7/8	3/4	
Numéro Part number	A (")	B (")	Écrou Nut	846FS16X12	1	3/4
848BHFS04X02	1/4	1/8	711FSO4	846FS16X16	1	1
848BHFS04X04	1/4	1/4	711FSO4	846FS20X16	1-1/4	1
848BHFS06X04	3/8	1/4	711FSO6	846FS20X20	1-1/4	1-1/4
848BHFS06X06	3/8	3/8	711FSO6	846FS24X24	1-1/2	1-1/2
848BHFS08X06	1/2	3/8	711FSO8	846FS32X32	2	2
848BHFS08X08	1/2	3/8	711FSO8			
848BHFS08X08	1/2	1/2	711FSO8			
848BHFS10X08	5/8	1/2	711FSO10			
848BHFS12X12	3/4	3/4	711FSO12			
848BHFS16X16	1	1	711FSO16			
848BHFS20X20	1-1/4	1-1/4	711FSO20			
848BHFS24X24	1-1/2	1-1/2	711FSO24			

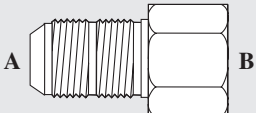
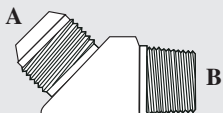
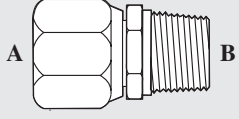
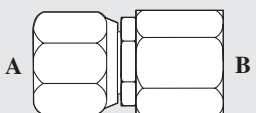
				Numéro Part number	A (")	B (")
847FS				882FS08X06	1/2	3/8
Mâle JIC Cloison / Femelle NPTF				882FS08X08	1/2	1/2
Male JIC bulkhead / Female NPTF				882FS10X08	5/8	1/2
Numéro Part number	A (")	B (")	Écrou Nut	882FS12X12	3/4	3/4
847FS04X02	1/4	1/8	711FSO04	882FS16X16	1	1
847FS04X04	1/4	1/4	711FSO04	882FS20X20	1-1/4	1-1/4
847FS06X04	3/8	1/4	711FSO06			
847FS08X06	1/2	3/8	711FSO08	854FS		
847FS10X08	5/8	1/2	711FSO10	Mâle JIC / Mâle NPTF		
847FS12X12	3/4	3/4	711FSO12	Male JIC / Male NPTF		
847FS16X16	1	1	711FSO16	Numéro Part number	A (")	B (")
				854FS02X02	1/8	1/8
881FS				854FS03X02	3/16	1/8
Femelle JIC tournant / Mâle NPTF				854FS04X02	1/4	1/8
Female JIC swivel / Male NPTF				854FS04X04	1/4	1/4
Numéro Part number	A (")	B (")		854FS04X06	1/4	3/8
881FS04X02	1/4	1/8		854FS05X02	5/16	1/8
881FS04X04	1/4	1/4		854FS05X04	5/16	1/4
881FS05X04	5/16	1/4		854FS06X02	3/8	1/8
881FS06X04	3/8	1/4		854FS06X04	3/8	1/4
881FS06X06	3/8	3/8		854FS06X06	3/8	3/8
881FS08X06	1/2	3/8		854FS06X08	3/8	1/2
881FS08X08	1/2	1/2		854FS08X04	1/2	1/4
881FS10X06	5/8	3/8		854FS08X06	1/2	3/8
881FS10X08	5/8	1/2		854FS08X08	1/2	1/2
881FS10X08	5/8	1/2		854FS08X12	1/2	3/4
881FS12X08	3/4	1/2		854FS10X06	5/8	3/8
881FS12X12	3/4	3/4		854FS10X08	5/8	1/2
881FS16X12	1	3/4		854FS10X12	5/8	3/4
881FS16X16	1	1		854FS12X08	3/4	1/2
881FS20X20	1-1/4	1-1/4		854FS12X12	3/4	3/4
				854FS12X16	3/4	1
882FS				854FS14X12	7/8	3/4
Femelle JIC tournant / Femelle NPTF				854FS16X08	1	1/2
Female JIC swivel / Female NPTF				854FS16X12	1	3/4
Numéro Part number	A (")	B (")		854FS16X16	1	1
882FS04X02	1/4	1/8		854FS16X20	1	1-1/4
882FS04X04	1/4	1/4		854FS20X16	1-1/4	1
882FS06X04	3/8	1/4		854FS20X20	1-1/4	1-1/4
882FS06X06	3/8	3/8		854FS24X24	1-1/2	1-1/2
882FS06X08	3/8	1/2		854FS32X32	2	2

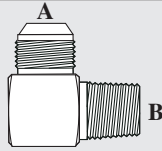
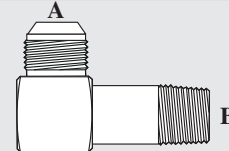
849FS
Mâle JIC / Mâle NPTF
Male JIC / Male NPTF

849LFS
Mâle JIC / Mâle NPTF long
Male JIC / Male NPTF long

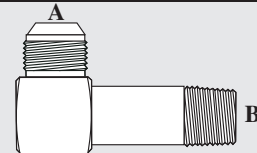
Numéro Part number	A (")	B (")	Numéro Part number	A (")	B (")
849FS02X02	1/8	1/8	849LFS04X02	1/4	1/8
849FS03X02	3/16	1/8	849LFS04X04	1/4	1/4
849FS04X02	1/4	1/8	849LFS05X02	5/16	1/8
849FS04X04	1/4	1/4	849LFS05X04	5/16	1/4
849FS04X06	1/4	3/8	849LFS06X04	3/8	1/4
849FS04X08	1/4	1/2	849LFS06X06	3/8	3/8
849SF05X02	5/16	1/8	849LFS08X06	1/2	3/8
849FS05X04	5/16	1/4	849LFS08X08	1/2	1/2
849FS05X06	5/16	3/8	849LFS10X08	5/8	1/2
849FS06X02	3/8	1/8	849LFS12X12	3/4	3/4
849FS06X04	3/8	1/4	849LFS16X12	1	3/4
849FS06X06	3/8	3/8	849LFS16X16	1	1
849FS06X08	3/8	1/2	849LFS20X20	1-1/4	1-1/4
849FS06X12	3/8	3/4			
849FS08X04	1/2	1/4			
849FS08X06	1/2	3/8			
849FS08X08	1/2	1/2			
849FS08X12	1/2	3/4			
849FS08X16	1/2	1			
849FS10X06	5/8	3/8			
849FS10X08	5/8	1/2			
849FS10X12	5/8	3/4			
849FS12X06	3/4	3/8			
849FS12X08	3/4	1/2			
849FS12X12	3/4	3/4			
849FS12X16	3/4	1			
849FS12X20	3/4	1-1/4			
849FS14X12	7/8	3/4			
849FS16X08	1	1/2			
849FS16X12	1	3/4			
849FS16X16	1	1			
849FS16X20	1	1-1/4			
849FS16X24	1	1-1/2			
849FS20X12	1-1/4	3/4			
849FS20X16	1-1/4	1			
849FS20X20	1-1/4	1-1/4			
849FS20X24	1-1/4	1-1/2			
849FS24X16	1-1/2	1			
849FS24X20	1-1/2	1-1/4			
849FS24X24	1-1/2	1-1/2			
849FS32X24	2	1-1/2			
849FS32X32	2	2			

849LLFS
Mâle JIC / Mâle NPTF X-long
Male JIC / Male NPTF X-long

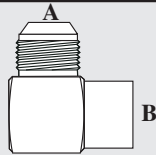
Numéro Part number	A (")	B (")
849LLFS04X02	1/4	1/8
849LLFS04X04	1/4	1/4
849LLFS05X02	5/16	1/8
849LLFS05X04	5/16	1/4
849LLFS06X04	3/8	1/4
849LLFS06X06	3/8	3/8
849LLFS08X06	1/2	3/8
849LLFS08X08	1/2	1/2
849LLFS10X08	5/8	1/2
849LLFS12X08	3/4	1/2
849LLFS12X12	3/4	3/4
849LLFS16X12	1	3/4
849LLFS16X16	1	1
849LLFS20X20	1-1/4	1-1/4

850FS
Mâle JIC / Femelle NPTF
Male JIC / Female NPTF

Numéro Part number	A (")	B (")
850FS04X02	1/4	1/8
850FS04X04	1/4	1/4
850FS04X06	1/4	3/8
850FS04X08	1/4	1/2
850FS05X02	5/16	1/8
850FS05X04	5/16	1/4
850FS06X02	3/8	1/8
850FS06X04	3/8	1/4
850FS06X06	3/8	3/8
850FS06X08	3/8	1/2
850FS08X04	1/2	1/4
850FS08X06	1/2	3/8
850FS08X08	1/2	1/2
850FS10X08	5/8	1/2
850FS10X12	5/8	3/4
850FS12X08	3/4	1/2
850FS12X12	3/4	3/4
850FS12X16	3/4	1
850FS14X12	7/8	3/4
850FS16X16	1	1
850FS20X20	1-1/4	1-1/4
850FS24X24	1-1/2	1-1/2
850FS32X32	2	2

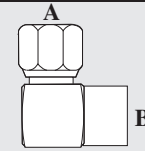
877FS
Femelle JIC tournant / Femelle NPTF
Female JIC swivel / Female NPTF

Numéro Part number	A (")	B (")
877FS04X04	1/4	1/4
877FS06X04	3/8	1/4
877FS06X06	3/8	3/8
877FS08X06	1/2	3/8
877FS10X08	5/8	1/2
877FS12X12	3/4	3/4

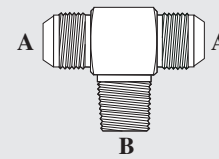
845FS
Mâle JIC / Mâle NPTF / Mâle JIC
Male JIC / Male NPTF / Male JIC

Numéro Part number	A (")	B (")
845FS04X02	1/4	1/8
845FS04X04	1/4	1/4
845FS04X06	1/4	3/8
845FS05X02	5/16	1/8
845FS05X04	5/16	1/4
845FS06X04	3/8	1/4
845FS06X06	3/8	3/8
845FS06X08	3/8	1/2
845FS08X06	1/2	3/8
845FS08X08	1/2	1/2
845FS10X06	5/8	3/8
845FS10X08	5/8	1/2
845FS10X12	5/8	3/4
845FS12X12	3/4	3/4
845FS16X12	1	3/4
845FS16X16	1	1
845FS20X20	1-1/4	1-1/4
845FS24X24	1-1/2	1-1/2
845FS32X32	2	2

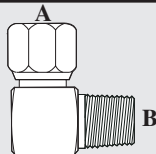

878FS
Femelle JIC tournant / Mâle NPTF
Female JIC swivel / Male NPTF

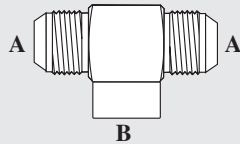
Numéro Part number	A (")	B (")
878FS04X02	1/4	1/8
878FS04X04	1/4	1/4
878FS06X04	3/8	1/4
878FS06X06	3/8	3/8
878FS06X08	3/8	1/2
878FS08X06	1/2	3/8
878FS08X08	1/2	1/2
878FS10X08	5/8	1/2
878FS12X12	3/4	3/4
878FS16X16	1	1
878FS20X20	1-1/4	1-1/4

858FS

 Mâle JIC / Femelle NPTF / Mâle JIC
 Male JIC / Female NPTF / Male JIC

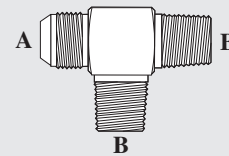
Numéro Part number	A (")	B (")
858FS02X02	1/8	1/8
858FS04X02	1/4	1/8
858FS04X04	1/4	1/4
858FS05X02	5/16	1/8
858FS06X04	3/8	1/4
858FS06X06	3/8	3/8
858FS08X06	1/2	3/8
858FS08X08	1/2	1/2
858FS10X08	5/8	1/2
858FS12X08	3/4	1/2
858FS12X12	3/4	3/4
858FS14X12	7/8	3/4
858FS16X16	1	1
858FS20X20	1-1/4	1-1/4
858FS24X24	1-1/2	1-1/2
858FS32X32	2	2

853FS

 Mâle JIC / Mâle NPTF / Mâle NPTF
 Male JIC / Male NPTF / Male NPTF

Numéro Part number	A (")	B (")
853FS04X02	1/4	1/8
853FS06X04	3/8	1/4
853FS08X06	1/2	3/8
853FS10X08	5/8	1/2
853FS12X12	3/4	3/4

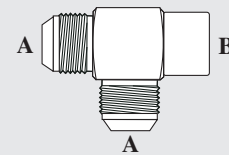
857FS

 Mâle JIC / Mâle JIC / Femelle NPTF
 Male JIC / Male JIC / Female NPTF

Numéro Part number	A (")	B (")
857FS04X02	1/4	1/8
857FS04X04	1/4	1/4
857FS06X04	3/8	1/4
857FS06X06	3/8	3/8
857FS08X06	1/2	3/8
857FS08X08	1/2	1/2
857FS10X08	5/8	1/2
857FS12X12	3/4	3/4
857FS16X16	1	1

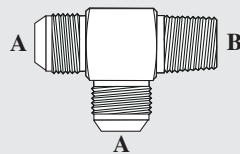
851FS

 Mâle JIC / Mâle JIC / Mâle NPTF
 Male JIC / Male JIC / Male NPTF

Numéro Part number	A (")	B (")
851FS04X02	1/4	1/8
851FS04X04	1/4	1/4
851FS05X02	5/16	1/8
851FS05X04	5/16	1/4
851FS06X04	3/8	1/4
851FS06X06	3/8	3/8
851FS08X06	1/2	3/8
851FS08X08	1/2	1/2
851FS08X12	1/2	3/4
851FS10X08	5/8	1/2
851FS10X12	5/8	3/4
851FS12X08	3/4	1/2
851FS12X12	3/4	3/4
851FS14X12	7/8	3/4
851FS16X16	1	1
851FS20X20	1-1/4	1-1/4
851FS24X24	1-1/2	1-1/2

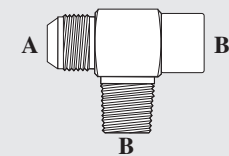
860FS

 Mâle JIC / Mâle NPTF / Femelle NPTF
 Male JIC / Male NPTF / Female NPTF

Numéro Part number	A (")	B (")
860FS04X02	1/4	1/8
860FS06X04	3/8	1/4
860FS08X06	1/2	3/8
860FS10X08	5/8	1/2
860FS12X12	3/4	3/4
860FS16X16	1	1
860FS20X20	1-1/4	1-1/4

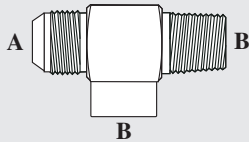

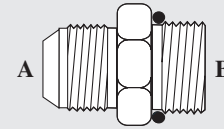
859FS

 Mâle JIC / Femelle NPTF / Mâle NPTF
 Male JIC / Female NPTF / Male NPTF

848FSO

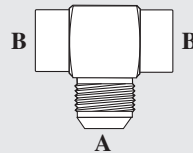
 Mâle JIC / Mâle o'ring boss
 Male JIC / Male o'ring boss

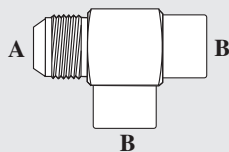
Numéro Part number	A (")	B (")	Numéro Part number	A (")	B (")	O'ring
859FS04X02	1/4	1/8	848FSO02X02	1/8	1/8	710FSO02
859FS06X04	3/8	1/4	848FSO03X03	3/16	3/16	710FSO03
859FS06X06	3/8	3/8	848FSO04X03	1/4	3/16	710FSO03
859FS08X06	1/2	3/8	848FSO04X04	1/4	1/4	710FSO04
859FS10X08	5/8	1/2	848FSO04X05	1/4	5/16	710FSO05
859FS12X12	3/4	3/4	848FSO04X06	1/4	3/8	710FSO06
859FS16X16	1	1	848FSO04X08	1/4	1/2	710FSO08
859FS20X20	1-1/4	1-1/4	848FSO05X04	5/16	1/4	710FSO04
859FS24X24	1-1/2	1-1/2	848FSO05X05	5/16	5/16	710FSO05
			848FSO05X06	5/16	3/8	710FSO06
			848FSO05X08	5/16	1/2	710FSO08
			848FSO05X10	5/16	5/8	710FSO10
			848FSO06X04	3/8	1/4	710FSO04
			848FSO06X05	3/8	5/16	710FSO05
			848FSO06X06	3/8	3/8	710FSO06
			848FSO06X08	3/8	1/2	710FSO08
			848FSO06X10	3/8	5/8	710FSO10
			848FSO06X12	3/8	3/4	710FSO12
			848FSO08X04	1/2	1/4	710FSO04
			848FSO08X05	1/2	5/16	710FSO05
			848FSO08X06	1/2	3/8	710FSO06
			848FSO08X08	1/2	1/2	710FSO08
			848FSO08X10	1/2	5/8	710FSO10
			848FSO08X12	1/2	3/4	710FSO12
			848FSO08X16	1/2	1	710FSO16
			848FSO10X04	5/8	1/4	710FSO04
			848FSO10X06	5/8	3/8	710FSO06
			848FSO10X08	5/8	1/2	710FSO08
			848FSO10X10	5/8	5/8	710FSO10
			848FSO10X12	5/8	3/4	710FSO12
			848FSO10X16	5/8	1	710FSO16
			848FSO12X08	3/4	1/2	710FSO08
			848FSO12X10	3/4	5/8	710FSO10
			848FSO12X12	3/4	3/4	710FSO12
			848FSO12X14	3/4	7/8	710FSO14
			848FSO12X16	3/4	1	710FSO16
			848FSO12X20	3/4	1-1/4	710FSO20
			848FSO14X12	7/8	3/4	710FSO12
			848FSO14X14	7/8	7/8	710FSO14
			848FSO14X16	7/8	1	710FSO16
			848FSO16X06	1	3/8	710FSO06
			848FSO16X08	1	1/2	710FSO08
			848FSO16X10	1	5/8	710FSO10
			848FSO16X12	1	3/4	710FSO12
			848FSO16X14	1	7/8	710FSO14
			848FSO16X16	1	1	710FSO16

862FS

 Femelle NPTF / Mâle JIC / Femelle NPTF
 Female NPTF / Male JIC / Female NPTF

863FS

 Mâle JIC / Femelle NPTF / Femelle NPTF
 Male JIC / Female NPTF / Female NPTF

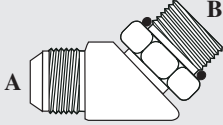
Numéro Part number	A (")	B (")	O'ring
848FSO16X20	1	1-1/4	710FSO20
848FSO16X24	1	1-1/2	710FSO24
848FSO20X12	1-1/4	3/4	710FSO12
848FSO20X16	1-1/4	1	710FSO16
848FSO20X20	1-1/4	1-1/4	710FSO20
848FSO20X24	1-1/4	1-1/2	710FSO24
848FSO24X16	1-1/2	1	710FSO16
848FSO24X20	1-1/2	1-1/4	710FSO20
848FSO24X24	1-1/2	1-1/2	710FSO24
848FSO24X32	1-1/2	2	710FSO32
848FSO32X32	2	2	710FSO32

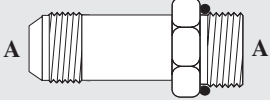

854FSO Mâle JIC / Mâle o'ring boss Male JIC / Male o'ring boss			
Numéro Part number	A (")	B (")	O'ring
854FSO02X02	1/8	1/8	710FSO02
854FSO04X04	1/4	1/4	710FSO04
854FSO04X06	1/4	3/8	710FSO06
854FSO05X05	5/16	5/16	710FSO05
854FSO05X06	5/16	3/8	710FSO06
854FSO06X04	3/8	1/4	710FSO04
854FSO06X05	3/8	5/16	710FSO05
854FSO06X06	3/8	3/8	710FSO06
854FSO06X08	3/8	1/2	710FSO08
854FSO08X06	1/2	3/8	710FSO06
854FSO08X08	1/2	1/2	710FSO08
854FSO08X10	1/2	5/8	710FSO10
854FSO08X12	1/2	3/4	710FSO12
854FSO10X08	5/8	1/2	710FSO08
854FSO10X10	5/8	5/8	710FSO10
854FSO10X12	5/8	3/4	710FSO12
854FSO12X08	3/4	1/2	710FSO08
854FSO12X10	3/4	5/8	710FSO10
854FSO12X12	3/4	3/4	710FSO12
854FSO12X16	3/4	1	710FSO16
854FSO14X14	7/8	7/8	710FSO14
854FSO16X12	1	3/4	710FSO12
854FSO16X16	1	1	710FSO16
854FSO16X20	1	1-1/4	710FSO20
854FSO20X16	1-1/4	1	710FSO16
854FSO20X20	1-1/4	1-1/4	710FSO20
854FSO24X24	1-1/2	1-1/2	710FSO24



848LFSO Mâle JIC / Mâle o'ring boss long Male JIC / Male o'ring boss long		
Numéro Part number	A (")	O'ring
848LFSO04	1/4	710FSO04
848LFSO06	3/8	710FSO06
848LFSO08	1/2	710FSO08
848LFSO10	5/8	710FSO10
848LFSO12	3/4	710FSO12
848LFSO16	1	710FSO16

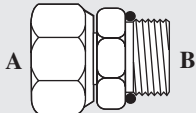

881FSO Femelle JIC tournant / Mâle o'ring boss Female JIC swivel / Male o'ring boss			
Numéro Part number	A (")	B (")	O'ring
881FSO04X04	1/4	1/4	710FSO04
881FSO06X06	3/8	3/8	710FSO06
881FSO06X08	3/8	1/2	710FSO08
881FSO08X06	1/2	3/8	710FSO06
881FSO08X08	1/2	1/2	710FSO08
881FSO10X10	5/8	5/8	710FSO10
881FSO12X12	3/4	3/4	710FSO12
881FSO16X16	1	1	710FSO16
881FSO20X20	1-1/4	1-1/4	710FSO20

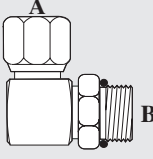

878FSO Femelle JIC tournant / Mâle o'ring boss Female JIC swivel / Male o'ring boss			
Numéro Part number	A (")	B (")	O'ring
878FSO06X06	3/8	3/8	710FSO06
878FSO08X08	1/2	1/2	710FSO08
878FSO10X10	5/8	5/8	710FSO10
878FSO12X12	3/4	3/4	710FSO12
878FSO16X16	1	1	710FSO16

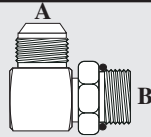
849FSO
Mâle JIC / Mâle o'ring boss
Male JIC / Male o'ring boss

Numéro Part number	A (")	B (")	O'ring
849FSO04X02	1/4	1/8	710FSO02
849FSO04X04	1/4	1/4	710FSO04
849FSO04X05	1/4	5/16	710FSO05
849FSO04X06	1/4	3/8	710FSO06
849FSO04X08	1/4	1/2	710FSO08
849FSO05X04	5/16	1/4	710FSO04
849FSO05X05	5/16	5/16	710FSO05
849FSO05X06	5/16	3/8	710FSO06
849FSO05X08	5/16	1/2	710FSO08
849FSO06X04	3/8	1/4	710FSO04
849FSO06X05	3/8	5/16	710FSO05
849FSO06X06	3/8	3/8	710FSO06
849FSO06X08	3/8	1/2	710FSO08
849FSO06X10	3/8	5/8	710FSO10
849FSO06X12	3/8	3/4	710FSO12
849FSO08X04	1/2	1/4	710FSO04
849FSO08X06	1/2	3/8	710FSO06
849FSO08X08	1/2	1/2	710FSO08
849FSO08X10	1/2	5/8	710FSO10
849FSO08X12	1/2	3/4	710FSO12
849FSO08X16	1/2	1	710FSO16
849FSO10X06	5/8	3/8	710FSO06
849FSO10X08	5/8	1/2	710FSO08
849FSO10X10	5/8	5/8	710FSO10
849FSO10X12	5/8	3/4	710FSO12
849FSO12X06	3/4	3/8	710FSO06
849FSO12X08	3/4	1/2	710FSO08
849FSO12X10	3/4	5/8	710FSO10
849FSO12X12	3/4	3/4	710FSO12
849FSO12X16	3/4	1	710FSO16
849FSO12X20	3/4	1-1/4	710FSO20
849FSO14X14	7/8	7/8	710FSO14
849FSO14X16	7/8	1	710FSO16
849FSO16X08	1	1/2	710FSO08
849FSO16X10	1	5/8	710FSO10
849FSO16X12	1	3/4	710FSO12
849FSO16X14	1	7/8	710FSO14
849FSO16X16	1	1	710FSO16
849FSO16X20	1	1-1/4	710FSO20
849FSO20X12	1-1/4	3/4	710FSO12
849FSO20X16	1-1/4	1	710FSO16
849FSO20X20	1-1/4	1-1/4	710FSO20
849FSO20X24	1-1/4	1-1/2	710FSO24
849FSO24X20	1-1/2	1-1/4	710FSO20
849FSO24X24	1-1/2	1-1/2	710FSO24
849FSO32X32	2	2	710FSO32

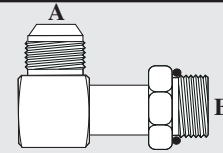
849LFSO
Mâle JIC / Mâle o'ring boss long
Male JIC / Male o'ring boss long

Numéro Part number	A (")	B (")	O'ring
849LFSO04X04	1/4	1/4	710FSO04
849LFSO06X06	3/8	3/8	710FSO06
849LFSO08X08	1/2	1/2	710FSO08
849LFSO10X10	5/8	5/8	710FSO10
849LFSO12X12	3/4	3/4	710FSO12
849LFSO16X16	1	1	710FSO16
849LFSO20X20	1-1/4	1-1/4	710FSO20

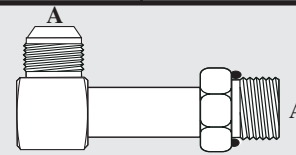
849LLFSO
Mâle JIC / Mâle o'ring boss X-long
Male JIC / Male o'ring boss X-long

Numéro Part number	A (")	O'ring
849LLFSO04	1/4	710FSO04
849LLFSO06	3/8	710FSO06
849LLFSO08	1/2	710FSO08
849LLFSO10	5/8	710FSO10
849LLFSO12	3/4	710FSO12
849LLFSO16	1	710FSO16
849LLFSO20	1-1/4	710FSO20

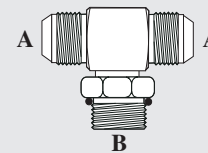

845FSO
Mâle JIC / Mâle o'ring boss / Mâle JIC
Male JIC / Male o'ring boss / Male JIC

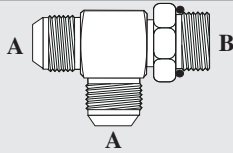
Numéro Part number	A (")	B (")	O'ring
845FSO04X04	1/4	1/4	710FSO04
845FSO05X05	5/16	5/16	710FSO05
845FSO06X06	3/8	3/8	710FSO06
845FSO08X08	1/2	1/2	710FSO08
845FSO10X08	5/8	1/2	710FSO08
845FSO10X10	5/8	5/8	710FSO10
845FSO12X08	3/4	1/2	710FSO08
845FSO12X12	3/4	3/4	710FSO12
845FSO14X14	7/8	7/8	710FSO14
845FSO16X16	1	1	710FSO16
845FSO20X20	1-1/4	1-1/4	710FSO20
845FSO24X24	1-1/2	1-1/2	710FSO24

851FSO

Mâle JIC / Mâle JIC / Mâle o'ring boss
 Male JIC / Male JIC / Male o'ring boss

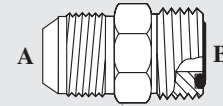
Numéro Part number	A (")	B (")	O'ring
851FSO04X04	1/4	1/4	710FSO04
851FSO05X05	5/16	5/16	710FSO05
851FSO06X04	3/8	1/4	710FSO04
851FSO06X06	3/8	3/8	710FSO06
851FSO08X08	1/2	1/2	710FSO08
851FSO10X10	5/8	5/8	710FSO10
851FSO12X12	3/4	3/4	710FSO12
851FSO14X14	7/8	7/8	710FSO14
851FSO16X16	1	1	710FSO16
851FSO20X20	1-1/4	1-1/4	710FSO20
851FSO24X24	1-1/2	1-1/2	710FSO24

848TTJ

Mâle JIC / Mâle o'ring face
 Male JIC / Male o'ring face

Numéro Part number	A (")	B (")	O'ring
848TTJ04X04	1/4	1/4	710TTO04
848TTJ06X06	3/8	3/8	710TTO06
848TTJ08X08	1/2	1/2	710TTO08
848TTJ10X10	5/8	5/8	710TTO10
848TTJ12X12	3/4	3/4	710TTO12
848TTJ16X16	1	1	710TTO16

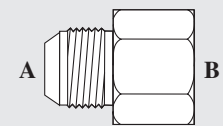
846TTJ

Mâle JIC / Femelle o'ring face fixe
 Male JIC / Female o'ring face solid

Numéro Part number	A (")	B (")
846TTJ04X04	1/4	1/4
846TTJ06X04	3/8	1/4
846TTJ06X06	3/8	3/8
846TTJ08X06	1/2	3/8
846TTJ08X08	1/2	1/2
846TTJ10X08	5/8	1/2
846TTJ10X10	5/8	5/8
846TTJ10X12	5/8	3/4
846TTJ12X12	3/4	3/4
846TTJ12X16	3/4	1
846TTJ16X16	1	1
846TTJ20X20	1-1/4	1-1/4

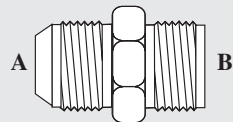
848FSV

Mâle JIC / Mâle cône inversé
 Male JIC / Male inverted flare

Numéro Part number	A (")	B (")
848FSV03X04	3/16	1/4
848FSV04X03	1/4	3/16
848FSV04X04	1/4	1/4
848FSV04X05	1/4	5/16
848FSV06X04	3/8	1/4
848FSV06X05	3/8	5/16
848FSV08X06	1/2	3/8

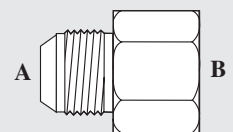
846FSV

Mâle JIC / Femelle cône inversé
 Male JIC / Female inverted flare

Numéro Part number	A (")	B (")
846FSV04X03	1/4	3/16
846FSV04X04	1/4	1/4
846FSV06X06	3/8	3/8

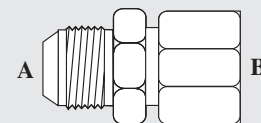

846TTJSW

Mâle JIC / Femelle o'ring face tournant
 Male JIC / Female o'ring face swivel

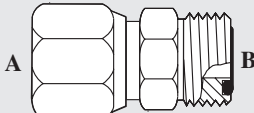
Numéro Part number	A (")	B (")
846TTJSW0404	1/4	1/4
846TTJSW0606	3/8	3/8
846TTJSW0808	1/2	1/2
846TTJSW1010	5/8	5/8
846TTJSW1212	3/4	3/4
846TTJSW1616	1	1

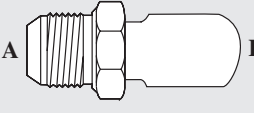
 881TTJ Femelle JIC tournant / Mâle o'ring face Female JIC swivel / Male o'ring face				Numéro Part number	A (")	B (")	Joint d'étanchéité Bonded seal
				848FSB05X04	5/16	1/4	710BSB04
				848FSB05X06	5/16	3/8	710BSB06
				848FSB05X08	5/16	1/2	710BSB08
				848FSB06X02	3/8	1/8	710BSB02
				848FSB06X04	3/8	1/4	710BSB04
				848FSB06X06	3/8	3/8	710BSB06
				848FSB06X08	3/8	1/2	710BSB08
				848FSB06X10	3/8	5/8	710BSB10
				848FSB08X04	1/2	1/4	710BSB04
				848FSB08X06	1/2	3/8	710BSB06
				848FSB08X08	1/2	1/2	710BSB08
				848FSB08X10	1/2	5/8	710BSB10
				848FSB08X12	1/2	3/4	710BSB12
				848FSB08X16	1/2	1	710BSB16
				848FSB10X04	5/8	1/4	710BSB04
				848FSB10X06	5/8	3/8	710BSB06
				848FSB10X08	5/8	1/2	710BSB08
				848FSB10X10	5/8	5/8	710BSB10
				848FSB10X12	5/8	3/4	710BSB12
				848FSB12X06	3/4	3/8	710BSB06
				848FSB12X08	3/4	1/2	710BSB08
				848FSB12X10	3/4	5/8	710BSB10
				848FSB12X12	3/4	3/4	710BSB12
				848FSB12X16	3/4	1	710BSB16
				848FSB12X20	3/4	1-1/4	710BSB20
				848FSB14X16	7/8	1	710BSB16
				848FSB16X08	1	1/2	710BSB08
				848FSB16X12	1	3/4	710BSB12
				848FSB16X16	1	1	710BSB16
				848FSB16X20	1	1-1/4	710BSB20
				848FSB16X24	1	1-1/2	710BSB24
				848FSB20X12	1-1/4	3/4	710BSB12
				848FSB20X16	1-1/4	1	710BSB16
				848FSB20X20	1-1/4	1-1/4	710BSB20
				848FSB20X24	1-1/4	1-1/2	710BSB24
				848FSB20X32	1-1/4	2	710BSB32
				848FSB24X20	1-1/2	1-1/4	710BSB20
				848FSB24X24	1-1/2	1-1/2	710BSB24
				848FSB24X32	1-1/2	2	710BSB32
				848FSB32X32	2	2	710BSB32

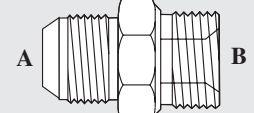
 848FSBJ Mâle JIC / Banjo Male JIC / Banjo				
Numéro Part number	A (")	B	Boulon Bolt	Rondelle Copper washer
848FSBJ04X04	1/4	1/4BSPP	BJ04	712BSP04
848FSBJ04X06	1/4	3/8BSPP	BJ06	712BSP06
848FSBJ04X08	1/4	8 mm	BJM08	712MET08
848FSBJ04X10	1/4	10 mm	BJM10	712MET10
848FSBJ04X12	1/4	12 mm	BJM12	712MET12
848FSBJ04X14	1/4	14 mm	BJM14	712MET14
848FSBJ06X04	3/8	1/4BSPP	BJ04	712BSP04
848FSBJ06X06	3/8	3/8BSPP	BJ06	712BSP06
848FSBJ06X12	3/8	12 mm	BJM12	712MET12
848FSBJ06X14	3/8	14 mm	BJM14	712MET14
848FSBJ08X08	1/2	1/2BSPP	BJ08	712BSP08
848FSBJ08X14	1/2	14 mm	BJM14	712MET14
848FSBJ08X16	1/2	16 mm	BJM16	712MET16
848FSBJ10X10	5/8	5/8BSPP	BJ10	712BSP10
848FSBJ12X12	3/4	3/4BSPP	BJ12	712BSP12

 848FSB Mâle JIC / Mâle BSPP Male JIC / Male BSPP			
Numéro Part number	A (")	B (")	Joint d'étanchéité Bonded seal
848FSB04X02	1/4	1/8	710BSB02
848FSB04X04	1/4	1/4	710BSB04
848FSB04X06	1/4	3/8	710BSB06
848FSB04X08	1/4	1/2	710BSB08
848FSB05X02	5/16	1/8	710BSB02

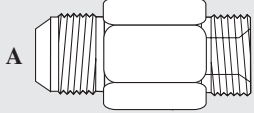
 848FSBL Mâle JIC / Mâle BSPP long Male JIC / Male BSPP long			
Numéro Part number	A (")	B (")	Joint d'étanchéité Bonded seal
848FSBL04X04	1/4	1/4	710BSB04
848FSBL06X04	3/8	1/4	710BSB04
848FSBL06X06	3/8	3/8	710BSB06
848FSBL08X06	1/2	3/8	710BSB06
848FSBL10X08	5/8	1/2	710BSB08

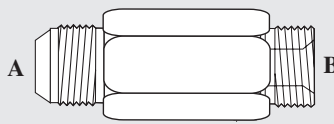
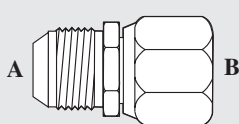
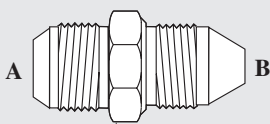
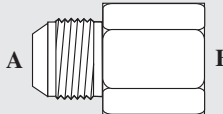
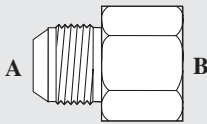
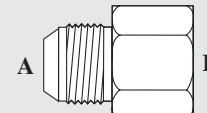
										
848FSBLL Mâle JIC / Mâle BSPP X-long Male JIC / Male BSPP X-long				846FSBSW Mâle JIC / Femelle BSPP tournant Male JIC /Female BSPP swivel						
Numéro Part number	A (")	B (")	Joint d'étanchéité Bonded seal	Numéro Part number	A (")	B (")				
848FSBLL0404	1/4	1/4	710BSB04	846FSBSW0404	1/4	1/4				
848FSBLL0604	3/8	1/4	710BSB04	846FSBSW0406	1/4	3/8				
848FSBLL0606	3/8	3/8	710BSB06	846FSBSW0606	3/8	3/8				
848FSBLL0608	3/8	1/2	710BSB08	846FSBSW0608	3/8	1/2				
848FSBLL0806	1/2	3/8	710BSB06	846FSBSW0806	1/2	3/8				
848FSBLL0808	1/2	1/2	710BSB08	846FSBSW0808	1/2	1/2				
848FSBLL1208	3/4	1/2	710BSB08	846FSBSW0812	1/2	3/4				
848FSBLL1210	3/4	5/8	710BSB10	846FSBSW1008	5/8	1/2				
848FSBLL1212	3/4	3/4	710BSB12	846FSBSW1212	3/4	3/4				
				846FSBSW1216			3/4	1		
				846FSBSW1616			1	1		
				846FSBSW2020			1-1/4	1-1/4		
				846FSBSW2424			1-1/2	1-1/2		
				846FSBSW3232			2	2		
								846FSJ Mâle JIC / Femelle JIS Male JIC /Female JIS		
				Numéro Part number	A (")	B (")	Numéro Part number	A (")	B (")	
				848FSJ04X02	1/4	1/8	846FSJ04X02	1/4	1/8	
				848FSJ04X04	1/4	1/4	846FSJ04X04	1/4	1/4	
				848FSJ06X06	3/8	3/8	846FSJ06X06	3/8	3/8	
848FSJ08X08	1/2	1/2	846FSJ08X08	1/2	1/2					
				846FSJ12X12			3/4	3/4		
				846FSB Mâle JIC / Femelle BSPP fixe Male JIC /Female BSPP solid						
				Numéro Part number	A (")	B (")	Numéro Part number	A (")	B (")	
				846FSB04X04	1/4	1/4	846FSH06X06	3/8	3/8	
				846FSB06X04	3/8	1/4	846FSH06X08	3/8	1/2	
				846FSB06X06	3/8	3/8	846FSH08X08	1/2	1/2	
846FSB08X06	1/2	3/8	846FSH08X10	1/2	5/8					
846FSB08X08	1/2	1/2	846FSH08X12	1/2	3/4					
846FSB12X12	3/4	3/4	846FSH10X08	5/8	1/2					
846FSB16X16	1	1	846FSH10X12	5/8	3/4					
846FSB20X20	1-1/4	1-1/4	846FSH12X12	3/4	3/4					
846FSB24X24	1-1/2	1-1/2								

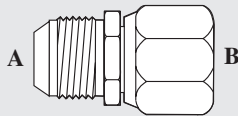
846FHSW
Mâle JIC / Femelle BSPP plat tournant
Male JIC / Female BSPP flat face swivel

Numéro Part number	A (")	B (")
846FHSW0608	3/8	1/2
846FHSW0808	1/2	1/2
846FHSW0812	1/2	3/4
846FHSW1212	3/4	3/4

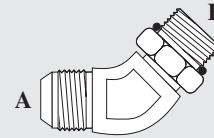
854FSB
Mâle JIC / Mâle BSPP ajustable
Male JIC / Male BSPP adjustable

Numéro Part number	A (")	B (")	Joint d'étanchéité Bonded seal
854FSB04X04	1/4	1/4	710BSB04
854FSB06X04	3/8	1/4	710BSB04
854FSB06X06	3/8	3/8	710BSB06
854FSB06X08	3/8	1/2	710BSB08
854FSB08X06	1/2	3/8	710BSB06
854FSB08X08	1/2	1/2	710BSB08
854FSB12X12	3/4	3/4	710BSB12
854FSB16X16	1	1	710BSB16

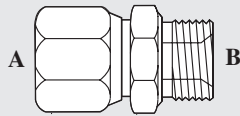
881FSB
Femelle JIC tournant / Mâle BSPP
Female JIC swivel / Male BSPP

Numéro Part number	A (")	B (")	Joint d'étanchéité Bonded seal
881FSB04X02	1/4	1/8	710BSB02
881FSB04X04	1/4	1/4	710BSB04
881FSB04X06	1/4	3/8	710BSB06
881FSB06X04	3/8	1/4	710BSB04
881FSB06X06	3/8	3/8	710BSB06
881FSB06X08	3/8	1/2	710BSB08
881FSB08X06	1/2	3/8	710BSB06
881FSB08X08	1/2	1/2	710BSB08
881FSB10X08	5/8	1/2	710BSB08
881FSB10X10	5/8	5/8	710BSB10
881FSB12X12	3/4	3/4	710BSB12
881FSB16X16	1	1	710BSB16
881FSB20X20	1-1/4	1-1/4	710BSB20
881FSB24X24	1-1/2	1-1/2	710BSB24
881FSB32X32	2	2	710BSB32

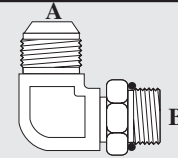
849FSB
Mâle JIC / Mâle BSPP ajustable
Male JIC / Male BSPP adjustable

Numéro Part number	A (")	B (")	Joint d'étanchéité Bonded seal
849FSB04X02	1/4	1/8	710BSB02
849FSB04X04	1/4	1/4	710BSB04
849FSB06X04	3/8	1/4	710BSB04
849FSB06X06	3/8	3/8	710BSB06
849FSB06X08	3/8	1/2	710BSB08
849FSB08X06	1/2	3/8	710BSB06
849FSB08X08	1/2	1/2	710BSB08
849FSB08X12	1/2	3/4	710BSB12
849FSB10X06	5/8	3/8	710BSB06
849FSB10X08	5/8	1/2	710BSB08
849FSB10X12	5/8	3/4	710BSB12
849FSB12X08	3/4	1/2	710BSB08
849FSB12X12	3/4	3/4	710BSB12
849FSB12X16	3/4	1	710BSB16
849FSB16X12	1	3/4	710BSB12
849FSB16X16	1	1	710BSB16

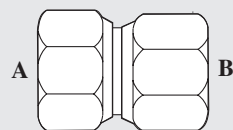
882FSB
Femelle JIC tournant / Femelle BSPP tournant
Female JIC swivel / Female BSPP swivel

Numéro Part number	A (")	B (")
882FSB06X06	3/8	3/8
882FSB06X08	3/8	1/2
882FSB08X06	1/2	3/8
882FSB08X08	1/2	1/2
882FSB12X12	3/4	3/4

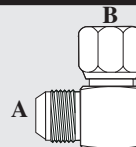
850FSB
Mâle JIC / Femelle BSPP tournant
Male JIC / Female BSPP swivel

Numéro Part number	A (")	B (")
850FSB06X06	3/8	3/8
850FSB08X06	1/2	3/8
850FSB08X08	1/2	1/2
850FSB12X12	3/4	3/4

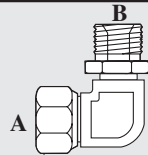
878FSB
Femelle JIC tournant / Mâle BSPP
Female JIC swivel / Male BSPP

Numéro Part number	A (")	B (")	Joint d'étanchéité Bonded seal
878FSB04X04	1/4	1/4	710BSB04
878FSB06X04	3/8	1/4	710BSB04
878FSB06X06	3/8	3/8	710BSB06
878FSB06X08	3/8	1/2	710BSB08
878FSB08X06	1/2	3/8	710BSB06
878FSB08X08	1/2	1/2	710BSB08
878FSB10X08	5/8	1/2	710BSB08
878FSB10X10	5/8	5/8	710BSB10
878FSB12X12	3/4	3/4	710BSB12

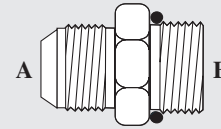
848FSM
Mâle JIC / Mâle métrique (port seulement)
Male JIC / Male metric (port only)

Numéro Part number	A (")	B (mm)	Joint d'étanchéité Bonded seal
848FSM04X10	1/4	M10X1.0	710BSM10
848FSM04X12	1/4	M12X1.5	710BSM12
848FSM04X14	1/4	M14X1.5	710BSM14
848FSM05X12	5/16	M12X1.5	710BSM12
848FSM05X16	5/16	M16X1.5	710BSM16
848FSM06X12	3/8	M12X1.5	710BSM12
848FSM06X14	3/8	M14X1.5	710BSM14
848FSM06X16	3/8	M16X1.5	710BSM16
848FSM08X14	1/2	M14X1.5	710BSM14
848FSM08X16	1/2	M16X1.5	710BSM16
848FSM08X18	1/2	M18X1.5	710BSM18
848FSM08X22	1/2	M22X1.5	710BSM22
848FSM10X18	5/8	M18X1.5	710BSM18
848FSM10X20	5/8	M20X1.5	710BSM20
848FSM10X22	5/8	M22X1.5	710BSM22
848FSM12X22	3/4	M22X1.5	710BSM22
848FSM12X26	3/4	M26X1.5	710BSM26
848FSM12X27	3/4	M27X2.0	710BSM27
848FSM14X26	7/8	M26X1.5	710BSM26
848FSM16X27	1	M27X2.0	710BSM27
848FSM16X33	1	M33X2.0	710BSM33
848FSM20X33	1-1/4	M33X2.0	710BSM33
848FSM20X42	1-1/4	M42X2.0	710BSM42
848FSM24X48	1-1/2	M48X1.5	710BSM48

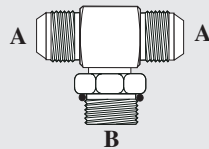

845FSB
Mâle JIC / Mâle BSPP ajustable / Mâle JIC
Male JIC / Male BSPP adjustable / Male JIC

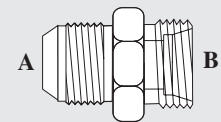
Numéro Part number	A (")	B (")	Joint d'étanchéité Bonded seal
845FSB04X04	1/4	1/4	710BSB04
845FSB05X04	5/16	1/4	710BSB04
845FSB06X04	3/8	1/4	710BSB04
845FSB06X06	3/8	3/8	710BSB06
845FSB08X06	1/2	3/8	710BSB06
845FSB10X08	5/8	1/2	710BSB08
845FSB12X12	3/4	3/4	710BSB12
845FSB16X16	1	1	710BSB16

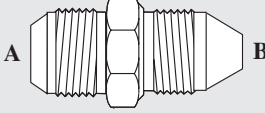
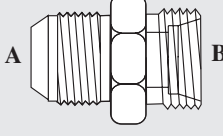
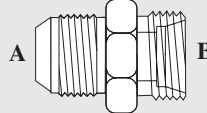
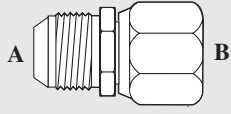

848FSML
Mâle JIC / Mâle métrique (port et tube) série légère
Male JIC / Male metric (port and tube) light
851FSB
Mâle JIC / Mâle JIC / Mâle BSPP ajustable
Male JIC / Male JIC / Male BSPP adjustable

Numéro Part number	A (")	B (")	Joint d'étanchéité Bonded seal
851FSB04X04	1/4	1/4	710BSB04
851FSB05X04	5/16	1/4	710BSB04
851FSB06X04	3/8	1/4	710BSB06
851FSB06X06	3/8	3/8	710BSB08
851FSB08X06	1/2	3/8	710BSB06
851FSB08X08	1/2	1/2	710BSB08
851FSB10X08	5/8	1/2	710BSB08
851FSB12X12	3/4	3/4	710BSB10
851FSB16X16	1	1	710BSB12

Numéro Part number	A (")	B (mm)	Tube mm	Joint d'étanchéité Bonded seal
848FSML4810	1/4	M8X1.0	4	710BSM08
848FSML48125	1/4	M8X1.25	----	710BSM08
848FSML41010	1/4	M10X1.0	6	710BSM10
848FSML41012	1/4	M10X1.25	----	710BSM10
848FSML41015	1/4	M10X1.5	----	710BSM10
848FSML41210	1/4	M12X1.0	8	710BSM12
848FSML41215	1/4	M12X1.5	6	710BSM12
848FSML04X14	1/4	M14X1.5	8	710BSM14
848FSML05X12	5/16	M12X1.5	6	710BSM12
848FSML05X14	5/16	M14X1.5	8	710BSM14
848FSML05X16	5/16	M16X1.5	10	710BSM16
848FSML61210	3/8	M12X1.0	8	710BSM12

Numéro Part number	A (")	B (mm)	Tube mm	Joint d'étanchéité Bonded seal	Numéro Part number	A (")	B (mm)	Tube mm	Joint d'étanchéité Bonded seal																																																																																																														
848FSML61212	3/8	M12X1.25	----	710BSM12	848FSMH16X42	1	M42X2.0	30	710BSM42																																																																																																														
848FSML06X14	3/8	M14X1.5	8	710BSM14	848FSMH20X52	1-1/4	M52X2.0	38	710BSM52																																																																																																														
848FSML06X16	3/8	M16X1.5	10	710BSM16	848FSMH24X52	1-1/2	M52X2.0	38	710BSM52																																																																																																														
848FSML06X18	3/8	M18X1.5	12	710BSM18	 <p>848FSK Mâle JIC / Mâle Komatsu Male JIC / Male Komatsu</p> <table border="1"> <thead> <tr> <th>Numéro Part number</th> <th>A (")</th> <th>B (mm)</th> </tr> </thead> <tbody> <tr> <td>848FSK04X14</td> <td>1/4</td> <td>M14X1.5</td> </tr> <tr> <td>848FSK06X18</td> <td>3/8</td> <td>M18X1.5</td> </tr> <tr> <td>848FSK08X22</td> <td>1/2</td> <td>M22X1.5</td> </tr> <tr> <td>848FSK10X24</td> <td>5/8</td> <td>M24X1.5</td> </tr> <tr> <td>848FSK12X30</td> <td>3/4</td> <td>M30X1.5</td> </tr> <tr> <td>848FSK16X33</td> <td>1</td> <td>M33X1.5</td> </tr> </tbody> </table>					Numéro Part number	A (")	B (mm)	848FSK04X14	1/4	M14X1.5	848FSK06X18	3/8	M18X1.5	848FSK08X22	1/2	M22X1.5	848FSK10X24	5/8	M24X1.5	848FSK12X30	3/4	M30X1.5	848FSK16X33	1	M33X1.5																																																																																									
Numéro Part number	A (")	B (mm)																																																																																																																					
848FSK04X14	1/4	M14X1.5																																																																																																																					
848FSK06X18	3/8	M18X1.5																																																																																																																					
848FSK08X22	1/2	M22X1.5																																																																																																																					
848FSK10X24	5/8	M24X1.5																																																																																																																					
848FSK12X30	3/4	M30X1.5																																																																																																																					
848FSK16X33	1	M33X1.5																																																																																																																					
848FSML08X16	1/2	M16X1.5	10	710BSM16																																																																																																																			
848FSML08X18	1/2	M18X1.5	12	710BSM18																																																																																																																			
848FSML08X22	1/2	M22X1.5	15	710BSM22																																																																																																																			
848FSML10X18	5/8	M18X1.5	12	710BSM18																																																																																																																			
848FSML10X22	5/8	M22X1.5	15	710BSM22																																																																																																																			
848FSML10X26	5/8	M26X1.5	18	710BSM26																																																																																																																			
848FSML12X22	3/4	M22X1.5	15	710BSM22																																																																																																																			
848FSML12X24	3/4	M24X1.5	18	710BSM24																																																																																																																			
848FSML12X26	3/4	M26X1.5	18	710BSM26																																																																																																																			
848FSML12301	3/4	M30X1.5	22	710BSM30																																																																																																																			
848FSML12302	3/4	M30X2.0	22	710BSM30																																																																																																																			
848FSML16X30	1	M30X1.5	22	710BSM30																																																																																																																			
848FSML16X36	1	M36X2.0	28	710BSM36																																																																																																																			
848FSML20X45	1-1/4	M45X2.0	35	710BSM45																																																																																																																			
848FSML20X52	1-1/4	M52X2.0	42	710BSM52																																																																																																																			
848FSML24X45	1-1/2	M45X2.0	----	710BSM45																																																																																																																			
848FSML24X52	1-1/2	52X2.0	42	710BSM52																																																																																																																			
 <p>848FSMH Mâle JIC / Male métrique (port et tube) série lourde Male JIC / Male metric (port and tube) heavy</p> <table border="1"> <thead> <tr> <th>Numéro Part number</th> <th>A (")</th> <th>B (mm)</th> <th>Tube mm</th> <th>Joint d'étanchéité Bonded seal</th> </tr> </thead> <tbody> <tr> <td>848FSMH04X14</td> <td>1/4</td> <td>M14X1.5</td> <td>6</td> <td>710BSM14</td> </tr> <tr> <td>848FSMH04X16</td> <td>1/4</td> <td>M16X1.5</td> <td>8</td> <td>710BSM16</td> </tr> <tr> <td>848FSMH04X18</td> <td>1/4</td> <td>M18X1.5</td> <td>10</td> <td>710BSM18</td> </tr> <tr> <td>848FSMH05X16</td> <td>5/16</td> <td>M16X1.5</td> <td>8</td> <td>710BSM16</td> </tr> <tr> <td>848FSMH05X18</td> <td>5/16</td> <td>M18X1.5</td> <td>10</td> <td>710BSM18</td> </tr> <tr> <td>848FSMH06X16</td> <td>3/8</td> <td>M16X1.5</td> <td>8</td> <td>710BSM16</td> </tr> <tr> <td>848FSMH06X18</td> <td>3/8</td> <td>M18X1.5</td> <td>10</td> <td>710BSM18</td> </tr> <tr> <td>848FSMH06X20</td> <td>3/8</td> <td>M20X1.5</td> <td>12</td> <td>710BSM20</td> </tr> <tr> <td>848FSMH06X22</td> <td>3/8</td> <td>M22X1.5</td> <td>14</td> <td>710BSM22</td> </tr> <tr> <td>848FSMH08X18</td> <td>1/2</td> <td>M18X1.5</td> <td>10</td> <td>710BSM18</td> </tr> <tr> <td>848FSMH08X20</td> <td>1/2</td> <td>M20X1.5</td> <td>12</td> <td>710BSM20</td> </tr> <tr> <td>848FSMH08X22</td> <td>1/2</td> <td>M22X1.5</td> <td>14</td> <td>710BSM22</td> </tr> <tr> <td>848FSMH08X24</td> <td>1/2</td> <td>M24X1.5</td> <td>16</td> <td>710BSM24</td> </tr> <tr> <td>848FSMH10X20</td> <td>5/8</td> <td>M20X1.5</td> <td>12</td> <td>710BSM20</td> </tr> <tr> <td>848FSMH10X24</td> <td>5/8</td> <td>M24X1.5</td> <td>16</td> <td>710BSM24</td> </tr> <tr> <td>848FSMH10X30</td> <td>5/8</td> <td>M30X2.0</td> <td>20</td> <td>710BSM30</td> </tr> <tr> <td>848FSMH10X36</td> <td>5/8</td> <td>M36X2.0</td> <td>25</td> <td>710BSM36</td> </tr> <tr> <td>848FSMH12X24</td> <td>3/4</td> <td>M24X1.5</td> <td>16</td> <td>710BSM24</td> </tr> <tr> <td>848FSMH12X30</td> <td>3/4</td> <td>M30X2.0</td> <td>20</td> <td>710BSM30</td> </tr> <tr> <td>848FSMH12X36</td> <td>3/4</td> <td>M36X2.0</td> <td>25</td> <td>710BSM36</td> </tr> <tr> <td>848FSMH16X30</td> <td>1</td> <td>M30X2.0</td> <td>20</td> <td>710BSM30</td> </tr> <tr> <td>848FSMH16X36</td> <td>1</td> <td>M36X2.0</td> <td>25</td> <td>710BSM36</td> </tr> </tbody> </table>					Numéro Part number	A (")	B (mm)	Tube mm	Joint d'étanchéité Bonded seal	848FSMH04X14	1/4	M14X1.5	6	710BSM14	848FSMH04X16	1/4	M16X1.5	8	710BSM16	848FSMH04X18	1/4	M18X1.5	10	710BSM18	848FSMH05X16	5/16	M16X1.5	8	710BSM16	848FSMH05X18	5/16	M18X1.5	10	710BSM18	848FSMH06X16	3/8	M16X1.5	8	710BSM16	848FSMH06X18	3/8	M18X1.5	10	710BSM18	848FSMH06X20	3/8	M20X1.5	12	710BSM20	848FSMH06X22	3/8	M22X1.5	14	710BSM22	848FSMH08X18	1/2	M18X1.5	10	710BSM18	848FSMH08X20	1/2	M20X1.5	12	710BSM20	848FSMH08X22	1/2	M22X1.5	14	710BSM22	848FSMH08X24	1/2	M24X1.5	16	710BSM24	848FSMH10X20	5/8	M20X1.5	12	710BSM20	848FSMH10X24	5/8	M24X1.5	16	710BSM24	848FSMH10X30	5/8	M30X2.0	20	710BSM30	848FSMH10X36	5/8	M36X2.0	25	710BSM36	848FSMH12X24	3/4	M24X1.5	16	710BSM24	848FSMH12X30	3/4	M30X2.0	20	710BSM30	848FSMH12X36	3/4	M36X2.0	25	710BSM36	848FSMH16X30	1	M30X2.0	20	710BSM30	848FSMH16X36	1	M36X2.0	25	710BSM36
					Numéro Part number	A (")	B (mm)	Tube mm	Joint d'étanchéité Bonded seal																																																																																																														
					848FSMH04X14	1/4	M14X1.5	6	710BSM14																																																																																																														
					848FSMH04X16	1/4	M16X1.5	8	710BSM16																																																																																																														
					848FSMH04X18	1/4	M18X1.5	10	710BSM18																																																																																																														
					848FSMH05X16	5/16	M16X1.5	8	710BSM16																																																																																																														
					848FSMH05X18	5/16	M18X1.5	10	710BSM18																																																																																																														
					848FSMH06X16	3/8	M16X1.5	8	710BSM16																																																																																																														
					848FSMH06X18	3/8	M18X1.5	10	710BSM18																																																																																																														
					848FSMH06X20	3/8	M20X1.5	12	710BSM20																																																																																																														
848FSMH06X22	3/8	M22X1.5	14	710BSM22																																																																																																																			
848FSMH08X18	1/2	M18X1.5	10	710BSM18																																																																																																																			
848FSMH08X20	1/2	M20X1.5	12	710BSM20																																																																																																																			
848FSMH08X22	1/2	M22X1.5	14	710BSM22																																																																																																																			
848FSMH08X24	1/2	M24X1.5	16	710BSM24																																																																																																																			
848FSMH10X20	5/8	M20X1.5	12	710BSM20																																																																																																																			
848FSMH10X24	5/8	M24X1.5	16	710BSM24																																																																																																																			
848FSMH10X30	5/8	M30X2.0	20	710BSM30																																																																																																																			
848FSMH10X36	5/8	M36X2.0	25	710BSM36																																																																																																																			
848FSMH12X24	3/4	M24X1.5	16	710BSM24																																																																																																																			
848FSMH12X30	3/4	M30X2.0	20	710BSM30																																																																																																																			
848FSMH12X36	3/4	M36X2.0	25	710BSM36																																																																																																																			
848FSMH16X30	1	M30X2.0	20	710BSM30																																																																																																																			
848FSMH16X36	1	M36X2.0	25	710BSM36																																																																																																																			
 <p>848FSKB Mâle JIC / Mâle Kobelco Male JIC / Male Kobelco</p> <table border="1"> <thead> <tr> <th>Numéro Part number</th> <th>A (")</th> <th>B (mm)</th> <th>Tube (mm)</th> </tr> </thead> <tbody> <tr> <td>848FSKB12X36</td> <td>3/4</td> <td>M36X1.5</td> <td>28</td> </tr> <tr> <td>848FSKB16X36</td> <td>1</td> <td>M36X1.5</td> <td>28</td> </tr> <tr> <td>848FSKB16X45</td> <td>1</td> <td>M45X1.5</td> <td>35</td> </tr> <tr> <td>848FSKB20X45</td> <td>1-1/4</td> <td>M45X1.5</td> <td>35</td> </tr> </tbody> </table>					Numéro Part number	A (")	B (mm)	Tube (mm)	848FSKB12X36	3/4	M36X1.5	28	848FSKB16X36	1	M36X1.5	28	848FSKB16X45	1	M45X1.5	35	848FSKB20X45	1-1/4	M45X1.5	35																																																																																															
					Numéro Part number	A (")	B (mm)	Tube (mm)																																																																																																															
					848FSKB12X36	3/4	M36X1.5	28																																																																																																															
					848FSKB16X36	1	M36X1.5	28																																																																																																															
					848FSKB16X45	1	M45X1.5	35																																																																																																															
848FSKB20X45	1-1/4	M45X1.5	35																																																																																																																				
 <p>846FSML Mâle JIC / Femelle métrique tournant (série légère) Male JIC / Female metric swivel (light)</p> <table border="1"> <thead> <tr> <th>Numéro Part number</th> <th>A (")</th> <th>B (mm)</th> <th>Tube (mm)</th> </tr> </thead> <tbody> <tr> <td>846FSML04X12</td> <td>1/4</td> <td>M12X1.5</td> <td>06</td> </tr> <tr> <td>846FSML04X14</td> <td>1/4</td> <td>M14X1.5</td> <td>08</td> </tr> <tr> <td>846FSML05X14</td> <td>5/16</td> <td>M14X1.5</td> <td>08</td> </tr> <tr> <td>846FSML05X16</td> <td>5/16</td> <td>M16X1.5</td> <td>10</td> </tr> <tr> <td>846FSML06X14</td> <td>3/8</td> <td>M14X1.5</td> <td>08</td> </tr> <tr> <td>846FSML06X16</td> <td>3/8</td> <td>M16X1.5</td> <td>10</td> </tr> <tr> <td>846FSML06X18</td> <td>3/8</td> <td>M18X1.5</td> <td>12</td> </tr> <tr> <td>846FSML08X18</td> <td>1/2</td> <td>M18X1.5</td> <td>12</td> </tr> <tr> <td>846FSML08X22</td> <td>1/2</td> <td>M22X1.5</td> <td>15</td> </tr> <tr> <td>846FSML10X22</td> <td>5/8</td> <td>M22X1.5</td> <td>15</td> </tr> </tbody> </table>					Numéro Part number	A (")	B (mm)	Tube (mm)	846FSML04X12	1/4	M12X1.5	06	846FSML04X14	1/4	M14X1.5	08	846FSML05X14	5/16	M14X1.5	08	846FSML05X16	5/16	M16X1.5	10	846FSML06X14	3/8	M14X1.5	08	846FSML06X16	3/8	M16X1.5	10	846FSML06X18	3/8	M18X1.5	12	846FSML08X18	1/2	M18X1.5	12	846FSML08X22	1/2	M22X1.5	15	846FSML10X22	5/8	M22X1.5	15																																																																							
					Numéro Part number	A (")	B (mm)	Tube (mm)																																																																																																															
					846FSML04X12	1/4	M12X1.5	06																																																																																																															
					846FSML04X14	1/4	M14X1.5	08																																																																																																															
					846FSML05X14	5/16	M14X1.5	08																																																																																																															
					846FSML05X16	5/16	M16X1.5	10																																																																																																															
					846FSML06X14	3/8	M14X1.5	08																																																																																																															
					846FSML06X16	3/8	M16X1.5	10																																																																																																															
					846FSML06X18	3/8	M18X1.5	12																																																																																																															
					846FSML08X18	1/2	M18X1.5	12																																																																																																															
					846FSML08X22	1/2	M22X1.5	15																																																																																																															
					846FSML10X22	5/8	M22X1.5	15																																																																																																															

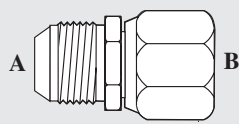
Numéro Part number	A (")	B (mm)	Tube (mm)
846FSML10X26	5/8	M26X1.5	18
846FSML12X26	3/4	M26X1.5	18
846FSML12X30	3/4	M30X2.0	22



Numéro Part number	A (")	B (mm)	Tube (mm)
846FSMH04X16	1/4	M16X1.5	08
846FSMH04X18	1/4	M18X1.5	10
846FSMH05X16	5/16	M16X1.5	08
846FSMH05X18	5/16	M18X1.5	10
846FSMH06X18	3/8	M18X1.5	10
846FSMH06X20	3/8	M20X1.5	12
846FSMH06X22	3/8	M22X1.5	14
846FSMH08X22	1/2	M22X1.5	14
846FSMH10X22	5/8	M22X1.5	14
846FSMH10X30	5/8	M30X2.0	20
846FSMH10X36	5/8	M36X2.0	25
846FSMH12X24	3/4	M24X1.5	16
846FSMH12X30	3/4	M30X2.0	20
846FSMH16X30	1	M30X2.0	20

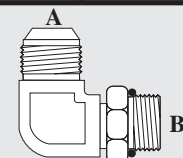

Numéro Part number	A (")	B (mm)
846FSK04X14	1/4	M14X1.5
846FSK06X18	3/8	M18X1.5
846FSK08X22	1/2	M22X1.5
846FSK10X24	5/8	M24X1.5
846FSK12X30	3/4	M30X1.5

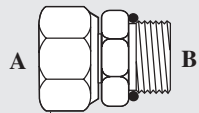

Numéro Part number	A (")	B (mm)	Joint d'étanchéité Bonded seal
881FSM05X12	5/16	M12X1.5	710BSM12
881FSM06X14	3/8	M14X1.5	710BSM14
881FSM06X16	3/8	M16X1.5	710BSM16
881FSM06X18	3/8	M18X1.5	710BSM18
881FSM06X20	3/8	M20X1.5	710BSM20
881FSM06X22	3/8	M22X1.5	710BSM22
881FSM08X16	1/2	M16X1.5	710BSM16
881FSM08X18	1/2	M18X1.5	710BSM18
881FSM08X20	1/2	M20X1.5	710BSM20
881FSM08X22	1/2	M22X1.5	710BSM22
881FSM10X16	5/8	M16X1.5	710BSM16
881FSM10X18	5/8	M18X1.5	710BSM18
881FSM10X20	5/8	M20X1.5	710BSM20
881FSM10X22	5/8	M22X1.5	710BSM22

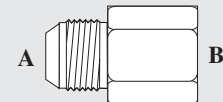

Numéro Part number	A (")	B (mm)	Joint d'étanchéité Bonded seal
849FSM04X12	1/4	M12X1.5	710BSM12
849FSM04X14	1/4	M14X1.5	710BSM14
849FSM06X14	3/8	M14X1.5	710BSM14
849FSM06X16	3/8	M16X1.5	710BSM16
849FSM08X16	1/2	M16X1.5	710BSM16
849FSM08X18	1/2	M18X1.5	710BSM18
849FSM10X18	5/8	M18X1.5	710BSM18
849FSM10X20	5/8	M20X1.5	710BSM20
849FSM12X22	3/4	M22X1.5	710BSM22
849FSM16X33	1	M33X2.0	710BSM33

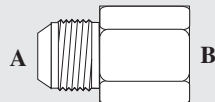

Numéro Part number	A (")	B (")
835FS06X06	3/8	3/8

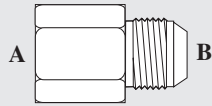
836FS
Femelle JIC fixe / Mâle SAE 45
Female JIC solid / Male SAE 45

Numéro Part number	A (")	B (")
836FS06X06	3/8	3/8

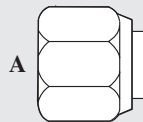
BSPP

630FS
Bouchon femelle BSPP tournant
BSPP female plug swivel

Numéro Part number	A (")
630FS02	1/8
630FS04	1/4
630FS06	3/8
630FS08	1/2
630FS10	5/8
630FS12	3/4
630FS16	1
630FS20	1-1/4
630FS24	1-1/2
630FS32	2

630FSJ
Bouchon femelle JIS
JIS female plug

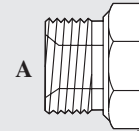
Numéro Part number	A (")
630FSJ02	1/8
630FSJ04	1/4
630FSJ06	3/8
630FSJ08	1/2
630FSJ12	3/4
630FSJ16	1

639FS
Bouchon mâle BSPP
BSPP male plug

Numéro Part number	A (")
639FS02	1/8
639FS04	1/4
639FS06	3/8
639FS08	1/2
639FS10	5/8
639FS12	3/4
639FS16	1
639FS20	1-1/4
639FS24	1-1/2
639FS32	2

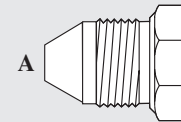
639FSJ
Bouchon mâle JIS
JIS male plug

Numéro Part number	A (")
639FSJ02	1/8
639FSJ04	1/4
639FSJ06	3/8
639FSJ08	1/2
639FSJ12	3/4

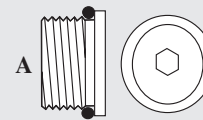
639FSR
Bouchon mâle BSPP (type Allen screw)
BSPP male plug (Allen screw type)

Numéro Part number	A (")
639FSR02	1/8
639FSR04	1/4
639FSR06	3/8
639FSR08	1/2
639FSR12	3/4
639FSR16	1
639FSR20	1-1/4
639FSR24	1-1/2

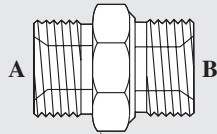
642FS
Mâle BSPP / Mâle BSPP
Male BSPP / Male BSPP

Numéro Part number	A (")	B (")	Joint d'étanchéité Bonded seal
642FS02X02	1/8	1/8	710BSB02
642FS04X02	1/4	1/8	710BSB02
642FS04X04	1/4	1/4	710BSB04
642FS06X02	3/8	1/8	710BSB02
642FS06X04	3/8	1/4	710BSB04
642FS06X06	3/8	3/8	710BSB06
642FS08X04	1/2	1/4	710BSB04
642FS08X06	1/2	3/8	710BSB06
642FS08X08	1/2	1/2	710BSB08
642FS10X06	5/8	3/8	710BSB06
642FS10X08	5/8	1/2	710BSB08
642FS10X10	5/8	5/8	710BSB10
642FS12X06	3/4	3/8	710BSB06
642FS12X08	3/4	1/2	710BSB08
642FS12X10	3/4	5/8	710BSB10
642FS12X12	3/4	3/4	710BSB12
642FS16X06	1	3/8	710BSB06
642FS16X08	1	1/2	710BSB08
642FS16X10	1	5/8	710BSB10
642FS16X12	1	3/4	710BSB12
642FS16X16	1	1	710BSB16
642FS20X12	1-1/4	3/4	710BSB12
642FS20X16	1-1/4	1	710BSB16
642FS20X20	1-1/4	1-1/4	710BSB20
642FS24X16	1-1/2	1	710BSB16
642FS24X20	1-1/2	1-1/4	710BSB20
642FS24X24	1-1/2	1-1/2	710BSB24
642FS32X16	2	1	710BSB16
642FS32X20	2	1-1/4	710BSB20
642FS32X24	2	1-1/2	710BSB24
642FS32X32	2	2	710BSB32

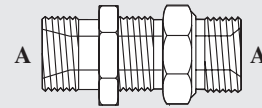
632FS
Mâle BSPP / Mâle BSPP cloison
Male BSPP / Male BSPP bulkhead

Numéro Part number	A (")	Écrou Nut
632FS04	1/4	711BPO04
632FS06	3/8	711BPO06
632FS08	1/2	711BPO08
632FS10	5/8	711BPO10
632FS12	3/4	711BPO12
632FS16	1	711BPO16
632FS20	1-1/4	711BPO20

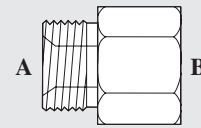

683FS
Mâle BSPP / Femelle BSPP fixe
Male BSPP / Female BSPP solid

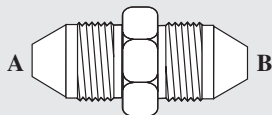
Numéro Part number	A (")	B (")
683FS02X04	1/8	1/4
683FS02X06	1/8	3/8
683FS04X02	1/4	1/8
683FS04X06	1/4	3/8
683FS04X12	1/4	3/4
683FS06X02	3/8	1/8
683FS06X04	3/8	1/4
683FS06X06	3/8	3/8
683FS06X08	3/8	1/2
683FS08X02	1/2	1/8
683FS08X04	1/2	1/4
683FS08X06	1/2	3/8
683FS08X12	1/2	3/4
683FS08X16	1/2	1
683FS08X20	1/2	1-1/4
683FS12X04	3/4	1/4
683FS12X06	3/4	3/8
683FS12X08	3/4	1/2
683FS12X16	3/4	1
683FS12X20	3/4	1-1/4
683FS12X24	3/4	1-1/2
683FS16X04	1	1/4
683FS16X06	1	3/8
683FS16X08	1	1/2
683FS16X12	1	3/4
683FS16X20	1	1-1/4
683FS16X24	1	1-1/2
683FS20X08	1-1/4	1/2
683FS20X12	1-1/4	3/4

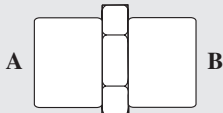
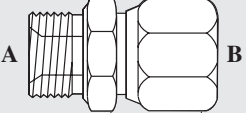
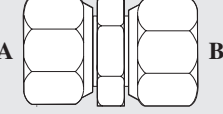

642FSJ
Mâle JIS / Mâle JIS
Male JIS / Male JIS

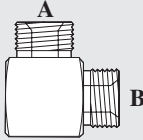
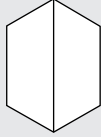
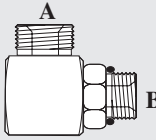
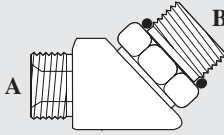
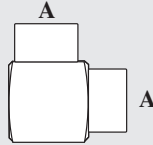
Numéro Part number	A (")	B (")
642FSJ02X02	1/8	1/8
642FSJ04X04	1/4	1/4
642FSJ06X06	3/8	3/8
642FSJ08X08	1/2	1/2
642FSJ12X12	3/4	3/4

Numéro Part number	A (")	B (")				
683FS20X16	1-1/4	1	680FS Femelle BSPP fixe / Femelle BSPP fixe Female BSPP solid / Female BSPP solid			
683FS20X24	1-1/4	1-1/2				
683FS24X08	1-1/2	1/2				
683FS24X12	1-1/2	3/4				
683FS24X16	1-1/2	1				
683FS24X20	1-1/2	1-1/4				
			Numéro Part number	A (")	B (")	
683FSSW Mâle BSPP / Femelle BSPP tournant Male BSPP / Female BSPP swivel			680FS02X02	1/8	1/8	
			680FS04X02	1/4	1/8	
			680FS04X04	1/4	1/4	
			680FS06X04	3/8	1/4	
			680FS06X06	3/8	3/8	
			680FS08X06	1/2	3/8	
			680FS08X08	1/2	1/2	
			680FS10X08	5/8	1/2	
			680FS10X10	5/8	5/8	
			680FS12X08	3/4	1/2	
			680FS12X12	3/4	3/4	
			680FS16X12	1	3/4	
			680FS16X16	1	1	
			680FS20X20	1-1/4	1-1/4	
			680FS24X24	1-1/2	1-1/2	
Numéro Part number	A (")	Joint d'étanchéité Bonded seal	B (")			
				680FSSW Femelle BSPP tournant / Femelle BSPP tournant Female BSPP swivel / Female BSPP swivel		
				Numéro Part number	A (")	B (")
683FSSW02X02	1/8	710BSB02	1/8	680FSSW02X02	1/8	1/8
683FSSW02X04	1/8	710BSB02	1/4	680FSSW04X04	1/4	1/4
683FSSW04X02	1/4	710BSB04	1/8	680FSSW06X04	3/8	1/4
683FSSW04X04	1/4	710BSB04	1/4	680FSSW06X06	3/8	3/8
683FSSW04X06	1/4	710BSB04	3/8	680FSSW08X04	1/2	1/4
683FSSW04X08	1/4	710BSB04	1/2	680FSSW08X06	1/2	3/8
683FSSW06X04	3/8	710BSB06	1/4	680FSSW08X08	1/2	1/2
683FSSW06X06	3/8	710BSB06	3/8	680FSSW10X08	5/8	1/2
683FSSW06X08	3/8	710BSB06	1/2	680FSSW10X10	5/8	5/8
683FSSW06X12	3/8	710BSB06	3/4	680FSSW12X08	3/4	1/2
683FSSW08X04	1/2	710BSB08	1/4	680FSSW12X10	3/4	3/4
683FSSW08X06	1/2	710BSB08	3/8	680FSSW12X12	3/4	3/4
683FSSW08X08	1/2	710BSB08	1/2	680FSSW12X16	3/4	1
683FSSW08X10	1/2	710BSB08	5/8	680FSSW12X20	3/4	1-1/4
683FSSW08X12	1/2	710BSB08	3/4	680FSSW16X08	1	1/2
683FSSW08X16	1/2	710BSB08	1	680FSSW16X10	1	5/8
683FSSW10X08	5/8	710BSB10	1/2	680FSSW16X12	1	3/4
683FSSW10X10	5/8	710BSB10	5/8	680FSSW16X16	1	1
683FSSW10X12	5/8	710BSB10	3/4	680FSSW20X20	1-1/4	1-1/4
683FSSW12X06	3/4	710BSB12	3/8	680FSSW20X16	1-1/4	1
683FSSW12X08	3/4	710BSB12	1/2	680FSSW20X20	1-1/4	1-1/4
683FSSW12X10	3/4	710BSB12	5/8	680FSSW20X24	1-1/4	1-1/2
683FSSW12X12	3/4	710BSB12	3/4	680FSSW24X20	1-1/2	1-1/4
683FSSW12X16	3/4	710BSB12	1	680FSSW24X24	1-1/2	1-1/2
683FSSW12X20	3/4	710BSB12	1-1/4	680FSSW24X32	1-1/2	1-1/2
683FSSW16X08	1	710BSB16	1/2	680FSSW32X24	2	1-1/2
683FSSW16X10	1	710BSB16	5/8	680FSSW32X32	2	2
683FSSW16X12	1	710BSB16	3/4			
683FSSW16X16	1	710BSB16	1			
683FSSW16X20	1	710BSB16	1-1/4			
683FSSW20X12	1-1/4	710BSB20	3/4			
683FSSW20X16	1-1/4	710BSB20	1			
683FSSW20X20	1-1/4	710BSB20	1-1/4			
683FSSW20X24	1-1/4	710BSB20	1-1/2			
683FSSW24X20	1-1/2	710BSB24	1-1/4			
683FSSW24X24	1-1/2	710BSB24	1-1/2			
683FSSW24X32	1-1/2	710BSB24	2			
683FSSW32X24	2	710BSB32	1-1/2			
683FSSW32X32	2	710BSB32	2			

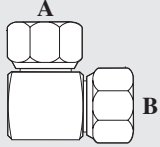
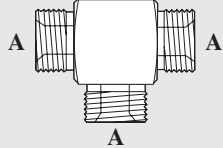
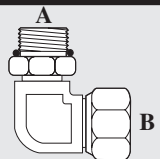
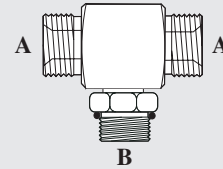
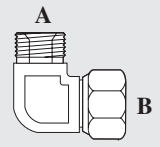
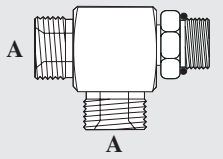
																																															
698FS Siège BSPP face plate BSPP flat face sealing seat		655FS Mâle BSPP / Mâle BSPP Male BSPP / Male BSPP																																													
<table border="1"> <thead> <tr> <th>Numéro Part number</th> <th>Dimension Size</th> </tr> </thead> <tbody> <tr> <td>698FS06</td> <td>3/8</td> </tr> <tr> <td>698FS08</td> <td>1/2</td> </tr> <tr> <td>698FS12</td> <td>3/4</td> </tr> </tbody> </table>	Numéro Part number	Dimension Size	698FS06	3/8	698FS08	1/2	698FS12	3/4	<table border="1"> <thead> <tr> <th>Numéro Part number</th> <th>A (")</th> <th>B (")</th> </tr> </thead> <tbody> <tr> <td>655FS02X02</td> <td>1/8</td> <td>1/8</td> </tr> <tr> <td>655FS04X04</td> <td>1/4</td> <td>1/4</td> </tr> <tr> <td>655FS06X04</td> <td>3/8</td> <td>1/4</td> </tr> <tr> <td>655FS06X06</td> <td>3/8</td> <td>3/8</td> </tr> <tr> <td>655FS08X06</td> <td>1/2</td> <td>3/8</td> </tr> <tr> <td>655FS08X08</td> <td>1/2</td> <td>1/2</td> </tr> <tr> <td>655FS10X10</td> <td>5/8</td> <td>5/8</td> </tr> <tr> <td>655FS12X12</td> <td>3/4</td> <td>3/4</td> </tr> <tr> <td>655FS16X16</td> <td>1</td> <td>1</td> </tr> </tbody> </table>	Numéro Part number	A (")	B (")	655FS02X02	1/8	1/8	655FS04X04	1/4	1/4	655FS06X04	3/8	1/4	655FS06X06	3/8	3/8	655FS08X06	1/2	3/8	655FS08X08	1/2	1/2	655FS10X10	5/8	5/8	655FS12X12	3/4	3/4	655FS16X16	1	1								
Numéro Part number	Dimension Size																																														
698FS06	3/8																																														
698FS08	1/2																																														
698FS12	3/4																																														
Numéro Part number	A (")	B (")																																													
655FS02X02	1/8	1/8																																													
655FS04X04	1/4	1/4																																													
655FS06X04	3/8	1/4																																													
655FS06X06	3/8	3/8																																													
655FS08X06	1/2	3/8																																													
655FS08X08	1/2	1/2																																													
655FS10X10	5/8	5/8																																													
655FS12X12	3/4	3/4																																													
655FS16X16	1	1																																													
																																															
699FS Siège BSPP-JIS BSPP-JIS sealing seat		655FSA Mâle BSPP / Mâle BSPP ajustable Male BSPP / Male BSPP adjustable																																													
<table border="1"> <thead> <tr> <th>Numéro Part number</th> <th>Dimension Size</th> </tr> </thead> <tbody> <tr> <td>699FS04</td> <td>1/4</td> </tr> <tr> <td>699FS06</td> <td>3/8</td> </tr> <tr> <td>699FS08</td> <td>1/2</td> </tr> <tr> <td>699FS12</td> <td>3/4</td> </tr> <tr> <td>699FS16</td> <td>1</td> </tr> </tbody> </table>	Numéro Part number	Dimension Size	699FS04	1/4	699FS06	3/8	699FS08	1/2	699FS12	3/4	699FS16	1	<table border="1"> <thead> <tr> <th>Numéro Part number</th> <th>A (")</th> <th>B (")</th> <th>Joint d'étanchéité Bonded seal</th> </tr> </thead> <tbody> <tr> <td>655FSA04X04</td> <td>1/4</td> <td>1/4</td> <td>710BSB04</td> </tr> <tr> <td>655FSA06X06</td> <td>3/8</td> <td>3/8</td> <td>710BSB06</td> </tr> <tr> <td>655FSA08X08</td> <td>1/2</td> <td>1/2</td> <td>710BSB08</td> </tr> <tr> <td>655FSA12X12</td> <td>3/4</td> <td>3/4</td> <td>710BSB12</td> </tr> </tbody> </table>	Numéro Part number	A (")	B (")	Joint d'étanchéité Bonded seal	655FSA04X04	1/4	1/4	710BSB04	655FSA06X06	3/8	3/8	710BSB06	655FSA08X08	1/2	1/2	710BSB08	655FSA12X12	3/4	3/4	710BSB12														
Numéro Part number	Dimension Size																																														
699FS04	1/4																																														
699FS06	3/8																																														
699FS08	1/2																																														
699FS12	3/4																																														
699FS16	1																																														
Numéro Part number	A (")	B (")	Joint d'étanchéité Bonded seal																																												
655FSA04X04	1/4	1/4	710BSB04																																												
655FSA06X06	3/8	3/8	710BSB06																																												
655FSA08X08	1/2	1/2	710BSB08																																												
655FSA12X12	3/4	3/4	710BSB12																																												
																																															
656FSA Mâle BSPP / Mâle BSPP ajustable Male BSPP / Male BSPP adjustable		674FS Femelle BSPP fixe / Femelle BSPP fixe Female BSPP solid / Female BSPP solid																																													
<table border="1"> <thead> <tr> <th>Numéro Part number</th> <th>A (")</th> <th>B (")</th> <th>Joint d'étanchéité Bonded seal</th> </tr> </thead> <tbody> <tr> <td>656FSA04X04</td> <td>1/4</td> <td>1/4</td> <td>710BSB04</td> </tr> <tr> <td>656FSA06X04</td> <td>3/8</td> <td>1/4</td> <td>710BSB04</td> </tr> <tr> <td>656FSA06X06</td> <td>3/8</td> <td>3/8</td> <td>710BSB06</td> </tr> <tr> <td>656FSA08X06</td> <td>1/2</td> <td>3/8</td> <td>710BSB06</td> </tr> <tr> <td>656FSA08X08</td> <td>1/2</td> <td>1/2</td> <td>710BSB08</td> </tr> <tr> <td>656FSA12X12</td> <td>3/4</td> <td>3/4</td> <td>710BSB12</td> </tr> <tr> <td>656FSA16X16</td> <td>1</td> <td>1</td> <td>710BSB16</td> </tr> </tbody> </table>	Numéro Part number	A (")	B (")	Joint d'étanchéité Bonded seal	656FSA04X04	1/4	1/4	710BSB04	656FSA06X04	3/8	1/4	710BSB04	656FSA06X06	3/8	3/8	710BSB06	656FSA08X06	1/2	3/8	710BSB06	656FSA08X08	1/2	1/2	710BSB08	656FSA12X12	3/4	3/4	710BSB12	656FSA16X16	1	1	710BSB16	<table border="1"> <thead> <tr> <th>Numéro Part number</th> <th>A (")</th> </tr> </thead> <tbody> <tr> <td>674FS04</td> <td>1/4</td> </tr> <tr> <td>674FS06</td> <td>3/8</td> </tr> <tr> <td>674FS08</td> <td>1/2</td> </tr> <tr> <td>674FS12</td> <td>3/4</td> </tr> <tr> <td>674FS16</td> <td>1</td> </tr> </tbody> </table>	Numéro Part number	A (")	674FS04	1/4	674FS06	3/8	674FS08	1/2	674FS12	3/4	674FS16	1		
Numéro Part number	A (")	B (")	Joint d'étanchéité Bonded seal																																												
656FSA04X04	1/4	1/4	710BSB04																																												
656FSA06X04	3/8	1/4	710BSB04																																												
656FSA06X06	3/8	3/8	710BSB06																																												
656FSA08X06	1/2	3/8	710BSB06																																												
656FSA08X08	1/2	1/2	710BSB08																																												
656FSA12X12	3/4	3/4	710BSB12																																												
656FSA16X16	1	1	710BSB16																																												
Numéro Part number	A (")																																														
674FS04	1/4																																														
674FS06	3/8																																														
674FS08	1/2																																														
674FS12	3/4																																														
674FS16	1																																														

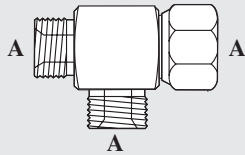
							
675FS Femelle BSPP tournant / Femelle BSPP tournant Female BSPP swivel / Female BSPP swivel				644FS Mâle BSPP / Mâle BSPP / Mâle BSPP Male BSPP / Male BSPP / Male BSPP			
Numéro Part number	A (")	Joint d'étanchéité Bonded seal		Numéro Part number	A (")	Joint d'étanchéité Bonded seal	
675FS04X04	1/4	710BSB04		644FS04	1/4	710BSB04	
675FS06X06	3/8	710BSB06		644FS06	3/8	710BSB06	
675FS08X08	1/2	710BSB08		644FS08	1/2	710BSB08	
675FS10X10	5/8	710BSB10		644FS10	5/8	710BSB10	
675FS12X12	3/4	710BSB12		644FS12	3/4	710BSB12	
675FS16X16	1	710BSB16		644FS16	1	710BSB16	
							
679FS Mâle BSPP ajustable / Femelle BSPP tournant Male BSPP adjustable / Female BSPP swivel				670FS Mâle BSPP / Mâle BSPP ajustable / Mâle BSPP Male BSPP / Male BSPP adjustable / Male BSPP			
Numéro Part number	A (")	Joint d'étanchéité Bonded seal	B (")	Numéro Part number	A (")	B (")	Joint d'étanchéité Bonded seal
679FS04X04	1/4	710BSB04	1/4	670FS04X04	1/4	1/4	710BSB04
679FS06X06	3/8	710BSB06	3/8	670FS06X04	3/8	1/4	710BSB04
679FS08X08	1/2	710BSB08	1/2	670FS06X06	3/8	3/8	710BSB06
679FS10X10	5/8	710BSB10	5/8	670FS08X06	1/2	3/8	710BSB06
679FS12X12	3/4	710BSB12	3/4	670FS08X08	1/2	1/2	710BSB08
679FS16X16	1	710BSB16	1	670FS12X12	3/4	3/4	710BSB12
							
679FSB Mâle BSPP / Femelle BSPP tournant Male BSPP / Female BSPP swivel				661FS Mâle BSPP / Mâle BSPP / Mâle BSPP ajustable Male BSPP / Male BSPP / Male BSPP adjustable			
Numéro Part number	A (")	Joint d'étanchéité Bonded seal	B (")	Numéro Part number	A (")	B (")	Joint d'étanchéité Bonded seal
679FSB02X02	1/8	710BSB02	1/8	661FS04X04	1/4	1/4	710BSB04
679FSB04X04	1/4	710BSB04	1/4	661FS06X04	3/8	1/4	710BSB04
679FSB04X06	1/4	710BSB04	3/8	661FS06X06	3/8	3/8	710BSB06
679FSB06X04	3/8	710BSB06	1/4	661FS08X06	1/2	3/8	710BSB06
679FSB06X06	3/8	710BSB06	3/8	661FS08X08	1/2	1/2	710BSB08
679FSB06X08	3/8	710BSB06	1/2	661FS12X12	3/4	3/4	710BSB12
679FSB08X06	1/2	710BSB08	3/8				
679FSB08X08	1/2	710BSB08	1/2				
679FSB10X10	5/8	710BSB10	5/8				
679FSB12X12	3/4	710BSB12	3/4				
679FSB16X12	1	710BSB16	3/4				
679FSB16X16	1	710BSB16	1				
679FSB20X20	1-1/4	710BSB20	1-1/4				
679FSB24X24	1-1/2	710BSB24	1-1/2				
679FSB32X32	2	710BSB32	2				

671FS

Mâle BSPP / Mâle BSPP / Femelle BSPP tournant
Male BSPP / Male BSPP / Female BSPP swivel

Numéro Part number	A (")	Joint d'étanchéité Bonded seal
671FS04	1/4	710BSB04
671FS06	3/8	710BSB06
671FS08	1/2	710BSB08
671FS10	5/8	710BSB10
671FS12	3/4	710BSB12
671FS16	1	710BSB16

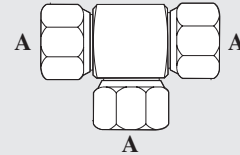
673FSSW

Femelle BSPP tourn./Femelle BSPP tourn./Femelle BSPP tourn.
Female BSPP swivel/Female BSPP swivel/Female BSPP swivel

Numéro Part number	A (")
673FSSW02	1/8
673FSSW04	1/4
673FSSW06	3/8
673FSSW08	1/2
673FSSW10	5/8
673FSSW12	3/4
673FSSW16	1
673FSSW20	1-1/4
673FSSW24	1-1/2
673FSSW32	2

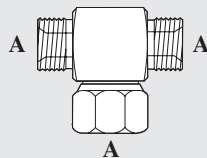
672FS

Mâle BSPP / Femelle BSPP tournant / Mâle BSPP
Male BSPP / Female BSPP swivel / Male BSPP

Numéro Part number	A (")	Joint d'étanchéité Bonded seal
672FS02	1/8	710BSB02
672FS04	1/4	710BSB04
672FS06	3/8	710BSB06
672FS08	1/2	710BSB08
672FS10	5/8	710BSB10
672FS12	3/4	710BSB12
672FS16	1	710BSB16
672FS20	1-1/4	710BSB20

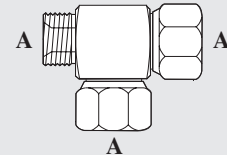
677FS

Mâle BSPP / Femelle BSPP tournant / Femelle BSPP tournant
Male BSPP / Female BSPP swivel / Female BSPP swivel

Numéro Part number	A (")	Joint d'étanchéité Bonded seal
677FS04	1/4	710BSB04
677FS06	3/8	710BSB06
677FS08	1/2	710BSB08
677FS10	5/8	710BSB10
677FS12	3/4	710BSB12
677FS16	1	710BSB16

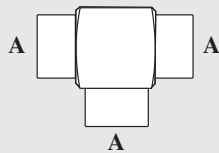
673FS

Femelle BSPP fixe / Femelle BSPP fixe / Femelle BSPP fixe
Female BSPP solid / Female BSPP solid / Female BSPP solid

Numéro Part number	A (")
673FS02	1/8
673FS04	1/4
673FS06	3/8
673FS08	1/2
673FS12	3/4
673FS16	1

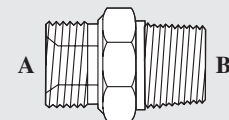

648FS

Mâle BSPP / Mâle NPTF
Male BSPP / Male NPTF

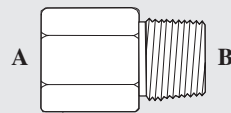
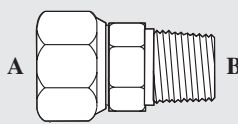
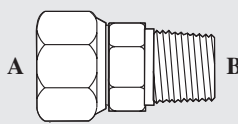
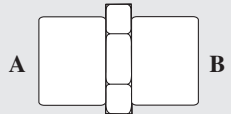
Numéro Part number	A (")	Joint d'étanchéité Bonded seal	B (")
648FS02X02	1/8	710BSB02	1/8
648FS02X04	1/8	710BSB02	1/4
648FS04X02	1/4	710BSB04	1/8
648FS04X04	1/4	710BSB04	1/4
648FS04X06	1/4	710BSB04	3/8
648FS04X08	1/4	710BSB04	1/2
648FS06X02	3/8	710BSB06	1/8
648FS06X04	3/8	710BSB06	1/4
648FS06X06	3/8	710BSB06	3/8
648FS06X08	3/8	710BSB06	1/2

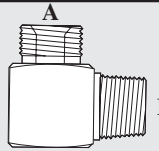
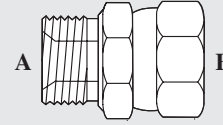
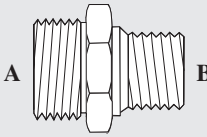
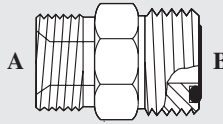
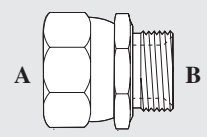
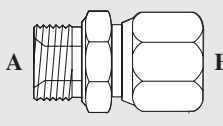
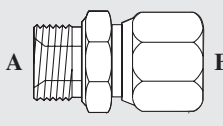
Numéro Part number	A (")	Joint d'étanchéité Bonded seal	B (")																																						
648FS06X12	3/8	710BSB06	3/4	681FS Femelle BSPP fixe / Mâle NPTF Female BSPP solid / Male NPTF																																					
648FS06X16	3/8	710BSB06	1																																						
648FS08X04	1/2	710BSB08	1/4																																						
648FS08X06	1/2	710BSB08	3/8																																						
648FS08X08	1/2	710BSB08	1/2																																						
648FS08X12	1/2	710BSB08	3/4																																						
648FS08X16	1/2	710BSB08	1																																						
648FS10X08	5/8	710BSB10	1/2																																						
648FS10X12	5/8	710BSB10	3/4																																						
648FS12X04	3/4	710BSB12	1/4																																						
648FS12X06	3/4	710BSB12	3/8																																						
648FS12X08	3/4	710BSB12	1/2																																						
648FS12X12	3/4	710BSB12	3/4																																						
648FS12X16	3/4	710BSB12	1																																						
648FS16X08	1	710BSB16	1/2																																						
648FS16X12	1	710BSB16	3/4																																						
648FS16X16	1	710BSB16	1																																						
648FS16X20	1	710BSB16	1-1/4																																						
648FS20X16	1-1/4	710BSB20	1																																						
648FS20X20	1-1/4	710BSB20	1-1/4																																						
648FS20X24	1-1/4	710BSB20	1-1/2																																						
648FS24X16	1-1/2	710BSB24	1																																						
648FS24X20	1-1/2	710BSB24	1-1/4																																						
648FS24X24	1-1/2	710BSB24	1-1/2																																						
648FS24X32	1-1/2	710BSB24	2																																						
648FS32X20	2	710BSB32	1-1/4																																						
648FS32X24	2	710BSB32	1-1/2																																						
648FS32X32	2	710BSB32	2																																						
				681FSSW Femelle BSPP tournant / Mâle NPTF Female BSPP swivel / Male NPTF																																					
Numéro Part number	A (")	B (")	<table border="1"> <thead> <tr> <th>Numéro Part number</th> <th>A (")</th> <th>B (")</th> </tr> </thead> <tbody> <tr><td>681FSSW02X02</td><td>1/8</td><td>1/8</td></tr> <tr><td>681FSSW04X04</td><td>1/4</td><td>1/4</td></tr> <tr><td>681FSSW04X06</td><td>1/4</td><td>3/8</td></tr> <tr><td>681FSSW06X06</td><td>3/8</td><td>3/8</td></tr> <tr><td>681FSSW06X08</td><td>3/8</td><td>1/2</td></tr> <tr><td>681FSSW08X06</td><td>1/2</td><td>3/8</td></tr> <tr><td>681FSSW08X08</td><td>1/2</td><td>1/2</td></tr> <tr><td>681FSSW08X12</td><td>1/2</td><td>3/4</td></tr> <tr><td>681FSSW12X12</td><td>3/4</td><td>3/4</td></tr> <tr><td>681FSSW12X16</td><td>3/4</td><td>1</td></tr> <tr><td>681FSSW16X16</td><td>1</td><td>1</td></tr> </tbody> </table>			Numéro Part number	A (")	B (")	681FSSW02X02	1/8	1/8	681FSSW04X04	1/4	1/4	681FSSW04X06	1/4	3/8	681FSSW06X06	3/8	3/8	681FSSW06X08	3/8	1/2	681FSSW08X06	1/2	3/8	681FSSW08X08	1/2	1/2	681FSSW08X12	1/2	3/4	681FSSW12X12	3/4	3/4	681FSSW12X16	3/4	1	681FSSW16X16	1	1
Numéro Part number	A (")	B (")																																							
681FSSW02X02	1/8	1/8																																							
681FSSW04X04	1/4	1/4																																							
681FSSW04X06	1/4	3/8																																							
681FSSW06X06	3/8	3/8																																							
681FSSW06X08	3/8	1/2																																							
681FSSW08X06	1/2	3/8																																							
681FSSW08X08	1/2	1/2																																							
681FSSW08X12	1/2	3/4																																							
681FSSW12X12	3/4	3/4																																							
681FSSW12X16	3/4	1																																							
681FSSW16X16	1	1																																							
				646FS Mâle BSPP / Femelle NPTF Male BSPP / Female NPTF																																					
Numéro Part number	A (")	Joint d'étanchéité Bonded seal	B (")																																						
646FS02X02	1/8	710BSB02	1/8	682FS Femelle BSPP fixe / Femelle NPTF Female BSPP solid / Female NPTF																																					
646FS02X04	1/8	710BSB02	1/4																																						
646FS04X04	1/4	710BSB04	1/4																																						
646FS04X06	1/4	710BSB04	3/8																																						
646FS06X04	3/8	710BSB06	1/4																																						
646FS06X06	3/8	710BSB06	3/8																																						
646FS08X06	1/2	710BSB08	3/8																																						
646FS08X08	1/2	710BSB08	1/2																																						
646FS12X12	3/4	710BSB12	3/4																																						
646FS16X08	1	710BSB16	1/2																																						
646FS16X16	1	710BSB16	1																																						
646FS20X16	1-1/4	710BSB20	1																																						
646FS20X20	1-1/4	710BSB20	1-1/4																																						
646FS24X20	1-1/2	710BSB24	1-1/4																																						
646FS24X24	1-1/2	710BSB24	1-1/2																																						
646FS24X32	1-1/2	710BSB24	1-1/2																																						
Numéro Part number	A (")	B (")	<table border="1"> <thead> <tr> <th>Numéro Part number</th> <th>A (")</th> <th>B (")</th> </tr> </thead> <tbody> <tr><td>682FS02X02</td><td>1/8</td><td>1/8</td></tr> <tr><td>682FS04X04</td><td>1/4</td><td>1/4</td></tr> <tr><td>682FS06X06</td><td>3/8</td><td>3/8</td></tr> <tr><td>682FS08X08</td><td>1/2</td><td>1/2</td></tr> <tr><td>682FS12X12</td><td>3/4</td><td>3/4</td></tr> <tr><td>682FS16X16</td><td>1</td><td>1</td></tr> <tr><td>682FS20X20</td><td>1-1/4</td><td>1-1/4</td></tr> <tr><td>682FS24X24</td><td>1-1/2</td><td>1-1/2</td></tr> <tr><td>682FS32X32</td><td>2</td><td>2</td></tr> </tbody> </table>				Numéro Part number	A (")	B (")	682FS02X02	1/8	1/8	682FS04X04	1/4	1/4	682FS06X06	3/8	3/8	682FS08X08	1/2	1/2	682FS12X12	3/4	3/4	682FS16X16	1	1	682FS20X20	1-1/4	1-1/4	682FS24X24	1-1/2	1-1/2	682FS32X32	2	2					
Numéro Part number	A (")	B (")																																							
682FS02X02	1/8	1/8																																							
682FS04X04	1/4	1/4																																							
682FS06X06	3/8	3/8																																							
682FS08X08	1/2	1/2																																							
682FS12X12	3/4	3/4																																							
682FS16X16	1	1																																							
682FS20X20	1-1/4	1-1/4																																							
682FS24X24	1-1/2	1-1/2																																							
682FS32X32	2	2																																							

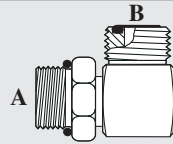
													
649FS Mâle BSPP / Mâle NPTF Male BSPP / Male NPTF				646FSM Mâle BSPP / Femelle métrique tournant Male BSPP / Female metric swivel									
Numéro Part number	A (")	Joint d'étanchéité Bonded seal	B (")	Numéro Part number	A (")	Joint d'étanchéité Bonded seal	B (mm)	Tube mm					
649FS04X04	1/4	710BSB04	1/4	646FSM04X14	1/4	710BSB04	M14X1.5	8					
649FS06X06	3/8	710BSB06	3/8	646FSM08X18	1/2	710BSB08	M18X1.5	12					
649FS08X08	1/2	710BSB08	1/2	646FSM08X20	1/2	710BSB08	M20X1.5	12					
649FS12X12	3/4	710BSB12	3/4	646FSM08X24	1/2	710BSB08	M24X1.5	16					
				646FSM12X26	3/4	710BSB12	M26X1.5	18					
				646FSM16X30	1	710BSB16	M30X2.0	22					
				646FSM20X45	1-1/4	710BSB20	M45X2.0	35					
				646FSM24X52	1-1/2	710BSB24	M52X2.0	42					
									648TT Mâle BSPP / Mâle o'ring face Male BSPP / Male o'ring face				
				Numéro Part number	A (")	B (mm)	Joint d'étanchéité Bonded seal	Numéro Part number	A (")	Joint d'étanchéité Bonded seal	B (")	O'ring	
				648FSM04X12	1/4	M12X1.5	710BSM12	648TT04X04	1/4	710BSB04	1/4	710TTO04	
648FSM04X14	1/4	M14X1.5	710BSM14	648TT04X06	1/4	710BSB04	3/8	710TTO06					
648FSM04X16	1/4	M16X1.5	710BSM16	648TT06X06	3/8	710BSB06	3/8	710TTO06					
648FSM06X12	3/8	M12X1.5	710BSM12	648TT06X08	3/8	710BSB06	1/2	710TTO08					
648FSM06X14	3/8	M14X1.5	710BSM14	648TT08X08	1/2	710BSB08	1/2	710TTO08					
648FSM06X16	3/8	M16X1.5	710BSM16	648TT08X10	1/2	710BSB08	5/8	710TTO10					
648FSM06X18	3/8	M18X1.5	710BSM18	648TT12X12	3/4	710BSB12	3/4	710TTO12					
648FSM08X16	1/2	M16X1.5	710BSM16	648TT20X20	1-1/4	710BSB20	1-1/4	710TTO20					
648FSM08X18	1/2	M18X1.5	710BSM18	648TT24X24	1-1/2	710BSB24	1-1/2	710TTO24					
648FSM08X22	1/2	M22X1.5	710BSM22										
648FSM10X26	5/8	M26X1.5	710BSM26										
648FSM12X30	3/4	M30X1.5	710BSM30										
648FSM16X38	1	M38X1.5	710BSM38										
									681TT Mâle BSPP / Femelle o'ring face tournant Male BSPP / Female o'ring face swivel				
Numéro Part number	A (")	B (mm)	Joint d'étanchéité Bonded seal						Numéro Part number	A (")	Joint d'étanchéité Bonded seal	B (")	
681FSM06X16	3/8	M16X1.5	710BSM16						646TT04X04	1/4	710BSB04	1/4	
681FSM06X18	3/8	M18X1.5	710BSM18	646TT04X06	1/4	710BSB04	3/8						
681FSM08X18	1/2	M18X1.5	710BSM18	646TT06X06	3/8	710BSB06	3/8						
681FSM12X26	3/4	M26X1.5	710BSM26	646TT06X08	3/8	710BSB06	1/2						
				646TT08X08	1/2	710BSB08	1/2						
				646TT08X10	1/2	710BSB08	5/8						
				646TT12X12	3/4	710BSB12	3/4						
				646TT16X16	1	710BSB16	1						
				646TT20X16	1-1/4	710BSB20	1						
				646TT20X20	1-1/4	710BSB20	1-1/4						

649TT
Mâle BSPP ajustable / Mâle o'ring face
Male BSPP adjustable / Male o'ring face

Numéro Part number	A (")	Joint d'étanchéité Bonded seal	B (")
649TT02X04	1/8	710BSB02	1/4
649TT04X04	1/4	710BSB04	1/4
649TT04X06	1/4	710BSB04	3/8
649TT04X08	1/4	710BSB04	1/2
649TT06X06	3/8	710BSB06	3/8
649TT06X08	3/8	710BSB06	1/2
649TT08X06	1/2	710BSB08	3/8
649TT08X08	1/2	710BSB08	1/2
649TT08X10	1/2	710BSB08	5/8
649TT08X12	1/2	710BSB08	3/4
649TT12X12	3/4	710BSB12	3/4
649TT12X16	3/4	710BSB12	1
649TT16X12	1	710BSB16	3/4
649TT16X16	1	710BSB16	1
649TT20X16	1-1/4	710BSB20	1
649TT20X20	1-1/4	710BSB20	1-1/4
649TT24X24	1-1/2	710BSB24	1-1/2

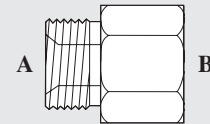
646FSO
Mâle BSPP / Femelle o'ring boss
Male BSPP / Female o'ring boss

Numéro Part number	A (")	Joint d'étanchéité Bonded seal	B (")
646FSO02X04	1/8	710BSB02	1/4
646FSO04X04	1/4	710BSB04	1/4
646FSO04X06	1/4	710BSB04	3/8
646FSO06X06	3/8	710BSB06	3/8
646FSO06X08	3/8	710BSB06	1/2
646FSO08X08	1/2	710BSB08	1/2
646FSO08X10	1/2	710BSB08	5/8
646FSO12X12	3/4	710BSB12	3/4
646FSO16X16	1	710BSB16	1
646FSO20X20	1-1/4	710BSB20	1-1/4
646FSO20X24	1-1/4	710BSB20	1-1/2
646FSO24X24	1-1/2	710BSB24	1-1/2

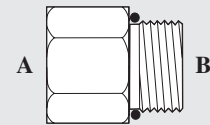
681FSO
Femelle BSPP fixe / Mâle o'ring boss
Female BSPP solid / Male o'ring boss

Numéro Part number	A (")	B (")	O'ring
681FSO02X04	1/8	1/4	710FSO04
681FSO04X04	1/4	1/4	710FSO04
681FSO04X06	1/4	3/8	710FSO06
681FSO06X06	3/8	3/8	710FSO06
681FSO08X08	1/2	1/2	710FSO08
681FSO20X12	1-1/4	3/4	710FSO12

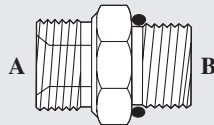

648FSO
Mâle BSPP / Mâle o'ring boss
Male BSPP / Male o'ring boss

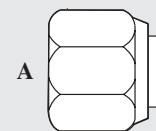
Numéro Part number	A (")	Joint d'étanchéité Bonded seal	B (")	O'ring
648FSO04X04	1/4	710BSB04	1/4	710FSO04
648FSO04X06	1/4	710BSB04	3/8	710FSO06
648FSO04X08	1/4	710BSB04	1/2	710FSO08
648FSO06X04	3/8	710BSB06	1/4	710FSO04
648FSO06X06	3/8	710BSB06	3/8	710FSO06
648FSO06X08	3/8	710BSB06	1/2	710FSO08
648FSO06X10	3/8	710BSB06	5/8	710FSO10
648FSO08X06	1/2	710BSB08	3/8	710FSO06
648FSO08X08	1/2	710BSB08	1/2	710FSO08
648FSO08X10	1/2	710BSB08	5/8	710FSO10
648FSO08X12	1/2	710BSB08	3/4	710FSO12
648FSO12X08	3/4	710BSB12	1/2	710FSO08
648FSO12X10	3/4	710BSB12	5/8	710FSO10
648FSO12X12	3/4	710BSB12	3/4	710FSO12
648FSO12X16	3/4	710BSB12	1	710FSO16
648FSO16X12	1	710BSB16	3/4	710FSO12
648FSO16X16	1	710BSB16	1	710FSO16
648FSO16X20	1	710BSB16	1-1/4	710FSO20
648FSO20X20	1-1/4	710BSB20	1-1/4	710FSO20

MÉTRIQUE - METRIC

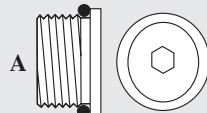
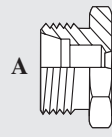
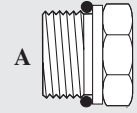
630FSM
Bouchon femelle métrique
Metric female plug

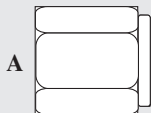
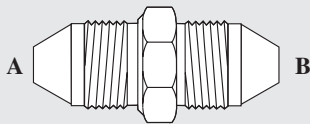
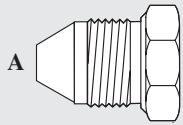
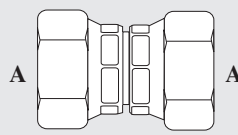
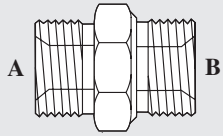
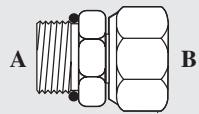
Numéro Part number	Tube (mm)	A (mm)
630FSM06X12	6	M12X1.5
630FSM06X14	6	M14X1.5
630FSM08X14	8	M14X1.5
630FSM08X16	8	M16X1.5
630FSM10X16	10	M16X1.5
630FSM10X18	10	M18X1.5
630FSM12X18	12	M18X1.5
630FSM12X20	12	M20X1.5

Numéro Part number	Tube (mm)	A (mm)																																																
630FSM14X22	14	M22X1.5	639FSMR Bouchon mâle métrique (type Allen screw) Metric male plug (Allen screw type)																																															
630FSM15X22	15	M22X1.5																																																
630FSM16X24	16	M24X1.5																																																
630FSM18X26	18	M26X1.5																																																
630FSM20X30	20	M30X2.0																																																
630FSM22X30	22	M30X2.0																																																
630FSM25X36	25	M36X2.0																																																
630FSM28X36	28	M36X2.0																																																
630FSM30X42	30	M42X2.0																																																
630FSM35X45	35	M45X2.0																																																
630FSM38X52	38	M52X2.0																																																
630FSM42X52	42	M52X2.0																																																
						<table border="1"> <thead> <tr> <th>Numéro Part number</th> <th colspan="2">A (mm)</th> </tr> </thead> <tbody> <tr> <td>639FSMR10</td> <td colspan="2">M10X1.0</td> </tr> <tr> <td>639FSMR12</td> <td colspan="2">M12X1.5</td> </tr> <tr> <td>639FSMR14</td> <td colspan="2">M14X1.5</td> </tr> <tr> <td>639FSMR16</td> <td colspan="2">M16X1.5</td> </tr> <tr> <td>639FSMR18</td> <td colspan="2">M18X1.5</td> </tr> <tr> <td>639FSMR20</td> <td colspan="2">M20X1.5</td> </tr> <tr> <td>639FSMR22</td> <td colspan="2">M22X1.5</td> </tr> <tr> <td>639FSMR26</td> <td colspan="2">M26X1.5</td> </tr> <tr> <td>639FSMR27</td> <td colspan="2">M27X2.0</td> </tr> <tr> <td>639FSMR30</td> <td colspan="2">M30X2.0</td> </tr> <tr> <td>639FSMR33</td> <td colspan="2">M33X2.0</td> </tr> <tr> <td>639FSMR36</td> <td colspan="2">M36X2.0</td> </tr> <tr> <td>639FSMR42</td> <td colspan="2">M42X2.0</td> </tr> </tbody> </table>			Numéro Part number	A (mm)		639FSMR10	M10X1.0		639FSMR12	M12X1.5		639FSMR14	M14X1.5		639FSMR16	M16X1.5		639FSMR18	M18X1.5		639FSMR20	M20X1.5		639FSMR22	M22X1.5		639FSMR26	M26X1.5		639FSMR27	M27X2.0		639FSMR30	M30X2.0		639FSMR33	M33X2.0		639FSMR36	M36X2.0		639FSMR42	M42X2.0	
Numéro Part number	A (mm)																																																	
639FSMR10	M10X1.0																																																	
639FSMR12	M12X1.5																																																	
639FSMR14	M14X1.5																																																	
639FSMR16	M16X1.5																																																	
639FSMR18	M18X1.5																																																	
639FSMR20	M20X1.5																																																	
639FSMR22	M22X1.5																																																	
639FSMR26	M26X1.5																																																	
639FSMR27	M27X2.0																																																	
639FSMR30	M30X2.0																																																	
639FSMR33	M33X2.0																																																	
639FSMR36	M36X2.0																																																	
639FSMR42	M42X2.0																																																	
Numéro Part number	Tube (mm)	A (mm)																																																
639FSM06X12	6	M12X1.5	639FSMO Bouchon mâle o'ring boss métrique O'ring boss metric male plug																																															
639FSM06X14	6	M14X1.5																																																
639FSM08X14	8	M14X1.5																																																
639FSM08X16	8	M16X1.5																																																
639FSM10X1.0	----	M10X1.0																																																
639FSM10X16	10	M16X1.5																																																
639FSM10X18	10	M18X1.5																																																
639FSM12X18	12	M18X1.5																																																
639FSM12X20	12	M20X1.5																																																
639FSM14X22	14	M22X1.5																																																
639FSM15X22	15	M22X1.5																																																
639FSM16X24	16	M24X1.5																																																
639FSM18X26	18	M26X1.5																																																
639FSM20X30	20	M30X2.0																																																
639FSM22X30	22	M30X2.0																																																
639FSM25X36	25	M36X2.0																																																
639FSM28X36	28	M36X2.0																																																
639FSM30X42	30	M42X2.0																																																
639FSM35X45	35	M45X2.0																																																
639FSM38X52	38	M52X2.0																																																
639FSM42X52	42	M52X2.0																																																
<table border="1"> <thead> <tr> <th>Numéro Part number</th> <th>A (mm)</th> <th>O'ring</th> </tr> </thead> <tbody> <tr> <td>639FSMO08</td> <td>M8X1.0</td> <td>710FSM08</td> </tr> <tr> <td>639FSMO10</td> <td>M10X1.0</td> <td>710FSM10</td> </tr> <tr> <td>639FSMO12</td> <td>M12X1.5</td> <td>710FSM12</td> </tr> <tr> <td>639FSMO14</td> <td>M14X1.5</td> <td>710FSM14</td> </tr> <tr> <td>639FSMO16</td> <td>M16X1.5</td> <td>710FSM16</td> </tr> <tr> <td>639FSMO18</td> <td>M18X1.5</td> <td>710FSM18</td> </tr> <tr> <td>639FSMO22</td> <td>M22X1.5</td> <td>710FSM22</td> </tr> <tr> <td>639FSMO27</td> <td>M27X2.0</td> <td>710FSM27</td> </tr> <tr> <td>639FSMO30</td> <td>M30X2.0</td> <td>710FSM30</td> </tr> <tr> <td>639FSMO33</td> <td>M33X2.0</td> <td>710FSM33</td> </tr> <tr> <td>639FSMO42</td> <td>M42X2.0</td> <td>710FSM42</td> </tr> <tr> <td>639FSMO48</td> <td>M48X2.0</td> <td>710FSM48</td> </tr> <tr> <td>639FSMO60</td> <td>M60X2.0</td> <td>710FSM60</td> </tr> </tbody> </table>						Numéro Part number	A (mm)	O'ring	639FSMO08	M8X1.0	710FSM08	639FSMO10	M10X1.0	710FSM10	639FSMO12	M12X1.5	710FSM12	639FSMO14	M14X1.5	710FSM14	639FSMO16	M16X1.5	710FSM16	639FSMO18	M18X1.5	710FSM18	639FSMO22	M22X1.5	710FSM22	639FSMO27	M27X2.0	710FSM27	639FSMO30	M30X2.0	710FSM30	639FSMO33	M33X2.0	710FSM33	639FSMO42	M42X2.0	710FSM42	639FSMO48	M48X2.0	710FSM48	639FSMO60	M60X2.0	710FSM60			
Numéro Part number	A (mm)	O'ring																																																
639FSMO08	M8X1.0	710FSM08																																																
639FSMO10	M10X1.0	710FSM10																																																
639FSMO12	M12X1.5	710FSM12																																																
639FSMO14	M14X1.5	710FSM14																																																
639FSMO16	M16X1.5	710FSM16																																																
639FSMO18	M18X1.5	710FSM18																																																
639FSMO22	M22X1.5	710FSM22																																																
639FSMO27	M27X2.0	710FSM27																																																
639FSMO30	M30X2.0	710FSM30																																																
639FSMO33	M33X2.0	710FSM33																																																
639FSMO42	M42X2.0	710FSM42																																																
639FSMO48	M48X2.0	710FSM48																																																
639FSMO60	M60X2.0	710FSM60																																																

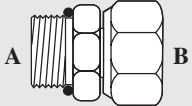
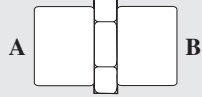
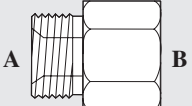
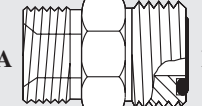
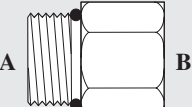
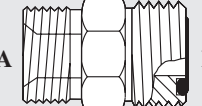
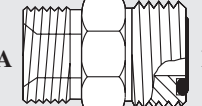
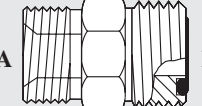
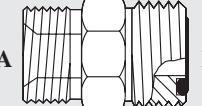
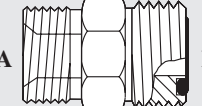
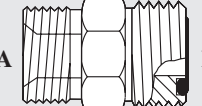
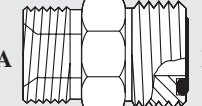
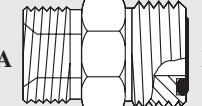
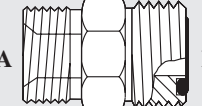
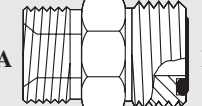
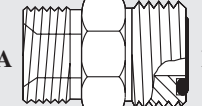
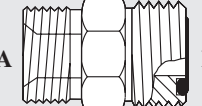
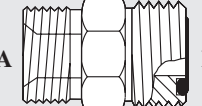
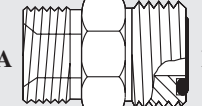
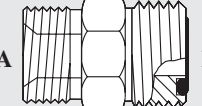
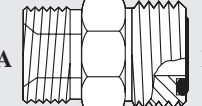
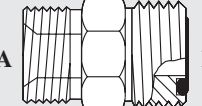
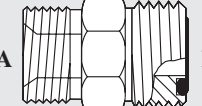
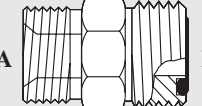
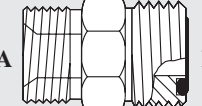
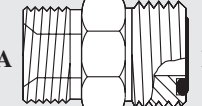
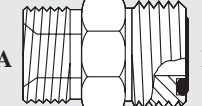
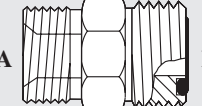
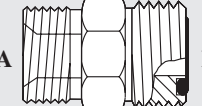
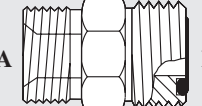
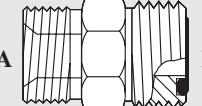
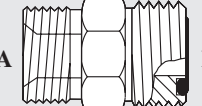
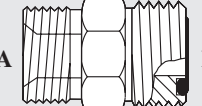
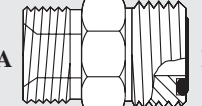
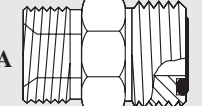
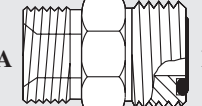
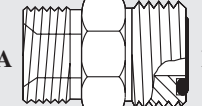
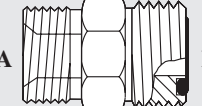
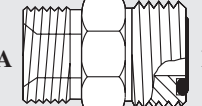
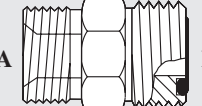
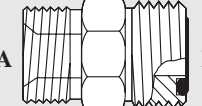
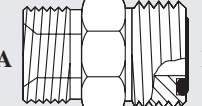
 <p>630FSK Bouchon femelle Komatsu Komatsu female plug</p>				Numéro Part number	A (mm)	B (mm)	Joint d'étanchéité Bonded seal				
				642FSM24X24	M24X1.5	M24X1.5	710BSM24				
				642FSM26X18	M26X1.5	M18X1.5	710BSM18				
				642FSM26X22	M26X1.5	M22X1.5	710BSM22				
				642FSM26X26	M26X1.5	M26X1.5	710BSM26				
Numéro Part number				 <p>642FSK Mâle Komatsu / Mâle Komatsu Male Komatsu / Male Komatsu</p>							
Numéro Part number				A (mm)	B (mm)						
630FSK14				M14X1.5	M14X1.5						
630FSK18				M18X1.5	M18X1.5						
630FSK22				M22X1.5	M22X1.5						
630FSK24				M24X1.5	M24X1.5						
630FSK30				M30X1.5	M30X1.5						
630FSK33				M33X1.5	M33X1.5						
 <p>639FSK Bouchon mâle Komatsu Komatsu male plug</p>				Numéro Part number	A (mm)	B (mm)					
				642FSK14X14	M14X1.5	M14X1.5					
				642FSK18X18	M18X1.5	M18X1.5					
				642FSK22X22	M22X1.5	M22X1.5					
				642FSK24X24	M24X1.5	M24X1.5					
				642FSK30X30	M30X1.5	M30X1.5					
				642FSK33X33	M33X1.5	M33X1.5					
 <p>680FSM Femelle métrique tournant / Femelle métrique tournant Female metric swivel / Female metric swivel</p>				Numéro Part number	A (mm)	Tube (mm)					
				680FSM14	M14X1.5	8					
				680FSM16	M16X1.5	10					
				680FSM18	M18X1.5	12					
				680FSM20	M20X1.5	12					
				680FSM26	M26X1.5	18					
				680FSM30	M30X2.0	22					
 <p>642FSM Mâle métrique / Mâle métrique Male metric / Male metric</p>				Numéro Part number	A (mm)	B (mm)	Joint d'étanchéité Bonded seal				
				642FSM10X10	M10X1.5	M10X1.5	710BSM10				
				642FSM12X10	M12X1.5	M10X1.5	710BSM10				
				642FSM12X12	M12X1.5	M12X1.5	710BSM12				
				642FSM14X12	M14X1.5	M12X1.5	710BSM12				
				642FSM14X14	M14X1.5	M14X1.5	710BSM14				
				642FSM16X12	M16X1.5	M12X1.5	710BSM12				
				642FSM16X14	M16X1.5	M14X1.5	710BSM14				
				642FSM16X16	M16X1.5	M16X1.5	710BSM16				
				642FSM18X16	M18X1.5	M16X1.5	710BSM16				
				642FSM18X18	M18X1.5	M18X1.5	710BSM18				
				642FSM20X18	M20X1.5	M18X1.5	710BSM18				
				642FSM22X18	M22X1.5	M18X1.5	710BSM18				
				642FSM22X22	M22X1.5	M22X1.5	710BSM22				
				642FSM24X22	M24X1.5	M22X1.5	710BSM22				
				 <p>683FSML Mâle métrique / Femelle métrique tournant (légère) Male metric / Female metric swivel (light)</p>				Numéro Part number	A (mm)	B (mm)	Tube (mm)
								683FSML10X12	M10X1.0	M12X1.5	6
683FSML12X14	M12X1.5	M14X1.5	8								
683FSML14X16	M14X1.5	M16X1.5	10								
683FSML16X18	M16X1.5	M18X1.5	12								
683FSML18X22	M18X1.5	M22X1.5	15								
683FSML22X26	M22X1.5	M26X1.5	18								

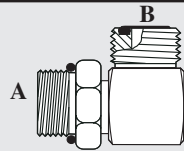
 <p>683FSMH Mâle métrique / Femelle métrique tournant (lourde) Male metric / Female metric swivel (heavy)</p>				Numéro Part number	A (mm)	Joint d'étanchéité Bonded seal	B (")	
				626FSO22X10	M22X1.5	710BSM22	5/8	
				626FSO26X12	M26X1.5	710BSM26	3/4	
				626FSO30X16	M30X2.0	710BSM30	1	
 <p>623FSO Femelle métrique fixe / Femelle o'ring boss Female metric solid / Female o'ring boss</p>				Numéro Part number	A (mm)	B (")		
 <p>683FSMS Mâle métrique / Femelle métrique fixe Male metric / Female metric solid</p>				623FSO20X08	M20X1.5	1/2		
 <p>618TT Mâle métrique (légère) / Mâle o'ring face Male metric (light) / Male o'ring face</p>				623FSO22X08	M22X1.5	1/2		
 <p>626FSO Mâle métrique / Femelle o'ring boss Male metric / Female o'ring boss</p>				623FSO24X08	M24X1.5	1/2		
 <p>618TT Mâle métrique (légère) / Mâle o'ring face Male metric (light) / Male o'ring face</p>				623FSO26X10	M26X1.5	5/8		
 <p>618TT Mâle métrique (légère) / Mâle o'ring face Male metric (light) / Male o'ring face</p>				623FSO30X12	M30X2.0	3/4		
 <p>618TT Mâle métrique (légère) / Mâle o'ring face Male metric (light) / Male o'ring face</p>				Numéro Part number	A (mm)	Tube mm	B (")	
 <p>618TT Mâle métrique (légère) / Mâle o'ring face Male metric (light) / Male o'ring face</p>				683FSMS08X06	M8X1.0	710BSM08	M6X1.0	1/4
 <p>618TT Mâle métrique (légère) / Mâle o'ring face Male metric (light) / Male o'ring face</p>				683FSMS10X08	M10X1.0	710BSM10	M8X1.0	1/4
 <p>618TT Mâle métrique (légère) / Mâle o'ring face Male metric (light) / Male o'ring face</p>				683FSMS14X10	M14X1.5	710BSM14	M10X1.0	3/8
 <p>618TT Mâle métrique (légère) / Mâle o'ring face Male metric (light) / Male o'ring face</p>				683FSMS16X12	M16X1.5	710BSM16	M12X1.5	3/8
 <p>618TT Mâle métrique (légère) / Mâle o'ring face Male metric (light) / Male o'ring face</p>				683FSMS18X14	M18X1.5	710BSM18	M14X1.5	3/8
 <p>618TT Mâle métrique (légère) / Mâle o'ring face Male metric (light) / Male o'ring face</p>				683FSMS20X16	M20X1.5	710BSM20	M16X1.5	1/2
 <p>618TT Mâle métrique (légère) / Mâle o'ring face Male metric (light) / Male o'ring face</p>				683FSMS22X18	M22X1.5	710BSM22	M18X1.5	1/2
 <p>618TT Mâle métrique (légère) / Mâle o'ring face Male metric (light) / Male o'ring face</p>				683FSMS24X20	M24X1.5	710BSM24	M20X1.5	3/4
 <p>618TT Mâle métrique (légère) / Mâle o'ring face Male metric (light) / Male o'ring face</p>				683FSMS26X22	M26X1.5	710BSM26	M22X1.5	3/4
 <p>618TT Mâle métrique (légère) / Mâle o'ring face Male metric (light) / Male o'ring face</p>				683FSMS30X26	M30X1.5	710BSM30	M26X1.5	3/4
 <p>618TT Mâle métrique (légère) / Mâle o'ring face Male metric (light) / Male o'ring face</p>				618TT12X04	M12X1.5	6	1/4	
 <p>618TT Mâle métrique (légère) / Mâle o'ring face Male metric (light) / Male o'ring face</p>				618TT14X04	M14X1.5	8	1/4	
 <p>618TT Mâle métrique (légère) / Mâle o'ring face Male metric (light) / Male o'ring face</p>				618TT14X06	M14X1.5	8	3/8	
 <p>618TT Mâle métrique (légère) / Mâle o'ring face Male metric (light) / Male o'ring face</p>				618TT16X08	M16X1.5	10	1/2	
 <p>618TT Mâle métrique (légère) / Mâle o'ring face Male metric (light) / Male o'ring face</p>				618TT18X06	M18X1.5	12	3/8	
 <p>618TT Mâle métrique (légère) / Mâle o'ring face Male metric (light) / Male o'ring face</p>				618TT18X08	M18X1.5	12	1/2	
 <p>618TT Mâle métrique (légère) / Mâle o'ring face Male metric (light) / Male o'ring face</p>				618TT18X12	M18X1.5	12	3/4	
 <p>618TT Mâle métrique (légère) / Mâle o'ring face Male metric (light) / Male o'ring face</p>				618TT22X08	M22X1.5	15	1/2	
 <p>618TT Mâle métrique (légère) / Mâle o'ring face Male metric (light) / Male o'ring face</p>				618TT22X12	M22X1.5	15	3/4	
 <p>618TT Mâle métrique (légère) / Mâle o'ring face Male metric (light) / Male o'ring face</p>				618TT26X12	M26X1.5	18	3/4	
 <p>618TT Mâle métrique (légère) / Mâle o'ring face Male metric (light) / Male o'ring face</p>				618TT27X12	M27X2.0	----	3/4	
 <p>618TT Mâle métrique (légère) / Mâle o'ring face Male metric (light) / Male o'ring face</p>				618TT30X12	M30X2.0	22	3/4	
 <p>618TT Mâle métrique (légère) / Mâle o'ring face Male metric (light) / Male o'ring face</p>				618TT30X16	M30X2.0	22	1	
 <p>618TT Mâle métrique (légère) / Mâle o'ring face Male metric (light) / Male o'ring face</p>				Numéro Part number	A (mm)	Joint d'étanchéité Bonded seal	B (")	
 <p>618TT Mâle métrique (légère) / Mâle o'ring face Male metric (light) / Male o'ring face</p>				626FSO08X04	M8X1.0	710BSM08	1/4	
 <p>618TT Mâle métrique (légère) / Mâle o'ring face Male metric (light) / Male o'ring face</p>				626FSO10X04	M10X1.0	710BSM10	1/4	
 <p>618TT Mâle métrique (légère) / Mâle o'ring face Male metric (light) / Male o'ring face</p>				626FSO12X04	M12X1.0	710BSM12	1/4	
 <p>618TT Mâle métrique (légère) / Mâle o'ring face Male metric (light) / Male o'ring face</p>				626FSO12X06	M12X1.0	710BSM12	3/8	
 <p>618TT Mâle métrique (légère) / Mâle o'ring face Male metric (light) / Male o'ring face</p>				626FSO14X06	M14X1.5	710BSM14	3/8	
 <p>618TT Mâle métrique (légère) / Mâle o'ring face Male metric (light) / Male o'ring face</p>				626FSO16X06	M16X1.5	710BSM16	3/8	
 <p>618TT Mâle métrique (légère) / Mâle o'ring face Male metric (light) / Male o'ring face</p>				626FSO16X08	M16X1.5	710BSM16	1/2	
 <p>618TT Mâle métrique (légère) / Mâle o'ring face Male metric (light) / Male o'ring face</p>				626FSO18X08	M18X1.5	710BSM18	1/2	
 <p>618TT Mâle métrique (légère) / Mâle o'ring face Male metric (light) / Male o'ring face</p>				626FSO20X08	M20X1.5	710BSM20	1/2	
 <p>618TT Mâle métrique (légère) / Mâle o'ring face Male metric (light) / Male o'ring face</p>				626FSO22X06	M22X1.5	710BSM22	3/8	

619TT
Mâle métrique ajustable / Mâle o'ring face
Male metric adjustable / Male o'ring face

Numéro Part number	A (mm)	Joint d'étanchéité Bonded seal	B (")
619TT10X04	M10X1.0	710BSM10	1/4
619TT12X04	M12X1.5	710BSM12	1/4
619TT14X06	M14X1.5	710BSM14	3/8
619TT16X06	M16X1.5	710BSM16	3/8
619TT16X08	M16X1.5	710BSM16	1/2
619TT18X08	M18X1.5	710BSM18	1/2
619TT18X10	M18X1.5	710BSM18	5/8
619TT22X10	M22X1.5	710BSM22	5/8
619TT27X12	M27X2.0	710SBM27	3/4
619TT33X16	M33X2.0	710BSM33	1

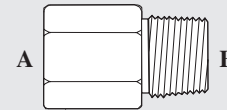
622FS
Femelle métrique fixe / Mâle NPTF
Female metric solid / Male NPTF

Numéro Part number	A (mm)	B (")
622FS06X02	M6X1.0	1/8
622FS08X02	M8X1.0	1/8
622FS1010X02	M10X1.0	1/8
622FS1012X02	M10X1.25	1/8
622FS1015X02	M10X1.5	1/8
622FS1210X02	M12X1.0	1/8
622FS1215X02	M12X1.5	1/8
622FS14X06	M14X1.5	3/8
622FS14X08	M14X1.5	1/2
622FS16X04	M16X1.5	1/4
622FS16X06	M16X1.5	3/8
622FS18X06	M18X1.5	3/8
622FS20X08	M20X1.5	1/2
622FS22X08	M22X1.5	1/2
622FS24X08	M24X1.5	1/2
622FS26X12	M26X1.5	3/4
622FS3015X12	M30X1.5	3/4
622FS3020X12	M30X2.0	3/4

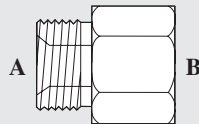



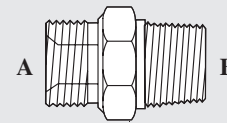

626FS
Mâle métrique / Femelle NPTF
Male metric / Female NPTF

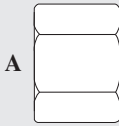
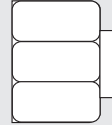
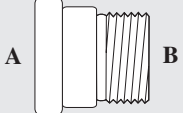
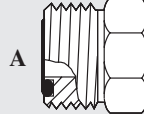
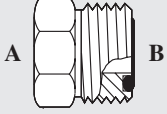
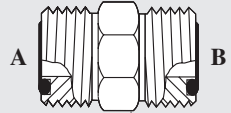
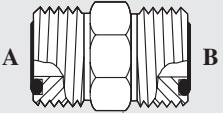
Numéro Part number	A (mm)	Joint d'étanchéité Bonded seal	B (")
626FS08X02	M8X1.0	710BSM08	1/8
626FS10X02	M10X1.0	710BSM10	1/8
626FS12X04	M12X1.5	710BSM12	1/4
626FS14X04	M14X1.5	710BSM14	1/4
626FS16X06	M16X1.5	710BSM16	3/8
626FS16X08	M16X1.5	710BSM16	1/2
626FS18X06	M18X1.5	710BSM18	3/8
626FS18X08	M18X1.5	710BSM18	1/2
626FS22X06	M22X1.5	710SBM22	3/8
626FS22X08	M22X1.5	710BSM22	1/2
626FS22X12	M22X1.5	710BSM22	3/4
626FS24X12	M24X1.5	710BSM24	3/4
626FS26X12	M26X1.5	710BSM26	3/4
626FS27X12	M27X2.0	710BSM27	3/4

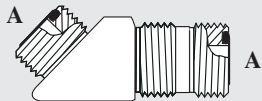
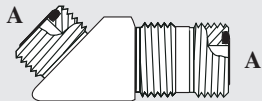
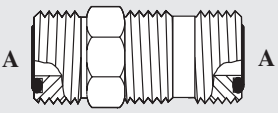
628FS
Mâle métrique / Mâle NPTF
Male metric / Male NPTF

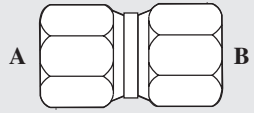
Numéro Part number	A (mm)	Bonded seal	B (")
628FS12X02	M12X1.5	710BSM12	1/8
628FS16X06	M16X1.5	710BSM16	3/8
628FS18X06	M18X1.5	710BSM18	3/8
628FS20X08	M20X1.5	710BSM20	1/2
628FS22X08	M22X1.5	710BSM22	1/2
628FS26X08	M26X1.5	710BSM26	1/2
628FS26X12	M26X1.5	710SBM26	3/4
628FS30X12	M30X2.0	710BSM30	3/4
628FS30X16	M30X2.0	710BSM30	1

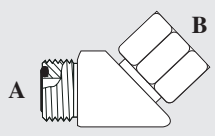
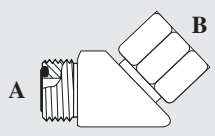
ORFS (O'RING FACE)					Numéro Part number	A (")	B (")	O'ring						
					883TTR16X20	1	1-1/4	710TTO20						
					883TTR16X24	1	1-1/2	710TTO24						
					883TTR20X24	1-1/4	1-1/2	710TTO24						
														
841TT Écrou o'ring face O'ring face nut					830TT Bouchon femelle o'ring face O'ring face female plug									
Numéro Part number	A (")				Numéro Part number	A (")								
841TT06	3/8				830TT04	1/4								
841TT08	1/2				830TT06	3/8								
841TT10	5/8				830TT08	1/2								
841TT12	3/4				830TT10	5/8								
841TT16	1				830TT12	3/4								
					883TT Femelle o'ring face tournant / Mâle o'ring face Female o'ring face swivel / Male o'ring face									
					Numéro Part number	A (")	Écrou Nut	B (")	O'ring					
					883TT08X04	1/2	841TT08	1/4	710TTO04					
					883TT08X06	1/2	841TT08	3/8	710TTO06					
					883TT10X04	5/8	841TT10	1/4	710TTO04					
					883TT10X06	5/8	841TT10	3/8	710TTO06					
					883TT10X08	5/8	841TT10	1/2	710TTO08					
					883TT12X08	3/4	841TT12	1/2	710TTO08					
					883TT16X08	1	841TT16	1/2	710TTO08					
					883TT16X10	1	841TT16	5/8	710TTO10					
883TT20X16	1-1/4	841TT20	1	710TTO16										
					883TTR Femelle o'ring face fixe/ Mâle o'ring face Female o'ring face solid / Male o'ring face									
					Numéro Part number	A (")	B (")	O'ring						
					883TTR04X06	1/4	3/8	710TTO06						
					883TTR06X08	3/8	1/2	710TTO08						
					883TTR06X10	3/8	5/8	710TTO10						
					883TTR08X10	1/2	5/8	710TTO10						
					883TTR08X12	1/2	3/4	710TTO12						
					883TTR08X16	1/2	1	710TTO16						
					883TTR10X12	5/8	3/4	710TTO12						
					883TTR10X16	5/8	1	710TTO16						
883TTR12X16	3/4	1	710TTO16											
883TTR12X20	3/4	1-1/4	710TTO20											
					842TT Mâle o'ring face / Mâle o'ring face Male o'ring face / Male o'ring face									
					Numéro Part number	A (")	O'ring	B (")	O'ring					
					842TT04X04	1/4	710TTO04	1/4	710TTO04					
					842TT06X04	3/8	710TTO06	1/4	710TTO04					
					842TT06X06	3/8	710TTO06	3/8	710TTO06					
					842TT08X06	1/2	710TTO08	3/8	710TTO06					
					842TT08X08	1/2	710TTO08	1/2	710TTO08					

Numéro Part number	A (")	O'ring	B (")	O'ring	Numéro Part number	A (")	O'ring	B (")																																																								
842TT10X08	5/8	710TTO10	1/2	710TTO08	889TT08X08	1/2	710TTO08	1/2																																																								
842TT10X10	5/8	710TTO10	5/8	710TTO10	889TT10X10	5/8	710TTO10	5/8																																																								
842TT12X08	3/4	710TTO12	1/2	710TTO08	889TT12X12	3/4	710TTO12	3/4																																																								
842TT12X10	3/4	710TTO12	5/8	710TTO10	889TT16X16	1	710TTO16	1																																																								
842TT12X12	3/4	710TTO12	3/4	710TTO12	889TT20X20	1-1/4	710TTO20	1-1/4																																																								
842TT16X12	1	710TTO16	3/4	710TTO12																																																												
842TT16X16	1	710TTO16	1	710TTO16																																																												
842TT20X20	1-1/4	710TTO20	1-1/4	710TTO20																																																												
842TT24X24	1-1/2	710TTO24	1-1/2	710TTO24																																																												
					854BHTT Mâle o'ring face / Mâle o'ring face cloison Male o'ring face / Male o'ring face bulkhead																																																											
					Numéro Part number	A (")	O'ring	Écrou Nut																																																								
832TT Mâle o'ring face / Mâle o'ring face cloison Male o'ring face / Male o'ring face bulkhead					854BHTT04	1/4	710TTO04	711TTO04																																																								
					854BHTT06	3/8	710TTO06	711TTO06																																																								
<table border="1"> <thead> <tr> <th>Numéro Part number</th> <th>A (")</th> <th>O'ring</th> <th>Écrou Nut</th> </tr> </thead> <tbody> <tr> <td>832TT04</td> <td>1/4</td> <td>710TTO04</td> <td>711TTO04</td> </tr> <tr> <td>832TT06</td> <td>3/8</td> <td>710TTO06</td> <td>711TTO06</td> </tr> <tr> <td>832TT08</td> <td>1/2</td> <td>710TTO08</td> <td>711TTO08</td> </tr> <tr> <td>832TT10</td> <td>5/8</td> <td>710TTO10</td> <td>711TTO10</td> </tr> <tr> <td>832TT12</td> <td>3/4</td> <td>710TTO12</td> <td>711TTO12</td> </tr> <tr> <td>832TT16</td> <td>1</td> <td>710TTO16</td> <td>711TTO16</td> </tr> <tr> <td>832TT20</td> <td>1-1/4</td> <td>710TTO20</td> <td>711TTO20</td> </tr> <tr> <td>832TT24</td> <td>1-1/2</td> <td>710TTO24</td> <td>711TTO24</td> </tr> </tbody> </table>					Numéro Part number	A (")	O'ring	Écrou Nut	832TT04	1/4	710TTO04	711TTO04	832TT06	3/8	710TTO06	711TTO06	832TT08	1/2	710TTO08	711TTO08	832TT10	5/8	710TTO10	711TTO10	832TT12	3/4	710TTO12	711TTO12	832TT16	1	710TTO16	711TTO16	832TT20	1-1/4	710TTO20	711TTO20	832TT24	1-1/2	710TTO24	711TTO24	854BHTT08	1/2	710TTO08	711TTO08																				
					Numéro Part number	A (")	O'ring	Écrou Nut																																																								
832TT04	1/4	710TTO04	711TTO04																																																													
832TT06	3/8	710TTO06	711TTO06																																																													
832TT08	1/2	710TTO08	711TTO08																																																													
832TT10	5/8	710TTO10	711TTO10																																																													
832TT12	3/4	710TTO12	711TTO12																																																													
832TT16	1	710TTO16	711TTO16																																																													
832TT20	1-1/4	710TTO20	711TTO20																																																													
832TT24	1-1/2	710TTO24	711TTO24																																																													
					854BHTT10	5/8	710TTO10	711TTO10																																																								
					854BHTT12	3/4	710TTO12	711TTO12																																																								
855TT Mâle o'ring face / Mâle o'ring face Male o'ring face / Male o'ring face					854BHTT16	1	710TTO16	711TTO16																																																								
					854BHTT20	1-1/4	710TTO20	711TTO20																																																								
					854BHTT24	1-1/2	710TTO24	711TTO24																																																								
					<table border="1"> <thead> <tr> <th>Numéro Part number</th> <th>A (")</th> <th>O'ring</th> <th>B (")</th> <th>O'ring</th> </tr> </thead> <tbody> <tr> <td>855TT04X04</td> <td>1/4</td> <td>710TTO04</td> <td>1/4</td> <td>710TTO04</td> </tr> <tr> <td>855TT06X04</td> <td>3/8</td> <td>710TTO06</td> <td>1/4</td> <td>710TTO04</td> </tr> <tr> <td>855TT06X06</td> <td>3/8</td> <td>710TTO06</td> <td>3/8</td> <td>710TTO06</td> </tr> <tr> <td>855TT08X04</td> <td>1/2</td> <td>710TTO08</td> <td>1/4</td> <td>710TTO04</td> </tr> <tr> <td>855TT08X06</td> <td>1/2</td> <td>710TTO08</td> <td>3/8</td> <td>710TTO06</td> </tr> <tr> <td>855TT08X08</td> <td>1/2</td> <td>710TTO08</td> <td>1/2</td> <td>710TTO08</td> </tr> <tr> <td>855TT10X10</td> <td>5/8</td> <td>710TTO10</td> <td>5/8</td> <td>710TTO10</td> </tr> <tr> <td>855TT12X12</td> <td>3/4</td> <td>710TTO12</td> <td>3/4</td> <td>710TTO12</td> </tr> <tr> <td>855TT16X16</td> <td>1</td> <td>710TTO16</td> <td>1</td> <td>710TTO16</td> </tr> <tr> <td>855TT20X20</td> <td>1-1/4</td> <td>710TTO20</td> <td>1-1/4</td> <td>710TTO20</td> </tr> <tr> <td>855TT24X24</td> <td>1-1/2</td> <td>710TTO24</td> <td>1-1/2</td> <td>710TTO24</td> </tr> </tbody> </table>					Numéro Part number	A (")	O'ring	B (")	O'ring	855TT04X04	1/4	710TTO04	1/4	710TTO04	855TT06X04	3/8	710TTO06	1/4	710TTO04	855TT06X06	3/8	710TTO06	3/8	710TTO06	855TT08X04	1/2	710TTO08	1/4	710TTO04	855TT08X06	1/2	710TTO08	3/8	710TTO06	855TT08X08	1/2	710TTO08	1/2	710TTO08	855TT10X10	5/8	710TTO10	5/8	710TTO10	855TT12X12	3/4	710TTO12	3/4	710TTO12	855TT16X16	1	710TTO16	1	710TTO16	855TT20X20	1-1/4	710TTO20	1-1/4	710TTO20
Numéro Part number	A (")	O'ring	B (")	O'ring																																																												
855TT04X04	1/4	710TTO04	1/4	710TTO04																																																												
855TT06X04	3/8	710TTO06	1/4	710TTO04																																																												
855TT06X06	3/8	710TTO06	3/8	710TTO06																																																												
855TT08X04	1/2	710TTO08	1/4	710TTO04																																																												
855TT08X06	1/2	710TTO08	3/8	710TTO06																																																												
855TT08X08	1/2	710TTO08	1/2	710TTO08																																																												
855TT10X10	5/8	710TTO10	5/8	710TTO10																																																												
855TT12X12	3/4	710TTO12	3/4	710TTO12																																																												
855TT16X16	1	710TTO16	1	710TTO16																																																												
855TT20X20	1-1/4	710TTO20	1-1/4	710TTO20																																																												
855TT24X24	1-1/2	710TTO24	1-1/2	710TTO24																																																												
880TT Femelle o'ring face tournant / Femelle o'ring face tournant Female o'ring face swivel / Female o'ring face swivel																																																																
					Numéro Part number	A (")	B (")																																																									
					880TT04X04	1/4	1/4																																																									
					880TT06X06	3/8	3/8																																																									
889TT Mâle o'ring face / Femelle o'ring face tournant Male o'ring face / Female o'ring face swivel					880TT08X08	1/2	1/2																																																									
					880TT12X12	3/4	3/4																																																									
<table border="1"> <thead> <tr> <th>Numéro Part number</th> <th>A (")</th> <th>O'ring</th> <th>B (")</th> </tr> </thead> <tbody> <tr> <td>889TT04X04</td> <td>1/4</td> <td>710TTO04</td> <td>1/4</td> </tr> <tr> <td>889TT06X06</td> <td>3/8</td> <td>710TTO06</td> <td>3/8</td> </tr> </tbody> </table>					Numéro Part number	A (")	O'ring	B (")	889TT04X04	1/4	710TTO04	1/4	889TT06X06	3/8	710TTO06	3/8	880TT16X16	1	1																																													
					Numéro Part number	A (")	O'ring	B (")																																																								
889TT04X04	1/4	710TTO04	1/4																																																													
889TT06X06	3/8	710TTO06	3/8																																																													
<table border="1"> <thead> <tr> <th>Numéro Part number</th> <th>A (")</th> <th>O'ring</th> <th>B (")</th> </tr> </thead> <tbody> <tr> <td>889TT04X04</td> <td>1/4</td> <td>710TTO04</td> <td>1/4</td> </tr> <tr> <td>889TT06X06</td> <td>3/8</td> <td>710TTO06</td> <td>3/8</td> </tr> </tbody> </table>					Numéro Part number	A (")	O'ring	B (")	889TT04X04	1/4	710TTO04	1/4	889TT06X06	3/8	710TTO06	3/8																																																
					Numéro Part number	A (")	O'ring	B (")																																																								
889TT04X04	1/4	710TTO04	1/4																																																													
889TT06X06	3/8	710TTO06	3/8																																																													
<table border="1"> <thead> <tr> <th>Numéro Part number</th> <th>A (")</th> <th>O'ring</th> <th>B (")</th> </tr> </thead> <tbody> <tr> <td>889TT04X04</td> <td>1/4</td> <td>710TTO04</td> <td>1/4</td> </tr> <tr> <td>889TT06X06</td> <td>3/8</td> <td>710TTO06</td> <td>3/8</td> </tr> </tbody> </table>					Numéro Part number	A (")	O'ring	B (")	889TT04X04	1/4	710TTO04	1/4	889TT06X06	3/8	710TTO06	3/8																																																
Numéro Part number	A (")	O'ring	B (")																																																													
889TT04X04	1/4	710TTO04	1/4																																																													
889TT06X06	3/8	710TTO06	3/8																																																													

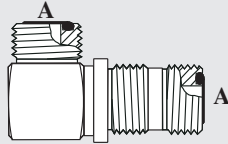
855BH TT

 Mâle o'ring face / Mâle o'ring face cloison
 Male o'ring face / Male o'ring face bulkhead

Numéro Part number	A (")	O'ring	Écrou Nut
855BH TT04	1/4	710TTO04	711TTO04
855BH TT06	3/8	710TTO06	711TTO06
855BH TT08	1/2	710TTO08	711TTO08
855BH TT10	5/8	710TTO10	711TTO10
855BH TT12	3/4	710TTO12	711TTO12
855BH TT16	1	710TTO16	711TTO16
855BH TT20	1-1/4	710TTO20	711TTO20
855BH TT24	1-1/2	710TTO24	711TTO24

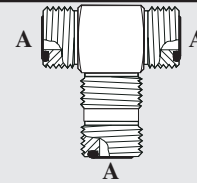
870TT

 Mâle o'ring face / Mâle o'ring face cloison / Mâle o'ring face
 Male o'ring face / Male o'ring face bulkhead / Male o'ring face

Numéro Part number	A (")	O'ring	Écrou Nut
870TT04	1/4	710TTO04	711TTO04
870TT06	3/8	710TTO06	711TTO06
870TT08	1/2	710TTO08	711TTO08
870TT10	5/8	710TTO10	711TTO10
870TT12	3/4	710TTO12	711TTO12
870TT16	1	710TTO16	711TTO16
870TT20	1-1/4	710TTO20	711TTO20

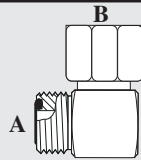
879TT

 Mâle o'ring face / Femelle o'ring face tournant
 Male o'ring face / Female o'ring face swivel

Numéro Part number	A (")	O'ring	B (")
879TT04X04	1/4	710TTO04	1/4
879TT06X06	3/8	710TTO06	3/8
879TT08X08	1/2	710TTO08	1/2
879TT10X10	5/8	710TTO10	5/8
879TT12X12	3/4	710TTO12	3/4
879TT16X16	1	710TTO16	1
879TT20X20	1-1/4	710TTO20	1-1/4
879TT24X24	1-1/2	710TTO24	1-1/2

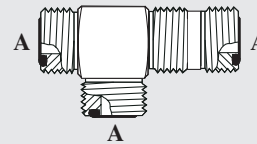
861TT

 Mâle o'ring face / Mâle o'ring face / Mâle o'ring face cloison
 Male o'ring face / Male o'ring face / Male o'ring face bulkhead

Numéro Part number	A (")	O'ring	Écrou Nut
861TT04	1/4	710TTO04	711TTO04
861TT06	3/8	710TTO06	711TTO06
861TT08	1/2	710TTO08	711TTO08
861TT10	5/8	710TTO10	711TTO10
861TT12	3/4	710TTO12	711TTO12
861TT16	1	710TTO16	711TTO16
861TT20	1-1/4	710TTO20	711TTO20

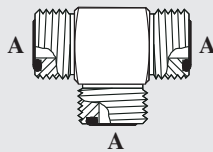
844TT

 Mâle o'ring face / Mâle o'ring face / Mâle o'ring face
 Male o'ring face / Male o'ring face / Male o'ring face

Numéro Part number	A (")	O'ring
844TT04	1/4	710TTO04
844TT06	3/8	710TTO06
844TT08	1/2	710TTO08
844TT10	5/8	710TTO10
844TT12	3/4	710TTO12
844TT16	1	710TTO16
844TT20	1-1/4	710TTO20
844TT24	1-1/2	710TTO24

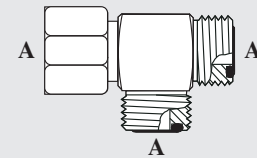
871TT

 Femelle o'ring face tournant/Mâle o'ring face/Mâle o'ring face
 Female o'ring face swivel / Male o'ring face / Male o'ring face

Numéro Part number	A (")	O'ring
871TT04	1/4	710TTO04
871TT06	3/8	710TTO06
871TT08	1/2	710TTO08
871TT10	5/8	710TTO10
871TT12	3/4	710TTO12
871TT16	1	710TTO16

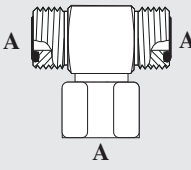
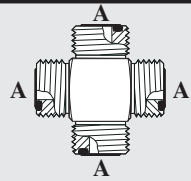
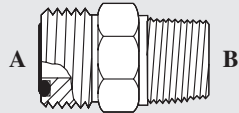
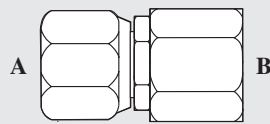
				872TT Mâle o'ring face/Femelle o'ring face tournant/Mâle o'ring face Male o'ring face / Female o'ring face swivel / Male o'ring face																																																																																																			
<table border="1"> <thead> <tr> <th>Numéro Part number</th> <th>A (")</th> <th>O'ring</th> </tr> </thead> <tbody> <tr><td>872TT04</td><td>1/4</td><td>710TTO04</td></tr> <tr><td>872TT06</td><td>3/8</td><td>710TTO06</td></tr> <tr><td>872TT08</td><td>1/2</td><td>710TTO08</td></tr> <tr><td>872TT10</td><td>5/8</td><td>710TTO10</td></tr> <tr><td>872TT12</td><td>3/4</td><td>710TTO12</td></tr> </tbody> </table>		Numéro Part number	A (")	O'ring	872TT04	1/4	710TTO04	872TT06	3/8	710TTO06	872TT08	1/2	710TTO08	872TT10	5/8	710TTO10	872TT12	3/4	710TTO12	<table border="1"> <thead> <tr> <th>Numéro Part number</th> <th>A (")</th> <th>O'ring</th> <th>B (")</th> </tr> </thead> <tbody> <tr><td>848TT12X16</td><td>3/4</td><td>710TTO12</td><td>1</td></tr> <tr><td>848TT16X12</td><td>1</td><td>710TTO16</td><td>3/4</td></tr> <tr><td>848TT16X16</td><td>1</td><td>710TTO16</td><td>1</td></tr> <tr><td>848TT16X20</td><td>1</td><td>710TTO16</td><td>1-1/4</td></tr> <tr><td>848TT20X16</td><td>1-1/4</td><td>710TTO20</td><td>1</td></tr> <tr><td>848TT20X20</td><td>1-1/4</td><td>710TTO20</td><td>1-1/4</td></tr> <tr><td>848TT24X24</td><td>1-1/2</td><td>710TTO24</td><td>1-1/2</td></tr> </tbody> </table>		Numéro Part number	A (")	O'ring	B (")	848TT12X16	3/4	710TTO12	1	848TT16X12	1	710TTO16	3/4	848TT16X16	1	710TTO16	1	848TT16X20	1	710TTO16	1-1/4	848TT20X16	1-1/4	710TTO20	1	848TT20X20	1-1/4	710TTO20	1-1/4	848TT24X24	1-1/2	710TTO24	1-1/2																																																		
Numéro Part number	A (")	O'ring																																																																																																					
872TT04	1/4	710TTO04																																																																																																					
872TT06	3/8	710TTO06																																																																																																					
872TT08	1/2	710TTO08																																																																																																					
872TT10	5/8	710TTO10																																																																																																					
872TT12	3/4	710TTO12																																																																																																					
Numéro Part number	A (")	O'ring	B (")																																																																																																				
848TT12X16	3/4	710TTO12	1																																																																																																				
848TT16X12	1	710TTO16	3/4																																																																																																				
848TT16X16	1	710TTO16	1																																																																																																				
848TT16X20	1	710TTO16	1-1/4																																																																																																				
848TT20X16	1-1/4	710TTO20	1																																																																																																				
848TT20X20	1-1/4	710TTO20	1-1/4																																																																																																				
848TT24X24	1-1/2	710TTO24	1-1/2																																																																																																				
				852TT Croix mâle o'ring face Cross male o'ring face																																																																																																			
<table border="1"> <thead> <tr> <th>Numéro Part number</th> <th>A (")</th> <th>O'ring</th> </tr> </thead> <tbody> <tr><td>852TT04</td><td>1/4</td><td>710TTO04</td></tr> <tr><td>852TT06</td><td>3/8</td><td>710TTO06</td></tr> <tr><td>852TT08</td><td>1/2</td><td>710TTO08</td></tr> <tr><td>852TT10</td><td>5/8</td><td>710TTO10</td></tr> <tr><td>852TT12</td><td>3/4</td><td>710TTO12</td></tr> <tr><td>852TT16</td><td>1</td><td>710TTO16</td></tr> </tbody> </table>		Numéro Part number	A (")	O'ring	852TT04	1/4	710TTO04	852TT06	3/8	710TTO06	852TT08	1/2	710TTO08	852TT10	5/8	710TTO10	852TT12	3/4	710TTO12	852TT16	1	710TTO16	<table border="1"> <thead> <tr> <th>Numéro Part number</th> <th>A (")</th> <th>B (")</th> </tr> </thead> <tbody> <tr><td>881TT04X02</td><td>1/4</td><td>1/8</td></tr> <tr><td>881TT04X04</td><td>1/4</td><td>1/4</td></tr> <tr><td>881TT06X04</td><td>3/8</td><td>1/4</td></tr> <tr><td>881TT06X06</td><td>3/8</td><td>3/8</td></tr> <tr><td>881TT08X08</td><td>1/2</td><td>1/2</td></tr> <tr><td>881TT10X08</td><td>5/8</td><td>1/2</td></tr> <tr><td>881TT12X08</td><td>3/4</td><td>1/2</td></tr> <tr><td>881TT12X12</td><td>3/4</td><td>3/4</td></tr> <tr><td>881TT16X12</td><td>1</td><td>3/4</td></tr> <tr><td>881TT16X16</td><td>1</td><td>1</td></tr> <tr><td>881TT20X16</td><td>1-1/4</td><td>1</td></tr> <tr><td>881TT20X20</td><td>1-1/4</td><td>1-1/4</td></tr> <tr><td>881TT24X24</td><td>1-1/2</td><td>1-1/2</td></tr> </tbody> </table>		Numéro Part number	A (")	B (")	881TT04X02	1/4	1/8	881TT04X04	1/4	1/4	881TT06X04	3/8	1/4	881TT06X06	3/8	3/8	881TT08X08	1/2	1/2	881TT10X08	5/8	1/2	881TT12X08	3/4	1/2	881TT12X12	3/4	3/4	881TT16X12	1	3/4	881TT16X16	1	1	881TT20X16	1-1/4	1	881TT20X20	1-1/4	1-1/4	881TT24X24	1-1/2	1-1/2																																					
Numéro Part number	A (")	O'ring																																																																																																					
852TT04	1/4	710TTO04																																																																																																					
852TT06	3/8	710TTO06																																																																																																					
852TT08	1/2	710TTO08																																																																																																					
852TT10	5/8	710TTO10																																																																																																					
852TT12	3/4	710TTO12																																																																																																					
852TT16	1	710TTO16																																																																																																					
Numéro Part number	A (")	B (")																																																																																																					
881TT04X02	1/4	1/8																																																																																																					
881TT04X04	1/4	1/4																																																																																																					
881TT06X04	3/8	1/4																																																																																																					
881TT06X06	3/8	3/8																																																																																																					
881TT08X08	1/2	1/2																																																																																																					
881TT10X08	5/8	1/2																																																																																																					
881TT12X08	3/4	1/2																																																																																																					
881TT12X12	3/4	3/4																																																																																																					
881TT16X12	1	3/4																																																																																																					
881TT16X16	1	1																																																																																																					
881TT20X16	1-1/4	1																																																																																																					
881TT20X20	1-1/4	1-1/4																																																																																																					
881TT24X24	1-1/2	1-1/2																																																																																																					
				848TT Mâle o'ring face / Mâle NPTF Male o'ring face / Male NPTF																																																																																																			
<table border="1"> <thead> <tr> <th>Numéro Part number</th> <th>A (")</th> <th>O'ring</th> <th>B (")</th> </tr> </thead> <tbody> <tr><td>848TT04X02</td><td>1/4</td><td>710TTO04</td><td>1/8</td></tr> <tr><td>848TT04X04</td><td>1/4</td><td>710TTO04</td><td>1/4</td></tr> <tr><td>848TT04X06</td><td>1/4</td><td>710TTO04</td><td>3/8</td></tr> <tr><td>848TT04X08</td><td>1/4</td><td>710TTO04</td><td>1/2</td></tr> <tr><td>848TT06X04</td><td>3/8</td><td>710TTO06</td><td>1/4</td></tr> <tr><td>848TT06X06</td><td>3/8</td><td>710TTO06</td><td>3/8</td></tr> <tr><td>848TT06X08</td><td>3/8</td><td>710TTO06</td><td>1/2</td></tr> <tr><td>848TT08X04</td><td>1/2</td><td>710TTO08</td><td>1/4</td></tr> <tr><td>848TT08X06</td><td>1/2</td><td>710TTO08</td><td>3/8</td></tr> <tr><td>848TT08X08</td><td>1/2</td><td>710TTO08</td><td>1/2</td></tr> <tr><td>848TT08X12</td><td>1/2</td><td>710TTO08</td><td>3/4</td></tr> <tr><td>848TT10X08</td><td>5/8</td><td>710TTO10</td><td>1/2</td></tr> <tr><td>848TT10X12</td><td>5/8</td><td>710TTO10</td><td>3/4</td></tr> <tr><td>848TT12X08</td><td>3/4</td><td>710TTO12</td><td>1/2</td></tr> <tr><td>848TT12X12</td><td>3/4</td><td>710TTO12</td><td>3/4</td></tr> </tbody> </table>		Numéro Part number	A (")	O'ring	B (")	848TT04X02	1/4	710TTO04	1/8	848TT04X04	1/4	710TTO04	1/4	848TT04X06	1/4	710TTO04	3/8	848TT04X08	1/4	710TTO04	1/2	848TT06X04	3/8	710TTO06	1/4	848TT06X06	3/8	710TTO06	3/8	848TT06X08	3/8	710TTO06	1/2	848TT08X04	1/2	710TTO08	1/4	848TT08X06	1/2	710TTO08	3/8	848TT08X08	1/2	710TTO08	1/2	848TT08X12	1/2	710TTO08	3/4	848TT10X08	5/8	710TTO10	1/2	848TT10X12	5/8	710TTO10	3/4	848TT12X08	3/4	710TTO12	1/2	848TT12X12	3/4	710TTO12	3/4	<table border="1"> <thead> <tr> <th>Numéro Part number</th> <th>A (")</th> <th>B (")</th> </tr> </thead> <tbody> <tr><td>882TT04X02</td><td>1/4</td><td>1/8</td></tr> <tr><td>882TT04X04</td><td>1/4</td><td>1/4</td></tr> <tr><td>882TT06X04</td><td>3/8</td><td>1/4</td></tr> <tr><td>882TT06X06</td><td>3/8</td><td>3/8</td></tr> <tr><td>882TT08X04</td><td>1/2</td><td>1/4</td></tr> <tr><td>882TT08X06</td><td>1/2</td><td>3/8</td></tr> <tr><td>882TT08X08</td><td>1/2</td><td>1/2</td></tr> <tr><td>882TT10X08</td><td>5/8</td><td>1/2</td></tr> <tr><td>882TT12X12</td><td>3/4</td><td>3/4</td></tr> <tr><td>882TT16X16</td><td>1</td><td>1</td></tr> <tr><td>882TT20X20</td><td>1-1/4</td><td>1-1/4</td></tr> </tbody> </table>		Numéro Part number	A (")	B (")	882TT04X02	1/4	1/8	882TT04X04	1/4	1/4	882TT06X04	3/8	1/4	882TT06X06	3/8	3/8	882TT08X04	1/2	1/4	882TT08X06	1/2	3/8	882TT08X08	1/2	1/2	882TT10X08	5/8	1/2	882TT12X12	3/4	3/4	882TT16X16	1	1	882TT20X20	1-1/4	1-1/4
Numéro Part number	A (")	O'ring	B (")																																																																																																				
848TT04X02	1/4	710TTO04	1/8																																																																																																				
848TT04X04	1/4	710TTO04	1/4																																																																																																				
848TT04X06	1/4	710TTO04	3/8																																																																																																				
848TT04X08	1/4	710TTO04	1/2																																																																																																				
848TT06X04	3/8	710TTO06	1/4																																																																																																				
848TT06X06	3/8	710TTO06	3/8																																																																																																				
848TT06X08	3/8	710TTO06	1/2																																																																																																				
848TT08X04	1/2	710TTO08	1/4																																																																																																				
848TT08X06	1/2	710TTO08	3/8																																																																																																				
848TT08X08	1/2	710TTO08	1/2																																																																																																				
848TT08X12	1/2	710TTO08	3/4																																																																																																				
848TT10X08	5/8	710TTO10	1/2																																																																																																				
848TT10X12	5/8	710TTO10	3/4																																																																																																				
848TT12X08	3/4	710TTO12	1/2																																																																																																				
848TT12X12	3/4	710TTO12	3/4																																																																																																				
Numéro Part number	A (")	B (")																																																																																																					
882TT04X02	1/4	1/8																																																																																																					
882TT04X04	1/4	1/4																																																																																																					
882TT06X04	3/8	1/4																																																																																																					
882TT06X06	3/8	3/8																																																																																																					
882TT08X04	1/2	1/4																																																																																																					
882TT08X06	1/2	3/8																																																																																																					
882TT08X08	1/2	1/2																																																																																																					
882TT10X08	5/8	1/2																																																																																																					
882TT12X12	3/4	3/4																																																																																																					
882TT16X16	1	1																																																																																																					
882TT20X20	1-1/4	1-1/4																																																																																																					
				882TT Femelle o'ring face tournant / Mâle NPTF Female o'ring face swivel / Male NPTF																																																																																																			

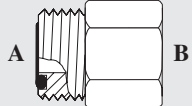
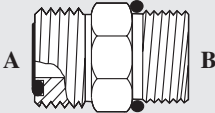
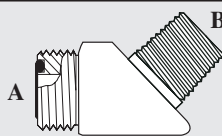
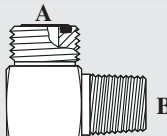
									
846TT Mâle o'ring face / Femelle NPTF Male o'ring face / Female NPTF				Numéro Part number	A (")	O'ring	B (")		
Numéro Part number	A (")	O'ring	B (")						
846TT04X02	1/4	710TTO04	1/8						
846TT04X04	1/4	710TTO04	1/4						
846TT06X04	3/8	710TTO06	1/4						
846TT06X06	3/8	710TTO06	3/8						
846TT06X08	3/8	710TTO06	1/2						
846TT08X06	1/2	710TTO08	3/8						
846TT08X08	1/2	710TTO08	1/2						
846TT08X12	1/2	710TTO08	3/4						
846TT10X08	5/8	710TTO10	1/2						
846TT12X08	3/4	710TTO12	1/2						
846TT12X12	3/4	710TTO12	3/4						
846TT16X16	1	710TTO16	1						
846TT20X20	1-1/4	710TTO20	1-1/4						
									
854TT Mâle o'ring face / Mâle NPTF Male o'ring face / Male NPTF									
Numéro Part number	A (")	O'ring	B (")						
854TT04X04	1/4	710TTO04	1/4						
854TT04X06	1/4	710TTO04	3/8						
854TT06X04	3/8	710TTO06	1/4						
854TT06X06	3/8	710TTO06	3/8						
854TT08X06	1/2	710TTO08	3/8						
854TT08X08	1/2	710TTO08	1/2						
854TT10X08	5/8	710TTO10	1/2						
854TT12X12	3/4	710TTO12	3/4						
854TT12X16	3/4	710TTO12	1						
854TT16X16	1	710TTO16	1						
854TT20X20	1-1/4	710TTO20	1-1/4						
849TT Mâle o'ring face / Mâle NPTF Male o'ring face / Male NPTF									
Numéro Part number	A (")	O'ring	B (")						
849TT04X04	1/4	710TTO04	1/4						
849TT06X02	3/8	710TTO06	1/8						
				Numéro Part number	A (")	O'ring	B (")	O'ring	
				848TTO04X04	1/4	710TTO04	1/4	710FSO04	
				848TTO04X06	1/4	710TTO04	3/8	710FSO06	
				848TTO04X08	1/4	710TTO04	1/2	710FSO08	
				848TTO06X04	3/8	710TTO06	1/4	710FSO04	
				848TTO06X05	3/8	710TTO06	5/16	710FSO05	
				848TTO06X06	3/8	710TTO06	3/8	710FSO06	
				848TTO06X08	3/8	710TTO06	1/2	710FSO08	
				848TTO06X10	3/8	710TTO06	5/8	710FSO10	
				848TTO06X12	3/8	710TTO06	3/4	710FSO12	
				848TTO08X06	1/2	710TTO08	3/8	710FSO06	
				848TTO08X08	1/2	710TTO08	1/2	710FSO08	
				848TTO08X10	1/2	710TTO08	5/8	710FSO10	
				848TTO08X12	1/2	710TTO08	3/4	710FSO12	
				848TTO10X08	5/8	710TTO10	1/2	710FSO08	
				848TTO10X10	5/8	710TTO10	5/8	710FSO10	
				848TTO10X12	5/8	710TTO10	3/4	710FSO12	
				848TTO12X06	3/4	710TTO12	3/8	710FSO06	
				848TTO12X08	3/4	710TTO12	1/2	710FSO08	
				848TTO12X10	3/4	710TTO12	5/8	710FSO10	
				848TTO12X12	3/4	710TTO12	3/4	710FSO12	
				848TTO12X14	3/4	710TTO12	7/8	710FSO14	
				848TTO12X16	3/4	710TTO12	1	710FSO16	
				848TTO16X12	1	710TTO16	3/4	710FSO12	
				848TTO16X16	1	710TTO16	1	710FSO16	
				848TTO16X20	1	710TTO16	1-1/4	710FSO20	
				848TTO20X16	1-1/4	710TTO20	1	710FSO16	
				848TTO20X20	1-1/4	710TTO20	1-1/4	710FSO20	
				848TTO20X24	1-1/4	710TTO20	1-1/2	710FSO24	
				848TTO24X20	1-1/2	710TTO24	1-1/4	710FSO20	
				848TTO24X24	1-1/2	710TTO24	1-1/2	710FSO24	

848LTTO

 Mâle o'ring face / Mâle o'ring boss long
 Male o'ring face / Male o'ring boss long

Numéro Part number	A (")	O'ring	B (")	O'ring
848LTTO04X04	1/4	710TTO04	1/4	710FSO04
848LTTO06X06	3/8	710TTO06	3/8	710FSO06
848LTTO06X08	3/8	710TTO06	1/2	710FSO08
848LTTO08X08	1/2	710TTO08	1/2	710FSO08
848LTTO10X10	5/8	710TTO10	5/8	710FSO10
848LTTO12X12	3/4	710TTO12	3/4	710FSO12
848LTTO16X16	1	710TTO16	1	710FSO16
848LTTO20X20	1-1/4	710TTO20	1-1/4	710FSO20
848LTTO24X24	1-1/2	710TTO24	1-1/2	710FSO24

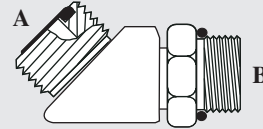
854TTO

 Mâle o'ring face / Mâle o'ring boss ajustable
 Male o'ring face / Male o'ring boss adjustable

Numéro Part number	A (")	O'ring	B (")	O'ring
854TTO04X04	1/4	710TTO04	1/4	710FSO04
854TTO04X06	1/4	710TTO04	3/8	710FSO06
854TTO06X04	3/8	710TTO06	1/4	710FSO04
854TTO06X06	3/8	710TTO06	3/8	710FSO06
854TTO06X08	3/8	710TTO06	1/2	710FSO08
854TTO08X06	1/2	710TTO08	3/8	710FSO06
854TTO08X08	1/2	710TTO08	1/2	710FSO08
854TTO08X10	1/2	710TTO08	5/8	710FSO10
854TTO08X12	1/2	710TTO08	3/4	710FSO12
854TTO10X08	5/8	710TTO10	1/2	710FSO08
854TTO10X10	5/8	710TTO10	5/8	710FSO10
854TTO10X12	5/8	710TTO10	3/4	710FSO12
854TTO12X12	3/4	710TTO12	3/4	710FSO12
854TTO12X16	3/4	710TTO12	1	710FSO16
854TTO16X12	1	710TTO16	3/4	710FSO12
854TTO16X16	1	710TTO16	1	710FSO16
854TTO16X20	1	710TTO16	1-1/4	710FSO20
854TTO20X20	1-1/4	710TTO20	1-1/4	710FSO20
854TTO24X24	1-1/2	710TTO24	1-1/2	710FSO24

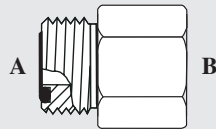
846TTO

 Mâle o'ring face / Femelle o'ring boss
 Male o'ring face / Female o'ring boss

Numéro Part number	A (")	O'ring	B (")
846TTO06X06	3/8	710TTO06	3/8
846TTO08X08	1/2	710TTO08	1/2
846TTO12X12	3/4	710TTO12	3/4

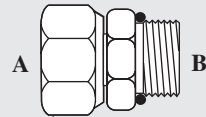
881TTO

 Femelle o'ring face tournant / Mâle o'ring boss
 Female o'ring face swivel / Male o'ring boss

Numéro Part number	A (")	B (")	O'ring
881TTO04X04	1/4	1/4	710FSO04
881TTO04X12	1/4	3/4	710FSO12
881TTO06X06	3/8	3/8	710FSO06
881TTO06X12	3/8	3/4	710FSO12
881TTO08X08	1/2	1/2	710FSO08
881TTO08X10	1/2	5/8	710FSO10
881TTO10X10	5/8	5/8	710FSO10
881TTO12X12	3/4	3/4	710FSO12
881TTO16X12	1	3/4	710FSO12
881TTO16X16	1	1	710FSO16
881TTO20X20	1-1/4	1-1/4	710FSO20
881TTO24X24	1-1/2	1-1/2	710FSO24

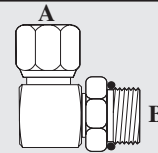

878TTO

 Femelle o'ring face tournant / Mâle o'ring boss ajustable
 Female o'ring face swivel / Male o'ring boss adjustable

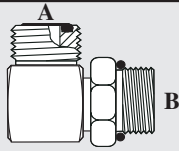
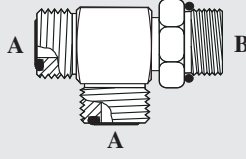
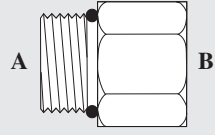
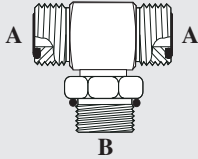
Numéro Part number	A (")	B (")	O'ring
878TTO04X04	1/4	1/4	710FSO04
878TTO06X06	3/8	3/8	710FSO06
878TTO08X08	1/2	1/2	710FSO08
878TTO10X10	5/8	5/8	710FSO10
878TTO12X12	3/4	3/4	710FSO12
878TTO16X16	1	1	710FSO16

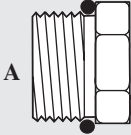
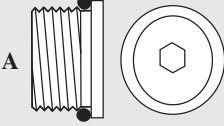
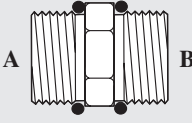
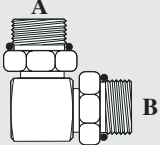
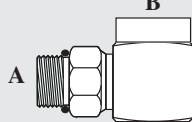
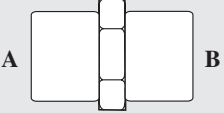
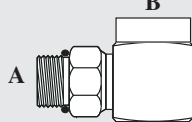
					Numéro Part number	A (")	O'ring	B (")	O'ring
849TTO					845TTO20X20	1-1/4	710TTO20	1-1/4	710FSO20
Mâle o'ring face / Mâle o'ring boss ajustable					845TTO24X24	1-1/2	710TTO24	1-1/2	710FSO24
Male o'ring face / Male o'ring boss adjustable									
849TTO					851TTO				
Mâle o'ring face / Mâle o'ring boss ajustable					Mâle o'ring face / Mâle o'ring face / Mâle o'ring boss ajustable				
Male o'ring face / Male o'ring boss adjustable					Male o'ring face / Male o'ring face / Male o'ring boss adjustable				
Numéro Part number	A (")	O'ring	B (")	O'ring	Numéro Part number	A (")	O'ring	B (")	O'ring
849TTO04X04	1/4	710TTO04	1/4	710FSO04	851TTO04X04	1/4	710TTO04	1/4	710FSO04
849TTO04X05	1/4	710TTO04	5/16	710FSO05	851TTO06X06	3/8	710TTO06	3/8	710FSO06
849TTO04X06	1/4	710TTO04	3/8	710FSO06	851TTO08X08	1/2	710TTO08	1/2	710FSO08
849TTO04X08	1/4	710TTO04	1/2	710FSO08	851TTO10X10	5/8	710TTO10	5/8	710FSO10
849TTO06X04	3/8	710TTO06	1/4	710FSO04	851TTO12X12	3/4	710TTO12	3/4	710FSO12
849TTO06X05	3/8	710TTO06	5/16	710FSO05	851TTO16X16	1	710TTO16	1	710FSO16
849TTO06X06	3/8	710TTO06	3/8	710FSO06	ORB (o'ring boss)				
849TTO06X08	3/8	710TTO06	1/2	710FSO08					
849TTO06X10	3/8	710TTO06	5/8	710FSO10					
849TTO06X12	3/8	710TTO06	3/4	710FSO12					
849TTO08X06	1/2	710TTO08	3/8	710FSO06	719FSO				
849TTO08X08	1/2	710TTO08	1/2	710FSO08	Mâle o'ring boss / Femelle o'ring boss				
849TTO08X10	1/2	710TTO08	5/8	710FSO10	Male o'ring boss / Female o'ring boss				
849TTO08X12	1/2	710TTO08	3/4	710FSO12	Numéro Part number	A (")	O'ring	B (")	
849TTO10X08	5/8	710TTO10	1/2	710FSO08	719FSO06X04	3/8	710FSO06	1/4	
849TTO10X10	5/8	710TTO10	5/8	710FSO10	719FSO06X08	3/8	710FSO06	1/2	
849TTO10X12	5/8	710TTO10	3/4	710FSO12	719FSO08X06	1/2	710FSO08	3/8	
849TTO12X08	3/4	710TTO12	1/2	710FSO08	719FSO08X08	1/2	710FSO08	1/2	
849TTO12X10	3/4	710TTO12	5/8	710FSO10	719FSO08X10	1/2	710FSO08	5/8	
849TTO12X12	3/4	710TTO12	3/4	710FSO12	719FSO10X06	5/8	710FSO10	3/8	
849TTO12X16	3/4	710TTO12	1	710FSO16	719FSO10X08	5/8	710FSO10	1/2	
849TTO16X12	1	710TTO16	3/4	710FSO12	719FSO10X12	5/8	710FSO10	3/4	
849TTO16X16	1	710TTO16	1	710FSO16	719FSO12X06	3/4	710FSO12	3/8	
849TTO16X20	1	710TTO16	1-1/4	710FSO20	719FSO12X08	3/4	710FSO12	1/2	
849TTO20X16	1-1/4	710TTO20	1	710FSO16	719FSO12X10	3/4	710FSO12	5/8	
849TTO20X20	1-1/4	710TTO20	1-1/4	710FSO20	719FSO12X12	3/4	710FSO12	1/2	
849TTO20X20	1-1/4	710TTO20	1-1/4	710FSO20	719FSO14X12	7/8	710FSO14	3/4	
849TTO24X20	1-1/2	710TTO24	1-1/4	710FSO20	719FSO16X10	1	710FSO16	5/8	
849TTO24X24	1-1/2	710TTO24	1-1/2	710FSO24	719FSO16X12	1	710FSO16	3/4	
					719FSO20X12	1-1/4	710FSO20	3/4	
					719FSO20X16	1-1/4	710FSO20	1	
845TTO					719FSO24X16	1-1/2	710FSO24	1	
Mâle o'ring face / Mâle o'ring boss ajustable / Mâle o'ring face					719FSO24X20	1-1/2	710FSO24	1 1/4	
Male o'ring face / Male o'ring boss adjustable / Male o'ring face									
Numéro Part number	A (")	O'ring	B (")	O'ring					
845TTO04X04	1/4	710TTO04	1/4	710FSO04					
845TTO06X06	3/8	710TTO06	3/8	710FSO06					
845TTO06X08	3/8	710TTO06	1/2	710FSO08					
845TTO08X08	1/2	710TTO08	1/2	710FSO08					
845TTO10X10	5/8	710TTO10	5/8	710FSO10					
845TTO12X10	3/4	710TTO12	5/8	710FSO10					
845TTO12X12	3/4	710TTO12	3/4	710FSO12					
845TTO16X16	1	710TTO16	1	710FSO16					

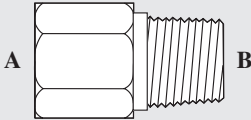
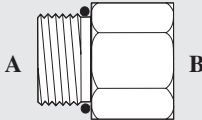
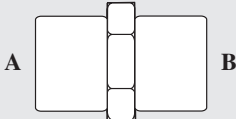
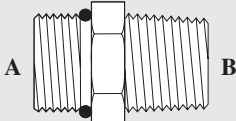
 <p>721FSO Bouchon mâle o'ring boss tête hexagone Hexagon head o'ring boss male plug</p>			Numéro Part number	A (")	B (")	
			780FSO04X06 780FSO06X06	1/4 3/8	3/8 3/8	
 <p>723FSO Bouchon mâle o'ring boss type Allen Allen type o'ring boss male plug</p>			 <p>742FSO Mâle o'ring boss / Mâle o'ring boss Male o'ring boss / Male o'ring boss</p>			
Numéro Part number	A (")	O'ring	Numéro Part number	A (")	B (")	O'ring
721FSO02 721FSO03 721FSO04 721FSO05 721FSO06 721FSO08 721FSO10 721FSO12 721FSO14 721FSO16 721FSO20 721FSO24 721FSO32	1/8 3/16 1/4 5/16 3/8 1/2 5/8 3/4 7/8 1 1-1/4 1-1/2 2	710FSO02 710FSO03 710FSO04 710FSO05 710FSO06 710FSO08 710FSO10 710FSO12 710FSO14 710FSO16 710FSO20 710FSO24 710FSO32	742FSO04X04 742FSO06X06 742FSO08X08 742FSO10X10 742FSO12X12 742FSO16X16 742FSO20X20 742FSO24X24	1/4 3/8 1/2 5/8 3/4 1 1-1/4 1-1/2	1/4 3/8 1/2 5/8 3/4 1 1-1/4 1-1/2	710FSO04 710FSO06 710FSO08 710FSO10 710FSO12 710FSO16 710FSO20 710FSO24
 <p>755FSO Mâle o'ring boss / Mâle o'ring boss Male o'ring boss / Male o'ring boss</p>			 <p>779FSO Mâle o'ring boss ajustable / Femelle o'ring boss Male o'ring boss adjustable / Female o'ring boss</p>			
Numéro Part number	A (")	O'ring	Numéro Part number	A (")	B (")	O'ring
723FSO02 723FSO03 723FSO04 723FSO05 723FSO06 723FSO08 723FSO10 723FSO12 723FSO14 723FSO16 723FSO20	1/8 3/16 1/4 5/16 3/8 1/2 5/8 3/4 7/8 1 1-1/4		755FSO04X04 755FSO06X06 755FSO08X08 755FSO10X10 755FSO12X12 755FSO16X16 755FSO20X20 755FSO24X24	1/4 3/8 1/2 5/8 3/4 1 1-1/4 1-1/2	1/4 3/8 1/2 5/8 3/4 1 1-1/4 1-1/2	710FSO04 710FSO06 710FSO08 710FSO10 710FSO12 710FSO16 710FSO20 710FSO24
 <p>780FSO Femelle o'ring boss / Femelle o'ring boss Female o'ring boss / Female o'ring boss</p>			 <p>779FSO Mâle o'ring boss ajustable / Femelle o'ring boss Male o'ring boss adjustable / Female o'ring boss</p>			
Numéro Part number	A (")	B (")	Numéro Part number	A (")	O'ring	B (")
780FSO03X04 780FSO04X04	3/16 1/4	1/4 1/4	779FSO03X03 779FSO03X04 779FSO04X04 779FSO05X05 779FSO06X06 779FSO08X08	3/16 3/16 1/4 5/16 3/8 1/2	710FSO03 710FSO03 710FSO04 710FSO05 710FSO06 710FSO08	3/16 1/4 1/4 5/16 3/8 1/2

 <p>728FSO Femelle o'ring boss / Mâle NPTF Female o'ring boss / Male NPTF</p>				Numéro Part number	A (")	O'ring	B (")	
				722FSO12X08	3/4	710FSO12	1/2	
				722FSO12X12	3/4	710FSO12	3/4	
				722FSO16X16	1	710FSO16	1	
				722FSO20X20	1-1/4	710FSO20	1-1/4	
				722FSO24X24	1-1/2	710FSO24	1-1/2	
722FSO32X32	2	710FSO32	2					
Numéro Part number	A (")	 <p>720FSO Mâle o'ring boss / Femelle NPTF Male o'ring boss / Female NPTF</p>						
728FSO04X02	1/4			1/8				
728FSO04X04	1/4			1/4				
728FSO05X02	5/16			1/8				
728FSO06X06	3/8			3/8				
728FSO06X08	3/8			1/2				
728FSO08X06	1/2			3/8				
728FSO08X08	1/2			1/2				
728FSO10X08	5/8			1/2				
728FSO12X12	3/4			3/4				
728FSO16X16	1			1				
728FSO20X20	1-1/4			1-1/4				
 <p>726FSO Femelle o'ring boss / Femelle NPTF Female o'ring boss / Female NPTF</p>				Numéro Part number	A (")	B (")		
				726FSO03X02	3/16	1/8		
				726FSO04X02	1/4	1/8		
				726FSO05X04	5/16	1/4		
				726FSO06X04	3/8	1/4		
				726FSO06X06	3/8	3/8		
726FSO08X08	1/2	1/2						
 <p>722FSO Mâle o'ring boss / Mâle NPTF Male o'ring boss / Male NPTF</p>				Numéro Part number	A (")	O'ring	B (")	
				720FSO04X02	1/4	710FSO04	1/8	
				720FSO04X04	1/4	710FSO04	1/4	
				720FSO04X06	1/4	710FSO04	3/8	
				720FSO05X02	5/16	710FSO05	1/8	
				720FSO05X04	5/16	710FSO05	1/4	
				720FSO06X04	3/8	710FSO06	1/4	
				720FSO06X06	3/8	710FSO06	3/8	
				720FSO06X08	3/8	710FSO06	1/2	
				720FSO08X04	1/2	710FSO08	1/4	
				720FSO08X06	1/2	710FSO08	3/8	
				720FSO08X08	1/2	710FSO08	1/2	
				720FSO10X04	5/8	710FSO10	1/4	
				720FSO10X06	5/8	710FSO10	3/8	
720FSO10X08	5/8	710FSO10	1/2					
720FSO10X12	5/8	710FSO10	3/4					
720FSO12X06	3/4	710FSO12	3/8					
720FSO12X08	3/4	710FSO12	1/2					
720FSO12X12	3/4	710FSO12	3/4					
720FSO14X12	7/8	710FSO14	3/4					
720FSO16X08	1	710FSO16	1/2					
720FSO16X12	1	710FSO16	3/4					
720FSO16X16	1	710FSO16	1					
720FSO16X20	1	710FSO16	1-1/4					
720FSO20X12	1-1/4	710FSO20	3/4					
720FSO20X16	1-1/4	710FSO20	1					
720FSO20X20	1-1/4	710FSO20	1-1/4					
720FSO24X16	1-1/2	710FSO24	1					
720FSO24X24	1-1/2	710FSO24	1-1/2					
720FSO32X32	2	710FSO32	2					
Numéro Part number	A (")	O'ring	B (")					
722FSO04X02	1/4	710FSO04	1/8					
722FSO04X04	1/4	710FSO04	1/4					
722FSO06X04	3/8	710FSO06	1/4					
722FSO06X06	3/8	710FSO06	3/8					
722FSO08X04	1/2	710FSO08	1/4					
722FSO08X06	1/2	710FSO08	3/8					
722FSO08X08	1/2	710FSO08	1/2					
722FSO08X12	1/2	710FSO08	3/4					
722FSO10X08	5/8	710FSO10	1/2					

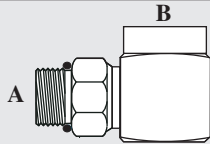
725FSO

Mâle o'ring boss ajustable / Femelle NPTF
 Male o'ring boss adjustable / Female NPTF

Numéro Part number	A (")	O'ring	B (")
725FSO04X02	1/4	710FSO04	1/8
725FSO04X04	1/4	710FSO04	1/4
725FSO05X02	5/16	710FSO05	1/8
725FSO08X06	1/2	710FSO08	3/8
725FSO08X08	1/2	710FSO08	1/2
725FSO12X12	3/4	710FSO12	3/4
725FSO16X16	1	710FSO16	1
725FSO20X20	1-1/4	710FSO20	1-1/4

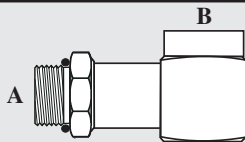
725LFSO

Mâle o'ring boss ajustable long / Femelle NPTF
 Male o'ring boss adjustable long / Female NPTF

Numéro Part number	A (")	O'ring	B (")
725LFSO08X06	1/2	710FSO08	3/8
725LFSO10X08	5/8	710FSO10	1/2
725LFSO12X12	3/4	710FSO12	3/4
725LFSO16X16	1	710FSO16	1

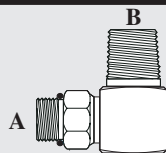
729FSO

Mâle o'ring boss ajustable / Mâle NPTF
 Male o'ring boss adjustable / Male NPTF

Numéro Part number	A (")	O'ring	B (")
729FSO04X04	1/4	710FSO04	1/4
729FSO06X04	3/8	710FSO06	1/4
729FSO06X06	3/8	710FSO06	3/8
729FSO08X08	1/2	710FSO08	1/2
729FSO12X12	3/4	710FSO12	3/4
729FSO16X16	1	710FSO16	1
729FSO20X20	1-1/4	710FSO20	1-1/4

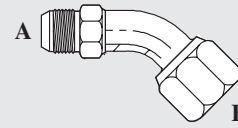
ADAPTER TUBE

63TA

Mâle JIC / Femelle JIC tournant
 Male JIC / Female JIC swivel

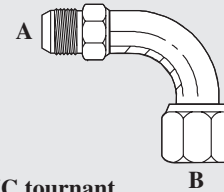
Numéro Part number	A (")	B (")
63TA04X04	1/4	1/4
63TA05X05	5/16	5/16
63TA06X06	3/8	3/8
63TA08X08	1/2	1/2
63TA10X10	5/8	5/8
63TA12X12	3/4	3/4
63TA16X16	1	1

63UA

Mâle JIC / Femelle JIC tournant
 Male JIC / Female JIC swivel

Numéro Part number	A (")	B (")
63UA04X04	1/4	1/4
63UA05X05	5/16	5/16
63UA06X06	3/8	3/8
63UA08X08	1/2	1/2
63UA10X10	5/8	5/8
63UA12X12	3/4	3/4
63UA16X16	1	1
63UA20X20	1-1/4	1-1/4
63UA24X24	1-1/2	1-1/2

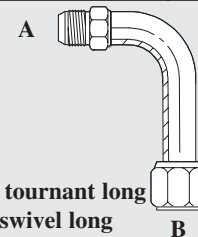
63UC

Mâle JIC / Femelle JIC tournant long
 Male JIC / Female JIC swivel long

Numéro Part number	A (")	B (")
63UC04X04	1/4	1/4
63UC05X05	5/16	5/16
63UC06X06	3/8	3/8
63UC08X08	1/2	1/2
63UC10X10	5/8	5/8
63UC12X12	3/4	3/4
63UC16X16	1	1
63UC20X20	1-1/4	1-1/4

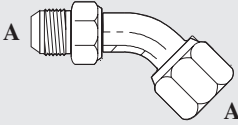
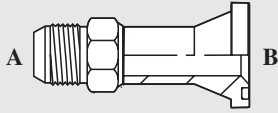
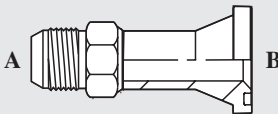
 <p>61TA Mâle JIC / Femelle BSPP tournant Male JIC / Female BSPP swivel</p>					Numéro Part number	A (")	B (")	O'ring	Bride Flange																																																																																
					63SB24X20	1-1/2	1-1/4	20PA77	20PA																																																																																
					63SB24X24	1-1/2	1-1/2	24PA77	24PA																																																																																
					63SB24X32	1-1/2	2	32PA77	32PA																																																																																
					63SB32X24	2	1-1/2	24PA77	24PA																																																																																
					63SB32X32	2	2	32PA77	32PA																																																																																
<table border="1"> <thead> <tr> <th>Numéro Part number</th> <th>A (")</th> </tr> </thead> <tbody> <tr><td>61TA04</td><td>1/4</td></tr> <tr><td>61TA06</td><td>3/8</td></tr> <tr><td>61TA08</td><td>1/2</td></tr> <tr><td>61TA10</td><td>5/8</td></tr> <tr><td>61TA12</td><td>3/4</td></tr> <tr><td>61TA16</td><td>1</td></tr> </tbody> </table>					Numéro Part number	A (")	61TA04	1/4	61TA06	3/8	61TA08	1/2	61TA10	5/8	61TA12	3/4	61TA16	1	 <p>63SE Mâle JIC / Bride (code 61 HD) Male JIC / Flange (code 61 HD)</p>																																																																						
Numéro Part number	A (")																																																																																								
61TA04	1/4																																																																																								
61TA06	3/8																																																																																								
61TA08	1/2																																																																																								
61TA10	5/8																																																																																								
61TA12	3/4																																																																																								
61TA16	1																																																																																								
<table border="1"> <thead> <tr> <th>Numéro Part number</th> <th>A (")</th> <th>B (")</th> <th>O'ring</th> <th>Bride Flange</th> </tr> </thead> <tbody> <tr><td>63SE12X12</td><td>3/4</td><td>3/4</td><td>12PA77</td><td>12PA</td></tr> <tr><td>63SE12X16</td><td>3/4</td><td>1</td><td>16PA77</td><td>16PA</td></tr> <tr><td>63SE16X16</td><td>1</td><td>1</td><td>16PA77</td><td>16PA</td></tr> <tr><td>63SE16X20</td><td>1</td><td>1-1/4</td><td>20PA77</td><td>20PA</td></tr> <tr><td>63SE20X20</td><td>1-1/4</td><td>1-1/4</td><td>20PA77</td><td>20PA</td></tr> <tr><td>63SE24X24</td><td>1-1/2</td><td>1-1/2</td><td>24PA77</td><td>24PA</td></tr> <tr><td>63SE32X32</td><td>2</td><td>2</td><td>32PA77</td><td>32PA</td></tr> </tbody> </table>					Numéro Part number	A (")	B (")	O'ring	Bride Flange	63SE12X12	3/4	3/4	12PA77	12PA	63SE12X16	3/4	1	16PA77	16PA	63SE16X16	1	1	16PA77	16PA	63SE16X20	1	1-1/4	20PA77	20PA	63SE20X20	1-1/4	1-1/4	20PA77	20PA	63SE24X24	1-1/2	1-1/2	24PA77	24PA	63SE32X32	2	2	32PA77	32PA																																													
Numéro Part number	A (")	B (")	O'ring	Bride Flange																																																																																					
63SE12X12	3/4	3/4	12PA77	12PA																																																																																					
63SE12X16	3/4	1	16PA77	16PA																																																																																					
63SE16X16	1	1	16PA77	16PA																																																																																					
63SE16X20	1	1-1/4	20PA77	20PA																																																																																					
63SE20X20	1-1/4	1-1/4	20PA77	20PA																																																																																					
63SE24X24	1-1/2	1-1/2	24PA77	24PA																																																																																					
63SE32X32	2	2	32PA77	32PA																																																																																					
<table border="1"> <thead> <tr> <th>Numéro Part number</th> <th>A (")</th> </tr> </thead> <tbody> <tr><td>61UA04</td><td>1/4</td></tr> <tr><td>61UA06</td><td>3/8</td></tr> <tr><td>61UA08</td><td>1/2</td></tr> <tr><td>61UA12</td><td>3/4</td></tr> <tr><td>61UA16</td><td>1</td></tr> </tbody> </table>					Numéro Part number	A (")	61UA04	1/4	61UA06	3/8	61UA08	1/2	61UA12	3/4	61UA16	1	 <p>63SF Mâle JIC / Bride (code 62) Male JIC / Flange (code 62)</p>																																																																								
Numéro Part number	A (")																																																																																								
61UA04	1/4																																																																																								
61UA06	3/8																																																																																								
61UA08	1/2																																																																																								
61UA12	3/4																																																																																								
61UA16	1																																																																																								
<table border="1"> <thead> <tr> <th>Numéro Part number</th> <th>A (")</th> <th>B (")</th> <th>O'ring</th> <th>Bride Flange</th> </tr> </thead> <tbody> <tr><td>63SF08X08</td><td>1/2</td><td>1/2</td><td>08PA77</td><td>08PH</td></tr> <tr><td>63SF12X12</td><td>3/4</td><td>3/4</td><td>12PA77</td><td>12PH</td></tr> <tr><td>63SF12X16</td><td>3/4</td><td>1</td><td>16PA77</td><td>16PH</td></tr> <tr><td>63SF16X12</td><td>1</td><td>3/4</td><td>12PA77</td><td>12PH</td></tr> <tr><td>63SF16X16</td><td>1</td><td>1</td><td>16PA77</td><td>16PH</td></tr> <tr><td>63SF16X20</td><td>1</td><td>1-1/4</td><td>20PA77</td><td>20PH</td></tr> <tr><td>63SF16X24</td><td>1</td><td>1-1/2</td><td>24PA77</td><td>24PH</td></tr> <tr><td>63SF20X16</td><td>1-1/4</td><td>1</td><td>16PA77</td><td>16PH</td></tr> <tr><td>63SF20X20</td><td>1-1/4</td><td>1-1/4</td><td>20PA77</td><td>20PH</td></tr> <tr><td>63SF20X24</td><td>1-1/4</td><td>1-1/2</td><td>24PA77</td><td>24PH</td></tr> <tr><td>63SF24X20</td><td>1-1/2</td><td>1-1/4</td><td>20PA77</td><td>20PH</td></tr> <tr><td>63SF24X24</td><td>1-1/2</td><td>1-1/2</td><td>24PA77</td><td>24PH</td></tr> <tr><td>63SF32X32</td><td>2</td><td>2</td><td>32PA77</td><td>32PH</td></tr> </tbody> </table>					Numéro Part number	A (")	B (")	O'ring	Bride Flange	63SF08X08	1/2	1/2	08PA77	08PH	63SF12X12	3/4	3/4	12PA77	12PH	63SF12X16	3/4	1	16PA77	16PH	63SF16X12	1	3/4	12PA77	12PH	63SF16X16	1	1	16PA77	16PH	63SF16X20	1	1-1/4	20PA77	20PH	63SF16X24	1	1-1/2	24PA77	24PH	63SF20X16	1-1/4	1	16PA77	16PH	63SF20X20	1-1/4	1-1/4	20PA77	20PH	63SF20X24	1-1/4	1-1/2	24PA77	24PH	63SF24X20	1-1/2	1-1/4	20PA77	20PH	63SF24X24	1-1/2	1-1/2	24PA77	24PH	63SF32X32	2	2	32PA77	32PH															
Numéro Part number	A (")	B (")	O'ring	Bride Flange																																																																																					
63SF08X08	1/2	1/2	08PA77	08PH																																																																																					
63SF12X12	3/4	3/4	12PA77	12PH																																																																																					
63SF12X16	3/4	1	16PA77	16PH																																																																																					
63SF16X12	1	3/4	12PA77	12PH																																																																																					
63SF16X16	1	1	16PA77	16PH																																																																																					
63SF16X20	1	1-1/4	20PA77	20PH																																																																																					
63SF16X24	1	1-1/2	24PA77	24PH																																																																																					
63SF20X16	1-1/4	1	16PA77	16PH																																																																																					
63SF20X20	1-1/4	1-1/4	20PA77	20PH																																																																																					
63SF20X24	1-1/4	1-1/2	24PA77	24PH																																																																																					
63SF24X20	1-1/2	1-1/4	20PA77	20PH																																																																																					
63SF24X24	1-1/2	1-1/2	24PA77	24PH																																																																																					
63SF32X32	2	2	32PA77	32PH																																																																																					
<p>63SB Mâle JIC / Bride (code 61) Male JIC / Flange (code 61)</p>					<table border="1"> <thead> <tr> <th>Numéro Part number</th> <th>A (")</th> <th>B (")</th> <th>O'ring</th> <th>Bride Flange</th> </tr> </thead> <tbody> <tr><td>63SB08X08</td><td>1/2</td><td>1/2</td><td>08PA77</td><td>08PA</td></tr> <tr><td>63SB08X12</td><td>1/2</td><td>3/4</td><td>12PA77</td><td>12PA</td></tr> <tr><td>63SB12X12</td><td>3/4</td><td>3/4</td><td>12PA77</td><td>12PA</td></tr> <tr><td>63SB12X16</td><td>3/4</td><td>1</td><td>16PA77</td><td>16PA</td></tr> <tr><td>63SB12X20</td><td>3/4</td><td>1-1/4</td><td>20PA77</td><td>20PA</td></tr> <tr><td>63SB12X24</td><td>3/4</td><td>1-1/2</td><td>24PA77</td><td>24PA</td></tr> <tr><td>63SB16X12</td><td>1</td><td>3/4</td><td>12PA77</td><td>12PA</td></tr> <tr><td>63SB16X16</td><td>1</td><td>1</td><td>16PA77</td><td>16PA</td></tr> <tr><td>63SB16X20</td><td>1</td><td>1-1/4</td><td>20PA77</td><td>20PA</td></tr> <tr><td>63SB16X24</td><td>1</td><td>1-1/2</td><td>24PA77</td><td>24PA</td></tr> <tr><td>63SB20X16</td><td>1-1/4</td><td>1</td><td>16PA77</td><td>16PA</td></tr> <tr><td>63SB20X20</td><td>1-1/4</td><td>1-1/4</td><td>20PA77</td><td>20PA</td></tr> <tr><td>63SB20X24</td><td>1-1/4</td><td>1-1/2</td><td>24PA77</td><td>24PA</td></tr> <tr><td>63SB20X32</td><td>1-1/4</td><td>2</td><td>32PA77</td><td>32PA</td></tr> <tr><td>63SB24X16</td><td>1-1/2</td><td>1</td><td>16PA77</td><td>16PA</td></tr> </tbody> </table>					Numéro Part number	A (")	B (")	O'ring	Bride Flange	63SB08X08	1/2	1/2	08PA77	08PA	63SB08X12	1/2	3/4	12PA77	12PA	63SB12X12	3/4	3/4	12PA77	12PA	63SB12X16	3/4	1	16PA77	16PA	63SB12X20	3/4	1-1/4	20PA77	20PA	63SB12X24	3/4	1-1/2	24PA77	24PA	63SB16X12	1	3/4	12PA77	12PA	63SB16X16	1	1	16PA77	16PA	63SB16X20	1	1-1/4	20PA77	20PA	63SB16X24	1	1-1/2	24PA77	24PA	63SB20X16	1-1/4	1	16PA77	16PA	63SB20X20	1-1/4	1-1/4	20PA77	20PA	63SB20X24	1-1/4	1-1/2	24PA77	24PA	63SB20X32	1-1/4	2	32PA77	32PA	63SB24X16	1-1/2	1	16PA77	16PA
Numéro Part number	A (")	B (")	O'ring	Bride Flange																																																																																					
63SB08X08	1/2	1/2	08PA77	08PA																																																																																					
63SB08X12	1/2	3/4	12PA77	12PA																																																																																					
63SB12X12	3/4	3/4	12PA77	12PA																																																																																					
63SB12X16	3/4	1	16PA77	16PA																																																																																					
63SB12X20	3/4	1-1/4	20PA77	20PA																																																																																					
63SB12X24	3/4	1-1/2	24PA77	24PA																																																																																					
63SB16X12	1	3/4	12PA77	12PA																																																																																					
63SB16X16	1	1	16PA77	16PA																																																																																					
63SB16X20	1	1-1/4	20PA77	20PA																																																																																					
63SB16X24	1	1-1/2	24PA77	24PA																																																																																					
63SB20X16	1-1/4	1	16PA77	16PA																																																																																					
63SB20X20	1-1/4	1-1/4	20PA77	20PA																																																																																					
63SB20X24	1-1/4	1-1/2	24PA77	24PA																																																																																					
63SB20X32	1-1/4	2	32PA77	32PA																																																																																					
63SB24X16	1-1/2	1	16PA77	16PA																																																																																					

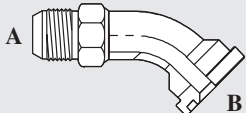
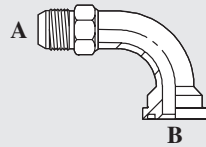
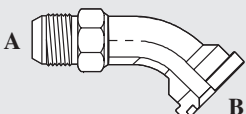
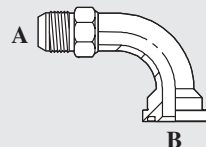
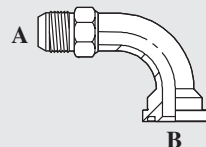
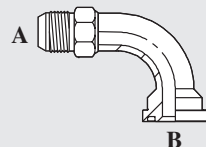
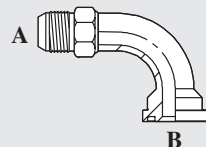
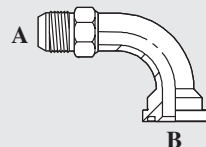
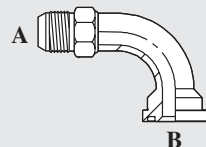
 63TB Mâle JIC / Bride (code 61) Male JIC / Flange (code 61)					Numéro Part number	A (")	B (")	O'ring	Bride Flange
63TB08X08	1/2	1/2	08PA77	08PA	63TF16X24	1	1-1/2	24PA77	24PH
63TB08X12	1/2	3/4	12PA77	12PA	63TF20X12	1-1/4	3/4	12PA77	12PH
63TB12X12	3/4	3/4	12PA77	12PA	63TF20X16	1-1/4	1	16PA77	16PH
63TB12X16	3/4	1	16PA77	16PA	63TF20X20	1-1/4	1-1/4	20PA77	20PH
63TB12X20	3/4	1-1/4	20PA77	20PA	63TF20X24	1-1/4	1-1/2	24PA77	24PH
63TB16X12	1	3/4	12PA77	12PA	63TF24X20	1-1/2	1-1/4	20PA77	20PH
63TB16X16	1	1	16PA77	16PA	63TF24X24	1-1/2	1-1/2	24PA77	24PH
63TB16X20	1	1-1/4	20PA77	20PA	63TF32X32	2	2	32PA77	32PH
63TB16X24	1	1-1/2	24PA77	24PA	 63UB Mâle JIC / Bride (code 61) Male JIC / Flange (code 61)				
63TB20X12	1-1/4	3/4	12PA77	12PA	Numéro Part number	A (")	B (")	O'ring	Bride Flange
63TB20X16	1-1/4	1	16PA77	16PA	63UB08X08	1/2	1/2	08PA77	08PA
63TB20X20	1-1/4	1-1/4	20PA77	20PA	63UB08X12	1/2	3/4	12PA77	12PA
63TB20X24	1-1/4	1-1/2	24PA77	24PA	63UB12X12	3/4	3/4	12PA77	12PA
63TB24X20	1-1/2	1-1/4	20PA77	20PA	63UB12X16	3/4	1	16PA77	16PA
63TB24X24	1-1/2	1-1/2	24PA77	24PA	63UB12X20	3/4	1-1/4	20PA77	20PA
63TB32X32	2	2	32PA77	32PA	63UB12X24	3/4	1-1/2	24PA77	24PA
 63TE Mâle JIC / Bride (code 61 HD) Male JIC / Flange (code 61 HD)					63UB16X12	1	3/4	12PA77	12PA
Numéro Part number	A (")	B (")	O'ring	Bride Flange	63UB16X16	1	1	16PA77	16PA
63TE12X12	3/4	3/4	12PA77	12PA	63UB16X20	1	1-1/4	20PA77	20PA
63TE16X16	1	1	16PA77	16PA	63UB16X24	1	1-1/2	24PA77	24PA
63TE16X20	1	1-1/4	20PA77	20PA	63UB16X32	1	2	32PA77	32PA
63TE20X20	1-1/4	1-1/4	20PA77	20PA	63UB20X12	1-1/4	3/4	12PA77	12PA
63TE24X24	1-1/2	1-1/2	24PA77	24PA	63UB20X16	1-1/4	1	16PA77	16PA
 63TF Mâle JIC / Bride (code 62) Male JIC / Flange (code 62)					63UB20X20	1-1/4	1-1/4	20PA77	20PA
Numéro Part number	A (")	B (")	O'ring	Bride Flange	63UB20X24	1-1/4	1-1/2	24PA77	24PA
63TF08X08	1/2	1/2	08PA77	08PH	63UB20X32	1-1/4	2	32PA77	32PA
63TF12X12	3/4	3/4	12PA77	12PH	63UB24X16	1-1/2	1	16PA77	16PA
63TF12X16	3/4	1	16PA77	16PH	63UB24X20	1-1/2	1-1/4	20PA77	20PA
63TF16X16	1	1	16PA77	16PH	63UB24X24	1-1/2	1-1/2	24PA77	24PA
63TF16X20	1	1-1/4	20PA77	20PH	63UB24X32	1-1/2	2	32PA77	32PA
 63UE Mâle JIC / Bride (code 61 HD) Male JIC / Flange (code 61 HD)					Numéro Part number	A (")	B (")	O'ring	Bride Flange
 63UE Mâle JIC / Bride (code 61 HD) Male JIC / Flange (code 61 HD)					63UE12X12	3/4	3/4	12PA77	12PA
 63UE Mâle JIC / Bride (code 61 HD) Male JIC / Flange (code 61 HD)					63UE12X16	3/4	1	16PA77	16PA
 63UE Mâle JIC / Bride (code 61 HD) Male JIC / Flange (code 61 HD)					63UE16X16	1	1	16PA77	16PA
 63UE Mâle JIC / Bride (code 61 HD) Male JIC / Flange (code 61 HD)					63UE16X20	1	1-1/4	20PA77	20PA

Numéro Part number	A (")	B (")	O'ring	Bride Flange
63UE20X20	1-1/4	1-1/4	20PA77	20PA
63UE20X24	1-1/4	1-1/2	24PA77	24PA
63UE24X24	1-1/2	1-1/2	24PA77	24PA
63UE32X32	2	2	32PA77	32PA

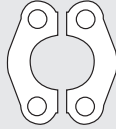
				
PH Bride code 62 Split flange code 62				
Numéro Part number		Dimension Size		
08PH		1/2		
12PH		3/4		
16PH		1		
20PH		1-1/4		
24PH		1-1/2		
32PH		2		

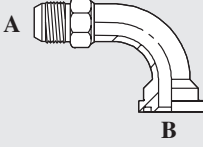
				
63UF Mâle JIC / Bride (code 62) Male JIC / Flange (code 62)				
Numéro Part number	A (")	B (")	O'ring	Bride Flange
63UF08X08	1/2	1/2	08PA77	08PH
63UF12X12	3/4	3/4	12PA77	12PH
63UF12X16	3/4	1	16PA77	16PH
63UF12X20	3/4	1-1/4	20PA77	20PH
63UF16X12	1	3/4	12PA77	12PH
63UF16X16	1	1	16PA77	16PH
63UF16X20	1	1-1/4	20PA77	20PH
63UF16X24	1	1-1/2	24PA77	24PH
63UF20X16	1-1/4	1	16PA77	16PH
63UF20X20	1-1/4	1-1/4	20PA77	20PH
63UF20X24	1-1/4	1-1/2	24PA77	24PH
63UF24X16	1-1/2	1	16PA77	16PH
63UF24X20	1-1/2	1-1/4	20PA77	20PH
63UF24X24	1-1/2	1-1/2	24PA77	24PH
63UF24X32	1-1/2	2	32PA77	32PH
63UF32X32	2	2	32PA77	32PH

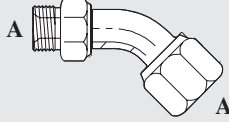
				
62TA Mâle BSPP / Femelle BSPP tournant Male BSPP / Female BSPP swivel				
Numéro Part number		A (")		
62TA04		1/4		
62TA06		3/8		
62TA08		1/2		
62TA10		5/8		
62TA12		3/4		
62TA16		1		
62TA20		1-1/4		
62TA24		1-1/2		
62TA32		2		

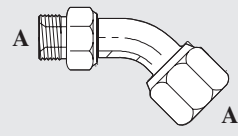
				
PA Bride code 61 Split flange code 61				
Numéro Part number		Dimension Size		
08PA		1/2		
12PA		3/4		
16PA		1		
20PA		1-1/4		
24PA		1-1/2		
32PA		2		

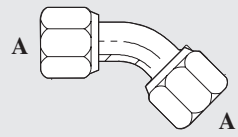
				
62TD Femelle BSPP tournant / Femelle BSPP tournant Female BSPP swivel / Female BSPP swivel				
Numéro Part number		A (")		
62TD04		1/4		
62TD06		3/8		
62TD08		1/2		
62TD10		5/8		
62TD12		3/4		
62TD16		1		
62TD20		1-1/4		

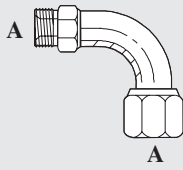
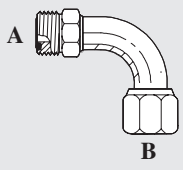
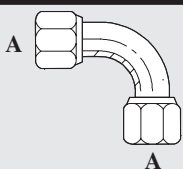
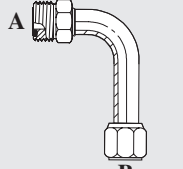
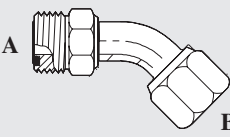
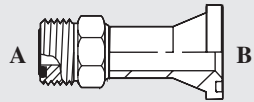
					
62UA Mâle BSPP / Femelle BSPP tournant Male BSPP / Female BSPP swivel			64UA Mâle o'ring face / Femelle o'ring face tournant Male o'ring face / Female o'ring face swivel		
Numéro Part number	A (")		Numéro Part number	A (")	B (")
62UA04	1/4		64UA04X04	1/4	1/4
62UA06	3/8		64UA06X06	3/8	3/8
62UA08	1/2		64UA08X08	1/2	1/2
62UA10	5/8		64UA10X10	5/8	5/8
62UA12	3/4		64UA12X12	3/4	3/4
62UA16	1		64UA16X16	1	1
62UA20	1-1/4		64UA20X20	1-1/4	1-1/4
62UA24	1-1/2		64UA24X24	1-1/2	1-1/2
62UA32	2				
					
62UD Femelle BSPP tournant / Femelle BSPP tournant Female BSPP swivel / Female BSPP swivel			64UC Mâle o'ring face / Femelle o'ring face tournant long Male o'ring face / Female o'ring face swivel long		
Numéro Part number	A (")		Numéro Part number	A (")	B (")
62UD04	1/4		64UC04X04	1/4	1/4
62UD06	3/8		64UC06X06	3/8	3/8
62UD08	1/2		64UC08X08	1/2	1/2
62UD10	5/8		64UC12X12	3/4	3/4
62UD12	3/4		64UC16X16	1	1
62UD16	1		64UC20X20	1-1/4	1-1/4
62UD20	1-1/4				
62UD24	1-1/2				
					
64TA Mâle o'ring face / Femelle o'ring face tournant Male o'ring face / Female o'ring face swivel			64SB Mâle o'ring face / Bride code 61 Male o'ring face / Flange code 61		
Numéro Part number	A (")	B (")	Numéro Part number	A (")	B (")
64TA04X04	1/4	1/4	64SB10X10	5/8	5/8
64TA06X06	3/8	3/8	64SB10X12	5/8	3/4
64TA08X08	1/2	1/2	64SB12X12	3/4	3/4
64TA10X10	5/8	5/8	64SB12X16	3/4	1
64TA12X12	3/4	3/4	64SB16X12	1	3/4
64TA16X16	1	1	64SB16X16	1	1
64TA20X20	1-1/4	1-1/4	64SB16X20	1	1-1/4
			64SB16X24	1	1-1/2
			64SB20X16	1-1/4	1
			64SB20X20	1-1/4	1-1/4
			64SB20X24	1-1/4	1-1/2
			64SB24X20	1-1/2	1-1/4

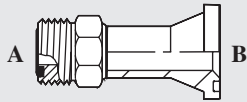
64SF

 Mâle o'ring face / Bride code 62
 Male o'ring face / Flange code 62

Numéro Part number	A (")	B (")
64SF10X12	5/8	3/4
64SF12X12	3/4	3/4
64SF12X16	3/4	1
64SF16X12	1	3/4
64SF16X16	1	1
64SF16X20	1	1-1/4
64SF16X24	1	1-1/2
64SF20X16	1-1/4	1
64SF20X20	1-1/4	1-1/4
64SF20X24	1-1/4	1-1/2
64SF24X20	1-1/2	1-1/4

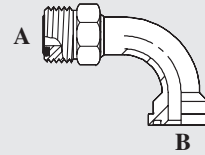
64UB

 Mâle o'ring face / Bride code 61
 Male o'ring face / Flange code 61

Numéro Part number	A (")	B (")
64UB12X12	3/4	3/4
64UB12X16	3/4	1
64UB16X16	1	1
64UB16X20	1	1-1/4
64UB20X20	1-1/4	1-1/4
64UB20X24	1-1/4	1-1/2
64UB24X24	1-1/2	1-1/2

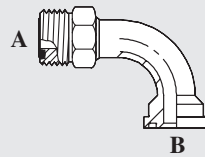
64UF

 Mâle o'ring face / Bride code 62
 Male o'ring face / Flange code 62

Numéro Part number	A (")	B (")
64UF12X12	3/4	3/4
64UF12X16	3/4	1
64UF16X12	1	3/4
64UF16X16	1	1
64UF16X20	1	1-1/4
64UF16X24	1	1-1/2
64UF20X12	1-1/4	3/4
64UF20X16	1-1/4	1
64UF20X20	1-1/4	1-1/4
64UF20X24	1-1/4	1-1/2
64UF24X24	1-1/2	1-1/2

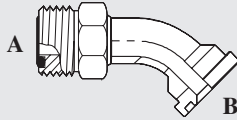
64TB

 Mâle o'ring face / Bride code 61
 Male o'ring face / Flange code 61

Numéro Part number	A (")	B (")
64TB12X12	3/4	3/4
64TB12X16	3/4	1
64TB16X16	1	1
64TB16X20	1	1-1/4
64TB20X20	1-1/4	1-1/4
64TB20X24	1-1/4	1-1/2
64TB24X24	1-1/2	1-1/2

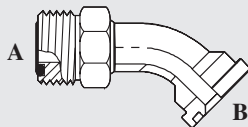
64TF

 Mâle o'ring face / Bride code 62
 Male o'ring face / Flange code 62

Numéro Part number	A (")	B (")
64TF12X12	3/4	3/4
64TF16X16	1	1
64TF20X20	1-1/4	1-1/4

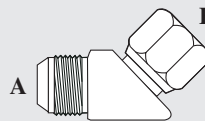
SAE 45 (45° flare)

589FS

 Mâle SAE45 / Femelle SAE45 tournant
 Male SAE45 / Female SAE45 swivel

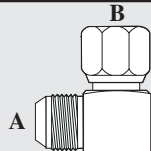
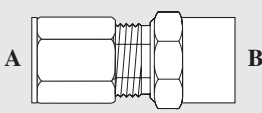
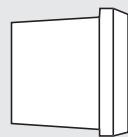
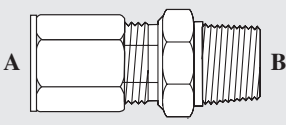
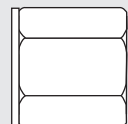
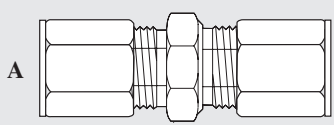
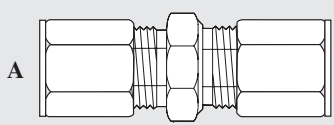
Numéro Part number	A (")	B (")
589FS06X06	3/8	3/8

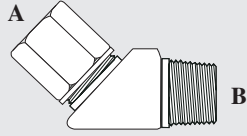
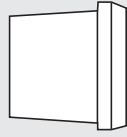
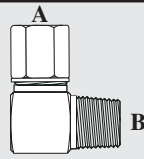
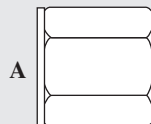
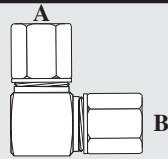
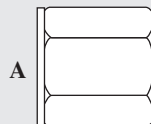
							
579FS Mâle SAE45 / Femelle SAE45 tournant Male SAE45 / Female SAE45 swivel			1946FS Tube / Femelle NPTF Tube / Female NPTF				
Numéro Part number	A (")	B (")	Numéro Part number	A (")	B (")	Écrou Nut	Bague Sleeve
579FS06X06	3/8	3/8	1946FS02X02	1/8	1/8	1961FS02	1960FS02
FLARELESS (compression)			1946FS04X04	1/4	1/4	1961FS04	1960FS04
			1946FS06X06	3/8	3/8	1961FS06	1960FS06
1960FS Bague Sleeve			1946FS08X08	1/2	1/2	1961FS08	1960FS08
Numéro Part number	Tube (")		1946FS12X12	3/4	3/4	1961FS12	1960FS12
1960FS02	1/8		1946FS16X16	1	1	1961FS16	1960FS16
1960FS03	3/16						
1960FS04	1/4		1948FS Tube / Mâle NPTF Tube / Male NPTF				
1960FS05	5/16		Numéro Part number	A (")	B (")	Écrou Nut	Bague Sleeve
1960FS06	3/8		1948FS02X02	1/8	1/8	1961FS02	1960FS02
1960FS08	1/2		1948FS04X02	1/4	1/8	1961FS04	1960FS04
1960FS10	5/8		1948FS04X04	1/4	1/4	1961FS04	1960FS04
1960FS12	3/4		1948FS06X04	3/8	1/4	1961FS06	1960FS06
1960FS14	7/8		1948FS06X06	3/8	3/8	1961FS06	1960FS06
1960FS16	1		1948FS08X06	1/2	3/8	1961FS08	1960FS08
			1948FS08X08	1/2	1/2	1961FS08	1960FS08
1961FS Écrou Nut			1948FS10X08	5/8	1/2	1961FS10	1960FS10
Numéro Part number	Tube (")		1948FS12X12	3/4	3/4	1961FS12	1960FS12
1961FS02	1/8		1948FS16X16	1	1	1961FS16	1960FS16
1961FS03	3/16						
1961FS04	1/4		1942FS Tube / Tube Tube / Tube				
1961FS05	5/16		Numéro Part number	A (")	B (")	Écrou Nut	Bague Sleeve
1961FS06	3/8		1942FS02X02	1/8	1/8	1961FS02	1960FS02
1961FS08	1/2		1942FS03X03	3/16	3/16	1961FS03	1960FS03
1961FS10	5/8		1942FS04X04	1/4	1/4	1961FS04	1960FS04
1961FS12	3/4		1942FS05X05	5/16	5/16	1961FS05	1960FS05
1961FS14	7/8		1942FS06X06	3/8	3/8	1961FS06	1960FS06
1961FS16	1		1942FS08X08	1/2	1/2	1961FS08	1960FS08
			1942FS10X10	5/8	5/8	1961FS10	1960FS10
1942FS Tube / Tube Tube / Tube			1942FS12X12	3/4	3/4	1961FS12	1960FS12
Numéro Part number	Tube (")		1942FS16X16	1	1	1961FS16	1960FS16
1942FS02X02	1/8						
1942FS03X03	3/16						
1942FS04X04	1/4						
1942FS05X05	5/16						
1942FS06X06	3/8						
1942FS08X08	1/2						
1942FS10X10	5/8						
1942FS12X12	3/4						
1942FS16X16	1						

 1954FS Tube / Mâle NPTF Tube / Male NPTF					FLARELESS METRIC (compression)		
Numéro Part number	A (")	B (")	Écrou Nut	Bague Sleeve	 1960FSM Bague Sleeve		
1954FS04X04	1/4	1/4	1961FS04	1960FS04	Numéro Part number	Tube (mm)	
1954FS06X04	3/8	1/4	1961FS06	1960FS06	1960FSM4LL	4mm	
1954FS08X06	1/2	3/8	1961FS08	1960FS08	1960FSM6LL	6mm	
1954FS10X08	5/8	1/2	1961FS10	1960FS10	1960FSM8LL	8mm	
1954FS12X12	3/4	3/4	1961FS12	1960FS12	1960FSM6LS	6mm	
1954FS16X16	1	1	1961FS16	1960FS16	1960FSM8LS	8mm	
 1949FS Tube / Mâle NPTF Tube / Male NPTF					 1961FSM Écrou Nut		
Numéro Part number	A (")	B (")	Écrou Nut	Bague Sleeve	Numéro Part number	Tube (mm)	
1949FS04X02	1/4	1/8	1961FS04	1960FS04	1960FSM10LS	10mm	
1949FS04X04	1/4	1/4	1961FS04	1960FS04	1960FSM12LS	12mm	
1949FS05X04	5/16	1/4	1961FS05	1960FS05	1960FSM15L	15mm	
1949FS06X06	3/8	3/8	1961FS06	1960FS06	1960FSM18L	18mm	
1949FS08X08	1/2	1/2	1961FS08	1960FS08	1960FSM22L	22mm	
1949FS10X08	5/8	1/2	1961FS10	1960FS10	1960FSM28L	28mm	
1949FS12X12	3/4	3/4	1961FS12	1960FS12	1960FSM35L	35mm	
1949FS16X16	1	1	1961FS16	1960FS16	1960FSM42L	42mm	
 1955FS Tube / Tube Tube / Tube					1960FSM14S	14mm	
Numéro Part number	A (")	B (")	Écrou Nut	Bague Sleeve	1960FSM16S	16mm	
1955FS04X04	1/4	1/4	1961FS04	1960FS04	1960FSM20S	20mm	
1955FS05X05	5/16	5/16	1961FS05	1960FS05	1960FSM25S	25mm	
1955FS06X06	3/8	3/8	1961FS06	1960FS06	1960FSM30S	30mm	
1955FS08X08	1/2	1/2	1961FS08	1960FS08	1960FSM38S	38mm	
1955FS10X10	5/8	5/8	1961FS10	1960FS10			
1955FS12X12	3/4	3/4	1961FS12	1960FS12	Numéro Part number	A (mm)	Tube (mm)
1955FS16X16	1	1	1961FS16	1960FS16	1961FSM4LL	M8X1.0	4mm
					1961FSM6LL	M10X1.0	6mm
					1961FSM8LL	M12X1.0	8mm
					1961FSM6L	M12X1.5	6mm
					1961FSM8L	M14X1.5	8mm
					1961FSM10L	M16X1.5	10mm
					1961FSM12L	M18X1.5	12mm
					1961FSM15L	M22X1.5	15mm
					1961FSM18L	M26X1.5	18mm
					1961FSM22L	M30X2.0	22mm
					1961FSM28L	M36X2.0	28mm
					1961FSM35L	M45X2.0	35mm
					1961FSM42L	M52X2.0	42mm
					1961FSM6S	M14X1.5	6mm
					1961FSM8S	M16X1.5	8mm

Numéro Part number	A (mm)	Tube (mm)	
1961FSM10S	M18X1.5	10mm	
1961FSM12S	M20X1.5	12mm	
1961FSM14S	M22X1.5	14mm	
1961FSM16S	M24X1.5	16mm	
1961FSM20S	M30X2.0	20mm	
1961FSM25S	M36X2.0	25mm	
1961FSM30S	M42X2.0	30mm	
1961FSM38S	M52X2.0	38mm	

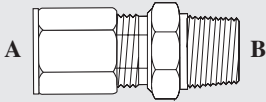

1948FSM
Tube / Mâle NPTF
Tube / Male NPTF

Numéro Part number	A (mm)	B (")	Écrou Nut	Bague Sleeve
1948FSM4LL02	4mm	1/8	1961FSM4LL	1960FSM4LL
1948FSM6LL02	6mm	1/8	1961FSM6LL	1960FSM6LL
1948FSM6L04	6mm	1/4	1961FSM6L	1960FSM6LS
1948FSM8L04	8mm	1/4	1961FSM8L	1960FSM8LS
1948FSM10L06	10mm	3/8	1961FSM10L	1960FSM10LS
1948FSM12L08	12mm	1/2	1961FSM12L	1960FSM12LS
1948FSM15L08	15mm	1/2	1961FSM15L	1960FSM15L
1948FSM6S04	6mm	1/4	1961FSM6S	1960FSM6LS
1948FSM8S04	8mm	1/4	1961FSM8S	1960FSM8LS
1948FSM10S04	10mm	1/4	1961FSM10S	1960FSM10LS
1948FSM12S06	12mm	3/8	1961FSM12S	1960FSM12LS
1948FSM14S08	14mm	1/2	1961FSM14S	1960FSM14S
1948FSM16S08	16mm	1/2	1961FSM16S	1960FSM16S

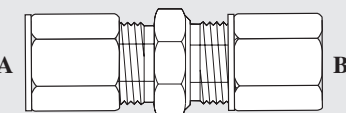

1942FSM
Tube / Tube
Tube / Tube

Numéro Part number	A (mm)	B (mm)	Écrou Nut	Bague Sleeve
1942FSM4LL	4mm	4mm	1961FSM4LL	1960FSM4LL
1942FSM6LL	6mm	6mm	1961FSM6LL	1960FSM6LL
1942FSM6L	6mm	6mm	1961FSM6L	1960FSM6LS
1942FSM8L	8mm	8mm	1961FSM8L	1960FSM8LS
1942FSM10L	10mm	10mm	1961FSM10L	1960FSM10LS
1942FSM12L	12mm	12mm	1961FSM12L	1960FSM12LS
1942FSM15L	15mm	15mm	1961FSM15L	1960FSM15L
1942FSM6S	6mm	6mm	1961FSM6S	1960FSM6LS
1942FSM8S	8mm	8mm	1961FSM8S	1960FSM8LS
1942FSM10S	10mm	10mm	1961FSM10S	1960FSM10LS
1942FSM12S	12mm	12mm	1961FSM12S	1960FSM12LS
1942FSM14S	14mm	14mm	1961FSM14S	1960FSM14S
1942FSM16S	16mm	16mm	1961FSM16S	1960FSM16S

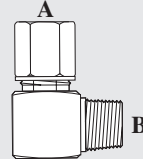

1949FSM
Tube / Mâle NPTF
Tube / Male NPTF

Numéro Part number	A (mm)	B (")	Écrou Nut	Bague Sleeve
1949FSM4LL02	4mm	1/8	1961FSM4LL	1960FSM4LL
1949FSM6LL02	6mm	1/8	1961FSM6LL	1960FSM6LL
1949FSM6L02	6mm	1/8	1961FSM6L	1960FSM6LS
1949FSM8L04	8mm	1/4	1961FSM8L	1960FSM8LS
1949FSM10L04	10mm	1/4	1961FSM10L	1960FSM10LS
1949FSM12L06	12mm	3/8	1961FSM12L	1960FSM12LS
1949FSM15L08	15mm	1/2	1961FSM15L	1960FSM15L
1949FSM6S04	6mm	1/4	1961FSM6S	1960FSM6LS
1949FSM8S04	8mm	1/4	1961FSM8S	1960FSM8LS
1949FSM10S06	10mm	3/8	1961FSM10S	1960FSM10LS
1949FSM12S06	12mm	3/8	1961FSM12S	1960FSM12LS
1949FSM14S08	14mm	1/2	1961FSM14S	1960FSM14S
1949FSM16S08	16mm	1/2	1961FSM16S	1960FSM16S

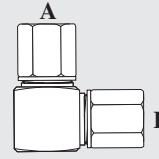

1955FSM
Tube / Tube
Tube / Tube

Numéro Part number	A (mm)	B (mm)	Écrou Nut	Bague Sleeve
1955FSM4LL	4mm	4mm	1961FSM4LL	1960FSM4LL
1955FSM6LL	6mm	6mm	1961FSM6LL	1960FSM6LL
1955FSM6L	6mm	6mm	1961FSM6L	1960FSM6LS
1955FSM8L	8mm	8mm	1961FSM8L	1960FSM8LS
1955FSM10L	10mm	10mm	1961FSM10L	1960FSM10LS
1955FSM12L	12mm	12mm	1961FSM12L	1960FSM12LS
1955FSM15L	15mm	15mm	1961FSM15L	1960FSM15L
1955FSM6S	6mm	6mm	1961FSM6S	1960FSM6LS
1955FSM8S	8mm	8mm	1961FSM8S	1960FSM8LS
1955FSM10S	10mm	10mm	1961FSM10S	1960FSM10LS
1955FSM12S	12mm	12mm	1961FSM12S	1960FSM12LS
1955FSM14S	14mm	14mm	1961FSM14S	1960FSM14S
1955FSM16S	16mm	16mm	1961FSM16S	1960FSM16S

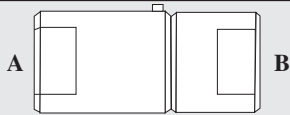
SWIVEL

59SP
Femelle NPTF / Femelle NPTF
Female NPTF / Female NPTF

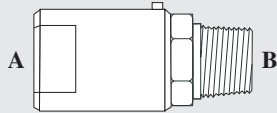
Numéro Part number	PSI	A (")	B (")	Ensemble Repair kit
59SP02X02	5000	1/8	1/8	59SKSS02
59SP04X04	5000	1/4	1/4	59SKSS04
59SP06X06	5000	3/8	3/8	59SKSS08
59SP08X08	5000	1/2	1/2	59SKSS08
59SP12X12	4500	3/4	3/4	59SKSS12
59SP16X16	4000	1	1	59SKSS16
59SP20X20	4000	1 1/4	1 1/4	59SKSS20
59SP24X24	4000	1 1/2	1 1/2	59SKSS24
59SP32X32	3000	2	2	59SKSS32

59SS
Femelle NPTF / Mâle NPTF
Female NPTF / Male NPTF

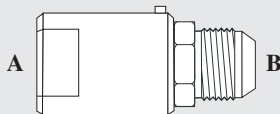
Numéro Part number	PSI	A (")	B (")	Ensemble Repair kit
59SS02X02	5000	1/8	1/8	59SKSS02
59SS04X04	5000	1/4	1/4	59SKSS04
59SS06X06	5000	3/8	3/8	59SKSS08
59SS08X08	5000	1/2	1/2	59SKSS08
59SS12X12	4500	3/4	3/4	59SKSS12
59SS16X16	4000	1	1	59SKSS16
59SS20X20	4000	1 1/4	1 1/4	59SKSS20
59SS24X24	4000	1 1/2	1 1/2	59SKSS24
59SS32X32	3000	2	2	59SKSS32

59SL
Femelle NPTF / Mâle JIC
Female NPTF / Male JIC

Numéro Part number	PSI	A (")	B (")	Ensemble Repair kit
59SL04X06	5000	1/4	3/8	59SKSS04
59SL06X08	5000	3/8	1/2	59SKSS08
59SL08X08	5000	1/2	1/2	59SKSS08
59SL08X10	5000	1/2	5/8	59SKSS08
59SL12X12	4500	3/4	3/4	59SKSS12
59SL16X16	4000	1	1	59SKSS16
59SL20X20	4000	1 1/4	1 1/4	59SKSS20
59SL24X24	4000	1 1/2	1 1/2	59SKSS24

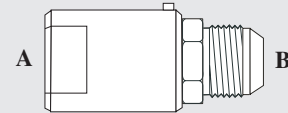
59SX
Femelle JIC / Mâle JIC
Female JIC / Male JIC

Numéro Part number	PSI	A (")	B (")	Ensemble Repair kit
59SX04X04	5000	1/4	1/4	59SKSS04
59SX06X06	5000	3/8	3/8	59SKSS04
59SX08X08	5000	1/2	1/2	59SKSS08
59SX10X10	5000	5/8	5/8	59SKSS08
59SX12X12	4500	3/4	3/4	59SKSS12
59SX16X16	4000	1	1	59SKSS16
59SX20X20	4000	1 1/4	1 1/4	59SKSS20
59SX24X24	4000	1 1/2	1 1/2	59SKSS24

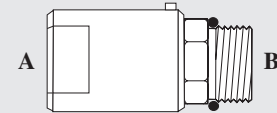
59ST
Femelle NPTF / Mâle o'ring boss
Female NPTF / Male o'ring boss

Numéro Part number	PSI	A (")	B (")	Ensemble Repair kit
59ST04X06	5000	1/4	3/8	59SKSS04
59ST06X08	5000	3/8	1/2	59SKSS08
59ST08X08	5000	1/2	1/2	59SKSS08
59ST08X10	5000	1/2	5/8	59SKSS08
59ST12X12	4500	3/4	3/4	59SKSS12
59ST16X16	4000	1	1	59SKSS16
59ST20X20	4000	1 1/4	1 1/4	59SKSS20
59ST24X24	4000	1 1/2	1 1/2	59SKSS24

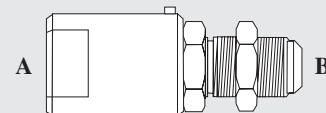
59SXBH
Femelle JIC / Mâle JIC cloison
Female JIC / Male JIC bulkhead

Numéro Part number	PSI	A (")	B (")	Ensemble Repair kit
59SXBH08X08	5000	1/2	1/2	59SKSS08
59SXBH10X10	5000	5/8	5/8	59SKSS08
59SXBH12X12	4500	3/4	3/4	59SKSS12
59SXBH16X16	4000	1	1	59SKSS16
59SXBH20X20	4000	1 1/4	1 1/4	59SKSS20

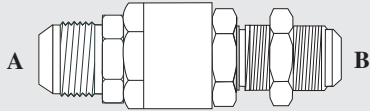
59SJBH
Mâle JIC / Mâle JIC cloison
Male JIC / Male JIC bulkhead

Numéro Part number	PSI	A (")	B (")	Ensemble Repair kit
59SJBH08X08	5000	1/2	1/2	59SKSS08
59SJBH10X10	5000	5/8	5/8	59SKSS08
59SJBH12X12	4500	3/4	3/4	59SKSS12
59SJBH16X16	4000	1	1	59SKSS16
59SJBH20X20	4000	1 1/4	1 1/4	59SKSS20

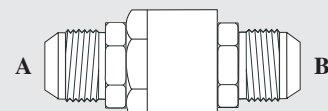
59SJ
Mâle JIC / Mâle JIC
Male JIC / Male JIC

Numéro Part number	PSI	A (")	B (")	Ensemble Repair kit
59SJ04X04	5000	1/4	1/4	59SKSS04
59SJ06X06	5000	3/8	3/8	59SKSS04
59SJ08X08	5000	1/2	1/2	59SKSS08
59SJ10X10	5000	5/8	5/8	59SKSS08
59SJ12X12	4500	3/4	3/4	59SKSS12
59SJ16X16	4000	1	1	59SKSS16
59SJ20X20	4000	1 1/4	1 1/4	59SKSS20
59SJ24X24	4000	1 1/2	1 1/2	59SKSS24

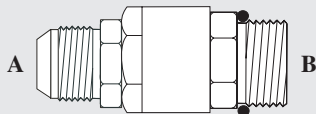
59SB
Mâle JIC / Mâle o'ring boss
Male JIC / Male o'ring boss

Numéro Part number	PSI	A (")	B (")	Ensemble Repair kit
59SB04X04	5000	1/4	1/4	59SKSS04
59SB06X06	5000	3/8	3/8	59SKSS04
59SB08X08	5000	1/2	1/2	59SKSS08
59SB08X10	5000	1/2	5/8	59SKSS08
59SB10X10	5000	5/8	5/8	59SKSS08
59SB12X12	4500	3/4	3/4	59SKSS12
59SB16X16	4000	1	1	59SKSS16
59SB20X20	4000	1 1/4	1 1/4	59SKSS20
59SB24X24	4000	1 1/2	1 1/2	59SKSS24

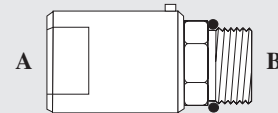
59SZ
Femelle JIC / Mâle o'ring boss
Female JIC / Male o'ring boss

Numéro Part number	PSI	A (")	B (")	Ensemble Repair kit
59SZ06X06	5000	3/8	3/8	59SKSS04
59SZ08X08	5000	1/2	1/2	59SKSS08
59SZ10X10	5000	5/8	5/8	59SKSS08
59SZ12X12	4500	3/4	3/4	59SKSS12
59SZ16X16	4000	1	1	59SKSS16
59SZ20X20	4000	1 1/4	1 1/4	59SKSS20
59SZ24X24	4000	1 1/2	1 1/2	59SKSS24

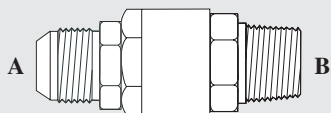

59SA
Mâle JIC / Mâle NPTF
Male JIC / Male NPTF

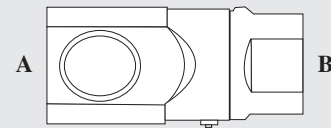
Numéro Part number	PSI	A (")	B (")	Ensemble Repair kit
59SA06X04	5000	3/8	1/4	59SKSS04
59SA06X06	5000	3/8	3/8	59SKSS04
59SA08X06	5000	1/2	3/8	59SKSS08
59SA08X08	5000	1/2	1/2	59SKSS08
59SA10X06	5000	5/8	3/8	59SKSS08
59SA10X08	5000	5/8	1/2	59SKSS08
59SA12X12	4500	3/4	3/4	59SKSS12
59SA16X16	4000	1	1	59SKSS16
59SA20X20	4000	1 1/4	1 1/4	59SKSS20
59SA24X24	4000	1 1/2	1 1/2	59SKSS24

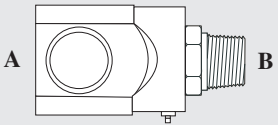
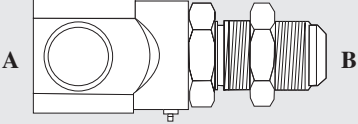
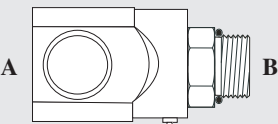
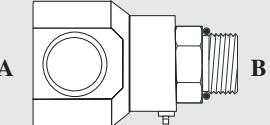
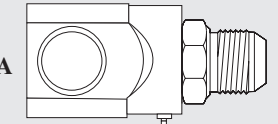
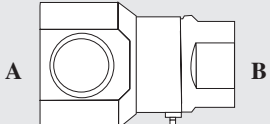

59UP
Femelle NPTF / Femelle NPTF
Female NPTF / Female NPTF

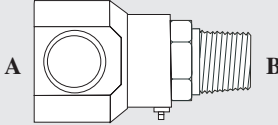
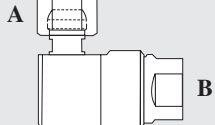
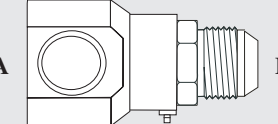
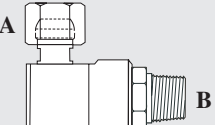
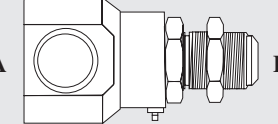
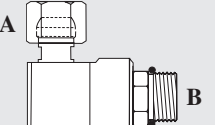
Numéro Part number	PSI	A (")	B (")	Ensemble Repair kit
59UP02X02	5000	1/8	1/8	59SKSS02
59UP04X04	5000	1/4	1/4	59SKSS04
59UP06X06	5000	3/8	3/8	59SKSS08
59UP08X08	5000	1/2	1/2	59SKSS08
59UP12X12	4500	3/4	3/4	59SKSS12
59UP16X16	4000	1	1	59SKSS16
59UP20X20	4000	1 1/4	1 1/4	59SKSS20
59UP24X24	4000	1 1/2	1 1/2	59SKSS24
59UP32X32	3000	2	2	59SKSS32

 <p>59US Femelle NPTF / Mâle NPTF Female NPTF / Male NPTF</p>					Numéro Part number	PSI	A (")	B (")	Ensemble Repair kit					
					59UL12X12	4500	3/4	3/4	59SKSS12					
					59UL16X16	4000	1	1	59SKSS16					
					59UL20X20	4000	1 1/4	1 1/4	59SKSS20					
					59UL24X24	4000	1 1/2	1 1/2	59SKSS24					
 <p>59ULBH Femelle NPTF / Mâle JIC cloison Female NPTF / Male JIC bulkhead</p>					Numéro Part number	PSI	A (")	B (")	Ensemble Repair kit					
					59ULBH06X08	5000	3/8	1/2	59SKSS08					
					59ULBH08X08	5000	1/2	1/2	59SKSS08					
					59ULBH06X10	5000	3/8	5/8	59SKSS08					
					59ULBH08X10	5000	1/2	5/8	59SKSS08					
					59ULBH12X12	4500	3/4	3/4	59SKSS12					
					59ULBH16X16	4000	1	1	59SKSS16					
					59ULBH20X20	4000	1 1/4	1 1/4	59SKSS20					
					 <p>59UT Femelle NPTF / Mâle o'ring boss Female NPTF / Male o'ring boss</p>					Numéro Part number	PSI	A (")	B (")	Ensemble Repair kit
										59UT04X04	5000	1/4	1/4	59SKSS04
										59UT04X06	5000	1/4	3/8	59SKSS04
										59UT06X08	5000	3/8	1/2	59SKSS08
										59UT06X10	5000	3/8	5/8	59SKSS08
59UT08X08	5000	1/2	1/2	59SKSS08										
59UT08X10	5000	1/2	5/8	59SKSS08										
59UT12X12	4500	3/4	3/4	59SKSS12										
59UT16X16	4000	1	1	59SKSS16										
59UT20X20	4000	1 1/4	1 1/4	59SKSS20										
59UT24X24	4000	1 1/2	1 1/2	59SKSS24										
 <p>59UR Femelle o'ring boss / Mâle o'ring boss Female o'ring boss / Male o'ring boss</p>										Numéro Part number	PSI	A (")	B (")	Ensemble Repair kit
										59UR06X04	5000	3/8	1/4	59SKSS04
					59UR06X06	5000	3/8	3/8	59SKSS04					
					59UR08X08	5000	1/2	1/2	59SKSS08					
					59UR08X10	5000	1/2	5/8	59SKSS08					
					59UR12X12	4500	3/4	3/4	59SKSS12					
					59UR16X16	4000	1	1	59SKSS16					
					59UR20X20	4000	1 1/4	1 1/4	59SKSS20					
					 <p>59UL Femelle NPTF / Mâle JIC Female NPTF / Male JIC</p>					Numéro Part number	PSI	A (")	B (")	Ensemble Repair kit
										59UL04X04	5000	1/4	1/4	59SKSS04
										59UL04X06	5000	1/4	3/8	59SKSS04
										59UL06X08	5000	3/8	1/2	59SKSS08
										59UL06X10	5000	3/8	5/8	59SKSS08
59UL08X08	5000	1/2	1/2	59SKSS08										
59UL08X10	5000	1/2	5/8	59SKSS08										
 <p>59UO Femelle o'ring boss / Femelle NPTF Female o'ring boss / Female NPTF</p>										Numéro Part number	PSI	A (")	B (")	Ensemble Repair kit
										59UO06X04	5000	3/8	1/4	59SKSS04
										59UO08X06	5000	1/2	3/8	59SKSS08
					59UO08X08	5000	1/2	1/2	59SKSS08					
					59UO12X12	4500	3/4	3/4	59SKSS12					
					59UO16X16	4000	1	1	59SKSS16					
					59UO20X20	4000	1 1/4	1 1/4	59SKSS20					

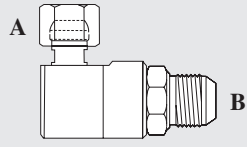
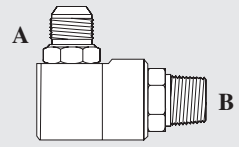
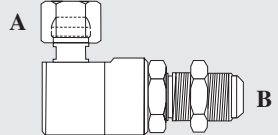
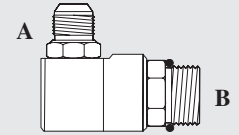
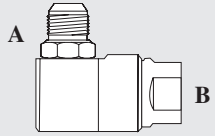
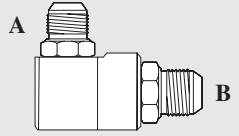
									
59UQ Femelle o'ring boss / Mâle NPTF Female o'ring boss / Male NPTF					59UE Femelle NPSM tournant / Femelle NPTF Female NPSM swivel / Female NPTF				
Numéro Part number	PSI	A (")	B (")	Ensemble Repair kit	Numéro Part number	PSI	A (")	B (")	Ensemble Repair kit
59UQ06X04	5000	3/8	1/4	59SKSS04	59UE04X04	5000	1/4	1/4	59SKSS04
59UQ06X06	5000	3/8	3/8	59SKSS04	59UE06X04	5000	3/8	1/4	59SKSS04
59UQ08X06	5000	1/2	3/8	59SKSS08	59UE06X06	5000	3/8	3/8	59SKSS08
59UQ08X08	5000	1/2	1/2	59SKSS08	59UE08X08	5000	1/2	1/2	59SKSS08
59UQ12X12	4500	3/4	3/4	59SKSS12	59UE12X12	4500	3/4	3/4	59SKSS12
59UQ16X16	4000	1	1	59SKSS16	59UE16X16	4000	1	1	59SKSS16
59UQ20X20	4000	1 1/4	1 1/4	59SKSS20	59UE20X20	4000	1 1/4	1 1/4	59SKSS20
					59UE24X24	4000	1 1/2	1 1/2	59SKSS24
									
59UI Femelle o'ring boss / Mâle JIC Female o'ring boss / Male JIC					59UC Femelle NPSM tournant / Mâle NPTF Female NPSM swivel / Male NPTF				
Numéro Part number	PSI	A (")	B (")	Ensemble Repair kit	Numéro Part number	PSI	A (")	B (")	Ensemble Repair kit
59UI06X04	5000	3/8	1/4	59SKSS04	59UC04X04	5000	1/4	1/4	59SKSS04
59UI06X06	5000	3/8	3/8	59SKSS04	59UC04X06	5000	1/4	3/8	59SKSS04
59UI08X08	5000	1/2	1/2	59SKSS08	59UC06X04	5000	3/8	1/4	59SKSS04
59UI08X10	5000	1/2	5/8	59SKSS08	59UC06X06	5000	3/8	3/8	59SKSS08
59UI12X12	4500	3/4	3/4	59SKSS12	59UC08X08	5000	1/2	1/2	59SKSS08
59UI16X16	4000	1	1	59SKSS16	59UC12X12	4500	3/4	3/4	59SKSS12
59UI20X20	4000	1 1/4	1 1/4	59SKSS20	59UC16X16	4000	1	1	59SKSS16
					59UC20X20	4000	1 1/4	1 1/4	59SKSS20
					59UC24X24	4000	1 1/2	1 1/2	59SKSS24
									
59UIBH Femelle o'ring boss / Mâle JIC cloison Female o'ring boss / Male JIC bulkhead					59UD Femelle NPSM tournant / Mâle o'ring boss Female NPSM swivel / Male o'ring boss				
Numéro Part number	PSI	A (")	B (")	Ensemble Repair kit	Numéro Part number	PSI	A (")	B (")	Ensemble Repair kit
59UIBH08X08	5000	1/2	1/2	59SKSS08	59UD04X04	5000	1/4	1/4	59SKSS04
59UIBH08X10	5000	1/2	5/8	59SKSS08	59UD04X06	5000	1/4	3/8	59SKSS04
59UIBH12X12	4500	3/4	3/4	59SKSS12	59UD06X06	5000	3/8	3/8	59SKSS04
59UIBH16X16	4000	1	1	59SKSS16	59UD06X08	5000	3/8	1/2	59SKSS08
59UIBH20X20	4000	1 1/4	1 1/4	59SKSS20	59UD08X08	5000	1/2	1/2	59SKSS08
					59UD08X10	5000	1/2	5/8	59SKSS08
					59UD12X12	4500	3/4	3/4	59SKSS12
					59UD16X16	4000	1	1	59SKSS16
					59UD20X20	4000	1 1/4	1 1/4	59SKSS20
					59UD24X24	4000	1 1/2	1 1/2	59SKSS24

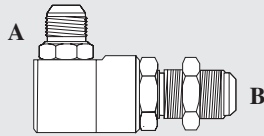
									
59UK Femelle NPSM tournant / Mâle JIC Female NPSM swivel / Male JIC					59UA Mâle JIC / Mâle NPTF Male JIC / Male NPTF				
Numéro Part number	PSI	A (")	B (")	Ensemble Repair kit	Numéro Part number	PSI	A (")	B (")	Ensemble Repair kit
59UK04X04	5000	1/4	1/4	59SKSS04	59UA04X04	5000	1/4	1/4	59SKSS04
59UK04X06	5000	1/4	3/8	59SKSS04	59UA06X04	5000	3/8	1/4	59SKSS04
59UK06X06	5000	3/8	3/8	59SKSS04	59UA06X06	5000	3/8	3/8	59SKSS04
59UK06X08	5000	3/8	1/2	59SKSS08	59UA08X06	5000	1/2	3/8	59SKSS08
59UK08X08	5000	1/2	1/2	59SKSS08	59UA08X08	5000	1/2	1/2	59SKSS08
59UK08X10	5000	1/2	5/8	59SKSS08	59UA10X08	5000	5/8	1/2	59SKSS08
59UK12X12	4500	3/4	3/4	59SKSS12	59UA12X12	4500	3/4	3/4	59SKSS12
59UK16X16	4000	1	1	59SKSS16	59UA16X16	4000	1	1	59SKSS16
59UK20X20	4000	1 1/4	1 1/4	59SKSS20	59UA20X20	4000	1 1/4	1 1/4	59SKSS20
59UK24X24	4000	1 1/2	1 1/2	59SKSS24	59UA24X24	4000	1 1/2	1 1/2	59SKSS24
									
59UKBH Femelle NPSM tournant / Mâle JIC cloison Female NPSM swivel / Male JIC cloison					59UB Mâle JIC / Mâle o'ring boss Male JIC / Male o'ring boss				
Numéro Part number	PSI	A (")	B (")	Ensemble Repair kit	Numéro Part number	PSI	A (")	B (")	Ensemble Repair kit
59UKBH06X08	5000	3/8	1/2	59SKSS08	59UB04X04	5000	1/4	1/4	59SKSS04
59UKBH08X08	5000	1/2	1/2	59SKSS08	59UB06X06	5000	3/8	3/8	59SKSS04
59UKBH08X10	5000	1/2	5/8	59SKSS08	59UB08X08	5000	1/2	1/2	59SKSS08
59UKBH12X12	4500	3/4	3/4	59SKSS12	59UB10X10	5000	5/8	5/8	59SKSS08
59UKBH16X16	4000	1	1	59SKSS16	59UB12X12	4500	3/4	3/4	59SKSS12
59UKBH20X20	4000	1 1/4	1 1/4	59SKSS20	59UB16X16	4000	1	1	59SKSS16
									
59UH Mâle JIC / Femelle NPTF Male JIC / Female NPTF					59UJ Mâle JIC / Mâle JIC Male JIC / Male JIC				
Numéro Part number	PSI	A (")	B (")	Ensemble Repair kit	Numéro Part number	PSI	A (")	B (")	Ensemble Repair kit
59UH04X04	5000	1/4	1/4	59SKSS04	59UJ04X04	5000	1/4	1/4	59SKSS04
59UH06X04	5000	3/8	1/4	59SKSS04	59UJ06X06	5000	3/8	3/8	59SKSS06
59UH06X06	5000	3/8	3/8	59SKSS08	59UJ08X08	5000	1/2	1/2	59SKSS08
59UH08X06	5000	1/2	3/8	59SKSS08	59UJ10X10	5000	5/8	5/8	59SKSS08
59UH08X08	5000	1/2	1/2	59SKSS08	59UJ12X12	4500	3/4	3/4	59SKSS12
59UH10X08	5000	5/8	1/2	59SKSS08	59UJ16X16	4000	1	1	59SKSS16
59UH12X12	4500	3/4	3/4	59SKSS12	59UJ20X20	4000	1 1/4	1 1/4	59SKSS20
59UH16X16	4000	1	1	59SKSS16	59UJ24X24	4000	1 1/2	1 1/2	59SKSS24
59UH20X20	4000	1 1/4	1 1/4	59SKSS20					
59UH24X24	4000	1 1/2	1 1/2	59SKSS24					

59UJBH
Mâle JIC / Mâle JIC cloison
Male JIC / Male JIC bulkhead

Numéro Part number	PSI	A (")	B (")	Ensemble Repair kit
59UJBH08X08	5000	1/2	1/2	59SKSS08
59UJBH10X10	5000	5/8	5/8	59SKSS08
59UJBH12X12	4500	3/4	3/4	59SKSS12
59UJBH16X16	4000	1	1	59SKSS16
59UJBH20X20	4000	1 1/4	1 1/4	59SKSS20

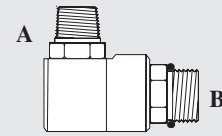
59UV
Mâle NPTF / Mâle o'ring boss
Male NPTF / Male o'ring boss

Numéro Part number	PSI	A (")	B (")	Ensemble Repair kit
59UV04X04	5000	1/4	1/4	59SKSS04
59UV04X06	5000	1/4	3/8	59SKSS04
59UV06X06	5000	3/8	3/8	59SKSS04
59UV06X08	5000	3/8	1/2	59SKSS08
59UV06X10	5000	3/8	5/8	59SKSS08
59UV08X08	5000	1/2	1/2	59SKSS08
59UV08X10	5000	1/2	5/8	59SKSS08
59UV12X12	4500	3/4	3/4	59SKSS12
59UV16X16	4000	1	1	59SKSS16
59UV20X20	4000	1 1/4	1 1/4	59SKSS20
59UV24X24	4000	1 1/2	1 1/2	59SKSS24

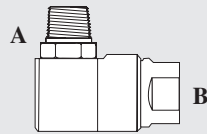
59UF
Mâle NPTF / Femelle NPTF
Male NPTF / Female NPTF

Numéro Part number	PSI	A (")	B (")	Ensemble Repair kit
59UF04X04	5000	1/4	1/4	59SKSS04
59UF06X06	5000	3/8	3/8	59SKSS08
59UF06X08	5000	3/8	1/2	59SKSS08
59UF08X06	5000	1/2	3/8	59SKSS08
59UF08X08	5000	1/2	1/2	59SKSS08
59UF12X12	4500	3/4	3/4	59SKSS12
59UF16X16	4000	1	1	59SKSS16
59UF20X20	4000	1 1/4	1 1/4	59SKSS20
59UF24X24	4000	1 1/2	1 1/2	59SKSS24

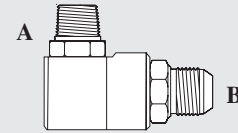
59UN
Mâle NPTF / Mâle JIC
Male NPTF / Male JIC



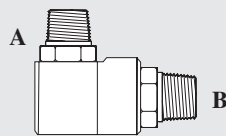

Numéro Part number	PSI	A (")	B (")	Ensemble Repair kit
59UN04X04	5000	1/4	1/4	59SKSS04
59UN04X06	5000	1/4	3/8	59SKSS04
59UN06X06	5000	3/8	3/8	59SKSS04
59UN06X08	5000	3/8	1/2	59SKSS08
59UN06X10	5000	3/8	5/8	59SKSS08
59UN08X08	5000	1/2	1/2	59SKSS08
59UN08X10	5000	1/2	5/8	59SKSS08
59UN12X12	4500	3/4	3/4	59SKSS12
59UN16X16	4000	1	1	59SKSS16
59UN20X20	4000	1 1/4	1 1/4	59SKSS20
59UN24X24	4000	1 1/2	1 1/2	59SKSS24

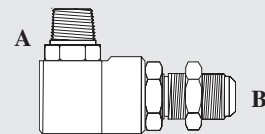

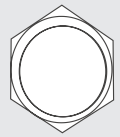
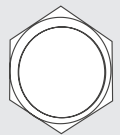

59UG
Mâle NPTF / Mâle NPTF
Male NPTF / Male NPTF





Numéro Part number	PSI	A (")	B (")	Ensemble Repair kit
59UG04X04	5000	1/4	1/4	59SKSS04
59UG06X04	5000	3/8	1/4	59SKSS04
59UG06X06	5000	3/8	3/8	59SKSS08
59UG06X08	5000	3/8	1/2	59SKSS08
59UG08X06	5000	1/2	3/8	59SKSS08
59UG08X08	5000	1/2	1/2	59SKSS08
59UG12X12	4500	3/4	3/4	59SKSS12
59UG16X16	4000	1	1	59SKSS16
59UG20X20	4000	1 1/4	1 1/4	59SKSS20
59UG24X24	4000	1 1/2	1 1/2	59SKSS24

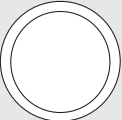
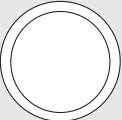

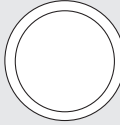
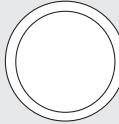

59UNBH
Mâle NPTF / Mâle JIC cloison
Male NPTF / Male JIC bulkhead

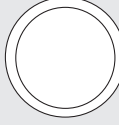
Numéro Part number	PSI	A (")	B (")	Ensemble Repair kit
59UNBH06X08	5000	3/8	1/2	59SKSS08
59UNBH08X08	5000	1/2	1/2	59SKSS08
59UNBH08X10	5000	1/2	5/8	59SKSS08
59UNBH12X12	4500	3/4	3/4	59SKSS12
59UNBH16X16	4000	1	1	59SKSS16
59UNBH20X20	4000	1 1/4	1 1/4	59SKSS20

O'RING AND NUT	
	
711FSO Écrou cloison JIC-o'ring boss JIC-o'ring boss bulkhead nut	
Numéro Part number	Dimension Size
711FSO04	1/4
711FSO05	5/16
711FSO06	3/8
711FSO08	1/2
711FSO10	5/8
711FSO12	3/4
711FSO16	1
711FSO20	1-1/4
711FSO24	1-1/2
	
711TTO Écrou cloison o'ring face O'ring face bulkhead nut	
Numéro Part number	Dimension Size
711TTO04	1/4
711TTO06	3/8
711TTO08	1/2
711TTO10	5/8
711TTO12	3/4
711TTO16	1
711TTO20	1-1/4
711TTO24	1-1/2
	
710FSO O'ring ORB (o'ring boss)	
Numéro Part number	Dimension Size
710FSO01	1/16
710FSO02	1/8
710FSO03	3/16
710FSO04	1/4
710FSO05	5/16
710FSO06	3/8
710FSO07	7/16
710FSO08	1/2
710FSO10	5/8
710FSO12	3/4
710FSO14	7/8
710FSO16	1
710FSO20	1-1/4
710FSO24	1-1/2
710FSO32	2
	
710FSM O'ring (o'ring boss métrique) O'ring (metric o'ring boss)	
Numéro Part number	Dimension Size
710FSM08	8mm
710FSM10	10mm
710FSM12	12mm
710FSM14	14mm
710FSM16	16mm
710FSM18	18mm
	
711BPO Écrou cloison BSPP BSPP bulkhead nut	
Numéro Part number	Dimension Size
711BPO02	1/8
711BPO04	1/4
711BPO06	3/8
711BPO08	1/2
711BPO10	5/8
711BPO12	3/4
711BPO16	1
711BPO20	1-1/4
711BPO24	1-1/2
	
710TTO O'ring (o'ring face)	
Numéro Part number	Dimension Size
710TTO02	1/8
710TTO04	1/4
710TTO06	3/8
710TTO08	1/2
710TTO10	5/8

<table border="1"> <thead> <tr> <th>Numéro Part number</th> <th>Dimension Size</th> </tr> </thead> <tbody> <tr> <td>710TTO12</td> <td>3/4</td> </tr> <tr> <td>710TTO16</td> <td>1</td> </tr> <tr> <td>710TTO20</td> <td>1-1/4</td> </tr> <tr> <td>710TTO24</td> <td>1-1/2</td> </tr> </tbody> </table>	Numéro Part number	Dimension Size	710TTO12	3/4	710TTO16	1	710TTO20	1-1/4	710TTO24	1-1/2	 <p>PA77 O'ring bride PA-PH PA-PH flange o'ring</p> <table border="1"> <thead> <tr> <th>Numéro Part number</th> <th>Dimension Size</th> </tr> </thead> <tbody> <tr> <td>08PA77</td> <td>1/2</td> </tr> <tr> <td>12PA77</td> <td>3/4</td> </tr> <tr> <td>16PA77</td> <td>1</td> </tr> <tr> <td>20PA77</td> <td>1-1/4</td> </tr> <tr> <td>24PA77</td> <td>1-1/2</td> </tr> <tr> <td>32PA77</td> <td>2</td> </tr> </tbody> </table>	Numéro Part number	Dimension Size	08PA77	1/2	12PA77	3/4	16PA77	1	20PA77	1-1/4	24PA77	1-1/2	32PA77	2																										
Numéro Part number	Dimension Size																																																		
710TTO12	3/4																																																		
710TTO16	1																																																		
710TTO20	1-1/4																																																		
710TTO24	1-1/2																																																		
Numéro Part number	Dimension Size																																																		
08PA77	1/2																																																		
12PA77	3/4																																																		
16PA77	1																																																		
20PA77	1-1/4																																																		
24PA77	1-1/2																																																		
32PA77	2																																																		
<p>710ORO O'ring pour bague de retenue BSPP BSPP retainer ring o'ring</p>  <table border="1"> <thead> <tr> <th>Numéro Part number</th> <th>Dimension Size</th> </tr> </thead> <tbody> <tr> <td>710ORO02</td> <td>1/8</td> </tr> <tr> <td>710ORO04</td> <td>1/4</td> </tr> <tr> <td>710ORO06</td> <td>3/8</td> </tr> <tr> <td>710ORO08</td> <td>1/2</td> </tr> <tr> <td>710ORO10</td> <td>5/8</td> </tr> <tr> <td>710ORO12</td> <td>3/4</td> </tr> <tr> <td>710ORO16</td> <td>1</td> </tr> <tr> <td>710ORO20</td> <td>1-1/4</td> </tr> <tr> <td>710ORO24</td> <td>1-1/2</td> </tr> </tbody> </table>	Numéro Part number	Dimension Size	710ORO02	1/8	710ORO04	1/4	710ORO06	3/8	710ORO08	1/2	710ORO10	5/8	710ORO12	3/4	710ORO16	1	710ORO20	1-1/4	710ORO24	1-1/2	 <p>PA77V O'ring bride PA-PH (viton) PA-PH flange o'ring (viton)</p> <table border="1"> <thead> <tr> <th>Numéro Part number</th> <th>Dimension Size</th> </tr> </thead> <tbody> <tr> <td>08PA77V</td> <td>1/2</td> </tr> <tr> <td>12PA77V</td> <td>3/4</td> </tr> <tr> <td>16PA77V</td> <td>1</td> </tr> <tr> <td>20PA77V</td> <td>1-1/4</td> </tr> <tr> <td>24PA77V</td> <td>1-1/2</td> </tr> <tr> <td>32PA77V</td> <td>2</td> </tr> </tbody> </table>	Numéro Part number	Dimension Size	08PA77V	1/2	12PA77V	3/4	16PA77V	1	20PA77V	1-1/4	24PA77V	1-1/2	32PA77V	2																
Numéro Part number	Dimension Size																																																		
710ORO02	1/8																																																		
710ORO04	1/4																																																		
710ORO06	3/8																																																		
710ORO08	1/2																																																		
710ORO10	5/8																																																		
710ORO12	3/4																																																		
710ORO16	1																																																		
710ORO20	1-1/4																																																		
710ORO24	1-1/2																																																		
Numéro Part number	Dimension Size																																																		
08PA77V	1/2																																																		
12PA77V	3/4																																																		
16PA77V	1																																																		
20PA77V	1-1/4																																																		
24PA77V	1-1/2																																																		
32PA77V	2																																																		
<p>710ORM O'ring pour bague de retenue métrique Metric retainer ring o'ring</p>  <table border="1"> <thead> <tr> <th>Numéro Part number</th> <th>Dimension Size</th> </tr> </thead> <tbody> <tr> <td>710ORM08</td> <td>8mm</td> </tr> <tr> <td>710ORM10</td> <td>10mm</td> </tr> <tr> <td>710ORM12</td> <td>12mm</td> </tr> <tr> <td>710ORM14</td> <td>14mm</td> </tr> <tr> <td>710ORM16</td> <td>16mm</td> </tr> <tr> <td>710ORM18</td> <td>18mm</td> </tr> <tr> <td>710ORM20</td> <td>20mm</td> </tr> <tr> <td>710ORM22</td> <td>22mm</td> </tr> <tr> <td>710ORM24</td> <td>24mm</td> </tr> <tr> <td>710ORM26</td> <td>26mm</td> </tr> <tr> <td>710ORM27</td> <td>27mm</td> </tr> <tr> <td>710ORM30</td> <td>30mm</td> </tr> <tr> <td>710ORM33</td> <td>33mm</td> </tr> <tr> <td>710ORM36</td> <td>36mm</td> </tr> </tbody> </table>	Numéro Part number	Dimension Size	710ORM08	8mm	710ORM10	10mm	710ORM12	12mm	710ORM14	14mm	710ORM16	16mm	710ORM18	18mm	710ORM20	20mm	710ORM22	22mm	710ORM24	24mm	710ORM26	26mm	710ORM27	27mm	710ORM30	30mm	710ORM33	33mm	710ORM36	36mm	 <p>710RRO Bague de retenue BSPP BSPP retainer ring</p> <table border="1"> <thead> <tr> <th>Numéro Part number</th> <th>Dimension Size</th> </tr> </thead> <tbody> <tr> <td>710RRO02</td> <td>1/8</td> </tr> <tr> <td>710RRO04</td> <td>1/4</td> </tr> <tr> <td>710RRO06</td> <td>3/8</td> </tr> <tr> <td>710RRO08</td> <td>1/2</td> </tr> <tr> <td>710RRO10</td> <td>5/8</td> </tr> <tr> <td>710RRO12</td> <td>3/4</td> </tr> <tr> <td>710RRO16</td> <td>1</td> </tr> <tr> <td>710RRO20</td> <td>1-1/4</td> </tr> <tr> <td>710RRO24</td> <td>1-1/2</td> </tr> </tbody> </table>	Numéro Part number	Dimension Size	710RRO02	1/8	710RRO04	1/4	710RRO06	3/8	710RRO08	1/2	710RRO10	5/8	710RRO12	3/4	710RRO16	1	710RRO20	1-1/4	710RRO24	1-1/2
Numéro Part number	Dimension Size																																																		
710ORM08	8mm																																																		
710ORM10	10mm																																																		
710ORM12	12mm																																																		
710ORM14	14mm																																																		
710ORM16	16mm																																																		
710ORM18	18mm																																																		
710ORM20	20mm																																																		
710ORM22	22mm																																																		
710ORM24	24mm																																																		
710ORM26	26mm																																																		
710ORM27	27mm																																																		
710ORM30	30mm																																																		
710ORM33	33mm																																																		
710ORM36	36mm																																																		
Numéro Part number	Dimension Size																																																		
710RRO02	1/8																																																		
710RRO04	1/4																																																		
710RRO06	3/8																																																		
710RRO08	1/2																																																		
710RRO10	5/8																																																		
710RRO12	3/4																																																		
710RRO16	1																																																		
710RRO20	1-1/4																																																		
710RRO24	1-1/2																																																		

 710RRM Bague de retenue métrique Metric retainer ring		Numéro Part number	Dimension Size
		710BSM10 710BSM12 710BSM14 710BSM16 710BSM18 710BSM20 710BSM22 710BSM24 710BSM26 710BSM27 710BSM30 710BSM33 710BSM36 710BSM42 710BSM52	10mm 12mm 14mm 16mm 18mm 20mm 22mm 24mm 26mm 27mm 30mm 33mm 36mm 42mm 52mm
Numéro Part number	Dimension Size	 712BSP Rondelle de cuivre BSPP BSPP copper washer	
710RRM08 710RRM10 710RRM12 710RRM14 710RRM16 710RRM18 710RRM20 710RRM22 710RRM24 710RRM26 710RRM27 710RRM30 710RRM33 710RRM36	8mm 10mm 12mm 14mm 16mm 18mm 20mm 22mm 24mm 26mm 27mm 30mm 33mm 36mm		
 710BSB Joint étanche BSPP Bonded seal BSPP		Numéro Part number	Dimension Size
		712BSP02 712BSP04 712BSP06 712BSP08 712BSP10 712BSP12 712BSP16 712BSP20 712BSP24 712BSP32	1/8 1/4 3/8 1/2 5/8 3/4 1 1-1/4 1-1/2 2
Numéro Part number	Dimension Size	 712MET Rondelle de cuivre métrique Metric copper washer	
710BSB02 710BSB04 710BSB06 710BSB08 710BSB10 710BSB12 710BSB16 710BSB20 710BSB24 710BSB32	1/8 1/4 3/8 1/2 5/8 3/4 1 1-1/4 1-1/2 2		
 710BSM Joint étanche métrique Bonded seal metric		Numéro Part number	Dimension Size
		712MET08 712MET10 712MET12 712MET14 712MET16 712MET18 712MET22 712MET26	8mm 10mm 12mm 14mm 16mm 18mm 22mm 26mm
Numéro Part number	Dimension Size	710BSM06 710BSM08	
710BSM06 710BSM08	6mm 8mm		

 KITSEAL Ensembles de joints étanches O'ring kit		Numéro Part number	
Numéro Part number	Description		
KITSEAL1	Bonded seal (157 pcs)		
KITSEAL2	O'ring et / and retaining ring (100 pcs)		
KITSEAL3	O'ring boss et / and o'ring face (175 pcs)		
 PA Bride (code 61) Flange (code 61)			
Numéro Part number	Dimension (" Size ("		
08PA	1/2		
12PA	3/4		
16PA	1		
20PA	1-1/4		
24PA	1-1/2		
32PA	2		
 PH Bride (code 62) Flange (code 62)			
Numéro Part number	Dimension (" Size ("	Numéro Part number	
08PH	1/2		
12PH	3/4		
16PH	1		
20PH	1-1/4		
24PH	1-1/2		
32PH	2		

INDEX

# PIÈCE PART #	PAGE	# PIÈCE PART #	PAGE	# PIÈCE PART #	PAGE
1942FS	57	59UD	63	632FS	30
1942FSM	59	59UE	63	639FS	29
1946FS	57	59UF	65	639FSJ	29
1948FS	57	59UG	65	639FSK	39
1948FSM	59	59UH	64	639FSM	38
1949FS	58	59UI	63	639FSMO	38
1949FSM	59	59UIBH	63	639FSMR	38
1954FS	58	59UJ	64	639FSR	29
1955FS	58	59UJBH	65	63SB	52
1955FSM	59	59UK	64	63SE	52
1960FS	57	59UKBH	64	63SF	52
1960FSM	58	59UL	62	63TA	51
1961FS	57	59ULBH	62	63TB	53
1961FSM	58	59UN	65	63TE	53
24SA	2	59UNBH	65	63TF	53
24SB	1	59UO	62	63UA	51
24SF	1	59UP	61	63UB	53
24SG	2	59UQ	63	63UC	51
24SJ	2	59UR	62	63UE	53
24SR	1	59US	62	63UF	54
24ST	1	59UT	62	642FS	30
25SP	1	59UV	65	642FSJ	30
25TA	3	60SA	5	642FSK	39
25TG	2	60SB	7	642FSM	39
25TJ	3	60SG	5	644FS	33
25UA	3	60TA	6	646FS	35
25UASW	4	60TB	8	646FSM	36
25UG	3	60TG	6	646FSO	37
25UGSW	3	60UA	6	646TT	36
25UJ	3	60UB	8	648FS	34
25VA	5	60UC	6	648FSM	36
25VC	4	60UG	7	648FSO	37
25VG	4	60VC	7	648TT	36
25VJ	4	60VH	7	649FS	36
25VK	4	60VJ	7	649TT	37
25VT	4	618TT	40	64SB	55
25WJ	5	619TT	41	64SF	56
579FS	57	61SA	5	64TA	55
589FS	56	61TA	52	64TB	56
59SA	61	61UA	52	64TF	56
59SB	61	622FS	41	64UA	55
59SJ	61	623FSO	40	64UB	56
59SJBH	61	626FS	41	64UC	55
59SL	60	626FSO	40	64UF	56
59SP	60	628FS	41	655FS	32
59SS	60	62TA	54	655FSA	32
59ST	60	62TD	54	656FSA	32
59SX	60	62UA	55	661FS	33
59SXBH	60	62UD	55	670FS	33
59SZ	61	630FS	29	671FS	34
59UA	64	630FSJ	29	672FS	34
59UB	64	630FSK	39	673FS	34
59UC	63	630FSM	37	673FSSW	34

INDEX

# PIÈCE PART #	PAGE	# PIÈCE PART #	PAGE	# PIÈCE PART #	PAGE
674FS	32	836FS	29	849FSO	21
675FS	33	839FS	8	849LFS	16
677FS	34	839TT	42	849LFSO	21
679FS	33	840FS	9	849LLFS	16
679FSB	33	841FS	9	849LLFSO	21
680FS	31	841TT	42	849TT	46
680FSM	39	842FS	10	849TTO	48
680FSSW	31	842TT	42	850FS	17
681FS	35	844FS	12	850FSB	25
681FSM	36	844TT	44	851FS	18
681FSO	37	845FS	17	851FSB	26
681FSSW	35	845FSB	26	851FSO	22
682FS	35	845FSO	21	851TTO	48
683FS	30	845TTO	48	852FS	13
683FSMH	40	846FS	14	852TT	45
683FSML	39	846FSB	24	853FS	18
683FSMS	40	846FSBSW	24	854BHFS	11
683FSSW	31	846FSH	24	854BHTT	43
698FS	32	846FSHSW	25	854FS	15
699FS	32	846FSJ	24	854FSB	25
710BSB	68	846FSK	28	854FSO	20
710BSM	68	846FSMH	28	854TT	46
710FSM	66	846FSML	27	854TTO	47
710FSO	66	846FSV	22	855BHFS	11
710ORM	67	846TT	46	855BHTT	44
710ORO	67	846TTJ	22	855FS	11
710RRM	68	846TTJSW	22	855TT	43
710RRO	67	846TTO	47	856FS	11
710TTO	66	847FS	15	857FS	18
711BPO	66	848BHFS	14	858FS	18
711FSO	66	848FS	13	859FS	19
711TTO	66	848FSB	23	860FS	18
712BSP	68	848FSBJ	23	861FS	12
712MET	68	848FSBL	23	861TT	44
719FSO	48	848FSBLL	24	862FS	19
720FSO	50	848FSJ	24	863FS	19
721FSO	49	848FSK	27	870FS	12
722FSO	50	848FSKB	27	870TT	44
723FSO	49	848FSM	26	871FS	12
725FSO	51	848FSMH	27	871TT	44
725LFSO	51	848FSML	26	872FS	13
726FSO	50	848FSO	19	872TT	45
728FSO	50	848FSV	22	873FS	13
729FSO	51	848LFS	14	875FS	12
742FSO	49	848LFSO	20	877FS	17
755FSO	49	848LLFS	14	878FS	17
779FSO	49	848LTTO	47	878FSB	26
780FSO	49	848TT	45	878FSO	20
830FS	8	848TTJ	22	878TTO	47
830TT	42	848TTO	46	879FS	11
832FS	10	849FS	16	879TT	44
832TT	43	849FSB	25	880FS	10
835FS	28	849FSM	28	880TT	43

INDEX

# PIÈCE PART #	PAGE	# PIÈCE PART #	PAGE	# PIÈCE PART #	PAGE
881FS	15				
881FSB	25				
881FSM	28				
881FSO	20				
881TT	45				
881TTJ	23				
881TTO	47				
882FS	15				
882FSB	25				
882TT	45				
883FS	9				
883FSSW	10				
883TT	42				
883TTR	42				
889FS	11				
889TT	43				
KITSEAL	69				
PA	54 et 69				
PA77	67				
PA77V	67				
PH	54 et 69				