



STRONGARM[®]

CATALOGUE

Lifting & Hydraulic Equipment

**2012
2013**

Date of publication: Nov 2012
 Product Number: **899913**

JET makes every effort to ensure that the information in this catalogue is current and accurate, however cannot accept responsibility and or liability for any loss or damage suffered as a result of information contained herein. Products may be discontinued and specifications may be subject to change without notice. The trademarks, logos and service marks printed in this catalogue are registered and unregistered trademarks of this company and no trademark license either expressed or implied is granted by **JET**. Trademarks printed in this catalogue can not be used without prior written permission of **JET Equipment & Tools Ltd.**



WEST



VANCOUVER, BC

Head Office
 49 Schooner Street
 Coquitlam, BC V3K 0B3
Tel: (604) 523-TOOL (8665)
Toll Free Tel: 1-800-472-7685
Fax: (604) 526-JET1 (5381)
Toll Free Fax: 1-800-663-7742



EDMONTON, AB

9720 – 12th Avenue SW
 Edmonton, AB T6X 0J5
Toll Free Tel: 1-800-472-7685
Toll Free Fax: 1-800-663-7742



WINNIPEG, MB

951 Powell Avenue
 Winnipeg, MB R3H 0H4
Tel: (204) 632-6970
Toll Free Tel: 1-800-665-7524
Fax: (204) 694-9534
Toll Free Fax: 1-877-694-9534

EAST



TORONTO, ON

979 Gana Court
 Mississauga, ON L5S 1N9
Tel: (905) 565-8661
Toll Free Tel: 1-800-387-3879
Fax: (905) 565-7266
Toll Free Fax: 1-800-267-3310



MONTREAL, QC

3504, rue Griffith
 Ville St-Laurent, QC H4T 1A7
Toll Free Tel: 1-800-363-2885
Toll Free Fax: 1-800-267-3310



HALIFAX, NS

110 - 11 Morris Drive
 Dartmouth, NS B3B 1M2
Tel: (902) 468-8324
Toll Free Tel: 1-800-472-7686
Fax: (902) 468-3461
Toll Free Fax: 1-877-468-3461

	Bottle Jacks	4 - 5
Manually Operated		4
Air/Hydraulic		4
JET Industrial		5
JET Hydraulic Toe		5
JET Mechanical Screw Jacks		24

	Service Jacks	6 - 9, 12 - 13
Floor Jacks - Hydraulic		6 - 8
Floor Truck Jack - Air/Hydraulic		8
Truck Axle Air/Hydraulic Jacks		9
Air Lift Jacks		12 - 13
Fork Lift Hydraulic Jack		13

	Service Jacks - Multi-Stage	10 - 11
Truck Axle Air Hydraulic Jacks - SHD		10 - 11

	Specialty Truck Equipment	14 - 15
Clutch Jack and Accessories		14
Wheel and Brake Drum Dollies		15

	Stands	16 - 19
High Reach Fixed Stands - SHD		16
Truck Ramps - SHD		16
Under-Hoist Component Stands		17
Under-Hoist Stabilizing Stands		17
Jack Stands		18 - 19

	Transmission Jacks	20 - 22
Underhoist - Telescopic		20 - 21
Fuel Tank Adaptor		21
Low Profile Truck		22

	Engine Stands	23
---	----------------------	-----------

	Cranes - Hydraulic	25 - 27
Engine Cranes		25 - 26
Engine Tilters and Supports		27

	Shop Presses	28 - 31
Floor Presses - Standard Duty		28
Floor Presses - Heavy Duty		29
Floor Presses - SHD		30 - 31

	Collision Repair	32 - 33
Collision Repair - SHD		32
Body Repair - Heavy Duty		33

	Rams & Pumps	34 - 35
Hand Pumps - Hydraulic		34
Foot Pumps - Air/Hydraulic		34
Rams - Hydraulic		35
Long Ram Jacks		35
Hydraulic Hose - 10,000 PSI		35

Index	36
By Model Number	36
By Product Number	36
Alphabetical	36

Warranty	37
-----------------	-----------

CAT13-SA-11/2012/10M

SP100TASHD	032187	Shop Press - Super Heavy Duty	31
BRK-4T	030202	4 Ton Body Repair Kit	33
BRK-10T	030207	10 Ton Body Repair Kit	33
BRKSPRAM	030230	1/2 Ton Spreader Ram	33
BRK4PH	030283	Hydraulic Pump and Hose for 030202	34
BRK10PH	030284	Hydraulic Pump and Hose for 030207	34
BRK4RAM	030241	4 Ton Push Ram	35
BRK10RAM	030242	10 Ton Push Ram	35
BRKH	030292	Hydraulic Hose for 030202 / 030207	35
401A	030212	Air/Hydraulic Foot Pump - Heavy Duty	34



new

New Products



MANUALLY OPERATED - HEAVY DUTY

- Available in 2 – 50 ton capacities
- 12 and 20 ton models available in standard and low profile versions
- Can be used in vertical and horizontal positions (valve side down)
- Factory pre-tested to 150% of rated capacity
- Heat treated piston for maximum strength
- Heavy duty steel saddle for secure lifts
- Centred pump and ram for balance and easy positioning
- Convenient carrying handle on 12 – 50 ton models
- Model 352A is equipped with a second large diameter plunger for faster contact with load



MOD. NO.	PROD. NO.	Style	Cap. (Tons)	Low Height	High Height	Lift	Screw Ext.	Shipping Weight
302A	030102	Standard	2	6-1/4"	12-1/2"	3-3/4"	2-1/2"	6 lb (3 kg)
304A	030103	Standard	4	6-3/4"	12-1/4"	3-1/4"	2-1/4"	8 lb (4 kg)
306A	030104	Standard	6	8"	16"	5-1/4"	2-3/4"	11 lb (5 kg)
308A	030105	Standard	8	7-3/4"	15-3/4"	5-1/4"	2-3/4"	13 lb (6 kg)
312A	030106	Standard	12	8-1/2"	17"	5-3/4"	2-3/4"	17 lb (8 kg)
314A	030107	Low Profile	12	7"	13"	4"	2"	15 lb (7 kg)
320A	030110	Standard	20	9-1/2"	18-1/4"	6-1/4"	2-1/2"	27 lb (12 kg)
322A	030111	Low Profile	20	7-3/4"	14-3/4"	4-1/2"	2-1/2"	23 lb (10 kg)
330A	030112	Standard	30	11-1/4"	18-3/4"	7-1/2"	-	44 lb (20 kg)
350A	030114	Standard	50	11-3/4"	19-3/4"	8"	-	74 lb (33 kg)
*352A	030115	Double Plunger	50	11-3/4"	19-3/4"	8"	-	94 lb (42 kg)



***352A • 030115**

Equipped with a second large diameter plunger for faster contact to the load

370C • 030152

Bottle jacks can be used in vertical and horizontal positions



AIR/HYDRAULIC - HEAVY DUTY

- Designed for use with compressed air systems at 90 PSI - quicker and faster than manual jacks!
- Factory pre-tested to 150% of rated capacity
- Heat treated piston for maximum strength
- Heavy duty steel saddle for secure lifts
- Convenient carrying handle
- Bypass mechanism prevents internal damage from over pumping

MOD. NO.	PROD. NO.	Style	Cap. (Tons)	Low Height	High Height	Lift	Screw Ext.	Shipping Weight
370C	030152	Air/Hydraulic	12	10-1/4"	19-1/2"	7"	2-1/2"	30 lb (14 kg)
380C	030157	Air/Hydraulic	20	10-1/2"	20"	6-1/4"	2-1/2"	38 lb (17 kg)
735	030442	Air/Hydraulic	35	11"	16-3/4"	21-1/4"	55"	101 lb (45 kg)

735 • 030442

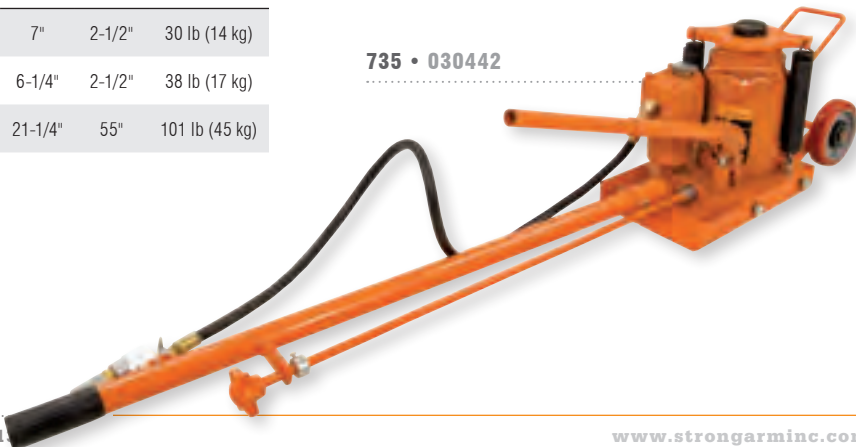

JET INDUSTRIAL BOTTLE JACKS

JHJ SERIES - SUPER HEAVY DUTY

- JET industrial hydraulic bottle jacks have earned a reputation for super heavy duty performance, reliability and dependability for over 40 years
- Electrically welded base and cylinder assures strength and eliminates leaks
- Not affected by temperature extremes
- All models work in upright, angle or horizontal positions
- Unique valving allows handle to remain in upright position when used horizontally for improved operation
- Cleated steel lift saddle for safest operator conditions
- Equipped with convenient extension screw for low pick up height adjustment
- Available in Standard and Low Profile models (LP)
- Fully serviceable; common release valve assemblies and other interchangeable parts allow quick repairs
- Rigidly adheres to JIS and ANSI standards
- Tested to over 150% of rated capacities
- Made in Japan



See page **24** for
Mechanical Screw Jacks



MOD. NO.	PROD. NO.	Rated Capacity (Tons)	Closed Height	Piston Travel	Head Screw Height	Maximum Height	Base Size	Handle Type (piece)	Shipping Weight
JHJ-2	140101	2	7-1/8"	4-1/2"	2"	13-5/8"	4-5/16" x 2-9/16"	2	5.5 lb (2.5 kg)
JHJ-3	140102	3	7-1/2"	4-1/2"	2-3/8"	14-3/8"	4-1/2" x 2-13/16"	2	6.8 lb (3 kg)
JHJ-5	140103	5	7-7/8"	4-3/4"	2-3/4"	15-3/8"	5-3/16" x 2-15/16"	3	8.8 lb (4 kg)
JHJ-8	140104	8	7-7/8"	4-3/4"	2-3/4"	15-3/8"	6" x 3-1/2"	3	12.2 lb (5.6 kg)
JHJ-12-1/2	140105	12-1/2	9-1/2"	5-7/8"	3-1/8"	18-1/2"	6-1/2" x 4-3/16"	3	17.7 lb (8 kg)
JHJ-12-1/2LP	140106	12-1/2	6-3/4"	3-3/4"	3"	13-1/2"	6-1/2" x 4-3/16"	1	12.8 lb (5.8 kg)
JHJ-17-1/2	140107	17-1/2	10-7/16"	6-1/2"	3-1/8"	20-1/16"	7-1/8" x 4-5/8"	3	24 lb (10.9 kg)
JHJ-17-1/2LP	140108	17-1/2	6-3/4"	3-1/2"	2-3/4"	13"	7-1/8" x 4-5/8"	1	16.4 lb (7.5 kg)
JHJ-22-1/2	140109	22-1/2	10-5/8"	6-1/4"	–	16-7/8"	7-3/16" x 5-1/16"	3	29.5 lb (13.4 kg)
JHJ-22-1/2LP	140110	22-1/2	7-1/8"	3-3/8"	1-9/16"	12-1/16"	7-3/16" x 5-1/16"	1	19.7 lb (9 kg)
JHJ-35	140111	35	11"	6-1/4"	–	17-1/4"	7-9/16" x 5-9/16"	1	41 lb (18.5 kg)
JHJ-60	140112	60	12"	6-3/4"	–	18-3/4"	9-5/16" x 7-3/8"	1	82 lb (36.9 kg)

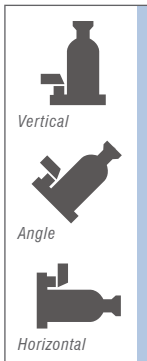

JET HYDRAULIC TOE JACKS

JTJ SERIES - SUPER HEAVY DUTY

- For use where exceptionally low pick up height is required
- Extra wide base for maximum stability
- Electrically welded base and cylinder assures strength and eliminates leaks
- 200° handle socket for operation from any direction
- Load can be applied to toe or head
- Capacity rated at toe and increases if load applied to head
- Complete with overload protection
- Not affected by temperature extremes
- Rigidly adheres to JIS and ANSI standards
- Tested to over 150% of rated capacities
- Made in Japan



MOD. NO.	PROD. NO.	Rated Capacity (Toe)	Rated Capacity (Head)	Minimum Height (Toe)	Maximum Height (Toe)	Minimum Height (Head)	Maximum Height (Head)	Base Size (L x W)	Shipping Weight
JTJ-5SV	149123	5 ton	6 ton	1"	5-5/8"	11-1/2"	16-1/8"	10-5/8" x 7-1/8"	51.7 lb (23.5 kg)
JTJ-10SV	149125	10 ton	14 ton	1-1/4"	6-3/4"	13"	18-1/2"	11-1/4" x 9-1/2"	85 lb (38.6 kg)



- All models designed for the professional user
- All models equipped with safety valve to prevent overloading
- Rear mounted swivel casters for easy manoeuvrability
- Heavy duty pump, ram and cylinders are precision machined and inspected to ensure long service life and superior performance

NOTE: Hydraulic Jacks are intended for lifting but not sustaining a partial vehicular load. Immediately after lifting, support the load with appropriate means such as high quality STRONGARM jack stands.



952B • 030415

2-1/2 TON

952B

SERVICE JACK - STANDARD DUTY

030415

- Model 952B has been the standard of the Canadian industry for over 20 years
- Heavy duty casters and saddle
- Two piece 40" handle
- A great floor jack for everyday use

Low Height	High Height	Length	Front Width	Rear Width	Shipping Weight
5"	19-1/4"	27"	10-3/4"	13"	93 lb (42 kg)

962 • 030411

Super low pickup height of 2-3/4"



2 TON

962

LOW RIDER SERVICE JACK - HEAVY DUTY

030411

- Super low pickup height of 2-3/4"
- Ideal for today's import cars and popular "Tuner" cars
- Equipped with a double pump design to increase speed without compromising overall performance of the jack
- Comes with padded handle and rubber saddle protector
- Safety valve prevents overload
- Universal joint technology for precision control of release valve
- Tough powder coated frame for longer shop life



Double Pump

Low Height	High Height	Length	Front Width	Rear Width	Shipping Weight
2-3/4"	20"	27"	11-3/4"	15"	95 lb (43 kg)



3-1/2 TON

965GTO

SERVICE JACK - HEAVY DUTY

030406

- The standard for tire and service shops in Canada
- Extra wide front casters for superior stability
- Two piece 50-1/4" padded handle and a rubber saddle
- Flanged side plates for increased strength and stability
- Universal joint technology for precision control of release valve
- Tough powder coated frame for longer shop life

Low Height	High Height	Length	Front Width	Rear Width	Shipping Weight
4"	19-1/2"	29"	11-1/4"	15"	119 lb (54 kg)

965GTO • 030406



3-1/2 TON

966HO

DOUBLE PUMPER SERVICE JACK - HEAVY DUTY

030407

- Same great quality features as Model 965GTO
- Equipped with a double pump design to increase speed without compromising overall performance of the jack
- Second volume pump assists in getting the saddle to load much quicker than most other single pump designs on the market today

Low Height	High Height	Length	Front Width	Rear Width	Shipping Weight
4"	19-1/2"	29"	11-1/4"	15"	120 lb (54 kg)

Double Pump

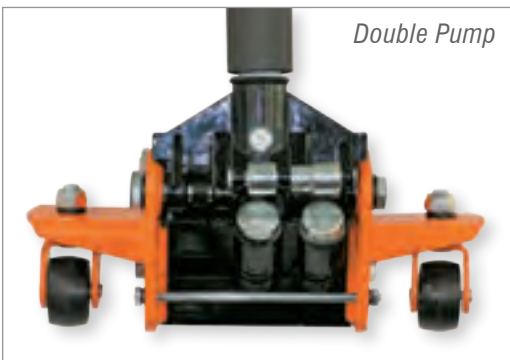

966HO • 030407





3-10 TON

LONG CHASSIS SERVICE JACK - HEAVY DUTY

- Heavy duty manually operated service jacks for the most demanding heavy duty applications
- Ideal for truck tire shops, truck repair shops, fleet service, maintenance shops, military bases, job sites and all heavy duty jobs
- Heavy duty pumps, rams, and cylinders are precision machined and inspected to ensure long service life and superior performance
- Designed to get into very low areas
- Automatic safety valve prevents overload
- Heavy duty swivel casters provide optimum manoeuvrability
- Handle mounted locking control lever locks handle in one of three positions: vertical, 45°, or horizontal for more convenient under vehicle positioning
- All models feature a convenient foot pedal for raising



T-Handle

MOD. NO.	PROD. NO.	Cap. (Tons)	Low Height	High Height	Length	Front Width	Rear Width	Shipping Weight
955	030434	5	6"	22-1/2"	59"	11-1/2"	15"	264 lb (119 kg)
957	030436	10	7"	23"	61"	13"	18"	373 lb (168 kg)

20 TON



LONG CHASSIS SERVICE JACK - SUPER HEAVY DUTY

MOD. NO.	PROD. NO.	Cap. (Tons)	Low Height	High Height	Length	Front Width	Rear Width	Shipping Weight
970SD	030438	20	7-3/4"	23-3/4"	67-1/2"	14-1/2"	19-5/8"	500 lb (225 kg)

5-10 TON

AIR/HYDRAULIC LONG CHASSIS SERVICE JACK - HEAVY DUTY

MOD. NO.	PROD. NO.	Cap. (Tons)	Low Height	High Height	Length	Front Width	Rear Width	Shipping Weight
956	030461	5	6"	22-1/2"	59"	11-1/2"	15"	273 lb (123 kg)
959	030466	10	7"	23"	61"	13"	18"	387 lb (175 kg)

- Same high quality features as the manually operated jacks but designed for use with compressed air systems between 115 - 200 PSI
- Uses 7.8 cu. ft./min. at 180 PSI
- May be used with or without air



T-Handle

955 • 030434

957 • 030436

970SD • 030438



SUPER HEAVY DUTY

959 • 030466



20 TON

728C

AIR/HYDRAULIC TRUCK JACK - HEAVY DUTY

030445

- For over 10 years model 728C has set the Canadian truck tire industry standard
- Corrosion-resistant aluminum and nylon composite air motor
- In-line filter to protect air motor from contaminants
- Heavy duty pump, ram and cylinders are precision machined and inspected to ensure long service life and superior performance
- Heat treated cylinder wall and chrome piston give added stability and longer jack life
- In-line oiler automatically provides lubrication for air motor, extending the life of the jack and overall performance
- Designed for lifting trucks, buses, trailers, and other heavy duty equipment
- Two piece 41" handle
- Operates at 90 - 180 PSI
- Standard accessories: 3 piece adaptor kit including 3/4", 2-3/4", and 4" extensions

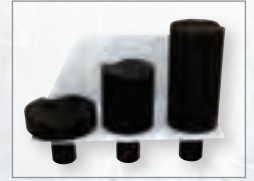

3 piece adaptor kit included as standard accessory



20 TON

SHD 720SD

AIR/HYDRAULIC TRUCK JACK - SUPER HEAVY DUTY

030448

- Canada's premium quality 20 ton axle jack
- This super duty work horse features a specially heat treated cylinder wall and chrome piston machined to super exacting tolerances ensuring premium performance, durability, life and safety
- Premium air motor lasts longer and is more reliable than competitive brands
- Safety valve prevents damage from overload
- Large diameter wheels assist in manoeuvrability
- Long T-handle with integrated release assists in jack positioning
- Handle lock allows the handle to be secured in the vertical, 45° or horizontal positions
- Ships in two cartons*



3 piece adaptor kit included as standard accessory



40 TON

SHD 740

AIR/HYDRAULIC TRUCK JACK - SUPER HEAVY DUTY

030443

- STRONGARM's largest capacity air / hydraulic single stage truck jack
- Outstanding durability and quality
- 41" one piece T-handle
- Large rubber tires for easy movement
- Heat treated cylinder wall to protect against scoring
- Operates at 90 - 180 PSI
- Easily handles full load roadside truck changes, agricultural equipment, heavy construction, bus and military applications
- **Optional accessories:** 740P12-1: 1-3/16" high
740P12-2: 2-3/4" high
740P12-3: 4-5/16" high

SHD SUPER HEAVY DUTY



SHD SUPER HEAVY DUTY

MOD. NO.	PROD. NO.	Cap. (Tons)	Ram Lift	Low Height	High Height	Length	Front Width	Rear Width	Shipping Weight
728C	030445	20	4-3/4"	8-3/4"	17-3/4"	20"	12-1/4"	12-1/4"	98 lb (44 kg)
720SD	030448	20	4-3/4"	8"	17"	20-1/8"	7-3/8"	12-7/8"	100 lb (45 kg)*
740	030443	40	3"	9-1/4"	16-1/4"	29-1/2"	19"	19"	145 lb (65 kg)



SHD SUPER HEAVY DUTY

30/15 TON

SHD 730SHD

**2 STAGE AIR HYDRAULIC TRUCK JACK
SUPER HEAVY DUTY**

030474

- The extra light weight and portability makes this the ideal service jack for service vehicles
- 2 stages and lifting capacities of 30 and 15 ton make this a very versatile jack
- The extra long removable handle and rugged rear wheels make for easy positioning of this jack in hard to reach places
- An integral Descent Metering Valve maintains a controlled and safe lowering of the load
- The piston head seal design is borrowed from industrial technology providing a superior low and high pressure seal, giving this jack a much better hold under severe load conditions
- Double polished chromed pistons allow for much tighter tolerances which reduce oil bypassing and reduced ram scoring
- Air assisted lowering speeds up ram retraction
- Built-in overload safety valve prevents damage to unit due to excessive load
- Comes with 2 extensions (75mm & 45mm) and saddle adaptor
- Units are tested to -25°C and +45°C as well as off centre loading to ensure a long life under even the harshest conditions

Cap. (Tons)	Low Height	High Height	Lift	Working Air Pressure	Shipping Weight
30	150 mm (5.92")	224 mm (8.82")	74 mm (2.91")	0.8 to 1.0 Mpa (116 to 145 PSI)	77 lb (35 kg)
15	150 mm (5.92")	292 mm (11.5")	142 mm (5.59")	—	—

50/25 TON

SHD 750SHD

**2 STAGE AIR HYDRAULIC TRUCK JACK
SUPER HEAVY DUTY**

030475

- Super Heavy Duty, 2 Stage 50 Ton and 25 Ton built tough for the rigors of the heavy duty trucking, agricultural and fleet business
- The piston head seal design is borrowed from industrial technology providing a superior low and high pressure seal, giving this jack a much better hold under severe load conditions
- The extra long 138cm (54") handle can be locked in 3 positions for easy positioning of this jack in hard to reach places
- An integral Descent Metering Valve maintains a controlled and safe lowering of the load
- Single piece base construction provides superior strength for increased load stability
- Double polished chromed pistons allow for much tighter tolerances which reduce oil bypassing and reduced ram scoring
- Air assisted lowering speeds up ram retraction
- Built-in overload safety valve prevents damage to unit due to excessive load
- Comes with 2 extensions (75mm & 45mm) and saddle adaptor
- Units are tested to -25°C and +45°C as well as off centre loading to ensure a long life under even the harshest conditions

Cap. (Tons)	Low Height	High Height	Lift	Working Air Pressure	Shipping Weight
50	215 mm (8.46")	332 mm (13.07")	117 mm (4.61")	0.8 to 1.2 Mpa (116 to 174 PSI)	165 lb (75 kg)
25	215 mm (8.46")	446 mm (17.56")	231 mm (9.09")	—	—



SHD SUPER HEAVY DUTY

60/40/20 TON

SHD 760SHD

**3 STAGE AIR HYDRAULIC TRUCK JACK
SUPER HEAVY DUTY**

030476

- This Super Heavy Duty, 3 Stage 60/40/20 Ton Air Hydraulic Jack covers a wide variety of demands from the heavy duty trucking, agricultural, fleet, construction and military sectors
- The piston head seal design is borrowed from industrial technology providing a superior low and high pressure seal, giving this jack a much better hold under severe load conditions
- The extra long 138cm (54") handle can be locked in 3 positions for easy positioning of this jack in hard to reach places
- An integral Descent Metering Valve maintains a controlled and safe lowering of the load
- Single piece base construction provides superior strength for increased load stability
- Double polished chromed pistons allow for much tighter tolerances which reduce oil bypassing and reduced ram scoring
- Air assisted lowering speeds up ram retraction
- Built-in overload safety valve prevents damage to unit due to excessive load
- Comes with 2 extensions (75mm & 45mm) and saddle adaptor
- Units are tested to -25°C and +45°C as well as off centre loading to ensure a long life under even the harshest conditions



Cap. (Tons)	Low Height	High Height	Lift	Working Air Pressure	Shipping Weight
60	175mm (6.89")	252mm (9.92")	77mm (3.03")	0.8 to 1.2 Mpa (116 to 174 PSI)	165 lb (75 kg)
40	175mm (6.89")	322mm (12.68")	147mm (5.79")	—	—
20	175mm (6.89")	404 mm (15.91")	229mm (9.02")	—	—

80/50 TON

SHD 780SHD

**2 STAGE AIR HYDRAULIC TRUCK JACK
SUPER HEAVY DUTY**

030477

- There isn't much that you won't be able to lift with this Super Heavy Duty 2 Stage Air Hydraulic Jack, heavy duty trucking, agricultural, construction, military, even aircraft - this does it all!
- The piston head seal design is borrowed from industrial technology providing a superior low and high pressure seal, giving this jack a much better hold under severe load conditions
- The extra long 138cm (54") handle can be locked in 3 positions for easy positioning of this jack in hard to reach places
- An integral Descent Metering Valve maintains a controlled and safe lowering of the load
- Single piece base construction provides superior strength for increased load stability
- Double polished chromed pistons allow for much tighter tolerances which reduce oil bypassing and reduced ram scoring
- Air assisted lowering speeds up ram retraction
- Built-in overload safety valve prevents damage to unit due to excessive load
- Comes with 2 extensions (75mm & 45mm) and saddle adaptor
- Units are tested to -25°C and +45°C as well as off centre loading to ensure a long life under even the harshest conditions



Cap. (Tons)	Low Height	High Height	Lift	Working Air Pressure	Shipping Weight
80	230 mm (9.06")	340 mm (13.39")	77mm (3.03")	0.8 to 1.2 Mpa (116 to 174 PSI)	240 lb (109 kg)
50	230 mm (9.06")	440 mm (17.32")	147mm (5.79")	—	—



5-1/2 TON

527

LONG REACH AIR LIFT JACK - HEAVY DUTY

030454

- 5-1/2 ton capacity achieved at 160 PSI air supply
- Eases lifting and lowering of large truck, buses, farm and construction equipment
- Scissor design enables flexibility when lifting
- Includes two sizes of saddles and a drop axle adaptor for increased versatility
- Convenient saddle storage on the cylinder
- The drop axle adaptor can reduce the minimum height by 3-1/2" in front of the support bar on the jack
- The high saddle adds maximum 10-1/2" height to the support bar on the jack
- The low saddle adds maximum 4-1/2" height to the support bar on the jack
- Five position safety lock that is independent of air pressure
- Two large pneumatic wheels provide excellent manoeuvrability
- Reach: 45", Saddle spread: 23" - 45"
- Lowered dimensions: 15" W. x 77" L. x 46" H.



Long reach model

10 TON

528

AIR END LIFT JACK - HEAVY DUTY

030457

- 10 ton capacity achieved at 200 PSI air supply
- 4" x 6" steel saddles adjust between 36" and 50" widths to accommodate a wide variety of vehicle applications
- Saddle arms reversible for lower lifting points
- Three-way air valve for fine lifting and lowering control
- Automatic mechanical safety lock engages at five lift heights from 17-1/2" to 50"
- Two air control valve fittings – one for shop air supply and one for a Schrader valve
- Front swivel caster and two pneumatic rear tires for easy manoeuvrability
- 13" forward reach (distance from cylinder to saddles)



MOD. NO.	PROD. NO.	Cap. (Tons)	Saddle Spread	Working Air Pressure	Shipping Weight
527	030454	5-1/2	23" - 45"	160 PSI	638 lb (290 kg)
528	030457	10	36" - 50"	200 PSI	750 lb (341 kg)



10 TON

529

AIR LIFT JACK - HEAVY DUTY

030458

- 10 ton capacity achieved at 200 PSI air supply
- Heavy duty air valve offers accurate lift control
- Removable T-handle for easy storage
- Extension tubes offer multiple lifting and locking positions
- 12" lift travel
- Large diameter rubber tread wheels for ease in positioning in restricted areas
- Designed for lifting large trucks, buses, farm and construction equipment, especially in crowded service areas

MOD. NO.	PROD. NO.	Cap. (Tons)	Working Air Pressure	Shipping Weight
529	030458	10	200 PSI	172 lb (78 kg)



7 TON

958A

FORK LIFT JACK - HEAVY DUTY

030482

- The scissor jack point is low enough to efficiently access and lift a variety of popular forklift models
- Scissors lift from 2-1/2" to 16-1/2"
- 14" reach in raised position
- Safety valve provides critical overload protection
- Rugged wheels make load alignment easier
- Chassis 26" long x 9" wide
- Shipping weight: 150 lb (68 kg)



Raised



Lowered



CLUTCH JACK

802A

MANUAL SWIVEL HEAD DESIGN - HEAVY DUTY

030501

- A highly efficient design that provides the technician with capabilities to remove, install and transport heavy duty truck clutches
- This heavy duty unit has a greater capacity than most competitive units and has the added versatility of being able to convert the optional adaptors for fly wheels, drive shafts, starter motors, auxiliary cases, differentials, brake drums and camel back springs
- Patented clutch head assembly (US patents 5,251, 875, and 5,033,717) turns 360° and pivots side-to-side for efficient clutch/engine alignment
- Two splined alignment shafts (2" OD x 1.18" pilot and 1-3/4" OD x .938" pilot)
- Clutch assemblies can easily be built on the vertical shaft and then positioned easily under the truck
- Pump handle rotates 360° for ease of operation in virtually any work position
- Unique pinned alignment shaft allows technician to remove jack to install clutch assembly without obstruction

Pin alignment shaft allows technician to install clutch assembly with jack removed from work area

Pump handle rotates 360°

Patented head design turns 360° and pivots side-to-side for positive clutch alignment

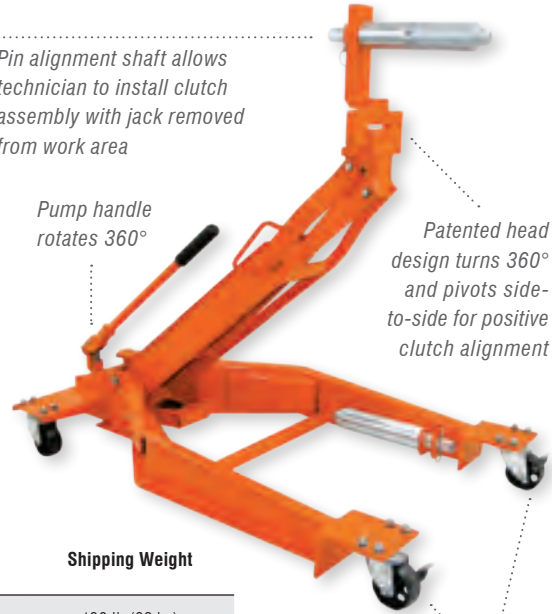

Versatile open leg design

Cap. (lbs)	Low Height	High Height	Frame Dimensions	Shipping Weight
500	13"	39"	36-1/2" L x 22" W	138 lb (62 kg)

CLUTCH JACK

ACCESSORIES

802A-1 • 030502 • FLYWHEEL ADAPTOR

- Easily replaces the spline and bolts onto flat and pot style truck flywheels used with 14" and 15-1/2" clutches for more efficient removal and installation
- Shipping weight: 18.55 lb (8 kg)



802A-6 • 030507 • BRAKE DRUM ADAPTOR

- Works like a forklift to handle heavy truck brake drums. Easily positions under the vehicle to safely remove or install the drum. The tilt and pivot abilities of the head allow for precise brake drum alignment
- Shipping weight: 37 lb (17 kg)



802A-2 • 030503 • DRIVE SHAFT ADAPTOR

- Supports heavy truck drive shafts under the main carrier bearing or the complete shaft, allowing one shop technician to safely move or align them
- Shipping weight: 18 lb (8 kg)



802A-7 • 030508 • CAMELBACK SPRING ADAPTOR

- Allows technician to safely remove and efficiently change many Mack truck style camel back spring units
- Shipping weight: 42 lb (19 kg)



802A-3 • 030504 • STARTER MOTOR ADAPTOR

- With its large V shape surface area, it cradles large truck starter motors and makes their removal, installation and transportation easier
- Shipping weight: 11 lb (5 kg)



802A-8 • 030509 • SPLINE 1.18" PILOT X 2.00"

- Comes with 802A • Spline shaft end has flattened sides to allow the use of wrench to turn clutch assembly and is threaded for use with slide hammer for pulling tight spline shafts
- Shipping weight: 6 lb (3 kg)



802A-4 • 030505 • AUXILIARY CASE ADAPTOR

- Helps technician remove the auxiliary case without having to remove the complete transmission unit
- Shipping weight: 11 lb (5 kg)



802A-9 • 030510 • SPLINE .983" PILOT X 1.75"

- Comes with 802A • Spline shaft end has flattened sides to allow the use of wrench to turn clutch assembly and is threaded for use with slide hammer for pulling tight spline shafts
- Shipping weight: 6 lb (3 kg)



802A-5 • 030506 • DIFFERENTIAL ADAPTOR

- Makes removing and installing heavy truck differentials easier and safer by eliminating the need for personal heavy lifting by a shop technician
- Shipping weight: 30 lb (14 kg)



802A-10 • 030511 • SPLINE .981" PILOT X 1.50"

- Spline shaft end has flattened sides to allow the use of wrench to turn clutch assembly and is threaded for use with slide hammer for pulling tight spline shafts
- Shipping weight: 6 lb (3 kg)



1,500 LBS

224

HYDRAULIC WHEEL DOLLY - HEAVY DUTY

030484

- Lift arm adjusts inward and outward to handle different wheel combinations
- Provides extra low access to easily position heavy wheel assemblies
- Leveling screw for precise alignment
- Full 7-3/4" ram lift
- Three large swivel casters provide maximum flexibility of movement
- Six foot safety chain secures wheels in place during removal and transport
- Easily handles the removal, installation and transportation of single or dual truck wheel assemblies

Cap. (lbs)	Low Height	High Height	Length	Width	Shipping Weight
1,500	2-1/2"	10-1/4"	31"	43"	166 lb (75 kg)

450 LBS

624A

WHEEL DOLLY

030485

- Suitable for super wide highway tires
- Rugged tubular construction
- 13-3/4" rollers turn and pivot for perfect alignment with hub lugs
- Design enables one person to do the work without excessive lifting or straining
- Shipping weight: 26.5 lb (12 kg)

DRUM HANDLER

623

BRAKE DRUM HANDLER - HEAVY DUTY

030483

- Designed for installing, removing and transporting brake drums
- Accommodates 15" to 16-1/2" brake drums
- Rotating handle for easy lowering and raising of drum
- Design allows for easy manoeuvrability and balance of drum
- Adjustable brackets secure both outboard and inboard mounted drums with disc wheel hubs to the brake drum handler
- Removable handle for easy storage
- Shipping weight: 55 lb (25 kg)



224 • 030484

For single or dual truck wheel assemblies



624A • 030485

13-3/4" long rollers allow easy wheel to hub alignment





SUPER HEAVY DUTY

15,000 LBS



HIGH REACH FIXED STANDS - SUPER HEAVY DUTY

- Super Heavy Duty construction, designed for truck and bus support
- Spring loaded caster wheels allow for easy positioning and portability
- Adjustable height range

MOD. NO.	PROD. NO.	Low Height	High Height	Saddle Diameter	Shipping Weight
WTS15H-SHD	032215	57"	82"	5"	134 lb (61 kg)
WTS15L-SHD	032216	36"	57"	5"	103 lb (47 kg)

33,000 LBS



HIGH REACH FIXED STAND - SUPER HEAVY DUTY

- Super Heavy Duty construction, designed for truck and bus support
- Spring loaded caster wheels allow for easy positioning and portability
- Adjustable height range

MOD. NO.	PROD. NO.	Low Height	High Height	Saddle Diameter	Shipping Weight
WTS33H-SHD	032217	56"	82"	5"	232 lb (105 kg)

20 TON



TR-20ATW

TRUCK RAMPS - SUPER HEAVY DUTY

030481

- Long retractable handle eases movement and stores easily out of the way
- Suitable for large truck tires up to 16" maximum width
- Comes with rubber non-skid pad to prevent slippage
- 20 Ton capacity per pair

Product Dimension	Overall Length	Shipping Weight
47" x 18.25" x 9.25" (L x W x H)	60"	396 lb (180 kg) pair

WTS15H-SHD
032215

WTS15L-SHD
032216



WTS33H-SHD
032217

Adjustable Height



STRONGARM Under-Hoist Stands and Stabilizing Stands, built with all steel construction, are designed to stabilize vehicle system components (such as exhausts and suspensions) in under-hoist applications.



2 TON

874A

**UNDER-HOIST COMPONENT STAND
TRIPOD STYLE - HEAVY DUTY**

032202

- Adjusts from 55" to 85-1/2"
- Ideal for exhaust and suspension work
- Bearing included for smooth operation
- Easily dismantles for storage
- 24" x 24" x 24" base
- Not designed to support entire vehicle but may be used to stabilize vehicles that are raised by in ground or above ground lifts
- Shipping weight: 44 lb (19 kg)

3/4 TON

875A

SINGLE POST STYLE - HEAVY DUTY

032204

- Designed to support vehicle components, not vehicles
- Ideal for shock absorber replacement and exhaust system installations
- Adjusts from 54-1/2" to 80-1/2"
- Foot operated lever for extra lift
- Bearing included for smooth operation
- 12" diameter base
- Shipping weight: 32 lb (14 kg)

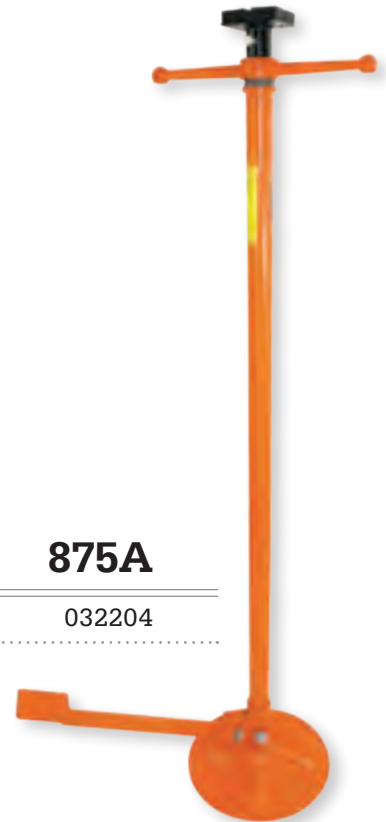

2 TON

876A

**UNDER-HOIST STABILIZING STAND
TRIPOD STYLE - HEAVY DUTY**

032206

- Features all steel construction with joints welded together for maximum strength
- Stabilizes vehicles that are raised by in ground or above ground lifts
- Adjusts from 66-1/2" to 73"
- Ideal for exhaust and suspension work
- Bearing included for smooth operation
- Adjusting screw for easier load operation
- 21" x 21" x 21" base
- Not designed to support entire vehicle but may be used to stabilize vehicles that are raised by in ground or above ground lifts
- Shipping weight: 26 lb (12 kg)

50 TON

877

**UNDER-HOIST STABILIZING STAND
SCREW TYPE - HEAVY DUTY**

032211

- Designed for stabilizing loaded and unloaded trailers when not connected to trucks
- Pivoting, reversible ratchet head helps level trailers on uneven ground
- Acme threaded screw design
- 100,000 lb static load capacity
- 45,000 lb lifting capacity
- Heavy duty base secures and stabilizes load
- Removable pipe handle
- Cap Size: 8" diameter
- Base Plate: 14" diameter
- Adjusts from 39" to 51"
- Shipping weight: 125 lb (54 kg)





STRONGARM Jack Stands provide a safe and secure way to support vehicles once lifted and when performing under car maintenance. Our ratchet and pin-type stands are built using heavier steel with large support saddles. They are intended for use in pairs in automotive and fleet service as well as agricultural and construction equipment service facilities.

10 TON

871A

**JACK STANDS
HIGH PROFILE SET - HEAVY DUTY**

032226

- Large support saddle and extra wide four legged base for stability
- 10 height adjusting pin positions
- Sold and shipped in pairs

10 TON

873A

**JACK STANDS
LOW PROFILE SET - HEAVY DUTY**

032228

- Large support saddle and extra wide four legged base for stability
- 7 height adjusting pin positions
- Sold and shipped in pairs

MOD. NO.	PROD. NO.	Cap. (Tons)	# of Positions	Low Height	High Height	Saddle Dimensions	Base Dimensions	Shipping Weight
871A	032226	10	10	30-3/4"	46-1/4"	3-1/8" x 5-7/8"	16" x 16"	110 lb (50 kg) pair
873A	032228	10	7	21-1/2"	29-3/4"	3-1/8" x 5-7/8"	17" x 17"	66 lb (30 kg) pair

871A • 032226



873A • 032228



20 TON

878A

JACK STAND - HEAVY DUTY

032229

- Efficient pin-type post with four height adjustment positions
- Adjusts from 13-3/4" to 19-3/4"
- Large 3" x 3-7/8" saddle
- 10" x 10" square base secures and stabilizes load
- Meets ANSI standards for performance and safety
- Balanced carry handle
- Sold individually

# of Positions	Low Height	High Height	Saddle Dimensions	Base Dimensions	Shipping Weight
4	13-3/4"	19-3/4"	3" x 3-7/8"	10" x 10"	42 lb (19 kg) ea.

878A • 032229



5 TON

869A

FORKLIFT STANDS - HEAVY DUTY

032222

- Large support saddle
- Heavy duty 9" - 10" rectangular base secures and stabilizes load
- Sold and shipped in pairs

# of Positions	Low Height	High Height	Saddle Dimensions	Base Dimensions	Shipping Weight
4	12-3/4"	16-1/2"	2-3/4" x 4"	9" x 10"	25 lb (11 kg) pair

869A • 032222



853A • 032241

Made with superior quality heavy duty cast saddles

3-12 TON

JACK STANDS - RATCHETING STYLE - HEAVY DUTY

- Notched saddles for use with unitized vehicles
- Safety ratchet prevents lowering when saddle is loaded
- Convenient handle for column release and carrying
- Meets ANSI specifications
- Sold and shipped in pairs

MOD. NO.	PROD. NO.	Cap. (Tons)	Low Height	High Height	Base Dimensions	Shipping Weight
853A	032241	3	11"	16"	7" x 7-1/2"	16 lb (7 kg) pair
856A	032243	6	15-1/2"	24"	9" x 10-1/2"	30 lb (14 kg) pair
872B	032246	12	18"	28-3/4"	12" x 10-3/4"	70 lb (32 kg) pair



Made with heavier gauge steel for maximum strength and safety



STRONGARM Hydraulic Telescopic Transmission Jacks provide service technicians one-man capabilities for installing transmissions, differentials or transfer cases.



792B • 030522

790 • 030521

700 LBS

792B

SINGLE STAGE MANUAL - STANDARD DUTY 030522

- Economical single stage telescopic ram for use on automobile transmissions, transfer cases or differentials
- Designed for under-hoist work
- Large 360° swivel casters for easy manoeuvrability
- Adjustable saddle with corner brackets and safety chain

1,000 LBS

790

SINGLE STAGE MANUAL - STANDARD DUTY 030521

- Single stage telescopic ram for use on automobile, truck and van transmissions, transfer cases and differentials in under-hoist applications
- Universal head provides forward and back tilt
- Wide base for maximum stability
- Foot operated pump frees both hands for easier saddle to transmission alignment
- Convenient release knob
- Large 360° swivel casters for easy manoeuvrability
- Safety chain included
- Hydraulic cylinder has two handles for extra convenience

1,000 LBS

814A

TWO STAGE MANUAL - HEAVY DUTY 030524

- Two stage manual hydraulic operation
- Universal head provides forward, back and side tilt
- Fully adjustable universal saddle with corner brackets and safety chain
- Foot operated pump allows mechanic to use both hands to position and align saddle with transmission
- Automatic safety valve prevents jack from overload
- Wide base for maximum stability
- 360° handle for extra convenience

814A • 030524



MOD. NO.	PROD. NO.	Cap. (lbs)	Low Height	High Height	Base Dimensions	Forward Tilt	Backward Tilt	Left Tilt	Right Tilt	Shipping Weight
792B	030522	700	53"	73"	39" sq.	N/A	N/A	N/A	N/A	96 lb (43 kg)
790	030521	1,000	45"	71"	23" sq.	30°	15°	N/A	N/A	96 lb (43 kg)
814A	030524	1,000	33-1/2"	72-1/2"	38" sq.	40°	15°	50°	20°	203 lb (91 kg)

1,000 LBS

8177

TWO STAGE AIR/HYDRAULIC - HEAVY DUTY

030531

- Combines an air-operated first stage for maximum speed with a hydraulic second stage for most accurate final positioning
- Four fast ratcheting head brackets easily secure to transmission pan flanges
- Extendable height from 34" to 72-3/4"
- Strong nylon safety strap for secure load anchoring
- Solid (41" x 41") stance with heavy duty, wide 4" swivel casters for easier, more efficient under-hoist positioning
- Large heavy duty casters provide ease of manoeuvrability on rough floors



8177 • 030531

2,000 LBS

816A

TWO STAGE HYDRAULIC - HEAVY DUTY

030527

- Two stage telescopic ram, designed for heavier automotive and medium duty truck transmissions, transfer cases or differentials in under-hoist applications
- Universal head provides forward, back and side tilt
- Automatic safety valve provides critical overload protection
- Adjustable saddle with corner brackets and safety chain
- Extra wide 4 point base with rugged 360° swivel casters for maximum stability and manoeuvrability



816A • 030527

MOD. NO.	PROD. NO.	Cap. (lbs)	Low Height	High Height	Base Dimensions	Forward Tilt	Backward Tilt	Left Tilt	Right Tilt	Shipping Weight
8177	030531	1,000	34"	72-3/4"	30-1/4" sq.	50°	20°	10°	10°	222 lb (100 kg)
816A	030527	2,000	33-1/2"	72-1/2"	44" sq.	40°	15°	50°	20°	242 lb (109 kg)

FUEL TANK

818

FUEL TANK ADAPTOR - HEAVY DUTY

030529

- Adjustable brackets, two safety straps, two grounding cables
- 80 lb capacity
- Fits STRONGARM transmission jack models 814A and 816A and 8177
- Measurements: Overall width 15" W., Retracted length 19-3/4", Extended length 31-3/4", Pad size 5-3/4" x 4"
- Shipping weight: 59 lb (27 kg)



818 • 030529



1/2 TON

800A

LOW PROFILE - LIGHT DUTY

030542

- Designed for light truck transmissions
- Fully adjustable universal saddle with corner brackets and safety chains
- Safety overload bypass to prevent hydraulic damage
- 24" handle pivots 360° around pump
- 4 swivel casters

804A • 030545



806A • 030547



808A • 030549



SHD SUPER HEAVY DUTY

1 TON

804A

LOW PROFILE - STANDARD DUTY

030545

- Designed for light to medium truck transmissions
- Fully adjustable universal saddle with corner brackets and safety chains
- Safety overload bypass to prevent hydraulic damage
- 24" handle pivots 360° around pump
- 4 industrial grade 3" casters
- Handles on both sides at back of the jack for convenience and manoeuvrability

1 TON

806A

LOW PROFILE - HEAVY DUTY

030547

- Designed for heavy truck service
- Adjustable width head plate and wedge shaped brackets allows for a wide range of mounting options and the 4 way tilting head makes for easier removal and installation of the transmission
- Equipped with a 360° swiveling handle for use in tight spots
- Head dimensions: Width - Min. 6-1/2", Max 18-1/4", Length - Min. 6-3/4", Max 18-1/2"
- Open leg design makes it very versatile
- Rugged heavy duty casters
- Safety chain included
- Handles on both sides at back of the jack for convenience and manoeuvrability

2 TON

SHD 808A

LOW PROFILE - SUPER HEAVY DUTY

030549

- STRONGARM offers the only Super Heavy Duty transmission jack with a full 2 ton capacity
- Built to handle removal, transport and installation of transmissions, transfer cases or differentials on heavy duty trucks, buses, agricultural and construction equipment
- Fully adjustable saddle with maximum tilt for easier alignment
- Adjustable corner brackets
- Convenient side trays for small tools and parts
- Safety overload bypass system to prevent hydraulic damage
- Adjustable saddle with corner brackets and safety chain
- 32" handle pivots 360° around pump
- Rugged industrial grade 4" casters for maximum manoeuvrability

MOD. NO.	PROD. NO.	Cap. (Tons)	Low Height	High Height	Base Dimensions	Forward Tilt	Backward Tilt	Side Tilt	Shipping Weight
800A	030542	1/2	5-3/4"	31-1/2"	18-1/2" W. x 36-3/4" L.	65°	12°	12°	110 lb (50 kg)
804A	030545	1	5-3/4"	31-1/2"	18-1/2" W. x 37-1/2" L.	65°	10°	12°	143 lb (64 kg)
806A	030547	1	10"	44"	25" W. x 53" L.	40°	25°	12°	299 lb (135 kg)
808A	030549	2	8-1/2"	34"	26" W. x 43" L.	15°	30°	12°	297 lb (166 kg)

STRONGARM Engine Stands are used in the positioning and transportation of automobile and light truck engines in a wide variety of vehicle service facilities. All Engine Stands include a 360° rotating head, which efficiently puts the engine in the optimal work position, rugged full swivel casters and heavy duty tubular steel construction. Superior welds in all locations provide maximum strength and durability.

1,000 LBS

234B

234B • 030352

H-DESIGN - STANDARD DUTY

030352

- Wide 4 point H type base ensures good stability
- 4 Adjustable brackets provide maximum flexibility – fits most small engines
- 360° rotating head enables engine to be placed in desired work position
- 2 fixed rear wheels and 2 front swivel casters
- Heavy duty welded reinforced steel base

Cap. (lbs)	Base Length	Stand Height	Front Width	Rear Width	Shipping Weight
1,000	36"	34-3/4"	31"	N/A	53 lb (24 kg)



1,250 LBS

236A

236A • 030353

U-DESIGN - STANDARD DUTY

030353

- Extra wide 4 point U type base ensures maximum stability and performance
- Adjustable brackets allow maximum flexibility – fits most automobile and light truck engines
- 360° rotating head enables engine to be placed in desired work position
- Full swivel casters
- Heavy duty welded steel base
- Features convenient tray for holding tools and parts

Cap. (lbs)	Base Length	Stand Height	Front Width	Rear Width	Shipping Weight
1,250	34"	34"	33"	33"	83 lb (37 kg)





634 • 032915



635 • 032916



660 • 032411



661 • 032412



675 • 032441



662 • 032413



663 • 032414



664 • 032421



677 • 032443



676 • 032442



TD-1000 • 032446

Contact your nearest distributor for complete information on our product lines.

Check out our other quality products on our website:

www.jetequipment.com



MECHANICAL SCREW JACKS



HEAVY DUTY



SJ SERIES – HEAVY DUTY

- Professional contractor quality mechanical screw jack for all-purpose lifts and supports
- Holds loads indefinitely – will not creep
- Heavy-duty bell shaped cast base adds stability
- Head pivots to provide maximum contact
- Corrugated steel swivel head turns easily under load
- Acme type thread
- Easy to carry and position with built-in handle
- Turning bar (handles) sold separately
- Compliance: ANSI / ASME B30.1 standards
- Ideal for construction, structural moving, supporting machinery, automotive, trucks, industrial, agriculture and general maintenance

HANDLES FOR SJ SERIES JACKS

MOD. NO.	PROD. NO.	Size	Fits Model Number	Shipping Weight **
SJH-05	141504	1/2" x 18"	SJ-05	1.1 lb (0.5 kg)
SJH-10	141506	5/8" x 24"	SJ-10	2.2 lb (1 kg)
SJH-15	141509	3/4" x 36"	SJ-15	5.5 lb (2.5 kg)
SJH-2025	141513	1" x 42"	SJ-20 / SJ-25	8.8 lb (4 kg)

MOD. NO.	PROD. NO.	Rated Capacity (Tons)	Bar Hole Size	Minimum Height	Maximum Height	Handle	Shipping Weight **
SJ-05	141503	5	9/16"	9.45"	13.39"	141504	8.8 lb (4 kg)
SJ-10	141505	10	11/16"	11.5"	17.83"	141506	15.4 lb (7 kg)
SJ-15	141508	15	13/16"	13.86"	21.38"	141509	24.2 lb (11 kg)
SJ-20	141512	20	1"	15.83"	24.88"	141513	31.9 lb (14.5 kg)
SJ-25	141516	25	1"	16.61"	26.34"	141513	37.4 lb (17 kg)

** Shipping weights are approximate

STRONGARM Engine Cranes are designed for easy and efficient removal and transportation of vehicle engines. All feature four-position telescopic booms, wide stable bases, forged steel hooks with safety latches and heavy duty swivel casters. Superior welds in all locations provide maximum strength and durability.

1/2 TON

200A

**(1,000 LBS) 360° SWIVEL TRUCK MOUNTED CRANE
HEAVY DUTY**

030303

- Rugged steel construction
- Boom working range 26.75" to 41.25"
- Locking 360° swivel base
- Heavy duty chain with safety lock
- Designed to be installed in pickup truck beds or vans
- Shipping Weight: 106 lb (48 kg)



200A • 030303

Extends from
26.75" to 41.25" ➔



205B • 030318

Extends from 51" to 79" ➤



216 • 030315

Extends from 43" to 64"

Foldable for extra storage and portability!



218 • 030321

4 different boom settings:
3T, 2T, 1.5T, 1T ➤

STRONGARM Engine Cranes are designed for easy and efficient removal and transportation of vehicle engines. All feature four-position telescopic booms, wide stable bases, forged steel hooks with safety latches and heavy duty swivel casters. Superior welds in all locations provide maximum strength and durability.

2 TON

205B

(4,000 LBS) TELESCOPING - HEAVY DUTY

030318

- High capacity engine crane with added boom length, enabling it to be used on vehicles with long front ends where an extra long reach is required
- Boom extends between 51" and 79"
- Base legs extend between 62" and 91" to maximize stability
- Frame legs increase from 26" to 33" in width at full extension
- Roller-bearing swivel casters with safety brakes to secure positioning
- Ideal for lifting and transporting automotive and truck engines, transmissions, etc.
- Shipping Weight: 282 lb (127 kg)

2 TON

216

(4,000 LBS) TELESCOPING - FOLDING STYLE HEAVY DUTY

030315

- Designed for shops with limited space and for maximum portability
- Ideal for rental yards
- The legs easily fold up and away and with the ram completely retracted, this uses an extremely small storage footprint
- 360° hook adds greater flexibility in positioning lifting chains during removal and installation
- Shipping Weight: 260 lb (117 kg)

3 TON

218

ENGINE CRANE - HEAVY DUTY

030321

- Extra Heavy Duty engine crane with reinforced leg assemblies for added strength and durability
- 4 different boom settings: 3T, 2T, 1.5T, 1T
- Hydraulic ram has built in safety overload to protect the unit from being used beyond its rated capacity
- Large 4.25" rear swivel casters and 6" fixed front wheels provide ease of mobility and positioning
- Shipping Weight: 359 lb (163 kg)

1/2 TON

208B

(1,000 LBS) ENGINE TILTER - STANDARD DUTY 030343

- Engine can be tipped to a wide variety of angles for easy removal and installation
- Saves time and labour
- Easily change centre of gravity to make engine removal or installation faster and safer
- Can be used with shop cranes and hoists
- Shipping Weight: 12 lb (5 kg)



3/4 TON

209

(1,500 LBS) ENGINE TILTER - HEAVY DUTY 030341

- Engine can be tipped to a wide variety of angles for easy removal and installation
- Saves time and labour
- Easily change centre of gravity to make engine removal or installation faster and safer
- Can be used with shop cranes and hoists
- Shipping Weight: 13 lb (6 kg)



750 LBS

238

ENGINE SUPPORT - STANDARD DUTY 030342

- Ideal for transverse mounted engines when working on the transmission or when removing engine mounts
- Precisely positions the engine to allow easy transmission removal
- Perfect for front wheel drive vehicles, both 4 and 6 cylinders
- Can be extended to adapt to the width of the vehicle
- Special feature provides height adjustment after having been attached to the engine by means of a worm screw (not intended for lifting engine)
- Shipping Weight: 37 lb (17 kg)



700 LBS

239

TRANSVERSE ENGINE SUPPORT 030344

- Three support points for added stability
- 700 lb capacity
- 2 - 14" adjustable hook screws
- 2 - 1/8" x 38" braided steel cables
- Width expands from 34.5" to 61"
- Shipping Weight: 27 lb (12 kg)



239 • 030344

*Extends from
34.5" to 61" ➔*



STRONGARM Shop Presses are used in repair shops for the removal and installation of gears, bushings and bearings, as well as with metal bending, straightening, compression and flattening applications. All floor presses have rugged structural steel frames and two arbor plates.

12 TON

112

MANUAL HYDRAULIC - STANDARD DUTY

032161

- Designed for light duty applications
- Eight level bed adjustment
- 12 ton bottle jack with overload protection
- Heavy duty return springs for fast ram retraction
- Comes with 2 V blocks (6" x 6" x 1/2")
- 20 1/4" W x 51 3/4" H

Ram travel	# Bed adjust.	Space interval	Dis. between posts	Bed depth	Throat width	Throat depth	Shipping Weight
6-1/4"	8	3-1/2"	16-3/4"	7"	14"	3-1/4"	110 lb (50 kg)

20 TON

120A

MANUAL HYDRAULIC - STANDARD DUTY

032166

- Front mounted gauge shows operator the amount of pressure being applied to work piece
- Comes with 20 ton bottle jack/gauge, combination V blocks and plate supports
- Rugged construction suited for industrial use
- Eight bed adjustments
- Comes with 2 V blocks (11" x 4-1/4" x 1")
- 26-3/4" W x 61-1/2" H

Ram travel	# Bed adjust.	Space interval	Dis. between posts	Bed depth	Throat width	Throat depth	Shipping Weight
5"	8	5"	23"	10"	19-1/2"	6"	288 lb (130 kg)

35 TON

135

AIR/HYDRAULIC - HEAVY DUTY

032173

- For automotive and heavy duty use
- Two speed hand pump provides faster travel to load while the air/hydraulic (with overload protection) allows for effortless operation
- Seven bed adjustments
- Frame mounted hydraulic pressure gauge
- Comes with 2 V blocks (12" x 3" x 2")
- 32" W x 69" H

Ram travel	# Bed adjust.	Space interval	Dis. between posts	Bed depth	Throat width	Throat depth	Shipping Weight
6-1/2"	8	4-1/2"	24"	12"	9"	7-1/2"	312 lb (140 kg)

50 TON

150

AIR/HYDRAULIC - HEAVY DUTY

032175

- Designed for heavy duty automotive and industrial use
- Utilizes a secondary manual volume pump to provide faster ram travel and the added versatility of an air motor for greater operator ease
- Frame mounted hydraulic pressure gauge
- Winch operated press bed
- Comes with 2 V blocks (14-1/2" x 3" x 2")
- 60" W x 67" H

Ram travel	# Bed adjust.	Space interval	Dis. between posts	Bed depth	Throat width	Throat depth	Shipping Weight
7-1/4"	6	5-1/2"	32"	15"	7"	9-1/2"	645 lb (290 kg)

SHOP PRESS

ACCESSORIES / REPLACEMENT PARTS

- 112NP04** • For Model 112 (2 required) • **ARBOR PLATE**
- 120AP07A** • For Model 120 (2 required) • **ARBOR PLATE**
- 135P9** • For Model 135 • **ARBOR PLATE**
- 150P23** • For Model 150 • **ARBOR PLATE**





SHD SUPER HEAVY DUTY

These quality features are standard on all SHD models

- Welded frame for added strength
- Protective guard, combination V block and pressing adaptor set included
- Press head moves from side to side for added pressing flexibility
- Liquid filled gauge accurately shows operator pressing force being applied
- Air pressure 110 - 120 PSI

*Pressing adaptor set
with all models*

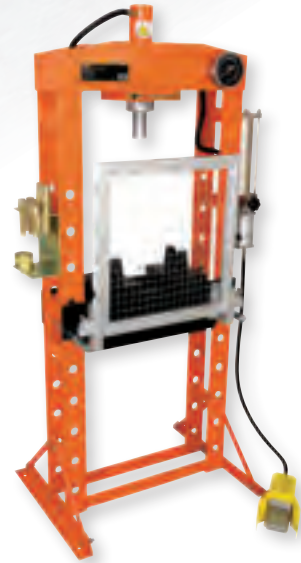
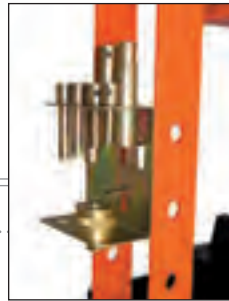

20 TON

SHD SP20T-SHD

SHOP PRESS - SUPER HEAVY DUTY 032181

Ram Stroke	Hydraulic System Pressure	Overall Size	Bed Depth	Bed Width	Throat Depth	Throat Width	Shipping Weight
7.5"	10,000 PSI	35" x 64"	7"	19.25"	5.75"	10.75"	282 lb (128 kg)

*Protective guard
with all models*

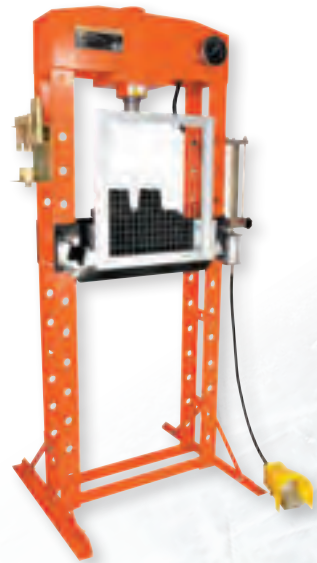

30 TON

SHD SP30T-SHD

SHOP PRESS - SUPER HEAVY DUTY 032182

Ram Stroke	Hydraulic System Pressure	Overall Size	Bed Depth	Bed Width	Throat Depth	Throat Width	Shipping Weight
5.9"	8,484 PSI	40" x 71"	7.25"	21.5"	6.5"	15"	363 lb (165 kg)

*HD cable winch for raising and lowering
press bed (50 and 75 Ton only)*

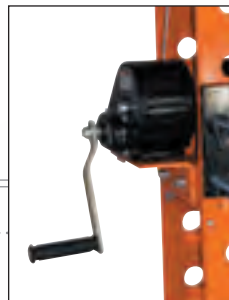

50 TON

SHD SP50T-SHD

SHOP PRESS - SUPER HEAVY DUTY 032184

Ram Stroke	Hydraulic System Pressure	Overall Size	Bed Depth	Bed Width	Throat Depth	Throat Width	Shipping Weight
7.75"	9,053 PSI	54" x 75"	10.125"	28.75"	7.25"	16.75"	660 lb (300 kg)

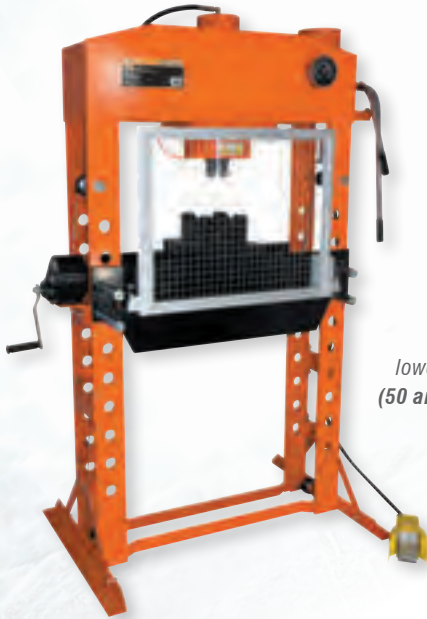

HD cable winch for raising and lowering press bed (50 and 75 Ton only)

SHD SUPER HEAVY DUTY

75 TON

SHD SP75T-SHD

SHOP PRESS - SUPER HEAVY DUTY

032185

Ram Stroke	Hydraulic System Pressure	Overall Size	Bed Depth	Bed Width	Throat Depth	Throat Width	Shipping Weight
9.75"	8,690 PSI	57" x 77"	10.875"	31.5"	8"	19.75"	1,038 lb (472 kg)

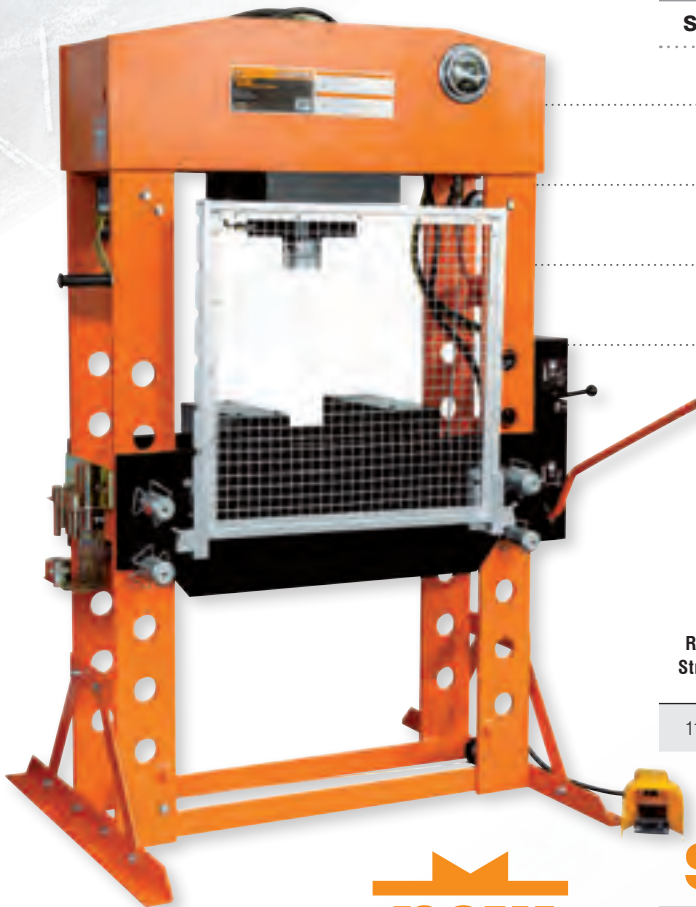

100 TON

SHD SP100TASHD

SHOP PRESS - SUPER HEAVY DUTY

032187

Standard on all SHD models

Liquid filled gauge accurately shows operator pressing force being applied

Welded frame for added strength

Press head moves from side to side for added pressing flexibility

Protective guard, combination V block and pressing adapter set included

Secondary air motor for fast retraction of ram (on 100 Ton only)



Ram Stroke	Hydraulic System Pressure	Overall Size	Bed Depth	Bed Width	Throat Depth	Throat Width	Shipping Weight
11.8"	9,237 PSI	55" x 84"	13.5"	31"	9"	16.5"	1,476 lb (671 kg)

Air Pressure: 120 - 200 PSI (on 100 Ton only)

new

SHOP PRESS

ACCESSORIES / REPLACEMENT PARTS

- PCN-SP20TSHD-28** • For Model SP20TSHD • **V BLOCK**
- PCN-SP30TSHD-12** • For Model SP30TSHD • **V BLOCK**
- PCN-SP50TSHD-24** • For Model SP50TSHD • **V BLOCK**
- PCN-SP75TSHD-24** • For Model SP75TSHD • **V BLOCK**
- PCN-SP100TASHD-19** • For Model SP100TASHD • **V BLOCK**



SHD SUPER HEAVY DUTY

20 TON

SHD BRK20T-SHD

COLLISION REPAIR KIT - SUPER HEAVY DUTY

030250



- 20 Ton deluxe collision repair kit used in the trucking, farm and construction industry
- 2 speed 10,000 PSI pump with safety overload extends the ram to load quickly
- 20 Ton ram with 5" stroke
- All components use a threaded connection for added strength and durability
- 5' Flexible hose comes with spring guards at both ends
- Comes with 2 metal carry boxes for added mobility and accessibility
- Shipping weight: 108 lb (49 kg)

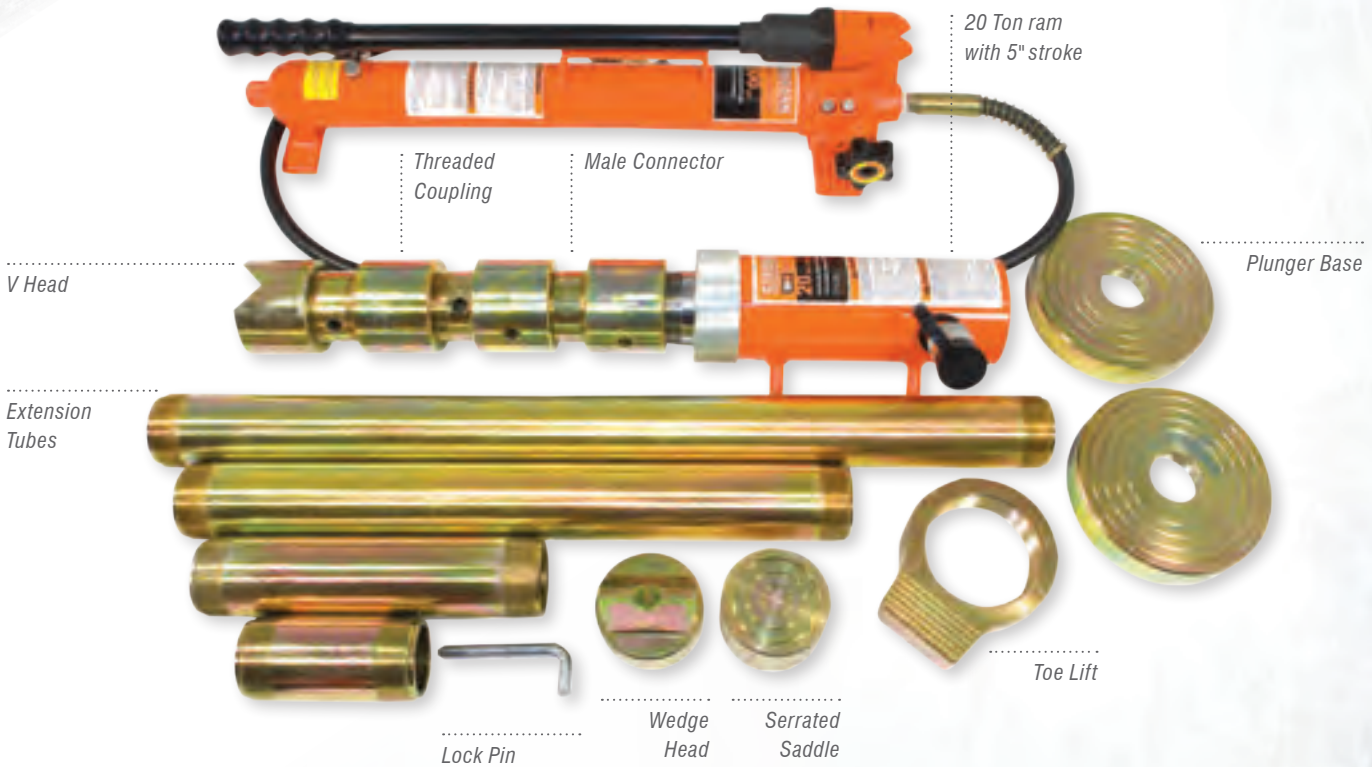

STRONGARM 4, 10 and 20 Ton body and frame repair kits are typically used in vehicle maintenance and collision repair facilities.

4 TON

BRK-4T

BODY REPAIR KIT - HEAVY DUTY

030202

KIT INCLUDES:

- Hydraulic hand pump • 4 ton heavy duty ram with 4" stroke • 5' Hydraulic hose with spring guards on both ends • 5 Quick connect extensions – 3-1/4", 5", 8-1/2", 16-1/2", 19-1/2" • 1/2 ton spreader ram • Rubber head, wedge head, spreading toe and plunger toe, flat base, V-base, quick connector
- Steel bar handle provides added strength
- Pump core treated for tighter tolerances and added durability
- Bronzed piston head bushing minimizes cylinder damage from side loading
- Upgraded o-rings and secondary o-rings provide for a superior seal and longer life
- Convenient blow mould case
- Shipping weight: 43 lb (19 kg)



10 TON

BRK-10T

BODY REPAIR KIT - HEAVY DUTY

030207

KIT INCLUDES:

- Hydraulic hand pump • 10 ton heavy duty ram with 5" stroke • 5' Hydraulic hose with spring guards on both ends • 4 Quick connect extensions – 4.25", 10", 14", 20" • 1/2 ton spreader ram • Rubber head, wedge head, spreading toe and plunger toe, flat base, V-base, quick connector
- Steel bar handle provides added strength
- Pump core treated for tighter tolerances and added durability
- Bronzed piston head bushing minimizes cylinder damage from side loading
- Upgraded o-rings and secondary o-rings provide for a superior seal and longer life
- Convenient blow mould case
- Shipping weight: 69 lb (31 kg)



<p>10 Ton Hydraulic Ram BRK10RAM • 030242</p> 	<p>Hydraulic Hand Pump Flexible Hydraulic Hose BRK10PH • 030284</p> 	<p>1/2 Ton Spreader Ram BRKSPRAM • 030230</p> 	<p>Rubber Head</p> 	<p>Spreader Toe Ram</p> 	<p>Spreader Plunger Toe</p> 
<p>Extension Tubes</p> 	<p>Flat Base</p> 	<p>SS Quick Connector</p> 	<p>Wedge Head</p> 	<p>90° V Base</p> 	<p>Serrated Saddle</p> 



STRONGARM Air/Hydraulic Hand and Foot Pumps are precision made with the highest quality material and components providing a durable unit for years of service. Each unit produces 10,000 PSI with overload protection.

4 TON

BRK4PH

HYDRAULIC HAND PUMP - HEAVY DUTY

030283

- Manual Hydraulic Pump
- Overload protection
- Oil Capacity – 350ml



10 TON

BRK10PH

HYDRAULIC HAND PUMP - HEAVY DUTY

030284

- Manual Hydraulic Pump
- Overload protection
- Oil Capacity – 500ml
- 5' Hose, 10,000 PSI working pressure
20,000 PSI burst pressure
- Spring guards on both ends of hose prevents kinking



STRONGARM Air/Hydraulic Foot Pumps convert rams from manual hand pump operations to air/hydraulic operation for increased efficiency and operator comfort. Can be used on STRONGARM rams as well as other brands up to a 10 Ton capacity.

10,000 PSI 20 OZ.

401A

AIR/HYDRAULIC FOOT PUMP - HEAVY DUTY

030212

- Operates at 90 - 120 PSI
- Develops up to 10,000 PSI pressure with overload protection
- 17-1/2" length
- 20 oz. oil capacity
- Shipping weight: 12 lb (5 kgs)

10,000 PSI 54 OZ.

402

AIR/HYDRAULIC FOOT PUMP - HEAVY DUTY

030214

- Operates at 90 - 140 PSI
- Develops up to 10,000 PSI pressure with overload protection
- Can be used with large diameter and multiple rams
- 10" L. x 5-1/4" W. x 8-1/2" H. (tank is 4-1/2" H.)
- 54 oz. oil capacity - aluminum reservoir
- Shipping weight: 20 lb (9 kg)



BRK4PH • 030283

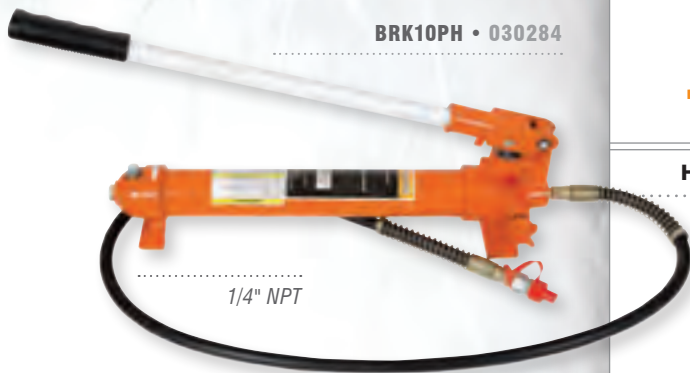

BRK10PH • 030284

1/4" NPT

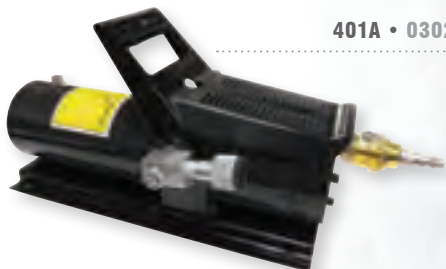

401A • 030212

402 • 030214
54 oz. oil capacity



1/4" NPT

3/8" NPT



HYDRAULIC RAMS - HEAVY DUTY

STRONGARM Hydraulic Rams are professional quality, designed to provide trouble free service to meet a wide range of needs. They are used to provide 2 to 10 tons of reliable, concentrated force in lifting, pulling, pushing, bending and alignment applications. STRONGARM ram models include mini, snap-style, screw, pull, wedge, and long configurations that can be used with STRONGARM and other body and frame repair kits as well as in vehicle service facilities, farms, industry and construction.

MOD. NO.	PROD. NO.	Cap. (Tons)	Ram type	Stroke	Compressed	Extended	Spring return	Shipping Weight
409A	030232	2	Push	3"	4-7/8"	9-9/16"	No	2 lb (1 kg)
411A	030234	4	Push	5"	11"	16"	Yes	4 lb (2 kg)
437A	030239	4	Push	5/8"	1-5/8"	2-1/4"	No	2 lb (1 kg)
412A	030235	10	Push	6"	15"	21"	Yes	12 lb (5 kg)
438A	030240	10	Push	2-1/4"	4-5/8"	6-7/8"	Yes	6 lb (3 kg)

PUSH RAMS - HEAVY DUTY

MOD. NO.	PROD. NO.	Cap. (Tons)	Stroke	Compressed	Extended
BRK4RAM	030241	4	4"	267mm / 10.5"	14.5"
BRK10RAM	030242	10	5"	318mm / 12.5"	17.5"



MANUAL LONG RAMS - HEAVY DUTY

STRONGARM Long Ram Jacks are available in 3 and 8 ton capacities in both manual hand pump and air/hydraulic versions. Ideal for a multitude of applications such as floor model engine cranes and trailer jacks. All models have a clevis pin system pre-drilled into piston shaft for use on cranes.

MOD. NO.	PROD. NO.	Cap. (Tons)	Type	Stroke	Compressed	Extended	Shipping Weight
403C	030371	3	Manual	20-3/4"	24-1/4"	45"	27 lb (12 kg)
408C	030381	8	Manual	20-3/4"	24-1/4"	45"	37 lb (17 kg)

10,000 PSI

BRKH

HYDRAULIC HOSE

030292

- 5' Hose
- 10,000 PSI working pressure / 20,000 PSI burst pressure
- Spring guards on both ends of hose prevents kinking



409A • 030232

412A • 030235

411A • 030234

438A • 030240

437A • 030239



408C • 030381



BRKH • 030292

By Model Number

112.....	28	380C.....	4	802A-1.....	14	878A.....	19	JHJ-17-1/2LP.....	5
120A.....	28	401A.....	34	802A-2.....	14	952B.....	6	JHJ-22-1/2.....	5
135.....	29	402.....	34	802A-3.....	14	955.....	8	JHJ-22-1/2LP.....	5
150.....	29	403C.....	35	802A-4.....	14	956.....	8	JHJ-35.....	5
200A.....	25	408C.....	35	802A-5.....	14	957.....	8	JHJ-60.....	5
205B.....	26	409A.....	35	802A-6.....	14	958A.....	13	JTJ-5SV.....	5
208B.....	27	411A.....	35	802A-7.....	14	959.....	8	JTJ-10SV.....	5
209.....	27	412A.....	35	802A-8.....	14	962.....	6	SJ-05.....	24
216.....	26	437A.....	35	802A-9.....	14	965GTO.....	7	SJ-10.....	24
218.....	26	438A.....	35	802A-10.....	14	966HO.....	7	SJ-15.....	24
224.....	15	527.....	12	804A.....	22	970SD.....	8	SJ-20.....	24
234B.....	23	528.....	12	806A.....	22	BRK-4T.....	33	SJ-25.....	24
236A.....	23	529.....	13	808A.....	22	BRK-10T.....	33	SJH-05.....	24
238.....	27	623.....	15	814A.....	20	BRK20T-SHD.....	32	SJH-10.....	24
239.....	27	624A.....	15	816A.....	21	BRK4PH.....	34	SJH-15.....	24
302A.....	4	720SD.....	9	8177.....	21	BRK10PH.....	34	SJH-2025.....	24
304A.....	4	728C.....	9	818.....	21	BRK4RAM.....	35	SP20T-SHD.....	30
306A.....	4	730SHD.....	10	853A.....	19	BRK10RAM.....	35	SP30T-SHD.....	30
308A.....	4	735.....	4	856A.....	19	BRKH.....	35	SP50T-SHD.....	30
312A.....	4	740.....	9	869A.....	19	BRKSPRAM.....	33	SP75T-SHD.....	31
314A.....	4	750SHD.....	10	871A.....	18	JHJ-2.....	5	SP100TASHD.....	31
320A.....	4	760SHD.....	11	872B.....	19	JHJ-3.....	5	TR-20ATW.....	16
322A.....	4	780SHD.....	11	873A.....	18	JHJ-5.....	5	WTS15H-SHD.....	16
330A.....	4	790.....	20	874A.....	17	JHJ-8.....	5	WTS15L-SHD.....	16
350A.....	4	792B.....	20	875A.....	17	JHJ-12-1/2.....	5	WTS33H-SHD.....	16
352A.....	4	800A.....	22	876A.....	17	JHJ-12-1/2LP.....	5		
370C.....	4	802A.....	14	877.....	17	JHJ-17-1/2.....	5		

By Product Number

030102.....	4	030284.....	34	030458.....	13	030529.....	21	032243.....	19
030103.....	4	030292.....	35	030461.....	8	030531.....	21	032246.....	19
030104.....	4	030303.....	25	030466.....	8	030542.....	22	140101.....	5
030105.....	4	030315.....	26	030474.....	10	030545.....	22	140102.....	5
030106.....	4	030318.....	26	030475.....	10	030547.....	22	140103.....	5
030107.....	4	030321.....	26	030476.....	11	030549.....	22	140104.....	5
030110.....	4	030341.....	27	030477.....	11	032161.....	28	140105.....	5
030111.....	4	030342.....	27	030481.....	16	032166.....	28	140106.....	5
030112.....	4	030343.....	27	030482.....	13	032173.....	29	140107.....	5
030114.....	4	030344.....	27	030483.....	15	032175.....	29	140108.....	5
030115.....	4	030352.....	23	030484.....	15	032181.....	30	140109.....	5
030152.....	4	030353.....	23	030485.....	15	032182.....	30	140110.....	5
030157.....	4	030371.....	35	030501.....	14	032184.....	30	140111.....	5
030202.....	33	030381.....	35	030502.....	14	032185.....	31	140112.....	5
030207.....	33	030406.....	7	030503.....	14	032187.....	31	141503.....	24
030212.....	34	030407.....	7	030504.....	14	032202.....	17	141504.....	24
030214.....	34	030411.....	6	030505.....	14	032204.....	17	141505.....	24
030232.....	35	030415.....	6	030506.....	14	032206.....	17	141506.....	24
030234.....	35	030434.....	8	030507.....	14	032211.....	17	141508.....	24
030235.....	35	030436.....	8	030508.....	14	032215.....	16	141509.....	24
030239.....	35	030438.....	8	030509.....	14	032216.....	16	141512.....	24
030230.....	33	030442.....	4	030510.....	14	032217.....	16	141513.....	24
030240.....	35	030443.....	9	030511.....	14	032222.....	19	141516.....	24
030241.....	35	030445.....	9	030521.....	20	032226.....	18	149123.....	5
030242.....	35	030448.....	9	030522.....	20	032228.....	18	149125.....	5
030250.....	32	030454.....	12	030524.....	20	032229.....	19		
030283.....	34	030457.....	12	030527.....	21	032241.....	19		

Alphabetical

Air Lift Jacks.....	12 - 13	Engine Stands.....	23	Jack Stands.....	18 - 19	Stands.....	16 - 19
Body Repair.....	32 - 33	Engine Tilters and Supports.....	27	Long Ram Jacks.....	35	High Reach Fixed - SHD.....	16
Bottle Jacks.....		Floor Jacks - Hydraulic.....	6 - 8	Low Profile.....	4, 5, 18, 22	Under-Hoist Component.....	17
Air/Hydraulic.....	4	Floor Presses.....	28 - 31	Pumps.....	34	Under-Hoist Stabilizing.....	17
Manually Operated.....	4 - 5	Standard Duty.....	28	Rams.....	35	Transmission Jacks.....	20 - 22
Screw Jacks.....	24	Heavy Duty.....	24	Screw Jacks.....	24	Truck Axle Air/Hydraulic Jacks.....	9
Clutch Jack and Accessories.....	14	SHD.....	30 - 31	Service Jacks.....	6 - 9, 12 - 13	SHD.....	10 - 11
Collision Repair.....	32 - 33	Floor Truck Jack - Air/Hydraulic.....	8	Manual.....	6 - 8	Truck Ramps.....	16
Heavy Duty.....	33	Foot Pumps - Air/Hydraulic.....	34	Air/Hydraulic.....	8, 9, 10, 11	Wheel & Brake Drum Dollies.....	15
SHD.....	32	Fork Lift Hydraulic Jack.....	13	Multi-Stage.....	10 - 11		
Cranes - Hydraulic.....	25 - 27	Hand Pumps - Hydraulic.....	34	Shop Presses.....	28 - 31		
Engine Cranes.....	25 - 26	Hose.....	35	Specialty Truck Equipment.....	14 - 15		

Canada's Leading Supplier of Lifting and Hydraulic Equipment to the Professional Automotive and Heavy Duty Markets



One Year Limited Warranty

JET Equipment & Tools Ltd. (JET®) makes every effort to ensure that it's **STRONGARM** branded products meet the highest quality and durability standards. All **STRONGARM** products are guaranteed to be free of defects in material and workmanship for a period of one year following the date of purchase. This warranty is extended to the original retail purchaser only.

If one of these products fail during its warranty period due to defective material or workmanship, it will be repaired or replaced at JET's discretion.

This warranty does not apply to any product showing signs of abuse, misuse, overloading, alteration, or improper maintenance. Normal wear and tear on moving parts or seals where applicable is specifically excluded from this warranty. To obtain repair or replacement, the defective product must be shipped, transportation charges prepaid, to the nearest authorized service depot with proof of purchase.

Repair or replacement is the exclusive remedy for defective equipment under this warranty. This Warranty is expressly in lieu of all other warranties, including the implied warranty of merchantability or any implied warranty of fitness for a particular application on this equipment.

JET® shall not be liable for any consequential or incidental damages for breach of any expressed or implied warranty on this equipment.

WARNING

Jacks are for lifting vehicles only. Support the vehicle with safety stands immediately after lifting. DO NOT attempt to move the vehicle with the jack. Use only on a hard level surface. Auxiliary / High Stands are for accessories only and are not designed or intended to support a vehicle. Transmission Jacks are for the removal, installation and transportation of transmissions and differentials. Transmission Jacks may be used with appropriate adaptors manufactured specifically for the jack to handle other components, such as rear axle units and transfer cases, within the weight limitations specified. No alteration to any of the jacks or adaptors shall be made. Do not overload. Do not extract or drain caustic or flammable products with any of our lubrication equipment. Only use the device for the purpose for which it has been designed. Follow safety instructions included with product for safe use.



JET reserves the right to change appearance and specifications at any time.

OUR PRODUCT LINES



Scan QR Codes with your smart phone
to see our products online



Check out our other quality
JET® products on our website:

www.jetequipment.com

ABRASIVES & CUTTING TOOLS



AIR TOOLS & AIR LINE ACCESSORIES



HAND TOOLS

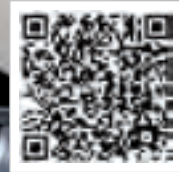

MATERIAL HANDLING



STRONGARM®

For over 50 years **STRONGARM** has been the leading brand of high quality lifting & hydraulic equipment to the demanding automotive, tire and heavy duty truck and fleet markets across Canada. Professionals in all industries have come to rely on **STRONGARM's** reputation for superior, high performance tools that stand up to the toughest work environments. If you are looking for outstanding, innovative products to make your job easier, check out our wide range of products. Not only will they save you time, effort and improve your productivity, but will also provide a safer and less stressful work environment. Make **STRONGARM** your brand of choice – you will be happy you did!

Product Range

STRONGARM carries one of the widest ranges of hard working, high performance lifting & hydraulic equipment in Canada. These include innovative tools such as the incredible heavy duty clutch jack (precise, easy-to-use and an industry back saver), our latest and greatest aluminum body 2 stage axle jack (another back saver), super duty truck axle jacks up to 40 ton capacity and the list goes on. All **STRONGARM** products are manufactured to exacting specifications and tolerances to meet the most demanding field applications.

Strategic Warehouse Locations

Once again, **STRONGARM** leads the way in Canada by offering large inventories in six strategically located warehouses across the nation. These warehouse facilities ensure our customers receive the fastest delivery times regardless of their location. When the heat is on and customers need product now, **STRONGARM** has the advantage.

After Sales & Service

STRONGARM is 100% committed to the Canadian market and the products that we sell. We employ a large staff of sales and customer service representatives to ensure that our customers needs are met before and after the sale. In addition, **STRONGARM** carries a large quantity of parts to service all of our products through a wide range of warranty and service centers across Canada.

Canadian Industry Knowledge

STRONGARM has been the key player in the lifting & hydraulic business longer than any other Canadian company. Our years of dedicated service to this unique and challenging market has enabled us to design and build a product line that offers all of the features necessary to provide the best product for the job at hand. We have worked closely with our distributors and, more importantly, customers on the shop floor, to develop tools that exceed their needs and expectations. That's why you will find more **STRONGARM** products in tire, automotive service and heavy duty truck repair facilities than any other brand in Canada. So when you need quality, dependable and safe equipment, count on **STRONGARM**. Thousands of other happy customers do!



Duty Levels

LIGHT DUTY

Manufactured to withstand light to medium intermittent use by professionals

STANDARD DUTY

Manufactured for moderate everyday use by professionals

HEAVY DUTY

Manufactured for heavy use and wear by professionals

SUPER HEAVY DUTY

Unprecedented strength, designed to thrive in extreme conditions





**ABRASIVES
& CUTTING TOOLS**

Coated Abrasives
Bonded Abrasives
Surface Conditioning
Products
Wire Products
Diamond Products

**AIR TOOLS &
AIR LINE ACCESSORIES**

Air Drills
Air Grinders
Air Sanders
Impact Wrenches
Spray Guns

**HAND
TOOLS**

Hand Tools
Specialty Automotive Tools
Tool Storage
Shop Equipment
Lubrication &
Fluid Transfer Products

**MATERIAL
HANDLING**

Electric Hoists
Hydraulic / Mechanical Jacks
Manual Hoists & Pullers
Pumps
Trolleys & Clamps
Winches

Contact your nearest distributor
for complete information on
our product lines.

Check out our quality
products on our website:

\$3.95 CDN ea.

www.strongarminc.com