

Gabriel®



**2011
TRUCK, TRAILER & BUS SHOCKS**



Table of Contents

About Gabriel Commercial Vehicle Shocks	
Product Information	1
When Shocks Should be Changed	8
Shock Disposal Instructions	11
Warranty Policy	12
Catalog Changes	13
Applications Listing	
Cab Shocks	14
Shocks for Special Applications..... (Steering Stabilizers, Hood Dampers)	21
Light Trucks	23
Medium & Heavy Duty Trucks, Trailers & Buses.....	59
Numerical Listing	
Shocks for Special Applications.....	231
Gas Light Truck	231
Fleetline®	234
GasSLX®	242
Interchange Listing	
Competitive Interchange	245
OEM Interchange.....	256
Fleetline® /GasSLX® Interchange	278
Manufacturer No. to Catalog No. Interchange	279
How to Determine the Correct Shock for Your Truck	
Determining the Series/Measuring External Dimensions	282
Identifying the Mounting Style/Measuring Extended & Collapsed Lengths	283
Determining the Mounting Code/Gabriel End Mount Designs	284
Finding the Correct Part Number/Specifications by End Mount.....	287
Specifications by Part Number.....	300
Mounting Accessory Packages	
Component Parts Listing.....	313
Buyer's Guide.....	321
Sección en español	
Tabla de materias.....	324
Section française	
Table des matières.....	339

Gabriel®

TRUCK, TRAILER & BUS SHOCKS

Evolution to Higher Performing Shocks

The higher performance demands of today's vehicles require shocks that stand up to the challenge.

Heavy multi-leaf suspensions have very limited travel and a high level of inherent friction. The multi-leaf quickly dampens suspension oscillation and therefore limits the amount of work shock absorbers need to perform.

Today's low friction suspensions, such as Air Spring and Taper Leaf, are engineered to have very little suspension damping friction and a great deal of vertical travel. These characteristics enhance the operational control and performance of today's vehicles. Plus, they help reduce physical strain on the driver by isolating equipment and its cargo from highway vibration damage.

Overall, low friction suspensions have increased the need for control of suspension oscillation increasing the importance of peak performance by the shock absorber.



Multi-Leaf Suspension

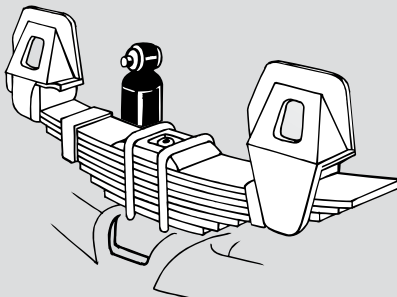

The inherent damping friction limits suspension travel to 2-3".

Air Spring Suspension

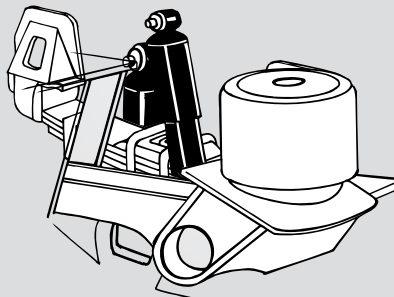

The damping responsibility has been shifted over to shocks. These suspensions can travel in excess of 9".

Taper-Leaf Suspension

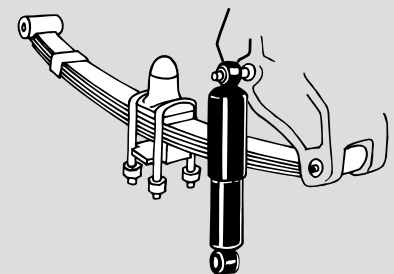

Gabriel®

TRUCK, TRAILER & BUS SHOCKS

GasSLX (Heavy Truck Gas Shocks/Adjustable)

89000 Series

Our premium adjustable Heavy Truck gas shock.

- Unique Gas Cell double seals for superior gas retention
- Three position adjustable offers personal ride selection
- 1-5/8" bore, 360° arc welded end mounts provides improved durability
- Specially formulated High Temperature fluid reduces friction and wear in extreme operating conditions
- Many more premium component upgrades combine to provide the ultimate in performance and durability



FleetLine (Heavy-Duty Truck Shocks)

83000 Series*

A heavy duty product, best suited for light trucks or heavy truck suspensions where clearance is an issue.

- 1-3/8" bore
- 10 stage valving

85000/85300 Series*

Added durability makes these two series the standard heavy duty product for today's low friction suspensions.

- 1-5/8" bore provides improved durability
- 360° arc welded end mounts protect against end mount breakage
- Hydraulic rebound stop¹ prevents impact damage to the shock and vehicle mounting components
- Multi-lip piston rod seal provides backup seal protection
- Welded closure for maximum tensile strength



85700 Series*

Designed for unique truck applications and for severe duty bus applications. The specialty features of this series ensure a long consistent operating life.

- 1-5/8" bore with a bulged design provides increased fluid capacity for cooler operation
- Patented rod seal material significantly increases the life of the seal
- Custom blended HT Fluid reduces friction and wear in extreme operating conditions
- Plus all of the specialty features contained in the 85000 & 85300 Series



* Self compensating piston seal provides consistent damping throughout shock life

¹ Where required.

Gabriel®

TRUCK, TRAILER & BUS SHOCKS

FleetLine Cab Shocks

Cab Shocks

Designed specifically to eliminate cab vibration.

- 1", 1-3/16", 1-3/8", 1-5/8" bore sizes provide customized suspension for different cab designs
- Unique Gas Cell³ design reduces fade as result of fluid aeration
- Exclusive 10 stage valving provides a consistent ride at all speeds
- Premium chrome plated piston rod designed for corrosion resistance and reduced rod seal wear
- Multi-lip piston rod seal provides backup seal protection and increased durability



Gas Light Truck

G6000 Series

For consistent performance you can count on.

Targeted at standard light truck and van applications.

- 1-3/8" bore
- Gas charged
- Piston rod and radial lip seal
- Non-commercial applications only



Steering Stabilizers

- Reinforced arc welded end mounts protect against end mount breakage and provide improved durability
- Unique Gas Cell design separates air and oil so shock functions properly while in the horizontal position
- Custom designed (OE styled) mounts for improved fit and increased durability

Shock absorbers engineered with the same focus on quality, design, longevity and endurance that has come to characterize our world renowned Original Equipment shock absorbers.

³ Where design permits.

Gabriel[®]

TRUCK, TRAILER & BUS SHOCKS

FleetLine Cab Shocks¹

Designed specifically to eliminate cab vibration!
"See pages 14 - 18 for specific applications listing."



- Unique GAS CELL² design reduces fade
- Exclusive 10 stage valving provides consistent control at all speeds
- Premium chrome plated piston rod designed for corrosion resistance and reduced rod seal wear
- Multi-lip nitrile piston rod seal for increased durability
- All weather shock fluid keeps shock functioning normally in extreme temperatures

¹ For truck applications only

² Where design permits

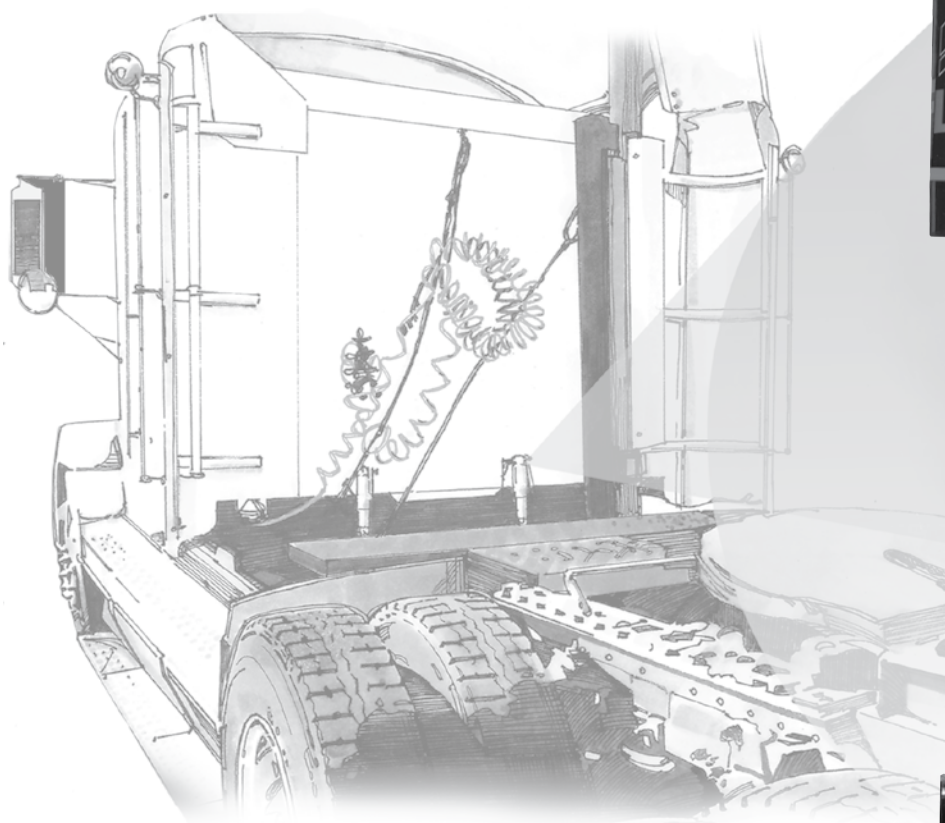

Gabriel®

TRUCK, TRAILER & BUS SHOCKS

GasSLX – The ultimate "SLXtion" in ride!

- The three position GasSLX adjustable shock allows you to choose from one of 3 settings; "Firm", "Regular" and "Extra Firm."
- Firm - closest to OE ride performance
- Regular - a softer ride than that of the OE shock
- Extra firm - more controlled ride

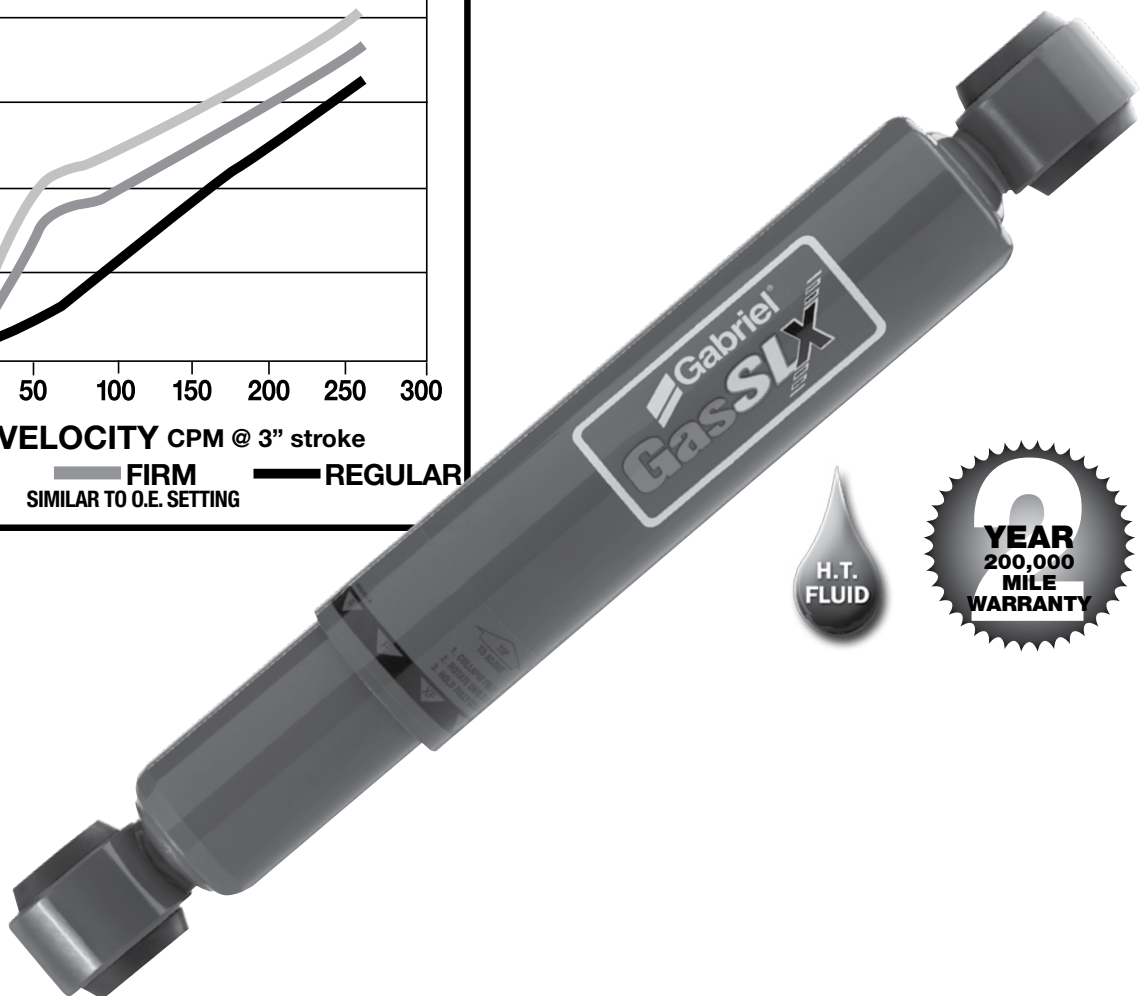
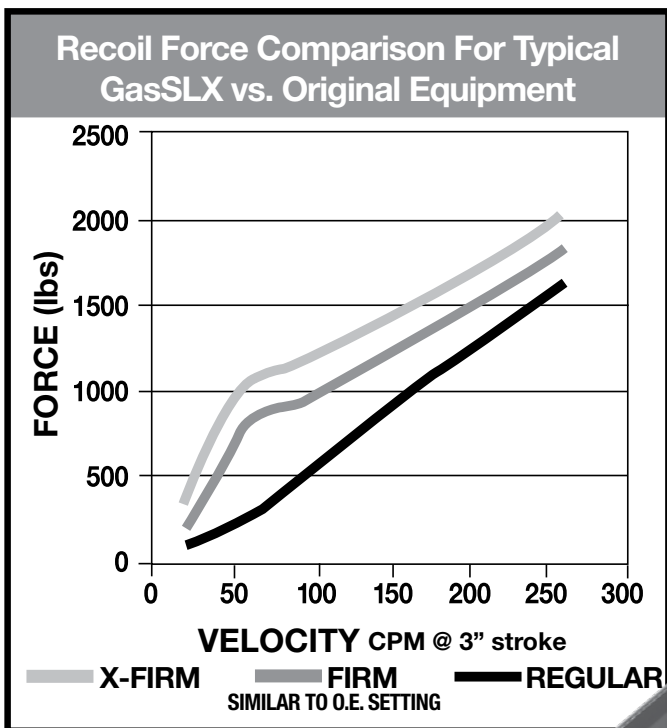

Gabriel®

TRUCK, TRAILER & BUS SHOCKS

GasSLX – This shock provides reliability, control, comfort and ride selection

We believe a premium upgrade is more than just a promise, it's a commitment to deliver. The Gabriel GasSLX was engineered using proven premium components that deliver distinguishable benefits.

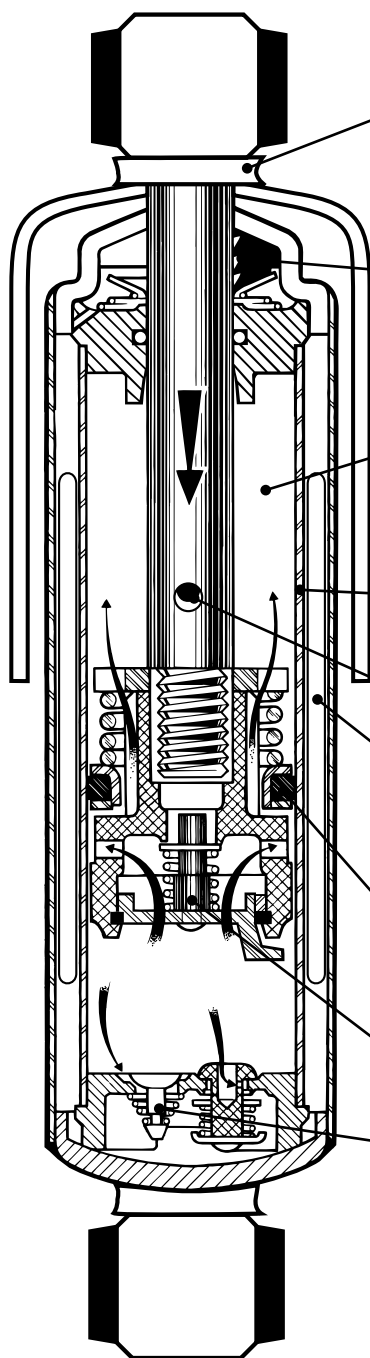

360° ARC WELDED END MOUNTS
Protects Against End Mount Breakage.

Today's suspensions require shocks to withstand multi-directional flexing. Reinforcing the weld 360°, ensures structural superiority.

Improved Tensile Strength.

Gives the added strength required to limit travel on air suspensions.

MULTI-LIP VITON SEAL

A More Robust Seal Design for Greater Fluid Retention and High Temperature Performance.

Multi-sealing lips act as backup to keep fluid in.

HIGH TEMPERATURE (HT) FLUID

Reduces Friction and Wear in Extreme Operating Conditions.

Extreme pressures and temperatures can break down standard shock absorber fluids. The Gabriel HT Fluid is uniquely formulated to maintain its lubricating properties at pressures and temperatures 2 to 3 times greater than standard shock fluids.

H.T.
FLUID

LARGE BORE DESIGN

1-5/8" Bore. Proven OEM Design.

The optimum working area when combined with our HT fluid, provides performance and durability you can count on.

HYDRAULIC REBOUND STOP¹

Prevents Impact Damage to the Shock and Vehicle Mounting Components.

At full extension, the restriction hole in the rod is closed off and traps fluid between the piston and upper cylinder head, creating a hydraulic cushion.

GAS CELL

Double Seals Sulfur Hexafluoride (SF₆) Gas to Ensure that it Remains Within the Shock.

The gas cell separates the gas from the fluid so they cannot mix, keeping the fluid free of the bubbles that can cause fade.

PRESSURIZED METAL PISTON RING

Hydraulically Energized to Maintain the Required Damping Characteristics.

As the ring wears, the hydraulic pressure forces the ring out to the tube to maintain the seal and damping characteristics.

10 STAGE VALVING

Improves Handling While Maintaining Ride Comfort.

Allows for the independent adjustment of damping.

¹ Where required by design



Gabriel®

TRUCK, TRAILER & BUS SHOCKS

FleetLine

Top quality components ensure top performance throughout the life of the shock absorber, meaning less wear and tear on other costly suspension parts.



Cold Formed, 360° Arc Welded Mounts*

- Greater tensile strength
- Greatly reduces end mount failures

Multi Lip Seal

- Extra seal protection = Improved fluid retention
- Improved fluid retention = Longer shock life

1-5/8", Large Bore Design*

- Increased tensile strength
- Designed for more control
- Proven design for low friction suspensions

Bulged Design**

- Increased fluid capacity
- Lower operating temperatures
- Less internal wear due to heat dissipation

Hydraulic Extension Stop¹

- Prevents shocks from topping out and suspensions from over-extending
- Designed for low friction suspensions such as Air Spring Suspensions, etc.

Floating Piston Seal Design

- Reduces force-velocity variabilities
- Increase control capabilities at low velocities
- Self-compensates for wear
- Reduced wear between the cylinder and the piston seal means reduced clearance which means less fade
- Less fade means more consistent performance over the full range

10 Stage All Coil Spring Valving

- For comfort and control
- Enhanced durability
- Self cleaning

¹ Where required by design

* Excluding 83000 Series

** Including 85300 and 85700 Series

Note: Features may vary by part number.





Gabriel®

TRUCK, TRAILER & BUS SHOCKS

When Should Shock Absorbers Be Changed?

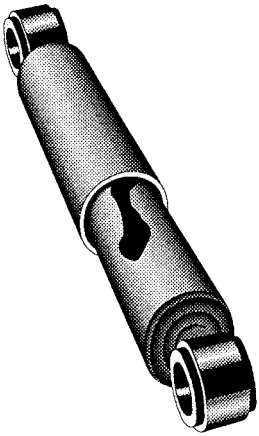
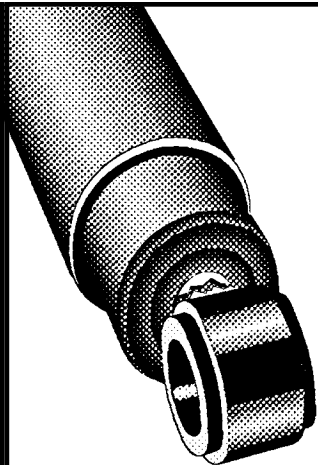
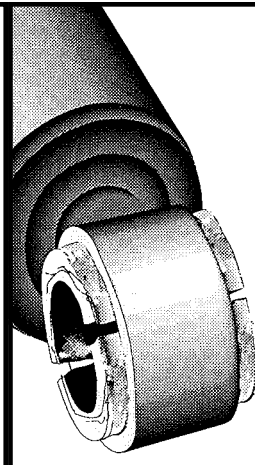
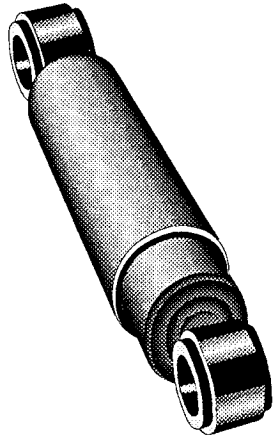
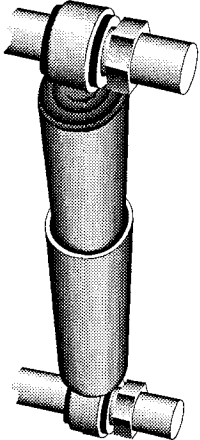
All of the following conditions indicate that it is time to replace your shock absorbers. Remember worn shock absorbers can cause vibration that leads to electrical, frame, and/or engine damage. Regular inspection of shock absorbers can prolong the life of your vehicle.

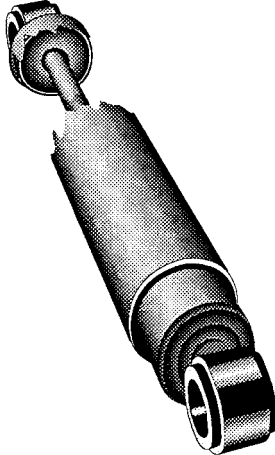
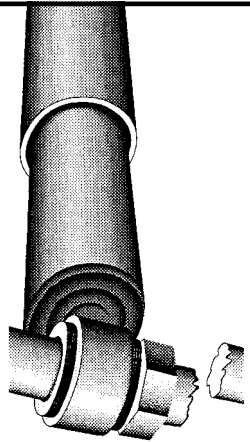
			
<p>L Leaking (Be sure to wipe shock of road grime)</p>	<p>UMB/LMB Upper or lower mount broken</p>	<p>UBB/LBB Upper or lower bushing broken</p>	<p>BI/S Broken internally Seized (Jammed in collapsed position)</p>
	<p>• Soft undulating ride • Nose diving • Too rough</p> 		
<p>II Improper Installation (for example: this shock is upside down)</p>	<p>RC Ride Complaint</p>	<p>DT Dust Tube Broken</p>	<p>TMF Truck Mount Failure</p>

Gabriel®

TRUCK, TRAILER & BUS SHOCKS

Guide to Inspecting Truck Shocks

Regularly scheduled shock maintenance doesn't cost in the long run - it saves.

Like most other chassis components, a program of regular scheduled maintenance for shock absorbers will help to avoid unscheduled down time and reduce overall maintenance costs.

The role of a shock has changed dramatically. Previously, suspensions had heavy multi-leaf springs with limited travel and a great deal of inherent friction. These suspensions quickly self dampened and therefore limited the amount of work the shock needed to perform.

Low friction suspensions such as Air and Taper Leaf have dramatically changed the shock's role. Shocks now play a critical role in dampening suspension oscillation. Properly functioning shocks can help reduce the wear of more expensive suspension components such as air bags, while assisting in the reduction of tire wear and vibration damage to the cab and chassis. They also aid in reducing driver fatigue. Worn shocks simply cannot assist in providing control over today's sophisticated suspension systems.

Leaking vs. Misting Shocks

Misting shocks are often mis-diagnosed as failures. Misting is the process whereby very small amounts of shock fluid evaporate at high operating temperatures through the upper seal of the shock. When the "mist" reaches the cooler outside air, it condenses and forms a film on the outside of the shock body. When mixed with road debris and dust, a grime will often coat the entire body of the shock. Misting is a perfectly normal and necessary function of the shock. The fluid which evaporates through the seal area helps to lubricate & prolong the life of the seal.

Many technicians find it difficult to differentiate between a misting shock and a true leaker which needs to be replaced. A leaker will show clear signs of fluid leaking in streams from the upper seal. These streams can most easily be seen when the shock is fully extended, and one inspects as far up the main body of the shock (underneath the dust cover or tube) as possible.

Inspect with shocks fully extended

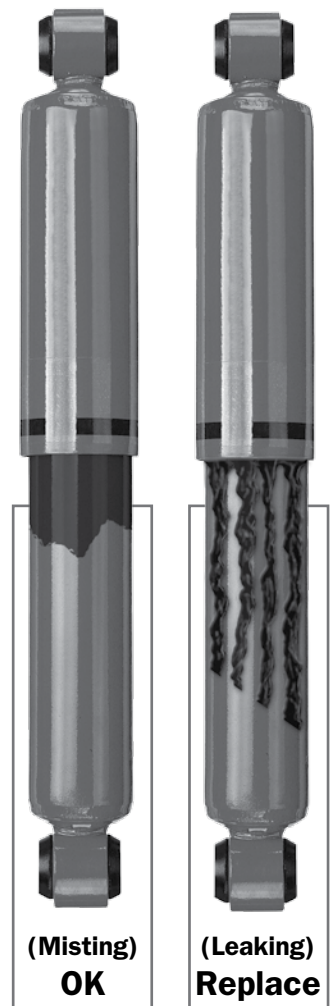

When should shocks be replaced?

There are many tell tale signs that indicate it may be time to replace shocks. Inspect for:

- **Uneven Tire Wear** - Balance should be checked first
- **Ride Deterioration**
- **Excess Vibration**
- **Sagging Taper Leaf Springs** - This is not caused by weak shocks
- **Premature wear** on cab, electrical, and cooling system components
- **Broken or Torn Air Springs** - Shocks will only affect this if they are broken or are missing

Gabriel®

TRUCK, TRAILER & BUS SHOCKS

Take the Heat Test

Shock absorbers function at temperatures ranging from ambient to 350°F. A shock's role is to dampen the oscillation of the truck's springs. It does this by transforming the energy produced by the spring to heat and dissipating it. As a result the shock should be slightly warm to hot to the touch after normal use.

If ride deterioration is experienced and there is suspicion that a shock has failed internally, which is visually undetectable, perform the following "SHOCK HEAT TEST" within a few minutes of operating the equipment:

1. Drive the vehicle at moderate speeds for at least 15 minutes.
2. Within a few minutes of driving the vehicle, touch each shock absorber carefully on its body below the dust cover or tube, after first touching a nearby part of the chassis to establish a reference ambient temperature of the metal.
3. All shock absorbers should be warmer than the chassis. Suspect a failure in any shock absorber that is noticeably cooler than its mate on the other end of the axle. Different temperatures from axle to axle do not indicate failures, but cooler temperatures on any one axle does warrant removal and examination of the cooler shock absorber.
4. To inspect for an internal failure, remove and shake the suspected shock. Listen for the sound of metal parts rattling inside. Rattling of metal parts can indicate that the shock has an internal failure.

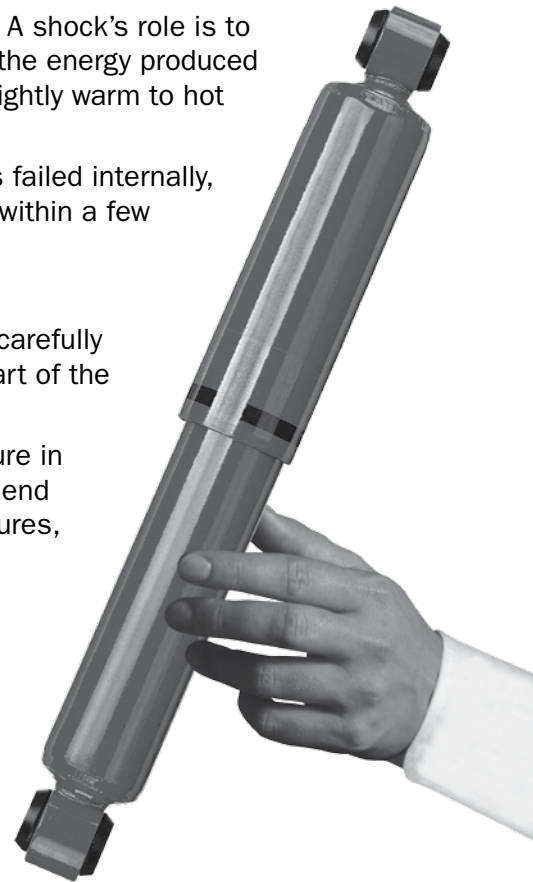

Shock Visual Checks

Look for these potential problems

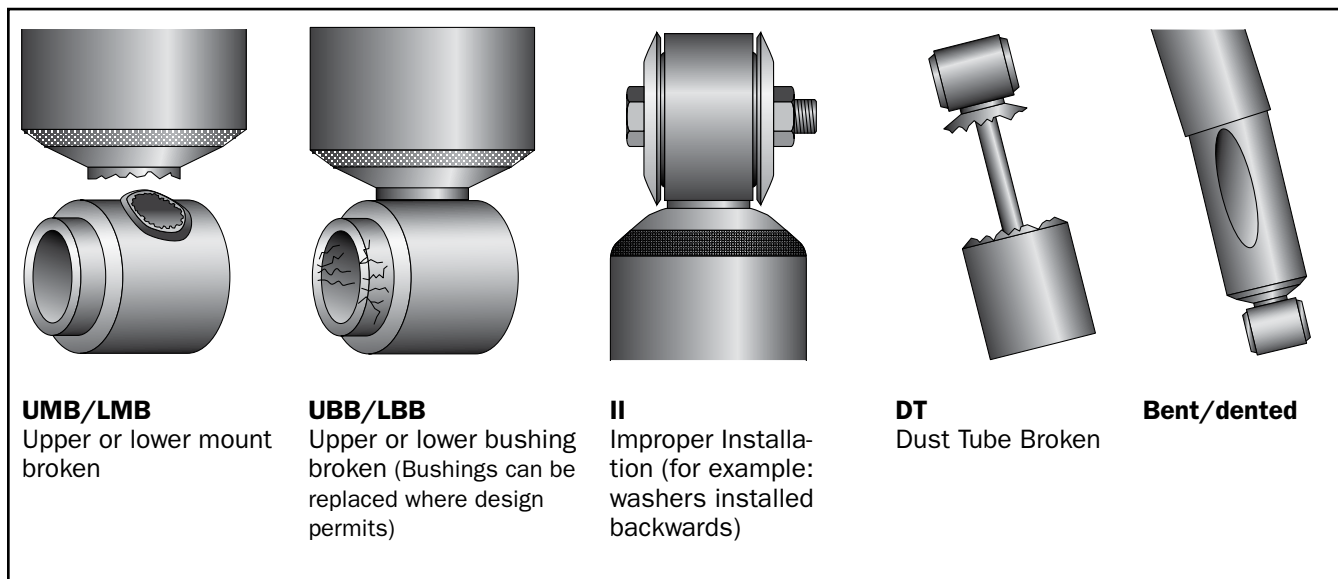

Gabriel®

TRUCK, TRAILER & BUS SHOCKS

Disposal Instruction

General Remark

Appropriate protective measures, such as wearing safety glasses and protective gloves, should be taken when removing oil and gas from discarded and defective shock absorbers.

Procedure

1. Secure the shock absorber in a horizontal position.
2. Fully extend the piston rod prior to drilling the unit.
3. Using a 1/8" (3mm) drill bit, drill a hole in a downward direction approximately 1.0" (25 mm) from the bottom of the shock absorber to a depth of about 1.0" (25 mm) (see fig. A).
4. Drill a second hole of about 1/8" (3 mm) at 2.0" (50 mm) from the top of the shock absorber to depth of about 1.0" (25 mm), in order to allow all of the oil to flow out (see fig. B).
5. By moving the piston rod in and out, begin stroking the unit to completely purge the oil from the cylinder of the unit (see fig. C).

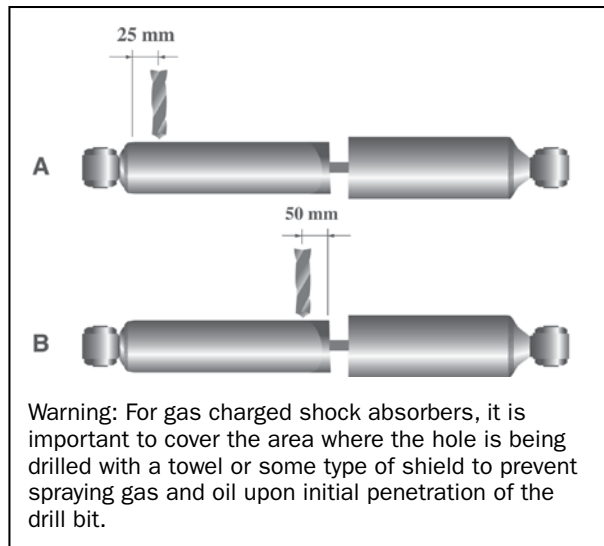

Environmental Information

6. Collect all used oil, **being careful not to mix oil with any other waste or refuse**. Store the used oil in an approved container clearly marked "Used Oil".
7. Dispose of the remaining shock body and internal parts in accordance with your local State or Provincial legislation concerning waste oil and other wastes.
8. Store, dispose, and/or transport used oil in accordance with environmental regulations and used oil program regulations in your state or province.

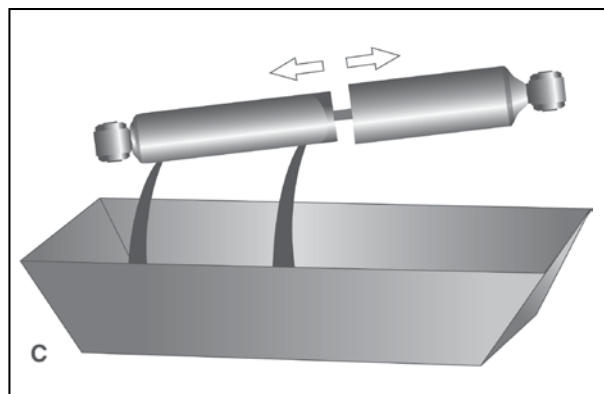

Used shock oil may be disposed in the container used for recycling engine oils. Information on where to dispose of the oil and other parts can be obtained from environmental authorities or oil suppliers.

Gabriel[®]

TRUCK, TRAILER & BUS SHOCKS

Warranty Policy on Gabriel Shock Absorbers (Heavy Truck Program)

Commercial Warranty

Gabriel Shock Absorbers are warranted as follows:

GasSLX Shock Absorbers (89000 Series) against manufacturing defects for two years from date of purchase or for 200,000 miles (322,000 km) whichever occurs first.

FleetLine Shock Absorbers (83000, 85000, 85300, 85700, 85900 and 87000 Series) against manufacturing defects for one year from date of purchase, unlimited mileage.

THIS COMMERCIAL WARRANTY IS LIMITED TO THE REPLACEMENT OF THE DEFECTIVE PRODUCT ONLY. Cost of shipping, removal and installation is not included. This warranty applies to the original purchaser under normal operating conditions.

The provisions of this warranty shall not apply to product: (a) installed on any vehicle(s) registered or used for racing, or competitive purposes; (b) used for any purpose for which it was not designed; (c) which has been altered or subjected to misuse, negligence or accident; (d) which has been improperly installed.

Non-Commercial Warranty

Gabriel Shock Absorbers are warranted as follows:

Gas Light Truck Shock Absorbers, (G60000 Series) against manufacturing defects for one year from date of purchase or for 25,000 miles (40,250 km) whichever occurs first. This warranty applies to the original purchaser, for use on private passenger light trucks and vans only, under normal operating conditions.

THIS WARRANTY IS LIMITED TO THE REPLACEMENT OF THE DEFECTIVE PRODUCT ONLY. Cost of shipping, removal and installation is not included.

The provisions of this warranty shall not apply to product: (a) installed on any vehicle(s) registered or used for commercial, racing, or competitive purposes; (b) used for any purpose for which it was not designed; (c) which has been altered or subjected to misuse, negligence or accident, (d) which has been improperly installed.

2011 CATALOG CHANGES

CAMBIOS EN EL CATALOGO 2011

2011 CHANGEMENTS DU CATALOGUE

N		NEW ITEMS			N
ARTICULOS NUEVOS / NOUVEAUX ARTICLES					
646177	85078	85967	G61872	G61959	
83044	85079	85968	G61873	G61961	
83045	85080	85969	G61875	G61962	
83046	85081	85970	G61877	G61963	
83047	85082	87016	G61878	G61964	
83048	85083	87017	G61879	G61965	
83049	85084	89457	G61880	G61966	
83050	85085	89458	G61881	G61967	
83051	85339	89459	G61882	G61969	
83052	85340	89460	G61883	G61970	
83053	85341	G61169	G61884	G61971	
83054	85377	G61170	G61885	G62000	
83145	85378	G61173	G61886	G62001	
83146	85739	G61175	G61887	G62002	
83147	85740	G61177	G61888	G62003	
83148	85953	G61178	G61889	G62004	
83149	85954	G61180	G61890	G62005	
83150	85955	G61182	G61891	G62006	
83153	85956	G61204	G61892	G62007	
83154	85957	G61860	G61893	G62008	
83155	85958	G61862	G61894	G62009	
83156	85959	G61864	G61895	G62010	
83157	85961	G61865	G61896	G62011	
83158	85962	G61866	G61897	G62012	
83159	85963	G61867	G61898	G62013	
83160	85964	G61868	G61918	G62014	
83161	85965	G61869	G61919	G62015	
83162	85966	G61870	G61958	G62016	

S		SUPERSEDED		S
REEMPLAZADO / REPLACE		REEMPLAZADO / REPLACE		
Sell out /Vender / Épuisé	Then Use /Utilize / Utilisez alors	Sell out /Vender / Épuisé	Then Use /Utilize / Utilisez alors	
85928	85957	G60106	Obsolete	
85064	85938	G60107	G60164	

FLEETLINE CAB SHOCKS

AMORTISSEURS POUR CABINE AMORTIGUADORES DE CABINA

OEM #	Gabriel #
-------	-----------

CHEVROLET TRUCK (Also see GMC Truck)

	Bruin Tractors with J9 Cabs with Link Cabmate Model GMC92J9	1202-0012	83023
1990-	Kodiak Truck Cabs with Link Cabmate Model GMC104TK	1202-0054	83021
-1989	Kodiak Truck Cabs with Link Cabmate Model GMC92TK	1202-0012	83023
	Models with Link Cab Suspension	1202-0022	83046
	Titan Cabover (Sleeper & Non-Sleeper Trucks) with Link Cabmate Model GMC-2P-A	1202-0032	83016

FORD

	8500 & 9500 Series with 113" & 122" BBC Conventional Tractors with Link Cabmate Models FH1322 & FH1322-A	1202-1043	83025
	CL9000 & CLT9000 Cabover Tractors (Sleeper & Non-Sleeper) with Link Cabmate Model FCL110-2P	1202-0032	83016
	Conventional Tractors - L, LT, LN, LNT 800, 8000, 9000 Series, LTS, LS 8000, 9000 Series, & LTL, LL 9000 Series with Link Cabmate Model FN89-A	1202-0012	83023
	L Series Conventional Tractors (All with 60" Able Body Sleepers) with Link Bunkmate Models FAS60-A & FAS60-AS	1202-1044	83025
	L8501 & L9501 Series with 101" BBC Conventional Tractors with Link Cabmate Model FH101	1202-1043	83025
	Models with Link Cab Suspension	1202-0022	83046

AeroMax Series

	9500 Series with O.E.M. Number	F6HZ-5K407-AB	83034
		F6HZ-5K407-BA	83033
		F8HT-5K407-AA	83033
	Models with Link Cab Suspension	1202-0012	83023
		1202-0032	83016
		1202-0042	83025
		1202-0043	83032

FREIGHTLINER

	60" Sleeper models with Link Bunkmate Model FRTS60-A	1202-1043	83025
2000-06	Argosy models with O.E.M. Number	18-37813-000	83044
	Cabover Tractors with the rear cab mounts having a center to center measurement of 50" or 54" & with Link Cabmate Models FRT50-2P-C	1202-0054	83021
2009-11	Cascadia and Columbia Models w/ with 72" High-Roof Sleeper	18-60764-000	83038
2009-11	Coronado w/ O.E.M. Number	18-60764-000	83038
2004-09	Coronado w/ O.E.M. Number	18-41762-000	83038
2004-09	Coronado w/ with 72" Mid-Roof Sleeper	18-41762-002	83038
1997-	FL112 Business Class Day Cab Conventional Tractors with Link Cabmate Model FRT112DC	1202-1044	83025
	Models with Link Cab Suspension	1202-0022	83046
		1202-0042	83025
		1202-0043	83032
		1202-0044	83025

Business Class FL 60, 70, 80 & 106 Series - Conventional Truck & Tractor

	FL60, 70 Series	18-30378	83006
1991-	Trucks with crew cabs with Link Cabmate Model FRT153BC-A	1202-0054	83021
1991-	Trucks with Link Cabmate Models FRT106BC or FRT106HD-A	1202-0054	83021

Business Class M2

2002 & Up	Trucks with Air Spring Suspensions	18-47350-000	83040
2002 & Up	Trucks with Leaf Spring Suspensions	18-47349-000	83039
2011	Models with O.E.M. Number	18-60766-000	83040
		18-60767-000	83039

FLEETLINE CAB SHOCKS

AMORTISSEURS POUR CABINE AMORTIGUADORES DE CABINA

OEM #	Gabriel #
-------	-----------

FREIGHTLINER....cont'd

Century Class

	Models with O.E.M. Number	18-41762-000	83038
	With Day-Cabs with O.E. Number	18-32999-001	83006
	With Sleeper-Cabs with O.E. Number	18-30378-000	83001
		18-32999-000	83001

Classic

	Models with O.E.M. Number	18-29846-000	83009
--	---------------------------	--------------	--------------

Columbia

	Models with O.E.M. Number	18-29846-000	83009
	Models with Sleeper Cab and O.E.M. Number	18-41762-000	83038

FLA Series - COE Truck & Tractor

	COE Series	681-891-02-05	83017
--	------------	---------------	--------------

FLB - COE Truck & Tractors

1993-	90", 100", & 110" Cabs with Link Cabmate Models FRT46-2P-A or FRT46-2P-B	1202-0054	83021
1984-	Cabover Tractors with 86", 96" & 104" Cabs with Link Cabmate Model FRT285	1202-0032	83016

FLC - 120 Conventional Tractors

-Mar 1988	Conventional Tractors with Link Cabmate Model FRTC120-A	1202-0012	83023
1989-	Conventional Tractors with Link Cabmate Model FRTE120-A	1202-1043	83025

FLD Series - 112 & 120 Conventional Truck & Tractor

Sep 93-	64" Able Body Sleepers with Link Bunkmate Models FRTA64 or FRTAS64-A	1202-1044	83025
1989-	Conventional Tractors with Link Cabmate Model FRTE120-A	1202-1043	83025
	D2 Cab	18-41762-001	83047
	FL112 Daycab with Air Suspension	18-31476-000	83020
	FLD Sleeper with Air Suspension	18-29846-000	83009

	Models with O.E.M. Number	18-32999-000	83001
		18-41762-002	83038
		18-44321-000	83009
		18-45067-000	83034
		18-60295-000	83006
		18-60765-000	83047
		18-60772-000	83026
		650361	83017
		654739	83009
		654819	83001
		654831	83006
		654841	83020
		654990	83038
		659079	83040
		659080	83039
		659125	83047
		659178	83038
		659288	83006

FLEETLINE CAB SHOCKS

AMORTISSEURS POUR CABINE AMORTIGUADORES DE CABINA

OEM #	Gabriel #
-------	-----------

GMC

	Astro Cabover (Sleeper & Non-Sleeper Trucks) with Link Cabmate Model GMC-2P-A	1202-0032	83016
	Brigadier Tractors with J9 Cabs with Link Cabmate Model GMC92J9	1202-0012	83023
2003 -	C4500 , C5500 Series Models with Link Cabmate Model GMT560	1201-1043 1202-1043	83025 83025
1979-	Conventional Trucks measuring 108" BBC or 116" BBC with Link Cabmate Model GMC816	1202-0012	83023
	Models with Link Cab Suspension	1202-0022	83046
1990-	TopKick Truck Cabs with Link Cabmate Model GMC104TK	1202-0054	83021
-1989	TopKick Truck Cabs with Link Cabmate Model GMC92TK	1202-0012	83023

INTERNATIONAL (NAVISTAR)

	4000 Series Cabover Tractors with 74", 84" or 88" cabs with Link Cabmate Model IHB-2P	1202-0032	83016
	4000 Series Conventional Tractors with Link Cabmate Model IHC43	1202-0012	83023
	4000 Series Conventional Tractors with O.E.M. Number	2509221C91	83054
Jan1993-	48" & 60" Bentz Sleepers on 9000 Series Conventional Tractors with Link Cabmate Model IHS4860	1202-1044	83025
	7300, 7400 & 7500 Series trucks with day cab or extended cabs with Link Cabmate Model IDC734	1201-9001	83052
	7300, 7400 & 7500 Series trucks with day cab or extended cabs with Link Cabmate Model IDC7345	1201-9008	83054
	7600 Series trucks with day cab or extended cabs with Link Cabmate Model IDC76	1201-9010	83053
	8500 Series trucks with day cab or extended cabs with Link Cabmate Model IDC85	1201-9008	83054
	8600 Series trucks with day cab or extended cabs with Link Cabmate Model IDC86	1201-9011	83053
2004-09	9000 Series Models With 51" Low-Roof Sleeper	1201-0154 2585145C1	83051 83051
2004-09	9000 Series Models With 72" Hi Roof Sleeper	1201-0254 2589922C1	83051 83051
Mar 97-	9100 & 9200 Series Conventionals with Link Cabmate Model ND92-A	1202-1043	83025
	9200 Series	2023684C1	83015
	9300 & 9400 Conventional Tractors with Link Cabmate Model IHC93-A	1202-1043 2503529C1	83025 83025
1981 -	9670 Cabover Tractors with 89" or 110" cabs with Link Cabmate Models IH967-A or IH97110	1202-0032	83016
1982 -	9670, 9700 & 9800 Cabovers with 89" & 110" cabs with Link Cabmate Model NAV9876	1202-0054	83021
1989 -	9700 Cabover Tractors with 110" cabs with Link Cabmate Model IH97110	1202-0032	83016
1989 -	9700 Cabover Tractors with 89" cabs with Link Cabmate Model IH9789	1202-0032	83016
1997 -	Eagle Pro-Sleeper	1202-0054	83021
	HPV 4000 Series travel crew cabs with ITC 42 Link Cabmate Model	1201-9002	83052
	Models with Link Cab Suspension NPS90	1202-0054	83021
	Models with Link Cabmate Models with O.E.M. Number	1201-1043 1201-1049 1201-9003 1201-9007 1201-9009 1202-0012 1202-0022 1202-0032 1202-0042 1202-0043 1202-0044 1202-0054 1202-1212 1202-1213	83025 83025 83052 83054 83054 83023 83046 83016 83025 83032 83025 83021 83013 83005

FLEETLINE CAB SHOCKS

AMORTISSEURS POUR CABINE AMORTIGUADORES DE CABINA

OEM #	Gabriel #
-------	-----------

INTERNATIONAL (NAVISTAR)....cont'd

	All Series with O.E. Number	2012769C2	83005
		2023684C1	83015
		2023685C1	83015
		2025790C1	83013
		2500013C1	83013
-1991	Navistar 60" Sleepers with Link Cabmate Model IHS60	1202-1043	83025
	S2500, S2600, 8100, 8200, & 8300 Series Conventional Tractors with Link Cabmate Model NAV80	1202-1043	83025
Sept 94 -	SBA 5000 Series Paystar Conventionals with Link Cabmate Model NP50 & NP50-A built after August of 1994	1202-1044	83025
Sept 96 -	SFA 5000 Series Paystar Conventionals with Link Cabmate Model NP50 & NP50-A built after August of 1996	1202-1044	83025
2004 - 09	TranStar 8600 Series with 36" Sleepers	2509222C91	83053
	Models with O.E.M. Number	2507409C1	83052
		2507761C1	83052
		2507763C1	83052
		2507948C1	83054
		2508326C1	83021
		2508327C1	83025
		2509223C91	83054
		2509224C91	83053
		3557165C1	83053
		3557166C1	83052
		3557167C3	83053
		3557169C2	83052
		3560649C2	83052
		3560705C2	83054
		AMS66160	83052
		AMS66161	83053
		AMS66161	83053

Fleetstar - Conventional

	1900A, 2000A Series	480945C1	83014
		480945C2	83014

KENWORTH

	32" Areocabs with Link Cabmate Models KWK1T03 & KWCSA 01 06	1202-1264	83031
	60" Sleeper with Link Cab Suspension	1202-0043	83032
	62" Areocabs and 74" Sleepers with Link Cabmate Models KWK1T01 & KWCSA 01 06	1202-1164	83031
	72" Areocabs with Link Cabmate Models KWK1T02 & KWCSA 01 06	1202-1065	83002
	COE Models with Link Cab Model	KWE90112	83016
	COE Models with Link Cab Model (Does not fit Non-Sleeper cabs)	KW1102-B	83016
	COE Sleeper Cabs using the 3 point mount system with one hydraulic latch centered on the rear cab support & Link Cabmate Model KW1102-B.	1202-0032	83016
-1982	Conventional Tractors with A-Model cabs & Link Cabmate Model KWA900	1202-0012	83023
	Link Cabmate Model KWB500	1202-0044	83025
	Link Cabmate Model KWB689-B	1202-1043	83025
	Link Cabmate Model KWE90112-B	1202-1064	83024
	Mid-1986 and newer Kenworth Sleepers with round cornered doors & Link Bunkmate Model KWS60-A .	1201-1044	83025
	Models with Link Cab Suspension	1202-0022	83046
		1202-0042	83025
		R71-1004	83049
	Models with Link Cab Suspension KWE90112-A	1202-0032	83016
- 2009	T-2000 Conventional Models with Link Cabmate Model KWT2000-A	1202-1064	83024
	T-2000 with PowerPacker Cab Suspension after 6/28/98	PP2582.870	83012

FLEETLINE CAB SHOCKS

AMORTISSEURS POUR CABINE AMORTIGUADORES DE CABINA

OEM #	Gabriel #
-------	-----------

KENWORTH... cont'd

	T-2000 with PowerPacker Cab Suspension prior to 6/28/98	96027.10545	83011
-May 92	T-400A & T-450 Conventional Tractors with Link Cabmate Model KWB400-A	1202-0012	83023
Jun 92-	T-400A & T-450 Conventional Tractors with rear cab support Kenworth P/N K235-1646 & Link Cabmate Model KWB689-A	1202-0012	83023
	T-600, T-800 & W-900 Models with Link Cabmate Model KWMC642	1202-0054	83021
	T-600A, T-800A & W-900B Conventional Tractors with rear cab support Kenworth P/N K235-1436 or K235-1488 with Link Cabmate Model KWB689-A	1202-0012	83023
2006-10	T660 Series with Link Cab Suspension	1202-1065	83002
2009	T800 Series with Link Cab Suspension	1202-1046	83049

LINK MANUFACTURING

	Models with Link Cab Suspension	1201-0012	83023
		1201-0154	83051
		1201-0254	83051
		1201-1043	83025
		1201-1044	83025
		1201-1212	83013
		1201-1213	83005
		1201-9001	83052
		1201-9002	83052
		1201-9003	83052
		1201-9007	83054
		1201-9008	83054
		1201-9009	83054
		1201-9010	83053
		1201-9011	83053
		1202-0012	83023
		1202-0022	83046
		1202-0032	83016
		1202-0042	83025
		1202-0043	83032
		1202-0044	83025
		1202-0052	83021
		1202-0054	83021
		1202-1042	83025
		1202-1043	83025
		1202-1044	83025
		1202-1064	83024
		1202-1065	83002
		1202-1164	83031
		1202-1212	83013
		1202-1213	83005
		632120	83046
		632129	83023
		635705	83016
		654669	83021
		654799	83025
		654811	83024
		654833	83021
		654847	83002
		654849	83031
		654867	83025
		LG40450	83016
		LG40470	83016
		R71-1004	83049
		R71-1005	83024
		T71-1000	83031
		T71-1001	83031
		T71-1002	83002

FLEETLINE CAB SHOCKS

AMORTISSEURS POUR CABINE AMORTIGUADORES DE CABINA

OEM #	Gabriel #
-------	-----------

MACK

	CH Series	14QK-411 14QK-411M	83007 83007
2008-10	CHU-613 and CXU-613 Series w/O.E.M. Number	14QK-3103M 20874147	83050 83050
	CL Series	14QK-391AM 14QK-391AM2	83041 83041
	CT, CTX Series w/O.E.M. Numbers	14QK-3103M 20874147	83050 83050
2002-07	CV-713 Models with O.E.M number	14QK-391BM	83041
	CX (Vision) Series w/Sleeper Cabs w/O.E.M. Numbers	14QK-399M 14QK-399M2 14QK-399M3	83045 83045 83045
	MH Series with Air Cab	14QK-376	83003
	Models with Link Cab Suspension	1202-0012 1202-0022 1202-0032	83023 83046 83016
	Models with O.E.M. Numbers	14QK-2111 14QK-2111-P2 14QK-391BM2	83019 83019 83041
	R 600 Tractors with Link Cabmate Model MCR600	1202-0012	83023
	R, RD Series	14QK-382 14QK-382-P2	83018 83018
	R, RD400 & 600 Series with Cab Air suspension	14QK-2111-P4	83019
	RS & Superliner Tractors with Link Cabmate Model MCRS600	1202-0012	83023
	RW Series	14QK-29303-P2	83014

MARMON

1981-	Conventional Tractors with Link Cabmate Model MARC57-B	1202-0054	83021
	Models with Link Cab Suspension	1202-0022	83046
	Models with Link Cabmate Model OKTP with O.E.M. Number	1202-0054	83021

PETERBILT

	357, 375, 376, 377 & 378 Conventional Truck & Tractors with Link Cabmate Models PBC377 & PBC377-A	1202-0054	83021
	359 & 379 Conventional Truck & Tractors with Link Cabmate Models PBC379 & PBC379-A	1202-0054	83021
	359 Series (Older Models) Conventional Tractors with Link Cabmate Model PBCAL359	1202-0012	83023
1981-	362 Cabovers with Link Cabmate Model PB-362-2P	1202-0032	83016
	362 COE Cab Suspension	20-18744	..
	377 & 379 Conventional Models with Unibuilt Cab	29-02455	83008
	387 Day Cab	R71-6000	..
1999 -	387 Series with 70" Sleepers	29-06032	83035
1999-	387 Series with O.E.M. Number	29-06005	83035
2008 -	389 Models with 70" Sleepers	29-02455	83008
1978-	48" Sleepers with Link Bunkmate Model PBS48-A	1202-1044	83025
1978-	63" Sleepers with Link Bunkmate Model PBS63-A	1202-1044	83025
	Day Cab Suspensions with O.E.M. Number	20-16755	83042
	Models with Link Cab Suspension	1202-0022	83046

FLEETLINE CAB SHOCKS

AMORTISSEURS POUR CABINE AMORTIGUADORES DE CABINA

OEM #	Gabriel #
-------	-----------

PETERBILT... cont'd

	Models with O.E.M. Number	654782	83008
		654812	83042
		654919	83035
	Models with PowerPacker Cab Suspension	96027.1054	83011
		PP2582.870	83012

STERLING

	8500 & 9500 Series with 113" & 122" BBC Conventional Tractors with Link Cabmate Models FH1322 & FH1322-A	1202-1043	83025
	AT-9500 Series with O.E.M. Number	F6HZ-5K407-BA	83033
		F8HT-5K407-AA	83033
	L8501 & L9501 Series with 101" BBC Conventional Tractors with Link Cabmate Model FH101	1202-1043	83025
	LT-9500 Series with O.E.M. Number	F6HZ-5K407-AB	83034
	Models with O.E.M. Numbers	18-45067-000	83034

VOLVO

	Aero Series (WCA & WIA Models)	66010-0007	83004
		66010-0008	83004
		8162662	83004
	Link Cabmate Model WRC-2P	1202-0032	83016
	Mack CT, CTX Series w/O.E.M. Numbers	20874147	83050
	Models with Link Cab Suspension	1202-0022	83046
	Models with O.E.M. Numbers	635869	83004
		8168617	83030
2008-09	VHD Series - With O.E.M. Number	20704334	83048
	VN Series - Horizontal Position	20496217	83029
		8078547	83029
	VN Series - Vertical Position (w/O.E.M. Number)	20704334	83048
		20721254	83048
		8078546	83028
2006-10	VNL Series - All with 60" to 77" Mid - High Roof Sleepers (w/O.E.M. Number)	20721254	83048
2006-10	VT Series - All with 60" to 77" Mid - High Roof Sleepers (w/O.E.M. Number)	20721254	83048
	WG Conventional Tractors with 112" cabs with Link Cabmate Model WWG112-A	1202-0012	83023

WESTERN STAR

	6900 Series	725470	83010
	Constellation Day Cab Models	66010-3405	83026
	Constellation Sleeper Cab Models	66010-3406	83027
1986-	Conventional Tractors with Link Cabmate Model WSC4000	1202-0012	83023
	Heritage Constellation models	66010-3404	83022
		1202-0022	83046
	Models with Link Cab Suspension	1202-0022	83046
		1202-0032	83016
	Models with O.E.M. Numbers	617547	83022
		654846	83027
		654916	83026

SHOCKS FOR SPECIAL APPLICATIONS

AMORTIGUADORES PARA APLICACIONES ESPECIALES

AMORTISSEURS POUR USAGES PARTICULIERS

OEM #	Gabriel #
--------------	------------------

CHALLENGE

Cement Mixer	1540459	630811
	632147	632147
	632155	646177

HENDRICKSON SUSPENSION

Auxiliary Lifiable Steerable System (HL)

HLP Paralift	A-14496	646155
HLU Paralift Ultra	A-14496	646155

INGERSALL MACHINE

700060-0 Axle Assy.	665472	665472
Models with O.E.M. Number	665904	665472

LINK/HIGH-STEER

6000 Steering Stabilizer	632155	646177
9000 Steering Stabilizer	1210-0007	665937
Models with O.E.M. Number	1210-0001	646155
	1210-0005	85734
	1210-0010	646155
	1210-0012	646155

MC NEILUS TRUCK & MAN. COMPANY

Booster Axles	600.115994B	632147
Pusher Axles	600.115994B	632147
Models with O.E.M. Number	600.11599C	630811
	217330	85303
	600.11599M	632147
	600.188206	646155

NEWAY SUSPENSION SYSTEMS

Neway V-Steer II

Self - Steering Axle Shocks	632155	646177
	90045331	646155

REYCO/GRANNING

L132 Steering Stabilizer	701071-01	665937
--------------------------	-----------	--------

REX

Cement Mixer	102-31602-01	630811
--------------	--------------	--------

RIDEWELL CORP.

RLT-230	1310002	665937
RSS-232	1317570B001	646155
RSS-236/R	1310002	665937
	1310004	665937

SHOCKS FOR SPECIAL APPLICATIONS

AMORTIGUADORES PARA APLICACIONES ESPECIALES

AMORTISSEURS POUR USAGES PARTICULIERS

OEM #	Gabriel #
-------	-----------

SPRING VALLEY

SS120 Steering Stabilizer	632155	646177
SS130L Steering Stabilizer	632155	646177

SUSPENSIONS INC.

LP11 Steerable Lift Axle	200188	646155
--------------------------	--------	--------

WATSON & CHALIN MFG. INC.

Self - Steering Axle Suspension Systems

LW5L-1100 SR	11418	646155
SL-2089 Steerable Lift Axle Suspension	11418	646155
WCAL-1000 SST	11418	646155
WCAL-1100 LR	11418	646155
WCAL-1100 SR	11418	646155
WCAL-1100 SRLP	11418	646155
WCAL-1100 SSR	11418	646155
WCHL-1100 FL	11418	646155
WCHL-1100 HI-LIFT	11418	646155

Gabriel®



Shocks for Light Trucks (Alphabetical Listing)

Amortiguadores Para Camionetas (Lista alfabética)

Amortisseurs Pour Camionettes (Liste alphabétique)

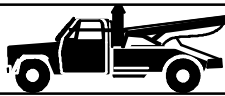

Front
Delantero
Avant

Rear
Trasero
Arrière

ACURA

MDX

01-06	All	G62003
-------	-----	-------	--------

SLX

96-99	All	G60250	G60251
-------	-----	--------	--------

ASUNA

SUNRUNNER

92-93	All	G61140
-------	-----	-------	--------

BUICK

RAINER

04-06	All	G62014
-------	-----	-------	--------

RENDEZVOUS

02-07	All Exc. Self Leveling System	G61868
-------	-------------------------------	-------	--------

CADILLAC

ESCALADE

99-00	All	G60163	G60196
-------	-----	--------	--------

CHEVROLET

3/4 TON VAN (EXPRESS & G MODELS)

70	All w/l-Beam Front Axle	G60021
----	-------------------------	-------	--------

ASTRO VAN

85-05	2 W.D.	G60076 ¹²	G60077
-------	--------	----------------------	--------

90-05	4 W.D.	G61159	G60077
-------	--------	--------	--------

AVALANCHE 1500

02-06	All Exc. Electronic Suspension)	G61144	G61866
-------	---------------------------------	--------	--------

AVALANCHE 2500

02-06	All Exc. Electronic Suspension)	G61158	G61866
-------	---------------------------------	--------	--------

BLAZER

73-74	2 W.D.	G60014	G60010
-------	--------	--------	--------

92-94	4 W.D.	G60163	G60196
-------	--------	--------	--------

71-72		G60045
-------	--	-------	--------

87-91	4 W.D. Exc. Lift Kit	G60010
-------	----------------------	-------	--------

87-91	4 W.D. Exc. Quad Suspension & Lift Kit	G60008
-------	--	--------	-------

73-74		G60010
-------	--	-------	--------

87-91	4 W.D. Quad Suspension Exc. Lift Kit Long Shock Front (2 req'd.)	G60307 ³⁰
-------	--	----------------------	-------

87-91	4 W.D. Quad Suspension Exc. Lift Kit Short Shock Front (2 req'd.)	G60309 ³⁰
-------	---	----------------------	-------

87-90	4 W.D. w/4" Lift Kit Exc. Quad Suspension)	G60064 ³¹	G60065 ³¹
-------	--	----------------------	----------------------

73-74		G60064 ³¹	G60065 ³¹
-------	--	----------------------	----------------------

69-72	All 2 W.D. w/Rear Coil Springs	G60014	G60021
-------	--------------------------------	--------	--------

C10 PICKUP

73-74	All	G60014	G60010
-------	-----	--------	--------

67-72		G60014
-------	--	--------	-------

63-66		G60014	G60021
-------	--	--------	--------

67-72	All w/Rear Leaf Springs	G60014	G60021
-------	-------------------------	--------	--------

¹² Use Kit No. 140719 to replace original equipment hardware for lower shock absorber mounting when studs break or self-tapping screws are no longer useable. / Usar el juego n° 140719 para cambiar los componentes originales del soporte inferior del amortiguador cuando se rompan los pernos o ya no se puedan usar los tornillos autorroscantes. / Utiliser le kit n° 140719 pour remplacer l'équipement original de l'amortisseur inférieur lorsque les ouvertures de goujon ou les vis auto-réglables ne peuvent plus être utilisées.

³⁰ It is recommended that when replacing front shocks on vehicles with "quad shocks" option, all four shocks should match by series. / Cuando se reemplacen los amortiguadores delanteros de los vehículos con la opción amortiguadores «Quad», se recomienda que los cuatro amortiguadores sean de la misma serie. / Lorsque les amortisseurs avant sont remplacés sur les véhicules avec amortisseurs «Quad», les quatre amortisseurs doivent être de la même série.

³¹ Bellows Kit No. 141242 is recommended for use to protect piston rod from potentially harmful road debris. / El juego de fuelles No. 141242 es recomendado para proteger al vástago del pistón contra desechos de la carretera potencialmente dañinos. / Nécessaire de soufflets no 141242 recommandé pour protéger la tige de piston des débris de la route.



Front
Delantero
Avant

Rear
Trasero
Arrière

CHEVROLET ... cont'd

C10 SUBURBAN

73-86	All	G60014	G60010
68-72		G60014

C10 TRUCK

75-86	All	G60014	G60010
-------	-----	--------	--------

C1500 SUBURBAN

92-99	All	G60098	G60196
-------	-----	--------	--------

C1500 TRUCK

88-99	All	G60098	G60097
-------	-----	--------	--------

C20 PICKUP

67-74	All	G60014
63-66		G60014	G60021
67-72	All w/Rear Leaf Springs	G60021
73-74	Standard Cab	G60010

C20 SUBURBAN

73-86	All	G60014	G60010
68-72		G60014

C20 TRUCK

75-86	Crew Cab Pickup	G60014	G60044
75-86	Standard Cab Pickup	G60014	G60010

C2500 SUBURBAN

92-99	All	G60098	G60196
-------	-----	--------	--------

C2500 TRUCK

88-00	All	G60098	G60097
-------	-----	--------	--------

C30 PICKUP

73-74	All	G60014	G60044
63-66		G60014
72	All Exc. 11,000# Rear Axle	G60014	G60021
67-71		G60014	G60021

C30 TRUCK

75-86	Crew Cab Pickup	G60014	G60044
-------	-----------------	--------	--------

C3500 TRUCK

88-02	All	G60097
88-00	All Exc. Heavy Duty Straight Front Axle	G60098
88-91	Cab & Chassis	G60014	G60044
01-02	w/ HD Solid Front Axle	G61153	G60097
91-00	w/ Solid Front Axle	G61153

COLORADO

04-07	2 W.D. Torsion Bar (Front Spring Type) Exc. Z71 Off Road Package)	G61882
04-07	All w/ Torsion Bar (Front Spring Type) Z71 Off Road Package	G61884	G61879

EQUINOX

05-07	FWD	G62015
-------	-----	-------	--------

EXPRESS 1500

03-06	All	G61896
96-02		G60076 ¹²	G60196
03-06	RWD, Coil (Front Spring Type)	G61894	G61896
04-06	Torsion Bar (Front Spring Type)	G61893

¹² Use Kit No. 140719 to replace original equipment hardware for lower shock absorber mounting when studs break or self-tapping screws are no longer useable. / Usar el juego n° 140719 para cambiar los componentes originales del soporte inferior del amortiguador cuando se rompan los pernos o ya no se puedan usar los tornillos autorroscantes. / Utiliser le kit n° 140719 pour remplacer l'équipement original de l'amortisseur inférieur lorsque les ouvertures de goujon ou les vis auto-réglables ne peuvent plus être utilisées.

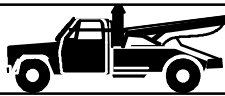

Front
Delantero
Avant

Rear
Trasero
Arrière

CHEVROLET ... cont'd
EXPRESS 2500

03-06	All	G61897
02	All Exc. 8600# GVW	G60076 ¹²
96-01		G60076 ¹²	G60196
03-06	Coil (Front Spring Type)	G61895	G61897
03-05	Torsion Bar (Front Spring Type)	G61893

EXPRESS 3500

03-06	All	G61895
97-02		G60076 ¹²	G60196
96		G60076 ¹²	G60196
96	Exc. 7100#, 7400#, 8600# & 9200# GVW Chassis Cab	G60015	G60039
03-06	Exc. Dual Rear Wheels	G61895	G61897
96	w/ 7100#, 7400#, 8600# GVW Chassis Cab	G60015	G60214
03-06	w/ Dual Rear Wheels	G61895	G61898

G10 VAN

78-95	All	G60015	G60039
71-77		G60015	G60021
67-70		G60021
70	w/ Independent Front Suspension	G60015

G20 VAN

78-95	All	G60015	G60039
71-77		G60015	G60021
67-70		G60021
70	w/ Independent Front Suspension	G60015

G30 VAN

75	110.0 & 125.0 (Wheel Base)	G60021
75	146.0 (Wheel Base)	G60015
76-77	All	G60021
71-74		G60015	G60021
93-96	Exc. 7100#, 7400#, 8600# & 9200# GVW Chassis Cab	G60039
92		G60039
79-84		G60015
85-91	Exc. 7100#, 7400#, 8600# GVW Chassis Cab	G60015	G60039
79-84		G60039
78		G60015	G60039
92-96	w/ 7100#, 7400#, 8600# GVW Chassis Cab	G60015	G60214
79-84	w/ 9200# GVW Chassis Cab	G60111

K10 PICKUP

71-72	All	G60008	G60045
69-70		G60008
73-74	Exc. Quad Suspension and Lift Kit	G60008	G60010
73-74	w/ 4" Lift Kit Exc. Quad Suspension	G60064	G60065

K10 SUBURBAN

71-72	All	G60008	G60045
69-70		G60008
84-86	Exc. Lift Kit	G60010
81-82		G60010
84-86	Exc. Quad Suspension and Lift Kit	G60008
83		G60008	G60010
81-82		G60008
73-80		G60008	G60010

¹² Use Kit No. 140719 to replace original equipment hardware for lower shock absorber mounting when studs break or self-tapping screws are no longer useable. / Usar el juego n° 140719 para cambiar los componentes originales del soporte inferior del amortiguador cuando se rompan los pernos o ya no se puedan usar los tornillos autorroscantes. / Utiliser le kit n° 140719 pour remplacer l'équipement original de l'amortisseur inférieur lorsque les ouvertures de goujon ou les vis auto-réglables ne peuvent plus être utilisées.



Front
Delantero
Avant

Rear
Trasero
Arrière

CHEVROLET ... cont'd

81-86	Quad Suspension Exc. Lift Kit Long Shock	G60307	³⁰
81-86	Quad Suspension Exc. Lift Kit Short Shock	G60309	³⁰
83	Quad Suspension Exc. Lift Kit		G60010
73-86	w/ 4" Lift Kit Exc. Quad Suspension	G60064		G60065

K10 TRUCK

81-86	All		G60010
81-86	Exc. Lift Kit		G60010
81-86	Exc. Quad Suspension and Lift Kit	G60008		G60010
75-80		G60008		G60010
81-86	Quad Suspension Exc. Lift Kit Long Shock	G60307	³⁰	G60010
81-86	Quad Suspension Exc. Lift Kit Short Shock	G60309	³⁰	G60010
86	w/ 4" Lift Kit Exc. Quad Suspension	G60064	³¹	G60065 ³⁴
75-85		G60064	³¹	G60065 ³¹

K1500 SUBURBAN

92-99	All	G60163		G60196
-------	-----	--------	--	--------

K1500 TRUCK

88-99	All	G61159		G60097
-------	-----	--------	--	--------

K20 PICKUP

71-72	All	G60008		G60045
69-70		G60008	
73-74	Exc. Quad Suspension and Lift Kit	G60008		G60010
73-74	w/ 4" Lift Kit Exc. Quad Suspension	G60064		G60065

K20 SUBURBAN

71-72	All	G60008		G60045
69-70		G60008	
81-86	Exc. Lift Kit		G60010
81-86	Exc. Quad Suspension and Lift Kit	G60008	
73-80		G60008		G60010
81-86	Quad Suspension Exc. Lift Kit Long Shock	G60307	³⁰
85-86	Quad Suspension Exc. Lift Kit Short Shock	G60309	
81-84		G60309	³⁰
75-86	w/ 4" Lift Kit Exc. Quad Suspension	G60064	³¹	G60065 ³¹

K20 TRUCK

81-85	Exc. Lift Kit		G60010
86	Exc. Quad Suspension and Lift Kit	G60008		G60010
81-85		G60008	
75-80		G60008		G60010
81-86	Quad Suspension Exc. Lift Kit Long Shock	G60307	³⁰
81-86	Quad Suspension Exc. Lift Kit Short Shock	G60309	³⁰
86	Quad Suspension Exc. Lift Kit		G60010
75-86	w/ 4" Lift Kit Exc. Quad Suspension	G60064	³¹	G60065 ³¹

K2500 SUBURBAN

92-99	All	G60163		G60196
-------	-----	--------	--	--------

K2500 TRUCK

88-00	All	G60163		G60097
-------	-----	--------	--	--------

³⁰ It is recommended that when replacing front shocks on vehicles with "quad shocks" option, all four shocks should match by series. / Cuando se reemplacen los amortiguadores delanteros de los vehiculos con la opción amortiguadores «Quad», se recomienda que los cuatro amortiguadores sean de la misma serie. / Lorsque les amortisseurs avant sont remplacés sur les véhicules avec amortisseurs «Quad», les quatre amortisseurs doivent être de la même série.

³¹ Bellows Kit No. 141242 is recommended for use to protect piston rod from potentially harmful road debris. / El juego de fuelles No. 141242 es recomendado para proteger al vástago del pistón contra desechos de la carretera potencialmente dañinos. / Nécessaire de soufflets no 141242 recommandé pour protéger la tige de piston des débris de la route.

³⁴ See Reference D for procedures to replace Electronic Adjustable Suspension with non-adjustable product. / La referencia D proporciona el procedimiento para sustituir a la suspensión electrónica ajustable por un producto no ajustable. / La référence D fournit la marche à suivre pour remplacer la suspension électronique ajustable par un produit non ajustable.

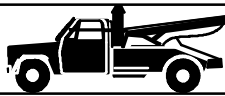

Front
Delantero
Avant

Rear
Trasero
Arrière

CHEVROLET ... cont'd

K30 TRUCK

77-86	All	G60112	G60218
-------	-----	--------	--------

K3500 TRUCK

88-00	All	G60163	G60097
-------	-----	--------	--------

K5 BLAZER

75-83	2WD	G60014	G60010
81-86	4WD Exc. Quad Suspension and Lift Kit	G60008
75-80		G60008	G60010
81-86	4WD Quad Suspension Exc. Lift Kit Long Shock	G60307 ³⁰
81-86	4WD Quad Suspension Exc. Lift Kit Short Shock Front 2 Required	G60308 ³⁰
75-86	4WD w/ 4" Lift Kit Exc. Quad Suspension	G60064 ³¹	G60065 ³¹

LUMINA (APV VAN)

90-96	All	G60312
-------	-----	-------	--------

LUV

81-82	2 W.D.	G60303	G60101
81-82	4 W.D.	G60310	G60101
75-80	All	G60310	G60308

LUV PICKUP

72-74	All	G60310	G60308
-------	-----	--------	--------

P10

75-80	All	G60014	G60044
-------	-----	--------	--------

P10 SERIES

67	All	G60014
63-66		G60014	G60021

P10 VAN

74	All	G60014	G60044
73		G60014	G60010
68-72		G60014

P20

79-89	All	G60014	G60044
75-78		G60014	G60010

P20 VAN

73-74	All	G60014	G60010
68-72		G60014	G60021

P30

84-99	All	G60044
75-90	Exc. Motorhome Chassis	G60014
75-84	Motorhome Chassis	G60113
75-83		G60044
98-99	Motorhome Chassis w/l-Beam Front Suspension	G60185	G60044
86-99		G60185
85		G60111
85-99	Motorhome Chassis w/Independent Front Suspension	G60113

³⁰ It is recommended that when replacing front shocks on vehicles with "quad shocks" option, all four shocks should match by series. / Cuando se reemplacen los amortiguadores delanteros de los vehículos con la opción amortiguadores «Quad», se recomienda que los cuatro amortiguadores sean de la misma serie. / Lorsque les amortisseurs avant sont remplacés sur les véhicules avec amortisseurs «Quad», les quatre amortisseurs doivent être de la même série.

³¹ Bellows Kit No. 141242 is recommended for use to protect piston rod from potentially harmful road debris. / El juego de fuelles No. 141242 es recomendado para proteger al vástago del pistón contra desechos de la carretera potencialmente dañinos. / Nécessaire de soufflets no 141242 recommandé pour protéger la tige de piston des débris de la route.



Front
Delantero
Avant

Rear
Trasero
Arrière

CHEVROLET ... cont'd

P30 VAN

68-71	All	G60014
72	Exc. 11,000# Rear Axle	G60014	G60021
68-71		G60014	G60021
73-74	Exc. Motorhome Chassis	G60014	G60044
74	Motorhome Chassis	G60113	G60044

R10 SUBURBAN

87-88	All	G60014	G60010
87-88	Exc. Quad Suspension and Lift Kit	G60008	G60010
87-88	Quad Suspension Exc. Lift Kit Long Shock	G60307 ³⁰	G60010
87-88	Quad Suspension Exc. Lift Kit Short Shock	G60309	G60010
87-88	w/ 4" Lift Kit Exc. Quad Suspension	G60064	G60065

R10 TRUCK

87	All	G60014	G60010
----	-----	--------	--------

R1500 SUBURBAN

89-91	All	G60014	G60010
-------	-----	--------	--------

R20 SUBURBAN

87-88	All	G60014	G60010
-------	-----	--------	--------

R20 TRUCK

87-88	All	G60014
87-88	w/Crew Cab Pick-up	G60044
87	w/Standard Cab Pick-up	G60010

R2500 SUBURBAN

89-91	All	G60014	G60010
-------	-----	--------	--------

R2500 TRUCK

89	All	G60014
89	Crew Cab Pick-up	G60044

R30 TRUCK

87-88	All	G60014	G60044
-------	-----	--------	--------

R3500 TRUCK

90-91	All	G60112	G60218
89	Cab & Chassis	G60112	G60218
89	Crew Cab Pick-up	G60112	G60218
89	Standard Cab Pick-up	G60014	G60044

S10

83-03	2WD Exc. Sport Chassis	G60049	G60050
83-93	4WD	G60051	G60050
83-04	All	G60050
94-03	Base, 4WD	G60051	G60050
83-85	Exc. Sport Chassis	G60050
82		G60049	G60050
94-04	LS, 4WD	G60051	G60050
94-98	SS	G60051	G60050
99-03	Xtreme	G60051	G60050
01-04	ZR5	G60051

³⁰ It is recommended that when replacing front shocks on vehicles with "quad shocks" option, all four shocks should match by series. / Cuando se reemplacen los amortiguadores delanteros de los vehículos con la opción amortiguadores «Quad», se recomienda que los cuatro amortiguadores sean de la misma serie. / Lorsque les amortisseurs avant sont remplacés sur les véhicules avec amortisseurs «Quad», les quatre amortisseurs doivent être de la même série.

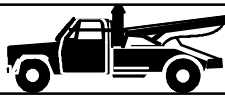

Front
Delantero
Avant

Rear
Trasero
Arrière

CHEVROLET ... cont'd
S10 BLAZER

83-94	2WD	G60049	G60050
83-94	4WD	G60051	G60050

SILVERADO 1500

99-06	2WD Exc. Adjustable Suspension	G61124	G60206
01-06	4WD Exc. Adjustable Suspension	G61144	G60218
99-00		G61144
99-00	4WD Exc.Heavy Duty Adjustable Suspension	G60218
07	Classic Hybrid, 2WD Exc. Adjustable Suspension	G61124	G60206
07	Classic Hybrid, 4WD Exc. Adjustable Suspension	G61144	G60218
07	Classic LS, 2WD Exc. Adjustable Suspension	G61124	G60206
07	Classic LS, 4WD Exc. Adjustable Suspension	G61144	G60218
07	Classic LT, 2WD Exc. Adjustable Suspension	G61124	G60206
07	Classic LT, 4WD Exc. Adjustable Suspension	G61144	G60218
07	Classic SS, 2WD Exc. Adjustable Suspension	G61124	G60206
07	Classic WT, 2WD Exc. Adjustable Suspension	G61124	G60206
07	Classic WT, 4WD Exc. Adjustable Suspension	G61144	G60218
07	LS	G61959
07	LT	G61959
07	LTZ	G61959
07	WT	G61959

SILVERADO 1500 HD

05-07	All	G61158	G60218
01-03		G61158	G60218

SILVERADO 2500

99-07	All	G61158	G60218
-------	-----	--------	--------

SILVERADO 2500 HD

01-07	All	G61158	G60218
-------	-----	--------	--------

SILVERADO 3500

01-07	All	G61158	G60218
-------	-----	--------	--------

SSR

04-06	All	G61175
-------	-----	-------	--------

SUBURBAN

63-66	All	G60014	G60021
67	w/Rear Coil Springs	G60014

SUBURBAN 1500

07	Exc. E898Z55 Auto Ride Suspension	G61866
00-06	Exc. Z55 Auto Ride Suspension	G61144	G61866

SUBURBAN 2500

07	Exc. Z55 Auto Ride Suspension	G61866
00-06		G61158	G61866

TAHOE

95-99	2WD	G60098
00	2WD Old Body Style	G60098
95-00	4WD	G60163	G60196
95-00	All Exc. 4WD	G60196
07	Exc. Z55 Auto Ride Suspension	G61866
01-06		G61144	G61866
00	New Body Style	G61144	G61866



Front
Delantero
Avant

Rear
Trasero
Arrière

CHEVROLET ... cont'd

TRACKER

98-03	All Exc. ABS)	G61140
-------	---------------	-------	--------

TRAILBLAZER

02-07	Coil (Rear Spring Type)	G61175
02-07	w/Rear Air Spring Suspension	G62014

TRUCK

55-56	All	G60031
-------	-----	--------	-------

UPLANDER

05-06	Exc. Self Leveling System	G61116
-------	---------------------------	-------	--------

V10 TRUCK

87	Exc. Lift Kit	G60010
87	Exc. Quad Suspension and Lift Kit	G60008
87	Quad Suspension Exc. Lift Kit Long Shock	G60307	³⁰
87	Quad Suspension Exc. Lift Kit Short Shock	G60309
87	w/4" Lift Kit Exc. Quad Suspension	G60064	G60065

V20 SUBURBAN

87-88	All Exc. w/4" Lift Kit Exc. Quad Suspension	G60010
87-88	Exc. Quad Suspension and Lift Kit	G60008	G60010
87-88	Quad Suspension Exc. Lift Kit Long Shock	G60307	³⁰ G60010
87-88	Quad Suspension Exc. Lift Kit Short Shock	G60309	³⁰ G60010
87-88	w/4" Lift Kit Exc. Quad Suspension	G60064	³¹ G60065 ³¹

V20 TRUCK

87	Exc. Lift Kit	G60010
87	Exc. Quad Suspension and Lift Kit	G60008
87	Quad Suspension Exc. Lift Kit Long Shock	G60307	³⁰
87	Quad Suspension Exc. Lift Kit Short Shock	G60309	³⁰
87	w/4" Lift Kit Exc. Quad Suspension	G60064	³¹ G60065 ³¹

V2500 SUBURBAN

88-91	All Exc. w/4" Lift Kit Exc. Quad Suspension	G60010
88-91	Exc. Quad Suspension and Lift Kit	G60008	G60010
88-91	Quad Suspension Exc. Lift Kit Long Shock	G60307	³⁰ G60010
88-91	Quad Suspension Exc. Lift Kit Short Shock	G60309	³⁰ G60010
88-91	w/4" Lift Kit Exc. Quad Suspension	G60064	³¹ G60065 ³¹

V30 TRUCK

87-88	All	G60112	G60218
-------	-----	--------	--------

V3500 TRUCK

89-91	All	G60112	G60218
-------	-----	--------	--------

VENTURE

97-05	All	G61116
-------	-----	-------	--------

CHRYSLER

ASPEN

08	All	G61892
07		G62016	G61892

GRAND VOYAGER

00	All	G60233
----	-----	-------	--------

³⁰ It is recommended that when replacing front shocks on vehicles with "quad shocks" option, all four shocks should match by series. / Cuando se reemplacen los amortiguadores delanteros de los vehículos con la opción amortiguadores «Quad», se recomienda que los cuatro amortiguadores sean de la misma serie. / Lorsque les amortisseurs avant sont remplacés sur les véhicules avec amortisseurs «Quad», les quatre amortisseurs doivent être de la même série.

³¹ Bellows Kit No. 141242 is recommended for use to protect piston rod from potentially harmful road debris. / El juego de fuelles No. 141242 es recomendado para proteger al vástago del pistón contra desechos de la carretera potencialmente dañinos. / Nécessaire de soufflets no 141242 recommandé pour protéger la tige de piston des débris de la route.

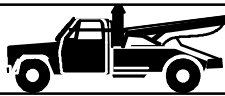

Front
Delantero
Avant

Rear
Trasero
Arrière

CHRYSLER ... cont'd
TOWN & COUNTRY

96-07	All	G60233 ⁹
90-95		G60062

VOYAGER

01-03	Exc. Nivomat Self-Leveling Option	G60233
00	Non-ABS Exc. Nivomat Self-Leveling Option	G60233 ⁹

DAIHATSU
ROCKY

90-92	All	G60165
-------	-----	--------	-------

DODGE
B100 VAN

71-80	All	G60017 ¹⁰	G60039
-------	-----	----------------------	--------

B150 VAN

81-94	109.6 (WheelBase) Exc. 7000# GVW	G60017 ¹⁰	G60039
-------	----------------------------------	----------------------	--------

B1500 VAN

95-98	109.6 (WheelBase) Exc. 7000# GVW	G60017 ¹⁰	G60039
-------	----------------------------------	----------------------	--------

B200 VAN

71-80	All	G60017 ¹⁰	G60039
-------	-----	----------------------	--------

B250 VAN

81-94	All	G60017 ¹⁰	G60039
-------	-----	----------------------	--------

B2500 VAN

95-98	All	G60017 ¹⁰	G60039
-------	-----	----------------------	--------

B300 VAN

71-80	All	G60039
80	Exc. w/ 4000# Front Axle	G60017 ¹⁰	G60039
71-79		G60017	G60039
71-80	w/ 4000# Front Axle	G60043	G60039

B350 VAN

81-94	Exc. w/ 4000# Front Axle	G60017	G60039
81-93	W/ 4000# Front Axle	G60043	G60039

B3500 VAN

95-98	Exc. w/ 4000# Front Axle	G60017 ¹⁰	G60039
-------	--------------------------	----------------------	--------

CARAVAN

84-95	All	G60062
96-07	Exc. Nivomat Self-Leveling Option	G60233

CB300

74-80	All	G60039
78-80	Exc. w/4000 Lb Front Axle	G60017 ¹⁰	G60039
78-80	w/4000 lb Front Axle	G60043	G60039
74-77	w/GVW over 8300 lb.	G60043	G60039
74-77	w/GVW up to 8300 lb.	G60017 ¹⁰	G60039

D100 PICKUP

86-89	All	G60017 ¹⁰	G60012
72-79		G60017 ¹⁰	G60012

DODGE ... cont'd
D150 PICKUP

77-93	All	G60017	G60012
-------	-----	--------	--------

⁹ If suspension spring contacts this unit, rotate suspension spring 180 degrees. / Si el resorte de suspensión entra en contacto con la unidad, rote el resorte de suspensión 180 grados. / Si le ressort de suspension entre en contact avec l'unité, faire pivoter le ressort de 180 degrees.

¹⁰ Slight grinding of control arm opening is required to install product made before August, 1988. / Un pequeño lijado de ajuste a la abertura del brazo de control es requerido para instalar productos fabricados antes de agosto 1988. / Un usinage mineur de l'ouverture de la bielle de poussée est nécessaire pour installer les pièces fabriquées avant août 1988.

			Front Delantero Avant	Rear Trasero Arrière
--	--	--	--------------------------------------	-------------------------------------

D200 PICKUP

75-80	131.0 (WheelBase) Heavy Duty Package	G60017	¹⁰
75-80	149.0 (WheelBase) Heavy Duty Package	G60017	¹⁰
77-80	165.0 (WheelBase) Heavy Duty Package	G60043	¹⁰	G60012
75-76		G60043	¹⁰
72-74		G60043	¹⁰	G60012
72-74	Exc. 165.0 (WheelBase) Heavy Duty Package	G60017	¹⁰	G60012
75-76	Exc. Heavy Duty Package		G60012

D250 PICKUP

81	131.0 (WheelBase) Exc.Heavy Duty Package	G60017	¹⁰
81	149.0 (WheelBase) Exc.Heavy Duty Package	G60017	¹⁰
81	165.0 (WheelBase) w/Heavy Duty Package	G60043	¹⁰
90-93	All		G60012
82-89		G60017	¹⁰	G60012
93	Exc. Heavy Duty Package	G60017	¹⁰
90-91		G60017	¹⁰
81			G60012
92	Exc. Heavy Duty Package w165" WheelBase	G60017	¹⁰
82-93	Heavy Duty Package	G60043	¹⁰

D300 PICKUP

72-74	165.0 (WheelBase) w/Heavy Duty Package	G60043		G60012
75-80	All	G60043	¹⁰	G60012
72-74		G60043	

D350 PICKUP

81-93	All	G60043	¹⁰	G60012
-------	-----	--------	---------------	--------

D50

79-82	2 W.D.	G60354		G60308
82	4 W.D.	G60074		G60075

DAKOTA

05-06	2WD		G61890
97-04		G60313		G60111
87-96		G60313		G60083
05-06	4WD		G61891
97-04		G60306		G60111
87-96		G61881		G60110
97-04	All		G60111

DURANGO

99-03	2WD	G60313		G60111
98-03	4WD	G60306		G60111
07-08	All		G61892
04-06		G62016		G61892

GRAND CARAVAN

88-95	All		G60062
96-07	Exc. Nivomat Self Leveling Option		G60233

M300

74	All	G60119		G60028
----	-----	--------	--	--------

¹⁰ Slight grinding of control arm opening is required to install product made before August, 1988. / Un pequeño lijado de ajuste a la abertura del brazo de control es requerido para instalar productos fabricados antes de agosto 1988. / Un usinage mineur de l'ouverture de la bielle de poussée est nécessaire pour installer les pièces fabriquées avant août 1988.

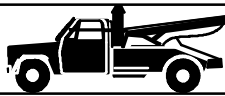

Front
Delantero
Avant

Rear
Trasero
Arrière

DODGE ... cont'd
M350

74	All	G60119
----	-----	--------	-------

MINI RAM

84-88	All	G60017	G60039
-------	-----	--------	--------

RAIDER

89	2.6L 4Cyl L (156)	G60074	G60101
89	3.0L 6Cyl V (181)	G60074
87-88	All	G60074	G60101
89	Sport Utility	G60074	G60152

RAM 1500 PICKUP

07-08	2WD	G61962
06		G61958	G61962
02-05		G61958
99-01		G60205	G60206
94		G60205	G60206
06-08	4WD	G61961
02-05		G61182
99-01		G60216	G60206
94		G60216	G60206
07	All	G62009
04-05		G60218

RAM 1500 VAN

99-03	109.3 (WheelBase) Exc. 7000# GVW	G60017 ¹⁰	G60039
-------	----------------------------------	----------------------	--------

RAM 2500 PICKUP

99-02	2WD	G60205	G60206
94-95		G60205	G60206
05-07	4WD	G62011	G62013
95	4WD, CNG Exc.8800# GVW	G60216
99-02	4WD, DIESEL	G60218
99-02	4WD, DIESEL w/8800# GVW	G60217
94-95		G60217	G60218
99-02	4WD, GAS Exc.w/8800# GVW	G60216	G60206
94-95		G60216	G60206
03-06	Crew Cab Pickup, RWD	G61971
03-06	Standard Cab Pickup, RWD	G61970

RAM 2500 VAN

99-03	All	G60017 ¹⁰	G60039
-------	-----	----------------------	--------

RAM 3500 PICKUP

99-01	2WD Exc. Solid Front Axle	G60205
94-95	2WD Exc. w/Solid Front Axle	G60205	G60206
99-02	2WD w/Solid Front Axle	G60217	G60218
94-95		G60217	G60218
99-02	4WD	G60217	G60218
94-95		G60217	G60218
03-06	Crew Cab Pickup, RWD	G61971
99-02	Exc. Solid Front Axle	G60206
03-06	Standard Cab Pickup, RWD	G61970

¹⁰ Slight grinding of control arm opening is required to install product made before August, 1988. / Un pequeño lijado de ajuste a la abertura del brazo de control es requerido para instalar productos fabricados antes de agosto 1988. / Un usinage mineur de l'ouverture de la bielle de poussée est nécessaire pour installer les pièces fabriquées avant août 1988.



DODGE ... cont'd
RAM 3500 VAN

99-03	All	G60017	¹⁰	G60039
-------	-----	--------	---------------	--------

RAM 50

87-93	2WD	G60354		G60308
87-93	4WD	G60074		G60075
83-86	All	G60354		G60308

RAMCHARGER

75-93	2WD	G60017		G60012
76-93	4WD	G60028		G60029
75		G60028		G60012
74	All	G60028		G60012

RD200

78-80	All	G60028	
-------	-----	--------	--	-------

SPRINTER 2500

03-06	Exc. Dual Rear Wheels		G61918
-------	-----------------------	-------	--	--------

SPRINTER 3500

03-06	Exc. Dual Rear Wheels		G61918
03-06	w/ Dual Rear Wheels		G61919

W100 PICKUP

72-77	All	G60028		G60029
61-71		G60028	
86-89	Exc. Lift Kit	G60028		G60029

W150 PICKUP

77-80	All	G60028		G60029
81-93	Exc. Lift Kit	G60028		G60029

W200 PICKUP

72-80	All	G60028		G60029
69-71		G60028	

W200 SERIES

61-67	All	G60028	
-------	-----	--------	--	-------

W250 PICKUP

81-93	Standard Cab Pickup Exc. Lift Kit	G60028		G60029
-------	-----------------------------------	--------	--	--------

W300 PICKUP

72-80	All	G60028		G60029
68-71		G60028		G60028

W300 SERIES

61-67	All	G60028		G60028
-------	-----	--------	--	--------

W350 PICKUP

81-93	Exc. Quad Shock & Lift Kit	G60028		G60029
-------	----------------------------	--------	--	--------

FORD

AEROSTAR

89-97	2WD	G60078		G60120
90-97	4WD	G60181		G60120
86-88	All	G60078		G60099

¹⁰ Slight grinding of control arm opening is required to install product made before August, 1988. / Un pequeño lijado de ajuste a la abertura del brazo de control es requerido para instalar productos fabricados antes de agosto 1988. / Un usinage mineur de l'ouverture de la bielle de poussée est nécessaire pour installer les pièces fabriquées avant août 1988.

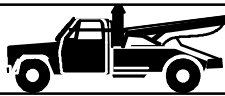

Front
Delantero
Avant

Rear
Trasero
Arrière

FORD ... cont'd
BRONCO

66-77	All From Serial #830001 Exc. Lift Kit)	G60023	G60042
80-88	All w/3-4" Lift Kit	G60068 ³¹
86	All w/3-4" Lift Kit Exc. Quad Suspension	G60071	G60068 ³¹
80-85	All w/3-4" Lift Kit Quad Suspension Forward of Front Axle	G60072
80-85	All w/3-4" Lift Kit Quad Suspension Rearward of Front Axle	G60071
66-77	All w/4-5" Lift Kit	G60071	G60068 ³¹
80-96	Exc. Lift Kit	G60035
78-79		G60042
66		G60023 ³¹
80-96	Includes Quad Suspension Rearward of Front Axle Exc. Lift Kit	G60038
78-79	Left Standard Suspension Exc. Lift Kit	G60129
78-79	Left w/3 1/2-4" Lift Kit Exc. Quad Suspension	G60073
80-96	Quad Suspension Exc. Lift Kit Forward of Front Axle	G60033
78-79	Quad Suspension Exc. Lift Kit) Long Shock	G60129
78-79	Quad Suspension Exc. Lift Kit) Rearward of Front Axle	G60026
78-79	Right Std. Suspension Exc. Lift Kit)	G60026
78-79	Right w/3 1/2-4" Lift Kit Exc. Quad Suspension)	G60071
66	Thru Serial #830000	G60011 ³¹
78-79	w/3 1/2-4" Lift Kit Exc. Quad Suspension)	G60068 ³¹

BRONCO II

90	All	G60171	G60144
89	All built from 2/89 (Vehicles w/12mm bolt in rear lower mount)	G60038	G60144
84-89	All built until 1/89 (Vehicles w/10mm bolt in rear lower mount)	G60038	G60063

E100 ECONOLINE

75-83	All	G60114	G60011
69-74		G60042
68	Early 1968	G60101	G60003
68	Late 1968	G60101	G60042

E100 ECONOLINE CLUB WAGON

75-83	All	G60114	G60011
-------	-----	--------	--------

E- 150

03-06	All	G60330	G60184
-------	-----	--------	--------

E- 150 CLUB WAGON

03-05	All	G60330	G60184
-------	-----	--------	--------

E- 150 ECONOLINE

92-02	All	G60330	G60184
75-91		G60114	G60011

E- 150 ECONOLINE CLUB WAGON

92-02	All	G60330	G60184
75-91		G60114	G60011

E200 ECONOLINE

69-74	All	G60042
68	Late 1968	G60042

E- 250

03-06	All	G60182	G60183
-------	-----	--------	--------

E- 250 ECONOLINE

92-02	All	G60182	G60183
75-91		G60023	G60024

³¹ Bellows Kit No. 141242 is recommended for use to protect piston rod from potentially harmful road debris. / El juego de fuelles No. 141242 es recomendado para proteger al vástago del pistón contra desechos de la carretera potencialmente dañinos. / Nécessaire de soufflets no 141242 recommandé pour protéger la tige de piston des débris de la route.



FORD ... cont'd
E-250 ECONOLINE CLUB WAGON

75-91	All		G60023	G60024
-------	-----	--	--------	--------

E-250 SUPER DUTY

04-05	All		G60182	G60183
-------	-----	--	--------	--------

E300 ECONOLINE

69-74	All		G60042
68	Late 1968		G60042

E-350

03	Includes Motorhome Conversion		G60182	G60183
----	-------------------------------	--	--------	--------

E-350 CLUB WAGON

03-05	Includes Motorhome Conversion		G60182	G60183
-------	-------------------------------	--	--------	--------

E-350 ECONOLINE

92-02	Includes Motorhome Conversion		G60182	G60183
75-91			G60023	G60024

E-350 ECONOLINE CLUB WAGON

92-02	Includes Motorhome Conversion		G60182	G60183
77-91			G60023	G60024

E-350 SUPER DUTY

04-06	Includes Motorhome Conversion		G60182	G60183
-------	-------------------------------	--	--------	--------

ECONOLINE

61-67	All		G60101	G60003
-------	-----	--	--------	--------

ESCAPE

01-07	All		G61862
-------	-----	--	-------	--------

EXCURSION

00-05	2WD		G60171	G60161
00-05	4WD		G61150	G61177

EXPEDITION

97-02	2WD Exc. w/Front Air Leveling		G60257	G60260
97-02	4WD Exc. w/Front Air Leveling		G60259	G60260

EXPLORER

91-94	All		G60162	G60161
95-01	All Exc. w/Adjustable Suspension)		G60221	G60222
02-03	All STD Package		G60221	G60222

EXPLORER SPORT TRAC

02-04	All		G60221	G60222
-------	-----	--	--------	--------

F SERIES

53-55	All		G60003
48-52	F-1, F-2, F-3		G60031	G60003
55	F-100		G60003	G60031
53-54	F-100 (All)		G60003

F SUPER DUTY

94-97	All		G60235	G60035
90-92			G60179	G60035
93	Mfg. after 2/93		G60235	G60035
93	Mfg. before 2/93		G60179	G60035

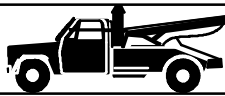

Front
Delantero
Avant

Rear
Trasero
Arrière

FORD ... cont'd

F-100

80-83 75-79	2WD	G60038 G60023	G60035 G60011
75-76	4WD Exc.Lift Kit	G60023	G60024
75-76	4WD w/3 1/2-4" Lift Kit	G60023	G60073 ³¹
75-79	All	G60023
77-79	All w/3-4" Lift Kit Exc. Quad Suspension)	G60071 ³¹	G60073 ³¹

F-100 PICKUP

73-74	2WD	G60023	G60011
73-74 70-72 66-69 61-64	All	G60023 G60023 G60023 G60042 G60031
65	Early 1965	G60002	G60031
70-74	Exc. Lift Kit	G60024
65	Late 1965	G60023	G60042
70-74	w/3 1/2-4" Lift Kit	G60073 ³¹

F-150

05-06 85-96 80-84 77-79 75-76	2WD G60038 G60038 G60023 G60023	G61870 G60007 G60035 G60011 G60011
97-98	2WD Exc. 7700# GVW	G60257	G61118
04-07 77	4WD G60026	G61867
97-03	4WD Exc. 7700# GVW	G60259	G60258
80-96 77-79	4WD Exc.Lift Kit	G60084 G60024
80-96	4WD Includes Quad Suspension Rearward of Front Axle Exc. Lift Kit	G60038
80-96	4WD Quad Suspension Exc.Lift Kit Forward of Front Axle	G60033
80-86	4WD Quad Suspension w/3-4" Lift Kit Forward of Front Axle	G60072
78-79	4WD Rearward of Front Axle	G60026
80-86	4WD w/3-4" Lift Kit	G60071	G60066
75-76	All	G60023
78	Base, 4WD Quad Suspension Exc.Lift Kit Long Shock	G60129
77-79	Cab & Chassis, 4WD w/3-4" Lift Kit Exc. Quad Suspension	G60071 ³¹	G60073 ³¹
78-79	Custom, 4WD Quad Suspension Exc.Lift Kit Long Shock	G60129
75-76	Exc. Lift Kit	G60023	G60024
78-79	Extended Cab Pickup, 4WD Exc.Lift Kit	G60046
04 01	Lariat, 2WD G60257	G61870
99-00 02-03 01	Lariat, 2WD Exc. 7700# GVW	G60257 G60257	G61118 G61118 G61118
78	Northland, 4WD Quad Suspension Exc.Lift Kit Long Shock	G60129
78-79	Ranger Lariat, 4WD Quad Suspension Exc.Lift Kit Long Shock	G60129
78-79	Ranger, 4WD Quad Suspension Exc.Lift Kit Long Shock	G60129
77-79	Standard Cab Pick-up, 4WD w/3-4" Lift Kit Exc. Quad Suspension	G60071 ³¹	G60073 ³¹
04	STX, 2WD	G61870

³¹ Bellows Kit No. 141242 is recommended for use to protect piston rod from potentially harmful road debris. / El juego de fuelles No. 141242 es recomendado para proteger al vástago del pistón contra desechos de la carretera potencialmente dañinos. / Nécessaire de soufflets no 141242 recommandé pour protéger la tige de piston des débris de la route.



FORD ... cont'd

75-76	w/3 1/2-4" Lift Kit	G60073 ³¹
04	XL, 2WD	G61870
99-03	XL, 2WD Exc. 7700# GVW	G60257	G61118
04	XLT, 2WD	G61870
99-03	XLT, 2WD Exc. 7700# GVW	G60257	G61118

F-150 HERITAGE

04	2WD Exc. 7700# GVW	G60257	G61118
04	4WD Exc. Lightning & 7700# GVW	G60259	G60258

F-250

80-96	2WD	G60038	G60007
75-79		G60023	G60042
97-98	2WD Over 8500# GVW	G60038	G60007
97-99	2WD Under 8500# GVW	G60257	G61118
97-99	4WD	G60259	G60258
87-96		G60080	G60084
83-86		G60041	G60084
82		G60084
80-81		G60033	G60084
97-98	4WD Over 8500# GVW	G60080	G60084
75-77	4WD Up through Serial No. Y20000	G60002
77-79	Cab & Chassis Pickup, 4WD All From Serial No. Y20001	G60046	G60024
75-79	Cab & Chassis, 2WD	G60011
80-82	Extended Cab Pick-up, 4WD	G60041
75-79	Standard Cab Pickup, 2WD	G60011
82	Standard Cab Pick-up, 4WD	G60033
77-79	Standard Cab Pickup, 4WD All From Serial No. Y20001	G60046	G60024

F-250 PICKUP

73-74	2WD	G60023
73-74	2WD Standard Cab	G60042
65-72	4WD	G60002	G60042
61-64		G60002	G60031
73-74	4WD Up through Serial No. Y20000	G60002
61-64	All	G60031
73-74	Extended Cab 2WD	G60011

F-250 SUPER DUTY

99-04	2WD	G60182	G61149
05-06		G60182	G62010
99-04	4WD	G61150	G61151
08		G61888
05-07		G61886	G61888

F-350

80-97	2WD	G60038
80-97	2WD Exc. Dual Rear Wheels	G60007
80-97	2WD w/ Dual Rear Wheels	G60035
93-97	4WD	G60080
92		G60080	G60081
86-91		G60080
82-85		G60041	G60084
80-81		G60033	G60084
79		G60046	G60024

³¹ Bellows Kit No. 141242 is recommended for use to protect piston rod from potentially harmful road debris. / El juego de fuelles No. 141242 es recomendado para proteger al vástago del pistón contra desechos de la carretera potencialmente dañinos. / Nécessaire de soufflets no 141242 recommandé pour protéger la tige de piston des débris de la route.

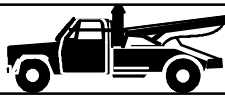

Front
Delantero
Avant

Rear
Trasero
Arrière

FORD ... cont'd

93-97	4WD Exc. Dual Rear Wheels	G60081
86-91		G60081
86-97	4WD w/ Dual Rear Wheels	G60084
75-79	Extended Cab Pick-up, 2WD	G60026	G60011
75-79	Standard Cab Pickup, 2WD	G60023	G60042

F-350 PICKUP

74	All	G60026
61-66		G60031
73-74	Exc. Super Cab 2WD	G60042

F-350 SUPER DUTY

99-04	2WD	G60182	G61149
05-06		G60182	G62010
99-04	4WD	G61150	G61151
05-06		G61886
05-06	4WD w/ Dual Rear Wheels	G61887
05-06	4WD w/ Single Rear Wheels	G61888

F-450 SUPER DUTY

05-06	2WD	G61969	G61963
05-06	4WD	G61969	G61964
99-04	All	G61150	G61152
97		G60235	G60035

F-550 SUPER DUTY

05-06	2WD	G61969	G61963
05-06	4WD	G61969	G61964
99-04	All	G61150	G61152

FREESTAR

04-06	All	G61873
-------	-----	-------	--------

P-350

68-75	GVW up through 8000#	G60031
-------	----------------------	--------	-------

P-400

75-76	GVW up through 8000#	G60031
-------	----------------------	--------	-------

RANGER

90-97	2WD	G60171	G60144
83-88		G60063
06		G61113
05		G61112	G61113
89	2WD Mfg. 2/89 Vehicles w/12mm bolt in rear lower mount	G60144
89	2WD Mfg. through 1/89 Vehicles w/10mm bolt in rear lower mount	G60063
90-97	4WD	G60171	G60143
83-88		G60048
89	4WD Exc. High Ryder Option	G60048
89	4WD w/ High Ryder Option	G60158	G60143
87-88		G60158
83-86	All	G60038
01-05	Edge	G60221	G61115
87-89	Exc. High Ryder Option	G60038
98	Splash, 2WD	G61112	G61113
04	Tremor, 2WD	G61112	G61113
98-04	XL, 2WD	G61112	G61113
98-04	XLT, 2WD	G61112	G61113



FORD ... cont'd
WINDSTAR

95-03	Coil (Rear Spring Type)	G60219
-------	-------------------------	-------	--------

GEO
TRACKER

89-97	All	G61140
-------	-----	-------	--------

GMC
1000 SERIES

63-65	All	G60014	G60021
-------	-----	--------	--------

1500 SERIES

63-65	All	G60014	G60021
-------	-----	--------	--------

C15 SUBURBAN

75-78	All	G60014	G60010
-------	-----	--------	--------

C15 TRUCK

75-78	All	G60014	G60010
-------	-----	--------	--------

C15/C1500 PICKUP

73-74	All	G60014	G60010
-------	-----	--------	--------

67-72	w/ Rear Coil Springs	G60014
-------	----------------------	--------	-------

67-72	w/ Rear Leaf Springs	G60014	G60021
-------	----------------------	--------	--------

C15/C1500 SUBURBAN

73-74	All	G60014	G60010
-------	-----	--------	--------

68-72	w/ Rear Coil Springs	G60014
-------	----------------------	--------	-------

C1500 SUBURBAN

92-99	All	G60098	G60196
79-86		G60014	G60010

C1500 TRUCK

88-99	All	G60098	G60097
79-86		G60014	G60010

C25 SUBURBAN

75-78	All	G60014	G60010
-------	-----	--------	--------

C25 TRUCK

75-78	Cab & Chassis	G60014	G60010
-------	---------------	--------	--------

75-78	Crew Cab Pickup	G60014	G60044
-------	-----------------	--------	--------

75-78	Standard Cab Pickup	G60014	G60010
-------	---------------------	--------	--------

C25/C2500 SUBURBAN

73-74	All	G60014	G60010
68-72		G60014

C25/C2500 PICKUP

73-74	All	G60014	G60044
66		G60014	G60021

73-74	Exc. Crew & Bonus Cab	G60010
-------	-----------------------	-------	--------

67-72	w/ Rear Coil Springs	G60014
-------	----------------------	--------	-------

67-72	w/ Rear Leaf Springs	G60014	G60021
-------	----------------------	--------	--------

C2500 SUBURBAN

92-99	All	G60098	G60196
79-86		G60014	G60010

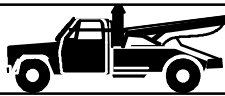

Front
Delantero
Avant

Rear
Trasero
Arrière

GMC ... cont'd
C2500 TRUCK

88-00	All	G60098	G60097
79-86	Cab & Chassis	G60014	G60010
85-86	Crew Cab Pickup	G60014	G60044
79-83		G60014	G60044
85-86	Standard Cab Pickup	G60014	G60010
84		G60010
79-83		G60014	G60010

C35 TRUCK

75-78	All	G60014	G60044
-------	-----	--------	--------

C35/C3500 PICKUP

73-74	All	G60014	G60044
67-72		G60014
67-72	Exc. 11,000# Rear Axle	G60014	G60021

C3500 TRUCK

79-85	All	G60014	G60044
92-96	Coil (Front Spring Type), Leaf (Rear Spring Type) Exc. Heavy Duty Straight Front Axle	G60098	G60097
97-00	Exc. Heavy Duty Straight Front Axle	G60098	G60097
88-91		G60098	G60097
98-00	Heavy Duty Solid Front Axle	G61153	.
97		G61153	G60097
91		G61153	.
01-02		G61153	G60097
92-96	Leaf (Front Spring Type), Leaf (Rear Spring Type) Heavy Duty Solid Front Axle	G61153	G60097
97-00	Solid Front Axle	G60097
91		G60097

CANYON

04-06	2WD Exc. Z71 Off Road Package	G61884	G61882
04-06	All	G61884	G61879

ENVOY

02	2WD	G60049
02	4WD	G60051
02-05	Coil (Rear Spring Type)	G61175
02-06	w/Rear Air Spring Suspension	G62014

G15 VAN

78	All	G60015	G60039
75-77		G60015	G60021

G15/G1500 VAN

71-74	All	G60015	G60021
67-70		G60021
70	w/Independent Front Suspension	G60015	G60021

G1500 VAN

79-95	All	G60015	G60039
-------	-----	--------	--------

G25 VAN

75-77	All	G60015	G60021
78	Exc. 8600# GVW	G60015	G60039

G25/G2500 VAN

71-74	All	G60015	G60021
67-70		G60021
70	w/Independent Front Suspension	G60015	G60021



Front
Delantero
Avant

Rear
Trasero
Arrière

GMC ... cont'd
G2500 VAN

79-95	Exc. 8600# GVW	G60015	G60039
-------	----------------	--------	--------

G35 VAN

75	110.0 (WheelBase)	G60021
75	125.0 (WheelBase)	G60021
75	146.0 (WheelBase)	G60015
76-77	All	G60021
78	Exc. 7100# 7400#, 8600# GVW Chassis Cab	G60015
78	Exc. 7100#, 7400#, 8600# & 9200# GVW Chassis Cab	G60039

G35/G3500 VAN

71-74	All	G60015	G60021
-------	-----	--------	--------

G3500 VAN

96	All	G60015	G60196
92-95		G60015
79-91	Exc. 7100# 7400#, 8600# GVW Chassis Cab	G60015
79-96	Exc. 7100#, 7400#, 8600# & 9200# GVW Chassis Cab	G60039
92-96	w/ 7100# 7400#, 8600# GVW Chassis Cab	G60214
79-96	w/9200# GVW	G60111

JIMMY

92-01	2WD	G60049	G60050
70-82		G60014
92-01	4WD	G60051	G60050
83-84	4WD Exc. Lift Kit	G60008	G60010
75-82		G60008
81-84	4WD Long Shock	G60307	³⁰
81-84	4WD Short Shock	G60309	³⁰
75-84	4WD w/ Lift Kit	G60064	³¹ G60065 ³¹
71-72	All	G60045
73-74	All Exc. w/4" Lift Kit Exc. Quad Suspension	G60010
85-91	Exc. Lift Kit	G60010
75-82		G60010
85-91	Exc. Quad Suspension and Lift Kit	G60008
85-91	Quad Suspension Exc. Lift Kit Long Shock	G60307	³⁰
87-91	Quad Suspension Exc. Lift Kit Short Shock	G60309	³⁰
85-86		G60309	³⁰
99	Sport Utility, 4WD	G60051	G60050
70-72	w/ Rear Leaf Springs	G60021
85-90	w/4" Lift Kit Exc. Quad Suspension	G60064	³¹ G60065 ³¹
73-74		G60008	³¹ G60065 ³¹

K15 SUBURBAN

75-78	Exc. Quad Suspension and Lift Kit	G60008	G60010
75-78	w/4" Lift Kit Exc. Quad Suspension	G60064	³¹ G60065

K15 TRUCK

75-78	Exc. Quad Suspension and Lift Kit	G60008	G60010
75-78	w/4" Lift Kit Exc. Quad Suspension	G60064	G60065

³⁰ It is recommended that when replacing front shocks on vehicles with "quad shocks" option, all four shocks should match by series. / Cuando se reemplacen los amortiguadores delanteros de los vehículos con la opción amortiguadores «Quad», se recomienda que los cuatro amortiguadores sean de la misma serie. / Lorsque les amortisseurs avant sont remplacés sur les véhicules avec amortisseurs «Quad», les quatre amortisseurs doivent être de la même série.

³¹ Bellows Kit No. 141242 is recommended for use to protect piston rod from potentially harmful road debris. / El juego de fuelles No. 141242 es recomendado para proteger al vástago del pistón contra desechos de la carretera potencialmente dañinos. / Nécessaire de soufflets no 141242 recommandé pour protéger le tige de piston des débris de la route.

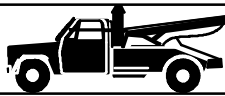

Front
Delantero
Avant

Rear
Trasero
Arrière

GMC ... cont'd
K15/K1500 PICKUP

71-72 69-70	All	G60008 G60008	G60045
73-74	Exc. Quad Suspension and Lift Kit	G60008	G60010
73-74	w/4" Lift Kit Exc. Quad Suspension	G60064	G60065

K15/K1500 SUBURBAN

71-72 69-70	All	G60008 G60008	G60045
73-74	Exc. Quad Suspension and Lift Kit	G60008 ³¹	G60010
73-74	w/4" Lift Kit Exc. Quad Suspension	G60064 ³¹	G60065

K1500 SUBURBAN

92-99	All	G60163	G60196
81-86	Exc. Lift Kit	G60010
81-86 79-80	Exc. Quad Suspension and Lift Kit	G60064 G60008 G60010
81-86	Quad Suspension Exc. Lift Kit Long Shock	G60307 ³⁰
81-86	Quad Suspension Exc. Lift Kit Short Shock	G60309
79-86	w/4" Lift Kit Exc. Quad Suspension	G60064 ³¹	G60065 ³¹

K1500 TRUCK

88-99	All	G61159	G60097
86 81-84	Exc. Lift Kit	G60010 G60010
86 85 81-84 79-80	Exc. Quad Suspension and Lift Kit	G60008 G60008 G60008 G60008 G60010 G60010
81-86	Quad Suspension Exc. Lift Kit Long Shock	G60307 ³⁰
81-86	Quad Suspension Exc. Lift Kit Short Shock	G60309 ³⁰
79-86	w/4" Lift Kit Exc. Quad Suspension	G60064 ³¹	G60065 ³¹

K25 SUBURBAN

75-78	Exc. Quad Suspension and Lift Kit	G60008	G60010
75-78	w/4" Lift Kit Exc. Quad Suspension	G60064 ³¹	G60065 ³¹

K25 TRUCK

75-78	Exc. Quad Suspension and Lift Kit	G60008	G60010
75-78	w/4" Lift Kit Exc. Quad Suspension	G60064 ³¹	G60065 ³¹

K25/K2500 PICKUP

71-72 69-70	All	G60008 G60008	G60045
73-74	Exc. Quad Suspension and Lift Kit	G60008	G60010
73-74	w/4" Lift Kit Exc. Quad Suspension	G60064	G60065 ³¹

K25/K2500 SUBURBAN

71-72 69-70	All	G60008 G60008	G60045
73-74	Exc. Quad Suspension and Lift Kit	G60008	G60010
73-74	w/4" Lift Kit Exc. Quad Suspension	G60064 ³¹	G60065 ³¹

³¹ Bellows Kit No. 141242 is recommended for use to protect piston rod from potentially harmful road debris. / El juego de fuelles No. 141242 es recomendado para proteger al vástago del pistón contra desechos de la carretera potencialmente dañinos. / Nécessaire de soufflets no 141242 recommandé pour protéger la tige de piston des débris de la route.

³⁰ It is recommended that when replacing front shocks on vehicles with "quad shocks" option, all four shocks should match by series. / Cuando se reemplacen los amortiguadores delanteros de los vehículos con la opción amortiguadores «Quad», se recomienda que los cuatro amortiguadores sean de la misma serie. / Lorsque les amortisseurs avant sont remplacés sur les véhicules avec amortisseurs «Quad», les quatre amortisseurs doivent être de la même série.

			Front Delantero Avant	Rear Trasero Arrière
--	--	--	--------------------------------------	-------------------------------------

GMC ... cont'd
K2500 SUBURBAN

92-99	All	G60163	G60196
81-86	Exc. Lift Kit	G60010
81-86	Exc. Quad Suspension and Lift Kit	G60008
79-80		G60008	G60010
81-86	Quad Suspension Exc. Lift Kit Long Shock	G60307 ³⁰
81-86	Quad Suspension Exc. Lift Kit Short Shock	G60309 ³⁰
79-86	w/4" Lift Kit Exc. Quad Suspension	G60064 ³¹	G60065 ³¹

K2500 TRUCK

88-00	All	G60163	G60097
81-86	Exc. Lift Kit	G60010
81-86	Exc. Quad Suspension and Lift Kit	G60008
79-80		G60008	G60010
81-86	Quad Suspension Exc. Lift Kit Long Shock	G60307 ³⁰
81-86	Quad Suspension Exc. Lift Kit Short Shock	G60309 ³⁰
79-86	w/4" Lift Kit Exc. Quad Suspension	G60064 ³¹	G60065 ³¹

K35 TRUCK

77-78	All	G60112	G60218
-------	-----	--------	--------

K3500 TRUCK

88-00	All	G60163	G60097
79-86		G60112	G60218

P15

75-78	All	G60014	G60044
-------	-----	--------	--------

P15/P1500 VAN

74	All	G60014	G60044
73		G60014	G60010
68-72		G60014
67		G60014	G60021

P1500

79-80	All	G60014	G60044
-------	-----	--------	--------

P25

75-78	All	G60014	G60010
-------	-----	--------	--------

P25/P2500 VAN

73-74	All	G60014	G60010
68-72		G60014	G60021

P2500

79-89	All	G60014	G60044
-------	-----	--------	--------

P35

75-78	Exc. Motorhome Chassis	G60014	G60044
75-78	Motorhome Chassis	G60113	G60044

P35/P3500 VAN

73	All	G60044
68-72		G60014
68-72	Exc. 11,000# Rear Axle	G60014	G60021
73-74	Exc. Motorhome Chassis	G60014	G60044
74	Motorhome Chassis	G60113	G60044

³⁰ It is recommended that when replacing front shocks on vehicles with "quad shocks" option, all four shocks should match by series. / Cuando se reemplacen los amortiguadores delanteros de los vehículos con la opción amortiguadores «Quad», se recomienda que los cuatro amortiguadores sean de la misma serie. / Lorsque les amortisseurs avant sont remplacés sur les véhicules avec amortisseurs «Quad», les quatre amortisseurs doivent être de la même série.

³¹ Bellows Kit No. 141242 is recommended for use to protect piston rod from potentially harmful road debris. / El juego de fuelles No. 141242 es recomendado para proteger al vástago del pistón contra desechos de la carretera potencialmente dañinos. / Nécessaire de soufflets no 141242 recommandé pour protéger la tige de piston des débris de la route.

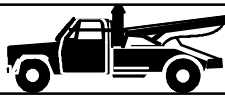

Front
Delantero
Avant

Rear
Trasero
Arrière

GMC ... cont'd
P3500

83-99	All	G60044
79-81		G60044
83-90	Exc. Motorhome Chassis	G60014
79-82		G60014	G60044
79-84	Motorhome Chassis	G60113
86-99	Motorhome Chassis w/l-Beam Front Suspension	G60185
85		G60111
85-99	Motorhome Chassis w/Independent Front Suspension	G60113
PB1000 SERIES			
63-65	All	G60014	G60021
R1500 SUBURBAN			
87-91	All	G60014	G60010
R1500 TRUCK			
87	All	G60014	G60010
R2500 SUBURBAN			
87-91	All	G60014	G60010
R2500 TRUCK			
87	All	G60014
87	Cab & Chassis	G60014	G60010
87-89	Crew Cab Pickup	G60044
88-89	Exc. Crew Cab & Bonus Cab	G60014	G60010
87	Standard Cab Pickup	G60014	G60010
R3500 TRUCK			
87-91	All	G60014	G60044
S15			
82-90	2WD	G60049	G60050
83-90	4WD	G60051	G60050
S15 JIMMY			
83-91	2WD	G60049
83-91	4WD	G60051
83-91	All	G60050
SAFARI			
85-89	All	G60076 ¹²	G60077
90-05	All 2 W.D.	G60076 ¹²	G60077
90-05	All 4 W.D.	G61159	G60077
SAVANA 1500			
96-02	All	G60076 ¹²	G60196
03-06		G61896
03-06	RWD, Coil (Front Spring Type)	G61894	G61896
04-06	Torsion Bar (Front Spring Type)	G61893
SAVANA 2500			
03-06	All	G61897
03-06	Coil (Front Spring Type)	G61895	G61897
96-02	Exc. 8600# GVW	G60076 ¹²	G60196
03	Torsion Bar (Front Spring Type)	G61893

¹² Use Kit No. 140719 to replace original equipment hardware for lower shock absorber mounting when studs break or self-tapping screws are no longer useable. / Usar el juego n° 140719 para cambiar los componentes originales del soporte inferior del amortiguador cuando se rompan los pernos o ya no se puedan usar los tornillos autorroscantes. / Utiliser le kit n° 140719 pour remplacer l'équipement original de l'amortisseur inférieur lorsque les ouvertures de goujon ou les vis auto-réglables ne peuvent plus être utilisées.



Front
Delantero
Avant

Rear
Trasero
Arrière

GMC ... cont'd
SAVANA 3500

96-02 03-06	All	G60076 ¹² G61895	G60196
96	Exc. 7100#, 7400#, 8600# & 9200# GVW Chassis Cab	G60076 ¹²	G60039
04-06	Exc. Dual Rear Wheels	G61897
96	w/ 9200# GVW	G60076 ¹²	G60111
03-06	w/ Dual Rear Wheels	G61895	G61898
96	w/7100#, 7400#, 8600# GVW Chassis Cab	G60076 ¹²	G60196
03	w/Single Rear Wheels	G61897

SIERRA 1500

99-07	2WD Exc. Adjustable Suspension	G61124	G60206
99-05 06-07	4WD Exc. Adjustable Suspension	G61144 G61144	G60218
06-07	All	G60218
07	SLE	G61959
07	SLT	G61959
07	WT	G61959

SIERRA 1500 HD

05-07 01-03	All	G61158 G61158	G60218 G60218
----------------	-----	------------------	------------------

SIERRA 2500

99-04	All	G61158	G60218
-------	-----	--------	--------

SIERRA 2500 HD

07 05 01-04	All G61158 G61158	G60218 G60218
-------------------	-----	---------------------------	---------------------------

SIERRA 3500

01-07	All	G61158	G60218
-------	-----	--------	--------

SONOMA

91-04	2WD	G60049	G60050
91-04	4WD	G60051
91-04	All	G60050

V1500 SUBURBAN

87-91	Exc. Lift Kit	G60010
87-91	Exc. Quad Suspension and Lift Kit	G60008
87-91	Quad Suspension Exc. Lift Kit Long Shock	G60307 ³⁰
87-91	Quad Suspension Exc. Lift Kit Short Shock	G60309 ³⁰
87-91	w/4" Lift Kit Exc. Quad Suspension	G60064 ³¹	G60065 ³¹

V1500 TRUCK

87	Exc. Lift Kit	G60010
87	Exc. Quad Suspension and Lift Kit	G60008
87	Quad Suspension Exc. Lift Kit Long Shock	G60307 ³⁰
87	Quad Suspension Exc. Lift Kit Short Shock	G60309 ³⁰
87	w/4" Lift Kit Exc. Quad Suspension	G60064 ³¹	G60065 ³¹

¹² Use Kit No. 140719 to replace original equipment hardware for lower shock absorber mounting when studs break or self-tapping screws are no longer useable. / Usar el juego n° 140719 para cambiar los componentes originales del soporte inferior del amortiguador cuando se rompan los pernos o ya no se puedan usar los tornillos autorroscantes. / Utiliser le kit n° 140719 pour remplacer l'équipement original de l'amortisseur inférieur lorsque les ouvertures de goujon ou les vis auto-réglables ne peuvent plus être utilisées.

³⁰ It is recommended that when replacing front shocks on vehicles with "quad shocks" option, all four shocks should match by series. / Cuando se reemplacen los amortiguadores delanteros de los vehículos con la opción amortiguadores «Quad», se recomienda que los cuatro amortiguadores sean de la misma serie. / Lorsque les amortisseurs avant sont remplacés sur les véhicules avec amortisseurs «Quad», les quatre amortisseurs doivent être de la même série.

³¹ Bellows Kit No. 141242 is recommended for use to protect piston rod from potentially harmful road debris. / El juego de fuelles No. 141242 es recomendado para proteger al vástago del pistón contra desechos de la carretera potencialmente dañinos. / Nécessaire de soufflets no 141242 recommandé pour protéger la tige de piston des débris de la route.

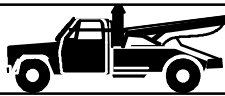

Front
Delantero
Avant

Rear
Trasero
Arrière

GMC ... cont'd
V2500 SUBURBAN

87-91	Exc. Lift Kit	G60010
87-91	Exc. Quad Suspension and Lift Kit	G60008
87-91	Quad Suspension Exc. Lift Kit Long Shock	G60307 ³⁰
87-91	Quad Suspension Exc. Lift Kit Short Shock	G60309 ³⁰
87-91	w/4" Lift Kit Exc. Quad Suspension	G60064 ³¹	G60065 ³¹
87	w/4" Lift Kit Shocks Mounted Behind Front Axle	G60064 ³¹	G60065 ³¹

V2500 TRUCK

87	Exc. Lift Kit	G60010
87	Exc. Quad Suspension and Lift Kit	G60008
87	Quad Suspension Exc. Lift Kit Long Shock	G60307 ³⁰
87	Quad Suspension Exc. Lift Kit Short Shock	G60309 ³⁰
87	w/4" Lift Kit Exc. Quad Suspension	G60064 ³¹	G60065 ³¹

V3500 TRUCK

87-91	All	G60112	G60218
-------	-----	--------	--------

YUKON

92-99	2WD	G60098	G60196
92-99	4WD	G60163	G60196
00-06	Exc. Z55 Auto Ride Suspension	G61144	G61866

YUKON XL 1500

00-06	Exc. Z55 Auto Ride Suspension	G61144	G61866
-------	-------------------------------	--------	--------

YUKON XL 2500

00-06	Exc. Nivomat Suspension	G61158	G61866
-------	-------------------------	--------	--------

YUKON DENALI

99	4WD	G60163	G60196
00-06	Exc. Z55 Auto Ride Suspension	G61144	G61866

YUKON DENALI XL

01-06	Exc. Z55 Auto Ride Suspension	G61144	G61866
-------	-------------------------------	--------	--------

HONDA

ODYSSEY

99-04	All	G61877
-------	-----	-------	--------

PASSPORT

98-02	All	G60165	G60253
94-97		G60165	G60164

PILOT

03-06	All	G62003
-------	-----	-------	--------

HUMMER

H2

03-06	All	G61158	G62000
-------	-----	--------	--------

H3

06-08	All	G62001	G61965
-------	-----	--------	--------

INFINITI

QX4

99-03	All	G61180
97-98	Mfg. through 11/98	G60255

³⁰ It is recommended that when replacing front shocks on vehicles with "quad shocks" option, all four shocks should match by series. / Cuando se reemplacen los amortiguadores delanteros de los vehículos con la opción amortiguadores «Quad», se recomienda que los cuatro amortiguadores sean de la misma serie. / Lorsque les amortisseurs avant sont remplacés sur les véhicules avec amortisseurs «Quad», les quatre amortisseurs doivent être de la même série.

³¹ Bellows Kit No. 141242 is recommended for use to protect piston rod from potentially harmful road debris. / El juego de fuelles No. 141242 es recomendado para proteger al vástago del pistón contra desechos de la carretera potencialmente dañinos. / Nécessaire de soufflets no 141242 recommandé pour protéger la tige de piston des débris de la route.



INTERNATIONAL

1000B

68	All		G60031
----	-----	--	-------	--------

1000C

68	All		G60031
----	-----	--	-------	--------

1100B

68	All		G60031
----	-----	--	-------	--------

68	Exc. Travelette w/166" Wheelbase		G60031	G60031
----	----------------------------------	--	--------	--------

1100C

68	All		G60031
----	-----	--	-------	--------

68	Exc. Travelette w/166" Wheelbase		G60031	G60031
----	----------------------------------	--	--------	--------

1200B

68	Exc. Travelette w/166" Wheelbase		G60031	G60031
----	----------------------------------	--	--------	--------

68	w/166" Wheelbase		G60031
----	------------------	--	--------	-------

1200C

68	Exc. Travelette w/166" Wheelbase		G60031	G60031
----	----------------------------------	--	--------	--------

68	w/166" Wheelbase		G60031
----	------------------	--	--------	-------

1300B

68	All		G60031	G60031
----	-----	--	--------	--------

1300C

68	Exc. Travelette w/166" Wheelbase		G60031	G60031
----	----------------------------------	--	--------	--------

908B

68	All		G60031
----	-----	--	-------	--------

908C

68	All		G60031
----	-----	--	-------	--------

M SERIES VAN

65-67	All		G60031
-------	-----	--	-------	--------

M1100

68-72	All		G60031
-------	-----	--	-------	--------

M1200

68-72	All		G60031
-------	-----	--	-------	--------

M1400

69	All		G60031
----	-----	--	-------	--------

SCOUT II

71-80	All		G60011
-------	-----	--	--------	-------

ISUZU

AMIGO

98-00	All		G60165	G60253
-------	-----	--	--------	--------

84-94			G60310	G60329
-------	--	--	--------	--------

ASCENDER

03-06	Coil (Rear Spring Type)		G61175
-------	-------------------------	--	-------	--------

03-06	w/Rear Air Spring Suspension		G62014
-------	------------------------------	--	-------	--------

HOMBRE

98-00	2WD Exc. Sport Chassis		G60049	G60050
-------	------------------------	--	--------	--------

96-97			G60050
-------	--	--	-------	--------

98-00	4WD		G60051	G60050
-------	-----	--	--------	--------

96-97	All		G60051	G60050
-------	-----	--	--------	--------

96-97	Exc. Sport Chassis		G60049	G60050
-------	--------------------	--	--------	--------

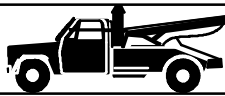

Front
Delantero
Avant

Rear
Trasero
Arrière

HOMBRE ... cont'd
I-280

06	2WD Exc. Z71 Off Road Package	G61882
----	-------------------------------	-------	--------

I-350

06	4WD	G61884	G61879
06	All	G61879

PICKUP

81-95	2WD	G60303	G60101
81-95	4WD	G60310	G60329

RODEO

98-04	All	G60165	G60253
91-97		G60165	G60164

RODEO SPORT

01-03	All	G60165	G60253
-------	-----	--------	--------

TROOPER

92-99	4WD	G60250	G60251
87-91		G60104
84-86		G60310	G60329
00-02	All	G60250	G60251

VEHICROSS

99-01	All	G60250	G60251
-------	-----	--------	--------

JEEP
CHEROKEE

84-01	All	G60052	G60053
76-83		G60042	G60042
74-75		G60042

CJ5

66-71	All	G60031
82-83	Exc. Lift Kit	G60042	G60031
72-81		G60003	G60031
82-83	w/2" Lift Kit	G60068	G60069 ³¹
66-81	w/2-4" Lift Kit	G60069 ³¹	G60067 ³¹
82-83	w/3-4" Lift Kit	G60068	G60067 ³¹

CJ6

66-71	All	G60031
72-75	Exc. Lift Kit	G60003	G60031
66-75	w/2-4" Lift Kit	G60069 ³¹	G60067 ³¹

CJ7

82-86	Exc. Lift Kit	G60042	G60031
76-81		G60003	G60031
82-86	w/2" Lift Kit	G60068 ³¹	G60069 ³¹
76-81	w/2-4" Lift Kit	G60069 ³¹	G60067 ³¹
82-86	w/3-4" Lift Kit	G60068	G60067 ³¹

COMANCHE

86-92	All	G60052	G60101
-------	-----	--------	--------

COMMANDER

06-08	All	G62012
-------	-----	-------	--------

³¹ Bellows Kit No. 141242 is recommended for use to protect piston rod from potentially harmful road debris. / El juego de fuelles No. 141242 es recomendado para proteger al vástago del pistón contra desechos de la carretera potencialmente dañinos. / Nécessaire de soufflets no 141242 recommandé pour protéger la tige de piston des débris de la route.



JEEP ... cont'd
DJ5

66-74	Exc. Lift Kit	G60003	G60031
66-74	w/2-4" Lift Kit	G60069 ³¹	G60067 ³¹

DJ6

66-68	All	G60031
66-68	w/2-4" Lift Kit	G60069 ³¹	G60067 ³¹

FC150

57-60	All	G60031
-------	-----	-------	--------

FC170

63-65	All	G60031	G60031
-------	-----	--------	--------

GLADIATOR

64-66	All	G60031
63	w/Independent Front Suspension	G60031

GRAND CHEROKEE

99-04	All	G61204	G61170
95-98		G60052	G60226
93-94		G60052	G60186
05-08		G62012

GRAND WAGONEER

84-91	All	G60042	G60042
-------	-----	--------	--------

J10

74-88	All	G60042	G60042
-------	-----	--------	--------

J20

74-88	All	G60042	G60042
-------	-----	--------	--------

JEEPSTER

70-73	All	G60031
-------	-----	-------	--------

LIBERTY

02-07	All	G61178
-------	-----	-------	--------

SCRAMBLER

82-85	All	G60042	G60031
81		G60003	G60031

UNIVERSAL

61-67	All	G60031
65-67	w/2-4" Lift Kit	G60069 ³¹	G60067 ³¹

WAGONEER

84-90	All	G60052	G60053
76-83		G60042	G60042
75		G60042
74		G60042	G60003
71-73		G60101	G60003
66-67		G60101	G60003
63-65		G60003
63-65	Exc. Independent Front Suspension	G60101	G60003
63-65	w/Independent Front Suspension	G60003

WRANGLER

07	All	G62008
07	Exc. 17" Wheels	G62008	G61966
97-05	TJ (Mfr Body Code)	G60264	G60265
07	w/ 17" Wheels	G62008	G61967
87-95	YJ (Mfr Body Code)	G60129	G60099

³¹ Bellows Kit No. 141242 is recommended for use to protect piston rod from potentially harmful road debris. / El juego de fuelles No. 141242 es recomendado para proteger al vástago del pistón contra desechos de la carretera potencialmente dañinos. / Nécessaire de soufflets no 141242 recommandé pour protéger la tige de piston des débris de la route.

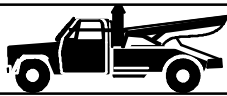

Front
Delantero
Avant

Rear
Trasero
Arrière

**KIA
SPORTAGE**

95-02	All	G60263
-------	-----	-------	--------

**LAND ROVER
DISCOVERY**

94-00	All	G60124	G60237
-------	-----	--------	--------

RANGE ROVER

94-95	Air (FrontSpringType), Air (RearSpringType)	G60176
94-95	Air (RearSpringType)	G60237
94	All	G60124
94	Coil (Rear Spring Type)	G60124	G60088
95	County Classic Exc. Air Suspension	G60124	G60088

LEXUS

LX450

96-97	All	G60176	G60177
-------	-----	--------	--------

LX470

98-04	Torsion Bar (Front Spring Type)	G61173	G61169
-------	---------------------------------	--------	--------

LINCOLN

MARK LT

06	All	G61867
----	-----	-------	--------

NAVIGATOR

98-02	2WD	G60257	G60260
98-02	4WD, Air (RearSpringType)	G62002

MAZDA

B2000

86-87	2WD	G60104	G60308
-------	-----	--------	--------

B2200

87-93	2WD	G60104	G60308
-------	-----	--------	--------

B2300

94-97	2WD	G60171	G60144
01-06		G61112	G61113
95-96	4WD	G60171	G60143

B2500

98-01	2WD	G61112	G61113
-------	-----	--------	--------

B2600

90-93	2WD	G60104	G60308
87-88		G60104	G60308
87-93	4WD	G60194	G60197

B3000

98-06	2WD	G61112	G61113
98-06	4WD	G60221	G61115

B4000

98-06	2WD	G61112	G61113
98-06	4WD	G60221	G61115

MPV

89-98	2WD	G60160
89-98	4WD	G60199
00-06	All	G61864



MAZDA ... cont'd
NAVAJO

91-94	All	G60162	G60161
-------	-----	--------	--------

TRIBUTE

01-06	All	G61862
-------	-----	-------	--------

MERCEDES-BENZ
SPRINTER

04-06	Exc. Dual Rear Wheels	G61918
04-06	w/ Dual Rear Wheels	G61919

MERCURY
MARINER

05-07	All	G61862
-------	-----	-------	--------

MONTEREY

04-06	Mini Passenger Van	G61873
-------	--------------------	-------	--------

MOUNTAINEER

97-01	Exc. Adjustable Suspension	G60221	G60222
-------	----------------------------	--------	--------

VILLAGER

93-96	4-Wheel ABS	G60003
97-02	Non-ABS	G60003

MITSUBISHI
MIGHTY MAX

83-96	2WD	G60354	G60308
83-94	4WD	G60074	G60075
95-96	All	G60308

MONTERO

89	2.6L 4Cyl L (156)	G60074	G60101
89	3.0L 6Cyl V (181)	G60074	G60152
92-00	All	G61122 ³⁴	G61121 ³⁴
90-91		G60074	G60152
89		G60074
83-88		G60074	G60101

MONTERO SPORT

97-02	All	G61122	G60101
-------	-----	--------	--------

VAN

87-90	All	G60305	G60308
-------	-----	--------	--------

NISSAN
521 PICKUP

69-72	All	G60303	G60100
-------	-----	--------	--------

620

75-79	All	G60303	G60100
-------	-----	--------	--------

620 PICKUP

72-74	All	G60303	G60100
-------	-----	--------	--------

720

82-85	2WD	G60100
86	2WD Vehicles Mfg. through 7/86	G60100
82-86	4WD	G60303	G60101
82-86	All	G60303
80-81		G60303	G60100

³⁴ See Reference D for procedures to replace Electronic Adjustable Suspension with non-adjustable product. / La referencia D proporciona el procedimiento para sustituir a la suspensión electrónica ajustable por un producto no ajustable. / La référence D fournit la marche à suivre pour remplacer la suspension électronique ajustable par un produit non ajustable.

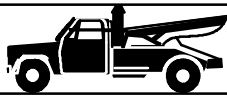

Front
Delantero
Avant

Rear
Trasero
Arrière

NISSAN ... cont'd
ARMADA

05-07	Exc. Auto Leveling System	G61875
-------	---------------------------	-------	--------

D21

87-94	2WD	G60310	G60308
86	2WD Mfg. from 8/86	G60310	G60308
87-94	4WD	G60303	G60101
86	4WD Mfg. from 8/86	G60303	G60101

FRONTIER

98-99	4WD	G60101
98-04	All	G60101
00-02	Crew Cab Pickup	G60310
00-04	Extended Cab Pickup	G61154
98-99	Extended Cab Pickup, 2WD	G61154	G60101
03-04		G60308
00		G60308
98-99	Standard Cab Pickup	G60310	G60101
01		G60310
00		G60310	G60308
98-99	Standard Cab Pickup, 2WD	G60308

PATHFINDER

96-97	All	G60255
00-04		G61180
04	Exc. Auto Leveling System	G61875
87-95	Exc. Electronic Adjustable Suspension	G60305	G60101 ³⁴
98-99	MFG to 11/98	G60255
99	MFG to 12/98	G61180

PICKUP

95-97	2WD	G60310	G60308
95-97	4WD	G60303	G60101

QUEST

99-02	4-Wheel ABS	G60003
93-98	All	G60003

TITAN

04-07	2WD	G61883
04-07	4WD	G61878

XTERRA

00-04	All	G61154	G60101
-------	-----	--------	--------

OLDSMOBILE
BRAVADA

96-01	All	G60051	G60050
91-94		G60051	G60050
02-04	Coil (Rear Spring Type)	G61175
02-04	w/Rear Air Spring Suspension	G62014

SILHOUETTE

97-04	All	G61116
90-96		G60312

³⁴ See Reference D for procedures to replace Electronic Adjustable Suspension with non-adjustable product. / La referencia D proporciona el procedimiento para sustituir a la suspensión electrónica ajustable por un producto no ajustable. / La référence D fournit la marche à suivre pour remplacer la suspension électronique ajustable par un produit non ajustable.



Front
Delantero
Avant

Rear
Trasero
Arrière

**PLYMOUTH
ARROW PICKUP**

81-82	All		G60354	G60308
-------	-----	--	--------	--------

ARROW PICKUP TRUCK

79-80	Truck		G60354	G60308
-------	-------	--	--------	--------

GRAND VOYAGER

96-00	All		G60233
88-95			G60062

PB100

75-80	All		G60017	G60039
-------	-----	--	--------	--------

PB100 VAN

74	All		G60017	G60039
----	-----	--	--------	--------

PB150

81-83	All		G60017	G60039
-------	-----	--	--------	--------

PB200

75-80	All		G60017	G60039
-------	-----	--	--------	--------

PB200 VAN

74	All		G60017	G60039
----	-----	--	--------	--------

PB250

81-83	All		G60017	G60039
-------	-----	--	--------	--------

PB300

75-80	All		G60039
75-80	Exc. 4000# Front Axle		G60017 ¹⁰	G60039
75-80	w/ 4000# Front Axle		G60043 ¹⁰	G60039

PB300 VAN

74	Exc. 4000# Front Axle		G60017 ¹⁰	G60039
74	w/ 4000# Front Axle		G60043 ¹⁰	G60039

PB350

81-83	All		G60039
81-83	Exc. 4000# Front Axle		G60017 ¹⁰	G60039
81-83	w/ 4000# Front Axle		G60043 ¹⁰	G60039

TRAILDUSTER

75-81	2WD		G60017	G60012
76-81	4WD		G60028	G60029
75			G60028	G60012
74	All		G60028	G60012

VOYAGER

96-00	All		G60233
87-95			G60062
84-86			G60062

**PONTIAC
AZTEK**

01-05	4WD		G61868
01-05	FWD		G61869

MONTANA

99-05	All		G61116
06	FWD Exc. Self Leveling Suspension		G61116

¹⁰ Slight grinding of control arm opening is required to install product made before August, 1988. / Un pequeño lijado de ajuste a la abertura del brazo de control es requerido para instalar productos fabricados antes de agosto 1988. / Un usinage mineur de l'ouverture de la bielle de poussée est nécessaire pour installer les pièces fabriquées avant août 1988.

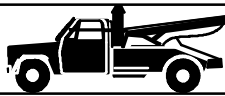

Front
Delantero
Avant

Rear
Trasero
Arrière

PONTIAC ... cont'd
SUNRUNNER

94-97	CAN	G61140
-------	-----	-------	--------

TORRENT

06-07	All	G62015
-------	-----	-------	--------

TRANS SPORT

97-98	All	G61116
90-96		G60312

SATURN
RELAY-2

05-06	FWD Exc. Self Leveling Suspension	G61116
-------	-----------------------------------	-------	--------

VUE

02-04	All	G61872
-------	-----	-------	--------

SUZUKI
GRAND VITARA

99-05	All	G61140
-------	-----	-------	--------

SAMURAI

94-95	All	G61139	G60353
86-91		G61139	G60353

SIDEKICK

89-98	All	G61140
-------	-----	-------	--------

VITARA

99-04	All	G61140
-------	-----	-------	--------

X-90

96-98	All	G61140
-------	-----	-------	--------

TOYOTA
4RUNNER

96-02	All	G60269
90-95		G60153 ⁸⁹	G60154
86-89		G60086	G60103
84-85		G60105	G60103
03-05		G61885

FJ CRUISER

07	All	G61885
----	-----	-------	--------

LAND CRUISER

98-05	All	G61173	G61169
93-97		G60176	G60177
88-90		G60091	G60128
79-83		G60101
69-74		G60003	G60101
67-68		G60003
80-83	FJ40 (Mfr Body Code)	G60003
76-79		G60003	G60101
75	FJ40 (Mfr Body Code) Mfg. 1/75	G60003
76-78	FJ55 (Mfr Body Code), Sport Utility	G60101
81-87	FJ60 (Mfr Body Code), Sport Utility	G60091	G60101
91-92	FJ80 (Mfr Body Code)	G60176	G60177
75	Mfg. 1/75	G60101

⁸⁹ Strut mount / Support de jambe de suspension / La Montura de un strut.



Front
Delantero
Avant

Rear
Trasero
Arrière

TOYOTA ... cont'd PICKUP

84-95	2WD	G60304	G60308
85-92	2WD 1Ton	G60101
70-83	2WD Includes Mojave	G60308
86-95	4WD Exc. Lift Kit	G60086	G60103
84-85		G60105	G60103
80-83		G60105	G60101
80-83	4WD w/2-3" Lift Kit	G60070 ³¹	G60067 ³¹

PREVIA

91-97	All	G60180
-------	-----	-------	--------

RAV4

00-05	All	G61860
-------	-----	-------	--------

SEQUOIA

01-04	All	G61865
-------	-----	-------	--------

SIENNA

98-03	All	G60164
-------	-----	-------	--------

T100

93-98	2WD	G60304	G60096
93-98	4WD	G60086	G60204

TACOMA

05-06	4WD Exc. X-Runner	G62006
95-04	All	G60103
04	Base, 2WD	G60338	G60232
05-06	Base, RWD Exc. Off Road Package	G61889
95-03	DLX, 2WD	G60338	G60232
05-06	Pre Runner, 2WD	G62007
01-04	S-Runner, 2WD	G60338	G60232
05-09	X-Runner Left	G62004
05-09	X-Runner Right	G62005

TUNDRA

00-06	All	G61156
-------	-----	-------	--------

VAN

87-89	2WD	G60301
87-89	4WD	G60169
84-86	All	G60301
84-89	Coil E847 (Rear Spring Type)	G60087
84-88	Leaf (Rear Spring Type)	G60308

VAN WAGON

88	All Exc. w/ Rear Leaf Springs	G60169
88	w/ Rear Leaf Springs	G60301	G60308
88	w/Rear Coil Springs	G60169	G60087

VOLKSWAGEN

VANAGON

86-89	4WD	G60077
-------	-----	-------	--------

³¹ Bellows Kit No. 141242 is recommended for use to protect piston rod from potentially harmful road debris. / El juego de fuelles No. 141242 es recomendado para proteger al vástago del pistón contra desechos de la carretera potencialmente dañinos. / Nécessaire de soufflets no 141242 recommandé pour protéger le tige de piston des débris de la route.

Gabriel®



Shocks for Medium & Heavy-Duty Trucks,
Trailers & Buses

(Alphabetical Listing)

Amortiguadores Para Camiones Pesados
Y Medios, Remolques Y Autobuses

(Lista alfabética)

Amortisseurs Pour Poids Lourds,
Poids Moyens, Remorques & Autobus









(Liste alphabétique)

















Gabriel®

Year Año Année	Model Modelo Modèle	O.E.M. #	Mount 	Front Delantero Avant	Rear Trasero Arrière
----------------------	---------------------------	----------	--	-----------------------------	----------------------------



ABC BUS.

	Drive Axle - Models with O.E.M. Number	12J-5-10		85733
	Models with O.E.M. Number	050134513		85732
		12L-5-88		85729
		6243-13790		85708
		6243-14040		85708
	Additional O.E.M. Interchanges	12B-5-1		85700	
		15L-5-114		85727	
		3166657		85700	
		680323		85700	

ACF BRILL BUS

	37R		83225
	C-27 and C-31 City Bus		85307	85307
	C-36 City Bus Serial #1051 and on		85307	85307
	C-37M		83225	83225
	C-44 City Bus and T-44 Trolley Bus		85308 or 89422	85308 or 89422
	IC-41 Intercity Bus Serial #1088 and on		85308 or 89422	85308 or 89422
	IC-41 Intercity Bus to Serial #1088		85307	85307
	Additional O.E.M. Interchanges	610513		85307	
		631237		85308 or 89422	
		641521		85308 or 89422	
		649648		85308 or 89422	
		659129		85303 or 89422	
		661732		83215	
		661733		83225	
		995891		85307	









ADVANCE MIXER

	ALL	13883		85334
		680087		85334

ALLCO TRAILER

	Dump Trailers with Watson & Chalin TA-5000-DB-19 Air Suspension	727602		83122 or 89406
--	---	--------	---	-------	-------------------

AM GENERAL

	Small Bus	5979484		85302 or 89420
	Additional O.E.M. Interchanges	3166657		85700	
		4975501		85700	
		5565748		85700	
		5957136		85700	
		5969438		85700	
		5978712		85700	
		5979574		85700	
		5982537		85700	

Gabriel Part Numbers that appear in BLUE are GasSLX, adjustable shocks. \ Los números de parte Gabriel imprimidos en AZUL son amortiguadores ajustables GasSLX. \ Les numéros de pièce Gabriel imprimés en BLEU sont des amortisseurs ajustables GasSLX.

★ Will be available in first quarter of 2011.

**Gabriel®**

Year Año Année	Model Modelo Modèle	O.E.M. #	Mount 	Front Delantero Avant	Rear Trasero Arrière
----------------------	---------------------------	----------	-----------	-----------------------------	----------------------------

ARVIN MERITOR

	Models with O.E.M. Number	654907		85000 or 89436
--	---------------------------	--------	--	-------	-------------------

BECK BUS

	Deck and 1/2 Bus - Spring Suspension		85307	85307
	Deck and 1/2 Bus - Trailing Wheel	85301
	Deck and 1/2 Bus with Air Suspension		85304	85304
	Luxury Liner Bus - Spring Suspension		85307	85307
	Mainliner with Air Suspension		85304	85304
	Models with O.E.M. Number	14QK-140 14QK-2102	 	85304 85304

BENSON TRUCK BODIES INC.

	Models with Hendrickson Intrax Air Suspension	A-20002		85000 or 89436
	Models with Neway Air Suspension	90044089		83124 or 89407

BERING TRUCK CORP.

	HD80TT Models with Hendrickson HAS-400 Air Suspension	47902-24		83137
	Models with Hendrickson HAS-230 Air Suspension	47902-24		83137

THE BINKLEY COMPANY

1997	Trailers with Binkley AirLite Suspension	16965 6898	 	85006 83125
------	--	---------------	------	----------------	----------------

BLUEBIRD SCHOOL BUS

	All American	0823054		85304
	All American Buses (FE & RE Models)				
	- With 13,200 lb, 2-Leaf Parabolic Springs	1658525 AMS65109	 89432
	- With 19,000 lb - 21,000 lb - 2 Stage Leaf Springs	AMS65110		85005 or 89430
	All American Models with Comfort Air Suspensions	60998-001		85337
Sept/98 Nov/01	All American Models with Hendrickson Parasteer Suspensions	59483-000 60665-005	 	85919 85919
	Bus with 35" Chassis	303-1350628 90-1968	 	85712 85712
	Buses with Neway Air Suspension	1526417 90044448	 	85052 85051
	Buses with Neway Air Suspension with shock stamping	90045083		85910
	Buses with Neway Air Suspensions with O.E.M. Number	90044915		83127
	Buses with Reyco Air Suspension	1668722 1668730 1722222	 	85030 or 89440 85013 or 89414 85013 or 89414

Gabriel Part Numbers that appear in BLUE are GasSLX, adjustable shocks. \ Los números de parte Gabriel imprimidos en AZUL son amortiguadores ajustables GasSLX. \ Les numéros de pièce Gabriel imprimés en BLEU sont des amortisseurs ajustables GasSLX.









★ Will be available in first quarter of 2011.



Gabriel®

Year Año Année	Model Modelo Modèle	O.E.M. #	Mount 	Front Delantero Avant	Rear Trasero Arrière
----------------------	---------------------------	----------	--	-----------------------------	----------------------------

BLUEBIRD SCHOOL BUS ... cont'd

	City Bird Buses with 1" Mounting Pins	300-0614966 300-0614974 609180 614958		85307 85307 85304 85304
	Rear Engine Model School Buses with 1" Mounting Pins 300-0614966 300-0614974 609180 614958		85307 85307 85307 85304 85304
	School Bus with 3/4" Mounting Pins	2021459		85012 or 89413	85012 or 89413
	TC 2000 Bus, TC/2000 FE Series - With Neway Rear Air Suspension - With Ridewell Front Suspension Option #4540 - With Ridewell Rear Suspension Option #4540 - With Standard Flat Leaf Rear Springs - With Standard Parabolic Front Springs	90045050 1004167 1316546 1658533 1667831 300-1317767 305-0961284 1746163 1658525	 85712 85029 85029 89432	85914 85006 85010 85734 85006
	Vision Models with Comfort Air Suspensions	60998-001		85337
	WanderLodge - Drive Axle - Front - with Reyco Air Suspension	1750793 90-1968-SP1 1722214	 85712	85712 85030 or 89440
	WanderLodge LX, LXI - Models - Front - Rear	90-2497-SP1 90-1951-SP1	 85734
	Models with O.E.M. Number	300-1316546 614974 680783	 85304 85304	85006
	Additional O.E.M. Interchanges	0523047 1217934 1707405 1962422 1962430 300-0823047 300-0823054 300-09612284 4759272 671933 680155 680667 70317 70397 7805-M-1001 87001-01A		85736 85304 85321 85304 83207 or 89407 85736 85304 85734 89447 85919 85712 89447 89402 85006 85919 85734	

Gabriel Part Numbers that appear in BLUE are GasSLX, adjustable shocks. Los números de parte Gabriel imprimidos en AZUL son amortiguadores ajustables GasSLX. \ Les numéros de pièce Gabriel imprimés en BLEU sont des amortisseurs ajustables GasSLX.

★ Will be available in first quarter of 2011.



Year Año Année	Model Modelo Modèle	O.E.M. #	Mount 	Front Delantero Avant	Rear Trasero Arrière
----------------------	---------------------------	----------	-----------	-----------------------------	----------------------------

BLUEBIRD SCHOOL BUS ... cont'd

		90-1813		85712	
		A-4890		85712	

BREDA BUS

	Models with O.E.M. Number	500-403-4	
--	---------------------------	-----------	--	-------	-------

BROCKWAY SCHOOL BUS

	257T, 260S, 260T		83207 or 89407
	300, 400, 500 Series				
	- With 1" Mounting Pins		85307
	- With 3/4" Mounting Pins		85012 or 89413
	55 and 61 Passenger School Bus				
	- With 1" Rear Mounting Pins		83216
		85305
	- With 3/4" Rear Mounting Pins		83216
	88WH, 128W, 154W		83216
	Less than 55 Passenger School Bus		83216
	Models with O.E.M. Number	14QK-281P10		85305
		14QK-282P3		83216
		152398		85304
		152412		83215
		508657		85307
		515231		85303 or 89422
		530873		83207 or 89407
		532397		85307

BUILT RITE

	Models with Air Suspension	318-06-100		85006
--	----------------------------	------------	--	-------	-------

BUS & TRUCK CO.

	Silver Eagle Bus	0100-905		85307	85307
		680091		85303 or 89422	85303 or 89422
		70039		85303 or 89422	85303 or 89422
		70041		85305	85305

CARPENTER BUS

	Models with O.E.M. Number	0272-SS5		85712
		63-0001		85713

CASCADE TRAILER

	Models with Air Suspension	120-1		83125
--	----------------------------	-------	--	-------	-------

Gabriel Part Numbers that appear in BLUE are GasSLX, adjustable shocks. | Los números de parte Gabriel imprimidos en AZUL son amortiguadores ajustables GasSLX. | Les numéros de pièce Gabriel imprimés en BLEU sont des amortisseurs ajustables GasSLX.



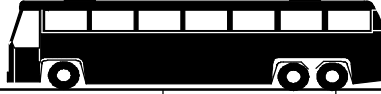



★ Will be available in first quarter of 2011.



Gabriel®

Year Año Année	Model Modelo Modèle	O.E.M. #	Mount 	Front Delantero Avant	Rear Trasero Arrière
----------------------	---------------------------	----------	--	-----------------------------	----------------------------

CHALMERS SUSPENSION

	K800-199 Series Kit	665174		85060
	Single Axle Truck Suspension (1023-23K, 1030 -30K, 1040-40K)	665174		85060
	Models with O.E.M. Number	21335		G60014
		665174		85060
		800670		85301
		800781		85314 or 89425

CHAMPION TRANSIT















	GMC P6000 Chassis	22064230		83136
		22064231		85324

CHANCE BUS

	Models with O.E.M. Number	59039		83207 or 89407	83207 or 89407
		6892		83207 or 89407	83207 or 89407
		6893		83203 or 89436
		728600		83203 or 89436	83203 or 89436
		AS789B		85014	85014
	Additional O.E.M. Interchanges	270-6708		85014	
		665017		85014	

CHEVROLET TRUCK (Also See GMC Truck)

4, 40, 4000 & 4500 Series

1969-72	All - Exc. Tilt Cab	22012096		83221	83221
		3192892		83221	83221
1960-62	C-40		83221
1963-68	C-40 , P-40, SS-40		83221
			85005 or 89430
1968	Cowl - Exc. School Bus	22012096		83221
		3192892		83221
1969-70	D-D Forward Control with Tilt Cab	22012095		85005 or 89430
		4940606		85005 or 89430
1969-70	D-D Forward Control with 9000 & 11000 lb Axles - Ex. Tilt Cab	22012096		83221
		3192892		83221
1967-72	S-40 School Bus	22012096		83221	83221
		3192892		83221	83221
1967-68	TDM 4 Cycle Detroit Diesel with Tandem Axle - Exc. Tilt Cab	22012096		83221
		3192892		83221

5, 50, 5000 & 5500 Series

1969-72	All - Exc. Tilt Cab	22012096		83221	83221
		3192892		83221	83221



























Gabriel Part Numbers that appear in BLUE are GasSLX, adjustable shocks. \ Los números de parte Gabriel imprimidos en AZUL son amortiguadores ajustables GasSLX. \ Les numéros de pièce Gabriel imprimés en BLEU sont des amortisseurs ajustables GasSLX.

★ Will be available in first quarter of 2011.











**Gabriel®**

Year Año Année	Model Modelo Modèle	O.E.M. #	Mount 	Front Delantero Avant	Rear Trasero Arrière
----------------------	---------------------------	----------	--	-----------------------------	----------------------------

CHEVROLET TRUCK ... cont'd

1976-89	C, M, S Chassis - Conventional Cab	22002294		83304
		22007752		83304
		22012096		83221
		22012169		83221
1975-80	C, M, S Chassis - Conventional Cab	4975510		83221
1973-80	C, M, S Chassis - Conventional Cab	22007750		83207 or 89407
		4975467		83207 or 89407
		4975494		83207 or 89407
1973-89	C, S Chassis - Conventional Cab and School Bus	22012095		85005 or 89430
		22012166		85005 or 89430
1973-80	C, S Chassis - Conventional Cab and School Bus	22012096		83221
		3192892		83221
1963-69	C-50, M-50, S-50, SE-50, T-50		83221
1963-68	C-50, M-50, S-50, SE-50, T-50		85005 or 89430
1968	Cowl - Exc. School Bus	22012096		83221
		3192892		83221
1969-70	D-D Forward Control with 9000 & 11000 lb Axles - Exc. Tilt Cab	22012096		83221
		3192892		83221
1969-70	D-D Forward Control with Tilt Cab	22012095		85005 or 89430
		4940606		85005 or 89430
1973-78	S-50 School Bus	22012166		85005 or 89430
		3192892		83221
1969-72	S-50 School Bus	3192892		83221	83221
1971-72	TDM 4 Cycle Detroit Diesel with Tandem Axle - Exc. Tilt Cab	22012095		85005 or 89430
		4940606		85005 or 89430
1967-68	TDM 4 Cycle Detroit Diesel with Tandem Axle - Exc. Tilt Cab	22012096		83221
		3192892		83221

6, 60, 6000 & 6500 Series

1969-72	All - Exc. Tilt Cab	22012096		83221	83221
		3192892		83221	83221
1968-69	All with 9000 & 11000 lb Axles - Exc. Tilt Cab	22012095		85005 or 89430
		4940606		85005 or 89430
1979-89	B6P042 School Bus (Axle codes F070, F070D)	22002294		83304
		22007752		83304
1979-89	B6P042 School Bus (Axle codes F090, F120D)	22002295		83303
		22007753		83303
		22017531		83303
1979-89	B6P042 School Bus w/15000 lb or 17000 lb Rear Springs	22012096		83221
		22012169		83221

Gabriel Part Numbers that appear in BLUE are GasSLX, adjustable shocks. | Los números de parte Gabriel imprimidos en AZUL son amortiguadores ajustables GasSLX. | Les numéros de pièce Gabriel imprimés en BLEU sont des amortisseurs ajustables GasSLX.





































★ Will be available in first quarter of 2011.



Gabriel®

Year Año Année	Model Modelo Modèle	O.E.M. #	Mount 	Front Delantero Avant	Rear Trasero Arrière
----------------------	---------------------------	----------	--	-----------------------------	----------------------------

CHEVROLET TRUCK ... cont'd

1979-89	B6P042 School Bus w/18500 or 20800 lb Rear Springs	22012095		85005 or 89430
		22012166		85005 or 89430
1976-89	C, M Chassis - Conventional Cab	22002294		83304
		22007752		83304
1975-80	C, M, S Chassis - Conventional Cab and School Bus	4975510		83221
1973-75	C, M, S Chassis - Conventional Cab and School Bus with 5000 & 7000 lb Axle	22007750		83207 or 89407
		4975467		83207 or 89407
		4975494		83207 or 89407
1973-89	C, S Chassis - Conventional Cab and School Bus - Exc. with 20800 & 23000 lb Rear Axle	22012096		83221
		22012169		83221
		3192892		83221
1973-89	C, S Chassis - Conventional Cab and School Bus with 20800 & 23000 lb Rear Axles	22012095		85005 or 89430
		22012166		85005 or 89430
		4940606		85005 or 89430
1979-89	C, S Chassis - Conventional Cab and School Bus	22002295		83303
		22007753		83303
		22017530		83303
		22017531		83303
1973-80	C, S, T Chassis - Conventional & Tilt Cab and School Bus with 5000 & 7000 lb Axle	22002293		85005 or 89430
		22007701		85005 or 89430
		22007751		83303
		22012095		85005 or 89430
		3192890		85005 or 89430
		4940606		85005 or 89430
		4940662		85005 or 89430
1971-72	Conventional Cab & Tilt Cab with 9000 & 11000 lb Axles	22012095		85005 or 89430
		4940606		85005 or 89430
1968	Cowl - Exc. School Bus	22012096		83221
		3192892		83221
1969-70	D - D Forward Control with 9000 & 11000 lb Axles - Exc. Tilt Cab	22012096		83221
		3192892		83221
1976-89	S Chassis - School Bus	22002294		83304
		22007702		83304
		22007752		83304
1973-78	S-60	4975510		83221
1969-72	S-60	3192892		83221	83221



























Gabriel Part Numbers that appear in BLUE are GasSLX, adjustable shocks. \ Los números de parte Gabriel imprimidos en AZUL son amortiguadores ajustables GasSLX. \ Les numéros de pièce Gabriel imprimés en BLEU sont des amortisseurs ajustables GasSLX.

★ Will be available in first quarter of 2011.







**Gabriel®**

Year Año Année	Model Modelo Modèle	O.E.M. #	Mount 	Front Delantero Avant	Rear Trasero Arrière
----------------------	---------------------------	----------	--	-----------------------------	----------------------------

CHEVROLET TRUCK ... cont'd

1973-78	S-60 w/Air Brakes	22007701		85005 or 89430
		22007751		83303
		22012095		85005 or 89430
		22012166		85005 or 89430
		3171069 4940606	 	85304 85005 or 89430
1973-75	SE, SS-60 thru Serial # 134487 (1975 1st Design)	22007700		83207 or 89407
		22007750		83207 or 89407
		4975467		83207 or 89407
		4975494		83207 or 89407
1976-78	SE-60 From Serial # 120000 (1976 2nd Design)	22002294		83304
		22007752		83304
1976-78	SE-60 w/Hydraulic Brakes from Serial # 120000 (1975 2nd Design)	22012169		83221
		3192892		83221
1973-74	SG, SM-60	3192890		85005 or 89430
1973-74	SG, SM-61	4940606		85005 or 89430
1973-74	SG, SM-62	22002293		85005 or 89430
1973-74	SG, SM-63	22007701		85005 or 89430
1973-74	SG, SM-64	22007751		83303
1960-62	Standard and Heavy Duty Truck and School Bus (2 Ton)		83221
1971-72	TDM 4 Cycle Detroit Diesel with Tandem Axle	22012095		85005 or 89430
		4940606		85005 or 89430
1967-68	TDM 4 Cycle Detroit Diesel with Tandem Axle - Exc. Tilt Cab	22012096		83221
		3192892		83221
1979-80	W Chassis - 72" BBC Steel Tilt Cab	22002293		85005 or 89430
		22007751		83303

7, 70 & 7000 Series

1966-72	72" BBC Steel Tilt Cab with V-6 2 Cycle Diesel Engine	22012095		85005 or 89430
		3171462		85005 or 89430
		3192890		85005 or 89430
1966-72	72" BBC Steel Tilt Cab with V-6 2 Cycle Diesel Engine with 17201 and 17221 Axle	22012096		83221
		3192892		83221
1966-72	72" BBC Steel Tilt Cab with V-6 2 Cycle Diesel Engine with 19101 and 19201 Axle	4940600		83209 or 89414

Gabriel Part Numbers that appear in BLUE are GasSLX, adjustable shocks. \ Los números de parte Gabriel imprimidos en AZUL son amortiguadores ajustables GasSLX. \ Les numéros de pièce Gabriel imprimés en BLEU sont des amortisseurs ajustables GasSLX.



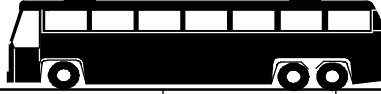



































★ Will be available in first quarter of 2011.



Gabriel®

Year Año Année	Model Modelo Modèle	O.E.M. #	Mount 	Front Delantero Avant	Rear Trasero Arrière
----------------------	---------------------------	----------	--	-----------------------------	----------------------------

CHEVROLET TRUCK ... cont'd

1966-72	92" BBC Conventional Cab	3192657		83216
		4940614		83216
		4963854		83216
1979-89	C, M Chassis - 97" BBC Conventional Cab	22002294		83304
		22002295		83303
		22007752		83304
		22007753		83303
		22012095		85005 or 89430
		22012166		85005 or 89430
		22017530		83303
1966-72	Conventional Cab with Tapered 2-Leaf Softride 11000 lb Rating and F120 Axle (12000 lb)	22046483		85304
		22052336		85304
		3171069		85304
1966-72	Conventional Cab With Tapered 2-Leaf Softride 7000 & 9000 lb Rating and F070, F090, F120 Axle (7000, 9000 & 12000 lb)	3171068		83216
		3192657		83216
		4940614		83216
		4963853		83216
		4963854		83216
1977-80	H, J Chassis - 92" BBC Conventional Cab	4963854		83216
		4984526		83216
1973-80	H, J Chassis - 92" BBC Conventional Cab with V-6, V8 Diesel Engines	4940614		83216
		4963854		83216
1973-80	H, J, M Chassis - 92" & 114" BBC Conventional Cab	2204683		85304
		3171069		85304
1973-80	R Chassis - Rear Engine Bus	22012090		85308 or 89422
		5552451		85308 or 89422
		5552456		85307
		5552552		85303 or 89422
1983-84	S7T042 Forward Control Chassis w/17000, 18500, 21000, 23000 lb Rear Axle	22012095		85005 or 89430
		22012166		85005 or 89430
1983-84	STT042 Forward Control Chassis	22012065		85304
		3171069		85304
1973-80	T, W Chassis - 72" BBC Steel Tilt Cab (4 x 2) with V-6 Diesel Engine	22007751		83303
		22012095		85005 or 89430
		4940606		85005 or 89430
		4975497		85005 or 89430
1973-80	T, W Chassis - 72" BBC Steel Tilt Cab with V-6 Gas Engine	22012091		85303 or 89422
		5552452		85303 or 89422





























Gabriel Part Numbers that appear in BLUE are GasSLX, adjustable shocks. \ Los números de parte Gabriel imprimidos en AZUL son amortiguadores ajustables GasSLX. \ Les numéros de pièce Gabriel imprimés en BLEU sont des amortisseurs ajustables GasSLX.

★ Will be available in first quarter of 2011.













**Gabriel®**

Year Año Année	Model Modelo Modèle	O.E.M. #	Mount 	Front Delantero Avant	Rear Trasero Arrière
----------------------	---------------------------	----------	--	-----------------------------	----------------------------

CHEVROLET TRUCK ... cont'd**8, 80 & 8000 Series**

1966-69	72" BBC Steel Tilt Cab	5544060		85302 or 89420
1966-72	92" BBC Conventional Cab	3171068		83216
		3192657		83216
		4940614		83216
		4963853		83216
		4963854		83216
1966-72	92" BBC Conventional Cab with 7000 & 9000 lb Axles - Exc. 2-Leaf Softride	22046483		85304
		22052336		85304
		3171069		85304
1979-82	H, J Chassis - 92" BBC Conventional Cab 4 x 2 with Air Suspension	22012065		85304
		22046483		85304
		22052336		85304
		3171069		85304
1979-82	H, J Chassis - 92" BBC Conventional Cab 4 x 2 with F090, F120 Axle	22012065		85304
1978-81	H, J Chassis - 92" BBC Conventional Cab	4963854		83216
		4984526		83216
1973-81	H, J Chassis - 92" BBC Conventional Cab with V-6 Gas Engine	4940614		83216
		4963854		83216
1973-86	H, J, M Chassis - 92" & 114" BBC Conventional Cab	22046483		85304
		22052336		85304
		3171069		85304
1973-80	R Chassis - Rear Engine Bus	22012090		85308 or 89422
		22012091		85303 or 89422
		5552451		85308 or 89422
		5552452		85303 or 89422
		5552456		85307
1970-80	T, W Chassis - 72" BBC Steel Tilt Cab with V-6 Gas Engine	22012091		85303 or 89422
		5552452		85303 or 89422

9000 Series

1970-72	54" BBC Aluminum Tilt Cab 6 x 4	22046483		85304	85304
		22052336		85304	85304
		3171069		85304	85304
1970-72	92" & 114" BBC Conventional Cab - Exc. 6 x 4	4940614		83216
		4963854		83216
1970-72	92" & 114" BBC Conventional Cab 6 x 4	22046483		85304	85304
		22052336		85304	85304
		3171069		85304	85304
1970-86	D, F Chassis - 54" BBC Aluminum Tilt Cab with Rear GM Air Ride Suspension (4 Req'd)	22012065		85304	85304
		22046483		85304	85304
		22052336		85304	85304
		3171069		85304	85304

Gabriel Part Numbers that appear in BLUE are GasSLX, adjustable shocks. \ Los números de parte Gabriel imprimidos en AZUL son amortiguadores ajustables GasSLX. \ Les numéros de pièce Gabriel imprimés en BLEU sont des amortisseurs ajustables GasSLX.



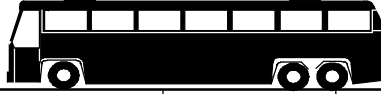





★ Will be available in first quarter of 2011.











Gabriel®

Year Año Année	Model Modelo Modèle	O.E.M. #	Mount 	Front Delantero Avant	Rear Trasero Arrière
----------------------	---------------------------	----------	--	-----------------------------	----------------------------























CHEVROLET TRUCK ... cont'd

1970-86	H, J Chassis - 92" BBC Conventional Cab	22046483		85304
		22052336		85304
		3171069		85304
1977-86	M, N Chassis - 114" BBC Conventional & 108" BBC Aluminum Conventional Cab with Rear GM Air-Ride Suspension (4 Req'd)	22012065		85304	85304
		22046483		85304	85304
		22052336		85304	85304
		3171069		85304	85304
1970-80	T, W Chassis - 72" BBC Steel Tilt Cab	22012091		85303 or 89422
		5552452		85303 or 89422

B - Series

1990-98 1990-06	B7 School Bus Chassis - With 11000, 13500, 15000 lb Taperleaf Springs - With 15000, 19000, 21000 lb Multileaf Springs	22064231		85324
		15174902		85071
		22064232		85071
1993-98	Models with O.E.M. Number	22064231		85324
1990-98	Models with O.E.M. Number	15588554		83136
		22064230		83136
1990-06	Models with O.E.M. Number	15123676		83136
		88982682		83136

C - Series (C4500, C5500) Kodiak

1990-09	C Chassis - Conventional Cab - Front Shock with O.E.M. Number	15123676		83136
		15588554		83136
		15887728		83136
		19152843		83136
		22064230		83136
		88982682		83136
		1990- 1990-09	- With 11000, 13500, 15000 lb Taperleaf Springs - With 15000, 19000, 21000 lb Multileaf Springs	22064231	
15174902				85071
22064232				85071
88982686				85071
1990-06	- With 16900 or 17850 lb Taperleaf Springs	21998392		85336
		22064489		85336
		88963409		85336
1990-	- With 19000, 21000, 23000 lb Taperleaf Springs (EXC Low Profile Vehicle)	22064233		83136
2004-09	C Chassis - Conventional Cab (Non 4x4 Option) with 13,500 Multi-leaf Spring	15185644		83155
		508-89		83155
		L-12706		83155
1983-99	C Chassis - Conventional Cab with 9100 to 17500 lb Rear Axle	22064432		85050
2003-09	C Chassis - Conventional Cab with O.E.M. Number	19152843		83136
2003-09	C Chassis - Conventional Cab with Taperleaf Rear Suspension	15185643		83153
	Models with O.E.M. Number	88982684		83136
		88982686		85071
		88982688		85336

Gabriel Part Numbers that appear in BLUE are GasSLX, adjustable shocks. \ Los números de parte Gabriel imprimidos en AZUL son amortiguadores ajustables GasSLX. \ Les numéros de pièce Gabriel imprimés en BLEU sont des amortisseurs ajustables GasSLX.

★ Will be available in first quarter of 2011.

**Gabriel®**

Year Año Année	Model Modelo Modèle	O.E.M. #	Mount 	Front Delantero Avant	Rear Trasero Arrière
----------------------	---------------------------	----------	-----------	-----------------------------	----------------------------

CHEVROLET TRUCK ... cont'd**C - Series (C6500, C7500, C8500) Kodiak**

1990-09	Conventional Cab				
	- Front Shock with O.E.M. Number	15123676		83136
		15174898		83136
		15588554		83136
		15887728		83136
		19152843		83136
		22064230		83136
		88982682		83136
1990-1990-09	- With 11000, 13500, 15000 lb Taperleaf Springs	22064231		85324
	- With 15000, 19000, 21000 lb Multileaf Springs	15174902		85071
		22064232		85071
		88982686		85071
1990-06	- With 16900 or 17850 lb Taperleaf Springs	21998392		85336
		22064489		85336
		88963409		85336
1990-	- With 19000, 21000, 23000 lb Taperleaf Springs (EXC Low Profile Vehicle)	22064233		83136
1983-99	Conventional Cab with 9100 to 17500 lb Rear Axle	22064432		85050
1995-99	Models with Hendrickson Air Suspension (Stamping number 47902-13)	12474915		83122 or 89406
		15963161		83122 or 89406
1996-99	Models with Hendrickson Air Suspension (Stamping number 47902-29)	12474917		83137
		15740554		83137
	Models with O.E.M. Number	88982684		83136
		88982688		85336

P - Series

1992-96	Motorhome Chassis	22064231		85324
		22064233		83136

T - Series (T5500, T6500, T7500, T8500)

1997-	FL1 Tilt Cab with 8100 lb Axle	22064804		83136	
		22064805		83136	
		22165187		83136	
		22165188		83136	
1997-	FL2 Tilt Cab with 5000 to 11000 lb Axle	22064807		83136	
		22166442		83136	
1997-	FL3 Tilt Cab with 14575 lb Axle	22064806		83136	
		22165189		83136	
1999	Models with Hendrickson Air Suspension (Stamping number 47902-13)	12474915		83122 or 89406	
		15963161		83122 or 89406	
1990-99	Tilt Cab					
		- With 11000, 13500, 15000 lb Taperleaf Springs	22064231		85324
		- With 15000, 19000, 21000 lb Multileaf Springs	15174902		85071
			22064232		85071
1992-99	- With 16900 lb Taperleaf Springs	22064489		85336	

Gabriel Part Numbers that appear in BLUE are GasSLX, adjustable shocks. | Los números de parte Gabriel imprimidos en AZUL son amortiguadores ajustables GasSLX. | Les numéros de pièce Gabriel imprimés en BLEU sont des amortisseurs ajustables GasSLX.

★ Will be available in first quarter of 2011.

























Gabriel®



















Year Año Année	Model Modelo Modèle	O.E.M. #	Mount 	Front Delantero Avant	Rear Trasero Arrière
----------------------	---------------------------	----------	--	-----------------------------	----------------------------

CHEVROLET TRUCK ... cont'd

1992-06	- With 16900 lb Taperleaf Springs	21998392		85336
		88963409		85336
1992-99	- With 19000, 21000, 23000 lb Taperleaf Springs (EXC Low Profile Veh.)	22064233		83136

W - Series (Isuzu)

1986-90	W4 Series	8-94454-986-0		G60177
		8-94454-987-0		G60177
		9-51630-647-1		G60177
1983-95	W4 Series	9-51630-666-0		85012 or 89413
		9-51630-666-2		85012 or 89413
1989-92	W4 Series Flatlow	9-51630-666-0		85012 or 89413
		9-51630-666-2		85012 or 89413
1989-90	W4 Series Flatlow	9-51630-647-1		G60177
86- Aug95	W4 Series with 11000 lb Suspension	97083027		G60177
Sep92-	W4 Series with 13000 lb Suspension	97083029		G60177
Sep88 - Aug92	W4 Series with 13000 lb Suspension	94454987		G60177
1987- Sept95	W4 Series with 13000 lb Suspension	97083029		G60177
1988-97	W5 Series	1-51630-217-0		83114
		1-51630-217-1		83114
		1-51630-219-1		83114
1986-91	W6 Series	1-51630-168-1		G60164
		1-51630-217-0		83114
		1-51630-217-1		83114
	Models with O.E.M. Number	94033786		83114
		94051090		83114
		94057593		83114
		97201960		G60177

	Models with O.E.M. Number	15642943		83136
		22099889		85336
	Additional O.E.M. Interchanges	22007703			83303
		22012067			85700
		22012079			85701
		22012082			85702
		22012083			85711
		22012114			85700
		22012131			85711
		22024062			85701
		22024673			85710
		22045526			85702
		22046481			85702
		22046485			85710
		22046499			85710
		22052014			85702
		22052424			85710
		3171696			85307

Gabriel Part Numbers that appear in BLUE are GasSLX, adjustable shocks. \ Los números de parte Gabriel imprimidos en AZUL son amortiguadores ajustables GasSLX. \ Les numéros de pièce Gabriel imprimés en BLEU sont des amortisseurs ajustables GasSLX.























































★ Will be available in first quarter of 2011.



Gabriel®

Year Año Année	Model Modelo Modèle	O.E.M. #	Mount 	Front Delantero Avant	Rear Trasero Arrière
----------------------	---------------------------	----------	--	-----------------------------	----------------------------

CHEVROLET TRUCK ... cont'd

Year Año Année	Model Modelo Modèle	O.E.M. #	Mount 	Front Delantero Avant	Rear Trasero Arrière
	Additional O.E.M. Interchanges	3172948		85303 or 89422	
		3175509		85735	
		3178157		85700	
		3178233		85734	
		3178507		85700	
		3178995		85700	
		3188626		85300 or 89419	
		3188729		85303 or 89422	
		4939852		85308 or 89422	
		4939967		85308 or 89422	
		4940601		83216	
		4940627		83203 or 89436	
		4940640		83216	
		4940650		83207 or 89407	
		4940654		83216	
		4940660		83207 or 89407	
		4963844		85307	
		4964853		83217	
		4974401		85700	
		4975429		85300 or 89419	
		4975479		83400	
		4975480		83400	
		4975515		85701	
		4975516		85702	
		4975518		85704	
		4975538		85700	
		4975549		83216	
		4975550		85702	
		5171068		83216	
		5316784		85700	
		5316791		83219	
		5316792		85305	
		5316793		85305	
		5321920		85307	
		5321929		85307	
		5348631		83203 or 89436	
		5352858		85305	
		5353054		85303 or 89422	
		5355798		85307	
		5357955		85300 or 89419	
		5357956		85734	
		5357959		85300 or 89419	
		5361994		85734	
		5374779		85308 or 89422	
		5374999		85307	
		5385939		85307	
		5392387		85303 or 89422	
		5394448		85305	
		5394467		85305	
		5394468		85735	
		5455798		85307	
		5513489		83216	
		5513716		85304	

Gabriel Part Numbers that appear in BLUE are GasSLX, adjustable shocks. | Los números de parte Gabriel imprimidos en AZUL son amortiguadores ajustables GasSLX. | Les numéros de pièce Gabriel imprimés en BLEU sont des amortisseurs ajustables GasSLX.























































★ Will be available in first quarter of 2011.



Gabriel®

Year Año Année	Model Modelo Modèle	O.E.M. #	Mount 	Front Delantero Avant	Rear Trasero Arrière
----------------------	---------------------------	----------	---	-----------------------------	----------------------------

CHEVROLET TRUCK ... cont'd

Year Año Année	Model Modelo Modèle	O.E.M. #	Mount 	Front Delantero Avant	Rear Trasero Arrière
	Additional O.E.M. Interchanges	5516459			85305
		5522781			85735
		5522794			85308 or 89422
		5522818			85305
		5527001			85300 or 89419
		5527271			85700
		5527272			85700
		5527606			85305
		5531027			85301
		5531435			85307
		5531436			85307
		5531437			85307
		5532026			85304
		5532425			83207 or 89407
		5532433			83207 or 89407
		5532675			85307
		5534430			85303 or 89422
		5534439			85304
		5534447			85303 or 89422
		5544112			83216
		5544581			85302 or 89420
		5544716			85304
		5544717			85304
		5544812			83308
		5544818			85735
		5549899			83207 or 89407
		5549924			85700
		5549925			85304
		5552111			85304
		5552112			85307
		5552114			83216
		5552205			83217
		5552206			83214
		5552207			83217
		5552208			83217
		5552209			83215
		5552210			85308 or 89422
		5552244			85308 or 89422
		5552285			83214
		5552286			83217
		5552287			83217
		5552288			83217
		5552453			85301
		5552527			85735
		5554184			85302 or 89420
		5554589			85307
		5554596			85303 or 89422
		5554814			85302 or 89420
		5554959			83401
		5554995			85305
		5559363			83203 or 89436
		5585939			85307
		684280			83209 or 89414

Gabriel Part Numbers that appear in BLUE are GasSLX, adjustable shocks. \ Los números de parte Gabriel imprimidos en AZUL son amortiguadores ajustables GasSLX. \
 Les numéros de pièce Gabriel imprimés en BLEU sont des amortisseurs ajustables GasSLX.

★ Will be available in first quarter of 2011.

**Gabriel®**

Year Año Année	Model Modelo Modèle	O.E.M. #	Mount 	Front Delantero Avant	Rear Trasero Arrière
----------------------	---------------------------	----------	-----------	-----------------------------	----------------------------

CHEVROLET TRUCK ... cont'd

	Additional O.E.M. Interchanges	97-2210-00153		85701	
		97-2210-00164		85708	
		97-2210-00170		85733	

CLARK EQUIPMENT

	Model 130885 (Air Suspension)	5532675		85307
	Ross Carrier	355778		85315	85315
		680042		85301	85301

CONTINENTAL TRAILWAYS- EAGLE INT'L

	Buses with O.E.M. Number	6-05-5		85307	85307
	Silver Eagle	01-0100-905		85303 or 89422	85303 or 89422
		5394467		85305	85305
		680091		85303 or 89422	85303 or 89422
		70039		85303 or 89422	85303 or 89422
		70041		85305	85305
	Models with O.E.M. Number	01-0100-020		85307	85307
		5532026		85304	85304

COUNTRY COACH

	Models with O.E.M. Number	89406		89406
		89414		89414

CRANE CARRIER

	Models with O.E.M. Number	277A-1		85307
		277A-13		85302 or 89420
		277A-14		85304
		277A-8		85303 or 89422
		277A-9		85307
		680091		85303 or 89422
	Additional O.E.M. Interchanges	277A-12		85304	
		680088		85713	

CROWN COACH

	All with Steel Spring Suspension	3188729		85303 or 89422
		5532026		85304	85304
	Models with O.E.M. Number	5532036		85734	85734

CUNHA PRODUCTS OHD

	Truck Dollies	CP-5222		85315
--	---------------	---------	--	-------	-------

DANA

	Dana Smart Ride - RF and RS Series - 20,000 lb and 23,000 lb	SR1VJ100		85078
--	--	----------	--	-------	-------

Gabriel Part Numbers that appear in BLUE are GasSLX, adjustable shocks. | Los números de parte Gabriel imprimidos en AZUL son amortiguadores ajustables GasSLX. | Les numéros de pièce Gabriel imprimés en BLEU sont des amortisseurs ajustables GasSLX.

★ Will be available in first quarter of 2011.

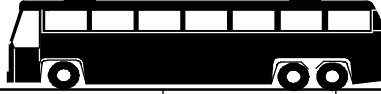











Gabriel®

Year Año Année	Model Modelo Modèle	O.E.M. #	Mount 	Front Delantero Avant	Rear Trasero Arrière
----------------------	---------------------------	----------	--	-----------------------------	----------------------------



DIAMOND T

	Models with O.E.M. Number	5549925		85304
--	---------------------------	---------	---	-------	-------

DIAMOND-REO



	All w/Velvet Ride Suspension		85307
	C054, C088 w/FH or FL Axle		85307
	C054, C088, C114, C116 w/FF Axle	220-55-1		83214
		220-55-6		83214
	C090, C090D, C101	220-55-2		85304
		220-55-7		85304
	C114, C116 w/FH or FL Axle	220-55-2		85304
		220-55-7		85304
	CF Series	220-55-8		83217
	DC101	220-55-2		85304
		220-55-7		85304

DINA BUS

	Marco Polo Viaggio GV 1000				
	- Drive Axle	39390339-6		85302 or 89420
	- Front Shock	39380353-6		85716
	- Tag Axle	39390340-4		85716

DODGE TRUCK

D Series- Conventional Cab 4 x 2

1974-78	D-500, D-600, D-700, D-800	3633643		G60028
1973	D-500, D-600, D-800	2516009		G60028

LN & LNT- Conventional Cab

1964-72	LN, LV Series	2516009		G60028
---------	---------------	---------	---	-------	--------

LNT, LVT, NLT, VLT- Tilt Cab 6 x 4

1964-73	LNT, LVT Series	2516009		G60028
---------	-----------------	---------	---	-------	--------



LS & LT- Steel Tilt Cab

1973-75	LS-1000, LT-1000	2516009		G60028
---------	------------------	---------	---	-------	--------

Motorhome Chassis

1973-81	M & R-300, 400, 500 Motorhome Chassis	3638112 3638631	  G60119	G60028
1963-72	M-300, M-375 & R-375 Motorhome Chassis	2961043 3633744	 	G60028 G60028
1977-81	M-6 Motorhome Chassis	3638112 4036892	  G60119	G60028

P Series - Forward Control

1972-82	P-300		G60028
1963-78	P-400		G60028
1963-71	PC-500 and PC-600, PD-500 and PD-600		G60028

Gabriel Part Numbers that appear in BLUE are GasSLX, adjustable shocks. \ Los números de parte Gabriel imprimidos en AZUL son amortiguadores ajustables GasSLX. \ Les numéros de pièce Gabriel imprimés en BLEU sont des amortisseurs ajustables GasSLX.

★ Will be available in first quarter of 2011.



Gabriel®

Year Año Année	Model Modelo Modèle	O.E.M. #	Mount 	Front Delantero Avant	Rear Trasero Arrière
----------------------	---------------------------	----------	-----------	-----------------------------	----------------------------

DODGE TRUCK ... cont'd

School Buses

1961-71	S-400, S-500, S-600	G60028
1972-73	S-500, S-600	2516009		G60028
1974-78	S-600, S-700	3633643		G60028

W-Series And Power Wagons

1961-72	W-500, WT-500 Series	G60028
1974-78	W-600 Series	3633643		G60028
1973	W-600 Series	2516009 2960707	 G60028	G60028

DUPLEX TRUCK

	Models with O.E.M. Number	59024 7604-3371		83204 83204	83204 83204
--	---------------------------	--------------------	--	----------------	----------------

DURA SUSPENSION

	Models with O.E.M. Number	1080099 12866 59024 59030 665133 665267 7604-3371 A-2212		83203 or 89436 83207 or 89407 83204 83203 or 89436 83203 or 89436 85029 83204 85029
--	---------------------------	---	--	--	--

EAGLE MOTOR COACH

	Buses with Rubber Torsion Suspension	6-05-5		85307
	Buses with Steel Spring Suspension	5532026		85304	85304
	Models with O.E.M. Number	01-0100-020 01-0100-905 014-0100-905 101364 154-0100-514 5394467 680091 70039 70041		85307 85303 or 89422 85308 or 89422 85305 85314 or 89425 85305 85303 or 89422 85303 or 89422 85305	85307 85303 or 89422 85305 85305 85303 or 89422 85303 or 89422 85305
	Additional O.E.M. Interchanges	0140100-905 12B-5-1 12J-5-10 690060		85308 or 89422 85700 85733 85713	

Gabriel Part Numbers that appear in BLUE are GasSLX, adjustable shocks. \ Los números de parte Gabriel imprimidos en AZUL son amortiguadores ajustables GasSLX. \ Les numéros de pièce Gabriel imprimés en BLEU sont des amortisseurs ajustables GasSLX.



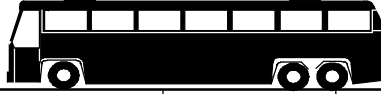









★ Will be available in first quarter of 2011.



Gabriel®

Year Año Année	Model Modelo Modèle	O.E.M. #	Mount 	Front Delantero Avant	Rear Trasero Arrière
----------------------	---------------------------	----------	--	-----------------------------	----------------------------

























EAST MANUFACTURING CORP.

Trailers with East Trailer part number	517-05001-18		87015
	517-05001-23		85005 or 89430
	517-05006-20		85030 or 89440
	517-05009-14		83125
	517-05010-07		83214
	517-05022-07		83217
	517-05110-20		85000 or 89436
	517-05511-14		83128
	517-05805-20		85000 or 89436
	517-05806-20		85029
	517-05808-20		85738
	517-05809-20		89437
	517-05916-14		83124 or 89407
When using the shock absorber stamping number, identification of the trailer suspension is necessary to determine what section of the catalog to refer to. Some possible options can be Chalmers, Hendrickson, Neway, Ridewell, Reyco.				

FLUIDRIVE

Models T950-1200, -1400, -1700	2697		85712
--------------------------------	------	---	-------	-------

FLXIBLE BUS

29 Passenger & Vista Coach		83217	83217
2-Level Intercity Bus		85736	85736
City Bus - 51 Passenger	6-05-1		85736
	6-05-2		85736
	6-05-3		85736
	6-05-4		85736
	6-05-5		85307
	6-05-6		85736
	6-05-7		85736
	6-05-8		85736
City Bus - 51 Passenger with Rubber Torsion Suspension	6-05-1		85736
	6-05-2		85736
	6-05-3		85736
	6-05-4		85736
	6-05-5		85307
	6-05-6		85736
	6-05-7		85736
	6-05-8		85736
CNG Bus (Natural Gas)	87-2519-00002		85731
	87-2519-00004		85731
	87-2520-00002		85730
	87-2520-00004		85730
	97-2201-00008		85731
	97-2210-00010		85730

Gabriel Part Numbers that appear in BLUE are GasSLX, adjustable shocks. \ Los números de parte Gabriel imprimidos en AZUL son amortiguadores ajustables GasSLX. \ Les numéros de pièce Gabriel imprimés en BLEU sont des amortisseurs ajustables GasSLX.

★ Will be available in first quarter of 2011.



Year Año Année	Model Modelo Modèle	O.E.M. #	Mount 	Front Delantero Avant	Rear Trasero Arrière
----------------------	---------------------------	----------	-----------	-----------------------------	----------------------------

FLXIBLE BUS ... cont'd

Model 870 Flex Bus, Metro	22024062		85701
	22024506		85703
	22025066		85703
	4975518		85704
	74412		85704
	87-2519-00001		85703
	87-2519-00003		85703
	87-2520-00001		85704
	87-2520-00003		85704
	97-2201-00003		85703
	97-2201-00005		85703
	97-2201-00006		85703
	97-2201-00007		85703
	97-2201-00009		85703
	97-2210-00001		85704
	97-2210-00002		85704
	97-2210-00003		85704
	97-2210-00004		85704
	97-2210-00005		85704
	97-2210-00006		85704
97-2210-00009		85704	
97-2210-00011		85704	
Models with O.E.M. Number	22012067		85700	85700
	22012114		85700	85700
	22024061		85704
	22025067		85704
	22025305		85704
	3166657		85700	85700
	3192333		85700	85700
	6-05-13		85304
	6-05-9		85304
	6-367-12		85700	85700
	6-367-14		85700	85700
	6-367-16		85700	85700
	6-367-8		85700	85700
	695125		85704
	87-2519-00001		85703
	97-2201-00001		85703
	97-2201-00002		85703
	97-2201-00004		85703
	97-2201-00151		85700	85700
	97-2210-00170		85733	85733
97-9999-02592		85710	
Additional O.E.M. Interchanges	015813		85708	
	06-0367-00151		85700	
	06-0367-00156		85702	
	06-0367-00157		85701	
	48-1-239		85736	
	48-1-241		85712	
	6-05-10		85734	
	6-367-1		85711	
6-367-11		85711		

Gabriel Part Numbers that appear in BLUE are GasSLX, adjustable shocks. | Los números de parte Gabriel imprimidos en AZUL son amortiguadores ajustables GasSLX. | Les numéros de pièce Gabriel imprimés en BLEU sont des amortisseurs ajustables GasSLX.



























★ Will be available in first quarter of 2011.













Gabriel®

Year Año Année	Model Modelo Modèle	O.E.M. #	Mount 	Front Delantero Avant	Rear Trasero Arrière
----------------------	---------------------------	----------	---	-----------------------------	----------------------------

FLXIBLE BUS ... cont'd





Year	Model	O.E.M. #	Mount	Front	Rear
	Additional O.E.M. Interchanges	6-367-17		85700	
		6-367-2		85736	
		6-367-3		85304	
		6-367-4		83217	
		6-367-6		85711	
		6-367-7		85305	
		6-367-9		85711	
		680029		85301	
		680155		85712	
		97-2210-00153		85701	
		97-2210-00156		85702	
		97-2210-00157		85708	
		97-2210-00160		85705 or 89447	
		97-2210-00162		85701	
		97-2210-00164		85708	
		97-9999-00732		85707	
		97-9999-02514		85700	
		97-9999-02515		85702	
		97-9999-02516		85701	
		97-9999-02519		85707	
		97-9999-02595		85313	
		97-9999-02632		85711	
		97-9999-02633		85311 or 89424	
		97-9999-02634		85733	
		97-9999-02635		85718	
		97-9999-02636		85716	
		97-9999-807		85307	

FLYER INDUSTRIES

Year	Model	O.E.M. #	Mount	Front	Rear
	Coaches with Low Floor	009863		85722
		15813		85708
	Additional O.E.M. Interchanges	015915		85711	
		22012067		85700	
		22012114		85700	
		3166657		85700	
		3192333		85700	
		4975501		85700	
		4975552		85711	
		592-6568		85700	
		5979574		85700	

FORD

AeroMax (A, AT, AAT, 8500, 9500) Series

Year	Model	O.E.M. #	Mount	Front	Rear
1996	8000 Series with 12000 or 13000 lb Axles	F6HT-18045-LA		85376
1996	8000 Series with 16000 lb. Multileaf Spring	F6HT-18045-AA		85054 or 89438
1996-97	9500 (113" & 122" BBC) Series with 10000 lb Axle and 54" Multileaf Spring	F6HT-18045-KA		83200
1996-	9500 (113" & 122" BBC) Series with 12000 or 13200 lb Axle and 54" Multileaf Spring	F6HT-18045-BC		85047 or 89435
1996-97	9500 (113" & 122" BBC) Series with 8500 or 9000 lb Axle and 54" Taperleaf Spring	F6HT-18045-HC		85054 or 89438

Gabriel Part Numbers that appear in BLUE are GasSLX, adjustable shocks. \ Los números de parte Gabriel imprimidos en AZUL son amortiguadores ajustables GasSLX. \ Les numéros de pièce Gabriel imprimés en BLEU sont des amortisseurs ajustables GasSLX.

★ Will be available in first quarter of 2011.



Year Año Année	Model Modelo Modèle	O.E.M. #	Mount 	Front Delantero Avant	Rear Trasero Arrière
----------------------	---------------------------	----------	-----------	-----------------------------	----------------------------

FORD ... cont'd

1996-	All Models with 10000 lb or 12000 lb Axle and 54" Taperleaf Spring	F6HT-18045-AC		85054 or 89438
		F6HZ-18124-A		85054 or 89438
1996-	All with 12000 lb, 13000 lb or 14600 lb Axle and 60" Taperleaf Spring	F6HT-18045-EB		85055 or 89439
		F6HT-18045-EC		85055 or 89439
		F6HZ-18124-D		85055 or 89439
		F6HZ-18124-E		85055 or 89439
		F6HZ-18124-F		85055 or 89439
1996-	All with 13200 lb or 14600 lb Axle and 54" Taperleaf Spring	F6HT-18045-GB		85030 or 89440
		F6HT-18045-GC		85030 or 89440
		F6HZ-18124-G		85054 or 89438
1996-	All with 21000 lb or 23000 lb Axle and 46" Taperleaf spring	F5HZ-18125-B		85001 or 89410
1996-	All with 23000 lb Axle and 52" Taperleaf spring	F5HZ-18125-A		85314 or 89425
1996-97	All with Hendrickson 40LH Model Tandem Axle	57241-2		83109
		F6HT-18080-DA		83109
		F6HZ-18125-B		83109
1996-97	All with Hendrickson HAS-400, HA-210 or HA-230 Air Suspension	47902-28		85013 or 89414
		F6HZ-18080-FC		85013 or 89414
		F6HZ-18125-D		85013 or 89414
1996-97	All with Neway AD-123 Air Suspension	90045068		89441
		F6HZ-18125-C		89441
1996-97	With Neway AD-246 Air Suspension	90045099		85906
		90045132		85909

B - Series - Bus Cowl Chassis

1970-79	B - 500, B - 600, B - 700, B - 750	D2TF-18045-GA		83308
		D7HT-18045-GA		83308
1961-79	B - 500, B - 600, B - 700, B - 750	D2TF-18080-HA		83225
		D7HT-18080-BA		83225
1961-69	B - 500, B - 600, B - 700, B - 750 with 4000, 4700 and 5000 lb Axle		83400
1961-69	B - 500, B - 600, B - 700, B - 750 with 6000 & 7000 lb Axle	C2TA-18045-A		83216
1977-96	B - 600, B - 700, B - 750, B - 800, B - 7000 with 18500 lb Axle	D7HT-18080-AA		83215
1986-90	B - 600, B - 700, B - 800, B - 7000	E0HT-18080-AA		83215
1980-96	B - 600, B - 700, B - 800, B - 7000	D7HT-18080-DA		83215
		E0HT-18045-AA		83309 or 89446
		E0HT-18045-AB		83309 or 89446
		E0HT-18080-AA		83215
		F1HT-18045-AA		83309 or 89446
1977-79	B - 600, B - 750, with 18500 lb Axle	D7HT-18080-DA		83215

Gabriel Part Numbers that appear in BLUE are GasSLX, adjustable shocks. | Los números de parte Gabriel imprimidos en AZUL son amortiguadores ajustables GasSLX. | Les numéros de pièce Gabriel imprimés en BLEU sont des amortisseurs ajustables GasSLX.

★ Will be available in first quarter of 2011.

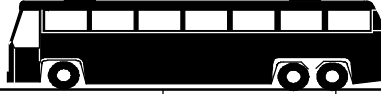















Gabriel®













Year Año Année	Model Modelo Modèle	O.E.M. #	Mount 	Front Delantero Avant	Rear Trasero Arrière
----------------------	---------------------------	----------	---	-----------------------------	----------------------------

FORD ... cont'd





C & CT Series - Tilt Cab

1971-73	C-500, C-550, C-600, C-650, C-700, C-750 with 6000 & 7000 lb Axle	D1TF-18045-LA		83312 or 89409
1964-67	C-550, C-600 with 6000 lb Axle - and Power Steering	C2TA-18045-A		83216
1964-67	C-550, C-600 with 6000 lb Axle - Exc. with Power Steering	C6PF-18077-A		G60021
1964-67	C-550, C-600, C-650, C-700, C-750	C6PF-18077-F		83225
1967-69	C-600, C-650, C-700, C-750, C-800, C-850, C-1000 with 7000, 9000, 11000, 12000, 15000 lb Axles - Exc. with 175" Wheel Base	D2HF-18045-CA		83308
1967-71	C-600, C-650, C-700, C-750, C-800, C-850, C-1000 with 7000, 9000, 11000, 12000, 15000 lb Axles and 175" Wheel Base	C8HA-18045-A		83312 or 89409
1980-90	C-600, C-700, C-7000, C-800, C-8000, CT-800, CT-8000 with 3100 lb Spring and 7000 lb Axle	D7HT-18045-JA		83308
1976-79	C-600, C-700, C-750, C-800, C-900, CT-800, CT-900	D2EF-18045-AA D7KF-18045-EA	 	83312 or 89409 83312 or 89409
1980-90	C-600, C-700, C-800, C-7000, CT-800, CT-8000 with 4040, 5040 lb Springs and 7000, 9000, 12000 lb Axles	D2EF-18045-AA		83312 or 89409
1964-66	C700/1100, CT-700/1100 with 7000, 9000, 11000, 15000 lb Axles	D2HF-18045-CA		83308
1972-79	C-750, C-800, C-850, C-900, CT-750, CT-800, CT-850, CT-900 with 9000, 11000, 12000 & 15000 lb Axle	D2KF-18045-AA		83312 or 89409
1972-75	C-800, C-850, C-900, CT-800, CT-850, CT-900 with 11000, 12000 lb Axle	D1TF-18045-LA		83312 or 89409
1969-71	C-800, C-850, C-900, CT-800, CT-850, CT-900, CT-950 with 9000, 11000, 12000 & 15000 lb Axle	C8HA-18045-A		83312 or 89409

CF Series (Brazilian Built)

1986-89	CF - 600, CF - 700	E5HT-18045-AA E5HT-18080-DA E5HT-18080-EA	  	85301 85315 85315
1992-97	CF-7000, CF-8000 or CFT-8000 Series	F6HT-18045-LA		85376
1996-97	CF-7000, CF-8000 or CFT-8000 Series with 16000 lb. Multileaf Spring	F6HT-18045-AA		85054 or 89438
1986-97	CF-7000, CF-8000 with 12000 lb or 13000 lb Axle 87HU-18045-AA E5HT-18045-AA E6HZ-18124-A E7HZ-18124-A	     85301 85301 85301 85301	85302 or 89420
1992-97	CF-7000, CF-8000 with 9000 lb Axle	F2HT-18045-BA F2HT-18045-CA F2HZ-18124-A	  	85376 85376 85376

CL & CLT Series - Highway Tractor Tilt Cab

1978-89	CL-9000, CLT-9000	D7HT-18045-NA		85301
1978-89	CL-9000, CLT-9000 with Cab Suspension Unit (4 req'd)	D8HT-18A160-AB	
1990-91	CL-9000, CLT-9000 with Multileaf Spring	F1HT-18045-NA		85040
1978-89	CL-9000, CLT-9000 with Rear Tandem Axle with Neway Suspension	D7HA-18080-AA		83123 or 89405
1978-89	CL-9000, CLT-9000 with Single Rear Axle Suspension	D4HA-18080-AA		83209 or 89414

Gabriel Part Numbers that appear in BLUE are GasSLX, adjustable shocks. \ Los números de parte Gabriel imprimidos en AZUL son amortiguadores ajustables GasSLX. \ Les numéros de pièce Gabriel imprimés en BLEU sont des amortisseurs ajustables GasSLX.

★ Will be available in first quarter of 2011.



Year Año Année	Model Modelo Modèle	O.E.M. #	Mount 	Front Delantero Avant	Rear Trasero Arrière
----------------------	---------------------------	----------	-----------	-----------------------------	----------------------------

FORD ... cont'd

	Models with Hendrickson Rear Air Suspension	47902-13		83122 or 89406
	Models with O.E.M. Number	D4HA-18080-AA		83209 or 89414

F Series - Conventional Cab

1964-66	F-1000 Diesel with 11000, 12000 lb Axles	C1TT-18045-D		G60007
1964-66	F-1000 with 15000 lb Axle	C1TT-18045-D		G60007
1970-77	F-500	D2HT-18045-GA D2TF-18045-GA	 	83308 83308
1967-69	F-500	C8TA-18045-AA		G60023
1964-77	F-500	C7PF-18077-A D2TF-18080-HA	 	83225 83225
1964-69	F-500	C2TA-18045-A		83216
1964-79	F-600 (2 x 4), F-650, F-700, F-750	C7PF-18077-A D2TF-18080-HA D7HT-18080-BA	 	83225 83225 83225
1971-79	F-600 (4 x 4)	D2HT-18045-GA D2TF-18045-GA	 	83308 83308
1980-94	F-600, F-6000, F-700, F-7000, F-800, F-8000, FT-700, FT-800, FT-8000 - Exc. 9000 lb Axle with H.D. Suspension & 12000 lb Axle	E0HT-18045-AA E0HT-18045-AB	 	83309 or 89446 83309 or 89446
1983-89	F-600, F-6000, F-700, F-7000, F-800, F-8000, FT-700, FT-800, FT-8000 with 9000 lb Axle with H.D. Suspension & 12000 lb Axle	D2HF-18045-AA D7HT-18045-CA	 	83314 83314
1970-79	F-600, F-650, F-700, F-750 with 5500, 6000, 7000 & 9000 lb Axles	D2HT-18045-GA D2TF-18045-GA	 	83308 83308
1967-69	F-600, F-650, F-700, F-750 with 5500, 6000, 7000 & 9000 lb Axles	C8TA-18045-AA		G60023
1964-67	F-600, F-700, F-750	C7PF-18077-A		83225
1964-69	F-600, F-700, F-750 with 6000 & 7000 Axle	C2TA-18045-A		83216
1986-90	F-600, F-700, F-800	AX-310 E6HT-18080-AA E6HZ-18125-D	 	83215 83215 83215
1980-90	F-600, F-700, F-800 with 13000 & 15000 lb Rear Axle	D7HT-18080-BA		83225
1980-90	F-600, F-700, F-800 with 17000 & 18000 lb Rear Axle	D7HF-18080-AA D7HT-18080-DA	 	83215 83215
1990	F-600, F-700, F-800, FT-800, FT-900, with Multileaf Spring	F1HT-18045-AA		83309 or 89446
1989-94	F-600, F-700, LPO (Low Profile Vehicle)	E9HS-18045-AA E9HS-18080-AA	 	83309 or 89446 85716
1976-79	F-700	D2TF-18045-AA		83312 or 89409
1973-79	F-700 (Diesel), F-750 with 9000 lb Axle	D2EF-18045-AA D7HT-18045-BA	 	83312 or 89409 83312 or 89409
1971-72	F-700 (Diesel), F-750 with 9000 lb Axle	D2HF-18045-CA		83308
1970	F-700 with 9000 lb Axle	D2HF-18045-CA		83308

Gabriel Part Numbers that appear in BLUE are GasSLX, adjustable shocks. \ Los números de parte Gabriel imprimidos en AZUL son amortiguadores ajustables GasSLX. \ Les numéros de pièce Gabriel imprimés en BLEU sont des amortisseurs ajustables GasSLX.



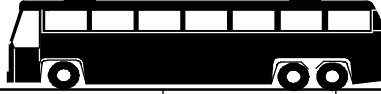























★ Will be available in first quarter of 2011.















Gabriel®

Year Año Année	Model Modelo Modèle	O.E.M. #	Mount 	Front Delantero Avant	Rear Trasero Arrière
----------------------	---------------------------	----------	--	-----------------------------	----------------------------

FORD ... cont'd

1990-97	F-700, F-800	AX-310 E6HT-18080-AA E6HZ-18125-D	  	83215 83215 83215
1994 - 98	F-700, F-800 with 15000, 17500, 19000 lb Taperleaf Springs	F4HT-18080-AA F4HT-18080-AB F5HZ-18125-A	  	85314 or 89425 85314 or 89425 85314 or 89425
1994-97	F-700, F-800 with 21000 lb Taperleaf Springs	F4HT-18080-BA		85001 or 89410
1995-97	F-700, F-800 with 52" or 54" Taperleaf Springs and with 10000 or 12000 lb Axle	F5HZ-18124-C		85063
1994-97	F-700, F-800 with Multileaf Spring and 14600 lb Axle	F4HT-18045-EA F5HZ-18124-D	 	83125 83125
1994-97	F-700, F-800 with Multileaf Spring and with 10000, 12000 or 13200 lb Axle	F4HT-18045-CB F5HZ-18124-B	 	83107 83107
1994-97	F-700, F-800 with Taperleaf Springs and with 10000 or 12000 lb Axle	F4HT-18045-DA		85063
1994 - 98	F-700, F-800 with Taperleaf Springs and with 6000, 7000, 8500, 9000 lb Axle	F4HT-18045-AB F4HT-18045-AC F5HZ-18124-A	  	83314 83314 83314
1976-79	F-800	D2HT-18080-HA D2TF-18045-AA D2TF-18045-GA D7HT-18045-GA D7HT-18080-BA	     83312 or 89409 83308 83308	83225 83225
1978-79	F-800 with 9000 lb Axle	D2EF-18045-AA D7HT-18045-BA	 	83312 or 89409 83312 or 89409
1964-66	F-800, F-850-,F-900, F-950, F-1000 - Exc. Diesel with 11000 CP Axle	C1TT-18045-D		G60007
1964-69	F-800, F-850-,F-900, F-950, F-1000 with 6000, 7000, 9000, 11000, 12000, 15000, 18000 lb Axles (Exc. Diesel with 6000 and 7000 lb Axles)	C1TT-18045-C C6PF-18077-DL	 	83312 or 89409 83312 or 89409
1964-69	F-950, F-1000, F-1100 Diesel with 7000 lb Axle	C6PF-18077-DN		83314

F Series - F550, F650, F750 Models

1999-	F-550 with single or dual rear wheels with 165" or 201" wheel base	AT-611 F81A-18080-DCA F81Z-18125-DC	  	G60084 G60084 G60084
- 2009	F-650 with 21,000 lb Rear Air Suspension	3578858C1		85926
2005 - 10	F-650 with 22,000 lb Rear Spring Suspension	4C4Z-18125-B 501906C92	 	83317 83317
2000	F-650 with 8500 lb Front Axle	AA-494 XC35-18045-JA XC3Z-18124-JA	  	83131 83131 83131
2005 - 07	F-650 with O.E.M. Number	3553628C1 3553628C2	 	85927 85927
2004-08	F-650 with O.E.M. Number	AT-811 FC4Z-18124-HB	 	83135 83135















Gabriel Part Numbers that appear in BLUE are GasSLX, adjustable shocks. \ Los números de parte Gabriel imprimidos en AZUL son amortiguadores ajustables GasSLX. \ Les numéros de pièce Gabriel imprimés en BLEU sont des amortisseurs ajustables GasSLX.

★ Will be available in first quarter of 2011.





















**Gabriel®**

Year Año Année	Model Modelo Modèle	O.E.M. #	Mount 	Front Delantero Avant	Rear Trasero Arrière
----------------------	---------------------------	----------	--	-----------------------------	----------------------------



FORD ... cont'd

2004 - 10	F-650 with O.E.M. Number	3584117C2		83135
		4C4Z-18124-P		83135
		AA-615		83135
- 2009	F-750 with 21,000 lb Rear Air Suspension	3578858C1		85926
2005 - 10	F-750 with 22,000 lb Rear Spring Suspension	4C4Z-18125-B		83317
		501906C92		83317
2000	F-750 with 23000 lb Multi-leaf Rear Springs	AT-696		83140
		F81A-18080-ZC		83140
		F81Z-18125-ZA		83140
2000	F-750 with 9000 lb Front Axle	XC35-18045-AB		83131
2005 - 10	F-750 with O.E.M. Number	3584118C2		85957
		4C4Z-18124-RA		85957
		AA-617		85957
2005 - 07	F-750 with O.E.M. Number	3553628C1		85927
		3553628C2		85927

FT Series - Conventional Cab

1990-94	FT-900 (Low Profile Vehicle)	E9HS-18045-AA		83309 or 89446
		E9HZ-18124-A		83309 or 89446
1990-92	FT-900 (Low Profile Vehicle)	E9HS-18080-AA		85716
1994-97	FT-900 with 46" Taperleaf Spring and 15000, 17500 or 19000 lb Axle	F4HT-18080-AA		85314 or 89425
		F4HT-18080-AB		85314 or 89425
		F5HZ-18125-DA		85314 or 89425
1994-97	FT-900 with 46" Taperleaf Springs and 21000 lb Axle	F4HT-18080-BA		85001 or 89410
1995-97	FT-900 with 52 or 54" Taperleaf Springs and with 10000 or 12000 lb Axle	F5HZ-18124-C		85063
1990-94	FT-900 with 9000 lb Axle with H.D. Suspension or 10000, 11000, or 12000 lb Axles	E9HS-18045-AA		83309 or 89446
		F1HT-18045-AA		83309 or 89446
		F1HZ-18124-A		83309 or 89446
1994-97	FT-900 with Multileaf Spring and 14600 lb Axle	F4HT-18045-EA		83125
		F5HZ-18124-D		83125
1994-97	FT-900 with Multileaf Spring and with 10000, 12000 or 13200 lb Axle	F4HT-18045-CB		83107
		F5HZ-18124-B		83107
1990-97	FT-900 with shock located forward of rear axle	AX-310		83215
		E6HT-18080-AA		83215
		E6HZ-18125-D		83215
1994-97	FT-900 with Taperleaf Spring and with 10000 or 12000 lb Axle	F4HT-18045-DA		85063
1994-97	FT-900, with Taperleaf Springs and with 6000, 7000, 8500 or 9000 lb Axles	F4HT-18045-AB		83314
		F5HZ-18124-A		83314

H and HT Series - Hi Tilt Cab

1961-63	HT-950 with 11000 lb Axle		83314
1961-66	HT-950 with 12000 & 15000 lb Axle		83314

Gabriel Part Numbers that appear in BLUE are GasSLX, adjustable shocks. \ Los números de parte Gabriel imprimidos en AZUL son amortiguadores ajustables GasSLX. \ Les numéros de pièce Gabriel imprimés en BLEU sont des amortisseurs ajustables GasSLX.

★ Will be available in first quarter of 2011.

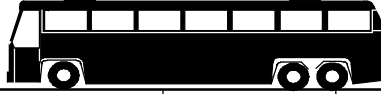





















Gabriel®







Year Año Année	Model Modelo Modèle	O.E.M. #	Mount 	Front Delantero Avant	Rear Trasero Arrière
----------------------	---------------------------	----------	---	-----------------------------	----------------------------

FORD ... cont'd

L, LT & LTS - Conventional Cab

1976-81	L-800	D2EF-18045-AA		83312 or 89409
		D7HT-18045-BA		83312 or 89409
1973-90	L-800, L8000, L-900, L-9000, LT-800, LT-880, LT8000, LT-900, LT-9000 with 7000, 9000, 12000 lb Axles	D2KF-18045-AA		83312 or 89409
		D7HF-18045-FA		83312 or 89409
1973-85	L-800, L8000, L-900, L-9000, LT-800, LT-880, LT8000, LT-900, LT-9000, LTS-8000, LTS-900, LTS-9000 with 7000, 9000, 12000, 16000 lb Axles	D2HF-18045-AA		83314
		D2HT-18045-CA		83314
1973-90	L-800, L850, L-900, L-9000, LT-800, LT-850, LT880, LT-900, LT-9000, LTS-800, LTS-850, LTS-900 with 7000, 9000, 12000, 16000 lb Axles	D2HF-18045-BA		83309 or 89446
		D7HT-18045-DA		83309 or 89446
1994-97	L-8000, L-9000, LT-8000 or LT-9000 Series with 21000 or 23000 lb. with 46" Taperleaf Spring	F4HT-18080-BA		85001 or 89410
1991-92	L-8000, L-9000, LT-8000, LT-9000 with 52" Taperleaf Spring	F1HT-18045-GB		89403
1990-97	L-8000, L-9000, LT-8000, LT-9000 with 52" Taperleaf Spring	F1HT-18045-GA		85006 or 89401
1990-97	L-8000, L-9000, LT-8000, LT-9000 with 58" Parabolic Taperleaf Spring	F1HT-18045-RA		89402
		F1HT-18045-RB		89402
	L-8000, L-9000, LT-8000, LT-9000 with Hendrickson Rear Air Suspension	47902-13		83122 or 89406
1991-97	L-8000, L-9000, LT-8000, LT-9000 with Multileaf Spring	F1HT-18045-DA		83312 or 89409
1991-97	L-8000, L-9000, LT-8000, LT-9000 with 4000, 4500, 5400, 6000, 7200 lb Multileaf Springs and with 9000, 10000, 12000 or 16000 lb Axles	F1HT-18045-CB		83216
1991-97	L-8000, L-9000, LT-8000, LT-9000 with 4500, 5400, 6000, 7200, 10000 lb Multileaf Springs and with 10000, 12000, 13200, 16000 lb Axles	F1HT-18045-DB		83308
1973-89	LTS-800, LTS-850, LTS-900, LTS-9000 with 16000 lb Axle	D0HA-18045-E		83312 or 89409
		D2HF-18045-DA		83312 or 89409
		D7HT-18045-EA		83312 or 89409

LA, LS & LST - Conventional Cab

1996	LA-8000 Series with 12000 or 13000 lb Axles	F6HT-18045-LA		85376
1996	LA-8000 Series with 16000 lb. Multileaf Spring	F6HT-18045-AA		85054 or 89438
1991-96	LA-8000, LA-9000 Series with 4000, 4500, 5400, 6000, or 7200 lb. Multileaf Spring	F1HT-18045-CB		83216
1991-96	LA-8000, LA-9000 Series with Hendrickson Rear Air Suspension	47902-28		85013 or 89414
1990-97	LA-8000, LA-9000, LS-8000, LST-8000 with 4500 lb to 10000 lb Multileaf Spring	F1HT-18045-CA		83308
1990-97	LA-8000, LS-8000, LST-8000 with 52" Taperleaf Spring	F1HT-18045-EA		89402
1991-96	LA-8000, LS-8000, LST-8000 with 58" Taperleaf Spring	F1HT-18045-EB		89402

Gabriel Part Numbers that appear in BLUE are GasSLX, adjustable shocks. \ Los números de parte Gabriel imprimidos en AZUL son amortiguadores ajustables GasSLX. \ Les numéros de pièce Gabriel imprimés en BLEU sont des amortisseurs ajustables GasSLX.

★ Will be available in first quarter of 2011.

**Gabriel®**

Year Año Année	Model Modelo Modèle	O.E.M. #	Mount 	Front Delantero Avant	Rear Trasero Arrière
----------------------	---------------------------	----------	-----------	-----------------------------	----------------------------

FORD ... cont'd**LL, LLA, LTA, LTL, LTLA - Conventional Cab**

1991-95	LL-9000 with 4500, 5000, 6000 lb Springs and with 10000, 11000, 12000 lb Axles	F1HT-18045-DB		83308
1991-96	LL-9000, LLA-9000, LTA-9000, LTLA-9000, with 4000, 4500, 5400, 6000 or 7200 lb Multileaf Springs and with 9000, 10000, 12000 or 16000 lb Axles	F1HT-18045-CB		83216
1991-96	LLA-9000, LTLA-9000 with 4500, 5400, 6500 lb 58" Parabolic Taperleaf Spring	F1HT-18045-HB		85006 or 89401
1991-95	LLA-9000, LTLA-9000 with 4500, 5400, 6500 lb 58" Parabolic Taperleaf Spring	F1HT-18045-CB		83216
1990	LLA-9000, LTLA-9000 with 4500, 5400, 6500 lb 58" Parabolic Taperleaf Spring	F0HT-18045-CA		85006 or 89401
1991-96	LTA-9000, LLA-9000 or LTLA-9000 Series with 4500, 5400, 6000, 7200 or 10000 lb. Multileaf Spring	F1HT-18045-CA		83308
1991-96	LTA-9000, LLA-9000 or LTLA-9000 Series with Hendrickson Rear Air Suspension	47902-28		85013 or 89414
1980-85	LTL-900, LTL-9000 with 7000, 9000, 12000 lb Axle	D2HF-18045-AA		83314

LN & LNT - Conventional Cab

1972	LN-500, LN-550 with 11000, 13000, 15000, 17000 lb Axles	D2TF-18080-HA		83225
1970-72	LN-500, LN-550 with 5000, 5500, 6000 & 7000 lb Axles	D2TF-18045-GA		83308
1972-79	LN-600, LN-650, LN-700, LN-750 with 11000, 13000, 15000, 17000 lb Axles	D2TF-18080-HA		83225
1970-79	LN-600, LN-650, LN-700, LN-750 with 5000, 5500, 6000 & 7000 lb Axles	D7HT-18045-GA		83308
1976-79	LN-600, LN-650, LN-700, LN-800	D2EF-18045-AA		83312 or 89409
1976-79	LN-600, LN-650, LN-700, LN-801	D7HT-18045-BA		83312 or 89409
1980-89	LN-600, LN-700, LN-7000, LN-800, LN-8000, LNT-800, LNT-8000 with 3000, 3300 lb Springs and 5000, 5500, 6000, 7000 lb Axles	D7HT-18045-GA		83308
1980-89	LN-600, LN-700, LN-7000, LN-800, LN-8000, LNT-800, LNT-8000 with 4400 lb Spring and 7000, 9000 lb Axles	D2EF-18045-AA		83312 or 89409
1980-89	LN-600, LN-700, LN-750 with 11000, 13000, 15000, 17000 lb Axles	D7HT-18080-BA		83225
1970-75	LN-700, LN-750 Diesel with 9000 lb Axle	C1TT-18045-C D2EF-18045-AA	 	83312 or 89409 83312 or 89409
1994-97	LN-7000, LN-8000, LN-9000, LNT-8000 or LNT-9000 Series with 21000 or 23000 lb. with 46" Taperleaf Spring	F4HT-18080-BA		85001 or 89410
1991-97	LN-7000, LN-8000, LN-9000, LNT-8000 or LNT-9000 Series with 4000, 4500, 5400, 6000 or 7200 lb. Multileaf Springs and with 9000, 10000, 12000 or 16000 lb. Axles	F1HT-18045-CB		83216
1991-97	LN-7000, LN-8000, LN-9000, LNT-8000, LNT-9000 with 52" Taperleaf Spring	F1HT-18045-GB		89403
1990	LN-7000, LN-8000, LN-9000, LNT-8000, LNT-9000 with 52" Taperleaf Spring	F1HT-18045-GA		85006 or 89401
1990-97	LN-7000, LN-8000, LN-9000, LNT-8000, LNT-9000 with 58" Parabolic Taperleaf Spring	F1HT-18045-RA F1HT-18045-RB	 	89402 89402
1990	LN-7000, LN-8000, LN-9000, LNT-8000, LNT-9000 with 58" Parabolic Taperleaf Spring	F1HT-18045-RA		89402

Gabriel Part Numbers that appear in BLUE are GasSLX, adjustable shocks. | Los números de parte Gabriel imprimidos en AZUL son amortiguadores ajustables GasSLX. | Les numéros de pièce Gabriel imprimés en BLEU sont des amortisseurs ajustables GasSLX.



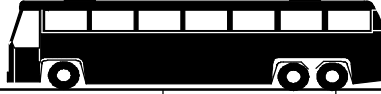







★ Will be available in first quarter of 2011.



















Gabriel®

Year Año Année	Model Modelo Modèle	O.E.M. #	Mount 	Front Delantero Avant	Rear Trasero Arrière
----------------------	---------------------------	----------	--	-----------------------------	----------------------------

FORD ... cont'd

	LN-7000, LN-8000, LN-9000, LNT-8000, LNT-9000 with Hendrickson Rear Air Suspension	47902-13 F0HT-18080-AA F0HZ-18125-A	  	83122 or 89406 85005 or 89430 85005 or 89430
1990-97	LN-7000, LN-8000, LN-9000, LNT-8000, LNT-9000 with Multileaf Spring	F1HT-18045-DA		83312 or 89409
1991-97	LN-7000, LN-8000, LN-9000, LNT-8000, LNT-9000 with 4500, 5400, 6000, 7200, 10000 lb Springs and with 10000, 12000, 13200, 16000 lb Axles	F1HT-18045-DB		83308
1976-81	LN-800, LN-8000, LN-900, LN-9000, LNT-800, LNT-8000, LNT-900, LNT-9000	D2HF-18045-AA D7HT-18045-CA	 	83314 83314
1976-77	LN-800, LN-8000, LN-900, LN-9000, LNT-800, LNT-8000, LNT-900, LNT-9000	D2KF-18045-AA		83312 or 89409
1970-71	LN-800, LN-850, LNT-900, with 7000, 9000, 12000 lb Axles	D2TF-18045-GA		83308
1970-89	LN-800, LN-850, LN-8000, LN-900, LN-9000, LNT-800, LNT-850, LNT-880, LNT-8000, LNT-900, LNT-9000 with 6000, 7000, 9000, 12000, 16000 lb Axles	D2HF-18045-BA D7HT-18045-DA	 	83309 or 89446 83309 or 89446

Louisville Series - Conventional Cab

1996-97	All Models with 10000 lb or 12000 lb Axle and 54" Taperleaf Spring	F6HT-18045-AC F6HZ-18124-A	 	85054 or 89438 85054 or 89438
1996-	All with 13200 lb or 14600 lb Axle with 54" Taperleaf Spring	F6HT-18045-GB F6HT-18045-GC F6HZ-18124-G	  	85030 or 89440 85030 or 89440 85054 or 89438
1996-	All with 54" Multi-leaf Spring and 14600 or 16000 lb Axle	F6HT-18045-CC F6HZ-18124-C	 	85055 or 89439 85055 or 89439
	All with 54" Multileaf Spring and with 12000 or 13200 lb Axle	F6HT-18045-BC		85047 or 89435
1996-97	All with 54" Multileaf Spring and with 8500 or 9000 lb Axle	F6HT-18045-JB F6HT-18045-JC F6HZ-18124-J	  	83200 83200 83200
1996-97	All with 60" Taperleaf Spring and 12000, 13000 or 14600 lb Axle	F6HT-18045-EB F6HT-18045-EC F6HZ-18124-D F6HZ-18124-E F6HZ-18124-F	    	85055 or 89439 85055 or 89439 85055 or 89439 85055 or 89439 85055 or 89439

Gabriel Part Numbers that appear in BLUE are GasSLX, adjustable shocks. \ Los números de parte Gabriel imprimidos en AZUL son amortiguadores ajustables GasSLX. \ Les numéros de pièce Gabriel imprimés en BLEU sont des amortisseurs ajustables GasSLX.

★ Will be available in first quarter of 2011.

**Gabriel®**

Year Año Année	Model Modelo Modèle	O.E.M. #	Mount 	Front Delantero Avant	Rear Trasero Arrière
----------------------	---------------------------	----------	-----------	-----------------------------	----------------------------

FORD ... cont'd

1996-97	All with 8500 lb or 9000 lb Axle with 54" Taperleaf Spring	F6HT-18045-HB		85054 or 89438
		F6HT-18045-HC		85054 or 89438
		F6HZ-18124-H		85054 or 89438
	All with Hendrickson HAS-400 Air Suspension	47902-28		85013 or 89414
		F6HZ-18080-FC		85013 or 89414
		F6HZ-18125-D		85013 or 89414
	All with Neway AD-123 Air Suspension	90045068		89441
		F6HZ-18125-C		89441
	With Neway AD-246 Air Suspension	90045099		85906
		90045132		85909

Motorhome Chassis

1973-76	M-400& M-500 Motorhome Chassis	83225
			85012 or 89413
1957-76	P-400 & 4000 Motorhome Chassis - Exc. H.D. Springs
1957-76	P-400 & 4000 Motorhome Chassis with H.D. Springs		85012 or 89413

N and NT 89" BBC Conventional Cab

1964-69	N-1100 with 11000 thru 15000 lb Axles	C6PF-18077-DN		83314
1964-69	N-500, N-550, N-600, N-650, N-700 with 5000, 6000, 7000 & 9000 lb Axles	D2TF-18045-GA		83308
1964-69	N-500, N-550, N-600, N-650, N-700, N-750	C7PF-18077-A		83225
		D2TF-18080-HA		83225
1964-67	N-600, N-650, N-700, N-750 with 6000 & 7000 lb Axle	C6PF-18077-DL		83312 or 89409
1967-69	N-750 with 9000 lb Axle	C1TT-18045-C		83312 or 89409
1964-69	N-800, N-850, N-900 Gas with 6000 & 7000 lb Axle	C6PF-18077-DL		83312 or 89409
1964-69	N-800, N-850, N-900, N-950 - Exc. Diesel with 6000 & 7000 lb Axle	C1TT-18045-C		83312 or 89409
1967-69	N-850, N-900, N-950 with 6000, 7000, 9000, 11000, 12000 lb Axles	C1TT-18045-C		83312 or 89409
1967-69	N-850, N-900, N-950, N-1000, NT-850, NT-900, NT-950, NT-1000 with 6000, 7000, 9000, 11000, 12000, 15000, 18000 lb Axles	C1TT-18045-D		G60007

P-Series - Parcel Delivery

1957-76	P-350 & 3500
1957-76	P-400 & 4000 - Exc. H. D. Springs
1957-76	P-400 & 4000 w/ H. D. Springs		85012 or 89413
1957-76	P500, P-5000	83225
			85012 or 89413
1978-79	P-600	D7HT-18045-HA		85012 or 89413
		D7HT-18080-CA		83225

Gabriel Part Numbers that appear in BLUE are GasSLX, adjustable shocks. \ Los números de parte Gabriel imprimidos en AZUL son amortiguadores ajustables GasSLX. \ Les numéros de pièce Gabriel imprimés en BLEU sont des amortisseurs ajustables GasSLX.

★ Will be available in first quarter of 2011.





Gabriel®









Year Año Année	Model Modelo Modèle	O.E.M. #	Mount 	Front Delantero Avant	Rear Trasero Arrière
----------------------	---------------------------	----------	--	-----------------------------	----------------------------

























FORD ... cont'd

T-Series - Conventional Tandem

1964-69	T-750, T-800, T-850, T-900, T-950 with 6000, 7000, 9000, 11000, 12000, 15000, 18000 lb Axles	C1TT-18045-D		G60007
1964-69	T-750, T-800, T-850, T-900, T-950 with 9000 thru 15000 lb Axles	C1TT-18045-E		83314
		C6PF-18077-DN		83314

W and WT Series - Hi Tilt Cab Highway Tractor

1966-71	W-900, W-950, W-1000, WT-900, WT-950, WT-1000 with 11000 lb Axle	D2HA-18045-E1A		85304
		D2HA-18045-E1B		85304
		D2HA-18045-E2A		85304
		D2HA-18045-E2B		85304
1966-71	W-900, W-950, W-1000, WT-900, WT-950, WT-1000 with 12000 & 15000 lb Axle	C6TA-18045-Z		85301
1973-77	W-900, WT-900 with 11000, 12000 & 15000 lb Axle	C6TA-18045-Y		85301
		C6TA-18045-Z		85301
1973-77	W-900, WT-900 with Air Suspension	D2HZ-18080-A		83209 or 89414
		D4HA-18080-AA		83209 or 89414

	HN-80 with 21000 lb or 23000 lb Axle & 52" Taper leaf Rear Suspension	F6HT-18080-JA		85305
	Models with O.E.M. Number	57365-111		85006 or 89401
		6ETZ-18124-AA		83145
		6ETZ-18125-A		83146
		70127		85006 or 89401
		70128		85006 or 89401
		90044769		83207 or 89407
		90044770		83207 or 89407
		AX267A		83309 or 89446
		D8HZ-18124-A		85301
		D8HZ-18125-A		83209 or 89414
		D8HZ-18125-B		83123 or 89405
		E5HT-18045-DA		85301
		E5HT-18045-EA		85301
		E6HZ-18124-D		85301
		E7XZ-18124-A		G60023
		E7XZ-18124-F		G60046
		E7XZ-18124-G		G60046
		E7XZ-18125-B		G60024
		E9HZ-18125-A		85716
		E9HZ-18125-AA		85716
	F0HS-18045-AA		85006 or 89401	
	F0HZ-18124-B		85006	
	F1HT-18045-LB		85006 or 89401	

Gabriel Part Numbers that appear in BLUE are GasSLX, adjustable shocks. \ Los números de parte Gabriel imprimidos en AZUL son amortiguadores ajustables GasSLX. \ Les numéros de pièce Gabriel imprimés en BLEU sont des amortisseurs ajustables GasSLX.

★ Will be available in first quarter of 2011.



Year Año Année	Model Modelo Modèle	O.E.M. #	Mount 	Front Delantero Avant	Rear Trasero Arrière
----------------------	---------------------------	----------	-----------	-----------------------------	----------------------------

FORD ... cont'd

Year Año Année	Model Modelo Modèle	O.E.M. #	Mount 	Front Delantero Avant	Rear Trasero Arrière
	Models with O.E.M. Number	F1HT-18045-RB		89402
		F1HZ-18124-AA		83309 or 89446
		F1HZ-18124-B		83308
		F1HZ-18124-C		89402
		F1HZ-18124-D		85006 or 89401
		F1HZ-18124-E		85006 or 89401
		F1HZ-18124-F		85006 or 89401
		F1HZ-18124-G		85006 or 89401
		F1HZ-18124-H		85040
		F1HZ-18124-J		83308
		F1HZ-18124-K		89402
		F2HZ-18124-B		85301
		F4TA-18045-TA		G60080
		F4TA-18080-PA		G60084
		F4TZ-18124-K		G60080
		F4TZ-18125-E		G60084
		F5HZ-18124-AA		83314
		F5HZ-18124-C		85063
		F5HZ-18124-DA		83125
		F5HZ-18125-A		85314 or 89425
		F5HZ-18125-AA		85314 or 89425
		F5HZ-18125-B		85001 or 89410
		F5HZ-18125-BA		85001 or 89410
		F5TZ-18124-B		G60162
		F5TZ-18125-BC		G60161
		F6HT-18045-KA		83200
		F6HT-18045-MA		85006 or 89401
		F6HT-18080-CA		85314 or 89425
		F6HT-18080-DA		83109
		F6HT-18080-EA		85906
		F6HT-18080-FC		85013 or 89414
		F6HZ-18124-B		83308
		F6HZ-18124-J		83200
		F6HZ-18124-KA		83200
		F6HZ-18124-MA		85006 or 89401
		F6HZ-18125-A		85314 or 89425
		F6HZ-18125-D		85013 or 89414
		F6HZ-18125-JA		85305
		F7TA-18045-AA		G60162
		F7TA-18080-BA		G60161
		XC45-18045-AA		83216

Gabriel Part Numbers that appear in BLUE are GasSLX, adjustable shocks. | Los números de parte Gabriel imprimidos en AZUL son amortiguadores ajustables GasSLX. | Les numéros de pièce Gabriel imprimés en BLEU sont des amortisseurs ajustables GasSLX.



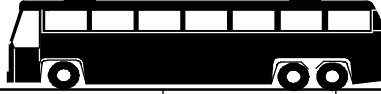



















































★ Will be available in first quarter of 2011.



Gabriel®

Year Año Année	Model Modelo Modèle	O.E.M. #	Mount 	Front Delantero Avant	Rear Trasero Arrière
----------------------	---------------------------	----------	--	-----------------------------	----------------------------

FORD ... cont'd

Year Año Année	Model Modelo Modèle	O.E.M. #	Mount 	Front Delantero Avant	Rear Trasero Arrière
	Additional O.E.M. Interchanges	47902-8			83122 or 89406
		680029			85301
		B3Q-18124-A			83219
		B3Q-18125-A			83217
		B3TZ-18125-A			83217
		B6TZ-18124-A			83219
		B7TZ-18124-B			83216
		B7TZ-18124-C			83216
		B7TZ-18124-D			83219
		B7TZ-18124-E			83217
		B7TZ-18125-C			83217
		B8Q-18125-A			85307
		B8QZ-18124-A			83312 or 89409
		B8T-18124-A			83219
		B9TT-18045-C			83219
		B9TT-18045-D			83219
		C0TT-18045-A			83219
		C0TT-18045-D			83216
		C0TZ-18124-A			83216
		C1TT-18045-G			83216
		C1TZ-18045-C			83312 or 89409
		C1TZ-18124-A			83217
		C1TZ-18124-B			83216
		C1TZ-18124-C			83312 or 89409
		C1TZ-18124-D			83309 or 89446
		C1TZ-18124-N			83314
		C1TZ-18125-B			83217
		C1VT-18080-B			83217
		C2TA-18045-B			83308
		C2TZ-18124-A			83308
		C3TA-18045-A			83216
		C3TZ-18124-A			83308
		C4HZ-18124-A			83312 or 89409
		C4HZ-18124-B			83309 or 89446
		C4HZ-18124-C			83314
		C4HZ-18124-D			83312 or 89409
		C4HZ-18124-E			83309 or 89446
		C4HZ-18124-F			83308
		C4PF-18045-H			83216
		C4TZ-18124-AA			83308
		C4TZ-18124-AB			83308
		C4TZ-18124-B			83308
		C5TZ-18124-A			83308
		C6PF-18077-DD			83216
		C6PF-18077-DE			83219
		C6TA-18045-U			85301
		C6TA-18045-V			85301
		C6TS-18080-A			83217
		C6TZ-18124-D			85301
		C6TZ-18124-E			85301
		C6TZ-18124-H			85301
		C6TZ-18124-J			85301
		C7HZ-18124-A			83312 or 89409

Gabriel Part Numbers that appear in BLUE are GasSLX, adjustable shocks. \ Los números de parte Gabriel imprimidos en AZUL son amortiguadores ajustables GasSLX. \
 Les numéros de pièce Gabriel imprimés en BLEU sont des amortisseurs ajustables GasSLX.

★ Will be available in first quarter of 2011.



Year Año Année	Model Modelo Modèle	O.E.M. #	Mount 	Front Delantero Avant	Rear Trasero Arrière
----------------------	---------------------------	----------	-----------	-----------------------------	----------------------------

FORD ... cont'd

Year	Model	O.E.M. #	Mount	Front	Rear
	Additional O.E.M. Interchanges	C7PF-18077-Z			83217
		C7TA-18045-R			83216
		C7TA-18045-Z			85301
		C8PF-18045-CM			83216
		DOHA-18045-D			83309 or 89446
		DOHZ-18124-A			83309 or 89446
		DOHZ-18124-B			83312 or 89409
		DOHZ-18124-C			83314
		D1TZ-18124-D			83308
		D1TZ-18124-E			83216
		D1TZ-18125-E			83217
		D2EF-18124-AA			83312 or 89409
		D2HA-18045-EB			85301
		D2HA-18045-F1A			85301
		D2HA-18045-F1B			85301
		D2HA-18045-F2A			85301
		D2HA-18045-F2B			85301
		D2HF-18045-A			83314
		D2HF-18124-AA			83314
		D2HT-18045-EA			83312 or 89409
		D2HZ-18080-A			83209 or 89414
		D2HZ-18125-A			83209 or 89414
		D2HZ-18125-B			83209 or 89414
		D2KF-18124-AA			83312 or 89409
		D2TA-18045-AAA			83219
		D2TA-18045-ZA			83219
		D2TF-18124-F			83309 or 89446
		D2TZ-18124-A			83308
		D2TZ-18124-E			83312 or 89409
		D2TZ-18124-F			83309 or 89446
		D2TZ-18124-G			83314
		D2TZ-18124-H			83308
		D2TZ-18124-J			83312 or 89409
		D3TA-18045-BA			83219
		D3TZ-18124-B			83219
		D3TZ-18125-C			83217
		D3TZ-18125-D			83217
		D4HA-18080-A			83209 or 89414
		D4TZ-18124-J			83308
		D5TZ-18124-B			83308
		D5TZ-18124-C			83312 or 89409
		D7HF-18125-AA			83215
		D7HT-18124-BA			83312 or 89409
		D7HT-18124-CA			83314
		D7HT-18124-DA			83309 or 89446
		D7HT-18124-EA			83312 or 89409
		D7HT-18124-FA			83312 or 89409
		D7HT-18124-GA			83308
		D7HT-18124-HA			83219
		D7HT-18124-JA			83308
		D7HT-18124-KA			85301
		D7HT-18125-BA			83217
		D7HT-18125-CA			83217

Gabriel Part Numbers that appear in BLUE are GasSLX, adjustable shocks. | Los números de parte Gabriel imprimidos en AZUL son amortiguadores ajustables GasSLX. | Les numéros de pièce Gabriel imprimés en BLEU sont des amortisseurs ajustables GasSLX.



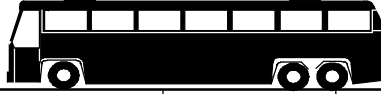























★ Will be available in first quarter of 2011.



Gabriel®









Year Año Année	Model Modelo Modèle	O.E.M. #	Mount 	Front Delantero Avant	Rear Trasero Arrière
----------------------	---------------------------	----------	--	-----------------------------	----------------------------

FORD ... cont'd





Year	Model	O.E.M. #	Mount	Front	Rear
	Additional O.E.M. Interchanges	D7HT-18125-DA			83215
		D7HT-18125-FA			83123 or 89405
		D7HZ-18125-A			83215
		D7TA-18124-GA			83314
		E0HZ-18124-A			83309 or 89446
		E1TA-18045-AA			83309 or 89446
		E1TD-18045-AA			83309 or 89446
		E5HT-18045-AA			85301
		E5HT-18080-DA			85315
		TACAA-18045-A			83216
		TANNA-18045-A			83312 or 89409
		TBDA-18080-A			83217
		TBDA-18080-B			83217
		TDAA-18080-B			83217
		TDBA-18045-A			83219
		TDBA-18045-B			83219
		TDBA-18080-A			83217
		TDBA-18080-B			83217
		TDBA-18080-C			83217
		TDBE-18045-A			83219
		TFAA-18045-B			83219
		TFAA-18045-C			83219
		TFAA-18080-A			85307
		THAB-18045-A			83219
		THAB-18045-B			83219
		TQSH-18045-A			83309 or 89446

FREIGHTLINER

Argosy

Year	Model	O.E.M. #	Mount	Front	Rear
	Models w/ Freightliner Low Profile Rear Air Suspension	16-14259-000		85331
	Models with 4" Taperleaf Front Suspension	10-12703-000		85918 or 89449
		10-12704-000		85918 or 89449
		10-13634-000		85918 or 89449
1999 -	Models with Freightliner FAS II Rear Air Suspension	16-15817-000		85724 or 89443
		680611		85724 or 89443
- 1998	Models with Freightliner FAS II Rear Air Suspension	16-13957-000		85724 or 89443
		680339		85724 or 89443

Business Class - FL50, 60, 70, 80

Year	Model	O.E.M. #	Mount	Front	Rear
	Business Class 6 & 7 with 15000 lb Rear Suspension	6803260000		83120
	FAS Airliner, Single / Tandem Past Production	16-11133-000		85007 or 89412
1999 -	FL Series with FAS II Rear Air Suspension	16-15817-000		85724 or 89443
		680611		85724 or 89443

Gabriel Part Numbers that appear in BLUE are GasSLX, adjustable shocks. \ Los números de parte Gabriel imprimidos en AZUL son amortiguadores ajustables GasSLX. \ Les numéros de pièce Gabriel imprimés en BLEU sont des amortisseurs ajustables GasSLX.

★ Will be available in first quarter of 2011.

**Gabriel®**

Year Año Année	Model Modelo Modèle	O.E.M. #	Mount 	Front Delantero Avant	Rear Trasero Arrière
----------------------	---------------------------	----------	-----------	-----------------------------	----------------------------

FREIGHTLINER ... cont'd

- 1998	FL Series with FAS II Rear Air Suspension	16-13957-000 680339	 	85724 or 89443 85724 or 89443
	FLN with 11000 to 12000 lb Front axle	665538 6803230300	 	85006 85006
	FLN with 6000 to 9000 lb Front axle	654654 6803230200	 	85043 85043

Business Class - M2

2009 - 11	Models w/ Freightliner Low Profile Rear Air Suspension	16-18706-000		85331
- 2008	Models w/ Freightliner Low Profile Rear Air Suspension	16-14259-000 680511	 	85331 85331
2002 - 08	Models with 10000 to 12000 lb. Front Axle	10-12390-000		85920
2009 - 11	Models with 13,300 lb to 20,000 Front Axle	10-13809-000 471700003920	 	85958 85958
2002 & UP	Models with 6000 to 9000 lb. Front Axle	10-12388-000		85920
2009 - 11	Models with 8000 to 12000 lb. Front Axle and Taperleaf Spring	10-13760-000 SDA471700002991	 	85959 85959
2009 - 11	Models with FAS II Rear Air Suspension	16-18708-000 SDA471700002809	 	85724 or 89443 85724 or 89443
2002 - 08	Models with FAS II Rear Air Suspension	16-15817-000 680611	 	85724 or 89443 85724 or 89443
2002 & UP	Models with Rear 10-15K Low Profile AirLiner	16-16577-000 16-18711-000	 	85335 85335
2002 & UP	Models with Rear 52" Spring ,10/15K	16-16486-000 16-18710-000	 	83134 83134
2002 & UP	Models with Rear 52" Spring ,18/23K	16-16442-000		83134
2002 & UP	Models with Rear 60" Spring ,18/23K	16-15765-000 16-18707-000	 	85921 85921
2005 - 08	Models with Taperleaf Front Suspension	10-13634-000		85918 or 89449
- 2004	Models with Taperleaf Front Suspension	10-13211-000		85918 or 89449

Cargo - FC70 & FC80

	FC70 & FC80 Series with 11000 to 12000 lb Front Axle	665538 6803230300	 	85006 85006
	FC70 & FC80 Series with 6000 to 9000 lb Front Axle	654654 6803230200	 	85043 85043
1999 -	FC70 & FC80 Series with FAS II Rear Air Suspension	16-15817-000 680611	 	85724 or 89443 85724 or 89443
- 1998	FC70 & FC80 Series with FAS II Rear Air Suspension	16-13957-000 680339	 	85724 or 89443 85724 or 89443

Gabriel Part Numbers that appear in BLUE are GasSLX, adjustable shocks. | Los números de parte Gabriel imprimidos en AZUL son amortiguadores ajustables GasSLX. | Les numéros de pièce Gabriel imprimés en BLEU sont des amortisseurs ajustables GasSLX.

★ Will be available in first quarter of 2011.

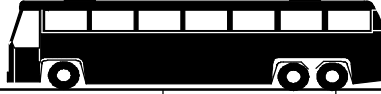







Gabriel®

















Year Año Année	Model Modelo Modèle	O.E.M. #	Mount 	Front Delantero Avant	Rear Trasero Arrière
----------------------	---------------------------	----------	--	-----------------------------	----------------------------

FREIGHTLINER ... cont'd





Cascadia

2009 - 11	Models with 12000 lb Taperleaf Front Suspension	10-13809-000		85958
		SDA471400003920		85958
2008	Models with 12000 lb Taperleaf Front Suspension	10-13634-000		85918 or 89449
2009 - 11	Models with FAS II Rear Air Suspension	16-18708-000		85724 or 89443
		SDA471700002809		85724 or 89443
2008	Models with FAS II Rear Air Suspension	16-15817-000		85724 or 89443
		680611		85724 or 89443

Century Class - C112 & C120

2000 - 09	Models with 12000 lb Taperleaf Front Suspension	10-13021-000		85918 or 89449
		10-13063-000		85918 or 89449
		10-13211-000		85918 or 89449
		10-13634-000		85918 or 89449
1997 - 99	Models with 12000 lb Taperleaf Front Suspension	10-12542-000		85901
- 1997	Models with 12000 lb Taperleaf Front Suspension	10-12470-000	
2009 - 10	Models with FAS II Rear Air Suspension	16-18708-000		85724 or 89443
		SDA471700002809		85724 or 89443
1999 - 08	Models with FAS II Rear Air Suspension	16-15817-000		85724 or 89443
		680611		85724 or 89443
- 1998	Models with FAS II Rear Air Suspension	16-13957-000		85724 or 89443
		680339		85724 or 89443
2002 - 09	Models with Hendrickson Front Airtek	HDR-58913-003		85932 or 89453
	Models with Low Profile Front	10-12703-000		85918 or 89449
		10-12704-000		85918 or 89449
	Models with Low Profile Rear Suspension	16-14259-000		85331

Classic/ClassicXL

2000 - 09	Models with 12000 lb Taperleaf Front Suspension	10-13021-000		85918 or 89449
		10-13063-000		85918 or 89449
		10-13211-000		85918 or 89449
		10-13634-000		85918 or 89449

Gabriel Part Numbers that appear in BLUE are GasSLX, adjustable shocks. \ Los números de parte Gabriel imprimidos en AZUL son amortiguadores ajustables GasSLX. \ Les numéros de pièce Gabriel imprimés en BLEU sont des amortisseurs ajustables GasSLX.

★ Will be available in first quarter of 2011.

**Gabriel®**

Year Año Année	Model Modelo Modèle	O.E.M. #	Mount 	Front Delantero Avant	Rear Trasero Arrière
----------------------	---------------------------	----------	-----------	-----------------------------	----------------------------

FREIGHTLINER ... cont'd

2009 - 10	Models with FAS II Rear Air Suspension	16-18708-000		85724 or 89443
		SDA471700002809		85724 or 89443
1999 - 08	Models with FASII Rear Air Suspension	16-15817-000		85724 or 89443
		680611		85724 or 89443
- 1998	Models with FASII Rear Air Suspension	16-13957-000		85724 or 89443
		680339		85724 or 89443
- 2009	Models with Hendrickson Front Airtek	HDR-58913-003		85932 or 89453
	Models with O.E.M. Number	10-12032-002		85320 or 89429
		10-12032-004		85320 or 89429
		680009		85302 or 89420
		70029		85308 or 89422

Columbia

2009 - 10	Models with 12000 lb Taperleaf Front Suspension	10-13809-000		85958
		SDA471400003920		85958
2000 - 08	Models with 12000 lb Taperleaf Front Suspension	10-13021-000		85918 or 89449
		10-13063-000		85918 or 89449
		10-13211-000		85918 or 89449
		10-13634-000		85918 or 89449
2009 - 10	Models with FAS II Rear Air Suspension	16-18708-000		85724 or 89443
		SDA471700002809		85724 or 89443
1999 - 08	Models with FAS II Rear Air Suspension	16-15817-000		85724 or 89443
		680611		85724 or 89443
2002 - 10	Models with Hendrickson Front Airtek	HDR-58913-003		85932 or 89453

Coronado

2004 - 09	Models with 12000 lb Taperleaf Front Suspension	10-13211-000		85918 or 89449
2009 - 11	Models with 13,300 lb to 20,000 Front Axle	10-13809-000		85958
		471700003920		85958
2011	Models with Chalmers 46,000 lb Rear Suspension	665174		85060
2009 - 11	Models with FAS II Rear Air Suspension	16-18708-000		85724 or 89443
		SDA471700002809		85724 or 89443

Gabriel Part Numbers that appear in BLUE are GasSLX, adjustable shocks. \ Los números de parte Gabriel imprimidos en AZUL son amortiguadores ajustables GasSLX. \ Les numéros de pièce Gabriel imprimés en BLEU sont des amortisseurs ajustables GasSLX.





★ Will be available in first quarter of 2011.



















Gabriel®

Year Año Année	Model Modelo Modèle	O.E.M. #	Mount 	Front Delantero Avant	Rear Trasero Arrière
----------------------	---------------------------	----------	--	-----------------------------	----------------------------







FREIGHTLINER ... cont'd

2004 - 08	Models with FAS II Rear Air Suspension	16-15817-000		85724 or 89443
		680611		85724 or 89443
2008 - 11	Models with Freightliner TufTrac Rear Air Suspension	16-15770-000		85956
		481700125969		85956
2004 - 10	Models with Hendrickson Front Airtek	HDR-58913-003		85932 or 89453

FLA & FLB Series - COE Truck & Tractor

	COE Series	10-12030-002		85320 or 89429
		10-12032-000		85320 or 89429
		10-12032-001		85320 or 89429
		10-12032-002		85320 or 89429
		10-12032-003		85320 or 89429
		10-12032-004		85320 or 89429
- 1994	COE Series with Airliner Rolling Lobe Spring Air Suspension	16-13947-000		85319 or 89428
		681-326-0400		85319 or 89428
	COE Series with Convoluted Spring Air Suspension	16-12117-000		85007 or 89412
		16-18705-000		85007 or 89412
		665236		85007 or 89412
1999 -	COE Series with FASII Rear Air Suspension	16-15817-000		85724 or 89443
		680611		85724 or 89443
- 1998	COE Series with FASII Rear Air Suspension	16-13957-000		85724 or 89443
		680339		85724 or 89443
	COE Series with Neway Tag Axle Air Suspension	90044162		83128

FLC & FLD Series - 112 & 120 Conventional Truck & Tractor

2000 - 09	Conventional Series with 12000 lb Taperleaf Front Suspension	10-13021-000		85918 or 89449
		10-13063-000		85918 or 89449
		10-13211-000		85918 or 89449
		10-13634-000		85918 or 89449
- 1994	Conventional Series with Airliner Rolling Lobe Spring Air Suspension	16-13947-000		85319 or 89428
		681-326-0400		85319 or 89428





















Gabriel Part Numbers that appear in BLUE are GasSLX, adjustable shocks. \ Los números de parte Gabriel imprimidos en AZUL son amortiguadores ajustables GasSLX. \ Les numéros de pièce Gabriel imprimés en BLEU sont des amortisseurs ajustables GasSLX.

★ Will be available in first quarter of 2011.





**Gabriel®**

Year Año Année	Model Modelo Modèle	O.E.M. #	Mount 	Front Delantero Avant	Rear Trasero Arrière
----------------------	---------------------------	----------	--	-----------------------------	----------------------------



FREIGHTLINER ... cont'd

	Conventional Series with Convoluted Spring Air Suspension	16-12117-000 16-18705-000 665236	  	85007 or 89412 85007 or 89412 85007 or 89412
1999 - 08	Conventional Series with FASII Rear Air Suspension	16-15817-000 680611	 	85724 or 89443 85724 or 89443
- 1998	Conventional Series with FASII Rear Air Suspension	16-13957-000 680339	 	85724 or 89443 85724 or 89443
2002 - 09	Conventional Series with Hendrickson Front Airtek	HDR-58913-003		85932 or 89453
	Conventional Series with Neway Tag Axle Air Suspension	90044162		83128
	Conventional Series with O.E.M. Number	10-12030-002 10-12032-000 10-12032-001 10-12032-002 10-12032-003 10-12032-004	     	85320 or 89429 85320 or 89429 85320 or 89429 85320 or 89429 85320 or 89429
2009 - 10	Models with 12000 lb Taperleaf Front Suspension	10-13809-000 SDA471400003920	 	85958 85958
2009 - 10	Models with FAS II Rear Air Suspension	16-18708-000 SDA471700002809	 	85724 or 89443 85724 or 89443
2008 - 11	Models with Freightliner TufTrac Rear Air Suspension	16-15770-000 481700125969	 	85956 85956

Legacy

1999 -	Models with FAS II Rear Air Suspension	16-15817-000 680611	 	85724 or 89443 85724 or 89443
- 1998	Models with FAS II Rear Air Suspension	16-13957-000 680339	 	85724 or 89443 85724 or 89443
	Models with O.E.M. Number	681-323-0900		85009

Freightliner Additional O.E.M. Numbers

	Models with 7000 lb Front Suspension	10-13776-000		85005 or 89430
	Models with Neway Air Suspension with shock stamping	90045083		85910

Gabriel Part Numbers that appear in BLUE are GasSLX, adjustable shocks. \ Los números de parte Gabriel imprimidos en AZUL son amortiguadores ajustables GasSLX. \ Les numéros de pièce Gabriel imprimés en BLEU sont des amortisseurs ajustables GasSLX.





































★ Will be available in first quarter of 2011.







Gabriel®

Year Año Année	Model Modelo Modèle	O.E.M. #	Mount 	Front Delantero Avant	Rear Trasero Arrière
----------------------	---------------------------	----------	---	-----------------------------	----------------------------

FREIGHTLINER ... cont'd

Year	Model	O.E.M. #	Mount	Front	Rear
	Models with O.E.M. Number	10-12046-000		85320 or 89429
		10-13592-000		85959
		16-10688-000		85042
		16-11133-000		85007 or 89412
		16-14577-000		85043
		16-14669-000		G60111
		16-14759-000		85000 or 89436
		16-19138-000		85058 or 89431
		3638112		G60028
		47902-13		83122 or 89406
		535228		85302 or 89420
		61300224		85918 or 89449
		650224		83225
		651352		85042
		651356		83634
		654725		83120
		654875		83117
		654918		83118
		659060		85920
		659062		83134
		659063		83134
		659300		85005 or 89430
		660235		85042
		665409		85009
		671908		85918 or 89449
		671945		85920
		671946		85921
		680009		85302 or 89420
		680442		85319 or 89428
		680651		85335
		6813230900		85009
		6813231300	
		6813260000		83634
		6813260200		85011
		70029		85308 or 89422
		70042		85302 or 89420
		SDA471700000440		85959

FREIGHTLINER CUSTOM CHASSIS

	F65 School bus chassis	6803230300		85006
		6803260000		83120
		GBL654725		83120
		GBL665538		85006

Gabriel Part Numbers that appear in BLUE are GasSLX, adjustable shocks. \ Los números de parte Gabriel imprimidos en AZUL son amortiguadores ajustables GasSLX. \ Les numéros de pièce Gabriel imprimés en BLEU sont des amortisseurs ajustables GasSLX.

★ Will be available in first quarter of 2011.

**Gabriel®**

Year Año Année	Model Modelo Modèle	O.E.M. #	Mount 	Front Delantero Avant	Rear Trasero Arrière
----------------------	---------------------------	----------	-----------	-----------------------------	----------------------------

FREIGHTLINER CUSTOM CHASSIS ... cont'd

	FedEx Trucks with O.E.M. Number	MAE16950 P117146	 	83118 83118
	Fleetwood Motor Home with O.E.M. Number	651375 RW24285	 	83119 83119
	HT35 Step Van	16-14782-000	
	HT45 Step Van	16-15394-000	
	HT45 Step Van w/35" Front Spring	16-15473-000 16-15474-000	 	★ 83157 ★ 83157
	HT45 Step Van w/38" Front Spring	16-15089-000	
	MB55 & MT55 Models	16-17684-000		85058 or 89431
	MB55 Shuttle bus w/8000 lb. flat leaf front suspension	16-15676-000		85058 or 89431
	M-Line Walk in Van with O.E.M. Number	MAE 16949 MAE 16950 P117099 P117146	 83118 83118	83120 83120
	MP14 and 19 (UPS)	P117253		83116
	MT135	16-16331-000 16-17019-000 GBL654875	 83117
	MT55 Step Van	16-15436-000 16-15705-000 16-15934-000 16-16262-000 16-16542-000	 	83154 83120 83120 83154
	MT55 Step Van w/35" Front Spring	16-15473-000 16-15474-000	 	★ 83157 ★ 83157
	MT55 Step Van w/38" Front Spring	16-15089-000	
	MT55 Utility Van w/8000 lb. flat leaf front suspension	16-15676-000		85058 or 89431
	Oshkosh Motor Home with O.E.M. Number	1398980 GBL654875	 	83127	83127 83117
	Shuttle Bus Chassis	16-16082-000		85043
2003 - 07	VC Chassis				
	- ADL200 Suspension w/ 20K Rear	16-16873-000		85029
	- Rear Shock with O.E.M. Number	141700131809 16-16736-000	 	85029 85029
	- ZF - IFS Front Suspension with 23,000 lb GVW or Greater	16-18103-000 48170000493	 	85900 85900
	W700	P110799	
2003 - 07	XC Chassis				
	- ADL200 Suspension w/ 20K Rear	16-16873-000		85029
	- AS120 Front Suspension	141700131810 16-16737-000 16-16874-000	 	★ 83160 ★ 83160 ★ 83160
	- Rear Shock with O.E.M. Number	141700131809 16-16736-000	 	85029 85029
	- ZF - IFS Front Suspension with 23,000 lb GVW or Greater	16-18103-000 48170000493	 	85900 85900

Gabriel Part Numbers that appear in BLUE are GasSLX, adjustable shocks. | Los números de parte Gabriel imprimidos en AZUL son amortiguadores ajustables GasSLX. | Les numéros de pièce Gabriel imprimés en BLEU sont des amortisseurs ajustables GasSLX.



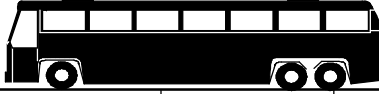













★ Will be available in first quarter of 2011.





















Gabriel®

Year Año Année	Model Modelo Modèle	O.E.M. #	Mount 	Front Delantero Avant	Rear Trasero Arrière
----------------------	---------------------------	----------	--	-----------------------------	----------------------------

FREIGHTLINER CUSTOM CHASSIS ... cont'd

Models with O.E.M. Number	16-14794-000		83154
	16-16083-000		85331
	16-16836-000		83154
	16-19138-000		85058 or 89431
	654870		83116
	654953		85058 or 89431
	659227		85058 or 89431
	GBL654918		83118
	P101977		85010
Additional O.E.M. Interchanges	10-13358-000		85904	
	10-13859-000		85005 or 89430	
	16-17759-000		85919	
	16-18094-000		85959	
	1745500		89430	
	659104		85904	
	665545401		89430	
	P116168		83117	

FRUEHAUF

"L" Suspensions	UCD-006216-001		83203 or 89436
"T" Suspensions	UCE-1295-901		85300 or 89419
"T" Suspensions With Drop Frame (NT Construction)	UCF-8339-001		85321
	UCF-8339-002		85321
All with Air Suspension and O.E.M. Number	UCE-1295-1		85300 or 89419
All with Lift Axle	UCE-9399-1		83122 or 89406
Model "T" Low Mount with 48 ft drop-deck trailer		85327
Model UCA-5431	5352858		85305
Model W24T1 Air Ride	UCE-2983-000		85322
	UCE-2983-001		85322
Tractor & Trailer Lift Axle with O.E.M. Number	5116-117		83122 or 89406
Models with O.E.M. Number	144-5910		85300 or 89419
	UCA-01113		85304
	UCA-5431		85305
	UCD-6216-1		83203 or 89436
	UEY 1124-001		85030 or 89440
Additional O.E.M. Interchanges	680117		85300 or 89419	
	680298		85321	
	UCE-2983-1		85322	

FWD TRUCK

Model with O.E.M. Number	450739		85302 or 89420
--------------------------	--------	---	-------------------	-------

Gabriel Part Numbers that appear in BLUE are GasSLX, adjustable shocks. \ Los números de parte Gabriel imprimidos en AZUL son amortiguadores ajustables GasSLX. \ Les numéros de pièce Gabriel imprimés en BLEU sont des amortisseurs ajustables GasSLX.

★ Will be available in first quarter of 2011.



Gabriel®

Year Año Année	Model Modelo Modèle	O.E.M. #	Mount 	Front Delantero Avant	Rear Trasero Arrière
----------------------	---------------------------	----------	-----------	-----------------------------	----------------------------

GENERAL TRAILER CO

	Models with Air Suspension	120-1		83125
	Additional O.E.M. Interchanges	12608		83125	

GILLIG BROS.

	Models with Neway Air Suspension with shock stamping	90045084		★ 85968
	Models with Neway ARD-234 Series Truck & Tractor Air Suspension (ARD-234-6)	90044046		83123 or 89405
	School Bus w/1" Mounting Pins	200-171		85304	85304
		53-176		85304	85304
	School Bus w/3/4" Mounting Pins	57113		83219
		57131		83216
	Transit Bus, Phantom 55, 40, TB40	53-14010		85318
		53-24685		85723
		695110		85318
		90F-1912		85318
	Models with O.E.M. Number	1583470		85051
		695109		85723
		82-01878		83122 or 89406	83122 or 89406
		90044683		83122 or 89406
		90044769		83207 or 89407
		90044770		83207 or 89407
		H53-02132/14005		85723
		H53-20415-006		85051
	Additional O.E.M. Interchanges	MR-6394		85723
		53-02132		85723
		53-02133-000		85318
		665568		85051
		680009		85302 or 89420
		680333		85708
		70034		85302 or 89420
		82-21542-000		85716
		82-30159-000		85708
	90-1908		85723	

GMC TRUCK

3500 & 4000 Series

1960- 62	3500, 4000, B-4000, L-4000, S-4000 with H-130, H-150 and 13800 Axles	83221
1963- 66	Truck and School Bus	83221
			85005 or 89430

4500 Series

1966- 72	CE-4500, CS-4500 Conventional Cab with V-8 Gas or In-line 6 Gas Engines	22012096		83221	83221
		3192892		83221	83221

Gabriel Part Numbers that appear in BLUE are GasSLX, adjustable shocks. | Los números de parte Gabriel imprimidos en AZUL son amortiguadores ajustables GasSLX. | Les numéros de pièce Gabriel imprimés en BLEU sont des amortisseurs ajustables GasSLX.



















★ Will be available in first quarter of 2011.



















Gabriel®

Year Año Année	Model Modelo Modèle	O.E.M. #	Mount 	Front Delantero Avant	Rear Trasero Arrière
----------------------	---------------------------	----------	---	-----------------------------	----------------------------

GMC TRUCK ... cont'd

1966-72	EG-4500, EM-4500, ES-4500 Cab/Cowl with V-6 Gas or Diesel or In-line 6 Gas Engines	22012095		85005 or 89430
		3171068		83216
		3171462		85005 or 89430
		3192657		83216
		3192890		85005 or 89430
		4940614		83216
		4963853		83216
		4963854		83216
1977	PS4620 P, 4650P Step Van (Walk-in)	22012166		85005 or 89430
		22012169		83221
1972-80	PS4620 P, 4650P Step Van (Walk-in)	22012096		83221
		3192892		83221
1972-77	PS4620 P, 4650P Step Van (Walk-in)	22012095		85005 or 89430
1972-76	PS4620 P, 4650P Step Van (Walk-in)	22007701		85005 or 89430
		3192890		85005 or 89430
		4940606		85005 or 89430
		4975497		85005 or 89430
1972-80	PS4620 P, 4650P Step Van (Walk-in) 3/4" Upper bolt	22002293		85005 or 89430
1972-80	PS4620 P, 4650P Step Van (Walk-in) 5/8" Upper bolt	22007751		83303

5000 Series

1960-62	5000, B-5000, L-5000, S-5000 with 1618 or 16802 Axle		83221
1976-89	C Chassis - Conventional Cab	22002294		83304
		22007752		83304
		22007757		83304
		22012096		83221
		22012196		83221
1975-80	C Chassis - Conventional Cab	4975510		83221
1973-80	C, S Chassis - Conventional Cab	22007750		83207 or 89407
		4975467		83207 or 89407
		4975494		83207 or 89407
1973-89	C,S Chassis - Conventional Cab and School Bus	22012095		85005 or 89430
		22012166		85005 or 89430
1973-80	C,S Chassis - Conventional Cab and School Bus	22012096		83221
		3192892		83221
1960-68	SP-5000, DSP-5000 School Bus		85302 or 89420
			85307

Gabriel Part Numbers that appear in BLUE are GasSLX, adjustable shocks. \ Los números de parte Gabriel imprimidos en AZUL son amortiguadores ajustables GasSLX. \ Les numéros de pièce Gabriel imprimés en BLEU sont des amortisseurs ajustables GasSLX.

★ Will be available in first quarter of 2011.

**Gabriel®**

Year Año Année	Model Modelo Modèle	O.E.M. #	Mount 	Front Delantero Avant	Rear Trasero Arrière
----------------------	---------------------------	----------	-----------	-----------------------------	----------------------------

GMC TRUCK ... cont'd

1963-66	Truck and School Bus		85005 or 89430
1963-68	W-5000, BW-5000, DW-5000		85005 or 89430

5500 Series

1966-72	CE-5500, CS-5500 Conventional Cab with V-8 Gas or In-line 6 Gas Engines	22012096		83221	83221
		3192891		83221	83221
		3192892		83221	83221
1966-72	CG-5500, CM-5500, T-5500 Conventional & Tilt Cab with V-6 Gas or Diesel Engines	22012095		85005 or 89430
		3192890		85005 or 89430
		4940606		85005 or 89430
1966-72	EG-5500, EM-5500, ES-5500 Cab/Cowl with 6 Cyl. Engines	22012095		85005 or 89430
		3171068		83216
		3171462		85005 or 89430
		3192657		83216
		3192890		85005 or 89430
		4940614		83216
		4963853 4963854		83216 83216
1960-68	LW-5500		85307
1967-68	Truck and School Bus	83221
			85005 or 89430
1963-68	W-5500		85005 or 89430

6000 Series

1976-89	C Chassis - Conventional Cab	22002294		83304
		22007752		83304
		22007757		83304
1979-89	C, S Chassis - Conventional Cab and School Bus	22002295		83303
		22007753		83303
		22017530		83303
		22017531		83303
1975-80	C, S Chassis - Conventional Cab and School Bus	4975510		83221
1973-89	C, S Chassis - Conventional Cab and School Bus - Exc. with 18500, 20800 & 23000 lb Rear Axle	22012096		83221
		22012169		83221
		3192892		83221
1973-75	C, S Chassis - Conventional Cab and School Bus - Exc. with 18500, 20800 & 23000 lb Rear Axle	22007750		83207 or 89407
		4975467		83207 or 89407
		4975494		83207 or 89407

Gabriel Part Numbers that appear in BLUE are GasSLX, adjustable shocks. \ Los números de parte Gabriel imprimidos en AZUL son amortiguadores ajustables GasSLX. \ Les numéros de pièce Gabriel imprimés en BLEU sont des amortisseurs ajustables GasSLX.



















★ Will be available in first quarter of 2011.

















Gabriel®

Year Año Année	Model Modelo Modèle	O.E.M. #	Mount 	Front Delantero Avant	Rear Trasero Arrière
----------------------	---------------------------	----------	---	-----------------------------	----------------------------

GMC TRUCK ... cont'd

1973-89	C, S Chassis - Conventional Cab and School Bus with 18500, 20800 & 23000 lb Rear Axle	22012095		85005 or 89430
		22012166		85005 or 89430
		4940606		85005 or 89430
1973-80	C, S, T Chassis - Conventional & Tilt Cab and School Bus with 5000 & 7000 lb Axle	22002293		85005 or 89430
		22007701		85005 or 89430
		22007751		83303
		22012095		85005 or 89430
		3192890		85005 or 89430
		4940606		85005 or 89430
		4940662		85005 or 89430
4975497		85005 or 89430		
1963-68	DW - 6000		85005 or 89430
1960-68	L - 6000		85307
1979-89	S Chassis - School Bus	22002294		83304
		22007752		83304
		22007757		83304
1976-89	S Chassis - School Bus	22007702		83304
1979-80	W Chassis - 72" BBC Steel Tilt Cab	22002293		85005 or 89430
		22007751		83303

6500 Series

1976-89	C, M Chassis - Conventional Cab	22002294		83304
		22007752		83304
		22007757		83304
1975-76	C, M Chassis - Conventional Cab	4975510		83221
1975-89	C, M Chassis - Conventional Cab with 9000 & 12000 lb Axle	22002295		83303
		22007751		83303
		22017530		83303
		22017531		83303
		4975511		83303
1973-75	C, M Chassis - Conventional Cab with 9000 & 12000 lb Axle	22012095		85005 or 89430
		3192890		85005 or 89430
		4940606		85005 or 89430
		4940614		83216
		4963854		83216
		4975497		85005 or 89430

Gabriel Part Numbers that appear in BLUE are GasSLX, adjustable shocks. \ Los números de parte Gabriel imprimidos en AZUL son amortiguadores ajustables GasSLX. \ Les numéros de pièce Gabriel imprimés en BLEU sont des amortisseurs ajustables GasSLX.

★ Will be available in first quarter of 2011.



Gabriel®

Year Año Année	Model Modelo Modèle	O.E.M. #	Mount 	Front Delantero Avant	Rear Trasero Arrière
----------------------	---------------------------	----------	-----------	-----------------------------	----------------------------

GMC TRUCK ... cont'd

1973-75	C, M, S Chassis - Conventional Cab and School Bus	22007750		83207 or 89407
		4975467		83207 or 89407
		4975494		83207 or 89407
1973-80	C, M, S Chassis - Conventional Cab and School Bus - Exc. with 20800 or 23000 lb Rear Axle	22012096		83221
		22012169		83221
		3192892		83221
1973-80	C, M, S Chassis - Conventional Cab and School Bus with 20800 or 23000 lb Rear Axle	22012095		85005 or 89430
		22012166		85005 or 89430
		4940606		85005 or 89430
1973-80	C, S, T Chassis - Conventional & Tilt Cab and School Bus	22002293		85005 or 89430
		22012095		85005 or 89430
		3192890		85005 or 89430
		4940606		85005 or 89430
		4975497		85005 or 89430
1966-72	CE-6500, CM-6500 Conventional Cab with V-6 Diesel or V-8 Gas Engine	3192892		83221
1966-72	CE-6500, ME-6500 Conventional Cab with V-8 Gas Engine - Exc. 11000 lb Axle	22012096		83221
		3192891		83221
		3192892		83221
1966-72	CE-6500, ME-6500 Conventional Cab with V-8 Gas Engine with 11000 lb Axle	22012095		85005 or 89430
		3192890		85005 or 89430
		4940606		85005 or 89430
1966-72	CM-6500, TE-6500, TM-6500 Conventional Cab with V-6 Diesel or V-8 Gas Engine	22012095		85005 or 89430
		22012096		83221
		3192890		85005 or 89430
		4940606		85005 or 89430
1966-72	EG-6500, DM-6500, ES-6500 Cab/Cowl with V-6 Gas or Diesel or In-line 6 Gas Engines	22012095		85005 or 89430
		3171068		83216
		3171462		85005 or 89430
		3192657		83216
		3192890		85005 or 89430
		4963853		83216

Gabriel Part Numbers that appear in BLUE are GasSLX, adjustable shocks. \ Los números de parte Gabriel imprimidos en AZUL son amortiguadores ajustables GasSLX. \ Les numéros de pièce Gabriel imprimés en BLEU sont des amortisseurs ajustables GasSLX.

★ Will be available in first quarter of 2011.















Gabriel®





















Year Año Année	Model Modelo Modèle	O.E.M. #	Mount 	Front Delantero Avant	Rear Trasero Arrière
----------------------	---------------------------	----------	--	-----------------------------	----------------------------

GMC TRUCK ... cont'd

7000 Series

1979-89	C, M Chassis - 97" BBC Conventional Cab	22002294		83304
		22002295		83303
		22007752		83304
		22007753		83303
		22007757		83304
		22017530		83303
1979-81	C, M Chassis - 97" BBC Conventional Cab - Exc. with 18500, 20800 & 23000 lb Rear Axle	22012096		83221
		2212169		83221
1979-89	C, M Chassis - 97" BBC Conventional Cab with 18500, 20800 & 23000 lb Rear Axle	22012095		85005 or 89430
		22012166		85005 or 89430
1979-80	W Chassis - 72" BBC Steel Tilt Cab	22002293		85005 or 89430
		22007751		83303

7500 Series

1966-69	72" BBC Tilt Cab	22012095		85005 or 89430
		3171462		85005 or 89430
		4940606		85005 or 89430
1966-72	72" BBC Tilt Cab with V-6 2 Cycle Diesel Engine with 17221 Axle	22012096		83221
		3192892		83221
1966-72	72" BBC Tilt Cab with V-6 2 Cycle Diesel Engine with 19101 and 19201 Axle	4940600		83209 or 89414
1970-72	72" BBC Tilt Cab with Air Brakes - Exc. Gas Engine	22012095		85005 or 89430
		3171462		85005 or 89430
		4940606		85005 or 89430
1970-72	72" BBC Tilt Cab with Air Brakes & Gas Engine	22012091		85303 or 89422
		5552452		85303 or 89422
1966-72	92" BBC Conventional Cab with Tapered 2-Leaf Softride 11000 lb Rating and F120 Axle (12000 lb)	22046483		85304
		22052336		85304
		3171069		85304
1966-72	92" BBC Conventional Cab with Tapered 2-Leaf Softride 7000 & 9000 lb Rating and F070, F090, F120 Axle (7000, 9000 & 12000 lb)	3171068		83216
		3192657		83216
		4940614		83216
		4963853		83216
		4963854		83216
1977-80	H, J Chassis - 92" BBC Conventional Cab	4963854		83216
		4984526		83216

Gabriel Part Numbers that appear in BLUE are GasSLX, adjustable shocks. \ Los números de parte Gabriel imprimidos en AZUL son amortiguadores ajustables GasSLX. \ Les numéros de pièce Gabriel imprimés en BLEU sont des amortisseurs ajustables GasSLX.

★ Will be available in first quarter of 2011.

**Gabriel®**

Year Año Année	Model Modelo Modèle	O.E.M. #	Mount 	Front Delantero Avant	Rear Trasero Arrière
----------------------	---------------------------	----------	-----------	-----------------------------	----------------------------

GMC TRUCK ... cont'd

1973-80	H, J, M Chassis - 92" & 114" BBC Conventional Cab	22046483		85304
		22052336		85304
		3171069		85304
1973-80	H, J, M Chassis - 92" & 114" BBC Conventional Cab with V-6, V-8 Gas or V-6 Diesel Engines	4940614		83216
		4963854		83216
1973-80	R Chassis - Rear Engine Bus	22012090		85308 or 89422
		22012091		85303 or 89422
		5552451		85308 or 89422
		5552452		85303 or 89422
		5552456		85307
1973-80	T, W Chassis - 72" BBC Steel Tilt Cab with V-6 Diesel Engine	22007751		83303
		22012095		85005 or 89430
		4940606		85005 or 89430
		4975497		85005 or 89430
1973-80	T, W Chassis - 72" BBC Steel Tilt Cab with V-6 Gas Engine	22012091		85303 or 89422
		5552452		85303 or 89422

8500 Series

1966-72	72" BBC Tilt Cab	5544060		85302 or 89420
1967	92" BBC Conventional Cab	3171068		83216
		3192657		83216
		4940614		83216
		4963853		83216
		4963854		83216
1966-72	92" BBC Conventional Cab with 7000 & 9000 lb Axles	22046483		85304
		22052336		85304
		3171069		85304
1979-80	D, F Chassis - 54" BBC Aluminum Tilt Cab	22046483		85304
		22052336		85304
		3171069		85304
1979-82	H, J Chassis - 92" BBC Conventional Cab 4 x 2 with Air Suspension	22012065		85304
		22046483		85304
		22052336		85304
		3171069		85304
1973-81	H, J Chassis - 92" BBC Conventional Cab with V-6, V-8 Gas Engine	4940614		83216
		4963854		83216
		4984526		83216
1973-86	H, J, M Chassis - 92" & 114" BBC Conventional Cab	22046483		85304
		22052336		85304
		3171069		85304

Gabriel Part Numbers that appear in BLUE are GasSLX, adjustable shocks. \ Los números de parte Gabriel imprimidos en AZUL son amortiguadores ajustables GasSLX. \ Les numéros de pièce Gabriel imprimés en BLEU sont des amortisseurs ajustables GasSLX.







★ Will be available in first quarter of 2011.































Gabriel®

Year Año Année	Model Modelo Modèle	O.E.M. #	Mount 	Front Delantero Avant	Rear Trasero Arrière
----------------------	---------------------------	----------	--	-----------------------------	----------------------------

GMC TRUCK ... cont'd

1973-80	R Chassis - Rear Engine Bus	22012090		85308 or 89422
		22012091		85303 or 89422
		5552451		85308 or 89422
		5552452		85303 or 89422
		5552456		85307
1973-80	T, W Chassis - 72" BBC Steel Tilt Cab with V-6 Gas Engine	22012091		85303 or 89422
		5552452		85303 or 89422

9500 Series

1972	114" BBC Conventional Cab with V-8 71 Engine	4940614		83216
		4963854		83216
1966-72	48" BBC Aluminum Tilt Cab	5552454		85302 or 89420
1966-72	72" BBC Steel Tilt Cab	22012091		85303 or 89422
		5552452		85303 or 89422
1967-72	92" & 114" BBC Conventional Cab	3171068		83216
		3192657		83216
		4940614		83216
		4963853		83216
		4963854		83216
1973-89	D, F Chassis - 54" BBC Aluminum Cab	22012065		85304
		22046483		85304
		22052336		85304
		3171069		85304
1973-89	D, F Chassis - 54" BBC Aluminum Tilt Cab with Rear GM Air-Ride Suspension (4 req'd)	22012065		85304
		22046483		85304
		22052336		85304
		3171069		85304
1973-89	H, J Chassis - 92" BBC Conventional Cab	22046483		85304
		22052336		85304
		3171069		85304
1973-89	H, J Chassis - 92" BBC Conventional Cab with Rear GM Air-Ride Suspension (4 req'd)	22012065		85304
		22046483		85304
		22052336		85304
		3171069		85304
1977-89	M, N Chassis - 114" BBC Conventional & 108" BBC Aluminum Conventional Cab	22046483		85304
		22052336		85304
		3171069		85304
1977-89	M, N Chassis - 114" BBC Conventional & 108" BBC Aluminum Conventional Cab with Rear GM Air-Ride Suspension (4 req'd)	22046483		85304
		22052336		85304
		3171069		85304

Gabriel Part Numbers that appear in BLUE are GasSLX, adjustable shocks. \ Los números de parte Gabriel imprimidos en AZUL son amortiguadores ajustables GasSLX. \ Les numéros de pièce Gabriel imprimés en BLEU sont des amortisseurs ajustables GasSLX.

★ Will be available in first quarter of 2011.









**Gabriel®**

Year Año Année	Model Modelo Modèle	O.E.M. #	Mount 	Front Delantero Avant	Rear Trasero Arrière
----------------------	---------------------------	----------	--	-----------------------------	----------------------------























GMC TRUCK ... cont'd

1973 - 80	T, W Chassis - 72" BBC Steel Tilt Cab	22012091		85303 or 89422
		5552452		85303 or 89422
1966 - 72	Models with O.E.M. Number	22046483		85304
		22052336		85304
		3171069		85304

B - Series

1990 - 98 1990 - 06	B7 School Bus Chassis - With 11000, 13500, 15000 lb Taperleaf Springs - With 15000, 19000, 21000 lb Multileaf Springs	22064231		85324
		15174902		85071
		22064232		85071
1993 - 96	Models with O.E.M. Number	22064231		85324
1990 - 98	Models with O.E.M. Number	15588554		83136
		22064230		83136
1990 - 06	Models with O.E.M. Number	15123676		83136
		88982682		83136

C - Series (C4500, C5500) Topkick

1990 - 09	C Chassis - Conventional Cab - Front Shock with O.E.M. Number	15123676		83136
		15588554		83136
		15887728		83136
		19152843		83136
		22064230		83136
		88982682		83136
		1990 - 1990 - 09	- With 11000, 13500, 15000 lb Taperleaf Springs - With 15000, 19000, 21000 lb Multileaf Springs	22064231	
15174902				85071
22064232				85071
88982686				85071
1990 - 06	- With 16900 or 17850 lb Taperleaf Springs	21998392		85336
		22064489		85336
		88963409		85336
1990 -	- With 19000, 21000, 23000 lb Taperleaf Springs (EXC Low Profile Vehicle)	22064233		83136
2004 - 09	C Chassis - Conventional Cab (Non 4x4 Option) with 13,500 Multi-leaf Spring	15185644		83155
		508-89		83155
		L-12706		83155
1983 - 99	C Chassis - Conventional Cab with 9100 to 17500 lb Rear Axle	22064432		85050
2003 - 09	C Chassis - Conventional Cab with O.E.M. Number	19152843		83136
2003 - 09	C Chassis - Conventional Cab with Taperleaf Rear Suspension	15185643		83153
	Models with O.E.M. Number	88982684		83136
		88982686		85071
		88982688		85336

Gabriel Part Numbers that appear in BLUE are GasSLX, adjustable shocks. | Los números de parte Gabriel imprimidos en AZUL son amortiguadores ajustables GasSLX. | Les numéros de pièce Gabriel imprimés en BLEU sont des amortisseurs ajustables GasSLX.

★ Will be available in first quarter of 2011.

























Gabriel®



















Year Año Année	Model Modelo Modèle	O.E.M. #	Mount 	Front Delantero Avant	Rear Trasero Arrière
----------------------	---------------------------	----------	--	-----------------------------	----------------------------

GMC TRUCK ... cont'd

C - Series (C6500, C7500, C8500) Topkick

1990-09	Conventional Cab				
	- Front Shock with O.E.M. Number	15123676		83136
		15174898		83136
		15588554		83136
		15887728		83136
		19152843		83136
		22064230		83136
		88982682		83136
1990- 1990-09	- With 11000, 13500, 15000 lb Taperleaf Springs	22064231		85324
	- With 15000, 19000, 21000 lb Multileaf Springs	15174902		85071
		22064232		85071
		88982686		85071
1990-06	- With 16900 or 17850 lb Taperleaf Springs	21998392		85336
		22064489		85336
		88963409		85336
1990-	- With 19000, 21000, 23000 lb Taperleaf Springs (EXC Low Profile Vehicle)	22064233		83136
1983-99	Conventional Cab with 9100 to 17500 lb Rear Axle	22064432		85050
1995-99	Models with Hendrickson Air Suspension (Stamping number 47902-13)	12474915		83122 or 89406
		15963161		83122 or 89406
1996-99	Models with Hendrickson Air Suspension (Stamping number 47902-29)	12474917		83137
		15740554		83137
	Models with O.E.M. Number	88982684		83136
		88982688		85336

Coaches

	4100, 4900 Series	3182842		85711	85711
		3188599		85711	85711
		3192416		85711	85711
		4975552		85711	85711
	4500, 5300 Series	3166657		85700	85700
		3192333		85700	85700
	Models with O.E.M. Number	3175509		85735	85735
		3178106		85700	85700
		3178507		85700	85700
		3178995		85700	85700
		3189265		85700	85700
		5304059		85700	85700
		5316784		85700	85700
		5316794		85700	85700
		5316984		85313	85313
		5352857		85700	85700
		5527271		85700	85700
		5527272		85700	85700
		5549924		85700	85700

Gabriel Part Numbers that appear in BLUE are GasSLX, adjustable shocks. \ Los números de parte Gabriel imprimidos en AZUL son amortiguadores ajustables GasSLX. \ Les numéros de pièce Gabriel imprimés en BLEU sont des amortisseurs ajustables GasSLX.

★ Will be available in first quarter of 2011.

**Gabriel®**

Year Año Année	Model Modelo Modèle	O.E.M. #	Mount 	Front Delantero Avant	Rear Trasero Arrière
----------------------	---------------------------	----------	-----------	-----------------------------	----------------------------

GMC TRUCK ... cont'd**P - Series**

1992-96	Motorhome Chassis	22064231		85324
		22064233		83136

T - Series (T5500, T6500, T7500, T8500)

1997-	FL1 Tilt Cab with 8100 lb Axle	22064804		83136
		22064805		83136
		22165187		83136
		22165188		83136
1997-	FL2 Tilt Cab with 5000 to 11000 lb Axle	22064807		83136
		22166442		83136
1997-	FL3 Tilt Cab with 14575 lb Axle	22064806		83136
		22165189		83136
1999	Models with Hendrickson Air Suspension (Stamping number 47902-13)	12474915		83122 or 89406
		15963161		83122 or 89406
1990-99	Tilt Cab with 11000, 13500, 15000 lb Taperleaf Springs	22064231		85324
1990-06	Tilt Cab with 15000, 19000, 21000 lb Multileaf Springs	15174902		85071
		22064232		85071
1992-99	Tilt Cab with 16900 lb Taperleaf Springs RR SUSP(GZH) Heavy Duty	22064489		85336
1992-06	Tilt Cab with 16900 lb Taperleaf Springs RR SUSP(GZH) Heavy Duty	21998392		85336
		88963409		85336
1992-99	Tilt Cab with 19000, 21000, 23000 lb Taperleaf Springs (EXC Low Profile Veh.)	22064233		83136

W - Series (Isuzu)

2002 - 09	W4 Models with O.E.M. Number	8-97253665-0		★ 83159
		898098-0580		★ 83159
		898098-0590		★ 83159
		97253665		★ 83159
		98098058		★ 83159
		98098059		★ 83159
1986-90	W4 Series	8-94454-986-0		G60177
		8-94454-987-0		G60177
		9-51630-647-1		G60177
1983-95	W4 Series	8-51630-666-0		85012 or 89413
		9-51630-666-0		85012 or 89413
1989-92	W4 Series Flatlow	8-51630-666-0		85012 or 89413
1989-90	W4 Series Flatlow	9-51630-647-1		G60177
2003 - 09	W4 Series with 11000 lb & 13000 lb Suspension	97253620		G60177
86-Aug95	W4 Series with 11000 lb Suspension	97083027		G60177
1987-96	W4 Series with 13000 lb Suspension	94454987		G60177
		97083029		G60177
1988-99	W5 Series	1-51630-217-0		83114
		1-51630-217-1		83114
		1-51630-219-1		83114

Gabriel Part Numbers that appear in BLUE are GasSLX, adjustable shocks. | Los números de parte Gabriel imprimidos en AZUL son amortiguadores ajustables GasSLX. | Les numéros de pièce Gabriel imprimés en BLEU sont des amortisseurs ajustables GasSLX.



















★ Will be available in first quarter of 2011.































Gabriel®

Year Año Année	Model Modelo Modèle	O.E.M. #	Mount 	Front Delantero Avant	Rear Trasero Arrière
----------------------	---------------------------	----------	--	-----------------------------	----------------------------

GMC TRUCK ... cont'd

2003 - 09	W5 Series with 11000 lb & 13000 lb Suspension	97253620		G60177
2003 - 09	W5 Series with O.E.M. Number	97253665		★ 83159
1986 - 91	W6 Series	1-51630-168-1		G60164
		1-51630-217-1		83114
	Models with O.E.M. Number	8-97083-029-0		G60177
		898098-1250		G60177
		898098-1270		G60177
		90044769		83207 or 89407
		90044770		83207 or 89407
		94033786		83114
		94051090		83114
		94057593		83114
		94454987		G60177
		9-51630-666-2		85012 or 89413
		97083027		G60177
		97083029		G60177
		97201960		G60177
		98098125		G60177
		98098127		G60177

	Models with O.E.M. Number	15642943		83136
		22024061		85704
		22025067		85704
		22025305		85704
		22099889		85336
		U0109-014		83400
	Additional O.E.M. Interchanges	22007703		83303	
		22012067		85700	
		22012079		85701	
		22012082		85702	
		22012083		85711	
		22012090		85308 or 89422	
		22012091		85303 or 89422	
		22012114		85700	
		22012131		85711	
		22017530		83303	
		22024062		85701	
		22024673		85710	
		22045526		85702	
		22046481		85702	
		22046485		85710	
		22046499		85710	
		22052014		85702	
		22052424		85710	
		3171696		85307	
		3172948		85303 or 89422	
		3175509		85735	
		3178157		85700	
		3178233		85734	

Gabriel Part Numbers that appear in BLUE are GasSLX, adjustable shocks. \ Los números de parte Gabriel imprimidos en AZUL son amortiguadores ajustables GasSLX. \ Les numéros de pièce Gabriel imprimés en BLEU sont des amortisseurs ajustables GasSLX.























































★ Will be available in first quarter of 2011.



Gabriel®

Year Año Année	Model Modelo Modèle	O.E.M. #	Mount 	Front Delantero Avant	Rear Trasero Arrière
----------------------	---------------------------	----------	--	-----------------------------	----------------------------

GMC TRUCK ... cont'd

Year Año Année	Model Modelo Modèle	O.E.M. #	Mount 	Front Delantero Avant	Rear Trasero Arrière
	Additional O.E.M. Interchanges	3178507			85700
		3178995			85700
		3188626			85300 or 89419
		3188729			85303 or 89422
		4939852			85308 or 89422
		4939967			85308 or 89422
		4940601			83216
		4940627			83203 or 89436
		4940640			83216
		4940650			83207 or 89407
		4940654			83216
		4940660			83207 or 89407
		4963844			85307
		4964853			83217
		4974401			85700
		4975429			85300 or 89419
		4975479			83400
		4975480			83400
		4975501			85700
		4975515			85701
		4975516			85702
		4975518			85704
		4975538			85700
		4975549			83216
		4975550			85702
		5171068			83216
		5316791			83219
		5316792			85305
		5316793			85305
		5321920			85307
		5321929			85307
		5348631			83203 or 89436
		5352858			85305
		5353054			85303 or 89422
		5355798			85307
		5357955			85300 or 89419
		5357956			85734
		5357959			85300 or 89419
		5361994			85734
		5374779			85308 or 89422
		5374999			85307
		5385939			85307
		5392387			85303 or 89422
		5394448			85305
		5394467			85305
		5394468			85735
		5455798			85307
		5513489			83216
		5513716			85304
		5516459			85305
		5522781			85735
		5522794			85308 or 89422
		5522818			85305

Gabriel Part Numbers that appear in BLUE are GasSLX, adjustable shocks. | Los números de parte Gabriel imprimidos en AZUL son amortiguadores ajustables GasSLX. |
 Les numéros de pièce Gabriel imprimés en BLEU sont des amortisseurs ajustables GasSLX.



















































★ Will be available in first quarter of 2011.



Gabriel®

Year Año Année	Model Modelo Modèle	O.E.M. #	Mount 	Front Delantero Avant	Rear Trasero Arrière
----------------------	---------------------------	----------	---	-----------------------------	----------------------------

GMC TRUCK ... cont'd

Year Año Année	Model Modelo Modèle	O.E.M. #	Mount 	Front Delantero Avant	Rear Trasero Arrière
	Additional O.E.M. Interchanges	5527001			85300 or 89419
		5527606			85305
		5531027			85301
		5531435			85307
		5531436			85307
		5531437			85307
		5532026			85304
		5532425			83207 or 89407
		5532433			83207 or 89407
		5532675			85307
		5533699			85302 or 89420
		5534430			85303 or 89422
		5534439			85304
		5534447			85303 or 89422
		5544112			83216
		5544581			85302 or 89420
		5544716			85304
		5544717			85304
		5544812			83308
		5544818			85735
		5549899			83207 or 89407
		5549925			85304
		5552111			85304
		5552112			85307
		5552114			83216
		5552205			83217
		5552206			83214
		5552207			83217
		5552208			83217
		5552209			83215
		5552210			85308 or 89422
		5552244			85308 or 89422
		5552285			83214
		5552286			83217
		5552287			83217
		5552288			83217
		5552453			85301
		5552527			85735
		5554184			85302 or 89420
		5554589			85307
		5554596			85303 or 89422
		5554814			85302 or 89420
		5554959			83401
		5554995			85305
		5559363			83203 or 89436
		5585939			85307
		684280			83209 or 89414
		97-2210-00153			85701
		97-2210-00164			85708
		97-2210-00170			85733

Gabriel Part Numbers that appear in BLUE are GasSLX, adjustable shocks. \ Los números de parte Gabriel imprimidos en AZUL son amortiguadores ajustables GasSLX. \ Les numéros de pièce Gabriel imprimés en BLEU sont des amortisseurs ajustables GasSLX.

★ Will be available in first quarter of 2011.

**Gabriel®**

Year Año Année	Model Modelo Modèle	O.E.M. #	Mount 	Front Delantero Avant	Rear Trasero Arrière
----------------------	---------------------------	----------	-----------	-----------------------------	----------------------------

GRANNING SUSPENSION

	Model L120 Self Steer Axle	701071-01		646155	646155
	Models T950-1200, -1400, -1700	2697		85712
	Models with O.E.M. Number	1085 680162	 	83214 85300 or 89419

GREAT DANE TRAILER

If using the shock stamping number, identification of the trailer suspension is necessary to determine what section of the catalog to refer to. Some possible options can be Chalmers, Hendrickson, Neway, Ridewell, Reyco.					
	Reyco Suspension 87	18163-01		83207 or 89407
	Reyco Suspension 88	18164-01		83122 or 89406
	Trailers with Great Dane part number	HENS-20001 HENS-20002 HENS-20126 HENS-21292 HENS-23566 HENS-23649 HENS-24088 MER202447 REY18165-01	 	85000 or 89436 85000 or 89436 85323 or 89436 85052 85000 or 89436 85938 85000 or 89436 85919 85006
	Trailers with Reyco 86 AR / RS 1015, 1035, 3035 Slider Air Suspension	18165-01		85006

GREYHOUND BUS

	City Cruiser	12 TA-01-013		85303 or 89422	85303 or 89422
	MC5, MC7, MC8	12B-5-1 3178157	 	85700 85700	85700 85700
	Additional O.E.M. Interchanges	3166657 3178154 3192333 5316984 690029	 	85700 85735 85700 85313 85700	

Gabriel Part Numbers that appear in BLUE are GasSLX, adjustable shocks. | Los números de parte Gabriel imprimidos en AZUL son amortiguadores ajustables GasSLX. | Les numéros de pièce Gabriel imprimés en BLEU sont des amortisseurs ajustables GasSLX.















★ Will be available in first quarter of 2011.



Gabriel®

Year Año Année	Model Modelo Modèle	O.E.M. #	Mount 	Front Delantero Avant	Rear Trasero Arrière
----------------------	---------------------------	----------	--	-----------------------------	----------------------------

GRUMMAN BUS

Model 870 Flex Bus	22024506		85703
	22025066		85703
	22025067		85704
	22025305		85704
	97-2201-00001		85703
	97-2201-00002		85703
	97-2201-00003		85703
	97-2201-00004		85703
	97-2201-00005		85703
	97-2210-00001		85704
	97-2210-00002		85704
	97-2210-00003		85704
	97-2210-00004		85704
	97-2210-00005		85704

HARDEE MFG















Models with O.E.M. Number	8030223		83207 or 89407
	AS789B		85014

HAUSMAN

Models with O.E.M. Number	695110		85318
	695119		85702
	695198		85706

HENDRICKSON TRAILER SUSPENSION SYSTEMS

Intraax

AA230T & AA250T (Models with O.E.M. Number)	A-20002		85000 or 89436
	A-20126		85323 or 89436
	A-20889		85323 or 89436
	B-22345		85911
AAEDT 30K - (w/14" and 15" Ride Height- High Damping) - (w/14" Ride Height) - (w/15", 16" & 17" Ride Height)	B-25436		89430
	B-23361		85911
	B-25515		85338
AANT 23K - (High Damping) - (Hvy Duty) - (Limited Rebound) - (Standard)	B-24023		85738
	B-24125		85323 or 89436
	B-23361		85911
	B-23566		85000 or 89436
AAT 23K - (High Damping) - (Hvy Duty) - (Limited Rebound) - (Standard)	B-24023		85738
	B-24125		85323 or 89436
	B-23361		85911
	B-23566		85000 or 89436

Gabriel Part Numbers that appear in BLUE are GasSLX, adjustable shocks. \ Los números de parte Gabriel imprimidos en AZUL son amortiguadores ajustables GasSLX. \ Les numéros de pièce Gabriel imprimés en BLEU sont des amortisseurs ajustables GasSLX.

★ Will be available in first quarter of 2011.

**Gabriel®**

Year Año Année	Model Modelo Modèle	O.E.M. #	Mount 	Front Delantero Avant	Rear Trasero Arrière
----------------------	---------------------------	----------	-----------	-----------------------------	----------------------------

HENDRICKSON TRAILER SUSPENSION SYSTEMS ... cont'd

	AAT 25K				
	- (High Damping)	B-24023		85738
	- (Hvy Duty)	B-24125		85323 or 89436
	- (Limited Rebound)	B-23361		85911
	- (Standard)	B-23566		85000 or 89436
	AAT 30K	B-24023		85738
	Low Ride Height Models with				
	- (10.5" to 15" Ride Height)	B-23013		85000 or 89436
	- (15.5" to 21" Ride Height - High Damping)	B-23316		89437
	- (15.5" to 21" Ride Height - Std Damping)	B-23315		85029
	- (6.5" to 8" Ride Height - High Damping)	B-22312		85939
	- (6.5" to 8" Ride Height)	B-22311		85045

Top Mount Style

	HT190T (All Models)	A-20001		85000 or 89436
	HT230T				
	- (All except Models listed below)	A-20002		85000 or 89436
	- (TA14-020)	B-22345		85911
	- (TA15-521, TA17-521)	B-21553		85738
	- (TA15-522, TA17-522)	B-21699	
	- (-14-020, -14-021, TA14-021)	A-2212		85029
	- (-14-17, -15-17, -15-517, -17-517, TA15-517, TA15-520, TA17-517)	A-20126		85323 or 89436
	- (-14-7, -14-11, -15-7, -15-11, -15-12, -15-28, TA14-7, TA15-7, TA16-7, TA17-7, TB14-33, TB15-28)	A-2160		85014
	HT250T (All Models)	A-2212		85029
	HT300T & N-HT300T				
	- (All except Models listed below)	A-20126		85323 or 89436
	- (-15-007, -15-011, -15-021, -17-007, -17-011, -17-012, TB19-007, TB19-020)	A-2160		85014
	- (-15-017, -15-518, -17-518, -17-520)	B-21553		85738
	- (TB15-027)	B-24579		85939
	- (TB15-518)	B-21699	
	T-15-140, -155, -172, 244, -376	A-2218		85030 or 89440
	T-15-324	A-2160		85014
	T-17-141, -174, -284	A-2218		85030 or 89440
	TMB-14-120	A-2213		85010
	TMB-17-135	A-4084		85005 or 89430

Gabriel Part Numbers that appear in BLUE are GasSLX, adjustable shocks. \ Los números de parte Gabriel imprimidos en AZUL son amortiguadores ajustables GasSLX. \ Les numéros de pièce Gabriel imprimés en BLEU sont des amortisseurs ajustables GasSLX.

★ Will be available in first quarter of 2011.

































Gabriel®

Year Año Année	Model Modelo Modèle	O.E.M. #	Mount 	Front Delantero Avant	Rear Trasero Arrière
----------------------	---------------------------	----------	--	-----------------------------	----------------------------

HENDRICKSON TRAILER SUSPENSION SYSTEMS ... cont'd

UnderSlung Style

	HT190U - (All except Models listed below) - (-6.75-001 / -6.75-002 / -6.75-003 / -6.75-020) - (U-7.5-517) - (U-9-022 / UB7-021)	A-20001 A-2212 A-20002 B-23649	   	85000 or 89436 85029 85000 or 89436 85938
	HT250U & N-HT250U - (All except Models listed below) - (U-6.5-030, U-6.5-031) - (U-6.5-27, U-9-27 & -28, U-14-28, UB6.5-522, UB7.5-27 & -522, UB9-522, UB12-27 & -28, UB14-27 & -28) - (U-6.5-517, U-7.5-17, U-7.5-517, U-9-517, U-12-517, U-14-514, UB6.5-517, UB7.5-517) - (U-7.5-021, U-7.5-022) - (U-9-20 & -21 & -23, U-9.5-26, U-15-22, UB9-22, UB15-22)	A-20002 A-2160 B-21553 A-20126 A-1667 A-2212	     	85000 or 89436 85014 85738 85323 or 89436 85000 or 89436 85029
	HT250US (Models with Angled and Frame Clearance Mount) - (Standard Travel w/ 6.5", 7.5" & 14" Ride Height -High Damping) - (Standard Travel w/ 6.5", 7.5" & 14" Ride Height)	B-24579 B-23651	 	85939 85045
	HT250US (Models with O.E.M. Number)	B-21936 B-21947 B-22862	  	85938 85052 85045
	HT250US (Models with Remote Shock Mount) - (Extended Rebound w/ 6.5" to 9" Ride Height -High Damping) - (Extended Rebound w/ 6.5" to 9" Ride Height) - (Standard Travel w/ 12" to 14" Ride Height) - (Standard Travel w/ 5.5" to 6.5" Ride Height) - (Standard Travel w/ 7.5" to 9" Ride Height -High Damping) - (Standard Travel w/ 7.5" to 9" Ride Height)	B-23316 A-2212 A-2212 B-23650 B-23743 B-23649	     	89437 85029 85029 85052 85938 85938
	HT250US (Models with Standard Shock Mount) - (Extended Rebound w/ 6.5" Ride Height -High Damping) - (Extended Rebound w/ 6.5" Ride Height) - (Standard Travel w/ 3.5" to 4" Ride Height) - (Standard Travel w/ 5.5" to 6.5" Ride Height) - (Standard Travel w/ 7.5" to 14" Ride Height -High Damping) - (Standard Travel w/ 7.5" to 14" Ride Height)	B-24579 B-23651 B-23548 B-23650 B-23743 B-23649	     	85939 85045 85079 85052 85938 85938
	HT250U-Y (All Models)	A-20002		85000 or 89436
	HT300U & N-HT300U - (All except Models listed below) - (U-7.5-519, U-9-011, U-9-519, U-12-011, U-12-015, U-14-011, U-14-015, U-17-011)	A-20126 B-21699	 	85323 or 89436

Gabriel Part Numbers that appear in BLUE are GasSLX, adjustable shocks. \ Los números de parte Gabriel imprimidos en AZUL son amortiguadores ajustables GasSLX. \ Les numéros de pièce Gabriel imprimés en BLEU sont des amortisseurs ajustables GasSLX.

★ Will be available in first quarter of 2011.

**Gabriel®**

Year Año Année	Model Modelo Modèle	O.E.M. #	Mount 	Front Delantero Avant	Rear Trasero Arrière
----------------------	---------------------------	----------	-----------	-----------------------------	----------------------------

HENDRICKSON TRAILER SUSPENSION SYSTEMS ... cont'd

	T-12-139	A-2213		85010
	T-23-US-9-011	A-2213		85010
	T30-US-9, -17	A-10348		85043
	T-4-392	A-2160		85014
	T-6-062, -295, -370, -422	A-1667		85000 or 89436
	T-6-071	A-2212		85029
	T-9-084	A-2240		85013 or 89414
	T-9-106, -278, -313	A-4084		85005 or 89430
	T-9-175	A-2160		85014
	T-9-325	A-2218		85030 or 89440
	T-9-390	A-2213		85010

Vantraax

	HKA180	B-24088		85000 or 89436
	HKA200				
	- (Hvy Duty)	B-24125		85323 or 89436
	- (Standard)	B-23566		85000 or 89436
	HKA250				
	- (Hvy Duty)	B-24125		85323 or 89436
	- (Standard)	B-23566		85000 or 89436
	HKANT 40K	B-24088		85000 or 89436
	HKANT 46K	B-23566		85000 or 89436
	HKAT 46K	B-23566		85000 or 89436

Others

	AB-32-001	A-1667		85000 or 89436
	HK190T (Slider Air Suspension)	A-21292		85052
	HK230 (Slider Air Suspension)	A-21292		85052
	HS190T (Slider Air Suspension)	A-20001		85000 or 89436
	HS230 (Slider Air Suspension)	A-20002		85000 or 89436
	Models with O.E.M. Number				
		A-20886		85738 or 89440
		S-20886		85738 or 89440
	MT-45,MTL45,MTL-50	S-1667		85000 or 89436
	TDC-014	A-2212		85029

Gabriel Part Numbers that appear in BLUE are GasSLX, adjustable shocks. | Los números de parte Gabriel imprimidos en AZUL son amortiguadores ajustables GasSLX. | Les numéros de pièce Gabriel imprimés en BLEU sont des amortisseurs ajustables GasSLX.













































★ Will be available in first quarter of 2011.



Gabriel®

Year Año Année	Model Modelo Modèle	O.E.M. #	Mount 	Front Delantero Avant	Rear Trasero Arrière
----------------------	---------------------------	----------	---	-----------------------------	----------------------------

HENDRICKSON TRAILER SUSPENSION SYSTEMS ... cont'd

Year Año Année	Model Modelo Modèle	O.E.M. #	Mount 	Front Delantero Avant	Rear Trasero Arrière
	Models with O.E.M. Number	654951		85000 or 89436
		659024		85052
		665190		85006
		665246		85043
		665405		85030 or 89440
		665406		85010
		665531		85000 or 89436
		665532		85013 or 89414
		665533		85005 or 89430
		665536		85000 or 89436
		665693		85938
		665694		85052
		665698		85911
		665733		85045
		665756		85000 or 89436
		665758		85938
		665759		85052
		665760		85045
		665761		85911
		665763		85079
		665764		85029
		665765		83150
		665766		85000 or 89436
		665767		85045
		665767		85045
		671779		89414
		671948		85000 or 89436
		680341		85323 or 89436
		680463		89440
		680467		85323 or 89436
		680509		85738
		680565		85738
		680566		85938
		680568		85323 or 89436
		680570		89437
		680571		85738
		680573		85939
		680573		85939
		680579		85939
		680614		85338
		680616		89430
		680617		85337
		680702		85323 or 89436

Gabriel Part Numbers that appear in BLUE are GasSLX, adjustable shocks. \ Los números de parte Gabriel imprimidos en AZUL son amortiguadores ajustables GasSLX. \ Les numéros de pièce Gabriel imprimés en BLEU sont des amortisseurs ajustables GasSLX.







































★ Will be available in first quarter of 2011.



Gabriel®

Year Año Année	Model Modelo Modèle	O.E.M. #	Mount 	Front Delantero Avant	Rear Trasero Arrière
----------------------	---------------------------	----------	--	-----------------------------	----------------------------

HENDRICKSON TRAILER SUSPENSION SYSTEMS ... cont'd

Year	Model	O.E.M. #	Mount	Front	Rear
	Models with O.E.M. Number	680756		85323 or 89436
		680769		85911
		680776		85338
		98583-019		85323 or 89436
		98583-020		89414
		A-14583		85000 or 89436
		A-1668		85000 or 89436
		A-20345	
		A-20819	
		A-20886		89440
		A-20887		85005 or 89430
		A-21292		85052
		A-2230		85005 or 89430
		A-2232		85005 or 89430
		A-2240-1		85043
		A-2471		85006
		A-4089		83209 or 89414
		A-4890		85712
		B-21832		85323 or 89436
		B-21936		85938
		B-22312		85939
		B-23014		85738
		B-23290		83150
		B-23362		89437
		B-23649		85938
		B-23743		85938
		B-24023		85738
		B-25437		85337
		B-25515		85338
		B-26652		85000 or 89436
		B-29432		85323 or 89436
		B-29678		85911
		B-29826		85338
		S-10348		85043
		S-14583		85000 or 89436
		S-1668		85000 or 89436
		S-20001		85000 or 89436
		S-20002		85000 or 89436
		S-20126		85323 or 89436
		S-20886		89440
		S-20887		85005 or 89430

Gabriel Part Numbers that appear in BLUE are GasSLX, adjustable shocks. | Los números de parte Gabriel imprimidos en AZUL son amortiguadores ajustables GasSLX. | Les numéros de pièce Gabriel imprimés en BLEU sont des amortisseurs ajustables GasSLX.













































★ Will be available in first quarter of 2011.



Gabriel®

Year Año Année	Model Modelo Modèle	O.E.M. #	Mount 	Front Delantero Avant	Rear Trasero Arrière
----------------------	---------------------------	----------	---	-----------------------------	----------------------------

HENDRICKSON TRAILER SUSPENSION SYSTEMS ... cont'd

Year Año Année	Model Modelo Modèle	O.E.M. #	Mount 	Front Delantero Avant	Rear Trasero Arrière
	Models with O.E.M. Number	S-20889		85323 or 89436
		S-21292		85052
		S-21553		85738
		S-2160		85014
		S-21699	
		S-21832		85323 or 89436
		S-21936		85938
		S-21947		85052
		S-2212		85029
		S-2213		85010
		S-2218		85030 or 89440
		S-2230		85005 or 89430
		S-22311		85045
		S-22312		85939
		S-2232		85005 or 89430
		S-22345		85911
		S-2240		85013 or 89414
		S-22862		85045
		S-23013		85000 or 89436
		S-23014		85738
		S-23290		83150
		S-23315		85029
		S-23316		89437
		S-23361		85911
		S-23362		89437
		S-23548		85079
		S-23566		85000 or 89436
		S-23649		85938
		S-23650		85052
		S-23651		85045
		S-23743		85938
		S-24023		85738
		S-24088		85000 or 89436
		S-24125		85323 or 89436
		S-24579		85939
		S-2471		85006
		S-25436		89430
		S-25437		85337
		S-25515		85338
		S-26652		85000 or 89436
		S-29432		85323 or 89436
		S-29678		85911
		S-29826		85338
		S-4084		85005 or 89430

Gabriel Part Numbers that appear in BLUE are GasSLX, adjustable shocks. \ Los números de parte Gabriel imprimidos en AZUL son amortiguadores ajustables GasSLX. \ Les numéros de pièce Gabriel imprimés en BLEU sont des amortisseurs ajustables GasSLX.

★ Will be available in first quarter of 2011.

**Gabriel®**

Year Año Année	Model Modelo Modèle	O.E.M. #	Mount 	Front Delantero Avant	Rear Trasero Arrière
----------------------	---------------------------	----------	-----------	-----------------------------	----------------------------

HENDRICKSON TRAILER SUSPENSION SYSTEMS ... cont'd

	Models with O.E.M. Number	S-4089		83209 or 89414
		S-4890		85712

HENDRICKSON TRUCK SUSPENSION SYSTEMS**Airtek - Series**

	Airtek Front - Used on Freightliner / Western Star - Used on International - Used on Volvo / Mack	58913-003		85932 or 89453	
		64838-001		85933 or 89454	
		65992-001		85955	
		65992-002		85955	
		64838-002		85933 or 89454	

Comfort Air - Series

	Conventional Hino Models with Single Axle Air Suspension	60670-013		83148
		60670-017		83148
	Models with O.E.M. Number	60998-001		85337

Firemaax - Series

	Firemaax 240 Air Suspensions - Disc Brake Applications with 8 1/2" to 10" Ride Height - Drum Brake Applications with 8 1/2" to 10" Ride Height - Standard with 12 1/2" - 14 3/8" - 15 1/2" Ride Height - Standard with 8 1/2" to 10" Ride Height	60665-014		85962
		60665-018		85961
		60665-011		★ 85967
		60657-003		85072
	Firemaax 270 Air Suspensions - Disc Brake Applications with 8 1/2" to 10" Ride Height - Drum Brake Applications with 8 1/2" to 10" Ride Height	60665-015		★ 85966
		60665-013		★ 85965
	Firemaax 480 Air Suspensions - Disc Brake Applications with 8 1/2" to 10" Ride Height - Drum Brake Applications with 8 1/2" to 10" Ride Height - Standard with 12 1/2" - 14 3/8" - 15 1/2" Ride Height - Standard with 8 1/2" to 10" Ride Height	60665-014		85962
		60665-018		85961
		60665-011		★ 85967
		60657-003		85072
	Firemaax 540 Air Suspensions - Disc Brake Applications with 8 1/2" to 10" Ride Height - Drum Brake Applications with 8 1/2" to 10" Ride Height	60665-015		★ 85966
		60665-013		★ 85965
	Firemaax EX 242 Air Suspensions - Standard with 12 1/2" - 14 3/8" - 15 1/2" Ride Height - Standard with 8 1/2" to 10" Ride Height	60665-011		★ 85967
		60657-003		85072
	Firemaax EX 272 Air Suspensions - Disc Brake Applications with 8 1/2" to 10" Ride Height - Drum Brake Applications with 8 1/2" to 10" Ride Height	60665-015		★ 85966
		60665-013		★ 85965

Gabriel Part Numbers that appear in BLUE are GasSLX, adjustable shocks. \ Los números de parte Gabriel imprimidos en AZUL son amortiguadores ajustables GasSLX. \ Les numéros de pièce Gabriel imprimés en BLEU sont des amortisseurs ajustables GasSLX.





★ Will be available in first quarter of 2011.

















Gabriel®

Year Año Année	Model Modelo Modèle	O.E.M. #	Mount 	Front Delantero Avant	Rear Trasero Arrière
----------------------	---------------------------	----------	--	-----------------------------	----------------------------









HENDRICKSON TRUCK SUSPENSION SYSTEMS ... cont'd

	Firemaax EX 482 Air Suspensions				
	- Standard with 12 1/2" - 14 3/8" - 15 1/2" Ride Height	60665-011		★ 85967
	- Standard with 8 1/2" to 10" Ride Height	60657-003		85072
	Firemaax EX 542 Air Suspensions				
	- Disc Brake Applications with 8 1/2" to 10" Ride Height	60665-015		★ 85966
	- Drum Brake Applications with 8 1/2" to 10" Ride Height	60665-013		★ 85965

HA - Series

	HA - 180 (Used on all except Mack)	47902-13		83122 or 89406
		47902-8		83122 or 89406
	HA - 200 (Used on all except Mack)	47902-13		83122 or 89406
		47902-8		83122 or 89406
	HA - 230 (Used on all except Mack)	47902-13		83122 or 89406
		47902-8		83122 or 89406
	HA - 360 (Used on all except Mack)	47902-13		83122 or 89406
		47902-8		83122 or 89406
	HA - 400 (Used on all except Mack)	47902-13		83122 or 89406
		47902-8		83122 or 89406
	HA - 460 (Used on all except Mack)	47902-13		83122 or 89406
		47902-8		83122 or 89406
	HA Series Air Suspension (All Series used on Mack)	47902-19		83123 or 89405
		47902-9		83123 or 89405
	HA-360/400/460 Edge System High Torque Rise	60675-003	

HAS - Series

	HAS - 120L	60670-010		83149
	HAS - 150L	60670-003		83149
	HAS - 190	60675-003	
		60670-005		83137
	HAS - 190L	60670-008		83123 or 89405
	HAS - 210	60675-003	
		60670-005		83137
	HAS - 210L	60670-008		83123 or 89405























Gabriel Part Numbers that appear in BLUE are GasSLX, adjustable shocks. \ Los números de parte Gabriel imprimidos en AZUL son amortiguadores ajustables GasSLX. \ Les numéros de pièce Gabriel imprimés en BLEU sont des amortisseurs ajustables GasSLX.

★ Will be available in first quarter of 2011.







**Gabriel®**

Year Año Année	Model Modelo Modèle	O.E.M. #	Mount 	Front Delantero Avant	Rear Trasero Arrière
----------------------	---------------------------	----------	--	-----------------------------	----------------------------

HENDRICKSON TRUCK SUSPENSION SYSTEMS ... cont'd

	HAS - 230 - High Torque - Standard	60675-003 60670-005	  83137
	HAS - 230L	60670-008		83123 or 89405
	HAS - 360 - High Torque - Standard	60675-003 60670-005	  83137
	HAS - 400 - High Torque - High Torque Inboard Rear - Mack & Kenworth Air Suspensions - Standard - Standard Inboard Rear	60675-003 60675-006 47902-25 60670-005 60670-007	     83125 83137 83144
	HAS - 400L	60670-008		83123 or 89405
	HAS - 402 - High Torque - High Torque Inboard Rear - Standard - Standard Inboard Rear	60675-003 60675-006 60670-005 60670-007	    83137 83144
	HAS - 402L	60670-008		83123 or 89405
	HAS - 40LH - High Torque - Standard	60685-001 60680-001	 83111
	HAS - 460 - High Torque - High Torque Inboard Rear - Standard - Standard Inboard Rear	60675-003 60675-006 60670-005 60670-007	    83137 83144
	HAS - 460L	60670-008		83123 or 89405

HN - Series

	HN - 400 - Models built between Mar/96 - Sept/97 - Models built between Nov/88 - Feb/96	60680-003 60670-002	 	83112 83207 or 89407
	HN - 402 - Models built between Apr/96 - Dec/04	57241-003 60680-003	 	83112 83112
	HN - 460 - Models built between Mar/96 - Sept/97	57241-003 60680-003	 	83112 83112

Gabriel Part Numbers that appear in BLUE are GasSLX, adjustable shocks. \ Los números de parte Gabriel imprimidos en AZUL son amortiguadores ajustables GasSLX. \ Les numéros de pièce Gabriel imprimés en BLEU sont des amortisseurs ajustables GasSLX.

★ Will be available in first quarter of 2011.

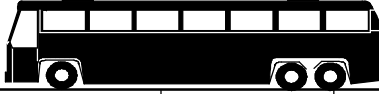























Gabriel®

Year Año Année	Model Modelo Modèle	O.E.M. #	Mount 	Front Delantero Avant	Rear Trasero Arrière
----------------------	---------------------------	----------	--	-----------------------------	----------------------------

HENDRICKSON TRUCK SUSPENSION SYSTEMS ... cont'd

	- Models built between Nov/88 - Feb/96	60670-002		83207 or 89407
	HN - 462 - Models built between Apr/96 - Dec/04	57241-003 60680-003	 	83112 83112
	HN - 522 - Models built between Apr/96 - Dec/04	60680-003		83112
	HNT - 460	47902-18		85030 or 89440

Primaax - Series

	230 Air Suspensions - For International Models with 9" Ride Height - Standard with 12 1/2" - 14 3/8" - 15 1/2" Ride Height - Standard with 8 1/2" to 10" Ride Height	60657-003 60665-011 60657-003	  	85072 ★ 85967 85072
	260 Air Suspensions - Disc Brake Applications with 8 1/2" to 10" Ride Height - Drum Brake Applications with 8 1/2" to 10" Ride Height	60665-015 60665-013	 	★ 85966 ★ 85965
	460 Air Suspensions - For International Models with 9" Ride Height - Standard with 12 1/2" - 14 3/8" - 15 1/2" Ride Height - Standard with 8 1/2" to 10" Ride Height	60657-003 60665-011 60657-003	  	85072 ★ 85967 85072
	520 Air Suspensions - Disc Brake Applications with 8 1/2" to 10" Ride Height - Drum Brake Applications with 8 1/2" to 10" Ride Height	60665-015 60665-013	 	★ 85966 ★ 85965
	690 Air Suspensions - For International Models with 9" Ride Height - Standard with 12 1/2" - 14 3/8" - 15 1/2" Ride Height - Standard with 8 1/2" to 10" Ride Height	60657-003 60665-011 60657-003	  	85072 ★ 85967 85072
	780 Air Suspensions - Disc Brake Applications with 8 1/2" to 10" Ride Height - Drum Brake Applications with 8 1/2" to 10" Ride Height	60665-015 60665-013	 	★ 85966 ★ 85965
	EX 232 Air Suspensions - Standard with 12 1/2" - 14 3/8" - 15 1/2" Ride Height - Standard with 8 1/2" to 10" Ride Height	60665-011 60657-003	 	★ 85967 85072
	EX 262 Air Suspensions - Disc Brake Applications with 8 1/2" to 10" Ride Height - Drum Brake Applications with 8 1/2" to 10" Ride Height	60665-015 60665-013	 	★ 85966 ★ 85965
	EX 462 Air Suspensions - Standard with 12 1/2" - 14 3/8" - 15 1/2" Ride Height - Standard with 8 1/2" to 10" Ride Height	60665-011 60657-003	 	★ 85967 85072
	EX 522 Air Suspensions - Disc Brake Applications with 8 1/2" to 10" Ride Height - Drum Brake Applications with 8 1/2" to 10" Ride Height	60665-015 60665-013	 	★ 85966 ★ 85965

Gabriel Part Numbers that appear in BLUE are GasSLX, adjustable shocks. \ Los números de parte Gabriel imprimidos en AZUL son amortiguadores ajustables GasSLX. \ Les numéros de pièce Gabriel imprimés en BLEU sont des amortisseurs ajustables GasSLX.

★ Will be available in first quarter of 2011.



Gabriel®

Year Año Année	Model Modelo Modèle	O.E.M. #	Mount 	Front Delantero Avant	Rear Trasero Arrière
----------------------	---------------------------	----------	-----------	-----------------------------	----------------------------

HENDRICKSON TRUCK SUSPENSION SYSTEMS ... cont'd

	EX 692 Air Suspensions				
	- Standard with 12 1/2" - 14 3/8" - 15 1/2" Ride Height	60665-011		★ 85967
	- Standard with 8 1/2" to 10" Ride Height	60657-003		85072
	EX 782 Air Suspensions				
	- Disc Brake Applications with 8 1/2" to 10" Ride Height	60665-015		★ 85966
	- Drum Brake Applications with 8 1/2" to 10" Ride Height	60665-013		★ 85965

Additional Applications

	AR2 - 400 Series	60665-012	
	AR2 - 460 Series	60665-012	
	HMX Haulmax with O.E.M. Number	60680-004		83143
		60680-005		83142
	MaxAir / AL-405 Models	57241-006		83111
	Parasteer Suspensions				
Sep98- Nov01	- Models with O.E.M. Number	59483-000		85919
		60665-005		85919
	RT2 & RTE2 (400 / 520) Series Air Suspension (Note: For Ride Height of 10.41" to 12.27" with 52" & 54" Beams and 8.52" to 10.37" with 60" Beams.)	57324-6		85904
	Models with O.E.M. Number	12738		83225
		47902-11		83207 or 89407
		47902-15		83137
		47902-26		83144
		47902-27		83123 or 89405
		47902-28		85013 or 89414
		47902-29		83149
		47902-3		85005 or 89430
		503610C2		83207 or 89407
		5554596		85303 or 89422
		57241-001		83111
		57241-002		83109
		57241-004		83110
		57324-11		85305
		57324-5		85903
		59048-001		83148
		59057-001		83137
		59057-002		85036 or 89405
		60657-007		85072
		60665-001	
		60665-002	
		60665-003		83137
		60665-004		85036 or 89405
		60665-009		85904
		60665-020		85919
		60665-024		85903

Gabriel Part Numbers that appear in BLUE are GasSLX, adjustable shocks. \ Los números de parte Gabriel imprimidos en AZUL son amortiguadores ajustables GasSLX. \ Les numéros de pièce Gabriel imprimés en BLEU sont des amortisseurs ajustables GasSLX.









































★ Will be available in first quarter of 2011.



Gabriel®

Year Año Année	Model Modelo Modèle	O.E.M. #	Mount 	Front Delantero Avant	Rear Trasero Arrière
----------------------	---------------------------	----------	--	-----------------------------	----------------------------

HENDRICKSON TRUCK SUSPENSION SYSTEMS ... cont'd

Year	Model	O.E.M. #	Mount	Front	Rear
	Models with O.E.M. Number	60670-001		83123 or 89405
		60670-004		83123 or 89405
		60670-006		83147
		60670-009		85013 or 89414
		60670-011		83148
		60675-001	
		60675-002	
		60675-004	
		60675-005	
		60680-002		83109
		60680-009		85083
		60680-012		85083
		654890		83207 or 89407
		654891		83149
		654894		83123 or 89405
		654895		83137
		654896		83147
		654897		83144
		654897		83144
		654898		83123 or 89405
		654899		85013 or 89414
		654900		83149
		654903		83111
		654904		83109
		654905		83112
		659000		83148
		659004		83123 or 89405
		659048		83143
		659049		83142
		659155		83147
		659202		83148
		659292		83148
		665816		85072
		665892		85072
		671006		85036 or 89405
		671007		83137
		671009		85919
		671030		85083
		671063		85083
		671105		85072
		671603		85919
		671606		85955
		671611		85955
		671704		85904
		671764		★ 85967
		671792		★ 85965

Gabriel Part Numbers that appear in BLUE are GasSLX, adjustable shocks. \ Los números de parte Gabriel imprimidos en AZUL son amortiguadores ajustables GasSLX. \ Les numéros de pièce Gabriel imprimés en BLEU sont des amortisseurs ajustables GasSLX.

★ Will be available in first quarter of 2011.



Gabriel®

Year Año Année	Model Modelo Modèle	O.E.M. #	Mount 	Front Delantero Avant	Rear Trasero Arrière
----------------------	---------------------------	----------	-----------	-----------------------------	----------------------------

HENDRICKSON TRUCK SUSPENSION SYSTEMS ... cont'd

Models with O.E.M. Number	671793		★ 85966
	671798		85962
	672009		85903
	680091		85303 or 89422
	680600		85305
	70018		85303 or 89422
	70021		85303 or 89422
	70088		85307
	98583-016		83147
	AE76164-3		85307
	AE76164-4		83225
	BE76164-2		85303 or 89422
	BE76164-3		85307
	BE76164-4		83225

HIGHWAY PRODUCT

Transit Bus with Air Suspension		83203 or 89436
Transit Bus with Leaf Spring Suspension		83203 or 89436	83203 or 89436
	A1-6-134		83207 or 89407
	A1-6-135		83203 or 89436

HINO

145 SERIES

2005-09	Trucks with O.E.M. Number	48500-3710		83126 or 89430
		485003710A		83126 or 89430
		48530-3280		G60067
		S4850-03710		83126 or 89430
		S4853-03280		G60067

165 SERIES

2005-09	Trucks with O.E.M. Number	48500-3710		83126 or 89430
		485003710A		83126 or 89430
		48530-3280		G60067
		S4850-03710		83126 or 89430
		S4853-03280		G60067

Gabriel Part Numbers that appear in BLUE are GasSLX, adjustable shocks. \ Los números de parte Gabriel imprimidos en AZUL son amortiguadores ajustables GasSLX. \ Les numéros de pièce Gabriel imprimés en BLEU sont des amortisseurs ajustables GasSLX.

★ Will be available in first quarter of 2011.

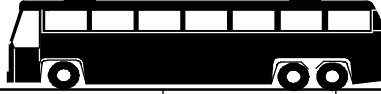







Gabriel®

Year Año Année	Model Modelo Modèle	O.E.M. #	Mount 	Front Delantero Avant	Rear Trasero Arrière
----------------------	---------------------------	----------	---	-----------------------------	----------------------------

HINO ... cont'd

185 SERIES

2010	Trucks with O.E.M. Number	S4850-03720		83140
2005-09	Trucks with O.E.M. Number	48500-3710		83126 or 89430
		485003710A		83126 or 89430
		48530-3280		G60067
		S4850-03710		83126 or 89430
		S4853-03280		G60067

238 SERIES

2005-10	Trucks with O.E.M. Number	48500-3720		83140
		S4850-03720		83140

258 SERIES

2005-10	Trucks with O.E.M. Number	48500-3720		83140
		S4850-03720		83140
		S4853-03290	

268, 268A SERIES

2005-10	Trucks with O.E.M. Number	48500-3720		83140
		S4850-03720		83140
		S4853-03290	



308 SERIES

2007 - 10	Trucks with O.E.M. Number	48500-3720		83140
		S4850-03720		83140













338 SERIES

2005-10	Trucks with O.E.M. Number	48500-3720		83140
		S4850-03720		83140
		S4853-03290	

358 SERIES

2007 - 10	Trucks with O.E.M. Number	48500-3720		83140
		S4850-03720		83140

FA, FB Series

1989-04	FA, FB Series Trucks with: - Front shocks with O.E.M. Number	48500-1950		83216
		48500-2750		G60164
		66639		G60164
		S4850-01950		83216
		S4850-02750		83216
1989-04	- Rear shocks with O.E.M. Number	34802		G60107
		48530-1910		G60107
		48530-2510		G60107
		S4853-01910		83216
		S4853-02510		83216
1989-96	FA14, FB14	48500-1950		G60164
		48530-1910		83216

Gabriel Part Numbers that appear in BLUE are GasSLX, adjustable shocks. \ Los números de parte Gabriel imprimidos en AZUL son amortiguadores ajustables GasSLX. \ Les numéros de pièce Gabriel imprimés en BLEU sont des amortisseurs ajustables GasSLX.

★ Will be available in first quarter of 2011.

**Gabriel®**

Year Año Année	Model Modelo Modèle	O.E.M. #	Mount 	Front Delantero Avant	Rear Trasero Arrière
----------------------	---------------------------	----------	--	-----------------------------	----------------------------











HINO ... cont'd

1993-97	FA1415 (FA15), FB1715 (FB15)	48500-1950		G60164
		48530-1910		83216
1992-96	FA15, FB15	48500-1950		G60164
		48530-1910		83216
1998	FA1517, FA1817, FB1817		G60075
		48530-2510		83216









FD Series

1998-03	FD Series Trucks with O.E.M. Number	48500-1801		83216
		48530-1880		83362
1986-87	FD16	48500-1801		83216
		48530-1880		83362
1988-91	FD17	48500-1801		83216
		48530-1880		83362
1992	FD20	48500-1801		83216
1993-97	FD2218, FD2218LD (FD5H). FE5H, FF5H	48500-1801		83216
		48530-1880		83362
1998	FD2220, FD2220 Lo Pro	48500-1801		83216

FE Series

1998-03	FE Series Trucks with O.E.M. Number	48500-1941		83141
		48530-1900		83104
2000-04	FE Series Trucks with: - Front shocks with O.E.M. Number - Rear shocks with O.E.M. Number	S4850-01941		83141
		S4853-01900		83104
		S4853-03280		G60067
1986-87	FE16	48500-1801		83216
		48530-1890		83104
1984-91	FE17, FE19	48530-1900		83104
1992	FE20	48530-1900		83104
1993-97	FE2618 (FE5H)	48530-1900		83104
1998	FE2620	48530-1880		83362

FF Series

1998-03	FF Series Trucks with O.E.M. Number	48500-1941		83141
		48530-1900		83104
1984-91	FF17, FF19	48530-1900		83104
1992	FF20, FF23	48530-1900		83104
1993-97	FF3018 (FF5H)	48530-1900		83104
1993-97	FF3020 (FF4H)	48530-1900		83104
1998	FF3320	48530-1880		83362
1987-88	FFC1	48530-1900		83104

FG Series

1984-85	FG19, FG22	48530-1900		83104
---------	------------	------------	---	-------	-------

Gabriel Part Numbers that appear in BLUE are GasSLX, adjustable shocks. | Los números de parte Gabriel imprimidos en AZUL son amortiguadores ajustables GasSLX. | Les numéros de pièce Gabriel imprimés en BLEU sont des amortisseurs ajustables GasSLX.

★ Will be available in first quarter of 2011.

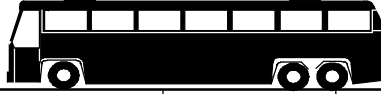

Gabriel®











Year Año Année	Model Modelo Modèle	O.E.M. #	Mount 	Front Delantero Avant	Rear Trasero Arrière
----------------------	---------------------------	----------	--	-----------------------------	----------------------------

HINO ... cont'd











GC Series

1990-91	GC17	48500-1801		83216
		48530-2050		83217
1992	GC20	48500-1801		83216
		48530-2050		83217

SG Series

1998-03	SG Series Trucks with O.E.M. Number	48500-1941		83141
		S4850-01941		83141
1986-91	SG19	48500-1941		83141
1992	SG20	48500-1941		83141
1986	SG22 Straight Truck	48500-1941		83141
1986	SG221 Tractor	48500-1941		83141
1987-92	SG23 Straight Truck	48500-1941		83141
1987-92	SG231 Tractor	48500-1941		83141
1993-97	SG3320 (SG4H)	48500-1941		83141
1993-97	SG3323 (SG1H) Straight Truck	48500-1941		83141
1993-97	SG5523 (SG1HD) Tractor	48500-1941		83141

Additional Applications

	Conventional Hino Models with Hendrickson Comfort Air Suspension	60670-013		83148
		60670-020		83148
	Models with O.E.M. Number	48500-1800		83216
		48500-1940		83141
		48500-1941		83141
		48500-3710		83126 or 89430
		48500-3720		83140
		48530-1120		83104
		48530-1460		83215
		48530-1620		83104
		48530-1770		83215

HOBBS TRAILERS



	Models with O.E.M. Number	680117		85300 or 89419
--	---------------------------	--------	---	-------	-------------------

HOLIDAY RAMBLER

	Models with Neway Trailer Air Suspension with O.E.M. Number	90044794		83127
--	---	----------	---	-------	-------

HOLLAND (See NEWAY)

HOLLAND - BINKLEY

	Air Plus Integrated Air Susp. with ProPar Parallel Spindle Axles	6898		83125
	Holland ProPar NT2 Air Suspension	680298		85321

HUTCHENS SUSPENSION

	Models with O.E.M. Number	9423-00		83203 or 89436
--	---------------------------	---------	---	-------	-------------------

Gabriel Part Numbers that appear in BLUE are GasSLX, adjustable shocks. \ Los números de parte Gabriel imprimidos en AZUL son amortiguadores ajustables GasSLX. \ Les numéros de pièce Gabriel imprimés en BLEU sont des amortisseurs ajustables GasSLX.

★ Will be available in first quarter of 2011.



Gabriel®

Year Año Année	Model Modelo Modèle	O.E.M. #	Mount 	Front Delantero Avant	Rear Trasero Arrière
----------------------	---------------------------	----------	-----------	-----------------------------	----------------------------

HYSTER

	Straddle Carrier	650150 73516	 	83217 83217	83217 83217
--	------------------	-----------------	------	----------------	----------------

INTERNATIONAL (NAVISTAR)

A, B, AC and BC Conventional

	A-140 (4 x 4)	83216
	A-160, B-160, AC-160, BC-160	308649C91 308650C91 453567C91	 	83216 83216 83216
	A-170, B-170, AC-170, BC-170, A-180, B-180, AC-180, BC-180	308646C91 308649C91 308650C91 453567C91	 	85012 or 89413 83216 83216 83216
	AB-140		G60021	G60021
	AC-170 & BC-170 (4 x 4)	83216
	AC-180 & BC-180 (4 x 4)	83216
	ACF-170 & BCF-170	308646C91		85012 or 89413
	BCF-195-D	83225
	C-150 308649C91 308668C91 453556C91 453567C91	 	G60021 83216 85012 or 89413 85012 or 89413 83216

Binder

	Binder	453556C91 453571C91 467983C91 467985C91 471201C91	 	85012 or 89413 85012 or 89413 85012 or 89413 85012 or 89413 83216
	S Series Binder	472367C91		83318

Gabriel Part Numbers that appear in BLUE are GasSLX, adjustable shocks. | Los números de parte Gabriel imprimidos en AZUL son amortiguadores ajustables GasSLX. | Les numéros de pièce Gabriel imprimés en BLEU sont des amortisseurs ajustables GasSLX.

★ Will be available in first quarter of 2011.

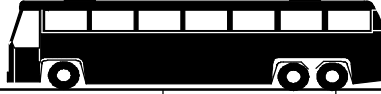

































Gabriel®

Year Año Année	Model Modelo Modèle	O.E.M. #	Mount 	Front Delantero Avant	Rear Trasero Arrière
----------------------	---------------------------	----------	--	-----------------------------	----------------------------

INTERNATIONAL (NAVISTAR) ... cont'd

Cargostar

CO-1600, CO-1610A & B, CO-1630A & B, CO-1700, CO-1710A & B, CO-1730A & B, CO-1750, CO-1750A & B, CO-1800, CO-1810A & B, CO-1830A & B, CO-1850, and CO-1850A & B	206620R91		83216
	206621R92		83216
	294334C91		83216
	3085640C92		83216
	308646C91		85012 or 89413
	308649C91		83216
	308650C92		83216
	360444C91		85012 or 89413
	453564C91		85012 or 89413
	453567C91		83216
	453570C91		83216
	467983C91		85012 or 89413
	467984C91		83216
	CO-1610A & B, CO-1630A & B, CO-1710A & B, CO-1730A & B, CO-1750A & B, CO-1810A & B, CO-1830A & B, COF-1810A & B - Exc. with 9000, 10800, or 12000 lb Front Axle	453572C91		83309 or 89446
CO-1610A & B, CO-1630A & B, CO-1710A & B, CO-1730A & B, CO-1750A & B, CO-1810A & B, CO-1830A & B, COF-1810A & B - With 9000, 10800, or 12000 lb Front Axle	873619C92		83314
	873619C93		83314
CO-190, VCO-190, CO-200, DCO-200, VCO-200, CO-220, VCO-220 With Air Ride Suspension After Chassis No G-387453	350425C1		85300 or 89419
	462557C91		85300 or 89419
CO-190, VCO-190, CO-200, DCO-200, VCO-200, CO-220, VCO-220 With Air Ride Suspension before Chassis No G-387453	350426C91		85734
CO-190, COF-190, VCO-190, VCOF-190 & CO-200, DCO-200, VCO-200 & CO-220, VCO-220 & VCO-190 (4 man cab)	204994R91		83225
	210534R92		83225
	288920C91		83225
	288921R92		83225
	308648C91		83225
	452566C91		83225
	453561C91		83225
	453562C91		83225
	453565C91		83225
	453569C91		83225
	467371C91		83225
467372C91		83225	
CO-1910A & B, CO-1950A & B, COF-1910A & B, COF-1950A & B	453572C91		83309 or 89446
	873619C92		83314

Gabriel Part Numbers that appear in BLUE are GasSLX, adjustable shocks. \ Los números de parte Gabriel imprimidos en AZUL son amortiguadores ajustables GasSLX. \ Les numéros de pièce Gabriel imprimés en BLEU sont des amortisseurs ajustables GasSLX.













★ Will be available in first quarter of 2011.













Gabriel®

Year Año Année	Model Modelo Modèle	O.E.M. #	Mount 	Front Delantero Avant	Rear Trasero Arrière
----------------------	---------------------------	----------	--	-----------------------------	----------------------------

INTERNATIONAL (NAVISTAR) ... cont'd

	CO-1950 , COF-1950 &COT-1950	204994R91 288920C91 288921C91 308648C91 453561C91 453565C91 453566C91 453569C91 467371C91 467372C91	         	83225 83225 83225 83225 83225 83225 83225 83225 83225 83225
	CO-1950 with Air Ride Suspension After Chassis No. G-387453	350425C1 462557C91	 	85300 or 89419 85300 or 89419
	CO-1950 with Air Ride Suspension Before Chassis No. G-387453	350426C1		85734







Co-Transtar and Transtar II

	7070B, F-7070B, CO-7070B & COF-7070B	426744R91 426744R92 453576C91 453576C92 477132C1	    	85303 or 89422 85303 or 89422 85303 or 89422 85303 or 89422
	CO-4010, COF-4010, COT-4010, COT-4010D, CO-4050, COF-4050, COT-4050, CO-4040A & B, CO-4070D, COF-4070B, COF-4070D, COT-4070D, COF-4077, COF-4077A, COF-4080D, CO-4090A, COF-4090A	426744R91 426744R92 453576C91 453576C92 477132C1	    	85303 or 89422 85303 or 89422 85303 or 89422 85303 or 89422
	CO-4070A, COF-4070A, COF-4090A with Rear Suspension	462557C91		85300 or 89419

DuraStar - 1000 Series

	1300 Series Steer Axle	56110-T8123 56110-T8129 66400	  	G60091 G60091 G60091
--	------------------------	-------------------------------------	---	----------------------------	-------------------------

DuraStar - 4300, 4400 Series

2002 - 11	Models with 12,000 lb Front axle	3533357C1 3533357C2	 	85957 85957
- 2011	Models with 20,000 lb International IROS Air Suspension	3578858C1 3578858C2	 	85926 85926
2002 - 10	Models with 22,000 lb Rear Spring Suspension	501906C91 501906C92	 	83317 83317
- 2009	Models with 40,000 lb Rear Air Suspension	3549099C2		85923 or 89458

Gabriel Part Numbers that appear in BLUE are GasSLX, adjustable shocks. \ Los números de parte Gabriel imprimidos en AZUL son amortiguadores ajustables GasSLX. \ Les numéros de pièce Gabriel imprimés en BLEU sont des amortisseurs ajustables GasSLX.

★ Will be available in first quarter of 2011.

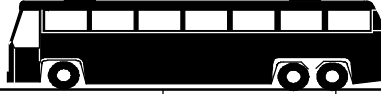

























Gabriel®

Year Año Année	Model Modelo Modèle	O.E.M. #	Mount 	Front Delantero Avant	Rear Trasero Arrière
----------------------	---------------------------	----------	--	-----------------------------	----------------------------

INTERNATIONAL (NAVISTAR) ... cont'd

2002 - 10	Models with 8,000 lb Front axle	3533356C1		83135
		3533356C2		83135
	School Bus models with 8,000 lb Front axle	3533356C1		83135
		3533356C2		83135

F & S Series

	1600, 1700, 1800, 1900, 2100 Series	3000070C91		83456 or 89447
		453576C92		85303 or 89422
	1600, 1700, 1800, 1900, 2100 Series with International Air Suspension	1675455C1		85003 or 89411
		1690035C1		85003 or 89411
		2018987C1		85003 or 89411
		501553C91		85003 or 89411
	1600, 1700, 1800, 1900, 2100 Series with Neway ARD-234 Air Suspension	537524C91		83123 or 89405
	1624, 1654, 1724, 1754, 1824, 1854, 1924, F1924, 1925, 1954, F1954, 1955, 2124, 2125, F2125, 2154, 2155 Series Exc. with Rear Axle Codes 14029, 14030, 14187	501905C91		83301
		501906C91		83317
	1624, 1654, 1724, 1754, 1824, 1854, 1924, F1924, 1925, 1954, F1954, 1955, 2124, 2125, F2125, 2154, 2155 Series with 5000, 6000 or 7500 lb Front Axle	472367C91		83318
	1624, 1654, 1724, 1754, 1824, 1854, 1924, F1924, 1925, 1954, F1954, 1955, 2124, 2125, F2125, 2154, 2155 Series with 9000, 10800 or 12000 lb Front Axle	472411C91		83456 or 89447
		472412C91		83456 or 89447
		586724C91		83456 or 89447
	1624, 1654, 1724, 1754, 1824, 1854, 1924, F1924, 1925, 1954, F1954, 1955, 2124, 2125, F2125, 2154, 2155 Series with Rear Axle Codes 14029, 14030, 14187	501905C91		83301
	1924, 1954 (6 x 6) Series	472367C91		83318
		472414C91		83318
	2275, F2275, 2524, F2524, 2554, F2554, 2574, F2574, 2575, F2575, F2624, F2654, F2674 Series with 9000, 10800 or 12000 lb Front Axle	472411C91		83456 or 89447
		472412C91		83456 or 89447
		586724C91		83456 or 89447
	2275, F2275, 2524, F2524, 2554, F2554, 2574, F2574, 2575, F2575, F2624, F2654, F2674 Series with International Corporate Air Suspension	1675455C1		85003 or 89411
		1690035C1		85003 or 89411
		2018987C1		85003 or 89411
		501553C91		85003 or 89411
	2275, F2275, 2524, F2524, 2554, F2554, 2574, F2574, 2575, F2575, F2624, F2654, F2674 Series with International Corporate Air Suspension - For Severe Use	1675455C1		85003 or 89411
	2275, F2275, 2524, F2524, 2554, F2554, 2574, F2574, 2575, F2575, F2624, F2654, F2674 Series with International Corporate Air Suspension - For Standard Use	501553C91		85003 or 89411

Gabriel Part Numbers that appear in BLUE are GasSLX, adjustable shocks. \ Los números de parte Gabriel imprimidos en AZUL son amortiguadores ajustables GasSLX. \ Les numéros de pièce Gabriel imprimés en BLEU sont des amortisseurs ajustables GasSLX.

★ Will be available in first quarter of 2011.



Gabriel®

Year Año Année	Model Modelo Modèle	O.E.M. #	Mount 	Front Delantero Avant	Rear Trasero Arrière
----------------------	---------------------------	----------	-----------	-----------------------------	----------------------------

INTERNATIONAL (NAVISTAR) ... cont'd

	2275, F2275, 2524, F2524, 2554, F2554, 2574, F2574, 2575, F2575, F2624, F2654, F2674 Series with Neway ARD-125/244 Air Suspension	790335C91		83209 or 89414
	2275, F2275, 2524, F2524, 2554, F2554, 2574, F2574, 2575, F2575, F2624, F2654, F2674 Series with Neway ARD-234 Air Suspension	537524C91		83123 or 89405
	2275, F2275, 2524, F2524, 2554, F2554, 2574, F2574, 2575, F2575, F2624, F2654, F2674 Series with Ridwell Rear Suspension	534464C1		85734

Firetruck

	CO-8190	204994R91 308648C91 453561C91 453565C91 467371C91	 	83225 83225 83225 83225 83225
	Models with O.E.M. Number	210919R91		85307

Fleetstar - Conventional

	1900, 1950, 2000 & 2000D	210535R91 453568C91 467372C91	 	83225 83225 83225
	1910A, 2010A, 2050A, 2070A, 2110A & 2150A	308650C92 453570C91 467984C91	 	83216 83216 83216
	2000D, 2010A, 2050A, 2070A, 2110A, 2150A with Air Ride Suspension After Chassis No G-387453	350425C1 462557C91	 	85300 or 89419 85300 or 89419
	2000D, 2010A, 2050A, 2070A, 2110A, 2150A with Air Ride Suspension Before Chassis No G-387453	350426C1		85734
	F-1900, T-1900, F-1950, T-1950, F-2000D, & T-2000D	210535R91 453568C91 467372C91	 	83225 83225 83225
	F-1910A, F-2010A, F-2050A & F-2070A	206621R92 308650C92 453570C91 467984C91	 	83216 83216 83216 83216
	F-2010A, F-2050A, F-2000D with Air Ride Suspension	350425C1 462557C91	 	85300 or 89419 85300 or 89419
	R-185, R-190, RD-190, R-200, RD-200, RF-200, RDF-200, R-220, RD-220, R210 & RF-210	210533R91 210534R92 210535R91 210536R91 210537R91 210538R91 453562C91 453568C91 467371C91 467372C91	 	83225 83225 83225 83225 83225 83225 83225 83225 83225 83225

Gabriel Part Numbers that appear in BLUE are GasSLX, adjustable shocks. | Los números de parte Gabriel imprimidos en AZUL son amortiguadores ajustables GasSLX. | Les numéros de pièce Gabriel imprimés en BLEU sont des amortisseurs ajustables GasSLX.

★ Will be available in first quarter of 2011.

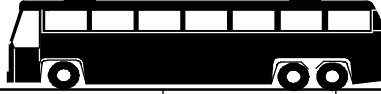































Gabriel®

Year Año Année	Model Modelo Modèle	O.E.M. #	Mount 	Front Delantero Avant	Rear Trasero Arrière
----------------------	---------------------------	----------	--	-----------------------------	----------------------------

INTERNATIONAL (NAVISTAR) ... cont'd

Loadstar - Conventional

	1600	467983C91		85012 or 89413
		471201C91		85012 or 89413
	1600, 1600 (4x4), 1610, 1610 (4x4), 1610FC, 1700, 1700 (4x4), 1710, 1710 (4x4), F-1700, 1750, 1800, 1810, F-1800, F-1800-D, 1850, F-1850, 1890 & 1890-D with 9000, 10800 or 12000 lb Front Axle	329316C92		85012 or 89413
		360444C91		85012 or 89413
		453564C91		85012 or 89413
		467983C91		85012 or 89413
	1600, 1600 (4x4), 1610, 1610 (4x4), 1610FC, 1700, 1700 (4x4), 1710, 1710 (4x4), F-1700, 1750, 1800, 1810, F-1800, F-1800-D, 1850, F-1850, 1890 & 1890-D with Axle Codes 02089, 02091	206620R91		83216
		308649C91		83216
		453567C91		83216
	1600, 1600 (4x4), 1610, 1610 (4x4), 1700, 1700 (4x4), 1710, 1710 (4x4), 1750, 1800, 1810, 1850, 1890 & 1890-D	206620R91		83216
		206621R91		83216
		308649C91		83216
		308650C92		83216
		329316C92		85012 or 89413
		360444C91		85012 or 89413
		383379C91		83308
		453564C91		85012 or 89413
		453567C91		83216
		453570C91		83216
		453575C91		83308
		467983C91		85012 or 89413
		467984C91		83216
		471203C91		83308
		474002C91		83308
		873622C91		83308
	1600, 1600 (4x4), 1610, 1610 (4x4), 1700, 1700 (4x4), 1710, 1710 (4x4), F-1700, 1750, 1800, 1810, F-1800, F-1800-D, 1850, F-1850, 1890 & 1890-D Exc. Axle Codes 02054, 02057, 02059, 02089, 02091, 02098, 02101, 02109, 02139, 02208, 02218, 02228, 02309, 0232	308668C92		85012 or 89413
		453556C91		85012 or 89413
		467985C91		85012 or 89413
		874695R91		85012 or 89413
		874695R92		85012 or 89413
	1600, 1610FC, 1700, 1700 (4x4), 1800, 1890, 1890D	384435C91		83216
		453571C91		83216
		462753C91		83216
	1700, 1750, 1800, 1850 with Air Ride Suspension	462557C91		85300 or 89419
	M1600, M1700, M1800, M1900, M2100 Series	453576C92		85303 or 89422

Gabriel Part Numbers that appear in BLUE are GasSLX, adjustable shocks. \ Los números de parte Gabriel imprimidos en AZUL son amortiguadores ajustables GasSLX. \ Les numéros de pièce Gabriel imprimés en BLEU sont des amortisseurs ajustables GasSLX.

★ Will be available in first quarter of 2011.

**Gabriel®**

Year Año Année	Model Modelo Modèle	O.E.M. #	Mount 	Front Delantero Avant	Rear Trasero Arrière
----------------------	---------------------------	----------	-----------	-----------------------------	----------------------------

INTERNATIONAL (NAVISTAR) ... cont'd**LoneStar - Series**

2009 - 10	All models with 40,000 lb Rear Air Suspension	3620395C1		85931 or 89458
2009 - 10	Day Cab models with 14,600 lb Parabolic Taperleaf Front Spring	3813341C1		85963
		3813341C2		85963
2008 - 10	Models with 12,000 lb Mono-leaf Front Spring	3819277C1		★ 85969
		3819279C1		★ 85969
2009 - 10	Sleeper Cab models with 13,200 lb Parabolic Taperleaf Front Spring	3813340C1		85964
		3813340C2		85964

Metro & Multi-Shop Series

	AM and AMC-160, AMC-164	308649C91 453567C91	 	83216 83216
	M1600, M1700, M1800, M1900, M2100 Series	453576C92		85303 or 89422
	M1600, M1700, M1800, M1900, M2100 Series - Exc. with Rear Axle Codes 14029, 14030, 14187	501905C91 501906C91	 	83301 83317
	M1600, M1700, M1800, M1900, M2100 Series with 5000, 6000 or 7500 lb Front Axle	472367C91		83318
	M1600, M1700, M1800, M1900, M2100 Series with 9000, 10800 or 12000 Front Axle	472411C91		83456 or 89447
	M1600, M1700, M1800, M1900, M2100 Series with Front Axle Codes 02109, 02118, 02309, 02127, 02139, 02329, 02339	472412C91		83456 or 89447
		586724C91		83456 or 89447
	M1600, MC1600, M1700 & MC1700	206620R91		83216
		308649C91		83216
		308668C91		85012 or 89413
		308669C91		85012 or 89413
		453556C91		85012 or 89413
		453597C91		83216
		874695R91		85012 or 89413
		874696R91		85012 or 89413
	MA1200, M1400, M1500, MA1500	287318C91		G60021	G60021
		308649C91		83216
		308669C91		85012 or 89413
		453531C91		G60021
		453556C91		85012 or 89413
		453557C91		G60021
		453567C91		83216
		467980C91		G60021	G60021
1966- 72	Metro Series M1200 - Exc. Frame Code 01000.0962		G60003
1966- 72	Metro Series M1200 with 14016 Reg. Rear Springs & with 14020 Rear Axle Code		G60021	G60021
1966- 72	Metro Series M1200 with Axle Code 0208 & Frame Code 01000.0962		G60021	G60021
1966- 72	Metro Series M1200 with Code 03204 Aux. Springs	G60003

Gabriel Part Numbers that appear in BLUE are GasSLX, adjustable shocks. | Los números de parte Gabriel imprimidos en AZUL son amortiguadores ajustables GasSLX. | Les numéros de pièce Gabriel imprimés en BLEU sont des amortisseurs ajustables GasSLX.

★ Will be available in first quarter of 2011.

















Gabriel®

Year Año Année	Model Modelo Modèle	O.E.M. #	Mount 	Front Delantero Avant	Rear Trasero Arrière
----------------------	---------------------------	----------	--	-----------------------------	----------------------------





INTERNATIONAL (NAVISTAR) ... cont'd

1966-72	Metro Series M700, 800, 900-U, 1000, 1100,		G60021	G60021
1973-75	Multi-Stop Series MS-1210 & 1510		G60021

Paystar - 5000 Series

	5010, F-5010, F-5050, F-5050SF, 5070, F-5070, F-5070SF	426744R91		85303 or 89422
		426744R92		85303 or 89422
		453576C91		85303 or 89422
		453576C92		85303 or 89422
		477132C1		85303 or 89422
- 2011	5600i Models with 16,000 lb Front axle	1667520C1		85058 or 89431
2004 - 11	5900 SB Models with 18,000 lb Front axle	1667520C1		85058 or 89431
2004 - 11	5900 SB Models with 46,000 lb Hendrickson Rear Air Suspension	3626571C1 60657-003	 	85072 85072
2009 - 11	5900i Models with 12,000 lb - 14,000 lb Front axle	2015556C1		85316 or 89426
2004 - 11	5900i SFA Models with 16,000 lb Front axle	1667520C1		85058 or 89431
2004 - 09	5900i SFA Models with 46,000 lb Neway Rear Air Suspension	2029200C91 90044626	 	83126 or 89430 83126 or 89430
- 2011	Models with Hendrickson HMX 460 Haulmax with 16.5" Saddle	60680-004		83143

ProStar - Series

2009 - 11	All models with 40,000 lb Rear Air Suspension	3620395C1		85931 or 89458
	Models with Day Cab and Air Suspension	3610199C1		85964
- 2011	Models with Sleeper Cab and 12,350 lb Leaf Spring Suspension	3606857C1 3606857C2	 	85954 85954
	Models with Sleeper Cab and Air Suspension	3610198C1		85963

S Series School Bus

	1603	467983C91 471201C91	 	85012 or 89413 85012 or 89413
--	------	------------------------	--	--	----------------

Gabriel Part Numbers that appear in BLUE are GasSLX, adjustable shocks. \ Los números de parte Gabriel imprimidos en AZUL son amortiguadores ajustables GasSLX. \ Les numéros de pièce Gabriel imprimés en BLEU sont des amortisseurs ajustables GasSLX.







































★ Will be available in first quarter of 2011.



Gabriel®

Year Año Année	Model Modelo Modèle	O.E.M. #	Mount 	Front Delantero Avant	Rear Trasero Arrière
----------------------	---------------------------	----------	--	-----------------------------	----------------------------

INTERNATIONAL (NAVISTAR) ... cont'd

	1603, 1703, 1803 & 1853	206620R91 206621R91 306444C91 308649C91 308650C92 329316C92 383379C91 453564C91 453567C91 453570C91 453575C91 467983C91 471203C91 474002C91 873622C91	              	83216 83216 85012 or 89413 83216 83216 85012 or 89413 83308 85012 or 89413 83216 83216 83308 85012 or 89413 83308 83308 83308
	1603, 1703, 1803 & 1853 - Exc. Axle Codes 02054, 02057, 02059, 02089, 02091, 02098, 02101, 02109, 02139, 02208, 02218, 02228, 02309, 02329, 02339	308668C92 453556C91 467985C91 874695R91	   	85012 or 89413 85012 or 89413 85012 or 89413 85012 or 89413
	1603, 1703, 1803 & 1853 with Axle Codes 02089, 02091	206620R91 308649C91 453567C91 467984C91	   	83216 83216 83216 83216
	1603, 1703, 1803 & 1853 with 9000, 10800 or 12000 lb Front Axle	320444C91 329316C92 453564C91 467983C91	   	85012 or 89413 85012 or 89413 85012 or 89413 85012 or 89413
	1723 S Series with 5000, 6000 or 7500 lb Front Axle	472367C91		83318
	1723, 1823, 1853 Series with International Air Suspension	1675455C1 1690035C1 2018987C1 501553C91	   	85003 or 89411 85003 or 89411 85003 or 89411 85003 or 89411
	1723, 1823, 1853 Series with Neway ARD-234 Air Suspension	537524C91		83123 or 89405
	173 FC & 183 FC - Exc. Axle Codes 14149 & 14189	210918R91 453574C91	 	83215 85307
	173 FC & 183 FC with Axle Codes 14149 & 14189	210535R91 453568C91 467372C91	  	83225 83225 83225

Gabriel Part Numbers that appear in BLUE are GasSLX, adjustable shocks. \ Los números de parte Gabriel imprimidos en AZUL son amortiguadores ajustables GasSLX. \ Les numéros de pièce Gabriel imprimés en BLEU sont des amortisseurs ajustables GasSLX.





































★ Will be available in first quarter of 2011.





Gabriel®

Year Año Année	Model Modelo Modèle	O.E.M. #	Mount 	Front Delantero Avant	Rear Trasero Arrière
----------------------	---------------------------	----------	--	-----------------------------	----------------------------

INTERNATIONAL (NAVISTAR) ... cont'd

	173 FC, 183 FC, 183RE, 193 RE	204994R91 308648C91 453561C91 453565C91 467371C91	    	83225 83225 83225 83225 83225
	1823 S Series - Exc. with Rear Axle Codes 14029,14030, 14187	501906C91		83317
	1823, 1853 S Series with 9000, 10800 or 12000 lb Front Axle	472411C91 472412C91 586724C91	  	83456 or 89447 83456 or 89447 83456 or 89447
	183 RE with Axle Codes 14043, 14147 & 14186	210533R91 210534R92 453562C91 467371C91	   	83225 83225 83225 83225
	1853 DFC3	210920R91 453579C91	 	85308 or 89422 85308 or 89422
	1853 FC & 1853 DFC	204994R91 308648C91 453561C91 453565C91 467371C91	    	83225 83225 83225 83225 83225
	1853 FC & 1853 DFC with Axle Code 14136	210919R91 308664C91 453574C91	  	85307 85307 85307
	1853 FC & 1853 DFC with Axle Code 14149 with FD Serial Numbers	453567C91		83216
	1853 FC & 1853 DFC with Axle Codes 14039, 14139, 14149 & 14189 - Exc. 14149 with FD Serial Numbers	210533R91 210534R92 453562C91 467371C91	   	83225 83225 83225 83225
	1853 FC & 1853 DFC with Axle Codes 14044, 14045, 14060, 14145, 14146, 14150 and 14186	208664C91 210919R91 453574C91	  	85307 85307 85307
	193 RE	210920R91 453579C91	 	85308 or 89422 85308 or 89422
	193 RE - Exc. Axle Codes 14039 & 14189	210533R91 210534R92 453562C91 467371C91	   	83225 83225 83225 83225

School Bus

	BE200 Small Bus Chassis with 7000 lb Axle	3605735C1 3605735C2	 	83156 83156
--	---	------------------------	--	----------------	----------------

Gabriel Part Numbers that appear in BLUE are GasSLX, adjustable shocks. \ Los números de parte Gabriel imprimidos en AZUL son amortiguadores ajustables GasSLX. \ Les numéros de pièce Gabriel imprimés en BLEU sont des amortisseurs ajustables GasSLX.

★ Will be available in first quarter of 2011.

**Gabriel®**

Year Año Année	Model Modelo Modèle	O.E.M. #	Mount 	Front Delantero Avant	Rear Trasero Arrière
----------------------	---------------------------	----------	-----------	-----------------------------	----------------------------

INTERNATIONAL (NAVISTAR) ... cont'd**Series 1000 Forward Control Chassis**

	1452, 1652 Series	453576C92		85303 or 89422
		472412C91		83456 or 89447
		586724C91		83456 or 89447
	1452, 1652 Series with International Air Suspension	1675455C1		85003 or 89411
		1690035C1		85003 or 89411
		2018987C1		85003 or 89411
		501553C91		85003 or 89411
	1452, 1652 Series with MOR-RYDE Rear Suspension	548532C1		83103
	1654 LP Series (Low Profile Vehicle)	1660846C91		83101
		1663471C1		83103
		2039565C1		83100
	M1400, M1600 Series	472412C91		83456 or 89447
		501905C91		83301
		586724C91		83456 or 89447

Series 2000 - Conventional Truck (Severe Service)

	2554, 2574, 2654, 2674 Series	472412C91		83456 or 89447
	2554, 2574, 2654, 2674 Series with International Air Suspension	1675455C1		85003 or 89411
		1690035C1		85003 or 89411
		2018987C1		85003 or 89411
		501553C91		85003 or 89411
	2554, 2574, 2654, 2674 Series with International Vari-Rate Rear Suspension	501506C91		83317
	All 2000 Series - With 12000 lb Front Axle - Without 12000 lb Front Axle and with 16000 or 18000 lb Springs - Without 12000 lb Front Axle and without 16000 or 18000 lb Springs	472412C91		83456 or 89447
		1667520C1		85058 or 89431
		2015556C1		85316 or 89426

Series 400, 500, 600, 700, & 900 - Medium Cabover Truck & Tractor (Nissan)

	400 Series	56101 Z5008		83114
		56101 Z5011		G60164
	500 Series	56101 Z5011		G60164
	600, 700, 900 Series	56101 Z1030		85311 or 89424
		56101 Z2000		85311 or 89424

Gabriel Part Numbers that appear in BLUE are GasSLX, adjustable shocks. \ Los números de parte Gabriel imprimidos en AZUL son amortiguadores ajustables GasSLX. \ Les numéros de pièce Gabriel imprimés en BLEU sont des amortisseurs ajustables GasSLX.

★ Will be available in first quarter of 2011.

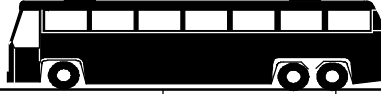













Gabriel®

Year Año Année	Model Modelo Modèle	O.E.M. #	Mount 	Front Delantero Avant	Rear Trasero Arrière
----------------------	---------------------------	----------	--	-----------------------------	----------------------------

INTERNATIONAL (NAVISTAR) ... cont'd















Series 405

	D-405, DB-405, DC-405, DCO-405, DF-405 & VCO-405 - Exc. Axle Code 02136	426744R91		85303 or 89422
		453576C91		85303 or 89422
	DBF-405, DCF-405, DCOF-405 & VCOF-405 with Axle Code 02136	293009C91		85308 or 89422
		426744R91		85303 or 89422
		453576C91		85303 or 89422
		453577C91		85308 or 89422
	DT-405, DBT-405, DCT-405, DCOT-405 & VCOT-405 - Exc. Axle Code 02136	426744R91		85303 or 89422
		453576C91		85303 or 89422
	DT-405, DBT-405, DCT-405, DCOT-405 & VCOT-405 with Axle Code 02136	293009C91		85308 or 89422
		426744R91		85303 or 89422
		453576C91		85303 or 89422
		453577C91		85308 or 89422

Series 417

	DCO-417 & DCOF-417	426744R91		85303 or 89422
		453576C91		85303 or 89422

Series 3000 - School Bus Chassis

	3700, 3800 Series	472412C91		83456 or 89447
		501905C91		83301
		501906C91		83317
		586724C91		83456 or 89447
	3700, 3800 Series with International Air Suspension	1675455C1		85003 or 89411
		1690035C1		85003 or 89411
		2018987C1		85003 or 89411
		501553C91		85003 or 89411
	3700, 3800 Series with MOR-RYDE Rear Suspension	548532C1		83103
	3700, 3800 Series with Neway ARD-234 Air Suspension	537524C91		83123 or 89405
		537525C91		83123 or 89405
	3900FC Series	1677707C1		85030 or 89440
		2015557C1		85030 or 89440
		467371C91		83225	83225

Gabriel Part Numbers that appear in BLUE are GasSLX, adjustable shocks. \ Los números de parte Gabriel imprimidos en AZUL son amortiguadores ajustables GasSLX. \ Les numéros de pièce Gabriel imprimés en BLEU sont des amortisseurs ajustables GasSLX.

★ Will be available in first quarter of 2011.

**Gabriel®**

Year Año Année	Model Modelo Modèle	O.E.M. #	Mount 	Front Delantero Avant	Rear Trasero Arrière
----------------------	---------------------------	----------	-----------	-----------------------------	----------------------------

INTERNATIONAL (NAVISTAR) ... cont'd

	3900FC Series (Genesis - Front Engine)	2200327C1		85332
	3900FC Series (Genesis - Rear Engine)	2039549C1		85333

Series 4000 - Short Conventional Medium Truck & Tractor

	4000 Series with Hendrickson HAS-230 Rear Air Suspension	AMS650420		85013 or 89414
	4600, 4700, 4800, 4900 Series	1663606C91		85027 or 89418
		1667520C1		85058 or 89431
		586724C91		83456 or 89447
	4600, 4700, 4800, 4900 Series with 10000 lb Front Axle	472412C91		83456 or 89447
	4600, 4700, 4800, 4900 Series with International Air Suspension (Exc. Low Profile)	1675455C1		85003 or 89411
		1690035C1		85003 or 89411
		2018987C1		85003 or 89411
		501553C91		85003 or 89411
	4600LP Series (Low Profile Vehicle)	501906C91		83317
Feb95-	4600LP, 4700LP Series (Low Profile Vehicle) U-Haul	2039565C1		83100
		540395C92		83613
- Jan95	4600LP, 4700LP Series (Low Profile Vehicle) U-Haul	1675496C91		83636
		540395C92		83613
	4800 4x4 with front driving Axle	506911C91	
	4900 Series with Dual Doors	2015556C1		85316 or 89426

Series 5000, 5000i - Severe Service Conventional Truck & Tractor

	5070 Series - 6 X 4 - with Neway AD246-10 Air Suspension and 60" Axle Spacing	2029200C91		83126 or 89430
		AMS 600172		85030 or 89440

Series 7000 - Short Conventional Medium Truck & Tractor

	7100 Series	1663606C91		85027 or 89418
		472412C91		83456 or 89447
		586724C91		83456 or 89447
	7100 Series with International Air Suspension	1675455C1		85003 or 89411
		1690035C1		85003 or 89411
		2018987C1		85003 or 89411
		501553C91		85003 or 89411
	7300, 7400, 7500, 7600 Series w/ IAS Suspension w/ 5.3" Ride Height	3544766C1		85930

Gabriel Part Numbers that appear in BLUE are GasSLX, adjustable shocks. \ Los números de parte Gabriel imprimidos en AZUL son amortiguadores ajustables GasSLX. \ Les numéros de pièce Gabriel imprimés en BLEU sont des amortisseurs ajustables GasSLX.

★ Will be available in first quarter of 2011.



















Gabriel®









Year Año Année	Model Modelo Modèle	O.E.M. #	Mount 	Front Delantero Avant	Rear Trasero Arrière
----------------------	---------------------------	----------	---	-----------------------------	----------------------------

INTERNATIONAL (NAVISTAR) ... cont'd

Series 8000 - Conventional Heavy Duty Tractor

	8100 Series - 6 X 4 & 4 X 2 Models with International Air Suspension for Lo-Profile and Carhauler	1660846C1		83101
	8100 Series Car Hauler	1664524C1 472412C91	  83456 or 89447	85935
	8100, 8200 & 8300 Series - 6 X 4 Models with International Air Suspension (Except Lo-Profile and Carhauler)	2018987C1		85003 or 89411
	8100, 8200, 8300 Series	3000070C91 501906C91	 	83456 or 89447 83317
	8100, 8200, 8300 Series - 6 X 4 - with Neway AD246-10 Air Suspension and 60" Axle Spacing	2029200C91 AMS 600172	 	83126 or 89430 85030 or 89440
	8100, 8200, 8300 Series - with Hendrickson HA-460 Air Suspension with 55" & 60" axle spacing and 40000 & 46000 lb capacity	AMS 600102		85005 or 89430
	8100, 8200, 8300 Series with 12000 - 14000 lb Suspension	1664788C2 2015556C1	 	85316 or 89426 85316 or 89426
	8100, 8200, 8300 Series with 15000 - 18000 lb Suspension	1667520C1		85058 or 89431
	8100, 8200, 8300 Series with Hendrickson HA-230 Rear Air Suspension	AMS 600102		85005 or 89430
	8100, 8200, 8300 Series with International Air Suspension	1675455C1 1690035C1 501553C91	  	85003 or 89411 85003 or 89411 85003 or 89411

Series 9100, 9100i - Tractor & Straight Truck

	9100 Series - 4 X 2 with International Air Suspension	2018987C1		85003 or 89411
	9100 Series - 6 X 4 - with Neway AD246-10 Air Suspension and 60" Axle Spacing	2029200C91 AMS 600172	 	83126 or 89430 85030 or 89440
	9100 Series - 6 X 4 (Low Profile) Models with International Air Suspension	1660846C91		83101
	9100 Series - 6 X 4 with International Air Suspension	2018987C1		85003 or 89411
	9100 Series - with Hendrickson HA-460 Series Air Suspension	AMS 600102		85005 or 89430
	9100 Series with 12000 - 14000 lb Suspension	1664788C2 2015556C1 2032533C1	  	85316 or 89426 85316 or 89426 85316 or 89426

Gabriel Part Numbers that appear in BLUE are GasSLX, adjustable shocks. \ Los números de parte Gabriel imprimidos en AZUL son amortiguadores ajustables GasSLX. \ Les numéros de pièce Gabriel imprimés en BLEU sont des amortisseurs ajustables GasSLX.

★ Will be available in first quarter of 2011.

**Gabriel®**

Year Año Année	Model Modelo Modèle	O.E.M. #	Mount 	Front Delantero Avant	Rear Trasero Arrière
----------------------	---------------------------	----------	-----------	-----------------------------	----------------------------

INTERNATIONAL (NAVISTAR) ... cont'd**Series 9200, 9200i - Tractor & Straight Truck**

Aug12 /94 -	4 X 2 Models with International Air Suspension	2018987C1		85003 or 89411
- Aug12 /94	4 X 2 Models with International Air Suspension	1675496C91		83636
	6 X 4 (Low Profile) Models with International Air Suspension	1660846C91		83101
	6 X 4 Models Neway AD246-10 Air Suspension and 60" Axle Spacing	2029200C91		83126 or 89430
		AMS 600172		85030 or 89440
	6 X 4 Models with 12,000 to 14,000 lb Front Axles	3581109C3		85924 or 89457
		3581109C4		85924 or 89457
	6 X 4 Models with International Air Suspension	2018987C1		85003 or 89411
	Models with 12,000 - 18,000 lb Suspension	1664788C2		85316 or 89426
		2015556C1		85316 or 89426
		2032533C1		85316 or 89426
2004 - 09	Models with 12,000 lb Front Axle	3584535C3		85924 or 89457
2000 - 07	Models with 12,000 lb Front Axle	3581107C1		85924 or 89457
		3581107C2		85924 or 89457
		3581107C3		85924 or 89457
2004 - 09	Models with 40,000 lb Rear Air Suspension	3586883C1		85931 or 89458
	Models with Day Cab & Hendrickson AirTek Suspension	3613984C1		85955
		3660549C1		85955
		65992-002		85955
	Models with Hendrickson HA-460 Series Air Suspension	AMS 600102		85005 or 89430
	Models with IAS Suspension w/ 9.25" or 9.5" Ride Height	3573265C1		85931 or 89458
	Models with International Air Suspension	1675455C1		85003 or 89411
		1690035C1		85003 or 89411
		501553C91		85003 or 89411
	Models with Sleeper Cab & Hendrickson AirTek Suspension	3609178C1		85955
		3660548C1		85955
		65992-001		85955

Series 9300, 9300i, 9400 & 9400i Long Hood Conventional Truck & Tractor

	(SBA Model) with 16000 lb - 18000 lb Suspension	1664149C1		85029
	(SFA Model) with 16000 lb - 18000 lb Suspension	507202C1		85030 or 89440
	6 X 4 Models with International Air Suspension Exc. Lo-Profile	2018987C1		85003 or 89411

Gabriel Part Numbers that appear in BLUE are GasSLX, adjustable shocks. \ Los números de parte Gabriel imprimidos en AZUL son amortiguadores ajustables GasSLX. \ Les numéros de pièce Gabriel imprimés en BLEU sont des amortisseurs ajustables GasSLX.



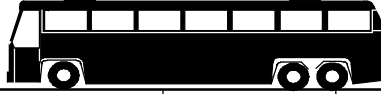























★ Will be available in first quarter of 2011.



Gabriel®

Year Año Année	Model Modelo Modèle	O.E.M. #	Mount 	Front Delantero Avant	Rear Trasero Arrière
----------------------	---------------------------	----------	--	-----------------------------	----------------------------

INTERNATIONAL (NAVISTAR) ... cont'd

	Models with 10,800 lb - 14,600 lb Suspension	503610C2		83207 or 89407
	Models with 12,000 - 14,000 lb Suspension	1664788C2		85316 or 89426
		2015556C1		85316 or 89426
		2032533C1		85316 or 89426
2004 - 09	Models with 12,000 lb Front Axle	3584535C3		85924 or 89457
2000 - 07	Models with 12,000 lb Front Axle	3581107C1		85924 or 89457
		3581107C2		85924 or 89457
		3581107C3		85924 or 89457
	Models with 16,000 - 18,000 lb Suspension	1667520C1		85058 or 89431
2004 - 09	Models with 40,000 lb Rear Air Suspension	3586883C1		85931 or 89458
	Models with 6 X 4 with International Air Suspension For Lo-Profile	1660846C91		83101
	Models with 6 X 4 with Neway AD246-10 Air Suspension and 60" Axle Spacing	2029200C91		83126 or 89430
		AMS 600172		85030 or 89440
	Models with Day Cab & Hendrickson AirTek Suspension	3613984C1		85955
		3660549C1		85955
		65992-002		85955
	Models with Hendrickson HA-460 Series Air Suspension	AMS 600102		85005 or 89430
	Models with Hendrickson RS/RTE-380 Rear Air Suspension	503610C2		83207 or 89407
	Models with IAS Suspension w/ 9.25" or 9.5" Ride Height	3573265C1		85931 or 89458
	Models with International Air Suspension	1675455C1		85003 or 89411
		1690035C1		85003 or 89411
		501553C91		85003 or 89411
	Models with Neway ARD-125/244 Air Suspension	790335C91		83209 or 89414
	Models with Sleeper Cab & Hendrickson AirTek Suspension	3609178C1		85955
		3660548C1		85955
		65992-001		85955
	Models with with Hendrickson RS-460 Rear Air Suspension	2015557C1		85030 or 89440

Series 9600 & 9700 Premium Cabover Tractor

	9600, 9700 Series	503610C2		83207 or 89407
		507202C1		85030 or 89440

Gabriel Part Numbers that appear in BLUE are GasSLX, adjustable shocks. \ Los números de parte Gabriel imprimidos en AZUL son amortiguadores ajustables GasSLX. \ Les numéros de pièce Gabriel imprimés en BLEU sont des amortisseurs ajustables GasSLX.

★ Will be available in first quarter of 2011.

**Gabriel®**

Year Año Année	Model Modelo Modèle	O.E.M. #	Mount 	Front Delantero Avant	Rear Trasero Arrière
----------------------	---------------------------	----------	-----------	-----------------------------	----------------------------

INTERNATIONAL (NAVISTAR) ... cont'd

	9600, 9700 Series Except Low Profile	1664788C2		85316 or 89426
		2015556C1		85316 or 89426
	9600, 9700 Series for Low Profile	503610C2		83207 or 89407
	9600, 9700 Series with 16000 - 18000 lb Suspension	1667520C1		85058 or 89431
	9600, 9700 Series with Hendrickson HA-460 Air Suspension with 55" or 60" axle spacing and 40000 or 46000 lb capacity	AMS 600102		85005 or 89430
	9600, 9700 Series with International Air Suspension	1675455C1		85003 or 89411
		1690035C1		85003 or 89411
		2018987C1		85003 or 89411
		501553C91		85003 or 89411
	9600, 9700 Series with International STL Spring Suspension	503550C1		83207 or 89407
	9600, 9700 Series with Neway ARD-125/244 Air Suspension	790335C91		83209 or 89414
	9600, 9700 Series with Neway ARD-234 Air Suspension	537524C91		83123 or 89405

Series 9800 - Premium Cabover Tractor

	9800 Series - 6 X 4 Models with International Air Suspension	2018987C1		85003 or 89411
	9800 Series - 6 X 4 Models with Neway AD246-10 Air Suspension and 60" Axle Spacing	2029200C91		83126 or 89430
		AMS 600172		85030 or 89440
	9800 Series - with Hendrickson HA-460 Air Suspension with 55" & 60" axle spacing and 40000 & 46000 lb capacity	AMS 600102		85005 or 89430
	9800 Series - with Hendrickson HAS-402-60 Air Suspension	AMS 650420		85013 or 89414
	9800 Series - with Set Back axle	2015556C1		85316 or 89426
	9800 Series - with Set Forward axle	503610C2		83207 or 89407

Series 9900, 9900i, 9900ix Long Hood Conventional Truck

	(SBA Model) with 16,000 lb - 18,000 lb Suspension	1664149C1		85029
	(SFA Model) with 16,000 lb - 18,000 lb Suspension	507202C1		85030 or 89440
	6 X 4 Models with International Air Suspension Exc. Lo-Profile	2018987C1		85003 or 89411
	6 X 4 Models with International Air Suspension For Lo-Profile	1660846C91		83101
	6 X 4 Models with Neway AD246-10 Air Suspension and 60" Axle Spacing	2029200C91		83126 or 89430
		AMS 600172		85030 or 89440

Gabriel Part Numbers that appear in BLUE are GasSLX, adjustable shocks. \ Los números de parte Gabriel imprimidos en AZUL son amortiguadores ajustables GasSLX. \ Les numéros de pièce Gabriel imprimés en BLEU sont des amortisseurs ajustables GasSLX.

















★ Will be available in first quarter of 2011.









Gabriel®

Year Año Année	Model Modelo Modèle	O.E.M. #	Mount 	Front Delantero Avant	Rear Trasero Arrière
----------------------	---------------------------	----------	---	-----------------------------	----------------------------

INTERNATIONAL (NAVISTAR) ... cont'd

- 2009	Day Cab Models with 12,000 lb Front Axles	3581106C1		85924 or 89457
		3581106C2		85924 or 89457
		3581106C3		85924 or 89457
	Models with 10,800 lb - 14,600 lb Suspension	503610C2		83207 or 89407
	Models with 12,000 - 14,000 lb Suspension	1664788C2		85316 or 89426
		2015556C1		85316 or 89426
		2032533C1		85316 or 89426
2004 - 09	Models with 12,000 lb Front axle	3584535C3		85924 or 89457
	Models with 16,000 - 18,000 lb Suspension	1667520C1		85058 or 89431
2004 - 09	Models with 40,000 lb Rear Air Suspension	3586883C1		85931 or 89458
	Models with Hendrickson HA-460 Series Air Suspension	AMS 600102		85005 or 89430
	Models with Hendrickson RS/RTE-380 Rear Air Suspension	503610C2		83207 or 89407
	Models with Hendrickson RS-460 Rear Air Suspension	2015557C1		85030 or 89440
	Models with International Air Suspension	1675455C1		85003 or 89411
		1690035C1		85003 or 89411
		501553C91		85003 or 89411
	Models with Neway ARD-125/244 Air Suspension	790335C91		83209 or 89414

TranStar - 8500, 8600 Series

2003 - 10	Models with 12,000 lb Front axle	3533357C1		85957
		3533357C2		85957
		3588209C1		85957
		3588209C2		85957
2003 - 10	Models with 40,000 lb Rear Air Suspension	3549099C1		85923 or 89458
		3549099C2		85923 or 89458

Transtar - Conventional

	4170, F-4170, 4200, F-4200, 4300 & F-4300	426744R91		85303 or 89422
		426744R92		85303 or 89422
		453576C91		85303 or 89422
		453576C92		85303 or 89422
		477132C1		85303 or 89422

Gabriel Part Numbers that appear in BLUE are GasSLX, adjustable shocks. \ Los números de parte Gabriel imprimidos en AZUL son amortiguadores ajustables GasSLX. \ Les numéros de pièce Gabriel imprimés en BLEU sont des amortisseurs ajustables GasSLX.

★ Will be available in first quarter of 2011.



Gabriel®

Year Año Année	Model Modelo Modèle	O.E.M. #	Mount 	Front Delantero Avant	Rear Trasero Arrière
----------------------	---------------------------	----------	-----------	-----------------------------	----------------------------

INTERNATIONAL (NAVISTAR) ... cont'd

	4170, F-4170, 4200, F-4200, 4300 & F-4300 with Air Ride Suspension	350425C1 462557C91	 	85300 or 89419 85300 or 89419
	D-400, DF-400, DC-400, DCF-400 & DCF-400M - Exc. Axle Code 02136	426744R91 426744R92 453576C91	 	85303 or 89422 85303 or 89422 85303 or 89422
	D-400, DF-400, DC-400, DCF-400 & DCF-400M with Axle Code 02136	293009C91 453577C91	 	85308 or 89422 85308 or 89422

Unistar

	CO7044A	426744R91 426744R92 453576C91	 	85303 or 89422 85303 or 89422 85303 or 89422	85303 or 89422 85303 or 89422 85303 or 89422
	Additional O.E.M. Interchanges	56101-Z5008 596329C1	 		83114 85014

WorkStar - 7000 Series

	7500, 7600 Series with 18,000 lb Front Axles	3576464C1 3576464C2	 	85957 85957
2011	7500, 7600 Series with 20,000 lb Front Axles	3558089C3		85925
	7500, 7600 Series with Hendrickson HAS - 400 (Standard Inboard Rear)	60670-007		83144
	S7700 Series w/ Multistage Front Suspension	3588591C1 3588591C2 3588592C1 3588592C2	 	85953 85953 85953 85953

	Models with Meritor AirLink Suspension	446-511-211		85739
2007	Models with O.E.M. Number	3586706C2 3586902C2	 	83145 83146
2005-08	Models with O.E.M. Number	3584117C1		83135
	Models with O.E.M. Number	3571711C1 3584117C2 3584118C1 3584118C2 3601600C1 3601600C2 4C4Z-18124-N 4C4Z-18125-DA 503610C1 90044025	 	85316 or 89426 83135 85957 85957 85082 85082 85957 85926 83207 or 89407 83209 or 89414

Gabriel Part Numbers that appear in BLUE are GasSLX, adjustable shocks. | Los números de parte Gabriel imprimidos en AZUL son amortiguadores ajustables GasSLX. | Les numéros de pièce Gabriel imprimés en BLEU sont des amortisseurs ajustables GasSLX.



















★ Will be available in first quarter of 2011.



Gabriel®









Year Año Année	Model Modelo Modèle	O.E.M. #	Mount 	Front Delantero Avant	Rear Trasero Arrière
----------------------	---------------------------	----------	--	-----------------------------	----------------------------

INTERNATIONAL (NAVISTAR) ... cont'd





Year	Model	O.E.M. #	Mount	Front	Rear
	Additional O.E.M. Interchanges	2012769C2		83005	
		2023684C1		83015	
		2023685C1		83015	
		2025790C1		83013	
		3541456C1		85929	
		3544766C1		85930	
		3544768C1		85926	
		3549100C1		85926	
		3553628C1		85927	
		3553628C2		85927	
		3558089C1		85925	
		3558089C2		85925	
		3558989C1		85925	
		3558989C2		85925	
		3571713C1		85333	
		3581109C1		85924 or 89457	
		3584535C1		85924 or 89457	
		3596107C1		85927	
		3596107C2		85927	

ISUZU

FTR Series

Year	Model	O.E.M. #	Mount	Front	Rear
2005 - 09	FTR Models with 15000, 19000, 21000 lb Multileaf Springs	15174902		85071
		88982686		85071
2005 - 09	FTR Models with O.E.M. Number	15123676		83136
		88982682		83136
		8-98098-059-0		★ 83159
		8-98098-127-0		G60177
		98098059		★ 83159
		98098127		G60177

FVR Series

Year	Model	O.E.M. #	Mount	Front	Rear
1990 - 09	FVR Models with 15000, 19000, 21000 lb Multileaf Springs	88982686		85071
2009	FVR Models with Hendrickson HAS suspension	12474915		83122 or 89406
		60670-005		83137
2000 - 09	FVR Models with O.E.M. Number	15887728		83136
		19152843		83136
Aug 87 - June 92	FVR Short & Middle Chassis	1-51630-160-0	

Gabriel Part Numbers that appear in BLUE are GasSLX, adjustable shocks. \ Los números de parte Gabriel imprimidos en AZUL son amortiguadores ajustables GasSLX. \ Les numéros de pièce Gabriel imprimés en BLEU sont des amortisseurs ajustables GasSLX.

★ Will be available in first quarter of 2011.

**Gabriel®**

Year Año Année	Model Modelo Modèle	O.E.M. #	Mount 	Front Delantero Avant	Rear Trasero Arrière
----------------------	---------------------------	----------	-----------	-----------------------------	----------------------------

ISUZU ... cont'd**NPR Series**

1986 - 94	NPR Series (All)	9-51630-666-2		85012 or 89413
1986 - 95	NPR Series (NPC & NPN)	51630666		85012 or 89413
		8-94454-647-1		G60177
		8-94454-986-0		G60177
		8-94454-987-0		G60177
		8-97083-029-0		G60177
		94454986		G60177
		9-51630-666-0		85012 or 89413
		9-51630-666-2		85012 or 89413
1989 - 92	NPR Series Flatlow	9-51630-666-0		85012 or 89413
		9-51630-666-2		85012 or 89413
1989 - 90	NPR Series Flatlow	51630647		G60177
		9-51630-647-1		G60177
1986 - 09	NPR, NPR-HD Series with 11000 lb & 13000 lb Suspension	8-94454-987-0		G60177
		8-97083-027-0		G60177
		8-97083-029-0		G60177
		8-97253-620-0		G60177
		8-98098-125-0		G60177
		94454987		G60177
		97083027		G60177
		97083029		G60177
		97253620		G60177
		98098125		G60177
2003 - 09	NPR, NPR-HD Series with O.E.M Number	8-97253-665-0		★ 83159
		8-98098-058-0		★ 83159
		8-98098-059-0		★ 83159
		97253665		★ 83159
		98098058		★ 83159
		98098059		★ 83159

NPR/W4 Series

Jul95-	NPR/W4 Series Single Cab with Short Chassis (NPC7SC), with Middle Chassis (NPC7SF), with Long Chassis (NPC7SK)	8-97119-729-0	
Sep 94 - Jun 95	NPR/W4 Series Single Cab with Short Chassis (NPC7SC), with Middle Chassis (NPC7SF), with Long Chassis (NPC7SK) all with 13000 lb suspension	8-97083-029-0		G60177
Sep 94 - Jun 95	NPR/W4 Series Single Cab with Short Chassis (NPC7SC), with Middle Chassis (NPC7SF), with Long Chassis (NPC7SK) EXC. 13000 lb suspension	8-97083-028-0	
1986- Aug92	NPR/W4 Series with 11000 lb Suspension	8-97083-027-0		G60177
		97083027		G60177
Sep92 -	NPR/W4 Series with 13000 lb Suspension	8-97083-029-0		G60177
Sep88 - Aug92	NPR/W4 Series with 13000 lb Suspension	8-94454-987-0		G60177
		94454987		G60177
1987- Aug88	NPR/W4 Series with 13000 lb Suspension	8-97083-029-0		G60177

Gabriel Part Numbers that appear in BLUE are GasSLX, adjustable shocks. | Los números de parte Gabriel imprimidos en AZUL son amortiguadores ajustables GasSLX. | Les numéros de pièce Gabriel imprimés en BLEU sont des amortisseurs ajustables GasSLX.

★ Will be available in first quarter of 2011.











Gabriel®













Year Año Année	Model Modelo Modèle	O.E.M. #	Mount 	Front Delantero Avant	Rear Trasero Arrière
----------------------	---------------------------	----------	--	-----------------------------	----------------------------

ISUZU ... cont'd





















NQR Series

Year	Model	O.E.M. #	Mount	Front	Rear
2003 - 09	NQR Models with O.E.M. Number	8-97253-620-0		G60177
		8-97253-665-0		★ 83159
		8-98098-059-0		★ 83159
		8-98098-127-0		G60177
		97253620		G60177
		97253665		★ 83159
		98098059		★ 83159
		98098127		G60177

NRR Series

Year	Model	O.E.M. #	Mount	Front	Rear
1988 - 99	NRR Models (All)	1-51630-217-0		83114
		1-51630-217-1		83114
		1-51630-219-1		83114
		51630217		83114
2002 - 09	NRR Models with O.E.M. Number	8-97253-620-0		G60177
		8-97253-665-0		★ 83159
		8-98098059-0		★ 83159
		8-98098-127-0		G60177
		97253620		G60177
		97253665		★ 83159
		98098059		★ 83159
		98098127		G60177

Other Series

Aug 87 - Jun92	EVR Short Chassis	1-51630-180-3	
Aug 87 - Apr93	EVR Short Chassis	1-51630-215-0	
July 92-	EVR Short Chassis, FVR Short & Middle Chassis	1-51630-304-0	
1995 -	FRR Series (All)	1-51630-219-1		83114
		51630219		83114
Oct 89 - 94	FSR Series	1-51630-167-0	
1986 - 92	FSR Series	1-51630-168-1		G60164
		1-51630-217-1		83114
		51630168		G60164
1985	KS22 Series (All)	8-97083-027-0		G60177
		9-51630-666-0		85012 or 89413
		9-51630-666-2		85012 or 89413
	Models with O.E.M. Number	8-22064-231-0		85324
		8-22064-232-0		85071
		8-22064-233-0		83136
		8-22064-489-0		85336
		8-22064-804-0		83136
		8-22064-805-0		83136
		8-22064-806-0		83136
		8-22064-807-0		83136
		8-51630-666-0		85012 or 89413
		898098-1250		G60177
		898098-1270		G60177
		94033786		83114

Gabriel Part Numbers that appear in BLUE are GasSLX, adjustable shocks. \ Los números de parte Gabriel imprimidos en AZUL son amortiguadores ajustables GasSLX. \ Les numéros de pièce Gabriel imprimés en BLEU sont des amortisseurs ajustables GasSLX.

★ Will be available in first quarter of 2011.



Year Año Année	Model Modelo Modèle	O.E.M. #	Mount 	Front Delantero Avant	Rear Trasero Arrière
----------------------	---------------------------	----------	-----------	-----------------------------	----------------------------

JAY MADSEN

Additional O.E.M. Interchanges	3166657 3192333	 	85700 85700
--------------------------------	--------------------	------	----------------

JIFFLOX

Truck Dolly	CP5222		85315
-------------	--------	--	-------	-------

KENWORTH
C500, C500B, C500K, C540 & C550

	All with Air Glide 100 Suspension with 8 air bags, 4 units required	K374-29 K374-32 K374-7 K374-9	 	85310 or 89423 85310 or 89423 85310 or 89423 85310 or 89423
	All with Air Glide 200 with 40,000 lb Suspension with 8 air bags, 4 units required	665903 665944 70701	 	85900 85900 85900
	All with Air Glide 200 with 46,000 lb Suspension with 8 air bags, 4 units required	665906 665945	 	85902 85902
2001 & Up	Models with AirGlide 380 Suspension (38000 lb)	C71-1002		85067 or 89451
	Models with Dual Steering Front Axle and Torsion Bar Bogey Rear Suspension	K374-28 K374-4	 	85314 or 89425 85314 or 89425
- 2009	Models with Multiple Leaf Springs on Front Axle	K374-14 K374-3 K374-33 K374-5	 	83312 or 89409 83312 or 89409 83312 or 89409 83312 or 89409
- 2009	Models with Taper Leaf Springs on Front Axle	K374-11 K374-16 K374-26 K374-27	 	85001 or 89410 85001 or 89410 85001 or 89410 85001 or 89410

K100, K100E, K125

	All with Air Glide 100 Suspension with 8 air bags, 4 units required	K374-29 K374-32 K374-7 K374-9	 	85310 or 89423 85310 or 89423 85310 or 89423 85310 or 89423
--	---	--	--------------	----------------------------------	--

Gabriel Part Numbers that appear in BLUE are GasSLX, adjustable shocks. | Los números de parte Gabriel imprimidos en AZUL son amortiguadores ajustables GasSLX. | Les numéros de pièce Gabriel imprimés en BLEU sont des amortisseurs ajustables GasSLX.



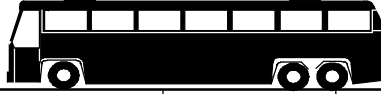















★ Will be available in first quarter of 2011.



















Gabriel®

Year Año Année	Model Modelo Modèle	O.E.M. #	Mount 	Front Delantero Avant	Rear Trasero Arrière
----------------------	---------------------------	----------	---	-----------------------------	----------------------------

KENWORTH ... cont'd

	All with Air Glide 200 with 40,000 lb Suspension with 8 air bags, 4 units required	665903		85900
		665944		85900
		70701		85900
	All with Air Glide 200 with 46,000 lb Suspension with 8 air bags, 4 units required	665906		85902
		665945		85902
	Models with Dual Steering Front Axle and Torsion Bar Bogey Rear Suspension	K374-28		85314 or 89425
		K374-4		85314 or 89425
	Models with Multiple Leaf Springs on Front Axle	K374-14		83312 or 89409
		K374-3		83312 or 89409
		K374-33		83312 or 89409
		K374-5		83312 or 89409
	Models with Set Back Front Axle	665331		83353
		K374-13		83353
		K374-13-1		83353
	Models with Taper Leaf Springs on Front Axle	K374-11		85001 or 89410
		K374-16		85001 or 89410
		K374-26		85001 or 89410
		K374-27		85001 or 89410

K300, T300

	All with Air Glide 100 Suspension with 8 air bags, 4 units required	K374-29		85310 or 89423
		K374-32		85310 or 89423
		K374-7		85310 or 89423
		K374-9		85310 or 89423
	All with Air Glide 200 with 40,000 lb Suspension with 8 air bags, 4 units required	665903		85900
		665944		85900
		70701		85900
	All with Air Glide 200 with 46,000 lb Suspension with 8 air bags, 4 units required	665906		85902
		665945		85902
	K300 COE Medium Duty	665565		85007 or 89412
	Models with Hendrickson Rear Air Suspension	47902-19		83123 or 89405
	Models with Multiple Leaf Springs on Front Axle	K374-14		83312 or 89409
		K374-3		83312 or 89409
		K374-33		83312 or 89409
		K374-5		83312 or 89409
	Models with OEM Number	665617		85031

Gabriel Part Numbers that appear in BLUE are GasSLX, adjustable shocks. \ Los números de parte Gabriel imprimidos en AZUL son amortiguadores ajustables GasSLX. \ Les numéros de pièce Gabriel imprimés en BLEU sont des amortisseurs ajustables GasSLX.

★ Will be available in first quarter of 2011.

**Gabriel®**

Year Año Année	Model Modelo Modèle	O.E.M. #	Mount 	Front Delantero Avant	Rear Trasero Arrière
----------------------	---------------------------	----------	-----------	-----------------------------	----------------------------

KENWORTH ... cont'd

	Models with Reyco 102 or 79KB Suspension (Drive Axle)	16725-01		83221
	Models with Reyco 1209 or 1212 Suspension (Steer Axle)	19495-01		85030 or 89440
	Models with Taper Leaf Springs on Front Axle	K374-11		85001 or 89410
		K374-16		85001 or 89410
		K374-26		85001 or 89410
		K374-27		85001 or 89410
	Models with Woodhead Shock (Stamping Number ACHB 966)	ACHB966		83136

Specialty / Vocational O.E.M. Part Numbers

	Heavy Duty Vocational Models / Cement Mixers	665753	
--	--	--------	--	-------	-------

T170

2008 - 2009	Models with 8,000 lb Dana Front Axle	665617		85031
2008 - 2009	Models with Reyco 79KB Rear Suspension	16725-01		83221

T270

2010 - 11	Models with 10,000 lb to 12,000 lb Front Axle	B71-6005		★ 85084 or ★ 89460
2010 - 11	Models with 13,200 lb & 14,600 lb Front Axle	B71-6006		★ 85084 or ★ 89460
2010 - 11	Models with 21,000 to 23,000 lb Reyco Spring Suspension	1949501		85005
2010 - 11	Models with 8,000 lb Front Axle	B71-6004		★ 85084 or ★ 89460
- 2009	Models with 9,500 lb to 10,500 lb Front Axle	665617		85031
2010 - 11	Models with Hendrickson HAS - 230L Rear Air Suspension	60670-008		83123 or 89405

T370

2010 - 11	Models with 10,000 lb to 12,000 lb Front Axle	B71-6005		★ 85084 or ★ 89460
- 2009	Models with 12,000 lb Front Axle	665617		85031
2010 - 11	Models with 13,200 lb & 14,600 lb Front Axle	B71-6006		★ 85084 or ★ 89460
2010 - 11	Models with 21,000 to 23,000 lb Reyco Spring Suspension	1949501		85005
2010 - 11	Models with 8,000 lb Front Axle	B71-6004		★ 85084 or ★ 89460
2010 - 11	Models with Hendrickson HAS - 230L Rear Air Suspension	60670-008		83123 or 89405
2010	Models with Hendrickson HAS - 400 (Standard) Rear Air Suspension	60670-005		83137

Gabriel Part Numbers that appear in BLUE are GasSLX, adjustable shocks. | Los números de parte Gabriel imprimidos en AZUL son amortiguadores ajustables GasSLX. | Les numéros de pièce Gabriel imprimés en BLEU sont des amortisseurs ajustables GasSLX.

★ Will be available in first quarter of 2011.

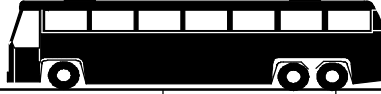





















Gabriel®









Year Año Année	Model Modelo Modèle	O.E.M. #	Mount 	Front Delantero Avant	Rear Trasero Arrière
----------------------	---------------------------	----------	--	-----------------------------	----------------------------

KENWORTH ... cont'd

T400, T400B, T450B

	All with Air Glide 100 Suspension with 8 air bags, 4 units required	K374-29 K374-32 K374-7 K374-9 K374-C7	    	85310 or 89423 85310 or 89423 85310 or 89423 85310 or 89423 85310 or 89423
	All with Air Glide 200 with 40,000 lb Suspension with 8 air bags, 4 units required	665903 665944 70701	  	85900 85900 85900
	All with Air Glide 200 with 46,000 lb Suspension with 8 air bags, 4 units required	665906 665945	 	85902 85902
	Models with Multiple Leaf Springs on Front Axle	K374-14 K374-3 K374-33 K374-5	   	83312 or 89409 83312 or 89409 83312 or 89409 83312 or 89409
	Models with Taper Leaf Springs on Front Axle	K374-11 K374-16 K374-26 K374-27	   	85001 or 89410 85001 or 89410 85001 or 89410 85001 or 89410
	Models with Torsion Bar Bogey (2 rear axles) and KW Air Ride Suspension (with 4 air bags)	K374-28 K374-4	 	85314 or 89425 85314 or 89425

T470

2010 - 11	Models with 12,000 to 20,000 lb Taperleaf Front Suspension	665858		85070 or ★89459
2010 - 11	Models with AG380 Rear Air Suspension	C71-1002		85067 or 89451
2010 - 11	Models with Air Glide 400 Suspension	671962		85936 or 89456
2010 - 11	Models with Air Glide 460 Suspension	671963		85937
2010 - 11	Models with Chalmers 40,000 lb Rear Suspension	665174		85060
2010 - 11	Models with Hendrickson HAS - 230 Rear Air Suspension	60670-005		83137
2010 - 11	Models with Hendrickson HMX 460 Haulmax - - with 16.5" Saddle - - with 17.5" & 18.5" Saddle	60680-004 60680-005	 	83143 83142
2010 - 11	Models with Hendrickson Primaax 460 Air Suspension - - Standard with 8 1/2" to 10" Ride Height	60657-003		85072



Gabriel Part Numbers that appear in BLUE are GasSLX, adjustable shocks. \ Los números de parte Gabriel imprimidos en AZUL son amortiguadores ajustables GasSLX. \ Les numéros de pièce Gabriel imprimés en BLEU sont des amortisseurs ajustables GasSLX.

★ Will be available in first quarter of 2011.



























**Gabriel®**

Year Año Année	Model Modelo Modèle	O.E.M. #	Mount 	Front Delantero Avant	Rear Trasero Arrière
----------------------	---------------------------	----------	--	-----------------------------	----------------------------

KENWORTH ... cont'd

2010 - 11	Models with Neway AD-123 or AD-246 Series Air Suspension with - - Shock stamping number	90045068		89441
		90045099		85906
		90045132		85909

T600, T600A, T600B, T602

	All with Air Glide 100 Suspension with 8 air bags, 4 units required	K374-29		85310 or 89423
		K374-32		85310 or 89423
		K374-7		85310 or 89423
		K374-9		85310 or 89423
		K374-C7		85310 or 89423
	All with Air Glide 200 with 40,000 lb Suspension with 8 air bags, 4 units required	665903		85900
		665944		85900
		70701		85900
	All with Air Glide 200 with 46,000 lb Suspension with 8 air bags, 4 units required	665906		85902
		665945		85902
2006 - 10	Models with 13,000 lb Front Axle	665858		85070 or - ★ 89459
2002 - 2010	Models with Air Glide 380 Rear Air Suspension	C71-1002		85067 or 89451
2005 - 2010	Models with Air Glide 400 Suspension	671962		85936 or 89456
2005 - 2010	Models with Air Glide 460 Suspension	671963		85937
	Models with Hendrickson Rear Air Suspension	47902-19		83123 or 89405
		47902-24		83137
	Models with Multiple Leaf Springs on Front Axle	K374-14		83312 or 89409
		K374-3		83312 or 89409
		K374-33		83312 or 89409
		K374-5		83312 or 89409
	Models with Reyco 102 or 79KB Suspension (Drive Axle)	16725-01		83221
	Models with Reyco 1209 or 1212 Suspension (Steer Axle)	19495-01		85030 or 89440
	Models with Taper Leaf Springs on Front Axle	K374-11		85001 or 89410
		K374-16		85001 or 89410
		K374-26		85001 or 89410
		K374-27		85001 or 89410

Gabriel Part Numbers that appear in BLUE are GasSLX, adjustable shocks. \ Los números de parte Gabriel imprimidos en AZUL son amortiguadores ajustables GasSLX. \ Les numéros de pièce Gabriel imprimés en BLEU sont des amortisseurs ajustables GasSLX.

★ Will be available in first quarter of 2011.

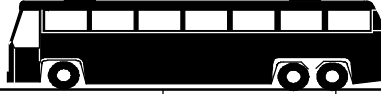



Gabriel®

























Year Año Année	Model Modelo Modèle	O.E.M. #	Mount 	Front Delantero Avant	Rear Trasero Arrière
----------------------	---------------------------	----------	--	-----------------------------	----------------------------

KENWORTH ... cont'd

T660 Series

2006 - 11	Models with 12,000 and 13,200 lb Front Axle	665858		85070 or - ★89459
2008 - 11	Models with 40,000 lb Low Air leaf Suspension	C71-1011		85069 or 89455
2006 - 11	Models with AG380 Rear Air Suspension	C71-1002		85067 or 89451

T800, T800B, T800B(8x4), T800SH, T800H, T800W

	All with Air Glide 100 Suspension with 8 air bags, 4 units required	K374-29		85310 or 89423
		K374-32		85310 or 89423
		K374-7		85310 or 89423
		K374-9		85310 or 89423
		K374-C7		85310 or 89423
	All with Air Glide 200 with 40,000 lb Suspension with 8 air bags, 4 units required	665903		85900
		665944		85900
		70701		85900
	All with Air Glide 200 with 46,000 lb Suspension with 8 air bags, 4 units required	665906		85902
		665945		85902
2005 - 11	Models with 12,000 and 13,200 lb Front Axle	665858		85070 or - ★89459
2001 - 11	Models with Air Glide 380 Suspension (38000 lb)	C71-1002		85067 or 89451
2005 - 11	Models with Air Glide 400 Suspension	671962		85936 or 89456
2005 - 11	Models with Air Glide 460 Suspension	671963		85937
	Models with Hendrickson Rear Air Suspension	47902-19		83123 or 89405
		47902-24		83137
	Models with Multiple Leaf Springs on Front Axle	K374-14		83312 or 89409
		K374-3		83312 or 89409
		K374-33		83312 or 89409
		K374-5		83312 or 89409
	Models with Neway Rear Air Suspension	90044089		83124 or 89407
	Models with Neway Rear Air Suspension (AD123-, AD246-)	90045132		85909
	Models with Reyco 102 or 79KB Suspension (Drive Axle)	16725-01		83221
	Models with Reyco 1209 or 1212 Suspension (Steer Axle)	19495-01		85030 or 89440

Gabriel Part Numbers that appear in BLUE are GasSLX, adjustable shocks. \ Los números de parte Gabriel imprimidos en AZUL son amortiguadores ajustables GasSLX. \ Les numéros de pièce Gabriel imprimés en BLEU sont des amortisseurs ajustables GasSLX.

★ Will be available in first quarter of 2011.



Year Año Année	Model Modelo Modèle	O.E.M. #	Mount 	Front Delantero Avant	Rear Trasero Arrière
----------------------	---------------------------	----------	-----------	-----------------------------	----------------------------

KENWORTH ... cont'd

	Models with Taper Leaf Springs on Front Axle	K374-11 K374-16 K374-26 K374-27	 	85001 or 89410 85001 or 89410 85001 or 89410 85001 or 89410
	Models with Torsion Bar Bogey (2 rear axles) and KW Air Ride Suspension (with 4 air bags)	K374-28 K374-4	 	85314 or 89425 85314 or 89425

T2000

	All with Air Glide 100 Suspension with 8 air bags, 4 units required	K374-29 K374-32 K374-7 K374-9	 	85310 or 89423 85310 or 89423 85310 or 89423 85310 or 89423
	All with Air Glide 200 with 40,000 lb Suspension with 8 air bags, 4 units required	665903 665944 70701	 	85900 85900 85900
	All with Air Glide 200 with 46,000 lb Suspension with 8 air bags, 4 units required	665906 665945	 	85902 85902
2006 - 10	Models with 13,000 lb Front Axle	665858		85070 or ★89459
2002 - 2010	Models with Air Glide 380 Rear Air Suspension	C71-1002		85067 or 89451
2005 - 2010	Models with Air Glide 400 Suspension	671962		85936 or 89456
2005 - 2010	Models with Air Glide 460 Suspension	671963		85937
	Models with Multiple Leaf Springs on Front Axle	K374-14 K374-3 K374-33 K374-5	 	83312 or 89409 83312 or 89409 83312 or 89409 83312 or 89409
	Models with Taper Leaf Springs on Front Axle	K374-11 K374-16 K374-26 K374-27	 	85001 or 89410 85001 or 89410 85001 or 89410 85001 or 89410

Gabriel Part Numbers that appear in BLUE are GasSLX, adjustable shocks. | Los números de parte Gabriel imprimidos en AZUL son amortiguadores ajustables GasSLX. | Les numéros de pièce Gabriel imprimés en BLEU sont des amortisseurs ajustables GasSLX.

★ Will be available in first quarter of 2011.

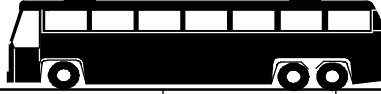





























Gabriel®

Year Año Année	Model Modelo Modèle	O.E.M. #	Mount 	Front Delantero Avant	Rear Trasero Arrière
----------------------	---------------------------	----------	--	-----------------------------	----------------------------

KENWORTH ... cont'd

W900, W900B, W900L, W900S

	All with Air Glide 100 Suspension with 8 air bags, 4 units required	K374-29		85310 or 89423
		K374-32		85310 or 89423
		K374-7		85310 or 89423
		K374-9		85310 or 89423
		K374-C7		85310 or 89423
	All with Air Glide 200 with 40,000 lb Suspension with 8 air bags, 4 units required	665903		85900
		665944		85900
		70701		85900
	All with Air Glide 200 with 46,000 lb Suspension with 8 air bags, 4 units required	665906		85902
		665945		85902
2005 - 10	Models with 12,000 and 13,200 lb Front Axle	665858		85070 or - ★89459
2010	Models with 46,000 lb Neway Rear Air Suspension	90045132		85909
2001 - 2010	Models with Air Glide 380 Suspension (38000 lb)	C71-1002		85067 or 89451
2005 - 2010	Models with Air Glide 400 Suspension	671962		85936 or 89456
2005 - 2010	Models with Air Glide 460 Suspension	671963		85937
	Models with Hendrickson Rear Air Suspension	47902-19		83123 or 89405
		47902-24		83137
	Models with Multiple Leaf Springs on Front Axle	K374-14		83312 or 89409
		K374-3		83312 or 89409
		K374-33		83312 or 89409
		K374-5		83312 or 89409
	Models with Reyco 102 or 79KB Suspension (Drive Axle)	16725-01		83221
	Models with Reyco 1209 or 1212 Suspension (Steer Axle)	19495-01		85030 or 89440
	Models with Taper Leaf Springs on Front Axle	K374-11		85001 or 89410
		K374-16		85001 or 89410
		K374-26		85001 or 89410
		K374-27		85001 or 89410
	Models with Torsion Bar Bogey (2 rear axles) and KW Air Ride Suspension (with 4 air bags)	K374-28		85314 or 89425
		K374-4		85314 or 89425

Gabriel Part Numbers that appear in BLUE are GasSLX, adjustable shocks. \ Los números de parte Gabriel imprimidos en AZUL son amortiguadores ajustables GasSLX. \ Les numéros de pièce Gabriel imprimés en BLEU sont des amortisseurs ajustables GasSLX.

★ Will be available in first quarter of 2011.

**Gabriel®**

Year Año Année	Model Modelo Modèle	O.E.M. #	Mount 	Front Delantero Avant	Rear Trasero Arrière
----------------------	---------------------------	----------	-----------	-----------------------------	----------------------------

KENWORTH ... cont'd**ADDITIONAL O.E.M. NUMBERS**

	All with AG 230 Suspension	671656	
2005 -	All with AG 460 Suspension	671963		85937
2005 -	All with Air Glide 400 Suspension	671962		85936 or 89456
	Models with O.E.M. Number	665453		85001 or 89410
		665670		85001 or 89410
		665680		83312 or 89409
		665828		85067 or 89451
		675041		83353
		675122		85001 or 89410
		680475		85314 or 89425
		680476		85310 or 89423
		680486		85310 or 89423
		680586		85311 or 89424
		K374-15		83353
		K374-C31		83312 or 89409
	Additional O.E.M. Interchanges	3166657		85700	
		665092		83312 or 89409	
		665118		83312 or 89409	
		K374-3-1		83312 or 89409	

KWK- LOC (JIFFLOX)

	Truck Dolly	CP-5222		85315
--	-------------	---------	--	-------	-------

LINK MANUFACTURING LTD.

	(See Cab and Specialty App's Section)				
	Sterling Models with Link Rear Air Suspension	1210-0528		85904
	Models with O.E.M. Number	671093		85904

LODAL, INC.

	Refuse Truck	9960257		83122 or 89406
--	--------------	---------	--	-------------------	-------

M.A.N. BUS

	Americana Bus with O.E.M. Numbers	25-1700-106-654		85708
		81-43701-6543		85708
		81-43701-6572		85708
		81-43701-6573		85722
	Articulating Bus - Drive Axle	81-43701-6537		85709
	Articulating Bus - Front Axle	81-43701-6538		85708
	Articulating Bus - Trailing Axle	81-43701-6539		85708

Gabriel Part Numbers that appear in BLUE are GasSLX, adjustable shocks. | Los números de parte Gabriel imprimidos en AZUL son amortiguadores ajustables GasSLX. | Les numéros de pièce Gabriel imprimés en BLEU sont des amortisseurs ajustables GasSLX.

★ Will be available in first quarter of 2011.



Gabriel®

Year Año Année	Model Modelo Modèle	O.E.M. #	Mount 	Front Delantero Avant	Rear Trasero Arrière
----------------------	---------------------------	----------	---	-----------------------------	----------------------------

M.A.N. BUS ... cont'd





















Models with O.E.M. Number	134		85709
	81-43701-6609		85709
	9020M-1042		85709

MAC TRAILER MFG., INC.

Identification of the trailer suspension is necessary to determine what section of the catalog to refer to. Some possible options can be Chalmers, Hendrickson, Neway, Ridewell, Reyco.				
---	--	--	--	--

MACK

CH Series

CH Series with Hendrickson HA Series Air Suspension	14QK-410M2 14QK-410M3	 	83137 83125
CH600 Series with 12000 lb Taperleaf Spring	14QK-392AM 14QK-392BM 14QK-392BM3 14QK-396M	   	85005 or 89430 85005 or 89430 85005 or 89430 85005 or 89430
CH600 Series with AL Suspension	14QK-393M		85010
CH600 Series with ALV Hendrickson Suspension	14QK-413M5 14QK-413M6	 	83138 83111
CH600 Series with HAS400 MACK Air Suspension	14QK-410M 47902-25	 	83125 83125
CH600 Series with Hendrickson AL-405 Rear Suspension	14QK-413M7		83111
CH600 Series with Hendrickson HN-2 Series Suspension	14QK-415M		83112
CH600 Series with Hendrickson Rear Air	14QK-393AM 47902-9	 	83123 or 89405 83123 or 89405
CH600 Series with Neway AD Air Suspension Shock w/ extend length of 24.30"	14QK-414M2		85909
CH600 Series with ST34 Suspension	14QK-2113M		85001 or 89410
CH600 Series with Steering Axle with Parabolic Taperleaf Spring	14QK-396		85005 or 89430
Models with O.E.M. Number	14QK-2113M 14QK-2113P6	 	85001 or 89410 85007 or 89412
Additional O.E.M. Interchanges	14QK-421M		85014	

CHN - Series

- 2007	CHN-613 Models with 12,000 lb Front Axles	14QK-3107M 20973993	 	85061 or 89450 85061 or 89450
--------	---	------------------------	--	--	----------------

CHU - Pinnacle Series

2008 - 10	CHU-613 Models with 12,000 lb and 14,600 lb Front Axle	14QK-434M 20998401 SDA471700002861	  	85014 85014 85014
-----------	--	--	---	-------------------------	-------------------------

Gabriel Part Numbers that appear in BLUE are GasSLX, adjustable shocks. \ Los números de parte Gabriel imprimidos en AZUL son amortiguadores ajustables GasSLX. \ Les numéros de pièce Gabriel imprimés en BLEU sont des amortisseurs ajustables GasSLX.

★ Will be available in first quarter of 2011.



Year Año Année	Model Modelo Modèle	O.E.M. #	Mount 	Front Delantero Avant	Rear Trasero Arrière
----------------------	---------------------------	----------	-----------	-----------------------------	----------------------------

MACK ... cont'd

2008 - 10	CHU-613 Models with Hendrickson 38,000 lb Rear Air Suspension	14QK-424M		83147
		20570098		83147
		60670-006		83147

CL Series

	CL600, CL700 Series with HAS400 MACK Air Suspension	14QK-410M		83125
		47902-25		83125
	CL600, CL700 Series with Hendrickson Rear Air Susp	14QK-393AM		83123 or 89405
		47902-9		83123 or 89405
	CL600, CL700 Series with Multileaf Spring Suspension	14QK-392AM2		83123 or 89405
		14QK-392BM2		85321
	CL600, CL700 Series with ST34 Suspension	14QK-2113		85001 or 89410
		14QK-2113M		85001 or 89410
	CL600, CL700 Series with Steering Axle & Taperleaf Spring	14QK-392AM		85005 or 89430
		14QK-392BM		85005 or 89430
	CL600/CL700 Series with Neway AD Air Suspension Shock w/ extend length of 24.30"	14QK-414M2		85909
	CL600/CL700 Series with ALV Hendrickson Suspension	14QK-413M5		83138
		14QK-413M6		83111
	CL600/CL700 Series with Hendrickson HA Series Air Suspension	14QK-410M2		83137
		14QK-410M3		83125
	CL600/CL700 Series with Hendrickson HN-2 Series Suspension	14QK-415M		83112

CS, MS - Mid - Liner Series

	CS Series Mid-Liner with O.E.M Number	4103-5000447861		83105
		4103-5000546892		83105
		V10234121		83105
		V10242320		83105
	MS200, MS300 Series Mid-Liner	V10234121		83105

CV - Series

2002 - 07	CV-713 Models with 18,000 lb Front Axles	14QK-366		85036 or 89405
2002 - 07	CV-713 Models with Hendrickson HN-2 Series Suspension	14QK-415M		83112

CX Series - Vision

	CX Vision Series w/ Hendrickson Air Suspension	14QK-431M		85061 or 89450
	CX Vision Series w/ Hendrickson HA Series Air Suspension	14QK-410M2		83137
		14QK-410M3		83125
	CX Vision Series w/ Hendrickson HN-2 Series Suspension	14QK-415M		83112
	CX Vision Series w/ Neway AD Air Suspension Shock w/ extend length of 24.30"	14QK-414M2		85909
	CX Vision Series w/ Parabolic Spring	14QK-431M		85061 or 89450

Gabriel Part Numbers that appear in BLUE are GasSLX, adjustable shocks. \ Los números de parte Gabriel imprimidos en AZUL son amortiguadores ajustables GasSLX. \ Les numéros de pièce Gabriel imprimés en BLEU sont des amortisseurs ajustables GasSLX.











★ Will be available in first quarter of 2011.









Gabriel®

Year Año Année	Model Modelo Modèle	O.E.M. #	Mount 	Front Delantero Avant	Rear Trasero Arrière
----------------------	---------------------------	----------	---	-----------------------------	----------------------------

MACK ... cont'd

	CX Vison Series w/ ALV Hendrickson Suspension	14QK-413M5 14QK-413M6	 	83138 83111
	CX Vison Series w/ MACK Air Suspension	14QK-3101M SDA47170000431	 	85066 or 89448 85066 or 89448
	Models with 12000 lb Front Taperleaf Suspension	14QK-392BM3		85005 or 89430
	Models with HAS400 MACK Air Suspension	14QK-410M 47902-25	 	83125 83125
	Models with Hendrickson Air Suspension (Stamping No. 57241-4)	14QK-413M4		83110
	Models with MAC AL405 Suspension	14QK-413M7		83111
	Models with O.E.M. Number	20513881		85061 or 89450







CXU - Pinnacle Series

2008 - 10	CXU-613 Models with 12,000 lb Front Axles	14QK-3114M 20973993 SDA14170000380	  	85061 or 89450 85061 or 89450 85061 or 89450
2008 - 10	CXU-613 Models with 40,000 lb Rear Air Suspensions	14QK-2136M 20897198 471700002626	  	85061 or 89450 85061 or 89450 85061 or 89450









DM Series

	Models with O.E.M. Number	14QK-2100P8		83242
--	---------------------------	-------------	---	-------	-------

F Series

	F Models with Standard Suspension		85305
	F Series - Eastern		83221
	F Series (exc. Eastern)	 	83207 or 89407 83215
	Fire Truck		85302 or 89420	85302 or 89420
	FL Series - Western	14QK-143 14QK-2100D-P4	 	83207 or 89407 83207 or 89407

GU - Granite Series

2008 - 10	GU-713 Models with 14,600 lb Multi-Leaf Front Springs	14QK-3116M 21010744	 	83101 83101
2008 - 10	GU-713 Models with 20,000 lb Front Axles	14QK-3108M 14QK-427M 20863239	  	85080 85080 85080
2008 - 10	GU-713 Models with Hendrickson 38,000 lb Rear Air Suspension	14QK-424M 20570098 60670-006	  	83147 83147 83147









Gabriel Part Numbers that appear in BLUE are GasSLX, adjustable shocks. \ Los números de parte Gabriel imprimidos en AZUL son amortiguadores ajustables GasSLX. \ Les numéros de pièce Gabriel imprimés en BLEU sont des amortisseurs ajustables GasSLX.

★ Will be available in first quarter of 2011.











**Gabriel®**

Year Año Année	Model Modelo Modèle	O.E.M. #	Mount 	Front Delantero Avant	Rear Trasero Arrière
----------------------	---------------------------	----------	--	-----------------------------	----------------------------











MACK ... cont'd

2008 - 10	GU-813 Models with 14,600 lb Multi-Leaf Front Springs	14QK-3116M		83101
		21010744		83101
2008 - 10	GU-813 Models with 20,000 lb Front Axles	14QK-3108M		85080
		14QK-427M		85080
		20863239		85080
2008 - 10	GU-813 Models with Hendrickson 38,000 lb Rear Air Suspension	14QK-424M		83147
		20570098		83147
		60670-006		83147





MH Series

	MH Series - 4" Wide Springs	14QK-373		83215
		14QK-378M		83215
	MH Series with Camelback Rear Suspension (SS34 & 38)	14QK-2107P1		83215
		14QK-2107P2		83215
	MH Series with Neway ARD-234 Air Suspension	14QK-375M		83123 or 89405
	MH Series with O.E.M. Number	14QK-2113P5		85001 or 89410
		14QK-2133M		85001 or 89410
		14QK-2133M2		85001 or 89410
		14QK-377M		83215
		14QK-392AM		85005 or 89430	85005 or 89430
	MH Series with Taperleaf Rear Suspension	14QK-2113P4		85007 or 89412

RW Series

	RW Series - 4" Wide Springs	14QK-373		83215
		14QK-378M		83215
	RW Series with Camelback Rear Suspension (SS34 & 38)	14QK-2107P1		83215
		14QK-2107P2		83215
	RW Series with Neway ARD-234 Air Suspension	14QK-375M		83123 or 89405
	RW Series with O.E.M. Number	14QK-2113P5		85001 or 89410
		14QK-2133M		85001 or 89410
		14QK-2133M2		85001 or 89410
		14QK-377M		83215
		14QK-392AM		85005 or 89430	85005 or 89430
	RW Series with Taperleaf Rear Suspension	14QK-2113P4		85007 or 89412

TD - Titan Series

2008 - 10	TD-713 Models with Hendrickson 38,000 lb Rear Air Suspension	14QK-424M		83147
		20570098		83147
		60670-006		83147
2008 - 10	TD-713 Models with O.E.M. Number	14QK-493M	
		21155033	

Gabriel Part Numbers that appear in BLUE are GasSLX, adjustable shocks. \ Los números de parte Gabriel imprimidos en AZUL son amortiguadores ajustables GasSLX. \ Les numéros de pièce Gabriel imprimés en BLEU sont des amortisseurs ajustables GasSLX.

★ Will be available in first quarter of 2011.

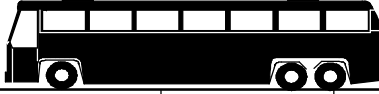

































Gabriel®

Year Año Année	Model Modelo Modèle	O.E.M. #	Mount 	Front Delantero Avant	Rear Trasero Arrière
----------------------	---------------------------	----------	--	-----------------------------	----------------------------

MACK ... cont'd

Mack Additional Series

	B Series	14QK-142		85305
	CF Fire Chassis	14QK-2102		85304
	CM 422 Tractor	14QK-390 V10242320	 	83105 83105
	DM Series	 	83209 or 89414 83215
	MB Series 14QK-2100P4	   83221 83207 or 89407	83215
	Model 75 Bogie Axle		83215
	Models with 12000 lb Taperleaf Spring	14QK-392AM3		85005 or 89430
	Models with Hendrickson AirTek Front Air Suspension	14QK-422M 64838-002	 	85933 or 89454 85933 or 89454
	Models with Hendrickson HAS-40LH Air Suspension (O.E. Number 57241-4)	14QK-413M4		83110
	Models with Inverted Camelback Spring Suspension	14QK-142P1		83215
	Models with MAC AL405 Suspension	14QK-413M7		83111
	Models with Meritor AirLink Suspension	14QK-3100 446-511-211	 	85739 85739
	R, RU, RD600 Series-3 1/2" Wide springs	14QK-366P1		85036 or 89405
	R, U Series	  83221	83215
	R, U, RD 600 Series	14QK-2115 14QK-29302	 	85305 83207 or 89407
	R, U, RD 600 Series/ MR600 Series with Front Taperleaf Springs	14QK-366 14QK-366P1	 	85036 or 89405 85036 or 89405
	RB 600 Series (Drive Axle)	14QK-2107 14QK-393M	 	83215 85010
	RD Series with ST34 Suspension	14QK-2113M		85001 or 89410
	RD800 Series with Shock Absorbers & Taperleaf Suspension (SWT & SWTL 561)(ST-34)	14QK-2110		85305
1975-79	W Series - Western	 	83207 or 89407 83215
	With Neway Rear Suspension (With O.E.Stamping 90045099)	14QK-414M		85906

Gabriel Part Numbers that appear in BLUE are GasSLX, adjustable shocks. \ Los números de parte Gabriel imprimidos en AZUL son amortiguadores ajustables GasSLX. \ Les numéros de pièce Gabriel imprimés en BLEU sont des amortisseurs ajustables GasSLX.

★ Will be available in first quarter of 2011.



Year Año Année	Model Modelo Modèle	O.E.M. #	Mount 	Front Delantero Avant	Rear Trasero Arrière
----------------------	---------------------------	----------	-----------	-----------------------------	----------------------------

MACK ... cont'd

Year	Model	O.E.M. #	Mount	Front	Rear
	Models with O.E.M. Number	14QK-1200P4		83207 or 89407
		14QK-140		85304
		14QK-142AP1		83215
		14QK-145		85307
		14QK-2100P2		83209 or 89414
		14QK-2100P3		83207 or 89407
		14QK-2100P5		83221
		14QK-2100P6		85036 or 89405
		14QK-2100P7		83221
		14QK-2105		83209 or 89414
		14QK-2107		83215
		14QK-2107P2		83215
		14QK-2107P3		83215
		14QK-2108		83203 or 89436
		14QK-2113P3		85001 or 89410
		14QK-2113P6		85007 or 89412
		14QK-2133M		85001 or 89410
		14QK-2133M2		85001 or 89410
		14QK-29001P2		85303 or 89422
		14QK-29301P1		83207 or 89407
		14QK-29301P2		83207 or 89407
		14QK-366P1		85036 or 89405	85036 or 89405
		14QK-366P2		85036 or 89405
		14QK-366P3		85036 or 89405
		14QK-372M3		83122 or 89406
		14QK-378		83215
		14QK-391AM		83041
		14QK-393M		85010
		14QK-396M		85005 or 89430
		14QK-410M2		83137
		14QK-413M5		83138
		14QK-413M6		83111
		14QK-414M2		85909
		14QK-415M		83112
		14QK-424M		83147
		202SU14	
		4717000002861		85014
		60670-6		83147
		651103		85036 or 89405

Gabriel Part Numbers that appear in BLUE are GasSLX, adjustable shocks. | Los números de parte Gabriel imprimidos en AZUL son amortiguadores ajustables GasSLX. | Les numéros de pièce Gabriel imprimés en BLEU sont des amortisseurs ajustables GasSLX.

























★ Will be available in first quarter of 2011.



























Gabriel®

Year Año Année	Model Modelo Modèle	O.E.M. #	Mount 	Front Delantero Avant	Rear Trasero Arrière
----------------------	---------------------------	----------	--	-----------------------------	----------------------------

MACK ... cont'd

Year	Model	O.E.M. #	Mount	Front	Rear
	Additional O.E.M. Interchanges	14QK-140P1		83225	
		14QK-20001P2		85308 or 89422	
		14QK-2100P1		83221	
		14QK-2110P1		85305	
		14QK-282P3		83216	
		14QK-288P2		83217	
		14QK-29302P1		83207 or 89407	
		14QK-3108		85080	
		14QK-3108M		85080	
		14QK-366P4		83209 or 89414	
		14QK-372M		83221	
		14QK-372M2		83209 or 89414	
		14QK-392M		85005 or 89430	
		14QK-427M		85080	
		14QK-428		85080	
		14QK-428M		85080	
		20863239		85080	
		4940654		83216	
		4940654		83216	
		5533699		85302 or 89420	
		5554184		85302 or 89420	
		651012		83221	
		651151		83209 or 89414	
		70042		85302 or 89420	

MAECO

Year	Model	O.E.M. #	Mount	Front	Rear
	Bus with O.E.M. Number	1668722		85030 or 89440	85030 or 89440
	FedEx Trucks with O.E.M. Number	16950		83118
	UPS Trucks with O.E.M. Number	16949		83120
	Additional O.E.M. Interchanges	12608		83125	
		12608		83125	
		12788		83216	
		12866		83207 or 89407	
		16385		83215	
		16720		83107	
		6025		83122 or 89406	
		6026		83204	
		70018		85303 or 89422	
		70021		85303 or 89422	
		70029		85308 or 89422	
		70034		85302 or 89420	
		70039		85303 or 89422	
		70041		85305	
		70042		85302 or 89420	
		70088		85307	
		70123		85716	
		70127		85006 or 89401	
		70128		85006 or 89401	
		70162		85716	
		70163		85302 or 89420	
		70164		85716	















Gabriel Part Numbers that appear in BLUE are GasSLX, adjustable shocks. \ Los números de parte Gabriel imprimidos en AZUL son amortiguadores ajustables GasSLX. \ Les numéros de pièce Gabriel imprimés en BLEU sont des amortisseurs ajustables GasSLX.

★ Will be available in first quarter of 2011.

**Gabriel®**

Year Año Année	Model Modelo Modèle	O.E.M. #	Mount 	Front Delantero Avant	Rear Trasero Arrière
----------------------	---------------------------	----------	--	-----------------------------	----------------------------

MAECO ... cont'd

Additional O.E.M. Interchanges	70300		85320 or 89429
	70300		85320 or 89429
	70312		85001 or 89410
	70315		85063
	70317		89432
	70331		85314 or 89425
	70332		83314
	70334		85316 or 89426
	70397		85006
	70402		85305
	70652		85030 or 89440
	70663		85013 or 89414
	70720		85934
	70721		83125
	74039		85303 or 89422



MARMON

Models with O.E.M. Number	1-7001		83216
	37-1-1		83122 or 89406
	51-139-28		85003 or 89411
	51-163-7		83123 or 89405
	576451		83122 or 89406
	665147		83216













MATSON SCHOOL BUS

Models with O.E.M. Number	5392387		85303 or 89422
---------------------------	---------	---	-----------------------	-------

MERCEDES

L1013, L1113	344-323-75		83100
L1116, L-1117 - Exc. 5900mm Wheel Base	344-323-75		83100

MERITOR

Air Link Suspensions with O.E.M. Number	14QK-3100		85739
	446-511-211		85739
AL460 Air Link Suspension	700115		85712
AL520 Air Link Suspension	700115		85712
FS230 Trailer Suspension (Light Duty)	A-7805P-1030		85737
FS230 Trailer Suspension (Std Duty)	671507		87015
	A-7805L-1026		87015
FS230T	21227751		87015
	671020		87015
2001- RHP11, RHP55 and RideSentry Trailer Suspension	A-7805L-1000		85919
	202447		85919
RHP11, RHP55 and RideSentry Trailer Suspension	A-3280-M-9711		85919
			85919

Gabriel Part Numbers that appear in BLUE are GasSLX, adjustable shocks. \ Los números de parte Gabriel imprimidos en AZUL son amortiguadores ajustables GasSLX. \ Les numéros de pièce Gabriel imprimés en BLEU sont des amortisseurs ajustables GasSLX.

★ Will be available in first quarter of 2011.



Gabriel®



Year Año Année	Model Modelo Modèle	O.E.M. #	Mount 	Front Delantero Avant	Rear Trasero Arrière
----------------------	---------------------------	----------	--	-----------------------------	----------------------------

MERITOR ... cont'd

	Models with O.E.M. Number	671507		87015
		671907		85919
		680705		85737

MITSUBISHI- FUSO

FE Series

July 86-	FE434, FE439, FE444, FE450	MB025382	
		MB161497		G60003
1996- 97	FE639, FE639SP, FE639HDT	MC114595		G60031



FF Series

1986- Jan 87	FF415	MC813511		G60046
--------------	-------	----------	---	--------	-------



FG Series

July89- Mar 91	FG434	MB161741	
		MC110328	
Apr91- Mar93	FG439	MB161748	
		MB294287	



FH Series

Oct 87- 96	FH100 Suspension (All)	MC809390		83103
		MC826268		G60164

FK Series

Nov85- Nov 86	FK414	MC813511		G60046
Dec 86- Feb 91	FK414	MC809295	
Mar 91- 95	FK417	MC809295	
Nov85- May 88	FK455	MC811327	
Jun88- Feb91	FK455	MC814614		85009
Mar91- Jun 93	FK457	MC814614		85009

FM Series

Nov85 - May88	FM555	MC813135		83456 or 89447
Jun 88 - Feb 91	FM555	MC814614		85009
May89 - Jun 93	FM557	MC814614		85009

MOHAWK

	Additional O.E.M. Interchanges	01-0100-905		85303 or 89422	
		020273544		83203 or 89436	
		050134508		85718	
		10134504		85715	
		10134506		85714	
		10234503		85714	
		10234504		85717	
		1235233		85736	
		22012079		85701	
		22012082		85702	
		22012114		85700	

Gabriel Part Numbers that appear in BLUE are GasSLX, adjustable shocks. \ Los números de parte Gabriel imprimidos en AZUL son amortiguadores ajustables GasSLX. \ Les numéros de pièce Gabriel imprimés en BLEU sont des amortisseurs ajustables GasSLX.













★ Will be available in first quarter of 2011.





Gabriel®

Year Año Année	Model Modelo Modèle	O.E.M. #	Mount 	Front Delantero Avant	Rear Trasero Arrière
----------------------	---------------------------	----------	--	-----------------------------	----------------------------

























MOHAWK ... cont'd

Additional O.E.M. Interchanges	4968853		83216
	6-367-7		85305
	680323		85700
	680332		85701
	680485		85733
	695195		85707
	695196		85707
	97-2201-00007		85703
	97-2201-00011		85704
	97-9999-02320		85704
	MM-6886		83207 or 89407
	MM-6957		83225
	MM-74029		85308 or 89422

MOR- RYDE SUSPENSION

Bus Suspension		83103
Recreational Vehicle	U0109-014		83400
Trailer Rear	U0109-7		G60028

MOTOR COACH INDUSTRIES

D 4000 Coach - (Drive Axle) - (Front Axle) - (Trailing Axle)	12-05-1177		85729
	12-05-1176		85728
	12L-5-97		85728
	12-05-1178		85339
	12-05-1194		85339
	12L-5-99		85339
D 4005 Coach - (Drive Axle) - (Front Axle) - (Trailing Axle)	12-05-1177		85729
	12-05-1176		85728
	12L-5-97		85728
	12-05-1194		85339
	12L-5-99		85339
	D 4500 Coach - (Drive Axle) - (Front Axle) - (Trailing Axle)	12-05-1177	
12L-5-88			85729
85729			85729
12-05-1176			85728
12L-5-67			85728
12-05-1179			85727
12L-5-114			85727
D 4505 Coach - (Drive Axle) - (Front Axle) - (Trailing Axle)		12-05-1177	
	12L-5-88		85729
	12-05-1176		85728
	12L-5-67		85728
	12-05-1179		85727
	12L-5-114		85727

Gabriel Part Numbers that appear in BLUE are GasSLX, adjustable shocks. \ Los números de parte Gabriel imprimidos en AZUL son amortiguadores ajustables GasSLX. \ Les numéros de pièce Gabriel imprimés en BLEU sont des amortisseurs ajustables GasSLX.













































★ Will be available in first quarter of 2011.



Gabriel®

Year Año Année	Model Modelo Modèle	O.E.M. #	Mount 	Front Delantero Avant	Rear Trasero Arrière
----------------------	---------------------------	----------	--	-----------------------------	----------------------------

MOTOR COACH INDUSTRIES ... cont'd

	DL3 Bus	12L-5-88 12L-5-89 12L-5-96 12L-5-97	    85728 85728	85729 85729
	DL3 Bus - Drive Axle	12J-5-10		85733
	DL3 Bus - Tag Axle	12L-5-100 12L-5-114	 	85727 85727
	Drive Axle	12J-5-2 12J-5-4 12L-5-71 T14-1081	   	85312 85312 85708 85729
	E 4500 Coach - (Drive Axle)	12-05-1022 12-05-1102 12-05-1138 12-05-1148 12-05-1188	    	★ 85970 ★ 85970 ★ 85970 ★ 85970 ★ 85970
	- (Front Axle)	12-05-1150 12-05-1165	 	85711 85711
	- (Trailing Axle)	12-05-1139 12-05-1147 12-05-1166	  	★ 85341 ★ 85341 ★ 85341
	G 4500 Coach - (45 ft Coach - Tag Axle)	1497835 12-05-6033 12-05-6001 12-05-6054	   	85711 85339 ★ 85740 ★ 85740
	- (Drive Axle)	12-05-6000 12-05-6053	 	85711 85711
	- (Front Axle)	12-05-6002 1498565 12-05-6055	  	85339 85339 85339
	- (Tag Axle)				
	- (Trailing Axle)				
	J 4500 Coach - (Drive Axle)	12-05-1022 12-05-1138 12-05-1148	  	★ 85970 ★ 85970 ★ 85970
	- (Front Axle with OEM Number)	12-05-1137 12-05-1142 12-05-1146 12-05-1150 12-05-1165	    	★ 85340 ★ 85340 ★ 85340 85711 85711
	- (Trailing Axle)	12-05-1139 12-05-1147 12-05-1166	  	★ 85341 ★ 85341 ★ 85341
	Low Floor Buses w/ O.E.M. Number	12L-5-99		85339
	MC5, MC7, MC8	12B-5-1 3178157 680323	  	85700 85700 85700	85700 85700 85700

Gabriel Part Numbers that appear in BLUE are GasSLX, adjustable shocks. \ Los números de parte Gabriel imprimidos en AZUL son amortiguadores ajustables GasSLX. \ Les numéros de pièce Gabriel imprimés en BLEU sont des amortisseurs ajustables GasSLX.







































★ Will be available in first quarter of 2011.



Gabriel®

Year Año Année	Model Modelo Modèle	O.E.M. #	Mount 	Front Delantero Avant	Rear Trasero Arrière
----------------------	---------------------------	----------	--	-----------------------------	----------------------------

MOTOR COACH INDUSTRIES ... cont'd

	RTS Bus with Normal Front	695117 74410	 	85701 85701
	RTS Bus with Regular Rear	G1011822		85702
	RTS Bus with Solid Front Axle	22024673		85710
	Steering - Tag Axle	12L-4-170 654789	 	★ 83158 ★ 83158
	Tag Axle	12-05-6068 12J-5-11 12J-5-3 T14-1082	   	85727 85313 85313 85727
	Models with O.E.M. Number	12-05-1021 12-05-1101 12-05-1137 12-05-1170 12-05-1228 12-5-1-G 12-5-1-GS 12B-5-1-G 12J-5-10 12J-5-10GS 12K-5-1 12L-5-58 12L-5-67 12L-5-69 12L-5-72 12L-5-88 12T-1-13 12TA-01-013 22012067 22024061 22045526 22046485 3178154 4975515 5316984 680232 680322 680323 680350 680369 680374 680441 680452 680462 680470 680482 680485 680544 680546 680602	                            	★ 85340 ★ 85340 ★ 85340 ★ 85340 85711 85700 85700 85700 85733 85733 85728 85728 85700 85303 or 89422 85303 or 89422 85700 85702 85702 85710 85701 85313 85704 85704 85708 85728 85729 85339 85728 85713 85727 85733 85711 85339 85339 85733 85733 85729 85704 85702 85735 85313 85733 85704 85708 85729 85339 85713 85727 85733 85339 85339

Gabriel Part Numbers that appear in BLUE are GasSLX, adjustable shocks. | Los números de parte Gabriel imprimidos en AZUL son amortiguadores ajustables GasSLX. |
Les numéros de pièce Gabriel imprimés en BLEU sont des amortisseurs ajustables GasSLX.



































★ Will be available in first quarter of 2011.























Gabriel®

Year Año Année	Model Modelo Modèle	O.E.M. #	Mount 	Front Delantero Avant	Rear Trasero Arrière
----------------------	---------------------------	----------	---	-----------------------------	----------------------------

MOTOR COACH INDUSTRIES ... cont'd

	Models with O.E.M. Number	680677 680680 680681 695125 G1101590 G1201338 G1201339 G5008069 T14-1029 T14-1045GS T14-1048 T14-1080	            	85728 85710 85700 85701 85700 85728 85729 85727 85704 85713 85702 85302 or 89420
	Additional O.E.M. Interchanges	12G-5-1 12J-5-6 12J-5-7 12J-5-71 12J-5-9 12L-5-70 22012079 22052014 6314933 680231 680323 680332 680333 680470 690029 97-2201-00151 97-2210-00164 97-9999-02514 97-9999-02634	                    	85700 85313 85312 85733 85700 85700 85701 85702 85708 85313 85700 85701 85708 85713 85700 85700 85700 85708 85713 85700 85700 85700	

MUNCIE RECLAMATION

	Models with O.E.M. Number	665568 H53-20415-006 MR-6394 MR-6536	    85723	85051 85051
	Additional O.E.M. Interchanges	97-2210-00164 MR1623 MR1710 MR1751 MR1763 MR1765 MR25767 MR2960 MR2961 MR2996 MR2997 MR3303 MR3304 MR3304H	               	85708 85700 85713 85713 85300 or 89419 85713 85702 85702 85701 85704 85703 85709 85710 85709	

Gabriel Part Numbers that appear in BLUE are GasSLX, adjustable shocks. \ Los números de parte Gabriel imprimidos en AZUL son amortiguadores ajustables GasSLX. \ Les numéros de pièce Gabriel imprimés en BLEU sont des amortisseurs ajustables GasSLX.

★ Will be available in first quarter of 2011.



Gabriel®

Year Año Année	Model Modelo Modèle	O.E.M. #	Mount 	Front Delantero Avant	Rear Trasero Arrière
----------------------	---------------------------	----------	-----------	-----------------------------	----------------------------

MUNCIE RECLAMATION ... cont'd

	Additional O.E.M. Interchanges	MR3306		85705 or 89447	
		MR3307		85707	
		MR3650		85707	
		MR6535		85708	
		MR7388		85710	

NATIONAL COACH CORP

	Eldorado Coach RE-29	C800853		83207 or 89407
--	----------------------	---------	--	----------------	-------

NAVISTAR - see INTERNATIONAL (NAVISTAR)

NEOPLAN BUS

	Mini-Bus	24-1700-106-149		83216
		24-1700-999-362		85009
		BN1002002		85009
		BT1002011		83216
	Model 40	25-1700-101-426		85705 or 89447	85705 or 89447
		DT1002002		85707	85707
	Model 80B	CL1002003		85705 or 89447	85705 or 89447
		DZ1002002		85705 or 89447	85705 or 89447
	Models with O.E.M. Number	680307		85705 or 89447	85705 or 89447
		680308		85706	85706
		AA1002002		85705 or 89447	85705 or 89447
		AA1002003		85705 or 89447	85705 or 89447
		AA1802002		85705 or 89447	85705 or 89447
		AC1002002		85705 or 89447	85705 or 89447
		AC1002003		85705 or 89447	85705 or 89447
		DT1802002		85705 or 89447	85705 or 89447
		GJ1002002		85706	85706
		GJ1002003		85705 or 89447	85705 or 89447
		MM1002002		85705 or 89447	85705 or 89447
MM1002003		85705 or 89447	85705 or 89447		
	Additional O.E.M. Interchanges	97-9999-02519		85707	
		CI 1002003		85705 or 89447	

NEW FLYER

	Diesel Low Floor Coach	009863		85722
		015813		85708
	Models with O.E.M. Number	16415		85727
		680346		85722
		G1011823		85710

Gabriel Part Numbers that appear in BLUE are GasSLX, adjustable shocks. | Los números de parte Gabriel imprimidos en AZUL son amortiguadores ajustables GasSLX. | Les numéros de pièce Gabriel imprimés en BLEU sont des amortisseurs ajustables GasSLX.

★ Will be available in first quarter of 2011.

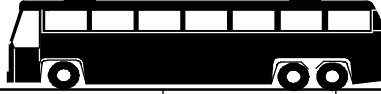

Gabriel®

Year Año Année	Model Modelo Modèle	O.E.M. #	Mount 	Front Delantero Avant	Rear Trasero Arrière
----------------------	---------------------------	----------	--	-----------------------------	----------------------------

NEW FLYER ... cont'd

	Additional O.E.M. Interchanges	015915		85711
		064845		85711
		152959		85708
		680352		85711
		680671		85708
		97-2210-00164		85708

NEWAY (HOLLAND) SUSPENSION SYSTEMS - (See SAF HOLLAND)

NISSAN

	UD 1300 Series Steer Axle	66400		G60091
--	---------------------------	-------	---	--------	-------







UD 1300 Series

	UD 1300 Series Steer Axle	56110-T8123		G60091
		56110-T8129		G60091

UD 1800 Series

1995 - 98	Models with O.E.M. Number	56101-30Z01		★ 83161
		56101-30Z02		G60107
		56110-30Z01		★ 83161
		56110-30Z02		G60107
1989 - 94	Models with O.E.M. Number	56101-Z5008		83114
		56110-Z5008		83114

UD 18CS Series

2005 - 10	Models with O.E.M. Number	56101-30Z01		★ 83161
		56110-30Z01		★ 83161
1999 - 04	Models with O.E.M. Number	56101-Z5008		83114
		56110-Z5008		83114
		56201-Z5001		★ 85085
		56210-Z5001		★ 85085

UD 18HD Series

1999 - 10	Models with O.E.M. Number	56101-30Z01		★ 83161
		56101-30Z02		G60107
		56110-30Z01		★ 83161
		56110-30Z02		G60107

UD 2000 Series

1992 - 94	U D 2600 Models with O.E.M. Number	56201-Z5001		★ 85085
		56210-Z5001		★ 85085
1989 - 04	U D 2600 Models with O.E.M. Number	56101-Z5017		★ 83162
		56110-Z5017		★ 83162
1992 - 94	U D 2800 Models with O.E.M. Number	56201-Z5001		★ 85085
		56210-Z5001		★ 85085
1989 - 94	U D 2800 Models with O.E.M. Number	56101-Z5017		★ 83162
		56110-Z5017		★ 83162
1995 - 04	Models with O.E.M. Number	56101-30Z01		★ 83161
		56101-30Z02		G60107
		56110-30Z01		★ 83161
		56110-30Z02		G60107

Gabriel Part Numbers that appear in BLUE are GasSLX, adjustable shocks. \ Los números de parte Gabriel imprimidos en AZUL son amortiguadores ajustables GasSLX. \ Les numéros de pièce Gabriel imprimés en BLEU sont des amortisseurs ajustables GasSLX.

★ Will be available in first quarter of 2011.



Year Año Année	Model Modelo Modèle	O.E.M. #	Mount 	Front Delantero Avant	Rear Trasero Arrière
----------------------	---------------------------	----------	-----------	-----------------------------	----------------------------

NISSAN ... cont'd

1989 - 94	Models with O.E.M. Number	56101-Z5008		83114
		56110-Z5008		83114
	Models with O.E.M. Number	56110-Z5011		G60164

UD 23DH Series

1995 - 10	Models with O.E.M. Number	56101-30Z01		★ 83161
		56101-30Z02		G60107
		56110-30Z01		★ 83161
		56110-30Z02		G60107

UD 23LP Series

1995 - 10	Models with O.E.M. Number	56101-30Z01		★ 83161
		56101-30Z02		G60107
		56110-30Z01		★ 83161
		56110-30Z02		G60107

UD 3000 Series

1995 - 00	U D 3000 Models with O.E.M. Number	56101-Z5017		★ 83162
		56110-Z5017		★ 83162
1989 - 91	U D 3000 Models with O.E.M. Number	56101-Z5017		★ 83162
		56110-Z5017		★ 83162
1999 - 07	U D 3300 Models with O.E.M. Number	56101-Z5017		★ 83162
		56110-Z5017		★ 83162
		56201-Z5001		★ 85085
		56210-Z5001		★ 85085
1992 - 94	U D 3300 Models with O.E.M. Number	56201-Z5001		★ 85085
		56210-Z5001		★ 85085
1989 - 94	U D 3300 Models with O.E.M. Number	56101-Z5017		★ 83162
		56110-Z5017		★ 83162

NOVA BUS

	Classic Bus with O.E.M. Number	97-2201-00151		85700	85700
	LoFloor Models w/OEM Numbers	481700131250		85377
		481700131252		85378
		680480		85377
		N16248		85377
		N16249		85378
		N21543		85378
		N31830		85378
		N31831		85377
	RTS Bus	22012079		85701
		22045526		85702
		22052014		85702
		4975515		85701
		695117		85701
		74410		85701
	RTS Bus with "V" Drive	G1011822		85702
		G1011823		85710
		G1101590		85713

Gabriel Part Numbers that appear in BLUE are GasSLX, adjustable shocks. | Los números de parte Gabriel imprimidos en AZUL son amortiguadores ajustables GasSLX. | Les numéros de pièce Gabriel imprimés en BLEU sont des amortisseurs ajustables GasSLX.















★ Will be available in first quarter of 2011.



Gabriel®

Year Año Année	Model Modelo Modèle	O.E.M. #	Mount 	Front Delantero Avant	Rear Trasero Arrière
----------------------	---------------------------	----------	---	-----------------------------	----------------------------



NOVA BUS ... cont'd

	RTS Bus with Solid Front Axle	22024673		85710
	Models with O.E.M. Number	12J-5-10		85733
		12J-5-11		85313
		680231		85313
		680232		85733
		680323		85700
		680326		85700
		680470		85713
		680481		85378
		G1201338		85710
		G1201339		85702
		G5008070		85700
		N22212		85700
	Additional O.E.M. Interchanges	97-9999-02514		85700	



OLE GRANNING

	Models with O.E.M. Number	1086		83217
--	---------------------------	------	---	-------	-------



















ONEIDA PRODUCTS

	School Bus w/Heavy Duty Suspension		85307	85307
	School Bus w/Standard Suspension		83216	83216

OPTIMA BUS CORP

	Buses with Ridewell RAS - 227 Series Steer Axle Air Suspension w/ O.E.M. Number	90-2610-SP1		★ 87017
		1260008		★ 87017

ORION BUS INDUSTRIES

	Orion 1	010134505-4		85715
		010134509		85717
		010234503-4		85308 or 89422
		010234506		85714
	Orion 102	050134501-4		85716
		050230501		85716
		050231505		85716
	Orion II	010134505-4		85715
		010234503-4		85308 or 89422
		020117504		85720
		020273541		83203 or 89436
		020273544		83203 or 89436
		020273546		85719
		020273547		85719
		020273548		85719
		020273549		85719
		20117501		85720
		20117503		85720
		20117505		85720





Gabriel Part Numbers that appear in BLUE are GasSLX, adjustable shocks. \ Los números de parte Gabriel imprimidos en AZUL son amortiguadores ajustables GasSLX. \ Les numéros de pièce Gabriel imprimés en BLEU sont des amortisseurs ajustables GasSLX.

★ Will be available in first quarter of 2011.





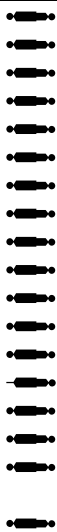

Year Año Année	Model Modelo Modèle	O.E.M. #	Mount 	Front Delantero Avant	Rear Trasero Arrière
----------------------	---------------------------	----------	--	-----------------------------	----------------------------

ORION BUS INDUSTRIES ... cont'd

	Orion V	010134508-4 050134502-4 050134506-4 050134510 050134513 050231505		85718 85718 85718 85732 85732 85716
	Orion VI (Low Floor)	060231508		85717
	Orion VII - 30 ft Rear	070231527		85729
	Orion VII with O.E.M. Number	070131502 070131506 070231514		★ 87016 ★ 87016 85729
	Models with O.E.M. Number	680271 680328 680378 695327 695343 695366 695389 695420 695421 695440	 85717 85720 85732 85732 85732	85714 ★ 87016 85729 ★ 87016 85729
	Additional O.E.M. Interchanges	010134501-4 010134504-4 010134506-4 020273541-4 020273547-4 020273549 050134508 0501345-11 050231502-4 050231507 665596 680091 680274 680352 97-9999-02635 97-9999-02636 A-4890 M340027 OB3166657		85307 85715 85717 85000 or 89436 85719 85719 85718 85718 85716 85716 85719 85303 or 89422 85716 85711 85718 85716 85712 85700	

OSHKOSH MOTORS

	Mobile Home - ForeTravel	1583470		85051
	Models with 16" Long Shock Absorber w/1" Mounting Pins		85303 or 89422
	Models with 3/4" Mounting Pins		83122 or 89406
	Motor Home with O.E. Number	1398980 GBL654875		83127	83127 83117
	V - Line Coach	1573280		83221

Gabriel Part Numbers that appear in BLUE are GasSLX, adjustable shocks. \ Los números de parte Gabriel imprimidos en AZUL son amortiguadores ajustables GasSLX. \ Les numéros de pièce Gabriel imprimés en BLEU sont des amortisseurs ajustables GasSLX.



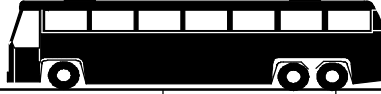



























★ Will be available in first quarter of 2011.





Gabriel®

Year Año Année	Model Modelo Modèle	O.E.M. #	Mount 	Front Delantero Avant	Rear Trasero Arrière
----------------------	---------------------------	----------	--	-----------------------------	----------------------------







OSHKOSH MOTORS ... cont'd

	Models with O.E.M. Number	12405F 12405F-1 1583470 3638112 5353054 5361994 651444 665040 690049 GBL654918 P101977 P117099 P117146	             	85734 85303 or 89422 85303 or 89422 85734 85303 or 89422 85303 or 89422 83118 83120 83118 85051 G60028 83221 85010 83120
	Additional O.E.M. Interchanges	12405FX1 1445910 1573270 1745500 2034140 2173340 2218640 26228-A 2JD137 40-0242 40-4845 40-4951 40-5348 40-6967 665060	               	85303 or 89422 85300 or 89419 83207 or 89407 89430 646177 85303 or 89422 83009 83122 or 89406 83119 83312 or 89409 85304 85316 or 89426 85058 or 89431 85030 or 89440 83122 or 89406	



OSTERLUND TRUCK

	Models with O.E.M. Number	59011 680117	 	83214 85300 or 89419
	Additional O.E.M. Interchanges	220-S5-10		85712

OTTAWA TRUCK

	Yard Tractor 59009	 	85720 83217 83217
	Models with O.E.M. Number	680117		85300 or 89419
	Additional O.E.M. Interchanges	53540451 90013787 90027577 9007342	   	85300 or 89419 85310 or 89423 85720 85303 or 89422	

PACIFIC TRUCK & TRAILER

	Additional O.E.M. Interchanges	3178157C 507202C1	 	85735 85030 or 89440	
--	--------------------------------	----------------------	--	-------------------------	--





Gabriel Part Numbers that appear in BLUE are GasSLX, adjustable shocks. \ Los números de parte Gabriel imprimidos en AZUL son amortiguadores ajustables GasSLX. \ Les numéros de pièce Gabriel imprimés en BLEU sont des amortisseurs ajustables GasSLX.

★ Will be available in first quarter of 2011.



Year Año Année	Model Modelo Modèle	O.E.M. #	Mount 	Front Delantero Avant	Rear Trasero Arrière
----------------------	---------------------------	----------	--	-----------------------------	----------------------------



PAGE SUSPENSION

	Model with LM-2000 Series Lift Axle Suspension	1080099		83203 or 89436
	Model with Trailmaster Air Spring Suspension	1081933		83204
		A-2212		85029
	Models with O.E.M. Number	665133		83203 or 89436
		665267		85029

PAI CORP

	Models with O.E.M. Number	HSA-5067		85305
		HSA-5080		83221
		HSA-5095		83215

PEERLESS TRAILER

	Models with Air Suspension	72-61		83125
	Models with O.E.M. Number	120-1		83125

PETERBILT





270 Series

	Models with Woodhead Shock (Stamping Number ACHB 966)	ACHB966		83136
--	---	---------	---	-------	-------







320 Series

	320 Models with Split Progressive Springs	02-01787		85062 or 89408
		02-02737		85062 or 89408

330 Series

	Models with 12000 lb Set Back Front Axle	02-02738		85012 or 89413
2003 -	Models with Peterbilt 40000 lb Low Air Leaf Suspension	03-08781		85069 or 89455
- 2002	Models with Peterbilt 40000 lb Low Air Leaf Suspension	03-07423		85033 or 89427
2008 -	Models with Peterbilt Low Air Leaf Suspension	C71-1011		85069 or 89455
	Models with O.E.M. Number	02-03020		85910

335 Series

2004 - 10	Models with 12000 lb Set Back Front Axle	02-02738		85012 or 89413
		02-02741		85012 or 89413
2004 - 10	Models with Air Trac Suspension (38000 or 40000 lb)	03-07421		85311 or 89424
2005 - 10	Models with Peterbilt Low Air Leaf Suspension	03-08781		85069 or 89455
		C71-1011		85069 or 89455
2004	Models with Peterbilt Low Air Leaf Suspension	03-07423		85033 or 89427

Gabriel Part Numbers that appear in BLUE are GasSLX, adjustable shocks. \ Los números de parte Gabriel imprimidos en AZUL son amortiguadores ajustables GasSLX. \ Les numéros de pièce Gabriel imprimés en BLEU sont des amortisseurs ajustables GasSLX.

★ Will be available in first quarter of 2011.









Gabriel®

Year Año Année	Model Modelo Modèle	O.E.M. #	Mount 	Front Delantero Avant	Rear Trasero Arrière
----------------------	---------------------------	----------	--	-----------------------------	----------------------------

PETERBILT ... cont'd

337 Series

2010 -	Models with Peterbilt Air Trac Suspension (38000 or 40000 lb)	03-07421		85311 or 89424
2010 -	Models with Peterbilt Low Air Leaf Suspension	03-08781		85069 or 89455
		C71-1011		85069 or 89455
2010 -	Models with Reyco 102AR (Standard) Rear Air Suspension	12887-01		85013 or 89414
		12887-02		85013 or 89414
2010 -	Models with Reyco 79KB Rear Steel Spring Suspension	16725-01		83221

340 Series

2007 - 10	Models with 12000 lb Set Back Front Axle	02-02738		85012 or 89413
		02-02741		85012 or 89413
2007 - 10	Models with Air Trac Suspension (38000 or 40000 lb)	03-07421		85311 or 89424









349 Series

	349 Conventional Models with 12000 lb capacity	02-00376		85302 or 89420
		02-00495		85302 or 89420
		02-02736		85302 or 89420

353 Series

	353 Conventional Models with 12000 lb capacity	02-00376		85302 or 89420
		02-00495		85302 or 89420
		02-02736		85302 or 89420

357 Series

	Conventional Models with Front Air Suspension and Set Back Front Axle.	02-02739		85013 or 89414
	Conventional Models with Front Air Suspension and without Set Back Front Axle.	02-02740		85036 or 89405
	Conventional Models with Spring Suspension and with Set Back Front Axle.	02-02738		85012 or 89413
		02-02741		85012 or 89413
	Conventional Models with Spring Suspension and without Set Back Front Axle.	02-02737		85062 or 89408
		02-02742		85062 or 89408
to Nov 82	Models with Air Trac Suspension (38000 or 40000 lb)	03-04176		85308 or 89422
after Nov 82	Models with Air Trac Suspension (38000 or 40000 lb)	03-07421		85311 or 89424
	Models with Chalmers 40,000 lb Rear Suspension	665174		85060

Gabriel Part Numbers that appear in BLUE are GasSLX, adjustable shocks. \ Los números de parte Gabriel imprimidos en AZUL son amortiguadores ajustables GasSLX. \ Les numéros de pièce Gabriel imprimés en BLEU sont des amortisseurs ajustables GasSLX.

★ Will be available in first quarter of 2011.



Year Año Année	Model Modelo Modèle	O.E.M. #	Mount 	Front Delantero Avant	Rear Trasero Arrière
----------------------	---------------------------	----------	-----------	-----------------------------	----------------------------

PETERBILT ... cont'd

	Models with Neway ARD 125/244-8 Series Rear Air Suspension	90044011		85004
2003 & up	Models with Peterbilt Low Air Leaf Suspension	03-08781		85069 or 89455
- 2003	Models with Peterbilt Low Air Leaf Suspension	03-07423		85033 or 89427
		665633		85033 or 89427

359 Series

	359 Conventional Models with 12000 lb capacity	02-00376		85302 or 89420
		02-00495		85302 or 89420
		02-02736		85302 or 89420

362 Series

	C.O.E. Models with 12000 lb capacity	02-02736		85302 or 89420
	C.O.E. Models with 14600 lb Taper Leaf Springs and Set Back Front Axle	02-02740		85036 or 89405
	C.O.E. Models with 14600 lb Taper Leaf Springs and Set Forward Front Axle	680599	
	C.O.E. Models with Progressive Springs	02-02738		85012 or 89413
	C.O.E. Models without Set Back Front Axle	02-00376		85302 or 89420
		02-00495		85302 or 89420
to Nov 82	Models with Air Trac Suspension (38000 or 40000 lb)	03-04176		85308 or 89422
after Nov 82	Models with Air Trac Suspension (38000 or 40000 lb)	03-07421		85311 or 89424
	Models with Chalmers 40,000 lb Rear Suspension	665174		85060
	Models with Neway ARD 125/244-8 Series Rear Air Suspension	90044011		85004
2003 & up	Models with Peterbilt Low Air Leaf Suspension	03-08781		85069 or 89455
- 2003	Models with Peterbilt Low Air Leaf Suspension	03-07423		85033 or 89427
		665633		85033 or 89427

365 Series

2008 - 10	Models with 12,000 lb to 16,000 lb Taperleaf Front Spring Suspension	B71-6002		85012 or 89413
2008 - 10	Models with 18,000 lb to 23,000 lb Taperleaf Front Spring Suspension	02-02742		85062 or 89408
2008 - 10	Models with Air Trac Suspension (38000 or 40000 lb)	03-07421		85311 or 89424
2008 - 10	Models with FlexAir Suspension (38000 lb)	C71-1002		85067 or 89451
		C71-6000		85067 or 89451
2008 - 11	Models with Hendrickson HMX 460 Haulmax with 16.5" Saddle	60680-004		83143
2008 - 10	Models with Hendrickson HMX 460 Haulmax with 17.5" & 18.5" Saddle	60680-005		83142

Gabriel Part Numbers that appear in BLUE are GasSLX, adjustable shocks. | Los números de parte Gabriel imprimidos en AZUL son amortiguadores ajustables GasSLX. | Les numéros de pièce Gabriel imprimés en BLEU sont des amortisseurs ajustables GasSLX.

★ Will be available in first quarter of 2011.

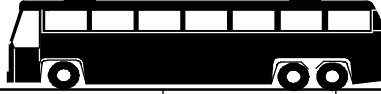











Gabriel®

Year Año Année	Model Modelo Modèle	O.E.M. #	Mount 	Front Delanero Avant	Rear Trasero Arrière
----------------------	---------------------------	----------	--	----------------------------	----------------------------









PETERBILT ... cont'd

2008 - 10	Models with Peterbilt Low Air Leaf Suspension	03-08781		85069 or 89455
		C71-1011		85069 or 89455
2008 - 10	Models with Quadraflex 4 Spring Rear Suspension	03-07420		85336







367 Series

2008 - 10	Models with 10,000 lb to 16,000 lb Taperleaf Front Spring Suspension	B71-6002		85012 or 89413
2008 - 10	Models with 18,000 lb to 23,000 lb Taperleaf Front Spring Suspension	02-02742		85062 or 89408
2008 - 10	Models with Air Trac Suspension (38000 or 40000 lb)	03-07421	
2008 - 10	Models with FlexAir Suspension (38000 lb)	C71-1002		85067 or 89451
		C71-6000		85067 or 89451
2008 - 11	Models with Hendrickson HMX 460 Haulmax with 16.5" Saddle	60680-004		83143
2008 - 10	Models with Hendrickson HMX 460 Haulmax with 17.5" & 18.5" Saddle	60680-005		83142
2008 - 10	Models with Peterbilt Low Air Leaf Suspension	03-08781		85069 or 89455
		C71-1011		85069 or 89455
2008 - 10	Models with Quadraflex 4 Spring Rear Suspension	03-07420		85336

372 Series

	C.O.E. Models with Front Air Suspension	02-02739		85013 or 89414
	C.O.E. Models with Front Spring Suspension	02-02738		85012 or 89413
to Nov 82	Models with Air Trac Suspension (38000 or 40000 lb)	03-04176		85308 or 89422
after Nov 82	Models with Air Trac Suspension (38000 or 40000 lb)	03-07421		85311 or 89424
	Models with Chalmers 40,000 lb Rear Suspension	665174		85060
	Models with Neway ARD 125/244-8 Series Rear Air Suspension	90044011		85004
2003 & up	Models with Peterbilt Low Air Leaf Suspension	03-08781		85069 or 89455
- 2003	Models with Peterbilt Low Air Leaf Suspension	03-07423		85033 or 89427
		665633		85033 or 89427

375 Series

	Conventional Models with Front Air Suspension and Set Back Front Axle.	02-02739		85013 or 89414
	Conventional Models with Front Air Suspension and without Set Back Front Axle.	02-02740		85036 or 89405
	Conventional Models with Spring Suspension and with Set Back Front Axle.	02-02738		85012 or 89413
		02-02741		85012 or 89413
	Conventional Models with Spring Suspension and without Set Back Front Axle.	02-02737		85062 or 89408
		02-02742		85062 or 89408







Gabriel Part Numbers that appear in BLUE are GasSLX, adjustable shocks. \ Los números de parte Gabriel imprimidos en AZUL son amortiguadores ajustables GasSLX. \ Les numéros de pièce Gabriel imprimés en BLEU sont des amortisseurs ajustables GasSLX.

★ Will be available in first quarter of 2011.















Year Año Année	Model Modelo Modèle	O.E.M. #	Mount 	Front Delantero Avant	Rear Trasero Arrière
----------------------	---------------------------	----------	--	-----------------------------	----------------------------







PETERBILT ... cont'd

to Nov 82	Models with Air Trac Suspension (38000 or 40000 lb)	03-04176		85308 or 89422
after Nov 82	Models with Air Trac Suspension (38000 or 40000 lb)	03-07421		85311 or 89424
	Models with Chalmers 40,000 lb Rear Suspension	665174		85060
	Models with Neway ARD 125/244-8 Series Rear Air Suspension	90044011		85004
2003 & up	Models with Peterbilt Low Air Leaf Suspension	03-08781		85069 or 89455
- 2003	Models with Peterbilt Low Air Leaf Suspension	03-07423		85033 or 89427
		665633		85033 or 89427

376 Series

	Conventional Models with Front Air Suspension and Set Back Front Axle.	02-02739		85013 or 89414
	Conventional Models with Front Air Suspension and without Set Back Front Axle.	02-02740		85036 or 89405
	Conventional Models with Spring Suspension and with Set Back Front Axle.	02-02738		85012 or 89413
		02-02741		85012 or 89413
	Conventional Models with Spring Suspension and without Set Back Front Axle.	02-02737		85062 or 89408
		02-02742		85062 or 89408
to Nov 82	Models with Air Trac Suspension (38000 or 40000 lb)	03-04176		85308 or 89422
after Nov 82	Models with Air Trac Suspension (38000 or 40000 lb)	03-07421		85311 or 89424
	Models with Chalmers 40,000 lb Rear Suspension	665174		85060
	Models with Neway ARD 125/244-8 Series Rear Air Suspension	90044011		85004
2003 & up	Models with Peterbilt Low Air Leaf Suspension	03-08781		85069 or 89455
- 2003	Models with Peterbilt Low Air Leaf Suspension	03-07423		85033 or 89427
		665633		85033 or 89427

377 Series

	Conventional Models with Front Air Suspension and Set Back Front Axle.	02-02739		85013 or 89414
	Conventional Models with Front Air Suspension and without Set Back Front Axle.	02-02740		85036 or 89405
	Conventional Models with Spring Suspension and with Set Back Front Axle.	02-02738		85012 or 89413
		02-02741		85012 or 89413
	Conventional Models with Spring Suspension and without Set Back Front Axle.	02-02737		85062 or 89408
		02-02742		85062 or 89408
to Nov 82	Models with Air Trac Suspension (38000 or 40000 lb)	03-04176		85308 or 89422

Gabriel Part Numbers that appear in BLUE are GasSLX, adjustable shocks. \ Los números de parte Gabriel imprimidos en AZUL son amortiguadores ajustables GasSLX. \ Les numéros de pièce Gabriel imprimés en BLEU sont des amortisseurs ajustables GasSLX.



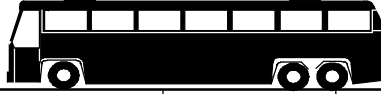



★ Will be available in first quarter of 2011.

















Gabriel®

Year Año Année	Model Modelo Modèle	O.E.M. #	Mount 	Front Delantero Avant	Rear Trasero Arrière
----------------------	---------------------------	----------	--	-----------------------------	----------------------------







PETERBILT ... cont'd

after Nov 82	Models with Air Trac Suspension (38000 or 40000 lb)	03-07421		85311 or 89424
	Models with Chalmers 40,000 lb Rear Suspension	665174		85060
	Models with Neway ARD 125/244-8 Series Rear Air Suspension	90044011		85004
2003 & up	Models with Peterbilt Low Air Leaf Suspension	03-08781		85069 or 89455
- 2003	Models with Peterbilt Low Air Leaf Suspension	03-07423		85033 or 89427
		665633		85033 or 89427

378 Series

	Conventional Models with Front Air Suspension and Set Back Front Axle.	02-02739		85013 or 89414
	Conventional Models with Front Air Suspension and without Set Back Front Axle.	02-02740		85036 or 89405
	Conventional Models with Spring Suspension and with Set Back Front Axle.	02-02738		85012 or 89413
		02-02741		85012 or 89413
	Conventional Models with Spring Suspension and without Set Back Front Axle.	02-02737		85062 or 89408
		02-02742		85062 or 89408
to Nov 82	Models with Air Trac Suspension (38000 or 40000 lb)	03-04176		85308 or 89422
after Nov 82	Models with Air Trac Suspension (38000 or 40000 lb)	03-07421		85311 or 89424
	Models with Chalmers 40,000 lb Rear Suspension	665174		85060
2001 & Up	Models with FlexAir Suspension (38000 lb)	C71-6000		85067 or 89451
	Models with Neway ARD 125/244-8 Series Rear Air Suspension	90044011		85004
2003 & up	Models with Peterbilt Low Air Leaf Suspension	03-08781		85069 or 89455
- 2003	Models with Peterbilt Low Air Leaf Suspension	03-07423		85033 or 89427
		665633		85033 or 89427

379 Series

	Conventional Models with Front Air Suspension and Set Back Front Axle.	02-02739		85013 or 89414
	Conventional Models with Front Air Suspension and without Set Back Front Axle.	02-02740		85036 or 89405
	Conventional Models with Spring Suspension and with Set Back Front Axle.	02-02738		85012 or 89413
		02-02741		85012 or 89413
	Conventional Models with Spring Suspension and without Set Back Front Axle.	02-02737		85062 or 89408
		02-02742		85062 or 89408
to Nov 82	Models with Air Trac Suspension (38000 or 40000 lb)	03-04176		85308 or 89422

Gabriel Part Numbers that appear in BLUE are GasSLX, adjustable shocks. \ Los números de parte Gabriel imprimidos en AZUL son amortiguadores ajustables GasSLX. \ Les numéros de pièce Gabriel imprimés en BLEU sont des amortisseurs ajustables GasSLX.

★ Will be available in first quarter of 2011.



Year Año Année	Model Modelo Modèle	O.E.M. #	Mount 	Front Delantero Avant	Rear Trasero Arrière
----------------------	---------------------------	----------	-----------	-----------------------------	----------------------------

PETERBILT ... cont'd

after Nov 82	Models with Air Trac Suspension (38000 or 40000 lb)	03-07421		85311 or 89424
	Models with Chalmers 40,000 lb Rear Suspension	665174		85060
2001 & Up	Models with FlexAir Suspension (38000 lb)	C71-6000		85067 or 89451
	Models with Neway ARD 125/244-8 Series Rear Air Suspension	90044011		85004
2003 & up	Models with Peterbilt Low Air Leaf Suspension	03-08781		85069 or 89455
- 2003	Models with Peterbilt Low Air Leaf Suspension	03-07423		85033 or 89427
		665633		85033 or 89427

382 Series

2010 -	Models with 12,000 lb to 14,600 lb Taperleaf Spring Suspension	02-02737		85062 or 89408
2010 -	Models with Air Trac Suspension (38000 or 40000 lb)	03-07421		85311 or 89424
2010 -	Models with FlexAir Suspension (38000 lb)	C71-1002		85067 or 89451
		C71-6000		85067 or 89451
2010 -	Models with Peterbilt Low Air Leaf Suspension	03-08781		85069 or 89455
		C71-1011		85069 or 89455
2010 -	Models with Quadraflex 4 Spring Rear Suspension	03-07420		85336
2010 -	Models with Reyco 102AR (Standard) Rear Air Suspension	12887-01		85013 or 89414
		12887-02		85013 or 89414
2010 -	Models with Reyco 79KB Rear Steel Spring Suspension	16725-01		83221

384 Series

2010 -	Models with 12,000 lb to 14,600 lb Taperleaf Spring Suspension and Set Forward Front Axle.	02-02737		85062 or 89408
2010 -	Models with Air Trac Suspension (38000 or 40000 lb)	03-07421		85311 or 89424
2010 -	Models with FlexAir Suspension (38000 lb)	C71-1002		85067 or 89451
		C71-6000		85067 or 89451
2010 -	Models with Peterbilt Low Air Leaf Suspension	03-08781		85069 or 89455
		C71-1011		85069 or 89455
2010 -	Models with Quadraflex 4 Spring Rear Suspension	03-07420		85336

385 Series

- 2009	Conventional Models with Spring Suspension and with Set Back Front Axle.	02-02738		85012 or 89413
		02-02741		85012 or 89413

Gabriel Part Numbers that appear in BLUE are GasSLX, adjustable shocks. \ Los números de parte Gabriel imprimidos en AZUL son amortiguadores ajustables GasSLX. \ Les numéros de pièce Gabriel imprimés en BLEU sont des amortisseurs ajustables GasSLX.



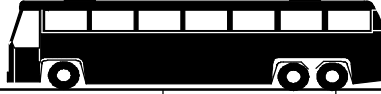







★ Will be available in first quarter of 2011.













Gabriel®

Year Año Année	Model Modelo Modèle	O.E.M. #	Mount 	Front Delantero Avant	Rear Trasero Arrière
----------------------	---------------------------	----------	--	-----------------------------	----------------------------





PETERBILT ... cont'd

- 2009	Conventional Models with Spring Suspension and without Set Back Front Axle.	02-02737		85062 or 89408
		02-02742		85062 or 89408
to Nov 82	Models with Air Trac Suspension	03-04176		85308 or 89422
after Nov 82	Models with Air Trac Suspension	03-07421		85311 or 89424
	Models with Chalmers 40,000 lb Rear Suspension	665174		85060
2001 & Up	Models with FlexAir Suspension (38000 lb)	C71-6000		85067 or 89451
	Models with Neway ARD 125/244-8 Series Rear Air Suspension	90044011		85004
2003 & up	Models with Peterbilt Low Air Leaf Suspension	03-08781		85069 or 89455
- 2003	Models with Peterbilt Low Air Leaf Suspension	03-07423		85033 or 89427
		665633		85033 or 89427
	Models with Quadraflex 4 Spring Rear Suspension	03-07420		85336

386 Series

2006 -	Conventional Models with Front Air Suspension and Set Back Front Axle.	02-02739		85013 or 89414
2006 -	Conventional Models with Front Air Suspension and without Set Back Front Axle.	02-02740		85036 or 89405
2006 -	Conventional Models with Spring Suspension and with Set Back Front Axle.	02-02738		85012 or 89413
		02-02741		85012 or 89413
		02-04010		85012 or 89413
2006 -	Conventional Models with Spring Suspension and without Set Back Front Axle.	02-02737		85062 or 89408
		02-02742		85062 or 89408
2006 -	Models with FlexAir Suspension (38000 lb)	C71-6000		85067 or 89451
2006 -	Models with Peterbilt Air Leaf Suspension	03-07421		85311 or 89424
2008 -	Models with Peterbilt Low Air Leaf Suspension	C71-1011		85069 or 89455
2006 -	Models with Peterbilt Low Air Leaf Suspension	03-08781		85069 or 89455

387 Series

- 2009	Conventional Models with Front Air Suspension and Set Back Front Axle.	02-02739		85013 or 89414
- 2009	Conventional Models with Front Air Suspension and without Set Back Front Axle.	02-02740		85036 or 89405
- 2009	Conventional Models with Spring Suspension and with Set Back Front Axle.	02-02738		85012 or 89413
		02-02741		85012 or 89413
		02-04010		85012 or 89413









Gabriel Part Numbers that appear in BLUE are GasSLX, adjustable shocks. \ Los números de parte Gabriel imprimidos en AZUL son amortiguadores ajustables GasSLX. \ Les numéros de pièce Gabriel imprimés en BLEU sont des amortisseurs ajustables GasSLX.

★ Will be available in first quarter of 2011.











Year Año Année	Model Modelo Modèle	O.E.M. #	Mount 	Front Delantero Avant	Rear Trasero Arrière
----------------------	---------------------------	----------	--	-----------------------------	----------------------------









PETERBILT ... cont'd

- 2009	Conventional Models with Spring Suspension and without Set Back Front Axle.	02-02737		85062 or 89408
		02-02742		85062 or 89408
2001 & Up	Models with FlexAir Suspension (38000 lb)	C71-6000		85067 or 89451
- 2009	Models with Peterbilt Air Leaf Suspension	03-07421		85311 or 89424
2008 -	Models with Peterbilt Low Air Leaf Suspension	C71-1011		85069 or 89455
2003 & up	Models with Peterbilt Low Air Leaf Suspension	03-08781		85069 or 89455
- 2003	Models with Peterbilt Low Air Leaf Suspension	03-07423		85033 or 89427
		665633		85033 or 89427

388 Series

2008 -	Conventional Models with Front Air Suspension and Set Back Front Axle.	02-02739		85013 or 89414
2008 -	Conventional Models with Front Air Suspension and without Set Back Front Axle.	02-02740		85036 or 89405
2008 -	Conventional Models with Spring Suspension and with Set Back Front Axle.	02-04010		85012 or 89413
2008 -	Conventional Models with Spring Suspension and without Set Back Front Axle.	02-02742		85062 or 89408
2008 -	Models with FlexAir Suspension (38000 lb)	C71-6000		85067 or 89451
2008 -	Models with Peterbilt Air Leaf Suspension	03-07421		85311 or 89424
2008 -	Models with Peterbilt Low Air Leaf Suspension	03-08781		85069 or 89455
		C71-1011		85069 or 89455

389 Series

2008 -	Conventional Models with Front Air Suspension and Set Back Front Axle.	02-02739		85013 or 89414
2008 -	Conventional Models with Front Air Suspension and without Set Back Front Axle.	02-02740		85036 or 89405
2008 -	Conventional Models with Spring Suspension and with Set Back Front Axle.	02-04010		85012 or 89413
2008 -	Conventional Models with Spring Suspension and without Set Back Front Axle.	02-02742		85062 or 89408
2008 -	Models with FlexAir Suspension (38000 lb)	C71-6000		85067 or 89451
2008 -	Models with Peterbilt Air Leaf Suspension	03-07421		85311 or 89424
2008 -	Models with Peterbilt Low Air Leaf Suspension	03-08781		85069 or 89455
		C71-1011		85069 or 89455

Gabriel Part Numbers that appear in BLUE are GasSLX, adjustable shocks. \ Los números de parte Gabriel imprimidos en AZUL son amortiguadores ajustables GasSLX. \ Les numéros de pièce Gabriel imprimés en BLEU sont des amortisseurs ajustables GasSLX.

★ Will be available in first quarter of 2011.













Gabriel®























Year Año Année	Model Modelo Modèle	O.E.M. #	Mount 	Front Delantero Avant	Rear Trasero Arrière
----------------------	---------------------------	----------	---	-----------------------------	----------------------------

PETERBILT ... cont'd

587 Series

2010 -	Models with 12,000 lb to 14,600 lb Taperleaf Spring Suspension	02-02737		85062 or 89408
2010 -	Models with Air Trac Suspension (38000 or 40000 lb)	03-07421		85311 or 89424
2010 -	Models with FlexAir Suspension (38000 lb)	C71-1002 C71-6000	 	85067 or 89451 85067 or 89451
2010 -	Models with Peterbilt Low Air Leaf Suspension	03-08781 C71-1011	 	85069 or 89455 85069 or 89455
2010 -	Models with Quadraflex 4 Spring Rear Suspension	03-07420		85336
2010 -	Models with Reyco 102AR (Standard) Rear Air Suspension	12887-01 12887-02	 	85013 or 89414 85013 or 89414
2010 -	Models with Reyco 79KB Rear Steel Spring Suspension	16725-01		83221

Additional Applications

	Models with Quadraflex 4 spring rear suspension	03-04628 03-07420	 	85336 85336
	Models with O.E.M. Number	02-01787 02-01890 02-02061 02-02142 02-02225 03-01635 03-01635 03-04629 03-05106 03-05384 03-06084 03-07281 03-07424 23-08233 23-10393 23-12262 665133	                   	85062 or 89408 85012 or 89413 85013 or 89414 85036 or 89405 85012 or 89413 85012 or 89413 85308 or 89422 85308 or 89422 85311 or 89424 85033 or 89427 85033 or 89427 85033 or 89427 85311 or 89424 85311 or 89424 85308 or 89422 85308 or 89422 83203 or 89436

Gabriel Part Numbers that appear in BLUE are GasSLX, adjustable shocks. \ Los números de parte Gabriel imprimidos en AZUL son amortiguadores ajustables GasSLX. \ Les numéros de pièce Gabriel imprimés en BLEU sont des amortisseurs ajustables GasSLX.

★ Will be available in first quarter of 2011.



Year Año Année	Model Modelo Modèle	O.E.M. #	Mount 	Front Delantero Avant	Rear Trasero Arrière
----------------------	---------------------------	----------	-----------	-----------------------------	----------------------------

PETERBILT ... cont'd

Year	Model	O.E.M. #	Mount	Front	Rear
	Models with O.E.M. Number	665656		85012 or 89413
		665657		85013 or 89414
		665658		85036 or 89405
		665660		85033 or 89427
		665662		85012 or 89413
		665738		85910
		665752		85067 or 89451
		665762		85012 or 89413
		665826		85069 or 89455
		665876		85959
		671091		85069 or 89455
		671092		85012 or 89413
		680026		85302 or 89420
		680027		85308 or 89422
		680185		85308 or 89422
		680348		85012 or 89413
		680435		85033 or 89427
		680457		85302 or 89420
		680458		85336
		680459		85311 or 89424
		680586		85311 or 89424
		B71-6000		85959
		B71-6002		85012 or 89413

PIERCE MANUFACTURING INC.

Year	Model	O.E.M. #	Mount	Front	Rear
	Additional O.E.M. Interchanges	1445910		85300 or 89419
		2034140		646155
		40-0242		83312 or 89409
		40-4845		85304
		40-4951		85316 or 89426
		40-5348		85058 or 89431
		40-6967		85030 or 89440

PREVOST

Year	Model	O.E.M. #	Mount	Front	Rear
2004 - 09	H3 Bus, H3 VIP Bus				
	- Drive and Tag Axle Shocks	630253	
	- VIP with Independant Front Suspension	630251	
	- With I-Beam Front Suspension	630252	

Gabriel Part Numbers that appear in BLUE are GasSLX, adjustable shocks. | Los números de parte Gabriel imprimidos en AZUL son amortiguadores ajustables GasSLX. | Les numéros de pièce Gabriel imprimés en BLEU sont des amortisseurs ajustables GasSLX.

































★ Will be available in first quarter of 2011.



Gabriel®

Year Año Année	Model Modelo Modèle	O.E.M. #	Mount 	Front Delantero Avant	Rear Trasero Arrière
----------------------	---------------------------	----------	--	-----------------------------	----------------------------

PREVOST ... cont'd

1996 - 03	H3 Bus, H3 VIP Bus				
	- Drive and Tag Axle Shocks	630127		85736
1996 - 03	- With I-Beam Front Suspension	650407		85736
		630134		85329
		680422		85329
	LeMirage XL 40 ft, 45 ft, & H Series Coaches with Independant Front Suspension	630136		85330
	LeMirage XL 40 ft, 45 ft, & H3-45 VIP Coaches with I-Beam Front Suspension	630134		85329
	LoFloor Models w/OEM Numbers	N16249		85378
	X3-45 Bus				
	- Drive and Tag Axle Shocks	630253	
	- With I-Beam Front Suspension	630254	
	- With Independant Front Suspension	630136		85330
1999 - 03	XL II Bus, XL II MTH Bus				
2004 - 06	- Drive and Tag Axle Shocks	630253	
		630127		85736
1999 - 03	- Drive and Tag Axle Shocks	650407		85736
		630252	
2004 - 06	- With I-Beam Front Suspension	630134		85329
1999 - 03	- With I-Beam Front Suspension	680422		85329
2004 - 06	- With Independant Front Suspension	630251	
1999 - 03	- With Independant Front Suspension	630163		85330
2007 - 09	XL II MTH Bus				
	- Drive and Tag Axle Shocks	630253	
2007 - 09	- Front Suspension	630136		85330
1989 - 2000	XL-45 Coach				
	- Drive and Tag Axle Shocks	630127		85736
1989 - 2000	- With I-Beam Front Suspension	650407		85736
		630134		85329
		680422		85329
	Models with O.E.M. Number	12L-5-89		85729
		12T-1-13		85303 or 89422	85303 or 89422
		19501288		85729
		19501289		85728
		680510		85330
	Additional O.E.M. Interchanges	01-0100-905		85303 or 89422	
		12B-5-1		85700	
		196347		85710	
		196533		85708	
		3166657		85700	
		52001		85708	
		63-0001		85713	
		63-0080		85713	
		63-0091		85736	
		630163		85330	

Gabriel Part Numbers that appear in BLUE are GasSLX, adjustable shocks. \ Los números de parte Gabriel imprimidos en AZUL son amortiguadores ajustables GasSLX. \ Les numéros de pièce Gabriel imprimés en BLEU sont des amortisseurs ajustables GasSLX.

★ Will be available in first quarter of 2011.



Year Año Année	Model Modelo Modèle	O.E.M. #	Mount 	Front Delantero Avant	Rear Trasero Arrière
----------------------	---------------------------	----------	-----------	-----------------------------	----------------------------

PREVOST

	Additional O.E.M. Interchanges	63-1013		85329
		680323		85700
		680492		85713
		680555		85330
		690060		85713
		74939852		85308 or 89422
		G1011822		85702
		G5008070		85700
		N22212		85700

RAMERIZ TRAILER

Identification of the trailer suspension is necessary to determine what section of the catalog to refer to. Some possible options can be Chalmers, Hendrickson, Neway, Ridewell, Reyco.						
---	--	--	--	--	--	--

RAYDAN MANUFACTURING

	Air Link Suspensions with O.E.M. Number	14QK-3100		85739
		446-511-211		85739
	AL460 Air Link Suspension	700115		85712
	AL520 Air Link Suspension	700115		85712

RED LION TRAILER

	Trailers with Neway Air Susp. RL196-14, -15	90044978		85059
	Trailers with Neway Air Suspensions with O.E.M. Number	90045019		85913

REINKE MANUFACTURING COMPANY, INC.

Identification of the trailer suspension is necessary to determine what section of the catalog to refer to. Some possible options can be Chalmers, Hendrickson, Neway, Ridewell, Reyco.						
---	--	--	--	--	--	--

REYCO SUSPENSION

Drive Axle

	101A, 101AR	18166-01		85704
	102	16725-01		83221
	102AR (Hvy Duty)	18286-01		89414
	102AR (Special)	17146-01		83209 or 89414
	102AR (Standard)	12887-01		85013 or 89414
		12887-02		85013 or 89414
	102AR for Western Star	19824-01		85006
	102AR-7	17794-01		83215
	102AR-LM	19623-01		83123 or 89405
	200 Series Air Suspension	20129-01		85713
	21AR - 25000 LB Capacity	12887-01		85013 or 89414
		12887-02		85013 or 89414

Gabriel Part Numbers that appear in BLUE are GasSLX, adjustable shocks. | Los números de parte Gabriel impresos en AZUL son amortiguadores ajustables GasSLX. | Les numéros de pièce Gabriel imprimés en BLEU sont des amortisseurs ajustables GasSLX.



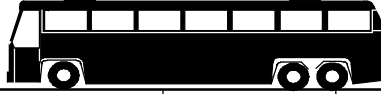





★ Will be available in first quarter of 2011.







Gabriel®

Year Año Année	Model Modelo Modèle	O.E.M. #	Mount 	Front Delantero Avant	Rear Trasero Arrière
----------------------	---------------------------	----------	--	-----------------------------	----------------------------



















REYCO SUSPENSION ... cont'd

	240AR Air-Ride Suspension - With O.E.M. Number	20125-01		85030 or 89440
		20126-01		89440
		20129-01		85713
	74AR - 30000 lb Capacity	12887-01		85013 or 89414
		12887-02		85013 or 89414
	79AR	12887-02		85013 or 89414
	79KB	16725-01		83221
	AirGlide 400 Air Suspension	20129-01		85713

Steer Axle

	1207	17403-01		85003 or 89411
	1209 (Alternate)	17408-01		85005 or 89430
	1209 1212	17358-01		85030 or 89440
		19495-01		85030 or 89440
	21B	14954-01		83217

Trailer

	19AR / RS1062 Models with O.E.M. Number	700098-03		85052
	20 AR/ RS 3162 Models with O.E.M. number	18163-01		83207 or 89407
	21B (Special)	18800-01		85000 or 89436
	25 ART Models with O.E.M. Number	24392-01		85051
	25 ARU Models with O.E.M. Number	23553-01		85938
	30 ART with O.E.M. Number	23524-01		85738
	30 ARUU - 14 and -15	23553-01		85938
	30 ARUU - 9, -12 and -17	23524-01		85738
	30 ARUUL - 12 and -17	23524-01		85738
	30 ARUUL - 9, -14 and -15	23553-01		85938
	81C	12885-03		85300 or 89419
	81LC	12885-01		85300 or 89419
	81S	12885-03		85300 or 89419
	86 AR / RS 1015, 1035, 3035 Slider Air Suspension	18165-01		85006
	87 for Great Dane	18163-01		83207 or 89407
		18164-01		83122 or 89406
	87-14 (Rear Mount)	18146-01		85313
	87-14, -17	16230-01		85702

Gabriel Part Numbers that appear in BLUE are GasSLX, adjustable shocks. \ Los números de parte Gabriel imprimidos en AZUL son amortiguadores ajustables GasSLX. \ Les numéros de pièce Gabriel imprimés en BLEU sont des amortisseurs ajustables GasSLX.

★ Will be available in first quarter of 2011.



Year Año Année	Model Modelo Modèle	O.E.M. #	Mount 	Front Delantero Avant	Rear Trasero Arrière
----------------------	---------------------------	----------	-----------	-----------------------------	----------------------------

REYCO SUSPENSION ... cont'd

	87-14, -17 Slider	12885-01		85300 or 89419
	87-6, 87-9	12885-01		85300 or 89419
	87M-12	18146-01		85313
	Models with O.E.M. Number	16824-01		85006
		17142-01		85001 or 89410
		20960-01		83204
		21497-01		85005 or 89430
		23614-01		85717
		665519		89414
		665813		85051
		665830		85045
		665833		85052
		671707		85052
		680551		85738
		680552		85938
		680700		85938
		700098-01		83203 or 89436
		702135-01		85045
		702136-01		85052
		702209-01		85014
		704672-01		85938

RIDEWELL CORPORATION
Bus and R.V. Air-Rides

	Mobile Home & RV with Air Suspension	AS563B		83203 or 89436
		S6009B		83203 or 89436
	RAS - 227 Series Steer Axle Air Suspension w/ O.E.M. Number	90-2610-SP1		★ 87017
	RAS - 227 Series Steer Axles Air Suspension w/ O.E.M. Number	1260008		★ 87017

Trailer Air-Rides

	FeatherRide Light Duty Air Suspension (8,000 lb Capacity)	1270007		85045
	RAR-210				
	- With Double Convolution Spring	AS789B		85014
		S5878B		83207 or 89407
	- With Shock Absorber Bracket 2-1/2" Above Frame Rail	85006
	- With Shock Absorber Bracket 2-7/8" Above Lower Frame Rail	83207 or 89407
	- With Shock Absorber Bracket 3" Above Lower Frame Rail	85005 or 89430
	- With Shock Absorber Bracket Even With Underside of Frame	AS546B		85006

Gabriel Part Numbers that appear in BLUE are GasSLX, adjustable shocks. | Los números de parte Gabriel imprimidos en AZUL son amortiguadores ajustables GasSLX. | Les numéros de pièce Gabriel imprimés en BLEU sont des amortisseurs ajustables GasSLX.



























★ Will be available in first quarter of 2011.







Gabriel®

Year Año Année	Model Modelo Modèle	O.E.M. #	Mount 	Front Delantero Avant	Rear Trasero Arrière
----------------------	---------------------------	----------	---	-----------------------------	----------------------------

RIDEWELL CORPORATION ... cont'd

	RAR-210 For Trailers with 25" Drop	1253069B000 AS30698 AS3069B	  	85005 or 89430 85005 or 89430 85005 or 89430
	RAR-210 Tag Axle	AS563B S6009B	 	83203 or 89436 83203 or 89436
	RAR-221 Tag Axle	AS563B AS789B S5878B S6009B	   	83203 or 89436 85014 83207 or 89407 83203 or 89436
	RAR-221-11, 12, 13-USW Trailer with Shock Absorber and Hanger	AS563B S6009B	 	83203 or 89436 83203 or 89436
	RAR-221AS-11-USW, RAR-221AS-11-1-USW Trailer	1253069B000 AS30698 AS3069B	  	85005 or 89430 85005 or 89430 85005 or 89430
	RAR-221AS-12-USW, RAR-221AS-12-1-USW Trailer	1250546B000 AS546B	 	85006 85006
	RAR-240, RAR-240W (Mono Pivot Trailers with HD Air Suspension) - With O.E.M. Number	1270563B000 1270563B003 1270789B000	  	85000 or 89436 85934 85014
	RAR-243 (Mono Pivot Trailers with HD Air Suspension)	1270563B003		85934
	RAR-260 Overslung Air Suspension (25,000 lb Capacity)	1270563B003		85934
	RAR-260 Underslung Air Suspension (25,000 lb and 30,000 lb Capacity)	1270563B003		85934
	RideLite Trailer Air Suspension	1270563B003		85934
	Models with O.E.M. Number	1275943B 57645 665526	  	85005 or 89430 85005 or 89430 85014

Truck Air- Rides

	Pusher w/Axle Lift	AS563B S6009B	 	83203 or 89436 83203 or 89436
	RAD-221R Drive Axle	S2607B S5477B	 	85702 85307
	RAD-241 Drive Axle	1265583B001 90F-2152	 































Gabriel Part Numbers that appear in BLUE are GasSLX, adjustable shocks. \ Los números de parte Gabriel imprimidos en AZUL son amortiguadores ajustables GasSLX. \ Les numéros de pièce Gabriel imprimés en BLEU sont des amortisseurs ajustables GasSLX.

★ Will be available in first quarter of 2011.



Gabriel®

Year Año Année	Model Modelo Modèle	O.E.M. #	Mount 	Front Delantero Avant	Rear Trasero Arrière
----------------------	---------------------------	----------	--	-----------------------------	----------------------------

RIDEWELL CORPORATION ... cont'd

	RCA-215 Series Air Suspension - (RCA-215 LM, RCA-215 MM)	1250789B000		85014
	RD-202B Tandem Drive Axle	S5478B		85307
	RD-202S-54-48-BS Tandem Drive Air Suspension	1252607B000		85702
	RD-202S-54-52T-SR Tandem Drive Air Suspension	1252607B000		85702
	RSS-236, RSS-236R Self Steering Tag/Pusher Lift Axle (For 13000 lb & 16000 lb Capacity)	1253069B000		85005 or 89430
		AS30698		85005 or 89430
		AS3069B		85005 or 89430
	RUA-220B-1-, 10, 10.5, 11, 11.5, 12, 12.5, 13 (Lift Tag Axle & Trailer Lift Suspension)	1250789B000		85014
		AS789B000		85014
	RUA-220B-1-, 7, 7.5, 8, 8.5, 9, 9.5, 10 (Lift Tag Axle & Trailer Lift Suspension)	1270563B000		85000 or 89436
	Models with O.E.M. Number	1250563B000		85000 or 89436
		1252607B000		85702
		1253069B000		85005 or 89430
		12651527B000		85712
		1267120B000		85734
		1267395B000		85302 or 89420
		1275813B000		85704
		665198		85005 or 89430
		665267		85029
		680101		85702
		AS1894B	
		AS575B		85005 or 89430
		S4025B		85734
		S5813B		85704
		S7120B		85304
		S7172B		83207 or 89407
		S7249B		85307
		S7365B		85305
	Additional O.E.M. Interchanges	1250005		85901
		1254025B000		85712

SAF HOLLAND
Trailer Air Suspension

	AR-120 Series Trailer Air Suspension - (AR-120, AR-120-L, AR-120-US, AR-120-US-F)	90044626		83126 or 89430
	- (AR-120-US-L, -1, -2, -3)	90044625		83125

Gabriel Part Numbers that appear in BLUE are GasSLX, adjustable shocks. Los números de parte Gabriel imprimidos en AZUL son amortiguadores ajustables GasSLX. Les numéros de pièce Gabriel imprimés en BLEU sont des amortisseurs ajustables GasSLX.



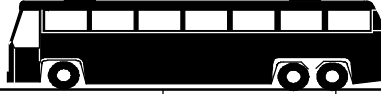

















★ Will be available in first quarter of 2011.



Gabriel®

Year Año Année	Model Modelo Modèle	O.E.M. #	Mount 	Front Delantero Avant	Rear Trasero Arrière
----------------------	---------------------------	----------	--	-----------------------------	----------------------------

SAF HOLLAND ... cont'd

	AR-125 Series Trailer Air Suspension - (AR-125, AR-125-L, AR-125-US, AR-125-US-F) - (AR-125-US-L, -1, -2, -3)	90044626 90044625	 	83126 or 89430 83125
	AR-165-US Series Trailer Air Suspension (AR165-US)	90044626		83126 or 89430
	AR-250 Series Trailer Air Suspension - (AR-250-12) - (AR-250-14, -15) - (AR-250-16, -17)	90045054 90044642 90044089	  	85051 83127 83124 or 89407
	AR-41 Series Trailer Air Suspension - (All)	90044162		83128
	AR-45 Series Trailer Air Suspension - (AR-45, AR-45-1)	90044162		83128
	AR-50 Series Trailer Air Suspension - (AR-50-US, AR-50-US-F, -1, -2)	90044162		83128
	AR-51 Series Trailer Air Suspension (AR51-US)	90044162		83128
	AR-70 Series Trailer Air Suspension - (AR-70-9, -14, AR-70A-9, 14)	90044626		83126 or 89430
	AR-75 Series Trailer Air Suspension - (AR-75-12) - (AR-75-6, -9, -1-12)	90044625 90044626	 	83125 83126 or 89430
	AR-80 Series Trailer Air Suspension - (AR-80-6.75) - (AR-80-9, -9FM) - (AR-80-9-WST)	90044046 90044868 90044626	  	83123 or 89405 85045 83126 or 89430
	AR-85-A Series Trailer Air Suspension - (AR-85-A)	90044625		83125
	AR-90 Series Trailer Air Suspension - (AR-90-14, -15, -16, -17)	90044089		83124 or 89407
	AR-90-1 Series Trailer Air Suspension - (AR-90-1-12, -14, -17) - (AR-90-1-15, -16)	90044162 90044448 90045054	  	83128 85051 85051

































Gabriel Part Numbers that appear in BLUE are GasSLX, adjustable shocks. \ Los números de parte Gabriel imprimidos en AZUL son amortiguadores ajustables GasSLX. \ Les numéros de pièce Gabriel imprimés en BLEU sont des amortisseurs ajustables GasSLX.

★ Will be available in first quarter of 2011.



Year Año Année	Model Modelo Modèle	O.E.M. #	Mount 	Front Delantero Avant	Rear Trasero Arrière
----------------------	---------------------------	----------	--	-----------------------------	----------------------------

SAF HOLLAND ... cont'd

	AR-92 Series Trailer Air Suspension				
	- (AR-92-12)	90044162		83128
		90044992		85000 or 89436
	- (AR-92-14)	90045040		83130
	- (AR-92-15)	90044448		85051
		90045054		85051
	- (AR-92-16)	90044794		83127
	- (AR-92-17)	90044642		83127
	- (AR-92-18)	90044089		83124 or 89407
		90044769		83207 or 89407
	AR-93 Series Trailer Air Suspension				
	- (AR-93-14)	90044448		85051
		90045054		85051
	- (AR-93-15)	90044794		83127
	- (AR-93-16)	90044642		83127
	- (AR-93-17)	90044089		83124 or 89407
		90044769		83207 or 89407
	AR-94 Series Trailer Air Suspension				
		90045028		85907
		90045048		85905
		90045049		85905
	AR-95 Series Trailer Air Suspension				
	- (AR-95-9, -12, -14, -17, All -HD Models, AR-95A-9, -12, -14, -17)	90044625		83125
	AR-955 Series Trailer Air Suspension (Liftaxle)				
	- (AR-955-9, -12, -14, -17)	90044625		83125
	- (AR-955-9HD, -12HD, -14HD, -17HD)	90044625		83125
	- (AR-955A-9, -12, -14, -17)	90044625		83125
	- (AR-955A-9HD, -12HD, -14HD, -17HD)	90044625		83125
	ARA-93 Series Trailer Air Suspension (ARA-93-14)	90045054		85051
	ARL20 Series Trailer Air Suspension (ARL20-D, ARL20-D-US)	90044162		83128
	ARS112 Series Trailer Air Suspension (ARS112-6)	90045096		85916
	ARU-92 Series Trailer Air Suspension				
	- (ARU-92-8, -9, -10, -12)	90044642		83127
	ARU-93 Series Trailer Air Suspension				
	- (ARU-93-6)	90045040		83130
	- (ARU-93-7, -8, -9, -10)	90044642		83127
	ARU-98 Series Trailer Air Suspension				
	- (ARU-98-17)	90045054		85051
	CB-2300 Series Trailer Air Suspension				
	- (CB-2300-14)	90044868		85045
	- (CB-2300-15)	90045381		83150
	- (CB-2300-16, CB-2300-17)	90045298		83128

Gabriel Part Numbers that appear in BLUE are GasSLX, adjustable shocks. | Los números de parte Gabriel imprimidos en AZUL son amortiguadores ajustables GasSLX. | Les numéros de pièce Gabriel imprimés en BLEU sont des amortisseurs ajustables GasSLX.



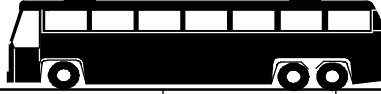



























★ Will be available in first quarter of 2011.



Gabriel®

Year Año Année	Model Modelo Modèle	O.E.M. #	Mount 	Front Delantero Avant	Rear Trasero Arrière
----------------------	---------------------------	----------	--	-----------------------------	----------------------------

SAF HOLLAND ... cont'd

	CB-400/4000 Series Trailer Air Suspension - (CB-400-15.5, CB-400-16.0) - (CB-400-16.5, CB-400-17.0) - (CB-400-18.0)	90045298 90044162 90045040	  	83128 83128 83130
	NL-200 Series Non Steer - Auxiliary Lift Air Suspension - (NL-200-1S, NL-200-2S)	90044162		83128
	NS-190 Series Trailer Air Suspension - (NS-190-16.0) - (NS-190-16.5, NS-190-17.0) - (NS-190-18.0)	90044162 90045040 90045054	  	83128 83130 85051
	NS-400 Series Trailer Air Suspension - (NS-400-16.0) - (NS-400-16.5) - (NS-400-17.0) - (NS-400-18.0)	90045298 90044162 90045299 90045040	   	83128 83128 85000 or 89436 83130
	NS-450 Series Trailer Air Suspension - (NS-450-16.0) - (NS-450-16.5) - (NS-450-17.0) - (NS-450-18.0)	90045298 90044162 90045299 90045040	   	83128 83128 85000 or 89436 83130
	RL-196 Series Trailer Air Suspension - (RL-196-12) - (RL-196-14, -15) - (RL-196-16, -17)	90044977 90044978 90044979	  	83115 85059 83113
	RL-196A Series Trailer Air Suspension - (RL-196A-12) - (RL-196A-14, -15) - (RL-196A-16, -17)	90044162 90045040 90044794	  	83128 83130 83127
	RL-228 Series Trailer Air Suspension - (RL-228-12-3) - (RL-228-14-3, -14-4, -15-3, -16-3) - (RL-228-17-3)	90044162 90044642 90044089	  	83128 83127 83124 or 89407
	RL-230 Series Trailer Air Suspension - (RL-230-12-3) - (RL-230-14-3, -15-3) - (RL-230-16-3, -17-3)	90045381 90044642 90044089	  	83150 83127 83124 or 89407
	RL-230 Series Trailer Air Suspension (Hanger Mounted Shock) - (RL-230-14-3, -15-4) - (RL-230-16-4) - (RL-230-17-4)	90045381 90045299 90045040	  	83150 85000 or 89436 83130

Gabriel Part Numbers that appear in BLUE are GasSLX, adjustable shocks. \ Los números de parte Gabriel imprimidos en AZUL son amortiguadores ajustables GasSLX. \ Les numéros de pièce Gabriel imprimés en BLEU sont des amortisseurs ajustables GasSLX.

★ Will be available in first quarter of 2011.



Year Año Année	Model Modelo Modèle	O.E.M. #	Mount 	Front Delantero Avant	Rear Trasero Arrière
----------------------	---------------------------	----------	-----------	-----------------------------	----------------------------

SAF HOLLAND ... cont'd

	RL-230 Series Trailer Air Suspension (Single Stud Air Spring) - (RL-230-14-3, -15-4, -16-4) - (RL-230-17-4)	90044642 90044089	 	83127 83124 or 89407
	RL-250 Series Trailer Air Suspension (Shock Below Frame) - (RL-250-14-3, -15-4) - (RL-250-16-4, -17-4)	90045040 90045299	 	83130 85000 or 89436
	RL-250 Series Trailer Air Suspension (Std Suspension) - (RL-250-12) - (RL-250-14.0, -15.0) - (RL-250-16.0, -17.0)	90045054 90044642 90044089	 	85051 83127 83124 or 89407
	RL-300 Series Trailer Air Suspension (Offset Stud Air Spring) - (RL-300-13) - (RL-300-14, -15, -16, -17)	90045054 90045338	 	85051 85060
	RL-300 Series Trailer Air Suspension (Std Suspension) - (RL-300-12, -13) - (RL-300-14, -15, -16, -17)	90045054 90045338	 	85051 85060
	RLSA Series Trailer Air Suspension (RLSA-4212, -4812)	90044977		83115
	RLSA Series Trailer Air Suspension (RLSA-4214, -4215, -4814, -4815)	90044978		85059
	RLSA Series Trailer Air Suspension (RLSA-4216, -4217, -4816, -4817)	90044979		83113
	RLSA228 Series Trailer Air Suspension (RLSA-228-4214, -4215, -4216, -4814, -4815, -4816)	90044642		83127
	RLSA228 Series Trailer Air Suspension (RLSA-228-4217, -4817)	90044089		83124 or 89407
	RLU-228 Series Trailer Air Suspension - (RLU-228-10-3) - (RLU-228-6-3) - (RLU-228-7-3) - (RLU-228-8-3, RLU-228-9-3)	90044089 90045040 90044642 90044626	 	83124 or 89407 83130 83127 83126 or 89430
	RLU-228 Series Trailer Air Suspension (Axle Mounted Shock Suspension) - (RLU-228-8-3) - (RLU-228-9-3, RLU-228-10-3, RLU-228-12-3)	90044162 90044642	 	83128 83127
	RLU-228 Series Trailer Air Suspension (Current Production - w/3" Axle Travel Up) - (RLU-228-10-3, RLU-228-12-3) - (RLU-228-6-3) - (RLU-228-7-3) - (RLU-228-8-3) - (RLU-228-9-3)	90044642 90045298 90044162 90045040 90045054	 	83127 83128 83128 83130 85051

Gabriel Part Numbers that appear in BLUE are GasSLX, adjustable shocks. | Los números de parte Gabriel imprimidos en AZUL son amortiguadores ajustables GasSLX. | Les numéros de pièce Gabriel imprimés en BLEU sont des amortisseurs ajustables GasSLX.



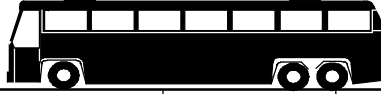

























★ Will be available in first quarter of 2011.











Gabriel®

Year Año Année	Model Modelo Modèle	O.E.M. #	Mount 	Front Delantero Avant	Rear Trasero Arrière
----------------------	---------------------------	----------	--	-----------------------------	----------------------------

SAF HOLLAND ... cont'd

	RLU-228 Series Trailer Air Suspension (Current Production - w/4" Axle Travel Up)				
	- (RLU-228-10-4)	90044642		83127
	- (RLU-228-8-4)	90044162		83128
	- (RLU-228-9-4, RLU-228-12-4)	90044626		83126 or 89430
		90045337		85911
	RLU-250 Series Trailer Air Suspension				
	- (RLU-250-12)	90044642		83127
	- (RLU-250-6.5)	90045381		83150
	- (RLU-250-9)	90044162		83128
	RLU-250 Series Trailer Air Suspension (Frame Mount Suspension)				
	- (RLU-250-12-FMT)	90045054		85051
	- (RLU-250-6.5-FMT)	90045381		83150
	- (RLU-250-9-FMT)	90044162		83128
	RLU-300 Series Trailer Air Suspension				
	- (RLU-300-6.5)	90045471		83150
	- (RLU-300-9)	90045337		85911
	Trailer Air Suspension (RL196-16,-17)	90044979		83113
	Models with O.E.M. Number				
		665454		85045
		671931		85916
		680234		85906
		680268		85323 or 89436
		90044980		85907
		90045000		85906
		90045001		85323 or 89436
		90045002		85906
		90045003		85323 or 89436
		90045019		85913
		90045080		85912
		90045083		85910
		90045188		85910
		90045207		89405
		90045433		85916

Truck, Bus & Motorhome Air Suspensions

	AD-123 Series Truck and Tractor Air Suspension (AD123-6,-8,-10,-8.75)				
	- Shock Mount approx. 2-1/2" above bottom of frame	90045132		85909
	- Shock Mount flush with bottom of frame	90045099		85906
	AD-130 Series Truck and Tractor Air Suspension (AD123-6,-8,-10,-8.75)	90045466		89406
	AD-130 Series Truck and Tractor Air Suspension W/ OEM Number	90045432		85321
	AD-150 Series Truck & Tractor Air Suspension	90045075		85911
	AD-200 Series Truck & Tractor Air Suspension (AD-200-7, -8, -9, -11)	90045138		85910
	AD-246 Series Truck & Tractor Air Suspension (AD246 -6, -8, -10, -8.75)	90045099		85906
		90045132		85909
	AD-252-10 Tandem Axle	90045132		85909



























Gabriel Part Numbers that appear in BLUE are GasSLX, adjustable shocks. \ Los números de parte Gabriel imprimidos en AZUL son amortiguadores ajustables GasSLX. \ Les numéros de pièce Gabriel imprimés en BLEU sont des amortisseurs ajustables GasSLX.

★ Will be available in first quarter of 2011.



Year Año Année	Model Modelo Modèle	O.E.M. #	Mount 	Front Delantero Avant	Rear Trasero Arrière
----------------------	---------------------------	----------	--	-----------------------------	----------------------------

SAF HOLLAND ... cont'd

	ARD-120 Series Truck & Tractor Air Suspension - (ARD-120-6)	90044025		83209 or 89414
	ARD-125 Series Truck & Tractor Air Suspension - (ARD-125-6 use on Ford, GM, International (Navistar), Mack, White, Western Star, Freightliner) - (ARD-125-8 use on Freightliner, White, Western Star) - (ARD-125-8 use on Mack)	90044025 90044011 90044016	  	83209 or 89414 85004 85300 or 89419
	ARD-165 Series Truck & Tractor Air Suspension - (ARD-165-A, ARD-165-B)	90044011		85004
	ARD-190 Series Truck & Tractor Air Suspension (ARD-190-B)	90044016		85300 or 89419
	ARD-234 Series Truck & Tractor Air Suspension (ARD-234-6)	90044046		83123 or 89405
	ARD-238 Series Truck & Tractor Air Suspension (ARD-238-6)	90044025		83209 or 89414
	ARD-244 Series Truck & Tractor Air Suspension - (ARD-244-6 use on Ford, GM, International (Navistar), Mack, White, Western Star, Freightliner) - (ARD-244-8 use on Freightliner, White, Western Star) - (ARD-244-8 use on Mack)	90044025 90044011 90044016	  	83209 or 89414 85004 85300 or 89419
	ARDAB-120 Series Truck & Tractor Air Suspension (ARDAB-120-5)	90044907		83635
	ARDAB-238-5 Series Truck & Tractor Air Suspension	90044907		83635
	ARDAB-240 Series Truck & Tractor Air Suspension (ARDAB-240-5)	90044907		83635
	ARDST-123 Series Truck & Tractor Air Suspension (ARDST-123-6, ARDSTM/L-123-6)	90044025		83209 or 89414
	ARDST-244 Series Truck & Tractor Air Suspension (ARDST-244-6)	90044025		83209 or 89414
	ARDST-246 Series Truck & Tractor Air Suspension (ARDST-246-6, ARDSTM/L-246-6)	90044025		83209 or 89414
	ARDST-250-6 Series Truck & Tractor Air Suspension	90044025		83209 or 89414
	ARDTB-125 Series Bus Air Suspension (ARDTB-125-6A)	90044448		85051
	ARDTB-125 Series Bus Air Suspension (ARDTB-125-6B)	90045031		★ 85968
	ARDTB-125-6A (Note: Front shock)	90045050		85914
	ARDTB-125-6A (Note: Rear shock)	90045053		85908
	ART-500 Series Truck & Tractor Tag Axle Air Suspension - (ART-500-B, ART-500-B-1) - (ART-500-US, ART-500-US-A)	90044162 90044008	 	83128 85000 or 89436
	ART-505 Series Truck & Tractor Tag Axle Air Suspension - (ART-505-B, -1, ART-505-C, -1)	90044162		83128
	ART-541 Series Truck & Tractor Tag Axle Air Suspension - (ART-541B)	90044162		83128
	ART-550 Series Truck & Tractor Tag Axle Air Suspension - (ART-550-US-1, -2, -3)	90044012		85006

Gabriel Part Numbers that appear in BLUE are GasSLX, adjustable shocks. | Los números de parte Gabriel impresos en AZUL son amortiguadores ajustables GasSLX. | Les numéros de pièce Gabriel imprimés en BLEU sont des amortisseurs ajustables GasSLX.

















★ Will be available in first quarter of 2011.























Gabriel®

Year Año Année	Model Modelo Modèle	O.E.M. #	Mount 	Front Delantero Avant	Rear Trasero Arrière
----------------------	---------------------------	----------	--	-----------------------------	----------------------------

SAF HOLLAND ... cont'd

	ART-551 Series Truck & Tractor Tag Axle Air Suspension				
	- (ART-551-B-1)	90044162		83128
	- (ART-551-B-2, -3, ART-551-US-1, -2, -3)	90044017		83204
	ART-555 Series Truck & Tractor Tag Axle Air Suspension				
	- (ART-555-B-1, ART-555-C-1)	90044162		83128
	- (ART-555-B-2, -3, ART555C-2, -3)	90044642		83127
	Models with O.E.M. Number	665002		85004
		665003		85300 or 89419
		671921		85916
		671922		89405
		671923		89440
		680645		85321
		90045084		★ 85968
		90045418		85916
		90045419		89405
		90045420		89440
		90045455		85909
			90045504	

Truck & Tractor Air Suspension (Tag Axle)

	Models with O.E.M. Number	57639		85000 or 89436
		57643		85013 or 89414
		6025		83122 or 89406
		6026		83204
		665197		85051
		665514		83127
		665969		89430
		90044001		85005 or 89430
		90044071		85000 or 89436
		90044081		85000 or 89436
		90044086		85000 or 89436
		90044089C		83124 or 89407
		90044095		83203 or 89436
		90044679		83122 or 89406
		90044680		83125
		90044681		83204
		90044682		83209 or 89414
		90044683		83122 or 89406
		90044684		83124 or 89407
		90044685		83128
90044686		85051		

Gabriel Part Numbers that appear in BLUE are GasSLX, adjustable shocks. \ Los números de parte Gabriel imprimidos en AZUL son amortiguadores ajustables GasSLX. \ Les numéros de pièce Gabriel imprimés en BLEU sont des amortisseurs ajustables GasSLX.

★ Will be available in first quarter of 2011.

**Gabriel®**

Year Año Année	Model Modelo Modèle	O.E.M. #	Mount 	Front Delantero Avant	Rear Trasero Arrière
----------------------	---------------------------	----------	-----------	-----------------------------	----------------------------

SAF HOLLAND ... cont'd

	Models with O.E.M. Number	90044687		83125
		90044688		83122 or 89406
		90044770		83207 or 89407
		90044833		85052
		90044834		85052
		90044878		83635
		90044915		83127
		90044968	
		90044981		85000 or 89436
		90044982		85000 or 89436
		90044991		85000 or 89436
		90045110		83137
		90045175		85916
		90045384		89430
		AR-1008		85006
		AR-1141		83204
		AR-1141-C		83204
		AR-1202		85300 or 89419
		AR-134-C		85005 or 89430
		AR-1404		85301
		AR-1425		85301
		AR-1434		83203 or 89436
		AR-1654		83209 or 89414
		AR-1822		85304
		AR-2451		83203 or 89436
		AR-2598		83123 or 89405
		AR-718-C		83203 or 89436
		AR-718-C-HD		85000 or 89436
		AR-781		83203 or 89436
		AR-958		83207 or 89407
		AR-995		85734

SICARD

	Models with O.E.M. Number	3166657		85700	85700
--	---------------------------	---------	--	-------	-------

SOUTHERN COACH

	Early Model Air Suspension		85304	85304
	Late Model Air Suspension		83217	83217
	U.S. Army Coaches		83217	83217

Gabriel Part Numbers that appear in BLUE are GasSLX, adjustable shocks. | Los números de parte Gabriel imprimidos en AZUL son amortiguadores ajustables GasSLX. | Les numéros de pièce Gabriel imprimés en BLEU sont des amortisseurs ajustables GasSLX.









★ Will be available in first quarter of 2011.



Gabriel®















Year Año Année	Model Modelo Modèle	O.E.M. #	Mount 	Front Delantero Avant	Rear Trasero Arrière
----------------------	---------------------------	----------	--	-----------------------------	----------------------------

SPARTAN MOTORS







1997 - 00	Alpine / Summit MotorHome Chassis with O.E.M. Number	0377-SS5		85029
		B46-1725		85029
	Fire Truck	0272-SS5		85712
1986	Fire Truck with Ridewell Front Suspension	AS 4025B		85734
1997 - 00	K2 / K3/ MountainMaster with O.E.M. Number	B46-2151		85007
1991 - 95	K2 / K3/ MountainMaster with Tuthill 102 AR Air Suspension	0346-SS5		85013 or 89414
		B46-1594		85013 or 89414
	Models with O.E.M. Number	59011		83214
	Additional O.E.M. Interchanges	78068		85304	

STERLING TRUCK

A - Line 9500 Series (SilverStar)

1998-	A9513, A9522, AT9513, AT9522 (113" & 122" BBC) Series with 8500 or 9000 lb Axle and 54" Taperleaf Spring	F6HT-18045-HB		85054 or 89438
		F6HT-18045-HC		85054 or 89438
1998-	A9513, A9522, AT9513, AT9522 (113" & 122" BBC) Series with 8500, 9000 or 10000 lb Axle and 54" Multileaf Spring	F6HT-18045-KA		83200
1998-	All Models with 10000 lb or 12000 lb Axle and 54" Taperleaf Spring	F6HT-18045-AC		85054 or 89438
1998-	All Models with 12000 lb or 13200 lb Axle and 54" Multileaf Spring	F6HT-18045-BC		85047 or 89435
1998-	All Models with 12000 lb, 13200 lb or 14600 lb Axle and 60" Taperleaf Spring	F6HT-18045-EB		85055 or 89439
		F6HT-18045-EC		85055 or 89439
1998-	All Models with 13200 lb or 14600 lb Axle and 54" Taperleaf Spring	F6HT-18045-GC		85030 or 89440
1998-	All Models with 14600 lb or 16000 lb Axle and 54" Multi-leaf Spring	F6HT-18045-CC		85055 or 89439
1998-	All Models with 23000 lb Axle and 52" Taperleaf Softride Rear Suspension	F6HT-18080-CA		85314 or 89425
1998-	All Models with FAS II Rear Air Suspension		85724 or 89443
1998-	All Models with Hendrickson 40LH Tandem Axle	57241-2		83109
1998-	All Models with Hendrickson HAS Rear Air Suspension	47902-28		85013 or 89414
		F6HT-18080-FC		85013 or 89414
1999 -	Models with FAS II Rear Air Suspension	16-15817-000		85724 or 89443

ACTERRA

2009 - 10	Models with 10000 to 12000 lb. Front Axle and 3" Taper-leaf Suspension	10-13592-000		85959
		SDA471700000440		85959
2003 -	Models with 10000 to 12000 lb. Front Axle and 4" Taper-leaf Suspension	10-12390-000		85920
	Models with 11000 to 12000 lb Front axle	6803230300		85006
	Models with 15000 lb Rear Suspension	6803260000		83120
- 2002	Models with 6000 to 9000 lb Front axle	6803230200		85043

Gabriel Part Numbers that appear in BLUE are GasSLX, adjustable shocks. \ Los números de parte Gabriel imprimidos en AZUL son amortiguadores ajustables GasSLX. \ Les numéros de pièce Gabriel imprimés en BLEU sont des amortisseurs ajustables GasSLX.

★ Will be available in first quarter of 2011.

**Gabriel®**

Year Año Année	Model Modelo Modèle	O.E.M. #	Mount 	Front Delantero Avant	Rear Trasero Arrière
----------------------	---------------------------	----------	-----------	-----------------------------	----------------------------

STERLING TRUCK ... cont'd

2003 -	Models with 6000 to 9000 lb. Front Axle	10-12388-000		85920
2009 - 10	Models with FAS II Rear Air Suspension	16-18708-000		85724 or 89443
		SDA471700002809		85724 or 89443
1999 - 08	Models with FAS II Rear Air Suspension	16-15817-000		85724 or 89443
		680611		85724 or 89443

Cargo Line

1998	SC-7000 or SC-8000 Series with 12000 or 13000 lb. Axles	F6HT-18045-LA		85376
1998	SC-7000 or SC-8000 Series with 16000 lb. Multileaf Spring	F6HT-18045-AA		85054 or 89438

L - Line 7500 Series - Short Haul Tractor

	Models with 10000 lb Front Axle	F6HT-18045-KA		83200
--	---------------------------------	---------------	--	-------	-------

L - Line 8500 Series - Conventional Cab

1998	All Models with 10000 lb or 12000 lb Axle and 54" Taperleaf Spring	F6HT-18045-AC		85054 or 89438
1998-	All Models with 12000 lb or 13200 lb Axle and 54" Multileaf Spring	F6HT-18045-BC		85047 or 89435
1998-	All Models with 12000 lb, 13200 lb or 14600 lb Axle and 60" Taperleaf Spring	F6HT-18045-EB		85055 or 89439
		F6HT-18045-EC		85055 or 89439
1998-	All Models with 13200 lb or 14600 lb Axle and 54" Taperleaf Spring	F6HT-18045-GC		85030 or 89440
1998-	All Models with 14600 lb or 16000 lb Axle and 54" Multi-leaf Spring	F6HT-18045-CC		85055 or 89439
1998-	All Models with 23000 lb Axle and 52" Taperleaf Softride Rear Suspension	F6HT-18080-CA		85314 or 89425
1998	All with Hendrickson HAS Rear Air Suspension	47902-28		85013 or 89414
		F6HT-18080-FC		85013 or 89414
1998	LT-8000 Series with 12000 or 13000 lb Axles	F6HT-18045-LA		85376
1998	LT-8000 Series with 16000 lb. Multileaf Spring	F6HT-18045-AA		85054 or 89438
1998	LT-8501 (101" BBC) Series with 8500 or 9000 lb Axle and 54" Multileaf Spring	F6HT-18045-JB		83200
		F6HT-18045-JC		83200
	LT-8501 (101" BBC) Series with 8500 or 9000 lb Axle and 54" Taperleaf Spring	F6HT-18045-HB		85054 or 89438
		F6HT-18045-HC		85054 or 89438
1999 -	Models with FAS II Rear Air Suspension	16-15817-000		85724 or 89443
- 1998	Models with FAS II Rear Air Suspension	85724 or 89443
1998	Models with Hendrickson 40LH Tandem Axle	57241-2		83109

L - Line 9500 Series - Conventional Cab

1998	All Models with 10000 lb or 12000 lb Axle and 54" Taperleaf Spring	F6HT-18045-AC		85054 or 89438
------	--	---------------	--	-------------------	-------

Gabriel Part Numbers that appear in BLUE are GasSLX, adjustable shocks. | Los números de parte Gabriel imprimidos en AZUL son amortiguadores ajustables GasSLX. | Les numéros de pièce Gabriel imprimés en BLEU sont des amortisseurs ajustables GasSLX.



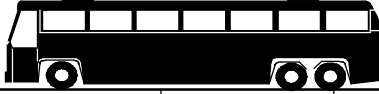











★ Will be available in first quarter of 2011.























Gabriel®

Year Año Année	Model Modelo Modèle	O.E.M. #	Mount 	Front Delantero Avant	Rear Trasero Arrière
----------------------	---------------------------	----------	---	-----------------------------	----------------------------

STERLING TRUCK ... cont'd

1998-	All Models with 12000 lb or 13200 lb Axle and 54" Multileaf Spring	F6HT-18045-BC		85047 or 89435
1998-	All Models with 12000 lb, 13200 lb or 14600 lb Axle and 60" Taperleaf Spring	F6HT-18045-EB		85055 or 89439
		F6HT-18045-EC		85055 or 89439
1998-	All Models with 13200 lb or 14600 lb Axle and 54" Taperleaf Spring	F6HT-18045-GC		85030 or 89440
1998-	All Models with 14600 lb or 16000 lb Axle and 54" Multi-leaf Spring	F6HT-18045-CC		85055 or 89439
1998-	All with 23000 lb Axle and 52" Taperleaf Softride Rear Suspension	F6HT-18080-CA		85314 or 89425
1998-	All with Hendrickson HAS Rear Air Suspension	47902-28		85013 or 89414
		F6HT-18080-FC		85013 or 89414
1998-	LT-9501, LT-9511, LT-9513 or LT-9513 (113" & 122" BBC) Series with 8500 or 9000 lb Axle and 54" Multileaf Spring	F6HT-18045-JB		83200
		F6HT-18045-JC		83200
1998-	LT-9501, LT-9511, LT-9513 or LT-9513 (113" & 122" BBC) Series with 8500 or 9000 lb Axle and 54" Taperleaf Spring	F6HT-18045-HB		85054 or 89438
		F6HT-18045-HC		85054 or 89438
1998-	Models with FAS II Rear Air Suspension		85724 or 89443
1998-	Models with Hendrickson 40LH Tandem Axle	57241-2		83109

	Models with FAS II Rear Air Suspension	XC45-18080-BA		85724 or 89443
	Models with Link Rear Air Suspension	1210-0528		85904
	Models with O.E.M. Number	4C4Z-18124-N		85957
		4C4Z-18125-DA		85926
		AT-560		G61150
		AX267A		83309 or 89446
		AX310		83215
		C4HZ-18124-E		83309 or 89446
		C4TZ-18124-AB		83308
		D8HZ-18124-A		85301
		E6HZ-18124-A		85301
		E6HZ-18124-D		85301
		E6HZ-18125-D		83215
		E7HZ-18124-A		85301
		E7XZ-18124-A		G60023
		E7XZ-18125-B		G60024
		E9HZ-18124-A		83309 or 89446
		F0HZ-18124-B		85006
F1HZ-18124-A		83309 or 89446		
F1HZ-18124-B		83308		
F1HZ-18124-D		85006 or 89401		

Gabriel Part Numbers that appear in BLUE are GasSLX, adjustable shocks. \ Los números de parte Gabriel imprimidos en AZUL son amortiguadores ajustables GasSLX. \ Les numéros de pièce Gabriel imprimés en BLEU sont des amortisseurs ajustables GasSLX.

★ Will be available in first quarter of 2011.



Gabriel®

Year Año Année	Model Modelo Modèle	O.E.M. #	Mount 	Front Delantero Avant	Rear Trasero Arrière
----------------------	---------------------------	----------	-----------	-----------------------------	----------------------------

STERLING TRUCK ... cont'd

Year	Model	O.E.M. #	Mount	Front	Rear
	Models with O.E.M. Number	F1HZ-18124-E		85006 or 89401
		F1HZ-18124-H		85040
		F1HZ-18124-J		83308
		F1HZ-18124-K		89402
		F2HZ-18124-A		85376
		F2HZ-18124-B		85301
		F5HZ-18124-A		83314
		F5HZ-18124-B		83107
		F5HZ-18124-C		85063
		F5HZ-18124-D		83125
		F5HZ-18125-A		85314 or 89425
		F5HZ-18125-B		85001 or 89410
		F6HT-18080-FC		85013 or 89414
		F6HT-18124-JC		83200
		F6HT-18124-KA		83200
		F6HZ-18124-A		85054 or 89438
		F6HZ-18124-B		83308
		F6HZ-18124-C		85055 or 89439
		F6HZ-18124-D		85055 or 89439
		F6HZ-18124-E		85055 or 89439
		F6HZ-18124-F		85055 or 89439
		F6HZ-18124-G		85054 or 89438
		F6HZ-18124-H		85054 or 89438
		F6HZ-18124-J		83200
		F6HZ-18125-B		83109
		F6HZ-18125-D		85013 or 89414
		F81A-18045-AGB		G61150

STOUGHTON TRAILERS INC.

Year	Model	O.E.M. #	Mount	Front	Rear
	Trailers with Hendrickson HT190T, HT190U, & HS190T Series Air Suspension	HTA20001		85000 or 89436
	Trailers with Hendrickson HT230T Series Air Suspension	HTA20002		85000 or 89436
	Trailers with Neway AR-90-1-12, -14, -17 Series Air Suspension	NW90044162		83128
	Trailers with Neway AR-90-1-15, -16 Series Air Suspension	NW90044448		85051
	Trailers with Neway RL-196-14, -15, Series Air Suspension	NW90044978		85059
	Trailers with Neway RL-196-16, -17, Series Air Suspension	NW90044979		83113
	Trailers with Reyco 86AR/RS1015 Air Ride Suspension	RT18165-01		85006
	Trailers with Reyco 86AR/RS1035 Anti-Dock Walk Air Suspension	RT18165-01		85006

Gabriel Part Numbers that appear in BLUE are GasSLX, adjustable shocks. | Los números de parte Gabriel imprimidos en AZUL son amortiguadores ajustables GasSLX. | Les numéros de pièce Gabriel imprimés en BLEU sont des amortisseurs ajustables GasSLX.































★ Will be available in first quarter of 2011.



Gabriel®

Year Año Année	Model Modelo Modèle	O.E.M. #	Mount 	Front Delantero Avant	Rear Trasero Arrière
----------------------	---------------------------	----------	--	-----------------------------	----------------------------

THOMAS SCHOOL BUS

	Model MVP	61310101		85736	85736
	Models with FAS II Rear Air Suspension	61310434		85724 or 89443
		61310478		85724 or 89443
	Models with Neway Tandem Air Suspension	61310232		85000 or 89436
	Models with Oshkosh Chassis & O.E.M. Number	P101977		85010
	ROC Front, SAF-T-Liner	61300285		83102
	School Bus	300-0614966		85307
		614974		85304
		680010		85304
		680054		85307
	Models with O.E.M. Number	128745		83102
		61300112		83613
		61300224		85918 or 89449
		61300240		85918 or 89449
		61310102		85308 or 89422
		61310103		85308 or 89422
		651442		83102
		659287		83102
		680-323-0300		85006
		680-326-0000		83120
		GBL654725		83120
		GBL665538		85006
	Additional O.E.M. Interchanges	6130-0114		89437
		6130029		85712
		61310104		85713
		63-0001		85713
		680088		85713
		728802		85736
		87002		85736
		A-4890		85712





TIMBREN INDUSTRIES

	Additional O.E.M. Interchanges	665804		85939
--	--------------------------------	--------	---	-------	-------

TRAIL KING INDUSTRIES

	Identification of the trailer suspension is necessary to determine what section of the catalog to refer to. Some possible options can be Chalmers, Hendrickson, Neway, Ridewell, Reyco.				
--	---	--	--	--	--

TRAILMOBILE CANADA CORP.

	Trailers with Granning Air Susp. T-350A	43-8-022		83225
	Trailers with Hendrickson Air Susp. HT230T (23,000 lb Capacity)	43-6-118		85000 or 89436
	Trailers with Hendrickson Air Susp. HT250U, HT250U-Y	A-2212		85029
	Trailers with Hendrickson Air Susp. T23-RL-17	43-8-011		83207 or 89407





































Gabriel Part Numbers that appear in BLUE are GasSLX, adjustable shocks. \ Los números de parte Gabriel imprimidos en AZUL son amortiguadores ajustables GasSLX. \ Les numéros de pièce Gabriel imprimés en BLEU sont des amortisseurs ajustables GasSLX.

★ Will be available in first quarter of 2011.





**Gabriel®**

Year Año Année	Model Modelo Modèle	O.E.M. #	Mount 	Front Delantero Avant	Rear Trasero Arrière
----------------------	---------------------------	----------	--	-----------------------------	----------------------------

TRAILMOBILE CANADA CORP. ... cont'd

	Trailers with Hendrickson Air Susp. T23-US-6 (Non-Liftable)	43-8-015		85006
	Trailers with Hendrickson Air Susp. T23-US-9 (Liftable & Non-Liftable)	43-8-014		85013 or 89414
	Trailers with Hendrickson Air Susp. T30-US-9, -12, -14, -17	43-8-013		85000 or 89436
	Trailers with Neway Air Susp. AR90-1-14, AR90-1-17	90044089		83124 or 89407
	Trailers with Neway Air Susp. AR90-14, -17,	90044089		83124 or 89407
	Trailers with Neway Air Susp. AR92-14	90044992		85000 or 89436
	Trailers with Neway Air Susp. AR92-17	90044642		83127
	Trailers with Neway Air Susp. AR93-14	90045054		85051
	Trailers with Neway Air Susp. AR93-17	90044089		83124 or 89407
	Trailers with Neway Air Susp. AR95-9-HD, -12-HD, -14-HD, 17-HD	90044625		83125
	Trailers with Neway Air Susp. RL196-12	90044977		83115
	Trailers with Neway Air Susp. RL196-14, -15	90044978		85059
	Trailers with Neway Air Susp. RL196-16, -17	90044979		83113
	Trailers with Reyco Air Susp. Model # 21AR (25,000 LB Capacity)	43-8-002		83209 or 89414
	Trailers with Reyco Air Susp. Model # 74AR (30,000 LB Capacity)	43-8-002		83209 or 89414
	Trailers with Reyco Air Susp. Model # 86AR	43-8-015		85006
	Additional O.E.M. Interchanges	43-4-235			85051
		43-4-236			85029
		43-4-237			85000 or 89436
		43-4-239			83207 or 89407
		43-4-241			85006
		43-4-277			85000 or 89436
		43-4-278			85059
		43-4-279			83204
		43-6-028			85000 or 89436
		43-6-118			85000 or 89436
		43-6-137			85006
		43-6-158			85013 or 89414
		43-6-164			83207 or 89407
		43-8-002			83209 or 89414
		43-8-011			83207 or 89407
		43-8-013			85000 or 89436
		43-8-014			85013 or 89414
	43-8-015			85006	
	43-8-022			83225	
	43-8-031			85029	

TRANSPORTATION MFG. CORP

	City Cruiser	12TA-01-13		85303 or 89422	85303 or 89422
	Drive Axle	12J-5-10		85733
		12J-5-2		85312
		12J-5-4		85312

Gabriel Part Numbers that appear in BLUE are GasSLX, adjustable shocks. \ Los números de parte Gabriel imprimidos en AZUL son amortiguadores ajustables GasSLX. \ Les numéros de pièce Gabriel imprimés en BLEU sont des amortisseurs ajustables GasSLX.





























★ Will be available in first quarter of 2011.



Gabriel®

Year Año Année	Model Modelo Modèle	O.E.M. #	Mount 	Front Delantero Avant	Rear Trasero Arrière
----------------------	---------------------------	----------	--	-----------------------------	----------------------------

TRANSPORTATION MFG. CORP ... cont'd





	G 4500 Coach - (45 ft Coach - Tag Axle) - (Front) - (Tag Axle)	12-05-6033 12-05-6000 12-05-6002	   85711	85339 85339
	Low Floor Buses w/ O.E.M. Number	12L-5-99		85339
	RTS Bus with "V" Drive Rear	G1101590		85713
	RTS Bus with Normal Front	22012079 4975515 695117 74410	   	85701 85701 85701 85701
	RTS Bus with Regular Rear	22045526 22052014 G1011822	  	85702 85702 85702
	RTS Bus with Solid Front Axle	22024673 22046485 680350 695273 695279	    	85710 85710 85710 85710 85710
	Tag Axle	12J-5-11 12J-5-3 12J-5-6 12J-5-9	    85700	85313 85313 85313
	Models with O.E.M. Number	12B-5-1 12G-5-1 22046485 680349	    85700 85710	85700 85702
	Additional O.E.M. Interchanges	12L-5-69 12L-5-70 680470	  	85700 85700 85713

TRINITY TRAILER MFG., INC.

	Identification of the trailer suspension is necessary to determine what section of the catalog to refer to. Some possible options can be Chalmers, Hendrickson, Neway, Ridewell, Reyco.				
--	---	--	--	--	--

TURNER- QUICK LIFT - see HENDRICKSON SUSPENSION

TWIN COACH

	Models with O.E.M. Number	90044089 90044089C 90044162 AR-718-C-HD AR-958	    	83124 or 89407 83124 or 89407 83128 85000 or 89436 83207 or 89407
--	---------------------------	--	---	---	---

UNITED MANUFACTURING

	Models with O.E.M. Number	K-96-41		85304
--	---------------------------	---------	---	-------	-------

Gabriel Part Numbers that appear in BLUE are GasSLX, adjustable shocks. \ Los números de parte Gabriel imprimidos en AZUL son amortiguadores ajustables GasSLX. \ Les numéros de pièce Gabriel imprimés en BLEU sont des amortisseurs ajustables GasSLX.

★ Will be available in first quarter of 2011.

**Gabriel®**

Year Año Année	Model Modelo Modèle	O.E.M. #	Mount 	Front Delantero Avant	Rear Trasero Arrière
----------------------	---------------------------	----------	-----------	-----------------------------	----------------------------

UNIVERSAL COACH

	Models with O.E.M. Number	12-05-1199 680777	 	85729 85729
--	---------------------------	----------------------	------	----------------	----------------

UTILITY TRAILER

Identification of the trailer suspension is necessary to determine what section of the catalog to refer to. Some possible options can be Chalmers, Hendrickson, Neway, Ridewell, Reyco.					
---	--	--	--	--	--

VAN HOOL

	Models with O.E.M. Number	6243-13790 6243-14040 665562 665563	 	85708 85708 85708 85708
--	---------------------------	--	--------------	----------------------------------	----------------------------------

VOLVO**FE Series**

	FE6 Series	6857668 6876828	 	83105 83105
	FE611, FE614	6876831	
	FE611, FE614 Front after CH419306	6794358		85040
	FE614 Tractor	6790756 6794358	 85040	83215
	FE615, FE715	6772218 6775412	 	85040 85040
	FE7 Series up to Chassis No. 20855	1505190		85722
	FE7 Series with over 6.5 Front Axle (Ton)	1590439		83104
	FE7 Series with Rear Air Suspension (Drive Axle)	1591501		85722
	FE715 with Rear Parabolic Spring	6790756		83215
	Models with Rear Air Suspension and O.E.M. Number	8056892		85023 or 89415

N Series

	N10 with 5.5 Ton Front Axle	1593843		83215
	N11 Series	1-0200-32-888-1 1591735 1593843	 	83104 83104 83215
	N12 Series	1-0200-32-888-1 1591735 1593843	 	83104 83104 83215
	N12 with over 6.5 Ton Front Axle	1590439		83104

VHD - Series

2008 - 09	Models with 12,000 to 14,600 lb Front Axles	20433426 SDA471700131258	 	85081 85081
------------------	---	-----------------------------	------	----------------	----------------

VN Series - 2200

May 99-	Models built after May 1999	20433425 8086651	 	85066 or 89448 85066 or 89448
----------------	-----------------------------	---------------------	------	----------------	--

Gabriel Part Numbers that appear in BLUE are GasSLX, adjustable shocks. \ Los números de parte Gabriel imprimidos en AZUL son amortiguadores ajustables GasSLX. \ Les numéros de pièce Gabriel imprimés en BLEU sont des amortisseurs ajustables GasSLX.



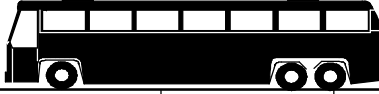





★ Will be available in first quarter of 2011.

















Gabriel®

Year Año Année	Model Modelo Modèle	O.E.M. #	Mount 	Front Delantero Avant	Rear Trasero Arrière
----------------------	---------------------------	----------	--	-----------------------------	----------------------------





VOLVO ... cont'd

Models with O.E.M. Number	20433424		85061 or 89450
	20513881		85061 or 89450
	20551628		85066 or 89448
	665607		85047 or 89435
	8077874-P01		85047 or 89435
	8078195		85061 or 89450
	8086053		85047 or 89435
	8169859		85047 or 89435

VNL Series

2006 - 10	64T-300, 64T-300U Models with 40,000 lb Rear Air Suspension	20551628		85066 or 89448
2006 - 10	64T-300, 64T-300U Models with Hendrickson Airtek	20485633		85933 or 89454
2006 - 10	64T-630, 42T-630 Models with 40,000 lb Rear Air Suspension	20551628		85066 or 89448
2006 - 10	64T-630, 42T-630 Models with Hendrickson Airtek	20485633		85933 or 89454
2006 - 10	64T-670 Models with 40,000 lb Rear Air Suspension	20551628		85066 or 89448
2006 - 10	64T-670 Models with Hendrickson Airtek	20485633		85933 or 89454
2008 - 10	64T-730, 64T-730U Models with 40,000 lb Rear Air Suspension	20551628		85066 or 89448
2008 - 10	64T-730, 64T-730U Models with Hendrickson Airtek	20485633		85933 or 89454
2006 - 10	64T-780 Models with 40,000 lb Rear Air Suspension	20551628		85066 or 89448
2006 - 10	64T-780 Models with Hendrickson Airtek	20485633		85933 or 89454
2006 - 09	64T-830 Models with Hendrickson 40,000 lb Pimaax EX and FireMaax EX Air Suspension	20782199		85072
		60657-007		85072
2006 - 10	All Models with 12,000 - 13,200 lb Front Axles	20433424		85061 or 89450
May 99-	Models with 38,000 lb Rear Air Suspension built after May 1999	20433425		85066 or 89448

Vocational Trucks

Models with T-Ride Rear Suspension	20433427		85065
	8060026		85065
	8073212		85065
	8075257		85065
WX, WXR, WG, AC Series with Hendrickson HN-402 Rear Suspension	57241-3		83112

Gabriel Part Numbers that appear in BLUE are GasSLX, adjustable shocks. \ Los números de parte Gabriel imprimidos en AZUL son amortiguadores ajustables GasSLX. \ Les numéros de pièce Gabriel imprimés en BLEU sont des amortisseurs ajustables GasSLX.

★ Will be available in first quarter of 2011.

**Gabriel®**

Year Año Année	Model Modelo Modèle	O.E.M. #	Mount 	Front Delantero Avant	Rear Trasero Arrière
----------------------	---------------------------	----------	-----------	-----------------------------	----------------------------

VOLVO ... cont'd

	WX, WXL, WXR, WG, AC Series				
	- With Hendrickson HAS-400 Rear Air Suspension	47902-24		83137
	- With Hendrickson HAS-460 Rear Air Suspension	47902-24		83137
	- With Hendrickson HN-462 Rear Suspension	57241-3		83112

VT Series

2006 - 10	64T-830 Models with 40,000 lb Rear Air Suspension	20551628		85066 or 89448
2006 - 09	64T-880 Models with Hendrickson 40,000 lb Pimaax EX and FireMaax EX Air Suspension	20782199		85072
		60657-007		85072
2006 - 10	All Models with 12,000 - 13,200 lb Front Axles	20433424		85061 or 89450

WCA & WIA Series

1995-	All with O.E.M. Number and after V.I.N. Number 723506	8169859		85047 or 89435
	Models with Front Dual Shocks	02-7005976		83400
		3082284		83400
1993-95	Models with O.E.M. Number and after V.I.N. Number 657841	8026658		85046 or 89434
-1992	Models with O.E.M. Number and up to V.I.N. Number 657250	8071524		85024 or 89416
	Models with O.E.M. Number	37301-0016		85026 or 89417
		37301-0021		85026 or 89417
		37301-3201		85027 or 89418
		37301-3202		85026 or 89417
		4975549		83216
		8065787		85026 or 89417

WG Series

1993-95	Models with O.E.M. Number	8026658		85046 or 89434
-1992	Models with O.E.M. Number	8065787		85026 or 89417
		8071524		85024 or 89416
	Models with O.E.M. Number	35901-3201		85024 or 89416
		37301-3201		85027 or 89418
		665623		85046 or 89434

WH Series

	WHS, WHR, WHL or WHE Models with Front Dual Shocks	02-7005976		83400
		3082284		83400
	WHS, WHR, WHL or WHE Models with Front Single Shocks	37301-0021		85026 or 89417

Gabriel Part Numbers that appear in BLUE are GasSLX, adjustable shocks. | Los números de parte Gabriel imprimidos en AZUL son amortiguadores ajustables GasSLX. | Les numéros de pièce Gabriel imprimés en BLEU sont des amortisseurs ajustables GasSLX.





★ Will be available in first quarter of 2011.































Gabriel®

Year Año Année	Model Modelo Modèle	O.E.M. #	Mount 	Front Delantero Avant	Rear Trasero Arrière
----------------------	---------------------------	----------	--	-----------------------------	----------------------------

VOLVO ... cont'd

1995-	WHS, WHR, WHL or WHE Models with O.E.M. Number	8169859		85047 or 89435
1993-95	WHS, WHR, WHL or WHE Models with O.E.M. Number	8026658		85046 or 89434
- 1992	WHS, WHR, WHL or WHE Models with O.E.M. Number	35901-3201		85024 or 89416
		8071524		85024 or 89416

Additional Series

	1500 Series				
	- Models with Rear Suspension	35901-0005		83219
	- Models with Velvet Ride Suspension	530596		85308 or 89422
	3000, 4000 & 9000 Series - Special Unit - Four Shock Absorbers Required Per Axle	5554959		83401
		676081		83401
		676082		83401
	3014, 3015, 3016, 3020 C.O.E. and 1500		83122 or 89406
	9000 Series		83122 or 89406
	Brigadier Series	22012065		85304
		22046483		85304
		22052336		85304
	Models with Hendrickson Airtek	20485633		85933 or 89454
		64838-001		85933 or 89454
		64838-002		85933 or 89454
1978-83	RC2		83122 or 89406
	Road Boss, Road Boss II, Road Commander II, Road Expeditor - (Four Shocks per Axle)	3946210		83103
	Road Boss, Road Boss II, Road Commander, Road Commander II, Road Expeditor II - (Four Shocks per Axle)	02-7005976		83400
		02-7005977		83400
		4975479		83400
		4975480		83400
	Models with O.E.M. Number	35901-0001		83209 or 89414
		35901-0008		85060
		37301-0008		83400
		665410		85027 or 89418
		665539		85026 or 89417
		665739		85047 or 89435
		70042		85302	89420
		8075287		85065
		8169859		85047 or 89435
		8174749		85906

Gabriel Part Numbers that appear in BLUE are GasSLX, adjustable shocks. \ Los números de parte Gabriel imprimidos en AZUL son amortiguadores ajustables GasSLX. \ Les numéros de pièce Gabriel imprimés en BLEU sont des amortisseurs ajustables GasSLX.

































★ Will be available in first quarter of 2011.















Gabriel®

Year Año Année	Model Modelo Modèle	O.E.M. #	Mount 	Front Delantero Avant	Rear Trasero Arrière
----------------------	---------------------------	----------	--	-----------------------------	----------------------------

VOLVO ... cont'd

Additional O.E.M. Interchanges	03-1106460		85005 or 89430
	20863239		85080
	35901-0003		85301
	35901-0004		83219
	35901-0011		83123 or 89405
	35901-0017		83314
	35901-0022		83635
	35901-3406		85305
	35901-3409		85304
	35901-3410		85307
	35901-3413		85006
	35901-3420		85303 or 89422
	37001-5		83401
	37301-0001		85013 or 89414
	37301-0018		85005 or 89430
	37301-0020	
	3953643		85040
	4940640		83216
	494-660		83219
	5322338		83214
	5513989		83216
	5531435		85307
	5531436		85307
	5531437		85307
	5534430		85303 or 89422
	5534447		85303 or 89422
	5549925		85304
	629398		85307
	629501		85307
	646220		85734
	66010-0016		85025
	668302		83216
	6771501		85040
6775411		85040	
8061167		

Additional Volvo PDC Numbers

Models with O.E.M. Number	20433424		85061 or 89450
	3092842		85061 or 89450
	3919958		85046 or 89434
	3949241		85061 or 89450
Additional O.E.M. Interchanges	1091347		83125	
	1091348		83122 or 89406	
	1091349		83204	
	1091350		83207 or 89407	
	1091351		83209 or 89414	
	1091353		83215	
	1091354		83216	
1091355		83217		

Gabriel Part Numbers that appear in BLUE are GasSLX, adjustable shocks. | Los números de parte Gabriel imprimidos en AZUL son amortiguadores ajustables GasSLX. | Les numéros de pièce Gabriel imprimés en BLEU sont des amortisseurs ajustables GasSLX.





















































★ Will be available in first quarter of 2011.



Gabriel®

Year Año Année	Model Modelo Modèle	O.E.M. #	Mount 	Front Delantero Avant	Rear Trasero Arrière
----------------------	---------------------------	----------	---	-----------------------------	----------------------------

VOLVO ... cont'd

Year Año Année	Model Modelo Modèle	O.E.M. #	Mount 	Front Delantero Avant	Rear Trasero Arrière
	Additional O.E.M. Interchanges	1091357			83219
		1091358			83456 or 89447
		1091359			83123 or 89405
		1091359			83123 or 89405
		1091360			83303
		1091361			83304
		1091362			83309 or 89446
		1091363			83221
		1091364			83312 or 89409
		1091365			83400
		1091366			83401
		1091367			85000 or 89436
		1091368			85003 or 89411
		1091370			85006
		1091371			85300 or 89419
		1091372			85301
		1091373			85302 or 89420
		1091374			85303 or 89422
		1091375			85304
		1091376			85305
		1091377			85307
		1091378			85308 or 89422
		1091379			85310 or 89423
		1091384			85735
		1093100			85027 or 89418
		1093174			83353
		1093176			85024 or 89416
		1093177			85025
		1093178			85026 or 89417
		1093180			85030 or 89440
		1716824			85304
		20551628			85066 or 89448
		3130140			85315
		3171696			85307
		3172948			85303 or 89422
		3915917			85319 or 89428
		3915947			85001 or 89410
		3915948			85311 or 89424
		3916352			85013 or 89414
		3919055			85007 or 89412
		3919056			83203 or 89436
		3919057			83225
		3919526			83314
		3919561			85314 or 89425
		3919585			83209 or 89414
		3919588			83216
		3919964			85304
		3945806			89417
		3945807			89416
		3945808			89407
		3945809			89410
		3945810			89420













Gabriel Part Numbers that appear in BLUE are GasSLX, adjustable shocks. \ Los números de parte Gabriel imprimidos en AZUL son amortiguadores ajustables GasSLX. \ Les numéros de pièce Gabriel imprimés en BLEU sont des amortisseurs ajustables GasSLX.

★ Will be available in first quarter of 2011.













**Gabriel®**

Year Año Année	Model Modelo Modèle	O.E.M. #	Mount 	Front Delantero Avant	Rear Trasero Arrière
----------------------	---------------------------	----------	--	-----------------------------	----------------------------



VOLVO ... cont'd

Additional O.E.M. Interchanges	3945811		89409
	3945812		89423
	3945813		89428
	3945814		89424
	3945815		89406
	3945816		89430
	3945817		89422
	3945818		89415
	3945819		89411
	3945820		89413
	3945821		89419
	3946219		83400
	5549899		83207 or 89407

VOLVO-AUTOCAR

A42B, A42F, A64B A64F - From Feb. 1971 - Thru Jan. 1971	03-1106460		85005 or 89430
	28R010		83216
ACM, ACL Models	35901-3201		85024 or 89416
	37301-3201		85027 or 89418
C65T, C70T, C70TS, C90, C75, C90T, DC74, DC75, DC102, DC104		83216
DC87T, DC9364 From Feb. 1971		83122 or 89406
Models with Air Suspension and O.E.M. Number	8026658		85046 or 89434
	8071524		85024 or 89416
Models with O.E.M. Number	1011839		83216
	28CFG-910		83216
	37301-3202		85026 or 89417
	660186		83216
	849246		83216

WABASH NATIONAL

If using the shock stamping number, identification of the trailer suspension is necessary to determine what section of the catalog to refer to. Some possible options can be Chalmers, Hendrickson, Neway, Ridewell, Reyco.				
1997-	RHP11, RHP55 and RideSentry Trailer Suspension	202447	 85919
		203447	 85919

Gabriel Part Numbers that appear in BLUE are GasSLX, adjustable shocks. \ Los números de parte Gabriel imprimidos en AZUL son amortiguadores ajustables GasSLX. \ Les numéros de pièce Gabriel imprimés en BLEU sont des amortisseurs ajustables GasSLX.



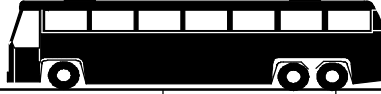

























★ Will be available in first quarter of 2011.



Gabriel®



Year Año Année	Model Modelo Modèle	O.E.M. #	Mount 	Front Delantero Avant	Rear Trasero Arrière
----------------------	---------------------------	----------	--	-----------------------------	----------------------------

WABASH NATIONAL ... cont'd



Year	Model	O.E.M. #	Mount	Front	Rear
	Trailers with Aurora part number	DANSR1VJ100		85078
		FLL83203-071		83203 or 89436
		FLL83207-071		83207 or 89407
		FLL85000-071		85000 or 89436
		FLL85030-071		85030 or 89440
		FRUUCE1295-1		85300 or 89419
		FRUUCE1295-901		85300 or 89419
		FRUUCE2983-1		85322
		FRUUCF8339-1		85321
		HENS-20001		85000 or 89436
		HENS-20002		85000 or 89436
		HENS-20126		85323 or 89436
		HENS-21292		85052
		HENS-23566		85000 or 89436
		HENS-24088		85000 or 89436
		NEW900-44-089		83124 or 89407
		NEW900-44-162		83128
		NEW900-44-625		83125
		NEW900-44-626		83126 or 89430
		NEW900-44-642		83127
		NEW900-44-794		83127
		NEW900-44-868		85045
		NEW900-44-978		85059
		NEW900-44-979		83113
		NEW900-45-040		83130
		NEW900-45-054		85051
		NEW900-45-298		83128
		NEW900-45-299		85000 or 89436

WATSON & CHALIN MFG. INC.

Heavy Duty Trailer Air Suspension

	TA-2590-14, 17 HD	10148		83204
	TA-3090-14, -17, -19	10148		83204
	TA-550-17	10148		83204

Light Weight Trailer Air Suspension

	TA-3175-9	17079		85300 or 89419
	TA-751-16	10148		83204





Gabriel Part Numbers that appear in BLUE are GasSLX, adjustable shocks. \ Los números de parte Gabriel imprimidos en AZUL son amortiguadores ajustables GasSLX. \ Les numéros de pièce Gabriel imprimés en BLEU sont des amortisseurs ajustables GasSLX.

★ Will be available in first quarter of 2011.



**Gabriel®**

Year Año Année	Model Modelo Modèle	O.E.M. #	Mount 	Front Delantero Avant	Rear Trasero Arrière
----------------------	---------------------------	----------	--	-----------------------------	----------------------------

WATSON & CHALIN MFG. INC. ... cont'd**LWSL- 1100- SR Self Steer Axle Suspension**

	AL-1100-SR	10148		83204
	HL-1100-20	10148		83204
	HL-1100-20 FL	10147		83203 or 89436
	SL-1100-LR	12128		85005 or 89430





Trailer Air Suspension

	TA-2590-12, 14, 15, & 17,	12128		85005 or 89430
	TA-2590-12-1	10147		83203 or 89436













WCAL- 2200 Series Pusher or Tag Axle Assembly

	AL-2200	10148		83204
--	---------	-------	---	-------	-------

WCTA Series Dump Trailer Air Suspension

	TA-1600-21	11604		83125
	TA-1900-15	10147		83203 or 89436
	TA-1900-16, -17	10148		83204
	TA-1900-18, -19	12128		85005 or 89430
	TA-5000-DB-19, -F-19	12128		85005 or 89430
	TA-5000-DB-24, -DB-30, -F-24, -F-30,	11724		83123 or 89405
	TA-525, -DB	10147		83203 or 89436

WCTA Series Trailer Air Suspension

	TA-2075-6	10148		83204
	TA-2075-9	12128		85005 or 89430
	TA-250-12	10148		83204
	TA-250-6, 7.5, 9,	10147		83203 or 89436
	TA-251-12, -12FS,	10148		83204
	TA-251-6.5, -6.5FS,	10147		83203 or 89436
	TA-251-7.5, -7.5FS	10147		83203 or 89436
	TA-251-8FS	10147		83203 or 89436
	TA-251-9.0, -9.0FS, -10,	10147		83203 or 89436
	TA-255-9	10147		83203 or 89436
	TA-280-6.5, 7.5, -9.0,	11604		83125
	TA-300-9	10147		83203 or 89436
	TA-380-9	12128		85005 or 89430

Gabriel Part Numbers that appear in BLUE are GasSLX, adjustable shocks. \ Los números de parte Gabriel imprimidos en AZUL son amortiguadores ajustables GasSLX. \ Les numéros de pièce Gabriel imprimés en BLEU sont des amortisseurs ajustables GasSLX.

★ Will be available in first quarter of 2011.





Gabriel®



Year Año Année	Model Modelo Modèle	O.E.M. #	Mount 	Front Delantero Avant	Rear Trasero Arrière
----------------------	---------------------------	----------	---	-----------------------------	----------------------------

WATSON & CHALIN MFG. INC. ... cont'd

WCTA- 1200 Series Trailer Air Suspension





















	TA-1000	10634		G60015
	TA-1200-5	10147		83203 or 89436

WCTL- 2200 Series Trailer Air Lift

	TL-1600-21	11604		83125
Oct 89 -	TL-2590-12,14,15, & 17	12128		85005 or 89430

WCWB Series Trailer Air Suspension

	WB-2500-6	10148		83204
	WB-2500-7.5, -9,	12128		85005 or 89430
	WB-251-6.5, 7.5, 9	10147		83203 or 89436
	WB-280-9	11604		83125
	Models with O.E.M. Number	17300 665769	 	85052 85052
	Additional O.E.M. Interchanges	3946219 665727	 	83400 85005 or 89430	

	Models with O.E.M. Number	10147HD 665862	 	85000 or 89436 85000 or 89436
	Additional O.E.M. Interchanges	11418 17069 17186 17186-01 17218 17297 17306 17382 17430 17474 19036 665724 665728 665770 680547 680584 680714 727603 727604	                  	646155 632147 85323 or 89436 85323 or 89436 85029 85938 85938 85014 85321 85009 85934 85000 or 89436 85060 85938 85323 or 89436 85938 85934 83203 or 89436 83204	

Gabriel Part Numbers that appear in BLUE are GasSLX, adjustable shocks. \ Los números de parte Gabriel imprimidos en AZUL son amortiguadores ajustables GasSLX. \ Les numéros de pièce Gabriel imprimés en BLEU sont des amortisseurs ajustables GasSLX.

★ Will be available in first quarter of 2011.



















**Gabriel®**

Year Año Année	Model Modelo Modèle	O.E.M. #	Mount 	Front Delantero Avant	Rear Trasero Arrière
----------------------	---------------------------	----------	--	-----------------------------	----------------------------

WESTERN STAR**3800 Series - Heritage Class**

	3842S, 3864S	37390-4401		85053 or 89442
		37390-4402		85053 or 89442
		37390-4403		85053 or 89442
	With Hendrickson Rear Suspension	47902-13		83122 or 89406
		47902-24		83137
		47902-8		83122 or 89406
	With Neway Rear Suspension	90044025		83209 or 89414
		90044907		83635

4800 & 4900 Series - Constellation Class

	4842FX, 4864FX, 4964EX, 4964EX, 4942SX or 4964SX Constellation Class	37301-3401		85053 or 89442
		37301-3404		85053 or 89442
		37301-3409		85053 or 89442
		37301-3412		85053 or 89442
		37390-4401		85053 or 89442
		37390-4402		85053 or 89442
		37390-4403		85053 or 89442
2009 - 10	Models with 12000 lb Taperleaf Front Suspension	10-13809-000		85958
		SDA471700003920		85958
2008 - 2010	Models with Freightliner TufTrac Rear Air Suspension	16-15770-000		85956
		SDA481700125969		85956
	With Hendrickson HAS-40LH Rear Suspension	57241-1		83111
	With Hendrickson Rear Suspension	47902-13		83122 or 89406
		47902-24		83137
		47902-8		83122 or 89406
	With Neway Rear Suspension	90044025		83209 or 89414
		90044907		83635
		90045099		85906

Gabriel Part Numbers that appear in BLUE are GasSLX, adjustable shocks. | Los números de parte Gabriel imprimidos en AZUL son amortiguadores ajustables GasSLX. | Les numéros de pièce Gabriel imprimés en BLEU sont des amortisseurs ajustables GasSLX.

★ Will be available in first quarter of 2011.





















Gabriel®















Year Año Année	Model Modelo Modèle	O.E.M. #	Mount 	Front Delantero Avant	Rear Trasero Arrière
----------------------	---------------------------	----------	---	-----------------------------	----------------------------

WESTERN STAR ... cont'd

4800 & 4900 Series - Heritage Class

	4842F, 4864F, 4843S, 4864S, 4942F, 4964F, 4942S or 4964S Heritage Class	37301-3401		85053 or 89442
		37301-3404		85053 or 89442
		37301-3409		85053 or 89442
		37301-3412		85053 or 89442
		37390-4401		85053 or 89442
		37390-4402		85053 or 89442
		37390-4403		85053 or 89442
2009 - 10	Models with 12000 lb Taperleaf Front Suspension	10-13809-000 SDA471700003920	 	85958 85958
2008 - 2010	Models with Freightliner TufTrac Rear Air Suspension	16-15770-000 SDA481700125969	 	85956 85956
	With Hendrickson HAS-40LH Rear Suspension	57241-1		83111
	With Hendrickson Rear Suspension	47902-13 47902-24 47902-8	  	83122 or 89406 83137 83122 or 89406
	With Neway Rear Suspension	90044025 90044907 90045099	  	83209 or 89414 83635 85906

5800 & 5900 Series - Constellation Class

	5842SS, 5864SS, 5942SS or 5964SS Constellation Class	37301-3401		85053 or 89442
		37301-3404		85053 or 89442
		37301-3409		85053 or 89442
		37301-3412		85053 or 89442
		37390-4401		85053 or 89442
		37390-4402		85053 or 89442
		37390-4403		85053 or 89442
2009 - 10	Models with 12000 lb Taperleaf Front Suspension	10-13809-000 SDA471700003920	 	85958 85958
2008 - 2010	Models with Freightliner TufTrac Rear Air Suspension	16-15770-000 SDA481700125969	 	85956 85956
	With Hendrickson Rear Suspension	47902-13 47902-24 47902-8	  	83122 or 89406 83137 83122 or 89406

Gabriel Part Numbers that appear in BLUE are GasSLX, adjustable shocks. \ Los números de parte Gabriel imprimidos en AZUL son amortiguadores ajustables GasSLX. \ Les numéros de pièce Gabriel imprimés en BLEU sont des amortisseurs ajustables GasSLX.

★ Will be available in first quarter of 2011.





































Gabriel®

Year Año Année	Model Modelo Modèle	O.E.M. #	Mount 	Front Delantero Avant	Rear Trasero Arrière
----------------------	---------------------------	----------	--	-----------------------------	----------------------------

WESTERN STAR ... cont'd

	With Neway Rear Suspension	90044025		83209 or 89414
		90044907		83635
		90045099		85906

5900 & 6900 Series - Heritage Class

	5942S, 5964S, 6964F or 6964S Heritage Class	37301-3401		85053 or 89442
		37301-3404		85053 or 89442
		37301-3409		85053 or 89442
		37301-3412		85053 or 89442
		37390-4401		85053 or 89442
		37390-4402		85053 or 89442
		37390-4403		85053 or 89442
	All with 4 shock Front System		83401
2009 - 10	Models with 12000 lb Taperleaf Front Suspension	10-13809-000		85958
		SDA471700003920		85958
2008 - 2010	Models with Freightliner TufTrac Rear Air Suspension	16-15770-000		85956
		SDA481700125969		85956
	Models with Hendrickson Airtek Suspension	58913-003		85932 or 89453
	With Hendrickson HAS-40LH Rear Suspension	57241-1		83111
	With Hendrickson Rear Suspension	47902-13		83122 or 89406
		47902-24		83137
		47902-8		83122 or 89406
	With Neway Rear Suspension	90044025		83209 or 89414
		90044907		83635
		90045099		85906
	Models with O.E.M. Number	02-7005976		83400
		02-7005977		83400
		04-9041375		85315
		28R010		83216
		35066-4413		83122 or 89406
		35901-0001		83209 or 89414
		35901-4403		85060
		37301-3405		85053 or 89442
		665682		85053 or 89442
		CP-5222		85315
	Additional O.E.M. Interchanges	1011839		83216
		35901-3406		85305
		35901-3409		85304
		35901-3410		85307

Gabriel Part Numbers that appear in BLUE are GasSLX, adjustable shocks. | Los números de parte Gabriel imprimidos en AZUL son amortiguadores ajustables GasSLX. | Les numéros de pièce Gabriel imprimés en BLEU sont des amortisseurs ajustables GasSLX.

★ Will be available in first quarter of 2011.

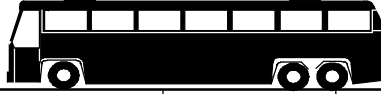









Gabriel®

Year Año Année	Model Modelo Modèle	O.E.M. #	Mount 	Front Delantero Avant	Rear Trasero Arrière
----------------------	---------------------------	----------	--	-----------------------------	----------------------------







WESTERN STAR ... cont'd

	Additional O.E.M. Interchanges	35901-3413		85006
		35901-3420		85303 or 89422
		615016		83401
		676081		83401
		676082		83401

WESTERN UNIT "STABILAIR" SUSPENSION

	Model 893T Trailer Suspension		85307
	Model TDA202, 203, 206, 240, 241, 243 Truck Drive Axle Suspension		85735
	Model TDA204, 205, 242 - Truck Drive Axle Suspension		85307
	Models with O.E.M. Number	101030		85307
		101364		85305
		4939967		85308 or 89422
		80370		85304
		80600		85300 or 89419

WORKHORSE

	Models with RSAS Rear Suspension	7805-X-1012		85919
	Step Van Models with O.E.M. Number	W0007363		83144
		W0007365		G61866
	Models with O.E.M. Number	659222		83144
		659223		G61866
		680672		85919

Gabriel Part Numbers that appear in BLUE are GasSLX, adjustable shocks. \ Los números de parte Gabriel imprimidos en AZUL son amortiguadores ajustables GasSLX. \ Les numéros de pièce Gabriel imprimés en BLEU sont des amortisseurs ajustables GasSLX.

★ Will be available in first quarter of 2011.

NUMERICAL LISTING

LISTA NUMÉRICA

LISTE NUMÉRIQUE

GABRIEL # APPLICATION MTG. ACC
PKG. NO.

Shocks for Special Applications

630811	140526(1)
CHALLENGE MC NEILUS TRUCK & MAN. COMPANY REX	
632147	Not Req'd.
CHALLENGE MC NEILUS TRUCK & MAN. COMPANY WATSON & CHALIN MFG. INC.	
646155	Not Req'd.
GRANNING SUSPENSION HENDRICKSON SUSPENSION LINK/HIGH-STEER MC NEILUS TRUCK & MAN. COMPANY NEWAY SUSPENSION SYSTEMS PIERCE MANUFACTURING INC. RIDEWELL CORP. SUSPENSIONS INC. WATSON & CHALIN MFG. INC.	
646177 N	Not Req'd.
CHALLENGE LINK/HIGH-STEER NEWAY SUSPENSION SYSTEMS OSHKOSH MOTORS SPRING VALLEY	
665472	Not Req'd
INGERSALL MACHINE	
665937	Not Req'd
LINK/HIGH-STEER REYCO/GRANNING RIDEWELL CORP.	

Gas Light Truck

G60002	141138
FORD	
G60003	140885
FORD INTERNATIONAL (NAVISTAR) JEEP MERCURY MITSUBISHI-FUSO NISSAN TOYOTA	
G60007	Not Req'd.
FORD	
G60008	Not Req'd.
CHEVROLET GMC	
G60010	140357
CHEVROLET GMC	
G60011	140126
FORD INTERNATIONAL	
G60012	Not Req'd.
DODGE PLYMOUTH	
G60014	140702
CHALMERS SUSPENSION CHEVROLET GMC	

GABRIEL # APPLICATION MTG. ACC
PKG. NO.

G60015	Not Req'd.
CHEVROLET GMC WATSON & CHALIN MFG. INC.	
G60017	140126
DODGE PLYMOUTH	
G60021	Not Req'd.
CHEVROLET FORD GMC INTERNATIONAL (NAVISTAR)	
G60023	140780
FORD STERLING TRUCK	
G60024	140126
FORD STERLING TRUCK	
G60026	140780
FORD	
G60028	Not Req'd.
DODGE DODGE TRUCK FREIGHTLINER MOR-RYDE SUSPENSION OSHKOSH MOTORS PLYMOUTH	
G60029	Not Req'd.
DODGE PLYMOUTH	
G60031	140884
CHEVROLET FORD INTERNATIONAL JEEP	
G60033	141047
FORD	
G60035	Not Req'd.
FORD	
G60038	140780
FORD	
G60039	Not Req'd.
CHEVROLET DODGE GMC PLYMOUTH	
G60041	140780
FORD	
G60042	141137
FORD JEEP	
G60043	140126
DODGE PLYMOUTH	
G60044	Not Req'd.
CHEVROLET GMC	
G60045	Not Req'd.
CHEVROLET GMC	
G60046	141138
FORD MITSUBISHI-FUSO	
G60048	Not Req'd.
FORD	

GABRIEL # APPLICATION MTG. ACC
PKG. NO.

G60049	140455
CHEVROLET GMC ISUZU	
G60050	Not Req'd.
CHEVROLET GMC ISUZU OLDSMOBILE	
G60051	Not Req'd.
CHEVROLET GMC ISUZU OLDSMOBILE	
G60052	141353
JEEP	
G60053	Not Req'd.
JEEP	
G60062	Not Req'd.
CHRYSLER DODGE PLYMOUTH	
G60063	Not Req'd.
FORD	
G60064	Not Req'd.
CHEVROLET GMC	
G60065	140357
CHEVROLET GMC	
G60066	Not Req'd.
FORD	
G60067	Not Req'd.
HINO JEEP TOYOTA	
G60068	Not Req'd.
FORD JEEP	
G60069	Not Req'd.
JEEP	
G60070	141041
TOYOTA	
G60071	140780
FORD	
G60072	141047
FORD	
G60073	140780
FORD	
G60074	141356
DODGE MITSUBISHI	
G60075	Not Req'd.
DODGE HINO MITSUBISHI	
G60076	140780 & 142615
CHEVROLET GMC	
G60077	Not Req'd.
CHEVROLET GMC VOLKSWAGEN	

★ Will be available in first quarter of 2011.

NUMERICAL LISTING

LISTA NUMÉRICA

LISTE NUMÉRIQUE

GABRIEL #	APPLICATION	MTG. ACC PKG. NO.
G60078	FORD	140126
G60080	FORD	Not Req'd.
G60081	FORD	Not Req'd.
G60083	DODGE	Not Req'd.
G60084	FORD	Not Req'd.
G60086	TOYOTA	140524
G60087	TOYOTA	140524
G60088	LAND ROVER	141439
G60091	INTERNATIONAL (NAVISTAR) NISSAN TOYOTA	141349 & 140169
G60096	TOYOTA	Not Req'd.
G60097	CHEVROLET GMC	Not Req'd.
G60098	CHEVROLET GMC	141277
G60099	FORD JEEP	Not Req'd.
G60100	NISSAN	140524
G60101	CHEVROLET DODGE FORD ISUZU JEEP MITSUBISHI NISSAN TOYOTA	141137
G60103	TOYOTA	140149(1)
G60104	ISUZU MAZDA	141350
G60105	TOYOTA	141349
G60107 S	G60164 HINO NISSAN	Not Req'd.
G60110	DODGE	Not Req'd.
G60111	CHEVROLET DODGE FREIGHTLINER GMC	Not Req'd.
G60112	CHEVROLET GMC	Not Req'd.

GABRIEL #	APPLICATION	MTG. ACC PKG. NO.
G60113	CHEVROLET GMC	140702
G60114	FORD	140780
G60119	DODGE DODGE TRUCK	140169
G60120	FORD	Not Req'd.
G60124	LAND ROVER	141448
G60128	TOYOTA	140149(1)
G60129	FORD JEEP	141353
G60143	FORD MAZDA	Not Req'd.
G60144	FORD MAZDA	Not Req'd.
G60152	DODGE MITSUBISHI	Not Req'd.
G60153	TOYOTA	141350
G60154	TOYOTA	140921
G60158	FORD	140780
G60160	MAZDA	Not Req'd.
G60161	FORD MAZDA	140719
G60162	FORD MAZDA	140780
G60163	CADILLAC CHEVROLET GMC	Not Req'd.
G60164	CHEVROLET TRUCK GMC TRUCK HINO HONDA INTERNATIONAL (NAVISTAR) ISUZU MITSUBISHI-FUSO NISSAN TOYOTA	142389
G60165	DAIHATSU HONDA ISUZU	140524
G60169	TOYOTA	Not Req'd.
G60171	FORD MAZDA	140780

GABRIEL #	APPLICATION	MTG. ACC PKG. NO.
G60176	LAND ROVER LEXUS TOYOTA	142657
G60177	CHEVROLET TRUCK GMC TRUCK ISUZU LEXUS TOYOTA	140169 & 142656
G60179	FORD	Not Req'd.
G60180	TOYOTA	141405
G60181	FORD	140780
G60182	FORD	142617
G60183	FORD	142617
G60184	FORD	140780
G60185	CHEVROLET GMC	140702
G60186	JEEP	Not Req'd.
G60194	MAZDA	140524
G60196	CADILLAC CHEVROLET GMC	Not Req'd.
G60197	MAZDA	Not Req'd.
G60199	MAZDA	Not Req'd.
G60204	TOYOTA	Not Req'd.
G60205	DODGE	143000
G60206	CHEVROLET DODGE GMC	Not Req'd.
G60214	CHEVROLET GMC	Not Req'd.
G60216	DODGE	143000
G60217	DODGE	142731
G60218	CHEVROLET DODGE GMC	Not Req'd.
G60219	FORD	Not Req'd.
G60221	FORD MAZDA MERCURY	Not Req'd.

★ Will be available in first quarter of 2011.

NUMERICAL LISTING

LISTA NUMÉRICA

LISTE NUMÉRIQUE

GABRIEL #	APPLICATION	MTG. ACC PKG. NO.	GABRIEL #	APPLICATION	MTG. ACC PKG. NO.	GABRIEL #	APPLICATION	MTG. ACC PKG. NO.
G60222		140719	G60308		Not Req'd.	G61144		141665
FORD MERCURY			CHEVROLET DODGE MAZDA MITSUBISHI NISSAN PLYMOUTH TOYOTA			CHEVROLET GMC		
G60226		Not Req'd.	G60309		Not Req'd.	G61149		Not Req'd.
JEEP			CHEVROLET GMC			FORD		
G60232		Not Req'd.	G60310		141368	G61150		Not Req'd.
TOYOTA			CHEVROLET ISUZU NISSAN			FORD STERLING TRUCK		
G60233		Not Req'd.	G60312		Not Req'd.	G61151		Not Req'd.
CHRYSLER DODGE PLYMOUTH			CHEVROLET OLDSMOBILE PONTIAC			FORD		
G60235		Not Req'd.	G60313		Not Req'd.	G61152		Not Req'd.
FORD			DODGE			FORD		
G60237		141448	G60329		Not Req'd.	G61153		Not Req'd.
LAND ROVER			ISUZU			CHEVROLET GMC		
G60250		141354	G60330		140780	G61154		Not Req'd.
ACURA ISUZU			FORD			NISSAN		
G60251		140169	G60338		140673	G61156		Not Req'd.
ACURA ISUZU			TOYOTA			TOYOTA		
G60253		Not Req'd.	G60353		Not Req'd.	G61158		Not Req'd.
HONDA ISUZU			SUZUKI			CHEVROLET GMC HUMMER		
G60255		141137	G60354		140455	G61159		Not Req'd.
INFINITI NISSAN			DODGE MITSUBISHI PLYMOUTH			CHEVROLET GMC		
G60257		142731	G61112		141665	G61169	N	142976
FORD LINCOLN			FORD MAZDA			LEXUS TOYOTA		
G60258		142700	G61113		Not Req'd.	G61170	N	Not Req'd.
FORD			FORD MAZDA			JEEP		
G60259		142731	G61115		Not Req'd.	G61173	N	142976
FORD			FORD MAZDA			LEXUS TOYOTA		
G60260		Not Req'd.	G61116		Not Req'd.	G61175	N	Not Req'd.
FORD LINCOLN			CHEVROLET OLDSMOBILE PONTIAC SATURN			CHEVROLET GMC ISUZU OLDSMOBILE		
G60263		Not Req'd.	G61118		142700	G61177	N	Not Req'd.
KIA			FORD			FORD		
G60264		141665	G61121		141350	G61178	N	Not Req'd.
JEEP			MITSUBISHI			JEEP		
G60265		Not Req'd.	G61122		141350	G61180	N	Not Req'd.
JEEP			MITSUBISHI			INFINITI NISSAN		
G60269		140921	G61124		141665	G61182	N	142731
TOYOTA			CHEVROLET GMC			DODGE		
G60301		140673	G61139		140455	G61204	N	141353 & 142592
TOYOTA			SUZUKI			JEEP		
G60303		140857	G61140		141514	G61860	N	140455
CHEVROLET ISUZU NISSAN			ASUNA CHEVROLET GEO PONTIAC SUZUKI			TOYOTA		
G60304		141376				G61862	N	140455
TOYOTA						FORD MAZDA MERCURY		
G60305		141356				G61864	N	Not Req'd.
MITSUBISHI NISSAN						MAZDA		
G60306		Not Req'd.				G61865	N	142389
DODGE						TOYOTA		
G60307		Not Req'd.						
CHEVROLET GMC								

★ Will be available in first quarter of 2011.

NUMERICAL LISTING

LISTA NUMÉRICA

LISTE NUMÉRIQUE

GABRIEL #	APPLICATION	MTG. ACC PKG. NO.
G61866	N CHEVROLET GMC WORKHORSE	Not Req'd.
G61867	N FORD LINCOLN	Not Req'd
G61868	N BUICK PONTIAC	Not Req'd.
G61869	N PONTIAC	Not Req'd.
G61870	N FORD	Not Req'd
G61872	N SATURN	Not Req'd.
G61873	N FORD MERCURY	Not Req'd.
G61875	N NISSAN	Not Req'd.
G61877	N HONDA	Not Req'd.
G61878	N NISSAN	Not Req'd.
G61879	N CHEVROLET GMC ISUZU	Not Req'd.
G61881	N DODGE	140126
G61882	N CHEVROLET GMC ISUZU	Not Req'd.
G61883	N NISSAN	Not Req'd.
G61884	N CHEVROLET GMC ISUZU	142036
G61885	N TOYOTA	142280 & 142280
G61886	N FORD	142731
G61887	N FORD	Not Req'd.
G61888	N FORD	Not Req'd.
G61889	N TOYOTA	141041
G61890	N DODGE	Not Req'd.
G61891	N DODGE	Not Req'd.
G61892	N CHRYSLER DODGE	Not Req'd.
G61893	N CHEVROLET GMC	143078

GABRIEL #	APPLICATION	MTG. ACC PKG. NO.
G61894	N CHEVROLET GMC	143078
G61895	N CHEVROLET GMC	143078
G61896	N CHEVROLET GMC	Not Req'd.
G61897	N CHEVROLET GMC	Not Req'd.
G61898	N CHEVROLET GMC	Not Req'd.
G61918	N DODGE MERCEDES-BENZ	Not Req'd.
G61919	N DODGE MERCEDES-BENZ	Not Req'd.
G61958	N DODGE	143078
G61959	N CHEVROLET GMC	Not Req'd.
G61961	N DODGE	Not Req'd.
G61962	N DODGE	Not Req'd.
G61963	N FORD	Not Req'd.
G61964	N FORD	Not Req'd.
G61965	N HUMMER	Not Req'd.
G61966	N JEEP	Not Req'd.
G61967	N JEEP	Not Req'd.
G61969	N FORD	143146
G61970	N DODGE	Not Req'd.
G61971	N DODGE	Not Req'd.
G62000	N HUMMER	Not Req'd.
G62001	N HUMMER	143078
G62002	N LINCOLN	Not Req'd.
G62003	N ACURA HONDA	Not Req'd.
G62004	N TOYOTA	141041
G62005	N TOYOTA	141041

GABRIEL #	APPLICATION	MTG. ACC PKG. NO.
G62006	N TOYOTA	141041
G62007	N TOYOTA	141041
G62008	N JEEP	142973
G62009	N DODGE	142731
G62010	N FORD	Not Req'd.
G62011	N DODGE	142731
G62012	N JEEP	Not Req'd.
G62013	N DODGE	Not Req'd.
G62014	N BUICK CHEVROLET GMC ISUZU OLDSMOBILE	Not Req'd.
G62015	N CHEVROLET PONTIAC	Not Req'd.
G62016	N CHRYSLER DODGE	Not Req'd.

FleetLine

83001	FREIGHTLINER	404702(1)
83002	KENWORTH LINK MANUFACTURING	Not Req'd.
83003	MACK	140455(1)
83004	VOLVO	Not Req'd.
83005	INTERNATIONAL (NAVISTAR) LINK MANUFACTURING	140455(1)
83006	FREIGHTLINER	404702(1)
83007	MACK	404702(2)
83008	PETERBILT	Not Req'd.
83009	FREIGHTLINER OSHKOSH MOTORS	Not Req'd.
83010	WESTERN STAR	Not Req'd.
83011	KENWORTH PETERBILT	404702(2)
83012	KENWORTH PETERBILT	404702(2)

★ Will be available in first quarter of 2011.

NUMERICAL LISTING

LISTA NUMÉRICA

LISTE NUMÉRIQUE

GABRIEL #	APPLICATION	MTG. ACC PKG. NO.
83013	INTERNATIONAL (NAVISTAR) LINK MANUFACTURING	Not Req'd.
83014	INTERNATIONAL (NAVISTAR) MACK	140455(2)
83015	INTERNATIONAL (NAVISTAR)	140455(1)
83016	CHEVROLET TRUCK FORD FREIGHTLINER GMC INTERNATIONAL (NAVISTAR) KENWORTH LINK MANUFACTURING MACK PETERBILT VOLVO WESTERN STAR	Not Req'd.
83017	FREIGHTLINER	Not Req'd.
83018	MACK	140780(1)
83019	MACK	140780(1)
83020	FREIGHTLINER	Not Req'd.
83021	CHEVROLET TRUCK FREIGHTLINER GMC INTERNATIONAL (NAVISTAR) KENWORTH LINK MANUFACTURING MARMON OSHKOSH MOTORS PETERBILT	Not Req'd.
83022	WESTERN STAR	Not Req'd.
83023	CHEVROLET TRUCK FORD FREIGHTLINER GMC INTERNATIONAL (NAVISTAR) KENWORTH LINK MANUFACTURING MACK PETERBILT VOLVO WESTERN STAR	Not Req'd.
83024	KENWORTH LINK MANUFACTURING	Not Req'd.
83025	FORD FREIGHTLINER GMC INTERNATIONAL (NAVISTAR) KENWORTH LINK MANUFACTURING PETERBILT STERLING	Not Req'd.
83026	FREIGHTLINER WESTERN STAR	Not Req'd.

GABRIEL #	APPLICATION	MTG. ACC PKG. NO.
83027	WESTERN STAR	140126(1)
83028	VOLVO	Not Req'd.
83029	VOLVO	Not Req'd.
83030	VOLVO	Not Req'd.
83031	KENWORTH LINK MANUFACTURING	Not Req'd.
83032	FORD FREIGHTLINER INTERNATIONAL (NAVISTAR) KENWORTH LINK MANUFACTURING	Not Req'd.
83033	FORD STERLING	Not Req'd.
83034	FORD FREIGHTLINER STERLING	Not Req'd.
83035	PETERBILT	Not Req'd.
83038	FREIGHTLINER	404702(1)
83039	FREIGHTLINER	Not Req'd.
83040	FREIGHTLINER	Not Req'd.
83041	MACK	140780(1)
83042	PETERBILT	Not Req'd.
83044 N	FREIGHTLINER	Not Req'd.
83045 N	MACK	140780(1)
83046 N	CHEVROLET TRUCK FORD FREIGHTLINER GMC INTERNATIONAL (NAVISTAR) KENWORTH LINK MANUFACTURING MACK MARMON PETERBILT VOLVO WESTERN STAR	Not Req'd.
83047 N	FREIGHTLINER	404702(1)
83048 N	VOLVO	Not Req'd.
83049 N	KENWORTH LINK MANUFACTURING	Not Req'd.
83050 N	MACK VOLVO	140780(1)

GABRIEL #	APPLICATION	MTG. ACC PKG. NO.
83051 N	INTERNATIONAL (NAVISTAR) LINK MANUFACTURING	Not Req'd.
83052 N	INTERNATIONAL (NAVISTAR) LINK MANUFACTURING	Not Req'd.
83053 N	INTERNATIONAL (NAVISTAR) LINK MANUFACTURING	Not Req'd.
83054 N	INTERNATIONAL (NAVISTAR) LINK MANUFACTURING	Not Req'd.
83100	INTERNATIONAL (NAVISTAR) MERCEDES	Not Req'd.
83101	INTERNATIONAL (NAVISTAR) MACK	Not Req'd.
83102	THOMAS SCHOOL BUS	145089-000(2)
83103	INTERNATIONAL (NAVISTAR) MITSUBISHI-FUSO MOR-RYDE SUSPENSION VOLVO	145054(2)
83104	HINO VOLVO	Not Req'd.
83105	MACK VOLVO	140780(1)
83107	FORD MAECO STERLING TRUCK	145080(2)
83109	FORD HENDRICKSON TRUCK SUSPENSION SYS STERLING TRUCK	145128(1)
83110	HENDRICKSON TRUCK SUSPENSION SYS MACK	145128(1)
83111	HENDRICKSON TRUCK SUSPENSION SYS MACK WESTERN STAR	145128(1)
83112	HENDRICKSON TRUCK SUSPENSION SYS MACK VOLVO	145128(1)
83113	SAF HOLLAND STOUGHTON TRAILERS INC. TRAILMOBILE CANADA CORP. WABASH NATIONAL	Not Req'd.
83114	CHEVROLET TRUCK GMC TRUCK INTERNATIONAL (NAVISTAR) ISUZU NISSAN	140780(1)
83115	SAF HOLLAND TRAILMOBILE CANADA CORP.	Not Req'd.
83116	FREIGHTLINER CUSTOM CHASSIS	Not Req'd.

★ Will be available in first quarter of 2011.

NUMERICAL LISTING

LISTA NUMÉRICA

LISTE NUMÉRIQUE

GABRIEL #	APPLICATION	MTG. ACC PKG. NO.
83117		404702(1)
	FREIGHTLINER FREIGHTLINER CUSTOM CHASSIS OSHKOSH MOTORS	
83118		Not Req'd.
	FREIGHTLINER FREIGHTLINER CUSTOM CHASSIS MAECO OSHKOSH MOTORS	
83119		Not Req'd.
	FREIGHTLINER CUSTOM CHASSIS OSHKOSH MOTORS	
83120		145089-000(1) & 145143(1)
	FREIGHTLINER FREIGHTLINER CUSTOM CHASSIS MAECO OSHKOSH MOTORS STERLING TRUCK THOMAS SCHOOL BUS	
83122		Not Req'd.
	ALLCO TRAILER CHEVROLET TRUCK FORD FREIGHTLINER FRUEHAUF GILLIG BROS. GMC TRUCK GREAT DANE TRAILER HENDRICKSON TRUCK SUSPENSION SYS ISUZU LODAL, INC. MACK MAECO MARMON OSHKOSH MOTORS REYCO SUSPENSION SAF HOLLAND VOLVO VOLVO-AUTOCAR WESTERN STAR	
83123		Not Req'd.
	FORD GILLIG BROS. HENDRICKSON TRUCK SUSPENSION SYS INTERNATIONAL (NAVISTAR) KENWORTH MACK MARMON REYCO SUSPENSION SAF HOLLAND VOLVO WATSON & CHALIN MFG. INC.	
83124		Not Req'd.
	BENSON TRUCK BODIES INC. EAST MANUFACTURING CORP. KENWORTH SAF HOLLAND TRAILMOBILE CANADA CORP. TWIN COACH WABASH NATIONAL	
83125		Not Req'd.
	CASCADE TRAILER EAST MANUFACTURING CORP. FORD GENERAL TRAILER CO HENDRICKSON TRUCK SUSPENSION SYS HOLLAND - BINKLEY MACK	

GABRIEL #	APPLICATION	MTG. ACC PKG. NO.
83125 (Cont'd.)		
	MAECO PEERLESS TRAILER SAF HOLLAND STERLING TRUCK THE BINKLEY COMPANY TRAILMOBILE CANADA CORP. VOLVO WABASH NATIONAL WATSON & CHALIN MFG. INC.	
83126		Not Req'd.
	HINO INTERNATIONAL (NAVISTAR) SAF HOLLAND WABASH NATIONAL	
83127		Not Req'd.
	BLUEBIRD SCHOOL BUS FREIGHTLINER CUSTOM CHASSIS HOLIDAY RAMBLER OSHKOSH MOTORS SAF HOLLAND TRAILMOBILE CANADA CORP. WABASH NATIONAL	
83128		Not Req'd.
	EAST MANUFACTURING CORP. FREIGHTLINER SAF HOLLAND STOUGHTON TRAILERS INC. TWIN COACH WABASH NATIONAL	
83130		Not Req'd.
	SAF HOLLAND WABASH NATIONAL	
83131		Not Req'd.
	FORD	
83134		145054(1)
	FREIGHTLINER	
83135		Not Req'd.
	FORD INTERNATIONAL (NAVISTAR)	
83136		145054(2)
	CHAMPION TRANSIT CHEVROLET TRUCK GMC TRUCK ISUZU KENWORTH PETERBILT	
83137		Not Req'd.
	BERING TRUCK CORP. CHEVROLET TRUCK GMC TRUCK HENDRICKSON TRUCK SUSPENSION SYS ISUZU KENWORTH MACK SAF HOLLAND VOLVO WESTERN STAR	
83138		145128(1)
	MACK	
83140		415010-802(2) & 145148(2)
	FORD HINO	
83141		415010-802(2) & 145148(2)
	HINO	

GABRIEL #	APPLICATION	MTG. ACC PKG. NO.
83142		145128(1)
	HENDRICKSON TRUCK SUSPENSION SYS KENWORTH PETERBILT	
83143		145128(1)
	HENDRICKSON TRUCK SUSPENSION SYS INTERNATIONAL (NAVISTAR) KENWORTH PETERBILT	
83144		Not Req'd.
	HENDRICKSON TRUCK SUSPENSION SYS INTERNATIONAL (NAVISTAR) WORKHORSE	
83145	N	Not Req'd.
	FORD INTERNATIONAL (NAVISTAR)	
83146	N	Not Req'd.
	FORD INTERNATIONAL (NAVISTAR)	
83147	N	Not Req'd.
	HENDRICKSON TRUCK SUSPENSION SYS MACK	
83148	N	Not Req'd.
	HENDRICKSON TRUCK SUSPENSION SYS HINO	
83149	N	Not Req'd.
	HENDRICKSON TRUCK SUSPENSION SYS	
83150	N	Not Req'd.
	HENDRICKSON TRAILER SUSPENSION SAF HOLLAND	
83153	N	Not Req'd.
	CHEVROLET TRUCK GMC TRUCK	
83154	N	145089-000(1)
	FREIGHTLINER CUSTOM CHASSIS	
83155	N	Not Req'd.
	CHEVROLET TRUCK GMC TRUCK	
83156	N	Not Req'd.
	INTERNATIONAL (NAVISTAR)	
★ 83157	N	Not Req'd.
	FREIGHTLINER CUSTOM CHASSIS	
★ 83158	N	Not Req'd.
	MOTOR COACH INDUSTRIES	
★ 83159	N	401011(4)
	GMC TRUCK ISUZU	
★ 83160	N	Not Req'd.
	FREIGHTLINER CUSTOM CHASSIS	
★ 83161	N	140524(1) & 404702(1)
	NISSAN	
★ 83162	N	(1)140780 & (1)145116
	NISSAN	
83200		140149(1)
	FORD STERLING TRUCK	

★ Will be available in first quarter of 2011.

NUMERICAL LISTING

LISTA NUMÉRICA

LISTE NUMÉRIQUE

GABRIEL #	APPLICATION	MTG. ACC PKG. NO.	GABRIEL #	APPLICATION	MTG. ACC PKG. NO.	GABRIEL #	APPLICATION	MTG. ACC PKG. NO.
83203	Not Req'd.		83214(Cont'd.)			83225(Cont'd.)		
CHANCE BUS			SPARTAN MOTORS			TRAILMOBILE CANADA CORP.		
CHEVROLET TRUCK			VOLVO			VOLVO		
DURA SUSPENSION			83215	401754(4)		83242	Not Req'd.	
FRUEHAUF			ACF BRILL BUS			MACK		
GMC TRUCK			BROCKWAY SCHOOL BUS			83301	141083(1)	
HIGHWAY PRODUCT			CHEVROLET TRUCK			INTERNATIONAL (NAVISTAR)		
HUTCHENS SUSPENSION			FORD			83303	140702(1)	
MACK			GMC TRUCK			CHEVROLET TRUCK		
MOHAWK			HINO			GMC TRUCK		
ORION BUS INDUSTRIES			INTERNATIONAL (NAVISTAR)			VOLVO		
PAGE SUSPENSION			MACK			83304	140702(1)	
PETERBILT			MAECO			CHEVROLET TRUCK		
REYCO SUSPENSION			PAI CORP			GMC TRUCK		
RIDEWELL CORPORATION			REYCO SUSPENSION			VOLVO		
SAF HOLLAND			STERLING TRUCK			83308	140149(1)	
VOLVO			VOLVO			CHEVROLET TRUCK		
WABASH NATIONAL			83216	140149(1)		FORD		
WATSON & CHALIN MFG. INC.			BROCKWAY SCHOOL BUS			GMC TRUCK		
83204	Not Req'd.		CHEVROLET TRUCK			INTERNATIONAL (NAVISTAR)		
DUPLEX TRUCK			FORD			STERLING TRUCK		
DURA SUSPENSION			GILLIG BROS.			83309	140149(1)	
MAECO			GMC TRUCK			FORD		
PAGE SUSPENSION			HINO			INTERNATIONAL (NAVISTAR)		
REYCO SUSPENSION			INTERNATIONAL (NAVISTAR)			STERLING TRUCK		
SAF HOLLAND			MACK			VOLVO		
TRAILMOBILE CANADA CORP.			MAECO			83312	140149(1)	
VOLVO			MARMON			FORD		
WATSON & CHALIN MFG. INC.			MOHAWK			KENWORTH		
83207	Not Req'd.		NEOPLAN BUS			OSHKOSH MOTORS		
BLUEBIRD SCHOOL BUS			ONEIDA PRODUCTS			PIERCE MANUFACTURING INC.		
BROCKWAY SCHOOL BUS			VOLVO			VOLVO		
CHANCE BUS			VOLVO-AUTOCAR			83314	140149(1)	
CHEVROLET TRUCK			WESTERN STAR			FORD		
DURA SUSPENSION			83217	401754(4)		INTERNATIONAL (NAVISTAR)		
FORD			CHEVROLET TRUCK			MAECO		
GILLIG BROS.			DIAMOND-REO			STERLING TRUCK		
GMC TRUCK			EAST MANUFACTURING CORP.			VOLVO		
GREAT DANE TRAILER			FLXIBLE BUS			83317	141083(1)	
HARDEE MFG			FORD			FORD		
HENDRICKSON TRUCK SUSPENSION SYS			GMC TRUCK			INTERNATIONAL (NAVISTAR)		
HIGHWAY PRODUCT			HINO			83318	141083(2)	
INTERNATIONAL (NAVISTAR)			HYSTER			INTERNATIONAL (NAVISTAR)		
MACK			MACK			83353	145099(1)	
MAECO			OLE GRANNING			KENWORTH		
MOHAWK			OTTAWA TRUCK			VOLVO		
NATIONAL COACH CORP			REYCO SUSPENSION			83362	401754(4)	
OSHKOSH MOTORS			SOUTHERN COACH			HINO		
REYCO SUSPENSION			VOLVO			83400	140455(2)	
RIDEWELL CORPORATION			83219	140149(1)		CHEVROLET TRUCK		
SAF HOLLAND			CHEVROLET TRUCK			FORD		
TRAILMOBILE CANADA CORP.			FORD			GMC TRUCK		
TWIN COACH			GILLIG BROS.			MOR-RYDE SUSPENSION		
VOLVO			GMC TRUCK			VOLVO		
WABASH NATIONAL			VOLVO			WATSON & CHALIN MFG. INC.		
83209	Not Req'd.		83221	Not Req'd.		WESTERN STAR		
CHEVROLET TRUCK			CHEVROLET TRUCK			83401	404702(2)	
FORD			GMC TRUCK			CHEVROLET TRUCK		
GMC TRUCK			KENWORTH			GMC TRUCK		
HENDRICKSON TRAILER SUSPENSION			MACK			VOLVO		
INTERNATIONAL (NAVISTAR)			OSHKOSH MOTORS			WESTERN STAR		
MACK			PAI CORP			83456	142998(2)	
REYCO SUSPENSION			PETERBILT			INTERNATIONAL (NAVISTAR)		
SAF HOLLAND			REYCO SUSPENSION			MITSUBISHI-FUSO		
TRAILMOBILE CANADA CORP.			VOLVO			VOLVO		
VOLVO			83225	401754(4)		83401	404702(2)	
WABASH NATIONAL			ACF BRILL BUS			CHEVROLET TRUCK		
83214	401754(4)		FORD			GMC TRUCK		
CHEVROLET TRUCK			FREIGHTLINER			VOLVO		
DIAMOND-REO			HENDRICKSON TRUCK SUSPENSION SYS			WESTERN STAR		
EAST MANUFACTURING CORP.			INTERNATIONAL (NAVISTAR)			83456	142998(2)	
GMC TRUCK			MACK			INTERNATIONAL (NAVISTAR)		
GRANNING SUSPENSION			MOHAWK			MITSUBISHI-FUSO		
OSTERLUND TRUCK						VOLVO		

★ Will be available in first quarter of 2011.

NUMERICAL LISTING

LISTA NUMÉRICA

LISTE NUMÉRIQUE

GABRIEL #	APPLICATION	MTG. ACC PKG. NO.
83613	INTERNATIONAL (NAVISTAR) THOMAS SCHOOL BUS	141083(2)
83634	FREIGHTLINER	Not Req'd.
83635	SAF HOLLAND VOLVO WESTERN STAR	145054(1)
83636	INTERNATIONAL (NAVISTAR)	Not Req'd.
85000	BENSON TRUCK BODIES INC. EAST MANUFACTURING CORP. FREIGHTLINER GREAT DANE TRAILER HENDRICKSON TRAILER SUSPENSION MERITOR ORION BUS INDUSTRIES REYCO SUSPENSION RIDEWELL CORPORATION SAF HOLLAND STOUGHTON TRAILERS INC. THOMAS SCHOOL BUS TRAILMOBILE CANADA CORP. TWIN COACH VOLVO WABASH NATIONAL WATSON & CHALIN MFG. INC.	Not Req'd.
85001	FORD KENWORTH MACK MAECO REYCO SUSPENSION STERLING TRUCK VOLVO	401754(4)
85003	INTERNATIONAL (NAVISTAR) MARMON REYCO SUSPENSION VOLVO	Not Req'd.
85004	PETERBILT SAF HOLLAND	401754(4)
85005	BLUEBIRD SCHOOL BUS CHEVROLET TRUCK EAST MANUFACTURING CORP. FORD FREIGHTLINER FREIGHTLINER CUSTOM CHASSIS GMC TRUCK HENDRICKSON TRAILER SUSPENSION HENDRICKSON TRUCK SUSPENSION SYS INTERNATIONAL (NAVISTAR) KENWORTH MACK REYCO SUSPENSION RIDEWELL CORPORATION SAF HOLLAND VOLVO VOLVO-AUTOCAR WATSON & CHALIN MFG. INC.	Not Req'd.
85006	BLUEBIRD SCHOOL BUS BUILT RITE FORD FREIGHTLINER FREIGHTLINER CUSTOM CHASSIS GREAT DANE TRAILER	Not Req'd.

GABRIEL #	APPLICATION	MTG. ACC PKG. NO.
85006(Cont'd.)	HENDRICKSON TRAILER SUSPENSION MAECO REYCO SUSPENSION RIDEWELL CORPORATION SAF HOLLAND STERLING TRUCK STOUGHTON TRAILERS INC. THE BINKLEY COMPANY THOMAS SCHOOL BUS TRAILMOBILE CANADA CORP. VOLVO WESTERN STAR	
85007	FREIGHTLINER KENWORTH MACK SPARTAN MOTORS VOLVO	401754(4)
85009	FREIGHTLINER MITSUBISHI-FUSO NEOPLAN BUS WATSON & CHALIN MFG. INC.	145054(1)
85010	BLUEBIRD SCHOOL BUS FREIGHTLINER CUSTOM CHASSIS HENDRICKSON TRAILER SUSPENSION MACK OSHKOSH MOTORS THOMAS SCHOOL BUS	Not Req'd.
85011	FREIGHTLINER	Not Req'd.
85012	BLUEBIRD SCHOOL BUS BROCKWAY SCHOOL BUS CHEVROLET TRUCK FORD GMC TRUCK INTERNATIONAL (NAVISTAR) ISUZU PETERBILT	145080(2)
85013	BLUEBIRD SCHOOL BUS FORD HENDRICKSON TRAILER SUSPENSION HENDRICKSON TRUCK SUSPENSION SYS INTERNATIONAL (NAVISTAR) MAECO PETERBILT REYCO SUSPENSION SAF HOLLAND SPARTAN MOTORS STERLING TRUCK TRAILMOBILE CANADA CORP. VOLVO	Not Req'd.
85014	CHANCE BUS HARDEE MFG HENDRICKSON TRAILER SUSPENSION INTERNATIONAL (NAVISTAR) MACK REYCO SUSPENSION RIDEWELL CORPORATION WATSON & CHALIN MFG. INC.	Not Req'd.
85023	VOLVO	140149(1)
85024	VOLVO VOLVO-AUTOCAR	140149(1)

GABRIEL #	APPLICATION	MTG. ACC PKG. NO.
85025	VOLVO	140169(1) & 145054(1)
85026	VOLVO VOLVO-AUTOCAR	145054(1)
85027	INTERNATIONAL (NAVISTAR) VOLVO VOLVO-AUTOCAR	145054(2)
85029	BLUEBIRD SCHOOL BUS DURA SUSPENSION EAST MANUFACTURING CORP. FREIGHTLINER CUSTOM CHASSIS HENDRICKSON TRAILER SUSPENSION INTERNATIONAL (NAVISTAR) PAGE SUSPENSION RIDEWELL CORPORATION SPARTAN MOTORS TRAILMOBILE CANADA CORP. WATSON & CHALIN MFG. INC.	Not Req'd.
85030	BLUEBIRD SCHOOL BUS EAST MANUFACTURING CORP. FORD FRUEHAUF HENDRICKSON TRAILER SUSPENSION HENDRICKSON TRUCK SUSPENSION SYS INTERNATIONAL (NAVISTAR) KENWORTH MAECO OSHKOSH MOTORS PACIFIC TRUCK & TRAILER PIERCE MANUFACTURING INC. REYCO SUSPENSION SAF HOLLAND STERLING TRUCK VOLVO WABASH NATIONAL	Not Req'd.
85031	KENWORTH	140169(1) & 401011(2)
85033	PETERBILT	145099(1)
85036	HENDRICKSON TRUCK SUSPENSION SYS MACK PETERBILT	Not Req'd.
85040	FORD STERLING TRUCK VOLVO	401754(4)
85042	FREIGHTLINER	401754(4)
85043	FREIGHTLINER FREIGHTLINER CUSTOM CHASSIS HENDRICKSON TRAILER SUSPENSION STERLING TRUCK	Not Req'd.
85045	HENDRICKSON TRAILER SUSPENSION REYCO SUSPENSION RIDEWELL CORPORATION SAF HOLLAND WABASH NATIONAL	Not Req'd.
85046	VOLVO VOLVO-AUTOCAR	140149(1)

★ Will be available in first quarter of 2011.

NUMERICAL LISTING

LISTA NUMÉRICA

LISTE NUMÉRIQUE

GABRIEL #	APPLICATION	MTG. ACC PKG. NO.	GABRIEL #	APPLICATION	MTG. ACC PKG. NO.	GABRIEL #	APPLICATION	MTG. ACC PKG. NO.
85047	FORD STERLING TRUCK VOLVO	140149(1)	85067	KENWORTH PETERBILT	Not Req'd.	85302	AM GENERAL CHEVROLET TRUCK CRANE CARRIER DINA BUS FORD FREIGHTLINER FWD TRUCK GILLIG BROS. GMC TRUCK MACK MAECO MOTOR COACH INDUSTRIES PETERBILT RIDEWELL CORPORATION VOLVO	401754(4)
85050	CHEVROLET TRUCK GMC TRUCK	Not Req'd.	85069	KENWORTH PETERBILT	145089-000(2)	85303	ACF BRILL BUS BROCKWAY SCHOOL BUS BUS & TRUCK CO. CHEVROLET TRUCK CONTINENTAL TRAILWAYS-EAGLE INT'L CRANE CARRIER CROWN COACH EAGLE MOTOR COACH GMC TRUCK GREYHOUND BUS HENDRICKSON TRUCK SUSPENSION SYS INTERNATIONAL (NAVISTAR) MACK MAECO MATSON SCHOOL BUS MC NEILUS TRUCK & MAN. COMPANY MOHAWK MOTOR COACH INDUSTRIES ORION BUS INDUSTRIES OSHKOSH MOTORS OTTAWA TRUCK PREVOST TRANSPORTATION MFG. CORP VOLVO WESTERN STAR	401754(4)
85051	BLUEBIRD SCHOOL BUS GILLIG BROS. MUNCIE RECLAMATION OSHKOSH MOTORS REYCO SUSPENSION SAF HOLLAND STOUGHTON TRAILERS INC. TRAILMOBILE CANADA CORP. WABASH NATIONAL	Not Req'd.	85070	KENWORTH	401754(2)	85304	BECK BUS BLUEBIRD SCHOOL BUS BROCKWAY SCHOOL BUS CHEVROLET TRUCK CONTINENTAL TRAILWAYS-EAGLE INT'L CRANE CARRIER CROWN COACH DIAMOND T DIAMOND-REO EAGLE MOTOR COACH FLXIBLE BUS FORD FRUEHAUF GILLIG BROS. GMC TRUCK MACK OSHKOSH MOTORS PIERCE MANUFACTURING INC. RIDEWELL CORPORATION SAF HOLLAND SOUTHERN COACH SPARTAN MOTORS THOMAS SCHOOL BUS UNITED MANUFACTURING VOLVO WESTERN STAR WESTERN UNIT "STABILAIRE" SUSP	401754(4)
85052	BLUEBIRD SCHOOL BUS GREAT DANE TRAILER HENDRICKSON TRAILER SUSPENSION REYCO SUSPENSION SAF HOLLAND WABASH NATIONAL WATSON & CHALIN MFG. INC.	Not Req'd.	85071	CHEVROLET TRUCK GMC TRUCK ISUZU	145054(2)	85305	BROCKWAY SCHOOL BUS BUS & TRUCK CO. CHEVROLET TRUCK CONTINENTAL TRAILWAYS-EAGLE INT'L CRANE CARRIER CROWN COACH EAGLE MOTOR COACH GMC TRUCK GREYHOUND BUS HENDRICKSON TRUCK SUSPENSION SYS INTERNATIONAL (NAVISTAR) MACK MAECO MATSON SCHOOL BUS MC NEILUS TRUCK & MAN. COMPANY MOHAWK MOTOR COACH INDUSTRIES ORION BUS INDUSTRIES OSHKOSH MOTORS OTTAWA TRUCK PREVOST TRANSPORTATION MFG. CORP VOLVO WESTERN STAR	401754(4)
85053	WESTERN STAR	145126(2)	85072	HENDRICKSON TRUCK SUSPENSION SYS INTERNATIONAL (NAVISTAR) KENWORTH VOLVO	Not Req'd.			
85054	FORD STERLING TRUCK	145080(2)	85078	N DANA WABASH NATIONAL	Not Req'd.			
85055	FORD STERLING TRUCK	145080(2)	85079	N HENDRICKSON TRAILER SUSPENSION	Not Req'd.			
85058	FREIGHTLINER FREIGHTLINER CUSTOM CHASSIS INTERNATIONAL (NAVISTAR) OSHKOSH MOTORS PIERCE MANUFACTURING INC.	Not Req'd.	85080	N MACK VOLVO	145054(1)			
85059	RED LION TRAILER SAF HOLLAND STOUGHTON TRAILERS INC. TRAILMOBILE CANADA CORP. WABASH NATIONAL	Not Req'd.	85081	N VOLVO	145090(1)			
85060	CHALMERS SUSPENSION FREIGHTLINER KENWORTH PETERBILT SAF HOLLAND VOLVO WATSON & CHALIN MFG. INC. WESTERN STAR	Not Req'd.	85082	N INTERNATIONAL (NAVISTAR)	Not Req'd.			
85061	MACK VOLVO	Not Req'd.	85083	N HENDRICKSON TRUCK SUSPENSION SYS	145128(1)			
85062	PETERBILT	145080(2)	★85084	N KENWORTH	Not Req'd.			
85063	FORD MAECO STERLING TRUCK	145080(2)	★85085	N NISSAN	145054(2)			
85065	VOLVO	145128(1)145144(1)	85300	CHEVROLET TRUCK FREIGHTLINER FRUEHAUF GMC TRUCK GRANNING SUSPENSION HOBBS TRAILERS INTERNATIONAL (NAVISTAR) MUNCIE RECLAMATION OSHKOSH MOTORS OSTERLUND TRUCK OTTAWA TRUCK PIERCE MANUFACTURING INC. REYCO SUSPENSION SAF HOLLAND VOLVO WABASH NATIONAL WATSON & CHALIN MFG. INC. WESTERN UNIT "STABILAIRE" SUSP	401754(4)			
85066	MACK VOLVO	Not Req'd.	85301	BECK BUS CHALMERS SUSPENSION CHEVROLET TRUCK CLARK EQUIPMENT FLXIBLE BUS FORD GMC TRUCK SAF HOLLAND STERLING TRUCK VOLVO	401754(4)			

★ Will be available in first quarter of 2011.

NUMERICAL LISTING

LISTA NUMÉRICA

LISTE NUMÉRIQUE

GABRIEL #	APPLICATION	MTG. ACC PKG. NO.	GABRIEL #	APPLICATION	MTG. ACC PKG. NO.	GABRIEL #	APPLICATION	MTG. ACC PKG. NO.
85305(Cont'd.)		401754(4)	85313		401754(4)	85331		Not Req'd.
EAGLE MOTOR COACH			FLXIBLE BUS			FREIGHTLINER		
FLXIBLE BUS			GMC TRUCK			FREIGHTLINER CUSTOM CHASSIS		
FORD			GREYHOUND BUS			85332		145128(1)
FRUEHAUF			MOTOR COACH INDUSTRIES			INTERNATIONAL (NAVISTAR)		
GMC TRUCK			NOVA BUS			85333		145128(1)
HENDRICKSON TRUCK SUSPENSION SYS			85313(Cont'd.)			INTERNATIONAL (NAVISTAR)		
MACK			REYCO SUSPENSION			85334		401754(4)
MAECO			TRANSPORTATION MFG. CORP			ADVANCE MIXER		
MOHAWK			85314		401754(4)	85335		Not Req'd.
PAI CORP			CHALMERS SUSPENSION			FREIGHTLINER		
RIDEWELL CORPORATION			EAGLE MOTOR COACH			85336		145054(2)
VOLVO			FORD			CHEVROLET TRUCK		
WESTERN STAR			KENWORTH			GMC TRUCK		
WESTERN UNIT "STABILAIRES" SUSP			MAECO			ISUZU		
85307		401754(4)	STERLING TRUCK			PETERBILT		
ACF BRILL BUS			VOLVO			85337		Not Req'd.
BECK BUS			85315		401754(4)	BLUEBIRD SCHOOL BUS		
BLUEBIRD SCHOOL BUS			CLARK EQUIPMENT			HENDRICKSON TRAILER SUSPENSION		
BROCKWAY SCHOOL BUS			CUNHA PRODUCTS OHD			HENDRICKSON TRUCK SUSPENSION SYS		
BUS & TRUCK CO.			FORD			85338		Not Req'd.
CHEVROLET TRUCK			JIFFLOX			HENDRICKSON TRAILER SUSPENSION		
CLARK EQUIPMENT			KWK-LOC (JIFFLOX)			85339	N	401754(4)
CONTINENTAL TRAILWAYS-EAGLE INT'L			VOLVO			MOTOR COACH INDUSTRIES		
CRANE CARRIER			WESTERN STAR			TRANSPORTATION MFG. CORP		
DIAMOND-REO			85316		145090(1)	★ 85340	N	145089-000(1)
EAGLE MOTOR COACH			INTERNATIONAL (NAVISTAR)			MOTOR COACH INDUSTRIES		
FLXIBLE BUS			MAECO			★ 85341	N	145089-000(1)
FORD			OSHKOSH MOTORS			MOTOR COACH INDUSTRIES		
GMC TRUCK			PIERCE MANUFACTURING INC.			85376		401754(4)
HENDRICKSON TRUCK SUSPENSION SYS			85318		145054(2)	FORD		
INTERNATIONAL (NAVISTAR)			GILLIG BROS.			STERLING TRUCK		
MACK			HAUSMAN			85377	N	Not Req'd.
MAECO			85319		145089-000(1)	NOVA BUS		
ONEIDA PRODUCTS			FREIGHTLINER			85378	N	Not Req'd.
ORION BUS INDUSTRIES			VOLVO			NOVA BUS		
RIDEWELL CORPORATION			85320		401754(4)	PREVOST		
THOMAS SCHOOL BUS			FREIGHTLINER			85700		401754(4)
VOLVO			MAECO			ABC BUS		
WESTERN STAR			85321		Not Req'd.	AM GENERAL		
WESTERN UNIT "STABILAIRES" SUSP			BLUEBIRD SCHOOL BUS			CHEVROLET TRUCK		
85308		401754(4)	FRUEHAUF			EAGLE MOTOR COACH		
ACF BRILL BUS			HOLLAND - BINKLEY			FLXIBLE BUS		
CHEVROLET TRUCK			MACK			FLYER INDUSTRIES		
EAGLE MOTOR COACH			SAF HOLLAND			GMC TRUCK		
FREIGHTLINER			WABASH NATIONAL			GREYHOUND BUS		
GMC TRUCK			WATSON & CHALIN MFG. INC.			JAY MADSEN		
INTERNATIONAL (NAVISTAR)			85322		401754(2)	KENWORTH		
MACK			FRUEHAUF			MOHAWK		
MAECO			WABASH NATIONAL			MOTOR COACH INDUSTRIES		
MOHAWK			85323		Not Req'd.	MUNCIE RECLAMATION		
ORION BUS INDUSTRIES			GREAT DANE TRAILER			NOVA BUS		
PETERBILT			HENDRICKSON TRAILER SUSPENSION SYS			ORION BUS INDUSTRIES		
PREVOST			SAF HOLLAND			PREVOST		
THOMAS SCHOOL BUS			WABASH NATIONAL			SICARD		
VOLVO			WATSON & CHALIN MFG. INC.			TRANSPORTATION MFG. CORP		
WESTERN UNIT "STABILAIRES" SUSP			85324		145054(2)	85701		145054(2)
85310		141108(1)	CHAMPION TRANSIT			CHEVROLET TRUCK		
KENWORTH			CHEVROLET TRUCK			FLXIBLE BUS		
OTTAWA TRUCK			GMC TRUCK			GMC TRUCK		
VOLVO			ISUZU			MOHAWK		
85311		141247(1)	85327		401754(2)	MOTOR COACH INDUSTRIES		
FLXIBLE BUS			FRUEHAUF			MUNCIE RECLAMATION		
INTERNATIONAL (NAVISTAR)			85329		401754(4)	NOVA BUS		
KENWORTH			PREVOST			ORION BUS INDUSTRIES		
PETERBILT			85330		145054(1)	PREVOST		
VOLVO			PREVOST			TRANSPORTATION MFG. CORP		
85312		141247(1)	85331		145054(1)	CHEVROLET TRUCK		
MOTOR COACH INDUSTRIES			PREVOST			FLXIBLE BUS		
TRANSPORTATION MFG. CORP						GMC TRUCK		

★ Will be available in first quarter of 2011.

NUMERICAL LISTING

LISTA NUMÉRICA

LISTE NUMÉRIQUE

GABRIEL #	APPLICATION	MTG. ACC PKG. NO.	GABRIEL #	APPLICATION	MTG. ACC PKG. NO.	GABRIEL #	APPLICATION	MTG. ACC PKG. NO.
85702	CHEVROLET TRUCK FLXIBLE BUS GMC TRUCK HAUSMAN MOHAWK MOTOR COACH INDUSTRIES MUNCIE RECLAMATION NOVA BUS PREVOST REYCO SUSPENSION RIDEWELL CORPORATION TRANSPORTATION MFG. CORP	401754(4)	85711 (Cont'd.)	MOTOR COACH INDUSTRIES NEW FLYER ORION BUS INDUSTRIES TRANSPORTATION MFG. CORP		85727	ABC BUS MOTOR COACH INDUSTRIES NEW FLYER	145140(2) & 405360(2)
85703	FLXIBLE BUS GRUMMAN BUS MOHAWK MUNCIE RECLAMATION	141247(1) & 401754(2)	85712	BLUEBIRD SCHOOL BUS CARPENTER BUS FLUIDRIVE FLXIBLE BUS GRANNING SUSPENSION HENDRICKSON TRAILER SUSPENSION MERITOR ORION BUS INDUSTRIES OSTERLUND TRUCK RAYDAN MANUFACTURING RIDEWELL CORPORATION SPARTAN MOTORS THOMAS SCHOOL BUS	401754(4)	85728	MOTOR COACH INDUSTRIES PREVOST	145140(2)
85704	CHEVROLET TRUCK FLXIBLE BUS GMC TRUCK GRUMMAN BUS MOHAWK MOTOR COACH INDUSTRIES MUNCIE RECLAMATION REYCO SUSPENSION RIDEWELL CORPORATION	401754(4)	85713	CARPENTER BUS CRANE CARRIER EAGLE MOTOR COACH MOTOR COACH INDUSTRIES MUNCIE RECLAMATION NOVA BUS PREVOST REYCO SUSPENSION THOMAS SCHOOL BUS TRANSPORTATION MFG. CORP	401754(4)	85729	ABC BUS MOTOR COACH INDUSTRIES ORION BUS INDUSTRIES PREVOST UNIVERSAL COACH	145054(1) & 401754(2)
85705	FLXIBLE BUS MUNCIE RECLAMATION NEOPLAN BUS	145090(2)	85714	MOHAWK ORION BUS INDUSTRIES	145093(1)	85730	FLXIBLE BUS	401754(4)
85706	HAUSMAN NEOPLAN BUS	145090(2)	85715	MOHAWK ORION BUS INDUSTRIES	145093(1)	85731	FLXIBLE BUS	145054(1) & 401754(2)
85707	FLXIBLE BUS MOHAWK MUNCIE RECLAMATION NEOPLAN BUS	145090(2)	85716	DINA BUS FLXIBLE BUS FORD GILLIG BROS. MAECO ORION BUS INDUSTRIES	145093(1)	85732	ABC BUS ORION BUS INDUSTRIES	145116(2)
85708	ABC BUS CHEVROLET TRUCK FLXIBLE BUS FLYER INDUSTRIES GILLIG BROS. GMC TRUCK M.A.N. BUS MOTOR COACH INDUSTRIES MUNCIE RECLAMATION NEW FLYER PREVOST VAN HOOL	145090(2)	85717	MOHAWK ORION BUS INDUSTRIES REYCO SUSPENSION	145093(1)	85733	ABC BUS CHEVROLET TRUCK EAGLE MOTOR COACH FLXIBLE BUS GMC TRUCK MOHAWK MOTOR COACH INDUSTRIES NOVA BUS TRANSPORTATION MFG. CORP	145089-000(1)
85709	M.A.N. BUS MUNCIE RECLAMATION	145090(2)	85718	FLXIBLE BUS MOHAWK ORION BUS INDUSTRIES	145093(1)	85734	BLUEBIRD SCHOOL BUS CHEVROLET TRUCK CROWN COACH FLXIBLE BUS GMC TRUCK INTERNATIONAL (NAVISTAR) LINK/HIGH-STEER OSHKOSH MOTORS RIDEWELL CORPORATION SAF HOLLAND SPARTAN MOTORS VOLVO	401754(4)
85710	CHEVROLET TRUCK FLXIBLE BUS GMC TRUCK MOTOR COACH INDUSTRIES MUNCIE RECLAMATION NEW FLYER NOVA BUS PREVOST TRANSPORTATION MFG. CORP	141247(1) & 401754(2)	85719	ORION BUS INDUSTRIES	145093(1)	85735	CHEVROLET TRUCK GMC TRUCK GREYHOUND BUS MOTOR COACH INDUSTRIES PACIFIC TRUCK & TRAILER VOLVO WESTERN UNIT "STABILAIRE" SUSP	401754(4)
85711	CHEVROLET TRUCK FLXIBLE BUS FLYER INDUSTRIES GMC TRUCK	141247(1) & 401754(2)	85720	ORION BUS INDUSTRIES OTTAWA TRUCK	401754(4)	85736	BLUEBIRD SCHOOL BUS FLXIBLE BUS MOHAWK PREVOST THOMAS SCHOOL BUS	401754(4)
			85722	FLYER INDUSTRIES M.A.N. BUS NEW FLYER VOLVO	145090(2)	85737	MERITOR	Not Req'd
			85723	GILLIG BROS. MUNCIE RECLAMATION	145075(1)	85738	EAST MANUFACTURING CORP. HENDRICKSON TRAILER SUSPENSION REYCO SUSPENSION	Not Req'd.
			85724	FREIGHTLINER STERLING TRUCK THOMAS SCHOOL BUS	Not Req'd.	85739	N INTERNATIONAL (NAVISTAR) MACK MERITOR RAYDAN MANUFACTURING	Not Req'd.

★ Will be available in first quarter of 2011.

NUMERICAL LISTING

LISTA NUMÉRICA

LISTE NUMÉRIQUE

GABRIEL #	APPLICATION	MTG. ACC PKG. NO.
★ 85740 N	145090(1) & 401754(2)	
MOTOR COACH INDUSTRIES		
85900	145054(2)	
FREIGHTLINER CUSTOM CHASSIS KENWORTH		
85901	401754(4)	
FREIGHTLINER RIDEWELL CORPORATION		
85902	145054(2)	
KENWORTH		
85903	Not Req'd.	
HENDRICKSON TRUCK SUSPENSION SYS		
85904	Not Req'd.	
FREIGHTLINER CUSTOM CHASSIS HENDRICKSON TRUCK SUSPENSION SYS LINK MANUFACTURING LTD. STERLING TRUCK		
85905	401754(4)	
SAF HOLLAND		
85906	Not Req'd.	
FORD KENWORTH MACK SAF HOLLAND VOLVO WESTERN STAR		
85907	Not Req'd.	
SAF HOLLAND		
85908	Not Req'd.	
SAF HOLLAND		
85909	Not Req'd.	
FORD KENWORTH MACK SAF HOLLAND		
85910	Not Req'd.	
BLUEBIRD SCHOOL BUS FREIGHTLINER PETERBILT SAF HOLLAND		
85911	Not Req'd.	
HENDRICKSON TRAILER SUSPENSION SAF HOLLAND		
85912	401754(2)	
SAF HOLLAND		
85913	401754(2)	
RED LION TRAILER SAF HOLLAND		
85914	Not Req'd.	
BLUEBIRD SCHOOL BUS SAF HOLLAND		
85916	Not Req'd.	
SAF HOLLAND		
85918	Not Req'd.	
FREIGHTLINER THOMAS SCHOOL BUS		
85919	Not Req'd.	
BLUEBIRD SCHOOL BUS FREIGHTLINER FREIGHTLINER CUSTOM CHASSIS GREAT DANE TRAILER HENDRICKSON TRUCK SUSPENSION SYS MERITOR WABASH NATIONAL WORKHORSE		

GABRIEL #	APPLICATION	MTG. ACC PKG. NO.
85920	Not Req'd.	
FREIGHTLINER STERLING TRUCK		
85921	145054(1)	
FREIGHTLINER		
85923	Not Req'd.	
INTERNATIONAL (NAVISTAR)		
85924	Not Req'd.	
INTERNATIONAL (NAVISTAR)		
85925	Not Req'd.	
INTERNATIONAL (NAVISTAR)		
85926	Not Req'd.	
FORD INTERNATIONAL (NAVISTAR) STERLING TRUCK		
85927	Not Req'd.	
FORD INTERNATIONAL (NAVISTAR)		
85929	Not Req'd.	
INTERNATIONAL (NAVISTAR)		
85930	Not Req'd.	
INTERNATIONAL (NAVISTAR)		
85931	Not Req'd.	
INTERNATIONAL (NAVISTAR)		
85932	Not Req'd.	
FREIGHTLINER HENDRICKSON TRUCK SUSPENSION SYS WESTERN STAR		
85933	Not Req'd.	
HENDRICKSON TRUCK SUSPENSION SYS MACK VOLVO		
85934	Not Req'd.	
MAECO RIDEWELL CORPORATION WATSON & CHALIN MFG. INC.		
85935	145090(1)	
INTERNATIONAL (NAVISTAR)		
85936	145089-200(1)	
KENWORTH		
85937	145089-200(1)	
KENWORTH		
85938	Not Req'd.	
GREAT DANE TRAILER HENDRICKSON TRAILER SUSPENSION REYCO SUSPENSION WATSON & CHALIN MFG. INC.		
85939	Not Req'd.	
HENDRICKSON TRAILER SUSPENSION TIMBREN INDUSTRIES		
85953 N	Not Req'd.	
INTERNATIONAL (NAVISTAR)		
85954 N	Not Req'd.	
INTERNATIONAL (NAVISTAR)		
85955 N	Not Req'd.	
HENDRICKSON TRUCK SUSPENSION SYS INTERNATIONAL (NAVISTAR)		
85956 N	Not Req'd.	
FREIGHTLINER WESTERN STAR		
85957 N	Not Req'd.	
FORD INTERNATIONAL (NAVISTAR) STERLING TRUCK		

GABRIEL #	APPLICATION	MTG. ACC PKG. NO.
85958 N	Not Req'd.	
FREIGHTLINER WESTERN STAR		
85959 N	Not Req'd.	
FREIGHTLINER FREIGHTLINER CUSTOM CHASSIS PETERBILT STERLING TRUCK		
85961 N	Not Req'd.	
HENDRICKSON TRUCK SUSPENSION SYS		
85962 N	Not Req'd.	
HENDRICKSON TRUCK SUSPENSION SYS		
85963 N	Not Req'd.	
INTERNATIONAL (NAVISTAR)		
85964 N	Not Req'd.	
INTERNATIONAL (NAVISTAR)		
★ 85965 N	Not Req'd.	
HENDRICKSON TRUCK SUSPENSION SYS		
★ 85966 N	Not Req'd.	
HENDRICKSON TRUCK SUSPENSION SYS		
★ 85967 N	Not Req'd.	
HENDRICKSON TRUCK SUSPENSION SYS		
★ 85968 N	401754(4)	
GILLIG BROS. SAF HOLLAND		
★ 85969 N	Not Req'd.	
INTERNATIONAL (NAVISTAR)		
★ 85970 N	145089-000(1)	
MOTOR COACH INDUSTRIES		
87015	Not Req'd.	
EAST MANUFACTURING CORP. MERITOR		
★ 87016 N	145116(1) & 145090(1)	
ORION BUS INDUSTRIES		
★ 87017 N	Not Req'd.	
OPTIMA BUS CORP RIDEWELL CORPORATION		

GasSLX

89401	140149(1)	
FORD MAECO STERLING TRUCK		
89402	140149(1)	
BLUEBIRD SCHOOL BUS FORD STERLING TRUCK		
89403	140149(1)	
FORD		
89405	Not Req'd.	
FORD GILLIG BROS. HENDRICKSON TRUCK SUSPENSION SYS INTERNATIONAL (NAVISTAR) KENWORTH MACK MARMON PETERBILT		

★ Will be available in first quarter of 2011.

NUMERICAL LISTING

LISTA NUMÉRICA

LISTE NUMÉRIQUE

GABRIEL #	APPLICATION	MTG. ACC PKG. NO.	GABRIEL #	APPLICATION	MTG. ACC PKG. NO.	GABRIEL #	APPLICATION	MTG. ACC PKG. NO.
89405(Cont'd.)	REYCO SUSPENSION SAF HOLLAND VOLVO WATSON & CHALIN MFG. INC.		89411	INTERNATIONAL (NAVISTAR) MARMON REYCO SUSPENSION VOLVO	Not Req'd.	89420	AM GENERAL CHEVROLET TRUCK CRANE CARRIER DINA BUS FORD FREIGHTLINER FWD TRUCK GILLIG BROS. GMC TRUCK MACK MAECO MOTOR COACH INDUSTRIES PETERBILT RIDEWELL CORPORATION VOLVO	401754(4)
89406	ALLCO TRAILER CHEVROLET TRUCK COUNTRY COACH FORD FREIGHTLINER FRUEHAUF GILLIG BROS. GMC TRUCK GREAT DANE TRAILER HENDRICKSON TRUCK SUSPENSION SYS ISUZU LODAL, INC. MACK MAECO MARMON OSHKOSH MOTORS REYCO SUSPENSION SAF HOLLAND VOLVO VOLVO-AUTOCAR WESTERN STAR	Not Req'd.	89412	FREIGHTLINER KENWORTH MACK VOLVO	401754(4)	89422	ACF BRILL BUS BROCKWAY SCHOOL BUS BUS & TRUCK CO. CHEVROLET TRUCK CONTINENTAL TRAILWAYS-EAGLE INT'L CRANE CARRIER CROWN COACH EAGLE MOTOR COACH FREIGHTLINER GMC TRUCK GREYHOUND BUS HENDRICKSON TRUCK SUSPENSION SYS INTERNATIONAL (NAVISTAR) MACK MAECO MATSON SCHOOL BUS MOHAWK MOTOR COACH INDUSTRIES ORION BUS INDUSTRIES OSHKOSH MOTORS OTTAWA TRUCK PETERBILT PREVOST THOMAS SCHOOL BUS TRANSPORTATION MFG. CORP VOLVO WESTERN STAR WESTERN UNIT "STABILAIRE" SUSP	401754(4)
89407	BENSON TRUCK BODIES INC. BLUEBIRD SCHOOL BUS BROCKWAY SCHOOL BUS CHANCE BUS CHEVROLET TRUCK DURA SUSPENSION EAST MANUFACTURING CORP. FORD GILLIG BROS. GMC TRUCK GREAT DANE TRAILER HARDEE MFG HENDRICKSON TRUCK SUSPENSION SYS HIGHWAY PRODUCT INTERNATIONAL (NAVISTAR) KENWORTH MACK MAECO MOHAWK NATIONAL COACH CORP OSHKOSH MOTORS REYCO SUSPENSION RIDEWELL CORPORATION SAF HOLLAND TRAILMOBILE CANADA CORP. TWIN COACH VOLVO WABASH NATIONAL	Not Req'd.	89413	BLUEBIRD SCHOOL BUS BROCKWAY SCHOOL BUS CHEVROLET TRUCK FORD GMC TRUCK INTERNATIONAL (NAVISTAR) ISUZU PETERBILT VOLVO	145080(2)	89423	KENWORTH OTTAWA TRUCK VOLVO	141108(1)
89408	PETERBILT	145080(2)	89414	BLUEBIRD SCHOOL BUS CHEVROLET TRUCK COUNTRY COACH FORD GMC TRUCK HENDRICKSON TRAILER SUSPENSION HENDRICKSON TRUCK SUSPENSION SYS INTERNATIONAL (NAVISTAR) MACK MAECO PETERBILT REYCO SUSPENSION SAF HOLLAND SPARTAN MOTORS STERLING TRUCK TRAILMOBILE CANADA CORP. VOLVO WESTERN STAR	Not Req'd.	89424	FLXIBLE BUS INTERNATIONAL (NAVISTAR) KENWORTH PETERBILT VOLVO	141247(1)
89409	FORD KENWORTH OSHKOSH MOTORS PIERCE MANUFACTURING INC. VOLVO	140149(1)	89415	VOLVO	140149(1)	89425	CHALMERS SUSPENSION EAGLE MOTOR COACH FORD KENWORTH MAECO STERLING TRUCK VOLVO	401754(4)
89410	FORD KENWORTH MACK MAECO REYCO SUSPENSION STERLING TRUCK VOLVO	401754(4)	89416	VOLVO VOLVO-AUTOCAR	140149(1)	89426	INTERNATIONAL (NAVISTAR) MAECO OSHKOSH MOTORS PIERCE MANUFACTURING INC.	145090(1)
			89417	VOLVO VOLVO-AUTOCAR	145054(1)	89427	PETERBILT	145099(1)
			89418	INTERNATIONAL (NAVISTAR) VOLVO VOLVO-AUTOCAR	145054(2)			
			89419	CHEVROLET TRUCK FREIGHTLINER FRUEHAUF GMC TRUCK GRANNING SUSPENSION HOBBS TRAILERS INTERNATIONAL (NAVISTAR) MUNCIE RECLAMATION OSHKOSH MOTORS OSTERLUND TRUCK OTTAWA TRUCK PIERCE MANUFACTURING INC. REYCO SUSPENSION SAF HOLLAND VOLVO WABASH NATIONAL WATSON & CHALIN MFG. INC. WESTERN UNIT "STABILAIRE" SUSP	401754(4)			

★ Will be available in first quarter of 2011.

NUMERICAL LISTING

LISTA NUMÉRICA

LISTE NUMÉRIQUE

GABRIEL #	APPLICATION	MTG. ACC PKG. NO.
89428		145089-000(1)
	FREIGHTLINER VOLVO	
89429		401754(4)
	FREIGHTLINER MAECO	
89430		Not Req'd.
	BLUEBIRD SCHOOL BUS CHEVROLET TRUCK EAST MANUFACTURING CORP. FORD FREIGHTLINER FREIGHTLINER CUSTOM CHASSIS GMC TRUCK HENDRICKSON TRAILER SUSPENSION HENDRICKSON TRUCK SUSPENSION SYS HINO INTERNATIONAL (NAVISTAR) MACK OSHKOSH MOTORS REYCO SUSPENSION RIDEWELL CORPORATION SAF HOLLAND VOLVO VOLVO-AUTOCAR WABASH NATIONAL WATSON & CHALIN MFG. INC.	
89431		Not Req'd.
	FREIGHTLINER FREIGHTLINER CUSTOM CHASSIS INTERNATIONAL (NAVISTAR) OSHKOSH MOTORS PIERCE MANUFACTURING INC.	
89432		Not Req'd.
	BLUEBIRD SCHOOL BUS MAECO	
89434		140149(1)
	VOLVO VOLVO-AUTOCAR	
89435		140149(1)
	FORD STERLING TRUCK VOLVO	
89436		Not Req'd.
	BENSON TRUCK BODIES INC. CHANCE BUS CHEVROLET TRUCK DURA SUSPENSION EAST MANUFACTURING CORP. FREIGHTLINER FRUEHAUF GMC TRUCK GREAT DANE TRAILER MERITOR	

GABRIEL #	APPLICATION	MTG. ACC PKG. NO.
89437		Not Req'd.
	EAST MANUFACTURING CORP. HENDRICKSON TRAILER SUSPENSION THOMAS SCHOOL BUS	
89438		145080(2)
	FORD STERLING TRUCK	
89439		145080(2)
	FORD STERLING TRUCK	
89440		Not Req'd.
	BLUEBIRD SCHOOL BUS EAST MANUFACTURING CORP. FORD FRUEHAUF HENDRICKSON TRAILER SUSPENSION HENDRICKSON TRUCK SUSPENSION SYS INTERNATIONAL (NAVISTAR) KENWORTH MAECO OSHKOSH MOTORS PACIFIC TRUCK & TRAILER PIERCE MANUFACTURING INC. REYCO SUSPENSION SAF HOLLAND STERLING TRUCK VOLVO WABASH NATIONAL	
89441		145054(1)
	FORD KENWORTH SAF HOLLAND	
89442		145126(2)
	WESTERN STAR FREIGHTLINER STERLING TRUCK THOMAS SCHOOL BUS	
89443		Not Req'd.
	HENDRICKSON TRAILER SUSPENSION HIGHWAY PRODUCT HUTCHENS SUSPENSION MACK MOHAWK ORION BUS INDUSTRIES PAGE SUSPENSION PETERBILT REYCO SUSPENSION RIDEWELL CORPORATION SAF HOLLAND STOUGHTON TRAILERS INC. THOMAS SCHOOL BUS TRAILMOBILE CANADA CORP. TWIN COACH VOLVO WABASH NATIONAL WATSON & CHALIN MFG. INC.	

GABRIEL #	APPLICATION	MTG. ACC PKG. NO.
89446		401011(4)
	FORD INTERNATIONAL (NAVISTAR) STERLING TRUCK VOLVO	
89447		141108(1)
	BLUEBIRD SCHOOL BUS FLXIBLE BUS INTERNATIONAL (NAVISTAR) MITSUBISHI-FUSO MUNCIE RECLAMATION NEOPLAN BUS VOLVO	
89448		Not Req'd.
	MACK VOLVO	
89449		Not Req'd.
	FREIGHTLINER THOMAS SCHOOL BUS	
89450		Not Req'd.
	MACK VOLVO	
89451		Not Req'd.
	KENWORTH PETERBILT	
89453		Not Req'd.
	FREIGHTLINER HENDRICKSON TRUCK SUSPENSION SYS WESTERN STAR	
89454		Not Req'd.
	HENDRICKSON TRUCK SUSPENSION SYS MACK VOLVO	
89455		141108(1)
	KENWORTH PETERBILT	
89456		145089-200(1)
	KENWORTH	
89457	N	Not Req'd.
	INTERNATIONAL (NAVISTAR)	
89458	N	Not Req'd.
	INTERNATIONAL (NAVISTAR)	
★ 89459	N	401754(2)
	KENWORTH	
★ 89460	N	Not Req'd.
	KENWORTH	

★ Will be available in first quarter of 2011.

Competitive Interchange List

Piezas de substitución de competidores

Articles concurrents

ARALMEX

Aralmex	Gabriel	Upgrade	Aralmex	Gabriel	Upgrade	Aralmex	Gabriel	Upgrade	Aralmex	Gabriel	Upgrade
2AMG037	G60076		3AMG007	G60015		3AMG023	G60049		3AMG031	G60043	
3AMG001	G60014		3AMG008	G60114		3AMG026	G60080		3AMG032	G60120	
3AMG004	G60021		3AMG009	G60007		3AMG027	G60062		3AMG033	G60171	
3AMG005	G60017		3AMG021	G60035		3AMG029	G60097		3AMG034	G60162	
3AMG006	G60042		3AMG022	G60077		3AMG030	G61159		3AMG035	G60161	

BILSTEIN

Bilstein	Gabriel	Upgrade	Bilstein	Gabriel	Upgrade	Bilstein	Gabriel	Upgrade	Bilstein	Gabriel	Upgrade
B46-1594	85013	89414	B46-1725	85029		B46-2151	85007	89412			

BOGE

Boge	Gabriel	Upgrade	Boge	Gabriel	Upgrade	Boge	Gabriel	Upgrade	Boge	Gabriel	Upgrade
40-A85-0	85708										

COFAP

Cofap	Gabriel	Upgrade	Cofap	Gabriel	Upgrade	Cofap	Gabriel	Upgrade	Cofap	Gabriel	Upgrade
45011	85702		ATG-051	G60062		ATG-085	G60161		L-12703	85071	
8482	85026	89417	ATG-081	G60120		L-12039	85065		L-12706	83155	
ATG-046	G60078		ATG-084	G60162		L-12687	83030		L-12713	83136	

DELCO

Delco	Gabriel	Upgrade	Delco	Gabriel	Upgrade	Delco	Gabriel	Upgrade	Delco	Gabriel	Upgrade
501-13	83318		507-24	85336		508-28	83207	89407	508-70	G60041	
501-74	83304		508-3	83400		508-29	85030	89440		G60026	
501-75	83303		508-5	G60043		508-30	85005	89430	508-71	G60046	
507-1	85304			G60017		508-35	G60045			83314	
507-2	85302	89420	508-9	85000	89436		G60021		508-72	G60023	
507-3	85307		508-13	83219		508-39	G60008		508-74	G60129	
507-4	85303	89422		85012	89413	508-42	G60012			G60024	
507-5	85308	89422	508-14	83216			G60029		508-78	83400	
507-6	85314	89425		85012	89413	508-47	G60011		508-79	G60052	
	85305		508-15	83216			G60042		508-80	G60053	
507-7	85301		508-16	83308	89435	508-48	G60063		508-82	G60033	
507-8	85301		508-17	83312	89409		G60035		508-87	85071	
507-9	85700		508-18	83309	89446	508-50	G60308		508-89	83155	
507-10	85711		508-19	83314			G60003		508-90	83136	
507-11	85308	89422	508-20	83207	89407	508-52	G60075		550-13	85005	89430
507-12	85701		508-21	83214			G60031		550-73	83303	
507-13	85704		508-22	83217			G60101			85005	89430
507-15	85703		508-23	83225		508-56	G60119		550-74	83304	
507-16	85702			83217		508-57	83123	89405	550-75	83303	
507-17	85304		508-24	83215		508-59	G60028		550-77	83221	
507-18	85305		508-26	83203	89436	508-68	83209	89414			
507-19	85700			85030			85006				

Important Note: Competitive Interchanges are to be used for stocking purposes only. **Where multiple crosses are identified, please reference the applications section of this catalog.** / **Remarque importante:** Les interchanges concurrentiels ne s'utilisent qu'aux fins de stocks. **Dans le cas de références multiples, consulter la section des applications du catalogue.** / **Nota importante:** Se pueden usar intercambios competitivos para propósitos de almacenamiento solamente. **Cuando se identifican intercambios múltiples, consulte la sección de aplicaciones de este catálogo.**

Competitive Interchange List

Piezas de sustitución de competidores

Articles concurrents

FLEETRITE

Fleetrite	Gabriel	Upgrade	Fleetrite	Gabriel	Upgrade	Fleetrite	Gabriel	Upgrade	Fleetrite	Gabriel	Upgrade
AMS600101	85003	89411	AMS600163	83101		AMS650412	83122	89406	AMS650466	85047	89435
AMS600102	85005	89430	AMS600164	83613		AMS650415	85046	89434	AMS650468	85069	89455
AMS600103	85014		AMS600165	83636		AMS650416	85323	89436	AMS650471	85302	89420
AMS600104	85000	89436	AMS600166	85052		AMS650417	85322		AMS650472	85330	
AMS600105	83304		AMS600167	83128		AMS650418	85906		AMS650473	85329	
AMS600106	83312	89409	AMS600168	83635		AMS650419	85000	89436	AMS650474	85712	
AMS600107	83309	89446	AMS600169	85051		AMS650420	85013	89414	AMS650475	85065	
AMS600108	83209	89414	AMS600172	85005	89430	AMS650421	85916		AMS650478	85030	89440
AMS600109	83217		AMS600173	85043		AMS650422	85912		AMS650479	83122	89406
AMS600110	83303		AMS600174	83125		AMS650423	85907		AMS650480	83109	
AMS600111	83301		AMS650101	85062	89408	AMS650424	85905			83111	
AMS600112	83456	89447	AMS650102	85001	89410	AMS650425	89441		AMS650481	83123	89405
AMS600113	83215		AMS650103	85320	89429	AMS650426	85054	89438	AMS650482	85006	
AMS600114	83125		AMS650105	85026	89417	AMS650427	85903		AMS650486	85066	89448
AMS600116	83216		AMS650107	85316	89426	AMS650428	85321		AMS660102	85005	89430
AMS600117	83308	89435	AMS650108	85030	89432	AMS650429	85030		AMS660103	85014	
AMS600118	83219		AMS650109	85058	89431	AMS650430	85712		AMS660104	85000	89436
AMS600119	83314		AMS650110	85005	89430	AMS650431	85909		AMS660105	83304	
AMS600120	G60119		AMS650111	85006		AMS650432	85910		AMS660106	83312	89409
AMS600123	G60028		AMS650112	89402		AMS650433	85910		AMS660107	83309	89446
AMS600125	83123	89405	AMS650113	85012	89413	AMS650434	85012	89413	AMS660108	83209	89414
AMS600126	83400		AMS650114	85006		AMS650435	85901		AMS660109	83217	
AMS600128	83401		AMS650115	85027	89418	AMS650436	85900		AMS660110	83303	
AMS600129	83317		AMS650116	85303	89422	AMS650439	85718		AMS660111	83301	
AMS600130	83204		AMS650118	83215		AMS650440	85711		AMS660112	83456	89447
AMS600131	83318		AMS650119	85029		AMS650441	85704		AMS660113	83215	
AMS600132	83215		AMS650120	85010		AMS650442	85700		AMS660114	85006	
AMS600133	83362		AMS650121	89432		AMS650443	85706		AMS660116	83216	
AMS600134	83221		AMS650122	85063		AMS650444	85311	89424	AMS660117	83308	89435
AMS600136	83353		AMS650123	85054	89438	AMS650445	85731		AMS660118	85012	89413
AMS600138	83100		AMS650124	85053	89442	AMS650446	85730		AMS660119	83314	
AMS600142	83209	89414	AMS650128	85031		AMS650447	85703		AMS660123	G60028	
AMS600145	85040		AMS650129	85701		AMS650448	85700		AMS660125	83123	89405
AMS600146	83105		AMS650130	85061	89450	AMS650449	85702		AMS660126	83400	
AMS600147	83216		AMS650139	85918	89449	AMS650451	85029		AMS660128	83401	
AMS600148	85026	89417	AMS650400	85033	89427	AMS650452	85733		AMS660129	83317	
AMS600149	83217		AMS650401	85013	89414	AMS650453	85904		AMS660130	83204	
AMS600150	85009		AMS650402	85311	89424	AMS650454	85713		AMS660131	83318	
AMS600151	85024	89416	AMS650404	85310	89423	AMS650455	85716		AMS660132	83215	
AMS600152	83242		AMS650405	85023	89415	AMS650456	85376		AMS660133	83362	
AMS600153	85003	89411	AMS650406	85024	89416	AMS650458	85908		AMS660134	83221	
AMS600154	83104		AMS650407	85736		AMS650459	85043		AMS660136	83353	
AMS600155	83103		AMS650408	85319	89428	AMS650462	85913		AMS660138	83100	
AMS600156	83103		AMS650409	85003	89411	AMS650463	85040		AMS660142	83209	89414
AMS600157	83221		AMS650410	85300	89419	AMS650464	85716		AMS660145	85040	
AMS600162	83103		AMS650411	85036	89405	AMS650465	85914		AMS660146	83105	

Important Note: Competitive Interchanges are to be used for stocking purposes only. Where multiple crosses are identified, please reference the applications section of this catalog. / **Remarque importante:** Les interchanges concurrentiels ne s'utilisent qu'aux fins de stocks. Dans le cas de références multiples, consulter la section des applications du catalogue. / **Nota importante:** Se pueden usar intercambios competitivos para propósitos de almacenamiento solamente. Cuando se identifican intercambios múltiples, consulte la sección de aplicaciones de este catálogo.

Competitive Interchange List

Piezas de substitución de competidores

Articles concurrents

FLEETRITE ... cont'd

Fleetrite	Gabriel	Upgrade	Fleetrite	Gabriel	Upgrade	Fleetrite	Gabriel	Upgrade	Fleetrite	Gabriel	Upgrade
AMS660147	83216		AMS660193	83001		AMS660244	83125		AMS700408	85704	
AMS660148	85026	89417	AMS660194	83207	89407		85006		AMS700410	85314	89425
AMS660149	85042		AMS660195	83130		AMS660247	83116		AMS700411	85703	
AMS660150	G60177		AMS660196	G60164			83118		AMS700413	85705	
AMS660153	85003	89411	AMS660198	83007		AMS660248	83117		AMS700414	85723	
AMS660154	83104		AMS660200	83008		AMS660502	646155		AMS700415	85318	
AMS660157	85030	89440	AMS660201	83308	89435	AMS660504	632147		AMS700416	85709	
AMS660160	83114		AMS660202	83009		AMS700101	85308	89422	AMS700418	85003	89411
AMS660161	G60164		AMS660203	83112		AMS700102	85303	89422	AMS700419	85708	
AMS660162	83103		AMS660204	83010		AMS700103	85302	89420	AMS700420	85733	
AMS660164	83613		AMS660205	83003		AMS700104	85304		AMS700421	85712	
AMS660165	83636		AMS660208	G60177		AMS700105	85314	89425	AMS700422	85308	89422
AMS660166	85052		AMS660209	83014		AMS700106	85301		AMS700423	85724	89443
AMS660167	83128		AMS660211	83110		AMS700107	85307		AMS700424	85333	
AMS660168	83635		AMS660212	83015		AMS700108	85315		AMS74421	85708	
AMS660169	85051		AMS660213	85009		AMS700111	85320	89429	AMS85722	83400	
AMS660170	83016		AMS660214	83002		AMS700112	85722		AMS85736	G60113	
AMS660171	83017		AMS660215	85059		AMS700113	85736		AMS85768	83209	89414
AMS660172	83126	89430	AMS660216	83123	89405	AMS700114	85701		AMS85802	83216	
AMS660173	85043		AMS660218	83137		AMS700115	85712		AMS85803	G60021	
AMS660174	83125		AMS660219	83215		AMS700116	83136		AMS85821	G60007	
AMS660175	83120		AMS660220	83109		AMS700117	85324		AMS85853	G60028	
AMS660176	83018		AMS660223	85055	89439	AMS700119	85336		AMS85895	83207	89407
AMS660177	83019		AMS660224	83111		AMS700120	85332		AMS85900	G60023	
AMS660182	83004		AMS660225	83200		AMS700121	83136		AMS85901	G60024	
AMS660183	85012	89413	AMS660232	83114		AMS700401	85700		AMS85904	G60003	
AMS660187	85071		AMS660233	83023		AMS700402	85310	89423	AMS85905	G60031	
AMS660188	85045		AMS660234	83013		AMS700403	85702		AMS85909	G60046	
AMS660189	83136		AMS660236	83025		AMS700404	85311	89424	AMS85932	G60046	
AMS660190	83107		AMS660237	83005		AMS700405	85300	89419	AMS85960	G60044	
AMS660191	83216		AMS660238	83101		AMS700406	85711				
AMS660192	85001	89410				AMS700407	85712				

KONI

Koni	Gabriel	Upgrade	Koni	Gabriel	Upgrade	Koni	Gabriel	Upgrade	Koni	Gabriel	Upgrade
30-1348	G60052		30-1456	G61122		30-1607	G60050		82-1952	G60008	
	G60264			G61122		30-1614	G60221		82-1954	G60014	
30-1350	G60129		30-1457	G61121		30-1624	G60052		82-1955	G60010	
30-1351	G60099			G61121		30-1627	G60233		82-1969	G60114	
30-1365	G60165		30-1501	G60162		30-1630	G60053		82-1970	G60011	
30-1366	G60164		30-1502	G60161			G60265		82-2158	G60015	
30-1381	G60062			G60222		80-2516	G60049		82-2345	G60039	
30-1421	G60153		30-1565	G60250		80-2517	G60050		82-2372	G60163	
30-1422	G60154		30-1566	G60251		80-2633	G60051			G61159	
			30-1606	G60051		80-2634	G60050				

Important Note: Competitive Interchanges are to be used for stocking purposes only. **Where multiple crosses are identified, please reference the applications section of this catalog.** / **Remarque importante:** Les interchanges concurrentiels ne s'utilisent qu'aux fins de stocks. **Dans le cas de références multiples, consulter la section des applications du catalogue.** / **Nota importante:** Se pueden usar intercambios competitivos para propósitos de almacenamiento solamente. **Cuando se identifican intercambios múltiples, consulte la sección de aplicaciones de este catálogo.**

Competitive Interchange List

Piezas de sustitución de competidores

Articles concurrents

KONI ... cont'd

Koni	Gabriel	Upgrade	Koni	Gabriel	Upgrade	Koni	Gabriel	Upgrade	Koni	Gabriel	Upgrade
82-2384	G60097		88-1558	85013	89414	90-1896	85302	89420	90-2257	85716	
	G60196		88-1559-SP1	85036	89405	90-1897	85303	89422	90-2325	★85340	
8240-1029	G60023		88-1560	85062	89408	90-1898	83215		90-2326	★85970	
8240-1054	G60076		88-1561	85012	89413	90-1907-SP1	85300	89419	90-2327	★85341	
8240-1055	G60077		88-1562	85003	89411	90-1908-SP1	85723		90-2423	85723	
8240-1148	G60263		88-1616	85014		90-1909	85318		90-2433	85710	
8805-1022	85724	89443	88-1639	83130		90-1910	85704		90-2434	85702	
88-1385	83105		88-1641	85029		90-1912	85318		90-2477	85900	
88-1417	83312	89409	88-1642	83124	89407	90-1943	85307		90-2478	85902	
88-1419	83136		88-1644	85000	89436	90-1951-SP1	85734		90-2529	85707	
88-1422	85030	89440	88-1646	83613		90-1951-SP5	85712		90-2530	85707	
88-1457-SP1	83209	89414	88-1647	83317		90-1965	85304		90-2563	85006	
88-1458-SP1	83122	89406	88-5162	83209	89414	90-1968	85720		90-2572	85329	
88-1458-SP2	83122	89406	90-1400	83104		90-1974	85311	89424	90-2573	85329	
88-1476	83353		90-1409-SP1	85722		9020-1042	85708		90-2574	85330	
88-1489	85036	89405	90-1466	85707		90-2102-SP1	85708		90-2575	85700	
88-1490	83124	89407	90-1577-SP1	85310	89423	90-2148	85304		90-2576	85700	
88-1499	85001	89410	90-1608	83104		90-2164-SP1	85723		90-2586	85728	
88-1509	85027	89418	90-1811	85301		90-2209	85001	89410	90-2587	85729	
88-1510	85708		90-1813-SP1	85712		90-2251	85717		90-2588	85339	
88-1517	85040		90-1813-SP3	85968		90-2252	85714		90-2589	85727	
88-1518	85040		90-1862	85708		90-2253-SP2	85718		90-2610-SP1	★87017	
88-1520	85040		90-1867	85053	89442	90-2254	85720		90-5055-SP2	85318	
88-1532	85708		90-1868	85307		90-2255	85719		90-5180	85300	89419
88-1540	85051		90-1868-SP1	85307		90-2256	85718		90F-1235	85700	
88-1541	85045										

KYB

KYB	Gabriel	Upgrade	KYB	Gabriel	Upgrade	KYB	Gabriel	Upgrade	KYB	Gabriel	Upgrade
340043	G60310		344040	G60049		344054	G60070		344076	G60033	
341302	G60221		344041	G60050			G60105			G60072	
341312	G61865		344042	G60051		344055	G60087		344077	G00007	
341339	G61918		344043	G60303		344066	G60017			G60035	
341343	G61893			G61154			G60043			G60066	
341374	G61884		344044	G60096		344067	G60008		344078	G60186	
343030	G60353			G60308			G60064			G60226	
343127	G60301		344045	G60075			G60112		344079	G60084	
343160	G60312			G60101			G60309			G60143	
343209	G60304		344046	G60100		344068	G60014			G61115	
343210	G61140		344047	G60354			G60015			G61149	
343272	G61860		344049	G60038			G60214		344080	G60062	
343353	G61880			G60158		344069	G60114			G60233	
343379	G61180		344050	G60063		344072	G60010		344081	G60074	
343388	G60255			G60144			G60065			G60076	
343395	G61175			G61113		344074	G60028		344082	G60077	
	G62014		344051	G60048			G61152		344083	G60078	
343403	G60204			G60081		344075	G60039				

Important Note: Competitive Interchanges are to be used for stocking purposes only. Where multiple crosses are identified, please reference the applications section of this catalog. / **Remarque importante:** Les interchanges concurrentiels ne s'utilisent qu'aux fins de stocks. Dans le cas de références multiples, consulter la section des applications du catalogue. / **Nota importante:** Se pueden usar intercambios competitivos para propósitos de almacenamiento solamente. Cuando se identifican intercambios múltiples, consulte la sección de aplicaciones de este catálogo.

★ Will be available in first quarter of 2011.

Competitive Interchange List

Piezas de substitución de competidores

Articles concurrents

KYB ... cont'd

KYB	Gabriel	Upgrade	KYB	Gabriel	Upgrade	KYB	Gabriel	Upgrade	KYB	Gabriel	Upgrade
344084	G60099		344365	G60206		345022	G61173		KG5438	G60075	
	G60120		344366	G60044		345023	G61169			G60101	
344085	G60021		344367	G60257		345024	G61864		KG5440	G60011	
	G60031		344368	G60259		345030	G60113		KG5442	G60186	
	G60042			G60260			G60185		KG5444	G60169	
344086	G60012		344369	G60184		345042	G61883			G60305	
	G60029		344370	G60182		345043	G61878		KG5446	G60310	
344088	G60052			G60330		345055	G61872		KG5447	G60100	
344089	G60053		344371	G60183		349004	G61886		KG5455	G60081	
344090	G60101		344372	G60205		349009	G61897		KG5456	G60041	
344091	G60129		344373	G60218			G61919		KG5462	G60103	
344092	G60099		344374	G61118		349010	G62006			G60128	
344093	G60306		344375	G60258			G62007		KG5466	G60101	
	G61881		344377	G60260		553360	G60338			G60329	
344094	G60313		344380	G61124		553361	G60232		KG5474	G60086	
344095	G60110		344381	G61144		554347	G61886			G60153	
344096	G60083		344382	G61887		GK5534	G60164		KG5475	G60091	
344098	G60104		344385	G61866		KG4159	G61892			G60154	
	G60169		344387	G60179		KG4160	G62016		KG5476	G60165	
344202	G60086			G60235		KG4613A	G60104			G60310	
	G60153		344397	G61112			G60310		KG5477	G60307	
344263	G60097		344398	G61958		KG4616	G61139		KG5478	G60098	
	G61898		344399	G61182		KG5194	G62000		KG5479	G60097	
344264	G60024		344401	G61970		KG5196	G62013		KG5480	G60163	
344265	G60098		344402	G61158		KG5198A	G60160			G61159	
344266	G60163		344404	G61178		KG5401	G60003		KG5482	G60218	
	G61159		344410	G61885		KG5406	G60023		KG5484	G60194	
344267	G60080		344419	G61888		KG5417	G60045		KG5485	G60197	
	G62002			G62010		KG5420	G60044		KG5487	G60144	
344268	G60162		344426	G60003		KG5421	G60024		KG5488	G60111	
	G60171		344427	G60305		KG5424	G60002		KG5489	G60171	
344269	G60161		344428	G60103		KG5426	G60026			G60171	
	G60222			G60128		KG5429	G60046		KG5491	G60152	
344272	G60023			G62004		KG54300	G60176		KG5494	G60180	
344273	G60196			G62005		KG54301	G60177		KG5495	G60330	
	G61896		344430	G60104		KG54302	G61122			G60330	
344291	G60219			G60165		KG54303	G61121		KG5496	G60184	
	G61873			G60310		KG54304	G60250		KG5497	G60182	
344299	G60253		344431	G60180		KG54305	G60199		KG5498	G60183	
344338	G61116		344435	G60264		KG54307	G61153		KG5499	G60181	
344341	G61204			G60265		KG54308	G60251		KG5534	G60164	
344342	G61170		344438	G61868		KG5431	G60129			G60164	
344353	G61877			G61869		KG54317	G60269		KG5538	G60087	
	G62003		344464	G61882		KG54330	G61150		KG5555	G60312	
344356	G61862		344466	G61879		KG54331	G61177		KG6403	G60119	
344359	G60263		344481	G61894		KG54333	G61151		KG6412	G60185	
344364	G60216		344496	G62012		KG54335	G61156				
	G60217		345005	G60237							

Important Note: Competitive Interchanges are to be used for stocking purposes only. **Where multiple crosses are identified, please reference the applications section of this catalog.** / **Remarque importante:** Les interchanges concurrentiels ne s'utilisent qu'aux fins de stocks. **Dans le cas de références multiples, consulter la section des applications du catalogue.** / **Nota importante:** Se pueden usar intercambios competitivos para propósitos de almacenamiento solamente. **Cuando se identifican intercambios múltiples, consulte la sección de aplicaciones de este catálogo.**

Competitive Interchange List

Piezas de sustitución de competidores

Articles concurrents

MONROE

Monroe	Gabriel	Upgrade	Monroe	Gabriel	Upgrade	Monroe	Gabriel	Upgrade	Monroe	Gabriel	Upgrade
12872	83219		34822	G60045		37026	G60264		37069	G60110	
16385	83215		34824	G60010			G60052		37070	G61140	
16721	83125		34828	G60128		37027	G60053		37071	G60312	
171322	G60222		34839	G60214		37028	G60305		37072	G60074	
171341	G62014		34895	83207	89407	37029	G60329			G60304	
31029	G61139		34900	G60023			G60075		37073	G60308	
32066	G60301		34901	G60024		37030	G60153			G60096	
32207	G60353		34904	G60003		37031	G60070		37074	G60180	
32217	G60169			G60003			G60105		37075	G60160	
32273	G61122		34905	G60031		37032	G60103		37076	G60199	
32274	G61121		34906	G60026		37033	G60154		37077	G60310	
32314	G60152		34907	G60129		37035	G60222		37080	G60184	
32341	G60218			G60129			G60161		37082	G60226	
32392	G61182		34909	G60002			G60162			G60186	
33049	G60164			G60046		37036	G60033		37085	G60196	
34514	G61958		34912	G60185			G60072			G61896	
34516	G61182		34919	G60112		37038	G60066		37086	G61897	
34518	G61150		34920	G60218			G60084		37088	G60114	
34519	G61177		34927	G60035		37040	G60064		37089	G60011	
34612	83017		34928	G60041			G60309		37090	G60015	
34617	83019		34929	G60111			G60008		37091	G60039	
34657	G60259		34930	G61152		37041	G60065		37093	G60017	
34684	G60182		34954	G60087			G60010		37094	G60012	
34685	G61149		34958	G60042		37042	G60307		37097	G60354	
34687	G61151		34959	G60091		37044	G60097		37099	G60051	
34690	G60218		34960	G60044		37045	G60028		37100	G60305	
34721	83103		34963	G60007		37046	G60029		37101	G60204	
34722	83400		34964	G60081		37047	G60303		37102	G60205	
34730	G60023		34972	G60164		37048	G60101		37103	G60206	
34733	G60179		34975	G60129		37049	G60014		37104	G60216	
34736	G60113		37011	G60038		37050	G60098		37108	G60250	
34751	G60161		37012	G60158		37051	G60099		37109	G60251	
34755	G61153		37013	G60144			G60099		37110	G60219	
34761	G60183			G60063		37052	G60007			G61873	
34762	G60196			G61113		37053	G60023		37111	G60338	
34768	83209	89414	37014	G60143		37055	G60080		37112	G60232	
34777	G60206			G61115		37058	G60078		37113	G62005	
34778	G60216			G60048		37060	G60181		37114	G62004	
34782	G60217		37015	G60171		37061	G60120		37120	G60129	
34787	G60176		37016	G60194		37062	G61159		37121	G60099	
34788	G60177		37017	G60197		37063	G60076		37122	G60221	
34791	G60235		37021	G60050		37064	G60077		37123	G60233	
34794	G60043		37022	G60165		37065	G60062		37128	G60330	
34798	G60163			G60104		37066	G60313		37129	G60049	
34802	83216		37024	G60164		37067	G60083		37130	G61159	
34803	G60021			G60164		37068	G61881			G60163	
34821	G60007						G60306		37131	G60257	

Important Note: Competitive Interchanges are to be used for stocking purposes only. Where multiple crosses are identified, please reference the applications section of this catalog. / **Remarque importante:** Les interchanges concurrentiels ne s'utilisent qu'aux fins de stocks. Dans le cas de références multiples, consulter la section des applications du catalogue. / **Nota importante:** Se pueden usar intercambios competitivos para propósitos de almacenamiento solamente. Cuando se identifican intercambios múltiples, consulte la sección de aplicaciones de este catálogo.

Competitive Interchange List

Piezas de substitución de competidores

Articles concurrents

MONROE ... cont'd

Monroe	Gabriel	Upgrade	Monroe	Gabriel	Upgrade	Monroe	Gabriel	Upgrade	Monroe	Gabriel	Upgrade
37132	G61118		555028	83207	89407	65129	85701		65422	85912	
37133	G60259		555043	83400		65130	85061	89450	65423	85907	
37134	G60258		557005	83136		65133	85935		65424	85905	
37135	G60265		557006	83136		65139	85918	89449	65425	89441	
37144	G60260		557010	85909		65140	85918	89449	65427	85903	
37149	G61124		557011	★83160		65142	83131		65428	85321	
37151	G61144		557012	85910		65143	83135		65429	85030	89440
37153	G61112		557013	85910		65144	85957		65430	85712	
37155	G60219		557014	89406		65145	85929		65431	85909	
37156	G61116		557015	85013	89414	65146	85925		65432	85910	
	G61869		557017	85029		65147	85924	89457	65433	85910	
37157	G60269		557018	85029		65148	85918	89449	65434	85012	89413
37158	G60255		557020	83123	89405	65150	85953		65435	85901	
37160	G60253		557021	85051		65151	85953		65436	85900	
37161	G61204		557022	85051		65153	85921		65439	85718	
37162	G61170		557023	85909		65155	83135		65440	85711	
37163	G61158		557026	83127		65156	85321		65441	85704	
37164	G60218		557027	83144		65158	85954		65442	85700	
37166	G61866		557028	85010		65159	85070	★89459	65443	85706	
37191	G60124		557031	85010		65160	85080		65444	85311	89424
37198	G60237		557033	85900		65161	83136		65445	85731	
37199	G61860		5777	G61880		65170	★85969		65446	85730	
37202	G62002		65101	85062	89408	65171	85964		65447	85703	
37203	G61178		65102	85001	89410	65172	83153		65448	85700	
37204	G61180		65103	85320	89429	65173	85336		65449	85702	
37206	G61958		65104	85304		65175	★85084	★89460	65451	85029	
37217	G61862		65105	85026	89417	65176	★85084	★89460	65452	85733	
37218	G61877		65106	83207	89407	65400	85033	89427	65453	85904	
37231	G60263		65107	85316	89426	65401	85013	89414	65454	85713	
37238	G61156		65108	85030	89432	65402	85311	89424	65455	85716	
37240	G61865		65109	85058	89431	65404	85310	89423	65456	85376	
37241	G61175		65110	85005	89430	65405	85023	89415	65457	85909	
37242	G62014		65111	85006		65406	85024	89416	65458	85908	
	G61175		65112	89402		65407	85736		65459	85043	
37243	G60164		65113	85012	89413	65408	85319	89428	65462	85913	
37244	G61864		65114	85006		65409	85003	89411	65463	85040	
37246	G62003		65115	85027	89418	65410	85300	89419	65464	85716	
37249	G60088		65116	85303	89422	65411	85036	89405	65465	85939	
39052	G61868		65118	83215		65412	83122	89406	65466	85047	89435
550019	G61918		65119	85029		65413	83136		65467	85054	89438
550020	G61919		65120	85010		65415	85046	89434	65468	85069	89455
551001	85043		65121	89432		65416	85323	89436	65469	85708	
551002	83122	89406	65122	85063		65417	85322		65470	85708	
555011	G60119		65123	85054	89438	65418	85906		65471	85302	89420
555012	G60028		65124	85053	89442	65419	85000	89436	65472	85330	
555026	83124	89407	65128	85031		65420	85013	89414	65473	85329	
555027	83124	89407				65421	85916		65474	85712	

Important Note: Competitive Interchanges are to be used for stocking purposes only. **Where multiple crosses are identified, please reference the applications section of this catalog.** / **Remarque importante:** Les interchanges concurrentiels ne s'utilisent qu'aux fins de stocks. **Dans le cas de références multiples, consulter la section des applications du catalogue.** / **Nota importante:** Se pueden usar intercambios competitivos para propósitos de almacenamiento solamente. **Cuando se identifican intercambios múltiples, consulte la sección de aplicaciones de este catálogo.**

★ Will be available in first quarter of 2011.

Competitive Interchange List

Piezas de sustitución de competidores

Articles concurrents

MONROE ... cont'd

Monroe	Gabriel	Upgrade	Monroe	Gabriel	Upgrade	Monroe	Gabriel	Upgrade	Monroe	Gabriel	Upgrade
65475	85065		6603	83103		66181	83025		66631	83132	
65476	85736		6604	83101		66182	83005		66632	83001	
65478	85030	89440	6605	83613		66189	83041		66633	83127	
65479	83122	89406	6606	83636		66193	83034		66634	83203	89436
65480	83111		6607	85052		66195	83033		66636	83127	
65481	85036	89405	6608	83128		66196	83027		66637	83304	
65482	85006	89401	6609	83635		66198	★83158		66638	83123	89405
65483	83148		6610	85051		66400	G60091		66639	G60164	
65484	85013	89414	66101	83042		66402	★83157		66643	83007	
65486	85066	89448	66103	83046		66403	83154		66645	83008	
65487	85927		66104	83021		66406	85920		66646	83308	89435
65488	85926		66105	83044		66407	83134		66647	83009	
65489	85331		66106	83016		66408	83145		66648	83112	
65490	85724	89443	66108	83028		66409	83146		66649	83010	
65491	85930		66109	83048		66412	83156		66650	83003	
65492	85931	89458	66111	83016		66416	★85085		66653	G60177	
65493	85934		66112	83017		66486	85066	89448	66654	83014	
65494	85061	89450	66113	83050		66502	646155		66656	83110	
65495	85067	89451	66114	83045		66504	632147		66657	83015	
65496	83138		66115	83045		6658	85009		66658	85009	
65497	85933	89454	66116	83018		66601	83114		66659	83002	
65498	85964		66117	83019		66602	★83161		66660	85059	
65499	85963		66118	83001		66603	83103		66661	83123	89405
65500	85738		66121	83047		66604	83101		66663	83137	
65501	85738		66122	83038		66605	83613		66664	83215	
65502	85938		66123	83004		66606	83636		66665	83109	
65503	85919		66124	83040		66607	85052		66668	85055	89439
65504	85072		66125	83035		66608	83128		66669	83111	
65505	83147		66126	83051		66609	83635		66670	83200	
65507	83143		6613	83123	89405	66610	85051		66677	83114	
65508	83142		66132	83001		66611	83016		66678	83023	
65509	85079		6614	83125		66612	83017		66679	83013	
65510	85052		66143	83007		66613	83123	89405	66681	83025	
65511	85939		66145	83008		66614	83125		66682	83005	
65512	85938		66147	83009		66615	83120		66683	83101	
65513	85338		66149	83022		66616	83018		66691	83118	
65514	89405		6615	83120		66617	83019		66692	83120	
65515	83125		66150	83003		66618	G60128		66693	83034	
65516	83209	89414	66154	83014		66620	★83162		66695	83033	
65519	83127		66157	83015		66623	83004		66699	83113	
65522	85082		66159	83031		66624	83141		66701	83215	
65523	85937		66160	83052		66625	★83162		66707	83215	
65524	85936	89456	66161	83054		66626	85071		66708	83100	
65525	87015		66162	83025		66627	85045		66710	83209	89414
65526	85956		66169	83027		66628	83136		66712	85040	
65527	85955		66178	83023		66629	83107		66713	83105	
65528	85069	89455	66179	83013		66630	83216		66714	83216	

Important Note: Competitive Interchanges are to be used for stocking purposes only. Where multiple crosses are identified, please reference the applications section of this catalog. / **Remarque importante:** Les interchanges concurrentiels ne s'utilisent qu'aux fins de stocks. Dans le cas de références multiples, consulter la section des applications du catalogue. / **Nota importante:** Se pueden usar intercambios competitivos para propósitos de almacenamiento solamente. Cuando se identifican intercambios múltiples, consulte la sección de aplicaciones de este catálogo.

★ Will be available in first quarter of 2011.

Competitive Interchange List

Piezas de sustitución de competidores

Articles concurrents

MONROE ... cont'd

Monroe	Gabriel	Upgrade	Monroe	Gabriel	Upgrade	Monroe	Gabriel	Upgrade	Monroe	Gabriel	Upgrade
66715	85026	89417	6718	85024	89416	6960	G60044		74420	85003	89411
66716	85042		6719	83242		6969	83126	89430	74421	85708	
66717	G60177		6720	85003	89411	6994	83122	89406	74422	85733	
66719	83242		6721	83103		70039	85303	89422	74423	85712	
66801	G60087		6801	G60087		70166	85301		74424	85308	89422
66811	83312	89409	6803	G60308		70300	85320	89429	74425	85724	89443
66828	85012	89413	6811	83312	89409	70312	85001	89410	74426	85333	
66829	83103		6817	G60014		70331	85314	89425	74427	85308	89422
66833	83126	89430	6824	G60010		70332	83314		74429	85919	
66841	83216		6828	83219		70334	85316	89426	74430	★85340	
66858	G60028		6829	83103		70402	85305		74431	★85341	
66860	83308	89435	6831	G60017		70720	85934		74432	★85970	
66861	83309	89446	6833	83126	89430	74001	85307		74433	85331	
66863	83314		6839	G60015		74003	85314	89425	74434	85711	
66864	83104		6840	83217		74004	85315		74435	★87017	
66868	83219		6841	83216		74006	85304		74436	85334	
66871	83119		6860	83308	89435	74012	85736		74438	85734	
66878	83221		6861	83309	89446	74024	85308	89422	74439	85728	
66883	83314		6863	83314		74025	85303	89422	74440	85729	
66884	83125		6864	83104		74028	85302	89420	74441	85339	
66886	83124	89407	6868	G60043		74029	85308	89422	74442	85727	
66891	83215		6878	83221		74069	85301		74443	85377	
66893	83203	89436	6886	83124	89407	74070	85701		74444	85378	
66894	83209	89414	6891	83215		74073	85320	89429	74451	85711	
66897	83126	89430	6893	83203	89436	74074	85722		74452	★85740	
66898	83125		6894	83209	89414	74075	85712		74453	85339	
66902	83401		6895	83204		74076	83136		911030	G60086	
66903	83400		66969	83126	89430	74077	85324		911171	G61154	
66912	83304		6897	83126	89430	74078	85027	89418	911172	G60100	
66913	83303		6898	83125		74079	85336		911183	G61173	
66921	83318		6900	G60023		74080	85332		911184	G61169	
66922	83301		6901	G60024		74081	83136		911222	G61970	
66923	83456	89447	6902	83401		74400	85700		911228	G61882	
66924	83317		6903	83400		74402	85711		911229	G61884	
66956	83101		6910	G60039		74405	85300	89419	911230	G61879	
66957	83225		6911	G60011		74406	85712		911251	G61878	
66966	83353		6912	83304		74408	85702		911252	G61883	
6701	83215		6913	83303		74409	85310	89423	911253	G61875	
6707	83215		6916	83123	89405	74410	85701		911255	G61894	
6708	83100		6920	G60112		74411	85703		911256	G61893	
6710	83209	89414	6921	83318		74412	85704		911257	G61895	
6712	85040		6922	83301		74413	85314	89425	911258	G61872	
6713	83105		6923	83456	89447	74414	85723			G62015	
6714	83216		6927	G60035		74415	85318		911259	G62016	
6715	85026	89417	6945	G60049		74416	85705		911260	G61892	
6716	85042		6956	83101		74417	85311	89424	911265	G62010	
6717	G60177		6957	83225		74418	85709		911266	G61886	

Important Note: Competitive Interchanges are to be used for stocking purposes only. **Where multiple crosses are identified, please reference the applications section of this catalog.** / **Remarque importante:** Les interchanges concurrentiels ne s'utilisent qu'aux fins de stocks. **Dans le cas de références multiples, consulter la section des applications du catalogue.** / **Nota importante:** Se pueden usar intercambios competitivos para propósitos de almacenamiento solamente. **Cuando se identifican intercambios múltiples, consulte la sección de aplicaciones de este catálogo.**

★ Will be available in first quarter of 2011.

Competitive Interchange List

Piezas de sustitución de competidores

Articles concurrents

MONROE ... cont'd

Monroe	Gabriel	Upgrade
911267	G61887	
911268	G61888	
911270	G61885	
911277	G61891	
911278	G62012	

Monroe	Gabriel	Upgrade
911279	G61889	
911280	G62007	
911508	G62000	
911527	G62001	
911528	G61965	

Monroe	Gabriel	Upgrade
911533	G61959	
911534	G62011	
911535	G62013	
911536	G62008	
911538	G61966	

Monroe	Gabriel	Upgrade
911539	G61967	
	G61890	
	G62006	

MOTORCRAFT

Motorcraft	Gabriel	Upgrade
AA-229	G61113	
AA-450	G61113	
AA-456	G61112	
AA-457	G60221	
AA-494	83131	
AA-615	83135	
AA-617	85957	
AS-1086	G60221	
AS-498G	G60162	
ASH-25	83309	89446
ASH-29	83314	
ASH-32	83125	
ASH-36	85716	
ASH-362	G60161	
ASH-363	G60144	
ASH-364	G60143	
ASH-365	G61112	
ASH-366	G60162	
ASH-38	85314	89425
ASH-39	85001	89410
ASH-51	G61113	
ASHV-1	G60221	
ASHV-1046	G61112	
ASHV-1047	G60161	
ASHV-1048	G60144	
ASHV-1049	G60143	
ASHV-1050	G60162	
ASHV-13	G60219	
ASHV-14	G61177	
ASHV-3	G60257	
ASHV-4	G60259	
ASHV-864	G60330	
ASHV-865	G61149	
ASHV-866	G61151	
ASHV-867	G60080	
ASHV-868	G60007	
ASHV-879	G60080	
AT-504G	G60222	
AT-506G	G60222	

Motorcraft	Gabriel	Upgrade
AT-507G	G60161	
AT-546	G60221	
AT-547	G61115	
AT-554	85305	
AT-611	G60084	
AT-621	G60258	
AT-682	G60221	
AT-683	G60222	
AT-684	G60222	
AT-685	G60222	
AT-696	83132	
AT-764	G60221	
AT-765	G61112	
AT-811	83135	
AX-131A	83217	
AX-135A	G60007	
AX-267A	83309	89446
AX-269A	83308	89435
	83312	89409
AX-277A	83219	
AX-282A	85010	
AX-310	83215	
AX-327	G61113	
AX-79A	83221	
	85030	89440
AX-97A	83122	89406
	85005	89430
CAH-001	85307	
	85711	
CAH-003	83207	89407
	83215	
	85001	89410
CAH-006	85304	
CAH-012	85736	
CAH-025	85007	89412
	85303	89422
CAH-028	85302	89420
CAH-029	85308	89422

Motorcraft	Gabriel	Upgrade
CAH-069	83219	
	85301	
CAHL-400	85303	89422
	85700	
CAHL-405	85300	89419
CAHL-406	85004	
	85734	
CAHL-409	85310	89423
CAHL-417	85311	89424
	85710	
CAT-722	83400	
CAT-729	G60038	
CAT-730	G60023	
CAT-731	G60035	
CAT-732	G60080	
CAT-733	G60179	
CAT-736	G60113	
CAT-737	G60120	
CAT-739	G60158	
CAT-740	G60051	
CAT-741	G60098	
CAT-745	G60162	
	G60171	
CAT-750	G60017	
CAT-751	G60161	
CAT-758	G60310	
CAT-759	G60184	
CAT-760	G60182	
CAT-761	G60183	
CAT-762	G60196	
CAT-768	83209	89414
CAT-776	G60205	
CAT-777	G60206	
CAT-778	G60216	
CAT-793	G60038	
CAT-802	G60075	
	G60101	
	G60329	
CAT-803	G60021	

Motorcraft	Gabriel	Upgrade
CAT-817	G60014	
CAT-824	G60010	
CAT-826	G60002	
CAT-828	G60103	
CAT-831	G60017	
CAT-832	G60012	
CAT-839	G60015	
CAT-853	G60028	89413
CAT-854	G60029	
CAT-868	G60043	
CAT-895	83207	89407
CAT-899	G60114	
CAT-900	G60023	
CAT-901	G60024	
CAT-904	G60003	
CAT-905	G60031	
CAT-906	G60026	
CAT-907	G60129	
CAT-909	G60046	
CAT-910	G60039	
CAT-911	G60011	
CAT-912	G60185	
CAT-919	G60112	
CAT-920	G60218	
CAT-926	G60033	
CAT-927	G60035	
	G60233	
CAT-928	G60033	
CAT-929	G60111	
CAT-930	G60084	
CAT-932	G60046	
CAT-935	G60052	
CAT-936	G60053	
CAT-944	G60008	
	G60309	
CAT-945	G60049	
	G60078	
CAT-948	G60310	

Important Note: Competitive Interchanges are to be used for stocking purposes only. Where multiple crosses are identified, please reference the applications section of this catalog. / **Remarque importante:** Les interchanges concurrentiels ne s'utilisent qu'aux fins de stocks. Dans le cas de références multiples, consulter la section des applications du catalogue. / **Nota importante:** Se pueden usar intercambios competitivos para propósitos de almacenamiento solamente. Cuando se identifican intercambios múltiples, consulte la sección de aplicaciones de este catálogo.

Competitive Interchange List

Piezas de sustitución de competidores

Articles concurrents

MOTORCRAFT ... cont'd

Motorcraft	Gabriel	Upgrade	Motorcraft	Gabriel	Upgrade	Motorcraft	Gabriel	Upgrade	Motorcraft	Gabriel	Upgrade
CAT-953	G60076		CAT-985	G60097		CAX-886	83207	89407	CAX-923	83102	
	G60301		CAT-986	G60098			85014			83456	
	G60304		CAT-990	G60307		CAX-891	83215		CAX-924	83317	
CAT-955	G60077		CAX-001	85307			85314	89425	CAX-957	83217	
CAT-958	G60042		CAX-707	83215		CAX-893	83203	89436		83225	
CAT-960	G60044			85001	89410		85000	89436	CAX-969	83221	
CAT-963	G60063		CAX-710	83209	89414		85043			85011	
	G60144		CAX-720	85003	89411	CAX-894	83209	89414		85030	89440
CAT-964	G60048		CAX-811	83312	89409		85005	89430	CLT-109	G60171	
	G60081		CAX-828	83207	89407		85013	89414	CLT-112	G60144	
CAT-972	G60164			85012	89413	CAX-898	83125		CLT-113	G60143	
CAT-975	G60129		CAX-833	83303			85006		CLT-114	G60194	
CAT-976	G60099			85005	89430	CAX-912	83304		CLT-115	G60115	
CAT-977	G60313		CAX-841	83216		CAX-913	83303		CLT-116	G60303	
CAT-978	G60083		CAX-860	83308	89435	CAX-916	83123	89405	CLT-124	G60164	
CAT-983	G60098		CAX-861	83309	89446		85036	89405	CLT-138	G60120	
CAT-984	G60163		CAX-863	83314		CAX-921	83318				
	G61159		CAX-878	83221							

SACHS

Sachs	Gabriel	Upgrade	Sachs	Gabriel	Upgrade	Sachs	Gabriel	Upgrade	Sachs	Gabriel	Upgrade
101892	85708		141700000443	85066	89448	311632	85909		471700003920	85958	
101968	85708		141700002626	85061	89450	311635	85030	89440	471700131155	85918	89449
106884	85708		141700131809	85029		471700000426	85014		471700131258	85081	
106-884	85708		141700131810	★83160		471700000431	85066	89448	481700000493	85900	
106885	85722		280499	85300	89419	471700000440	85959		481700125969	85956	
112-885	85709		290460	85005	89430	471700000449	85918	89449	481700131250	85377	
124693	85708		311229	85918	89449	471700002809	85724	89443	481700131252	85378	
141700000373	85061	89450	311230	85956		471700002861	85014		814903003528	83038	
141700000380	85061	89450	311631	85906		471700002991	85959				

TRUCKMASTER

Truckmaster	Gabriel	Upgrade	Truckmaster	Gabriel	Upgrade	Truckmaster	Gabriel	Upgrade	Truckmaster	Gabriel	Upgrade
665632	85013	89414	665930	85001	89410	680240	85302	89420	680283	83353	
665633	85033	89427	665931	83312	89409	680241	85311	89424	680303	85007	89412
665783	83123	89405	665932	85012	89413	680242	85308	89422	680348	85012	89413
665784	83122	89406	665950	85902		680243	85001	89410	680385	85311	89424
665785	83137		671052	85070	★89459	680253	85314	89425	680425	85320	89429
665844	85069	89455	671654	85936	89456	680261	85062	89408	680435	85317	
665918	85900		671699	85937		680279	83209	89414	680473	85319	89428
665926	85047	89435	671794	85067	89451	680280	83124	89407	680586	85311	89424
665927	85901		680237	85303	89422	680281	85003	89411	680601	85012	89413
665928	85062	89408	680239	85310	89423						

Important Note: Competitive Interchanges are to be used for stocking purposes only. **Where multiple crosses are identified, please reference the applications section of this catalog.** / **Remarque importante:** Les interchanges concurrentiels ne s'utilisent qu'aux fins de stocks. **Dans le cas de références multiples, consulter la section des applications du catalogue.** / **Nota importante:** Se pueden usar intercambios competitivos para propósitos de almacenamiento solamente. **Cuando se identifican intercambios múltiples, consulte la sección de aplicaciones de este catálogo.**

★ Will be available in first quarter of 2011.

O.E.M. INTERCHANGE

INTERCAMBIOS CON PIEZAS O.E.M.

ARTICLES DU MARCHÉ DES ÉQUIPEMENTS D'ORIGINE

O.E.M. #	GABRIEL #	O.E.M. #	GABRIEL #	O.E.M. #	GABRIEL #	O.E.M. #	GABRIEL #
ABC BUS		BLUEBIRD SCHOOL BUS		BLUEBIRD SCHOOL BUS		CHEVROLET TRUCK	
050134513	85732	...Cont'd		...Cont'd		1-51630-168-1	G60164
12B-5-1	85700	1217934	85304	AMS65109	89432	1-51630-217-0	83114
12J-5-10	85733	1316546	85006	AMS65110	85005 or	1-51630-217-1	83114
12L-5-88	85729	1526417	85052		89430	1-51630-219-1	83114
15L-5-114	85727	1658525	89432	BREDA BUS		1202-0012	83023
3166657	85700	1658533	85010	500-403-4	1202-0022	83046
6243-13790	85708	1667831	85029	BROCKWAY SCHOOL BUS		1202-0032	83016
6243-14040	85708	1668722	85030 or	14QK-281P10	85305	1202-0054	83021
680323	85700		89440	14QK-282P3	83216	12474915	83122 or
ACF BRILL BUS		1668730	85013 or	152398	85304		89406
610513	85307		89414	152412	83215	12474917	83137
631237	85308 or	1707405	85321	508657	85307	15123676	83136
	89422	1722214	85030 or	515231	85303 or	15174898	83136
641521	85308 or		89440		89422	15174902	85071
	89422	1722222	85013 or	530873	83207 or	15185643	83153
649648	85308 or		89414		89407	15185644	83155
	89422	1746163	85006	532397	85307	15588554	83136
659129	85303 or	1750793	85712	BUILT RITE		15642943	83136
	89422	1962422	85304	318-06-100	85006	15740554	83137
661732	83215	1962430	83207 or	BUS & TRUCK CO.		15887728	83136
661733	83225		89407	0100-905	85307	15963161	83122 or
995891	85307	2021459	85012 or	680091	85303 or		89406
ADVANCE MIXER			89413		89422	19152843	83136
13883	85334	300-0614966	85307	70039	85303 or	21998392	85336
680087	85334	300-0614974	85304		89422	22002293	85005 or
ALLCO TRAILER		300-0823047	85736	70041	85305		89430
727602	83122 or	300-0823054	85304	CARPENTER BUS		22002294	83304
	89406	300-09612284	85734	0272-SS5	85712	22002295	83303
AM GENERAL		300-1316546	85006	63-0001	85713	22007700	83207 or
3166657	85700	300-1317767	85029	CASCADE TRAILER			89407
4975501	85700	303-1350628	85712	120-1	83125	22007701	85005 or
5565748	85700	305-0961284	85734	CHALLENGE			89430
5957136	85700	4759272	89447	1540459	630811	22007702	83304
5969438	85700	59483-000	85919	632147	632147	22007703	83303
5978712	85700	60665-005	85919	632155	646177	22007750	83207 or
5979484	85302 or	609180	85304	CHALMERS SUSPENSION			89407
	89420	60998-001	85337	21335	G60014	22007751	83303
5979574	85700	614958	85307	665174	85060	22007752	83304
5982537	85700	614974	85304	800670	85301	22007753	83303
BECK BUS		671933	85919	800781	85314 or	22012065	85304
14QK-140	85304	680155	85712		89425	22012067	85700
14QK-2102	85304	680667	89447	CHAMPION TRANSIT		22012079	85701
BENSON TRUCK BODIES INC.		680783	85304	22064230	83136	22012082	85702
90044089	83124 or	70317	89402	22064231	85324	22012083	85711
	89407	70397	85006	CHANCE BUS		22012090	85308 or
A-20002	85000 or	7805-M-1001	85919	270-6708	85014		89422
	89436	87001-01A	85734	59039	83207 or	22012091	85303 or
BERING TRUCK CORP.		90-1813	85712		89407		89422
47902-24	83137	90-1951-SP1	85734	665017	85014	22012095	85005 or
BLUEBIRD SCHOOL BUS		90-1968	85712	6892	83207 or		89430
0523047	85736	90-1968-SP1	85712		89407	22012096	83221
0823054	85304	90-2497-SP1	6893	83203 or	22012114	85700
1004167	85712	90044448	85051		89436	22012131	85711
		90044915	83127	728600	83203 or	22012166	85005 or
		90045050	85914		89436		89430
		90045083	85910	AS789B	85014	22012169	83221
		A-4890	85712			22017530	83303
						22017531	83303

★ Will be available in first quarter of 2011.

O.E.M. INTERCHANGE

INTERCAMBIOS CON PIEZAS O.E.M.

ARTICLES DU MARCHÉ DES ÉQUIPEMENTS D'ORIGINE

O.E.M. #	GABRIEL #	O.E.M. #	GABRIEL #	O.E.M. #	GABRIEL #	O.E.M. #	GABRIEL #
CHEVROLET TRUCK ...Cont'd		CHEVROLET TRUCK ...Cont'd		CHEVROLET TRUCK ...Cont'd		CHEVROLET TRUCK ...Cont'd	
22024062	85701	4940640	83216	5394467	85305	5552288	83217
22024673	85710	4940650	83207 or 89407	5394468	85735	5552451	85308 or 89422
22045526	85702	4940654	83216	5455798	85307	5552452	85303 or 89422
22046481	85702	4940660	83207 or 89407	5513489	83216	5552453	85301
22046483	85304	4940662	85005 or 89430	5513716	85304	5552456	85307
22046485	85710	4963844	85307	5516459	85305	5552527	85735
22046499	85710	4963853	83216	5522781	85735	5552552	85303 or 89422
2204683	85304	4963854	83216	5522794	85308 or 89422	5554184	85302 or 89420
22052014	85702	4964853	83217	5522818	85305	5554589	85307
22052336	85304	4964853	83217	5527001	85300 or 89419	5554596	85303 or 89422
22052424	85710	4974401	85700	5527271	85700	5554814	85302 or 89420
22064230	83136	4975429	85300 or 89419	5527272	85700	5554959	83401
22064231	85324	4975467	83207 or 89407	5527606	85305	5554995	85305
22064232	85071	4975479	83400	5531027	85301	5559363	83203 or 89436
22064233	83136	4975480	83400	5531435	85307	5585939	85307
22064432	85050	4975494	83207 or 89407	5531436	85307	684280	83209 or 89414
22064489	85336	4975497	85005 or 89430	5531437	85307	8-94454-986-0	G60177
22064804	83136	4975510	83221	5532026	85304	8-94454-987-0	G60177
22064805	83136	4975515	85701	5532425	83207 or 89407	88963409	85336
22064806	83136	4975516	85702	5532433	83207 or 89407	88982682	83136
22064807	83136	4975518	85704	5534430	85303 or 89422	88982684	83136
22099889	85336	4975538	85700	5534439	85304	88982686	85071
22165187	83136	4975549	83216	5534447	85303 or 89422	88982688	85336
22165188	83136	4975550	85702	5544060	85302 or 89420	9-51630-647-1	G60177
22165189	83136	4984526	83216	5544112	83216	9-51630-666-0	85012 or 89413
22166442	83136	508-89	83155	5544581	85302 or 89420	9-51630-666-2	85012 or 89413
3171068	83216	5171068	83216	5544716	85304	94033786	83114
3171069	85304	5316784	85700	5544717	85304	94051090	83114
3171462	85005 or 89430	5316791	83219	5544812	83308	94057593	83114
3171696	85307	5316792	85305	5544818	85735	94454987	G60177
3172948	85303 or 89422	5316793	85305	5549899	83207 or 89407	97-2210-00153	85701
3175509	85735	5321920	85307	5549924	85700	97-2210-00164	85708
3178157	85700	5321929	85307	5549925	85304	97-2210-00170	85733
3178233	85734	5348631	83203 or 89436	5552111	85304	97083027	G60177
3178507	85700	5352858	85305	5552112	85307	97083029	G60177
3178995	85700	5353054	85303 or 89422	5552114	83216	97201960	G60177
3188626	85300 or 89419	5355798	85307	5552114	83216	L-12706	83155
3188729	85303 or 89422	5357955	85300 or 89419	5552205	83217	CLARK EQUIPMENT	
3192657	83216	5357956	85734	5552206	83214	355778	85315
3192890	85005 or 89430	5357959	85300 or 89419	5552207	83217	5532675	85307
3192892	83221	5361994	85734	5552208	83217	680042	85301
4939852	85308 or 89422	5374779	85308 or 89422	5552209	83215	CONTINENTAL TRAILWAYS-	
4939967	85308 or 89422	5374999	85307	5552210	85308 or 89422	EAGLE INT'L	
4940600	83209 or 89414	5385939	85307	5552244	85308 or 89422	01-0100-020	85307
4940601	83216	5392387	85303 or 89422	5552285	83214	01-0100-905	85303 or 89422
4940606	85005 or 89430	5394448	85305	5552286	83217	5394467	85305
4940614	83216			5552287	83217	5532026	85304
4940627	83203 or 89436						

★ Will be available in first quarter of 2011.

O.E.M. INTERCHANGE

INTERCAMBIOS CON PIEZAS O.E.M.

ARTICLES DU MARCHÉ DES ÉQUIPEMENTS D'ORIGINE

O.E.M. #	GABRIEL #	O.E.M. #	GABRIEL #	O.E.M. #	GABRIEL #	O.E.M. #	GABRIEL #
CONTINENTAL TRAILWAYS- EAGLE INT'L ...Cont'd		DURA SUSPENSION		FLXIBLE BUS		FLXIBLE BUS ...Cont'd	
6-05-5	85307	1080099	83203 or 89436	015813	85708	97-2201-00005	85703
680091	85303 or 89422	12866	83207 or 89407	06-0367-00151	85700	97-2201-00006	85703
70039	85303 or 89422	59024	83204	06-0367-00156	85702	97-2201-00007	85703
70041	85305	59030	83203 or 89436	06-0367-00157	85701	97-2201-00008	85731
COUNTRY COACH		665133	83203 or 89436	22012067	85700	97-2201-00009	85703
89406	89406	665267	85029	22012114	85700	97-2201-00151	85700
89414	89414	7604-3371	83204	22024061	85704	97-2210-00001	85704
CRANE CARRIER		A-2212	85029	22024062	85701	97-2210-00002	85704
277A-1	85307	EAGLE MOTOR COACH		22024506	85703	97-2210-00003	85704
277A-12	85304	01-0100-020	85307	22025066	85703	97-2210-00004	85704
277A-13	85302 or 89420	01-0100-905	85303 or 89422	22025067	85704	97-2210-00005	85704
277A-14	85304	014-0100-905	85308 or 89422	22025305	85704	97-2210-00006	85704
277A-8	85303 or 89422	0140100-905	85308 or 89422	3166657	85700	97-2210-00009	85704
277A-9	85307	101364	85305	3192333	85700	97-2210-00010	85730
680088	85713	12B-5-1	85700	48-1-239	85736	97-2210-00011	85704
680091	85303 or 89422	12J-5-10	85733	48-1-241	85712	97-2210-00153	85701
CROWN COACH		154-0100-514	85314 or 89425	4975518	85704	97-2210-00156	85702
3188729	85303 or 89422	5394467	85305	6-05-1	85736	97-2210-00157	85708
5532026	85304	5532026	85304	6-05-10	85734	97-2210-00160	85705 or 89447
5532036	85734	6-05-5	85307	6-05-13	85304	97-2210-00162	85701
CUNHA PRODUCTS OHD		680091	85303 or 89422	6-05-2	85736	97-2210-00164	85708
CP-5222	85315	690060	85713	6-05-3	85736	97-2210-00170	85733
DANA		70039	85303 or 89422	6-05-4	85736	97-9999-00732	85707
SR1VJ100	85078	70041	85305	6-05-5	85307	97-9999-02514	85700
DIAMOND T		EAST MANUFACTURING CORP.		6-05-6	85736	97-9999-02515	85702
5549925	85304	517-05001-18	87015	6-05-7	85736	97-9999-02516	85701
DIAMOND- REO		517-05001-23	85005 or 89430	6-05-8	85736	97-9999-02519	85707
220-55-1	83214	517-05006-20	85030 or 89440	6-05-9	85304	97-9999-02592	85710
220-55-2	85304	517-05009-14	83125	6-367-1	85711	97-9999-02595	85313
220-55-6	83214	517-05010-07	83214	6-367-12	85700	97-9999-02632	85711
220-55-7	85304	517-05022-07	83217	6-367-14	85700	97-9999-02633	85311 or 89424
220-55-8	83217	517-05110-20	85000 or 89436	6-367-16	85700	97-9999-02634	85733
DINA BUS		517-05511-14	83128	6-367-17	85700	97-9999-02635	85718
39380353-6	85716	517-05805-20	85000 or 89436	6-367-2	85736	97-9999-02636	85716
39390339-6	85302 or 89420	517-05806-20	85029	6-367-3	85304	97-9999-807	85307
39390340-4	85716	517-05808-20	85738	6-367-4	83217	FLYER INDUSTRIES	
DODGE TRUCK		517-05809-20	89437	6-367-7	85305	009863	85722
2516009	G60028	517-05916-14	83124 or 89407	6-367-8	85700	015915	85711
2960707	G60028	FLUIDRIVE		6-367-9	85711	15813	85708
2961043	G60028	2697	85712	680029	85301	22012067	85700
3633643	G60028			680155	85712	22012114	85700
3633744	G60028			695125	85704	3166657	85700
3638112	G60028			74412	85704	3192333	85700
3638631	G60119			87-2519-00001	85703	4975501	85700
4036892	G60119			87-2519-00002	85731	4975552	85711
DUPLEX TRUCK				87-2519-00003	85703	592-6568	85700
59024	83204			87-2519-00004	85731	5979574	85700
7604-3371	83204			87-2520-00001	85704	FORD	
				87-2520-00002	85730	1202-0012	83023
				87-2520-00003	85704	1202-0022	83046
				87-2520-00004	85730	1202-0032	83016
				97-2201-00001	85703	1202-0042	83025
				97-2201-00002	85703	1202-0043	83032
				97-2201-00003	85703	1202-1043	83025
				97-2201-00004	85703	1202-1044	83025

★ Will be available in first quarter of 2011.

O.E.M. INTERCHANGE

INTERCAMBIOS CON PIEZAS O.E.M.

ARTICLES DU MARCHÉ DES ÉQUIPEMENTS D'ORIGINE

O.E.M. #	GABRIEL #	O.E.M. #	GABRIEL #	O.E.M. #	GABRIEL #	O.E.M. #	GABRIEL #
FORD ...Cont'd		FORD ...Cont'd		FORD ...Cont'd		FORD ...Cont'd	
3553628C1	85927	C0TT-18045-D	83216	C7TA-18045-R	83216	D2TF-18045-AA	83312 or 89409
3553628C2	85927	C0TZ-18124-A	83216	C7TA-18045-Z	85301	D2TF-18045-GA	83308
3578858C1	85926	C1TT-18045-C	83312 or 89409	C8HA-18045-A	83312 or 89409	D2TF-18080-HA	83225
3584117C2	83135	C1TT-18045-D	G60007	C8PF-18045-CM	83216	D2TF-18124-F	83309 or 89446
3584118C2	85957	C1TT-18045-E	83314	C8TA-18045-AA	G60023	D2TZ-18124-A	83308
47902-13	83122 or 89406	C1TT-18045-G	83216	D0HA-18045-D	83309 or 89446	D2TZ-18124-E	83312 or 89409
47902-28	85013 or 89414	C1TZ-18045-C	83312 or 89409	D0HA-18045-E	83312 or 89409	D2TZ-18124-F	83309 or 89446
47902-8	83122 or 89406	C1TZ-18124-A	83217	D0HZ-18124-A	83309 or 89446	D2TZ-18124-G	83314
4C4Z-18124-P	83135	C1TZ-18124-B	83216	D0HZ-18124-B	83312 or 89409	D2TZ-18124-H	83308
4C4Z-18124-RA	85957	C1TZ-18124-C	83312 or 89409	D0HZ-18124-C	83314	D2TZ-18124-J	83312 or 89409
4C4Z-18125-B	83317	C1TZ-18124-D	83309 or 89446	D0HZ-18124-D	83314	D3TA-18045-BA	83219
501906C92	83317	C1TZ-18124-N	83314	D1TF-18045-LA	83312 or 89409	D3TZ-18124-B	83219
57241-2	83109	C1TZ-18125-B	83217	D1TZ-18124-D	83308	D3TZ-18125-C	83217
57365-111	85006 or 89401	C1VT-18080-B	83217	D1TZ-18124-E	83216	D3TZ-18125-D	83217
680029	85301	C2TA-18045-A	83216	D1TZ-18125-E	83217	D4HA-18080-A	83209 or 89414
6ETZ-18124-AA	83145	C2TA-18045-B	83308	D2EF-18045-AA	83312 or 89409	D4HA-18080-AA	83209 or 89414
6ETZ-18125-A	83146	C2TZ-18124-A	83308	D2EF-18124-AA	83312 or 89409	D4TZ-18124-J	83308
70127	85006 or 89401	C3TA-18045-A	83216	D2HA-18045-E1A	85304	D5TZ-18124-B	83308
70128	85006 or 89401	C3TZ-18124-A	83308	D2HA-18045-E1B	85304	D5TZ-18124-C	83312 or 89409
87HU-18045-AA	85301	C4HZ-18124-A	83312 or 89409	D2HA-18045-E2A	85304	D7HA-18080-AA	83123 or 89405
90044769	83207 or 89407	C4HZ-18124-B	83309 or 89446	D2HA-18045-E2B	85304	D7HF-18045-FA	83312 or 89409
90044770	83207 or 89407	C4HZ-18124-C	83314	D2HA-18045-EB	85301	D7HF-18080-AA	83215
90045068	89441	C4HZ-18124-D	83312 or 89409	D2HA-18045-F1A	85301	D7HF-18125-AA	83215
90045099	85906	C4HZ-18124-E	83309 or 89446	D2HA-18045-F1B	85301	D7HT-18045-BA	83312 or 89409
90045132	85909	C4HZ-18124-F	83308	D2HA-18045-F2A	85301	D7HT-18045-CA	83314
AA-494	83131	C4PF-18045-H	83216	D2HA-18045-F2B	85301	D7HT-18045-DA	83309 or 89446
AA-615	83135	C4TZ-18124-AA	83308	D2HF-18045-A	83314	D7HT-18045-EA	83312 or 89409
AA-617	85957	C4TZ-18124-AB	83308	D2HF-18045-AA	83314	D7HT-18045-GA	83308
AT-611	G60084	C4TZ-18124-AB	83308	D2HF-18045-BA	83309 or 89446	D7HT-18045-HA	85012 or 89413
AT-696	83140	C4TZ-18124-B	83308	D2HF-18045-CA	83308	D7HT-18045-JA	83308
AT-811	83135	C5TZ-18124-A	83308	D2HF-18045-DA	83312 or 89409	D7HT-18045-NA	85301
AX-310	83215	C6PF-18077-A	G60021	D2HF-18124-AA	83314	D7HT-18080-AA	83215
AX267A	83309 or 89446	C6PF-18077-DD	83216	D2HT-18045-CA	83314	D7HT-18080-BA	83225
B3Q-18124-A	83219	C6PF-18077-DE	83219	D2HT-18045-EA	83312 or 89409	D7HT-18080-CA	83225
B3Q-18125-A	83217	C6PF-18077-DL	83312 or 89409	D2HT-18045-EA	83312 or 89409	D7HT-18080-DA	83215
B3TZ-18125-A	83217	C6PF-18077-DN	83314	D2HT-18045-GA	83308	D7HT-18124-BA	83312 or 89409
B6TZ-18124-A	83219	C6PF-18077-F	83225	D2HT-18080-HA	83225	D7HT-18124-CA	83314
B7TZ-18124-B	83216	C6TA-18045-U	85301	D2HZ-18080-A	83209 or 89414	D7HT-18124-DA	83309 or 89446
B7TZ-18124-C	83216	C6TA-18045-V	85301	D2HZ-18125-A	83209 or 89414	D7HT-18124-EA	83312 or 89409
B7TZ-18124-D	83219	C6TA-18045-Y	85301	D2HZ-18125-B	83209 or 89414	D7HT-18124-FA	83312 or 89409
B7TZ-18124-E	83217	C6TA-18045-Z	85301	D2Kf-18045-AA	83312 or 89409	D7HT-18124-GA	83308
B7TZ-18125-C	83217	C6TS-18080-A	83217	D2Kf-18124-AA	83312 or 89409		
B8Q-18125-A	85307	C6TZ-18124-D	85301	D2TA-18045-AAA	83219		
B8QZ-18124-A	83312 or 89409	C6TZ-18124-E	85301	D2TA-18045-ZA	83219		
B8T-18124-A	83219	C6TZ-18124-H	85301				
B9TT-18045-C	83219	C6TZ-18124-J	85301				
B9TT-18045-D	83219	C7HZ-18124-A	83312 or 89409				
C0TT-18045-A	83219	C7PF-18077-A	83225				
		C7PF-18077-Z	83217				

★ Will be available in first quarter of 2011.

O.E.M. INTERCHANGE

INTERCAMBIOS CON PIEZAS O.E.M.

ARTICLES DU MARCHÉ DES ÉQUIPEMENTS D'ORIGINE

O.E.M. #	GABRIEL #	O.E.M. #	GABRIEL #	O.E.M. #	GABRIEL #	O.E.M. #	GABRIEL #
FORD ...Cont'd		FORD ...Cont'd		FORD ...Cont'd		FORD ...Cont'd	
D7HT-18124-HA	83219	F0HZ-18125-A	85005 or 89430	F5HZ-18124-AA	83314	F6HZ-18124-E	85055 or 89439
D7HT-18124-JA	83308	F1HT-18045-AA	83309 or 89446	F5HZ-18124-B	83107	F6HZ-18124-F	85055 or 89439
D7HT-18124-KA	85301	F1HT-18045-CA	83308	F5HZ-18124-C	85063	F6HZ-18124-G	85054 or 89438
D7HT-18125-BA	83217	F1HT-18045-CB	83216	F5HZ-18124-D	83125	F6HZ-18124-H	85054 or 89438
D7HT-18125-CA	83217	F1HT-18045-DA	83312 or 89409	F5HZ-18124-DA	83125	F6HZ-18124-J	83200
D7HT-18125-DA	83215	F1HT-18045-DB	83308	F5HZ-18125-A	85314 or 89425	F6HZ-18124-KA	83200
D7HT-18125-FA	83123 or 89405	F1HT-18045-EA	89402	F5HZ-18125-AA	85314 or 89425	F6HZ-18124-MA	85006 or 89401
D7HZ-18125-A	83215	F1HT-18045-EB	89402	F5HZ-18125-B	85001 or 89410	F6HZ-18125-A	85314 or 89425
D7KF-18045-EA	83312 or 89409	F1HT-18045-GA	85006 or 89401	F5HZ-18125-BA	85001 or 89410	F6HZ-18125-B	83109
D7TA-18124-GA	83314	F1HT-18045-GB	89403	F5HZ-18125-DA	85314 or 89425	F6HZ-18125-C	89441
D8HT-18A160-AB	F1HT-18045-HB	85006 or 89401	F5TZ-18124-B	G60162	F6HZ-18125-D	85013 or 89414
D8HZ-18124-A	85301	F1HT-18045-LB	85006 or 89401	F5TZ-18125-BC	G60161	F6HZ-18125-JA	85305
D8HZ-18125-A	83209 or 89414	F1HT-18045-NA	85040	F6HT-18045-AA	85054 or 89438	F6HZ-5K407-AB	83034
D8HZ-18125-B	83123 or 89405	F1HT-18045-RA	89402	F6HT-18045-AC	85054 or 89438	F6HZ-5K407-BA	83033
E0HT-18045-AA	83309 or 89446	F1HT-18045-RB	89402	F6HT-18045-BC	85047 or 89435	F7TA-18045-AA	G60162
E0HT-18045-AB	83309 or 89446	F1HZ-18124-A	83309 or 89446	F6HT-18045-CC	85055 or 89439	F7TA-18080-BA	G60161
E0HT-18080-AA	83215	F1HZ-18124-AA	83309 or 89446	F6HT-18045-EB	85055 or 89439	F81A-18080-DCA	G60084
E0HZ-18124-A	83309 or 89446	F1HZ-18124-B	83308	F6HT-18045-EC	85055 or 89439	F81A-18080-ZC	83140
E1TA-18045-AA	83309 or 89446	F1HZ-18124-C	89402	F6HT-18045-GB	85055 or 89439	F81Z-18125-DA	G60084
E1TD-18045-AA	83309 or 89446	F1HZ-18124-D	85006 or 89401	F6HT-18045-GC	85055 or 89440	F81Z-18125-ZA	83140
E5HT-18045-AA	85301	F1HZ-18124-E	85006 or 89401	F6HT-18045-HB	85054 or 89438	F8HT-5K407-AA	83033
E5HT-18045-DA	85301	F1HZ-18124-F	85006 or 89401	F6HT-18045-HC	85054 or 89438	FC4Z-18124-HB	83135
E5HT-18045-EA	85301	F1HZ-18124-G	85006 or 89401	F6HT-18045-JA	83109	TACAA-18045-A	83216
E5HT-18080-DA	85315	F1HZ-18124-H	85040	F6HT-18045-JB	83200	TANNA-18045-A	83312 or 89409
E5HT-18080-EA	85315	F1HZ-18124-I	83308	F6HT-18045-JC	83200	TBDA-18080-A	83217
E6HT-18080-AA	83215	F1HZ-18124-J	83308	F6HT-18045-KA	83200	TBDA-18080-B	83217
E6HZ-18124-A	85301	F1HZ-18124-K	89402	F6HT-18045-LA	85376	TBDA-18045-A	83219
E6HZ-18124-D	85301	F2HT-18045-BA	85376	F6HT-18045-MA	85006 or 89401	TBDA-18045-B	83219
E6HZ-18125-D	83215	F2HT-18045-CA	85376	F6HT-18080-CA	85314 or 89425	TBDA-18080-A	83217
E7HZ-18124-A	85301	F2HZ-18124-A	85376	F6HT-18080-DA	83109	TBDA-18080-B	83217
E7XZ-18124-A	G60023	F2HZ-18124-B	85301	F6HT-18080-EA	85906	TBDA-18080-C	83217
E7XZ-18124-F	G60046	F4HT-18045-AB	83314	F6HT-18080-FC	85013 or 89414	TDBE-18045-A	83219
E7XZ-18124-G	G60046	F4HT-18045-AC	83314	F6HT-18080-JA	85305	TFAA-18045-B	83219
E7XZ-18125-B	G60024	F4HT-18045-CB	83107	F6HT-18080-JB	83200	TFAA-18045-C	83219
E9HS-18045-AA	83309 or 89446	F4HT-18045-DA	85063	F6HT-18080-JC	83200	TFAA-18080-A	85307
E9HS-18080-AA	85716	F4HT-18045-EA	83125	F6HT-18080-KA	83200	THAB-18045-A	83219
E9HZ-18124-A	83309 or 89446	F4HT-18045-FA	85314 or 89425	F6HT-18080-LA	85376	THAB-18045-B	83219
E9HZ-18125-A	85716	F4HT-18080-AA	85314 or 89425	F6HT-18080-MA	85006 or 89401	TQSH-18045-A	83309 or 89446
E9HZ-18125-AA	85716	F4HT-18080-AB	85314 or 89425	F6HT-18080-NA	85006 or 89401	XC35-18045-AB	83131
F0HS-18045-AA	85006 or 89401	F4HT-18080-BA	85001 or 89410	F6HT-18080-OA	85006 or 89401	XC35-18045-JA	83131
F0HT-18045-CA	85006 or 89401	F4TA-18045-TA	G60080	F6HT-18080-PA	85006 or 89401	XC3Z-18124-JA	83131
F0HT-18080-AA	85005 or 89430	F4TA-18080-PA	G60084	F6HT-18080-QA	85006 or 89401	XC45-18045-AA	83216
F0HZ-18124-B	85006	F4TZ-18124-K	G60080	F6HZ-18124-A	85054 or 89438	FREIGHTLINER	
		F4TZ-18125-E	G60084	F6HZ-18124-B	83308	10-12030-002	85320 or 89429
		F5HZ-18124-A	83314	F6HZ-18124-C	85055 or 89439	10-12032-000	85320 or 89429
				F6HZ-18124-D	85055 or 89439		

★ Will be available in first quarter of 2011.

O.E.M. INTERCHANGE

INTERCAMBIOS CON PIEZAS O.E.M.

ARTICLES DU MARCHÉ DES ÉQUIPEMENTS D'ORIGINE

O.E.M. #	GABRIEL #	O.E.M. #	GABRIEL #	O.E.M. #	GABRIEL #	O.E.M. #	GABRIEL #
FREIGHTLINER ...Cont'd		FREIGHTLINER ...Cont'd		FREIGHTLINER ...Cont'd		FREIGHTLINER CUSTOM	
10-12032-001	85320 or 89429	16-15817-000	85724 or 89443	654990	83038	CHASSIS	
10-12032-002	85320 or 89429	16-16442-000	83134	659060	85920	10-13358-000	85904
10-12032-003	85320 or 89429	16-16486-000	83134	659062	83134	10-13859-000	85005 or 89430
10-12032-004	85320 or 89429	16-16577-000	85335	659079	83040	1398980	83127
10-12046-000	85320 or 89429	16-17759-000	85919	659080	83039	141700131809	85029
10-12388-000	85920	16-18094-000	85959	659125	83047	141700131810	★83160
10-12390-000	85920	16-18705-000	85007 or 89412	659178	83038	16-14782-000
10-12470-000	16-18706-000	85331	659288	83006	16-14794-000	83154
10-12542-000	85901	16-18707-000	85921	659300	85005 or 89430	16-15089-000
10-12703-000	85918 or 89449	16-18708-000	85724 or 89443	660235	85042	16-15394-000
10-12704-000	85918 or 89449	16-18710-000	83134	665174	85060	16-15436-000	83154
10-13021-000	85918 or 89449	16-18711-000	85335	665236	85007 or 89412	16-15473-000	★83157
10-13063-000	85918 or 89449	16-19138-000	85058 or 89431	665409	85009	16-15474-000	★83157
10-13211-000	85918 or 89449	18-29846-000	83009	665538	85006	16-15676-000	85058 or 89431
10-13592-000	85959	18-30378	83006	671908	85918 or 89449	16-15705-000
10-13634-000	85918 or 89449	18-30378-000	83001	671945	85920	16-15934-000	83120
10-13760-000	85959	18-31476-000	83020	671946	85921	16-16082-000	85043
10-13776-000	85005 or 89430	18-32999-000	83001	680008	85300 or 89419	16-16083-000	85331
10-13809-000	85958	18-32999-001	83006	680009	85302 or 89420	16-16262-000	83120
10-13859-000	85005 or 89430	18-37813-000	83044	680017	85302 or 89420	16-16331-000
1202-0012	83023	18-41762-000	83038	680017	85302 or 89420	16-16542-000	83154
1202-0022	83046	18-41762-001	83047	6803230200	85043	16-16736-000	85029
1202-0032	83016	18-41762-002	83038	6803230300	85006	16-16737-000	★83160
1202-0042	83025	18-44321-000	83009	6803260000	83120	16-16836-000	83154
1202-0043	83032	18-45067-000	83034	680339	85724 or 89443	16-16873-000	85029
1202-0044	83025	18-47349-000	83039	680442	85319 or 89428	16-16874-000	★83160
1202-0054	83021	18-47350-000	83040	680511	85331	16-17019-000
1202-1043	83025	18-60295-000	83006	680611	85724 or 89443	16-17684-000	85058 or 89431
1202-1044	83025	18-60764-000	83038	680651	85335	16-17759-000	85919
16-10688-000	85042	18-60765-000	83047	681-323-0900	85009	16-18094-000	85959
16-11133-000	85007 or 89412	18-60766-000	83040	681-326-0400	85319 or 89428	16-18103-000	85900
16-12117-000	85007 or 89412	18-60767-000	83039	681-891-02-05	83017	16-19138-000	85058 or 89431
16-13947-000	85319 or 89428	18-60772-000	83026	6813230900	85009	1745500	89430
16-13957-000	85724 or 89443	3638112	G60028	6813231300	481700000493	85900
16-14259-000	85331	471700003920	85958	6813260000	83634	651375	83119
16-14577-000	85043	47902-13	83122 or 89406	6813260200	85011	654870	83116
16-14669-000	G60111	481700125969	85956	70029	85308 or 89422	654953	85058 or 89431
16-14759-000	85000 or 89436	535228	85302 or 89420	70042	85302 or 89420	659104	85904
16-15765-000	85921	61300224	85918 or 89449	90044162	83128	659227	85058 or 89431
16-15770-000	85956	650224	83225	90045083	85910	665545401	89430
		650361	83017	HDR-58913-003	85932 or 89453	6803230300	85006
		651352	85042	SDA471400003920	85958	6803260000	83120
		651356	83634	SDA471700000440	85959	GBL654725	83120
		654654	85043	SDA471700002809	85724 or 89443	GBL654875	83117
		654725	83120	SDA471700002991	85959	GBL654918	83118
		654739	83009			GBL665538	85006
		654819	83001			MAE 16949	83120
		654831	83006			MAE 16950	83118
		654841	83020			MAE 16950	83118
		654875	83117			P101977	85010
		654918	83118			P110799

★ Will be available in first quarter of 2011.

O.E.M. INTERCHANGE

INTERCAMBIOS CON PIEZAS O.E.M.

ARTICLES DU MARCHÉ DES ÉQUIPEMENTS D'ORIGINE

O.E.M. #	GABRIEL #	O.E.M. #	GABRIEL #	O.E.M. #	GABRIEL #	O.E.M. #	GABRIEL #
FREIGHTLINER CUSTOM CHASSIS ...Cont'd		GILLIG BROS. ...Cont'd		GMC TRUCK ...Cont'd		GMC TRUCK ...Cont'd	
P116168	83117	82-01878	83122 or 89406	22007752	83304	3171696	85307
P117099	83120	82-21542-000	85716	22007753	83303	3172948	85303 or 89422
P117146	83118	82-30159-000	85708	22007757	83304		
P117253	83116	90-1908	85723	22012065	85304	3175509	85735
RW24285	83119	90044046	83123 or 89405	22012067	85700	3178106	85700
FRUEHAUF		90044683	83122 or 89406	22012079	85701	3178157	85700
144-5910	85300 or 89419	90044769	83207 or 89407	22012082	85702	3178233	85734
5116-117	83122 or 89406	90044770	83207 or 89407	22012083	85711	3178507	85700
5352858	85305	90045084	★85968	22012090	85308 or 89422	3178995	85700
680117	85300 or 89419	90F-1912	85318	22012091	85303 or 89422	3182842	85711
680298	85321	H53-02132/14005	85723	22012095	85005 or 89430	3188599	85711
UCA-01113	85304	H53-20415-006	85051	22012096	83221	3188626	85300 or 89419
UCA-5431	85305	MR-6394	85723	22012114	85700	3188729	85303 or 89422
UCD-006216-001	83203 or 89436	GMC		22012131	85711	3189265	85700
UCD-6216-1	83203 or 89436	1201-1043	83025	22012166	85005 or 89430	3192333	85700
UCE-1295-1	85300 or 89419	1202-0012	83023	22012169	83221	3192416	85711
UCE-1295-901	85300 or 89419	1202-0022	83046	22012196	83221	3192657	83216
UCE-2983-000	85322	1202-0032	83016	22017530	83303	3192891	83221
UCE-2983-001	85322	1202-0034	83016	22017531	83303	3192892	83221
UCE-2983-1	85322	1202-0054	83021	22024061	85704	4939852	85308 or 89422
UCE-9399-1	83122 or 89406	1202-1043	83025	22024062	85701	4939967	85308 or 89422
UCF-8339-001	85321	GMC TRUCK		22024673	85710	4940600	83209 or 89414
UCF-8339-002	85321	1-51630-168-1	G60164	22025067	85704	4940601	83216
UEY 1124-001	85030 or 89440	1-51630-217-0	83114	22025067	85704	4940606	85005 or 89430
FWD TRUCK		1-51630-217-1	83114	22025305	85704	4940614	83216
450739	85302 or 89420	1-51630-219-1	83114	22045526	85702	4940627	83203 or 89436
GENERAL TRAILER CO		12474915	83122 or 89406	22046481	85702	4940640	83216
120-1	83125	12474917	83137	22046483	85304	4940650	83207 or 89407
12608	83125	15123676	83136	22046485	85710	4940654	83216
GILLIG BROS.		15174898	83136	22046499	85710	4940660	83207 or 89407
1583470	85051	15174902	85071	22052014	85702	4940662	85005 or 89430
200-171	85304	15185643	83153	22052336	85304	4963844	85307
53-02132	85723	15185644	83155	22052424	85710	4963853	83216
53-02133-000	85318	15588554	83136	22064230	83136	4963854	83216
53-14010	85318	15642943	83136	22064231	85324	4964853	83217
53-176	85304	15740554	83137	22064232	85071	4974401	85700
53-24685	85723	15887728	83136	22064233	83136	4975429	85300 or 89419
57113	83219	15963161	83122 or 89406	22064432	85050	4975467	83207 or 89407
57131	83216	19152843	83136	22064489	85336	4975479	83400
665568	85051	21998392	85336	22064804	83136	4975480	83400
680009	85302 or 89420	22002293	85005 or 89430	22064805	83136	4975494	83207 or 89407
680333	85708	22002294	83304	22064806	83136	4975497	85005 or 89430
695109	85723	22002295	83303	22064807	83136		
695110	85318	22007701	85005 or 89430	22099889	85336		
70034	85302 or 89420	22007702	83304	2212169	83221		
		22007703	83303	22165187	83136		
		22007750	83207 or 89407	22165188	83136		
		22007751	83303	22165189	83136		
				22166442	83136		
				3166657	85700		
				3171068	83216		
				3171069	85304		
				3171462	85005 or 89430		

★ Will be available in first quarter of 2011.

O.E.M. INTERCHANGE

INTERCAMBIOS CON PIEZAS O.E.M.

ARTICLES DU MARCHÉ DES ÉQUIPEMENTS D'ORIGINE

O.E.M. #	GABRIEL #	O.E.M. #	GABRIEL #	O.E.M. #	GABRIEL #	O.E.M. #	GABRIEL #
GMC TRUCK ...Cont'd		GMC TRUCK ...Cont'd		GMC TRUCK ...Cont'd		GRANNING SUSPENSION	
4975501	85700	5531435	85307	5554596	85303 or 89422	680162	85300 or 89419
4975510	83221	5531436	85307	5554814	85302 or 89420	701071-01	646155
4975511	83303	5531437	85307	5554959	83401	GREAT DANE TRAILER	
4975515	85701	5532026	85304	5554995	85305	18163-01	83207 or 89407
4975516	85702	5532425	83207 or 89407	5559363	83203 or 89436	18164-01	83122 or 89406
4975518	85704	5532433	83207 or 89407	5585939	85307	18165-01	85006
4975538	85700	5532675	85307	684280	83209 or 89414	HENS-20001	85000 or 89436
4975549	83216	5533699	85302 or 89420	8-51630-666-0	85012 or 89413	HENS-20002	85000 or 89436
4975550	85702	5534430	85303 or 89422	8-94454-986-0	G60177	HENS-20126	85323 or 89436
4975552	85711	5534439	85304	8-94454-987-0	G60177	HENS-21292	85052
4984526	83216	5534447	85303 or 89422	8-97083-029-0	G60177	HENS-23566	85000 or 89436
508-89	83155	5544060	85302 or 89420	8-97253665-0	★83159	HENS-23649	85938
5171068	83216	5544112	83216	88963409	85336	HENS-24088	85000 or 89436
5304059	85700	5544581	85302 or 89420	88982682	83136	MER202447	85919
5316784	85700	5544581	85302 or 89420	88982684	83136	REY18165-01	85006
5316791	83219	5544716	85304	88982686	85071	GREYHOUND BUS	
5316792	85305	5544717	85304	88982688	85336	12 TA-01-013	85303 or 89422
5316793	85305	5544812	83308	898098-0580	★83159	12B-5-1	85700
5316794	85700	5544818	85735	898098-0590	★83159	3166657	85700
5316984	85313	5549899	83207 or 89407	898098-1250	G60177	3178154	85735
5321920	85307	5549924	85700	898098-1270	G60177	3178157	85700
5321929	85307	5549925	85304	9-51630-647-1	G60177	3192333	85700
5348631	83203 or 89436	5552111	85304	9-51630-666-0	85012 or 89413	5316984	85313
5352857	85700	5552112	85307	9-51630-666-2	85012 or 89413	690029	85700
5352858	85305	5552114	83216	90044769	83207 or 89407	GRUMMAN BUS	
5353054	85303 or 89422	5552205	83217	90044770	83207 or 89407	22024506	85703
5355798	85307	5552206	83214	94033786	83114	22025066	85703
5357955	85300 or 89419	5552207	83217	94051090	83114	22025067	85704
5357956	85734	5552208	83217	94454987	G60177	22025305	85704
5357959	85300 or 89419	5552209	83215	97-2210-00153	85701	97-2201-00001	85703
5361994	85734	5552210	85308 or 89422	97-2210-00164	85708	97-2201-00002	85703
5374779	85308 or 89422	5552244	85308 or 89422	97-2210-00170	85733	97-2201-00003	85703
5374999	85307	5552285	83214	97083027	G60177	97-2201-00004	85703
5385939	85307	5552286	83217	97083029	G60177	97-2201-00005	85703
5392387	85303 or 89422	5552287	83217	97201960	G60177	97-2210-00001	85704
5394448	85305	5552288	83217	97253620	G60177	97-2210-00002	85704
5394467	85305	5552451	85308 or 89422	97253665	★83159	97-2210-00003	85704
5394468	85735	5552452	85303 or 89422	98098058	★83159	97-2210-00004	85704
5455798	85307	5552453	85301	98098059	★83159	97-2210-00005	85704
5513489	83216	5552454	85302 or 89420	98098125	G60177	HARDEE MFG	
5513716	85304	5552456	85307	98098127	G60177	8030223	83207 or 89407
5516459	85305	5552527	85735	L-12706	83155	AS789B	85014
5522781	85735	5554184	85302 or 89420	U0109-014	83400	HAUSMAN	
5522794	85308 or 89422	5554589	85307	GRANNING SUSPENSION		695110	85318
5522818	85305			1085	83214	695119	85702
5527001	85300 or 89419			2697	85712	695198	85706
5527271	85700						85706
5527272	85700						
5527606	85305						
5531027	85301						

★ Will be available in first quarter of 2011.

O.E.M. INTERCHANGE

INTERCAMBIOS CON PIEZAS O.E.M.

ARTICLES DU MARCHÉ DES ÉQUIPEMENTS D'ORIGINE

O.E.M. #	GABRIEL #	O.E.M. #	GABRIEL #	O.E.M. #	GABRIEL #	O.E.M. #	GABRIEL #
HENDRICKSON SUSPENSION		HENDRICKSON TRAILER		HENDRICKSON TRAILER		HENDRICKSON TRAILER	
A-14496	646155	SUSPENSION ...Cont'd		SUSPENSION ...Cont'd		SUSPENSION ...Cont'd	
HENDRICKSON TRAILER		680756	85323 or 89436	B-23013	85000 or 89436	S-21947	85052
SUSPENSION SYSTEMS		680769	85911	B-23014	85738	S-2212	85029
654951	85000 or 89436	680776	85338	B-23290	83150	S-2213	85010
659024	85052	98583-019	85323 or 89436	B-23315	85029	S-2218	85030 or 89440
665190	85006	98583-020	89414	B-23316	89437	S-2230	85005 or 89430
665246	85043	A-10348	85043	B-23361	85911	S-22311	85045
665405	85030 or 89440	A-14583	85000 or 89436	B-23362	89437	S-22312	85939
665406	85010	A-1667	85000 or 89436	B-23548	85079	S-2232	85005 or 89430
665531	85000 or 89436	A-1668	85000 or 89436	B-23566	85000 or 89436	S-22345	85911
665532	85013 or 89414	A-20001	85000 or 89436	B-23649	85938	S-2240	85013 or 89414
665533	85005 or 89430	A-20002	85000 or 89436	B-23650	85052	S-22862	85045
665536	85000 or 89436	A-20012	85000 or 89436	B-23651	85045	S-23013	85000 or 89436
665693	85938	A-20126	85323 or 89436	B-23743	85938	S-23014	85738
665694	85052	A-20345	B-24023	85738	S-23290	83150
665698	85911	A-20819	B-24088	85000 or 89436	S-23315	85029
665733	85045	A-20886	85738 or 89440	B-24125	85323 or 89436	S-23316	89437
665756	85000 or 89436	A-20886	89440	B-24579	85939	S-23361	85911
665758	85938	A-20887	85005 or 89430	B-25436	89430	S-23362	89437
665759	85052	A-20889	85323 or 89436	B-25437	85337	S-23548	85079
665760	85045	A-21292	85052	B-25515	85338	S-23566	85000 or 89436
665761	85911	A-2160	85014	B-26652	85000 or 89436	S-23649	85938
665763	85079	A-2212	85029	B-29432	85323 or 89436	S-23650	85052
665764	85029	A-2213	85010	B-29678	85911	S-23651	85045
665765	83150	A-2218	85030 or 89440	B-29826	85338	S-23743	85938
665766	85000 or 89436	A-2230	85005 or 89430	S-10348	85043	S-24023	85738
665767	85045	A-2232	85005 or 89430	S-14583	85000 or 89436	S-24088	85000 or 89436
671779	89414	A-2240	85013 or 89414	S-1667	85000 or 89436	S-24125	85323 or 89436
671948	85000 or 89436	A-2240-1	85043	S-1668	85000 or 89436	S-24579	85939
680341	85323 or 89436	A-2471	85006	S-20001	85000 or 89436	S-2471	85006
680463	89440	A-4084	85005 or 89430	S-20002	85000 or 89436	S-25436	89430
680467	85323 or 89436	A-4089	83209 or 89414	S-2002	85000 or 89436	S-25437	85337
680509	85738	A-4890	85712	S-20126	85323 or 89436	S-25515	85338
680565	85738	B-21553	85738	S-20886	85738 or 89440	S-26652	85000 or 89436
680566	85938	B-21699	S-20887	85005 or 89430	S-29432	85323 or 89436
680568	85323 or 89436	B-21832	85323 or 89436	S-20889	85323 or 89436	S-29678	85911
680570	89437	B-21936	85938	S-21292	85052	S-29826	85338
680571	85738	B-21947	85052	S-21553	85738	S-4084	85005 or 89430
680573	85939	B-22311	85045	S-2160	85014	S-4089	83209 or 89414
680579	85939	B-22312	85939	S-21699	S-4890	85712
680614	85338	B-22345	85911	S-21832	85323 or 89436	HENDRICKSON TRUCK SUS- PENSION SYSTEMS	
680616	89430	B-22862	85045	S-21936	85938	12738	83225
680617	85337					47902-11	83207 or 89407
680702	85323 or 89436						

★ Will be available in first quarter of 2011.

O.E.M. INTERCHANGE

INTERCAMBIOS CON PIEZAS O.E.M.

ARTICLES DU MARCHÉ DES ÉQUIPEMENTS D'ORIGINE

O.E.M. #	GABRIEL #	O.E.M. #	GABRIEL #	O.E.M. #	GABRIEL #	O.E.M. #	GABRIEL #
HENDRICKSON TRUCK		HENDRICKSON TRUCK		HENDRICKSON TRUCK		HINO ...Cont'd	
SUSPENSION ...Cont'd		SUSPENSION ...Cont'd		SUSPENSION ...Cont'd			
47902-13	83122 or 89406	60670-001	83123 or 89405	659049	83142	485003710A	83126 or 89430
47902-15	83137	60670-002	83207 or 89407	659155	83147	48530-1120	83104
47902-18	85030 or 89440	60670-003	83149	659202	83148	48530-1460	83215
47902-19	83123 or 89405	60670-004	83123 or 89405	659292	83148	48530-1620	83104
47902-25	83125	60670-005	83137	65992-001	85955	48530-1770	83215
47902-26	83144	60670-006	83147	65992-002	85955	48530-1880	83362
47902-27	83123 or 89405	60670-007	83144	665816	85072	48530-1890	83104
47902-28	85013 or 89414	60670-008	83123 or 89405	665892	85072	48530-1900	83104
47902-29	83149	60670-009	85013 or 89414	671006	85036 or 89405	48530-1910	83216
47902-3	85005 or 89430	60670-010	83149	671007	83137	48530-1910	G60107
47902-8	83122 or 89406	60670-011	83148	671009	85919	48530-2050	83217
47902-9	83123 or 89405	60670-013	83148	671030	85083	48530-2510	83216
503610C2	83207 or 89407	60670-017	83148	671063	85083	48530-2510	G60107
5554596	85303 or 89422	60675-001	671063	85083	48530-3280	G60067
57241-001	83111	60675-002	671105	85072	60670-013	83148
57241-002	83109	60675-003	671105	85072	60670-020	83148
57241-003	83112	60675-004	671603	85919	66639	G60164
57241-004	83110	60675-005	671606	85955	S4850-01941	83141
57241-006	83111	60675-006	671611	85955	S4850-01950	83216
57324-11	85305	60680-001	83111	671704	85904	S4850-02750	83216
57324-5	85903	60680-002	83109	671764	★85967	S4850-03710	83126 or 89430
57324-6	85904	60680-003	83112	671792	★85965	S4850-03720	83140
58913-003	85932 or 89453	60680-004	83143	671793	★85966	S4853-01900	83104
59048-001	83148	60680-005	83142	671798	85962	S4853-01910	83216
59057-001	83137	60680-009	85083	672009	85903	S4853-02510	83216
59057-002	85036 or 89405	60680-012	85083	680091	85303 or 89422	S4853-02510	83216
59483-000	85919	60685-001	680600	85305	S4853-03280	G60067
60657-003	85072	60998-001	85337	70018	85303 or 89422	S4853-03290
60657-007	85072	64838-001	85933 or 89454	70021	85303 or 89422	HOBBS TRAILERS	
60665-001	64838-002	85933 or 89454	70088	85307	680117	85300 or 89419
60665-002	654890	83207 or 89407	98583-016	83147	HOLIDAY RAMBLER	
60665-003	83137	654891	83149	AE76164-3	85307	90044794	83127
60665-004	85036 or 89405	654894	83123 or 89405	AE76164-4	83225	HOLLAND (SEE NEWAY)	
60665-005	85919	654895	83137	BE76164-2	85303 or 89422	NULL	
60665-009	85904	654896	83147	BE76164-3	85307	HOLLAND - BINKLEY	
60665-011	★85967	654897	83144	BE76164-4	83225	680298	85321
60665-012	654898	83123 or 89405	HIGHWAY PRODUCT		6898	83125
60665-013	★85965	654900	83149	A1-6-134	83207 or 89407	HUTCHENS SUSPENSION	
60665-014	85962	654903	83111	A1-6-135	83203 or 89436	9423-00	83203 or 89436
60665-015	★85966	654904	83109	HINO		HYSTER	
60665-018	85961	654905	83112	34802	G60107	650150	83217
60665-020	85919	659000	83148	48500-1800	83216	73516	83217
60665-024	85903	659004	83123 or 89405	48500-1801	83216	INGERSALL MACHINE	
		659048	83143	48500-1940	83141	665472	665472
				48500-1941	83141	665904	665472
				48500-1950	83216	INTERNATIONAL (NAVISTAR)	
				48500-1950	G60164	1201-0154	83051
				48500-2750	G60164	1201-0254	83051
				48500-3710	83126 or 89430	1201-1043	83025
				48500-3720	83140	1201-1049	83025
						1201-1049	83025
						1201-9001	83052
						1201-9002	83052
						1201-9003	83052

★ Will be available in first quarter of 2011.

O.E.M. INTERCHANGE

INTERCAMBIOS CON PIEZAS O.E.M.

ARTICLES DU MARCHÉ DES ÉQUIPEMENTS D'ORIGINE

O.E.M. #	GABRIEL #	O.E.M. #	GABRIEL #	O.E.M. #	GABRIEL #	O.E.M. #	GABRIEL #
INTERNATIONAL ...Cont'd		INTERNATIONAL ...Cont'd		INTERNATIONAL ...Cont'd		INTERNATIONAL ...Cont'd	
1201-9007	83054	208664C91	85307	350426C91	85734	3584535C1	85924 or 89457
1201-9008	83054	210533R91	83225	3533356C1	83135		
1201-9009	83054	210534R92	83225	3533356C2	83135	3584535C3	85924 or 89457
1201-9010	83053	210535R91	83225	3533357C1	85957		
1201-9011	83053	210536R91	83225	3533357C2	85957	3586706C2	83145
1202-0012	83023	210537R91	83225	3541456C1	85929	3586883C1	85931 or 89458
1202-0022	83046	210538R91	83225	3544766C1	85930		
1202-0032	83016	210918R91	83215	3544768C1	85926	3586902C2	83146
1202-0042	83025	210919R91	85307	3549099C1	85923 or 89458	3588209C1	85957
1202-0043	83032	210920R91	85308 or 89422			3588209C2	85957
1202-0044	83025			3549099C2	85923 or 89458	3588591C1	85953
1202-0054	83021	2200327C1	85332			3588591C2	85953
1202-1043	83025	2500013C1	83013	3549100C1	85926	3588592C1	85953
1202-1044	83025	2503529C1	83025	3553628C1	85927	3588592C2	85953
1202-1212	83013	2507409C1	83052	3553628C2	85927	3596107C1	85927
1202-1213	83005	2507761C1	83052	3557165C1	83053	3596107C2	85927
1660846C1	83101	2507763C1	83052	3557166C1	83052	3601600C1	85082
1660846C91	83101	2507948C1	83054	3557167C3	83053	3601600C2	85082
1663471C1	83103	2508326C1	83021	3557169C2	83052	360444C91	85012 or 89413
1663606C91	85027 or 89418	2508327C1	83025	3558089C1	85925		
		2509221C91	83054	3558089C2	85925	3605735C1	83156
1664149C1	85029	2509222C91	83053	3558089C3	85925	3605735C2	83156
1664524C1	85935	2509223C91	83054	3558989C1	85925	3606857C1	85954
1664788C2	85316 or 89426	2509224C91	83053	3558989C2	85925	3606857C2	85954
		2585145C1	83051	3560649C2	83052	3609178C1	85955
1667520C1	85058 or 89431	2589922C1	83051	3560705C2	83054	3610198C1	85963
		287318C91	G60021	3571711C1	85316 or 89426	3610199C1	85964
1675455C1	85003 or 89411	288920C91	83225			3613984C1	85955
		288921C91	83225	3571713C1	85333	3620395C1	85931 or 89458
1675496C91	83636	288921R92	83225	3573265C1	85931 or 89458		
1677707C1	85030 or 89440	293009C91	85308 or 89422			3626571C1	85072
				3576464C1	85957	3660548C1	85955
1690035C1	85003 or 89411	294334C91	83216	3576464C2	85957	3660549C1	85955
		3000070C91	83456 or 89447	3578858C1	85926	3813340C1	85964
2012769C2	83005			3578858C2	85926	3813340C2	85964
2012769C2	83005	306444C91	85012 or 89413	3581106C1	85924 or 89457	3813341C1	85963
2015556C1	85316 or 89426					3813341C2	85963
		3085640C92	83216	3581106C2	85924 or 89457	3819277C1	★85969
2015557C1	85030 or 89440	308646C91	85012 or 89413			3819279C1	★85969
				3581106C3	85924 or 89457	383379C91	83308
2018987C1	85003 or 89411	308648C91	83225			384435C91	83216
		308649C91	83216	3581107C1	85924 or 89457	426744R91	85303 or 89422
2023684C1	83015	308650C91	83216				
2023684C1	83015	308650C92	83216	3581107C2	85924 or 89457	426744R92	85303 or 89422
2023685C1	83015	308664C91	85307				
2023685C1	83015	308668C91	85012 or 89413	3581107C3	85924 or 89457	446-511-211	85739
2025790C1	83013					452566C91	83225
2025790C1	83013	308668C92	85012 or 89413	3581109C1	85924 or 89457	453531C91	G60021
2029200C91	83126 or 89430					453556C91	85012 or 89413
		308669C91	85012 or 89413	3581109C3	85924 or 89457		
2032533C1	85316 or 89426					453557C91	G60021
		320444C91	85012 or 89413	3581109C4	85924 or 89457	453561C91	83225
2039549C1	85333					453562C91	83225
2039565C1	83100	329316C92	85012 or 89413	3584117C1	83135	453564C91	85012 or 89413
204994R91	83225			3584117C2	83135		
206620R91	83216	350425C1	85300 or 89419	3584118C1	85957	453565C91	83225
206621R91	83216			3584118C2	85957	453566C91	83225
206621R92	83216	350426C1	85734			453567C91	83216

★ Will be available in first quarter of 2011.

O.E.M. INTERCHANGE

INTERCAMBIOS CON PIEZAS O.E.M.

ARTICLES DU MARCHÉ DES ÉQUIPEMENTS D'ORIGINE

O.E.M. #	GABRIEL #	O.E.M. #	GABRIEL #	O.E.M. #	GABRIEL #	O.E.M. #	GABRIEL #
INTERNATIONAL ...Cont'd		INTERNATIONAL ...Cont'd		ISUZU ...Cont'd		ISUZU ...Cont'd	
453568C91	83225	534464C1	85734	1-51630-217-1	83114	98098125	G60177
453569C91	83225	537524C91	83123 or 89405	1-51630-219-1	83114	98098127	G60177
453570C91	83216			1-51630-304-0	JAY MADSEN	
453571C91	83216	537525C91	83123 or 89405	12474915	83122 or 89406	3166657	85700
453572C91	83309 or 89446	540395C92	83613		83136	3192333	85700
453574C91	85307	548532C1	83103	15123676	85071	JIFFLOX	
453575C91	83308	56101 Z1030	85311 or 89424	15174902	83136	CP5222	85315
453576C91	85303 or 89422	56101 Z2000	85311 or 89424	15887728	83136	KENWORTH	
453576C92	85303 or 89422	56101 Z5008	83114	19152843	83136	1201-1044	83025
453577C91	85308 or 89422	56101 Z5011	G60164	51630168	G60164	1202-0012	83023
453579C91	85308 or 89422	56101-Z5008	83114	51630217	83114	1202-0022	83046
453597C91	83216	56110-T8123	G60091	51630219	83114	1202-0032	83016
462557C91	85300 or 89419	56110-T8129	G60091	51630647	G60177	1202-0042	83025
462753C91	83216	56110-T8129	G60091	51630666	85012 or 89413	1202-0043	83032
467371C91	83225	586724C91	83456 or 89447	60670-005	83137	1202-0044	83025
467372C91	83225	596329C1	85014	8-22064-231-0	85324	1202-0054	83021
467980C91	G60021	60657-003	85072	8-22064-232-0	85071	1202-1043	83025
467983C91	85012 or 89413	60670-007	83144	8-22064-233-0	83136	1202-1046	83049
467984C91	83216	60680-004	83143	8-22064-489-0	85336	1202-1064	83024
467985C91	85012 or 89413	65992-001	85955	8-22064-804-0	83136	1202-1065	83002
471201C91	85012 or 89413	65992-002	85955	8-22064-805-0	83136	1202-1164	83031
471203C91	83308	66400	G60091	8-22064-806-0	83136	1202-1264	83031
472367C91	83318	790335C91	83209 or 89414	8-22064-807-0	83136	16725-01	83221
472411C91	83456 or 89447	873619C92	83314	8-51630-666-0	85012 or 89413	19495-01	85030 or 89440
472412C91	83456 or 89447	873619C93	83314	8-94454-647-1	G60177	1949501	85005
472414C91	83318	873622C91	83308	8-94454-986-0	G60177	3166657	85700
474002C91	83308	874695R91	85012 or 89413	8-94454-987-0	G60177	47902-19	83123 or 89405
477132C1	85303 or 89422	874695R92	85012 or 89413	8-97083-027-0	G60177	47902-24	83137
480945C1	83014	874696R91	85012 or 89413	8-97083-028-0	60657-003	85072
480945C2	83014	90044025	83209 or 89414	8-97083-029-0	G60177	60670-005	83137
4C4Z-18124-N	85957	90044626	83126 or 89430	8-97119-729-0	60670-008	83123 or 89405
4C4Z-18125-DA	85926	AMS 600102	85005 or 89430	8-97253-620-0	G60177	60680-004	83143
501506C91	83317	AMS 600172	85030 or 89440	8-97253-665-0	★83159	60680-005	83142
501553C91	85003 or 89411	AMS 650420	85013 or 89414	8-98098-058-0	★83159	665092	83312 or 89409
501905C91	83301	AMS650420	85013 or 89414	8-98098-125-0	G60177	665118	83312 or 89409
501906C91	83317	AMS66160	83052	8-98098-127-0	G60177	665174	85060
501906C92	83317	AMS66161	83053	8-98098059-0	★83159	665331	83353
503550C1	83207 or 89407	ISUZU		88982682	83136	665453	85001 or 89410
503610C1	83207 or 89407	1-51630-160-0	88982686	85071	665565	85007 or 89412
503610C2	83207 or 89407	1-51630-167-0	898098-1250	G60177	665617	85031
506911C91	1-51630-168-1	G60164	898098-1270	G60177	665670	85001 or 89410
507202C1	85030 or 89440	1-51630-180-3	9-51630-647-1	G60177	665680	83312 or 89409
		1-51630-215-0	9-51630-666-0	85012 or 89413	665753
		1-51630-217-0	83114	9-51630-666-2	85012 or 89413	665828	85067 or 89451
				94033786	83114	665858	85070
				94454986	G60177	★89459	★89459
				94454987	G60177	665903	85900
				97083027	G60177		
				97083029	G60177		
				97253620	G60177		
				97253665	★83159		
				98098058	★83159		
				98098059	★83159		

★ Will be available in first quarter of 2011.

O.E.M. INTERCHANGE

INTERCAMBIOS CON PIEZAS O.E.M.

ARTICLES DU MARCHÉ DES ÉQUIPEMENTS D'ORIGINE

O.E.M. #	GABRIEL #	O.E.M. #	GABRIEL #	O.E.M. #	GABRIEL #	O.E.M. #	GABRIEL #
KENWORTH ...Cont'd		KENWORTH ...Cont'd		LINK MANUFACTURING		MACK ...Cont'd	
665906	85902	K374-33	83312 or 89409	...Cont'd		14QK-2100P2	83209 or 89414
665944	85900			654811	83024		
665945	85902	K374-4	85314 or 89425	654833	83021	14QK-2100P3	83207 or 89407
671656			654847	83002		
671962	85936 or 89456	K374-5	83312 or 89409	654849	83031	14QK-2100P4	83207 or 89407
				654867	83025		
671963	85937	K374-7	85310 or 89423	LG40450	83016	14QK-2100P5	83221
675041	83353			LG40470	83016	14QK-2100P6	85036 or 89405
675122	85001 or 89410	K374-9	85310 or 89423	R71-1004	83049	14QK-2100P7	83221
				R71-1005	83024	14QK-2100P8	83242
680475	85314 or 89425	K374-C31	83312 or 89409	T71-1000	83031	14QK-2102	85304
				T71-1001	83031	14QK-2105	83209 or 89414
680476	85310 or 89423	K374-C7	85310 or 89423	T71-1002	83002		
				LINK MANUFACTURING LTD.			
680486	85310 or 89423	KW1102-B	83016	1210-0528	85904	14QK-2107	83215
		KWE90112	83016	671093	85904	14QK-2107P1	83215
680586	85311 or 89424	PP2582.870	83012	LINK/HIGH-STEER			
		R71-1004	83049	1210-0001	646155	14QK-2107P2	83215
		KWK-LOC (JIFFLOX)		1210-0005	85734	14QK-2107P3	83215
70701	85900	CP-5222	85315	1210-0007	665937	14QK-2108	83203 or 89436
90044089	83124 or 89407	LINK MANUFACTURING		1210-0010	646155	14QK-2110	85305
		1201-0012	83023	1210-0012	646155	14QK-2110P1	85305
90045068	89441	1201-0154	83051	632155	646177	14QK-2111	83019
90045099	85906	1201-0254	83051	LODAL, INC.			
90045132	85909	1201-1043	83025	9960257	83122 or 89406	14QK-2111-P2	83019
96027.10545	83011	1201-1044	83025	M.A.N. BUS			
ACHB966	83136	1201-1212	83013	134	85709	14QK-2111-P4	83019
B71-6004	★85084 or 89460	1201-1213	83005	25-1700-106-654	85708	14QK-2113	85001 or 89410
		1201-1213	83005	81-43701-6537	85709		
B71-6005	★85084 or 89460	1201-9001	83052	81-43701-6538	85708	14QK-2113M	85001 or 89410
		1201-9002	83052	81-43701-6539	85708		
B71-6006	★85084 or 89460	1201-9003	83052	81-43701-6543	85708	14QK-2113P3	85007 or 89412
		1201-9007	83054	81-43701-6572	85708	14QK-2113P4	85001 or 89410
C71-1002	85067 or 89451	1201-9008	83054	81-43701-6573	85722	14QK-2113P5	85007 or 89412
		1201-9009	83054	81-43701-6609	85709	14QK-2113P6	85001 or 89410
C71-1011	85069 or 89455	1201-9010	83053	9020M-1042	85709	14QK-2115	85305
		1201-9011	83053	MACK			
K374-11	85001 or 89410	1202-0012	83046	1202-0012	83023	14QK-2133M	85001 or 89410
		1202-0022	83046	1202-0022	83046		
K374-13	83353	1202-0032	83016	1202-0032	83016	14QK-2136M	85061 or 89450
K374-13-1	83353	1202-0042	83025	14QK-1200P4	83207 or 89407	14QK-282P3	83216
K374-14	83312 or 89409	1202-0043	83032	14QK-140	85304	14QK-288P2	83217
		1202-0044	83025	14QK-140P1	83225	14QK-29001P2	85303 or 89422
K374-15	83353	1202-0052	83021	14QK-142	85305	14QK-29301P1	83207 or 89407
K374-16	85001 or 89410	1202-0054	83021	14QK-142AP1	83215	14QK-29301P2	83207 or 89407
		1202-1042	83025	14QK-142P1	83215		
K374-26	85001 or 89410	1202-1043	83025	14QK-143	83207 or 89407	14QK-29302	83207 or 89407
		1202-1044	83025	14QK-145	85307	14QK-29302	83207 or 89407
K374-27	85001 or 89410	1202-1064	83024	14QK-20001P2	85308 or 89422	14QK-29302P1	83207 or 89407
		1202-1065	83002	14QK-2100D-P4	83207 or 89407		
K374-28	85314 or 89425	1202-1164	83031	14QK-2100P1	83221	14QK-29303-P2	83014
		1202-1212	83013			14QK-3100	85739
K374-29	85310 or 89423	1202-1213	83005				
		632120	83046				
K374-3	83312 or 89409	632129	83023				
		635705	83016				
K374-3-1	83312 or 89409	654669	83021				
		654799	83025				
K374-32	85310 or 89423						

★ Will be available in first quarter of 2011.

O.E.M. INTERCHANGE

INTERCAMBIOS CON PIEZAS O.E.M.

ARTICLES DU MARCHÉ DES ÉQUIPEMENTS D'ORIGINE

O.E.M. #	GABRIEL #	O.E.M. #	GABRIEL #	O.E.M. #	GABRIEL #	O.E.M. #	GABRIEL #
MACK ...Cont'd		MACK ...Cont'd		MACK ...Cont'd		MAECO ...Cont'd	
14QK-3101M	85066 or 89448	14QK-396M	85005 or 89430	64838-002	85933 or 89454	70331	85314 or 89425
14QK-3103M	83050	14QK-399M	83045	651012	83221	70332	83314
14QK-3107M	85061 or 89450	14QK-399M2	83045	651103	85036 or 89405	70334	85316 or 89426
14QK-3108	85080	14QK-399M3	83045	651151	83209 or 89414	70397	85006
14QK-3108M	85080	14QK-410M	83125	70042	85302 or 89420	70402	85305
14QK-3114M	85061 or 89450	14QK-410M2	83137	SDA14170000380	85061 or 89450	70652	85030 or 89440
14QK-3116M	83101	14QK-410M3	83125	SDA471700000431	85066 or 89448	70663	85013 or 89414
14QK-366	85036 or 89405	14QK-411	83007	SDA471700002861	85014	70720	85934
14QK-366P1	85036 or 89405	14QK-411M	83007	V10234121	83105	70721	83125
14QK-366P2	85036 or 89405	14QK-413M4	83110	V10242320	83105	74039	85303 or 89422
14QK-366P3	85036 or 89405	14QK-413M5	83138	MAECO		MARMON	
14QK-366P4	83209 or 89414	14QK-413M6	83111	12608	83125	1-7001	83216
14QK-372M	83221	14QK-413M7	83111	12788	83216	1202-0022	83046
14QK-372M2	83209 or 89414	14QK-414M	85906	12866	83207 or 89407	1202-0054	83021
14QK-372M3	83122 or 89406	14QK-414M2	85909	16385	83215	37-1-1	83122 or 89406
14QK-373	83215	14QK-415M	83112	1668722	85030 or 89440	51-139-28	85003 or 89411
14QK-375M	83123 or 89405	14QK-421M	85014	16720	83107	51-163-7	83123 or 89405
14QK-376	83003	14QK-422M	85933 or 89454	16949	83120	576451	83122 or 89406
14QK-377M	83215	14QK-424M	83147	16950	83118	665147	83216
14QK-378	83215	14QK-427M	85080	6025	83122 or 89406	MATSON SCHOOL BUS	
14QK-378M	83215	14QK-428	85080	6026	83204	5392387	85303 or 89422
14QK-382	83018	14QK-428M	85080	70018	85303 or 89422	MC NEILUS TRUCK & MAN. COMPANY	
14QK-382-P2	83018	14QK-431M	85061 or 89450	70021	85303 or 89422	217330	85303
14QK-390	83105	14QK-434M	85014	70029	85308 or 89422	600.115994B	632147
14QK-391AM	83041	14QK-493M	70034	85302 or 89420	600.11599C	630811
14QK-391AM	83041	202SU14	70039	85302 or 89420	600.11599M	632147
14QK-391AM2	83041	20513881	85061 or 89450	70041	85303 or 89422	600.188206	646155
14QK-391BM	83041	20570098	83147	70042	85305	MERCEDES	
14QK-391BM2	83041	20863239	85080	70042	85302 or 89420	344-323-75	83100
14QK-392AM	85005 or 89430	20874147	83050	70088	85307	MERITOR	
14QK-392AM2	83123 or 89405	20897198	85061 or 89450	70123	85716	14QK-3100	85739
14QK-392AM3	85005 or 89430	20973993	85061 or 89450	70127	85006 or 89401	202447	85919
14QK-392BM	85005 or 89430	20998401	85014	70127	85006 or 89401	21227751	87015
14QK-392BM2	85321	21010744	83101	70128	85006 or 89401	446-511-211	85739
14QK-392BM3	85005 or 89430	21155033	70162	85006 or 89401	654907	85000 or 89436
14QK-392M	85005 or 89430	4103-5000447861	83105	70163	85716	671020	87015
14QK-393AM	83123 or 89405	4103-5000546892	83105	70166	85302 or 89420	671507	87015
14QK-393M	85010	446-511-211	85739	70166	85302 or 89420	671907	85919
14QK-396	85005 or 89430	4717000002861	85014	70166	85716	680705	85737
		471700002626	85061 or 89450	70300	85320 or 89429	700115	85712
		47902-25	83125	70312	85001 or 89410	A-3280-M-9711	85919
		47902-9	83123 or 89405	70315	85063	A-7805L-1000	85919
		4940654	83216	70317	89432	A-7805L-1026	87015
		5533699	85302 or 89420			A-7805P-1030	85737
		5554184	85302 or 89420				
		60670-006	83147				
		60670-6	83147				

★ Will be available in first quarter of 2011.

O.E.M. INTERCHANGE

INTERCAMBIOS CON PIEZAS O.E.M.

ARTICLES DU MARCHÉ DES ÉQUIPEMENTS D'ORIGINE

O.E.M. #	GABRIEL #	O.E.M. #	GABRIEL #	O.E.M. #	GABRIEL #	O.E.M. #	GABRIEL #
MITSUBISHI- FUSO		MOTOR COACH IND ...Cont'd		MOTOR COACH IND ...Cont'd		MUNCIE RECLAMATION	
MB025382	12-05-1147	★85341	22012067	85700	665568	85051
MB161497	G60003	12-05-1148	★85970	22012079	85701	97-2210-00164	85708
MB161741	12-05-1150	85711	22024061	85704	H53-20415-006	85051
MB161748	12-05-1165	85711	22024673	85710	MR-6394	85723
MB294287	12-05-1166	★85341	22045526	85702	MR-6536
MC110328	12-05-1170	★85340	22046485	85710	MR1623	85700
MC114595	G6003	12-05-1176	85728	22052014	85702	MR1710	85713
MC809295	12-05-1177	85729	3178154	85735	MR1751	85713
MC809390	83103	12-05-1178	85339	3178157	85700	MR1763	85300 or 89419
MC811327	12-05-1179	85727	4975515	85701	MR1765	85713
MC813135	83456 or 89447	12-05-1188	★85970	5316984	85313	MR25767	85702
		12-05-1194	85339	6314933	85708	MR2960	85702
MC813511	G60046	12-05-1228	85711	654789	★83158	MR2961	85701
MC814614	85009	12-05-6000	85711	680231	85313	MR2966	85704
MC826268	G60164	12-05-6001	★85740	680232	85733	MR2997	85703
		12-05-6002	85339	680322	85704	MR3303	85709
MOHAWK		12-05-6033	85339	680323	85700	MR3304	85710
01-0100-905	85303 or 89422	12-05-6053	85711	680332	85701	MR3304H	85709
		12-05-6054	★85740	680333	85708	MR3306	85705 or 89447
020273544	83203 or 89436	12-05-6055	85339	680350	85710	MR3307	85707
		12-05-6068	85727	680369	85708	MR3650	85707
050134508	85718	12-5-1-G	85700	680374	85728	MR6535	85708
10134504	85715	12-5-1-GS	85700	680441	85729	MR7388	85710
10134506	85714	12B-5-1	85700	680452	85339		
10234503	85714	12B-5-1-G	85700	680462	85728		
10234504	85717	12G-5-1	85700	680470	85713		
1235233	85736	12J-5-10	85733	680482	85727	NATIONAL COACH CORP	
22012079	85701	12J-5-10GS	85733	680485	85733	C800853	83207 or 89407
22012082	85702	12J-5-11	85313	680544	85711		
22012114	85700	12J-5-2	85312	680546	85339	NEOPLAN BUS	
4968853	83216	12J-5-3	85313	680602	85339	24-1700-106-149	83216
6-367-7	85305	12J-5-4	85312	680677	85728	24-1700-999-362	85009
680323	85700	12J-5-6	85313	680680	85729	25-1700-101-426	85705 or 89447
680332	85701	12J-5-7	85312	680681	85727	680307	85705 or 89447
680485	85733	12J-5-71	85733	690029	85700	680308	85706
695195	85707	12J-5-9	85700	695117	85701	97-9999-02519	85707
695196	85707	12K-5-1	695125	85704	AA1002002	85705 or 89447
97-2201-00007	85703	12L-4-170	★83158	74410	85701	AA1002003	85705 or 89447
97-2201-00011	85704	12L-5-100	85727	85729	85729	AA1802002	85705 or 89447
97-9999-02320	85704	12L-5-114	85727	97-2201-00151	85700	AC1002002	85705 or 89447
MM-6886	83207 or 89407	12L-5-58	85728	97-2210-00164	85708	AC1002003	85705 or 89447
		12L-5-67	85728	97-9999-02514	85700	BN1002002	85009
MM-6957	83225	12L-5-69	85700	97-9999-02634	85733	BT1002011	83216
MM-74029	85308 or 89422	12L-5-70	85700	G1011822	85702	CI 1002003	85705 or 89447
		12L-5-71	85708	G1101590	85713	CL1002003	85705 or 89447
MOR-RYDE SUSPENSION		12L-5-72	G1201338	85710	DT1002002	85707
U0109-014	83400	12L-5-88	85729	G1201339	85702	DT1802002	85705 or 89447
U0109-7	G60028	12L-5-89	85729	G5008069	85700	DZ1002002	85705 or 89447
MOTOR COACH INDUSTRIES		12L-5-96	85728	T14-1029	85701		
12-05-1021	★85340	12L-5-97	85728	T14-1045GS	85700		
12-05-1022	★85970	12L-5-99	85339	T14-1048	85302 or 89420		
12-05-1101	★85340	12T-1-13	85303 or 89422				
12-05-1102	★85970			T14-1080	85728		
12-05-1137	★85340	12TA-01-013	85303 or 89422	T14-1081	85729		
12-05-1138	★85970			T14-1082	85727		
12-05-1139	★85341						
12-05-1142	★85340	1497835	85711				
12-05-1146	★85340	1498565	85339				

★ Will be available in first quarter of 2011.

O.E.M. INTERCHANGE

INTERCAMBIOS CON PIEZAS O.E.M.

ARTICLES DU MARCHÉ DES ÉQUIPEMENTS D'ORIGINE

O.E.M. #	GABRIEL #	O.E.M. #	GABRIEL #	O.E.M. #	GABRIEL #	O.E.M. #	GABRIEL #
NEOPLAN BUS ...Cont'd		NOVA BUS ...Cont'd		ORION BUS INDUSTRIES		OSHKOSH MOTORS ...Cont'd	
GJ1002002	85706	74410	85701	070231527	85729	5353054	85303 or 89422
GJ1002003	85705 or 89447	97-2201-00151	85700	20117501	85720	5361994	85734
MM1002002	85705 or 89447	97-9999-02514	85700	20117503	85720	651444	83221
MM1002003	85705 or 89447	G1011822	85702	20117505	85720	665040	85303 or 89422
NEW FLYER		G1011823	85710	665596	85719	665060	83122 or 89406
009863	85722	G1101590	85713	680091	85303 or 89422	690049	85303 or 89422
015813	85708	G1201338	85710	680271	85714	GBL654875	83117
015915	85711	G1201339	85702	680274	85716	GBL654918	83118
064845	85711	G5008070	85700	680328	85717	P101977	85010
152959	85708	N16248	85377	680352	85711	P117099	83120
16415	85727	N16249	85378	680378	85720	P117146	83118
680346	85722	N21543	85378	695327	85732	OSTERLUND TRUCK	
680352	85711	N22212	85700	695343	85732	220-S5-10	85712
680671	85708	N22212	85700	695366	85732	59011	83214
97-2210-00164	85708	N31830	85378	695389	★87016	680117	85300 or 89419
G1011823	85710	N31831	85377	695420	85729	OTTAWA TRUCK	
NEWAY SUSPENSION SYSTEMS		OLE GRANNING		695421	★87016	53540451	85300 or 89419
632155	646177	1086	83217	695440	85729	59009	83217
90045331	646155	OPTIMA BUS CORP		97-9999-02635	85718	680117	85300 or 89419
NISSAN		90-2610-SP1	★87017	97-9999-02636	85716	90013787	85310 or 89423
56101-30Z01	★83161	ORION BUS INDUSTRIES		A-4890	85712	90027577	85720
56101-30Z02	G60107	010134501-4	85307	M340027	9007342	85303 or 89422
56101-Z5008	83114	010134504-4	85715	OB3166657	85700	PACIFIC TRUCK & TRAILER	
56101-Z5017	★83162	010134505-4	85715	OSHKOSH MOTORS		3178157C	85735
56110-30Z01	★83161	010134506-4	85717	1202-0054	83021	507202C1	85030 or 89440
56110-30Z02	G60107	010134508-4	85718	12405F	85734	PAGE SUSPENSION	
56110-T8123	G60091	010134509	85717	12405F-1	85303 or 89422	1080099	83203 or 89436
56110-T8129	G60091	010234503-4	85308 or 89422	12405FX1	85303 or 89422	1081933	83204
56110-Z5008	83114	010234506	85714	1398980	83127	665133	83203 or 89436
56110-Z5011	G60164	020117504	85720	1445910	85300 or 89419	665267	85029
56110-Z5017	★83162	020273541	83203 or 89436	1573270	83207 or 89407	A-2212	85029
56201-Z5001	★85085	020273541-4	85000 or 89436	1573280	83221	PAI CORP	
56210-Z5001	★85085	020273544	83203 or 89436	1583470	85051	HSA-5067	85305
66400	G60091	020273546	85719	1745500	89430	HSA-5080	83221
NOVA BUS		020273547	85719	2034140	646177	HSA-5095	83215
12J-5-10	85733	020273547-4	85719	2173340	85303 or 89422	PEERLESS TRAILER	
12J-5-11	85313	020273548	85719	2218640	83009	120-1	83125
22012079	85701	020273549	85719	26228-A	83122 or 89406	72-61	83125
22024673	85710	0501345-11	85718	2JD137	83119	PETERBILT	
22045526	85702	050134501-4	85716	3638112	G60028	02-00376	85302 or 89420
22052014	85702	050134502-4	85718	40-0242	83312 or 89409	02-00495	85302 or 89420
481700131250	85377	050134506-4	85718	40-4845	85304	02-01787	85062 or 89408
481700131252	85378	050134508	85718	40-4951	85316 or 89426		
4975515	85701	050134510	85732	40-5348	85058 or 89431		
680231	85313	050134513	85732	40-6967	85030 or 89440		
680232	85733	050230501	85716				
680323	85700	050231502-4	85716				
680326	85700	050231505	85716				
680470	85713	050231507	85716				
680480	85377	060231508	85717				
680481	85378	070131502	★87016				
695117	85701	070131506	★87016				
		070231514	85729				

★ Will be available in first quarter of 2011.

O.E.M. INTERCHANGE

INTERCAMBIOS CON PIEZAS O.E.M.

ARTICLES DU MARCHÉ DES ÉQUIPEMENTS D'ORIGINE

O.E.M. #	GABRIEL #	O.E.M. #	GABRIEL #	O.E.M. #	GABRIEL #	O.E.M. #	GABRIEL #
PETERBILT ...Cont'd		PETERBILT ...Cont'd		PETERBILT ...Cont'd		PREVOST ...Cont'd	
02-01890	85012 or 89413	16725-01	83221	680459	85311 or 89424	680323	85700
02-02061	85013 or 89414	20-16755	83042	680586	85311 or 89424	680422	85329
02-02142	85036 or 89405	20-18744	..	680599	680492	85713
02-02225	85012 or 89413	23-08233	85308 or 89422	90044011	85004	680510	85330
02-02736	85302 or 89420	23-10393	85308 or 89422	96027.1054	83011	680555	85330
02-02737	85062 or 89408	23-12262	85012 or 89413	ACHB966	83136	690060	85713
02-02738	85012 or 89413	29-02455	83008	B71-6000	85959	74939852	85308 or 89422
02-02739	85013 or 89414	29-06005	83035	B71-6002	85012 or 89413	G1011822	85702
02-02740	85036 or 89405	29-06032	83035	C71-1002	85067 or 89451	G5008070	85700
02-02741	85012 or 89413	60680-004	83143	C71-1011	85069 or 89455	N16249	85378
02-02742	85062 or 89408	60680-005	83142	C71-6000	85067 or 89451	N22212	85700
02-03020	85910	654782	83008	PP2582.870	83012	RAYDAN MANUFACTURING	
02-04010	85012 or 89413	654812	83042	R71-6000	..	14QK-3100	85739
03-01635	85308 or 89422	654919	83035	PIERCE MANUFACTURING		446-511-211	85739
03-04176	85308 or 89422	665133	83203 or 89436	1445910	85300 or 89419	700115	85712
03-04628	85336	665174	85060	2034140	646155	RED LION TRAILER	
03-04629	85311 or 89424	665633	85033 or 89427	40-0242	83312 or 89409	90044978	85059
03-05106	85033 or 89427	665655	85062 or 89408	40-4845	85304	90045019	85913
03-05384	85033 or 89427	665656	85012 or 89413	40-4951	85316 or 89426	REX	
03-06084	85033 or 89427	665657	85013 or 89414	40-5348	85058 or 89431	102-31602-01	630811
03-07281	85311 or 89424	665658	85036 or 89405	40-6967	85030 or 89440	REYCO SUSPENSION	
03-07420	85336	665660	85033 or 89427	PREVOST		12885-01	85300 or 89419
03-07421 or 89424	665662	85012 or 89413	01-0100-905	85303 or 89422	12885-03	85300 or 89419
03-07421	85311 or 89424	665738	85910	12B-5-1	85700	12887-01	85013 or 89414
03-07423	85033 or 89427	665752	85067 or 89451	12L-5-89	85729	12887-02	85013 or 89414
03-07424	85311 or 89424	665762	85012 or 89413	12T-1-13	85303 or 89422	14954-01	83217
03-08781	85069 or 89455	665826	85069 or 89455	19501288	85729	16230-01	85702
1202-0012	83023	665876	85959	19501289	85728	16725-01	83221
1202-0022	83046	671091	85069 or 89455	196347	85710	16824-01	85006
1202-0032	83016	671092	85012 or 89413	196533	85708	17142-01	85001 or 89410
1202-0054	83021	680026	85012 or 89420	3166657	85700	17146-01	83209 or 89414
1202-1044	83025	680027	85308 or 89422	52001	85708	17358-01	85030 or 89440
12887-01	85013 or 89414	680185	85308 or 89422	63-0001	85713	17403-01	85003 or 89411
12887-02	85013 or 89414	680348	85012 or 89413	63-0080	85713	17408-01	85005 or 89430
		680435	85033 or 89427	63-0091	85736	17794-01	83215
		680457	85302 or 89420	63-1013	85329	18146-01	85313
		680458	85336	630127	85736	18163-01	83207 or 89407
				630134	85329	18164-01	83122 or 89406
				630136	85330	18165-01	85006
				630163	85330	18166-01	85704
				630251	18286-01	89414
				630252	18800-01	85000 or 89436
				630253	19495-01	85030 or 89440
				630254		
				650407	85736		

★ Will be available in first quarter of 2011.

O.E.M. INTERCHANGE

INTERCAMBIOS CON PIEZAS O.E.M.

ARTICLES DU MARCHÉ DES ÉQUIPEMENTS D'ORIGINE

O.E.M. #	GABRIEL #	O.E.M. #	GABRIEL #	O.E.M. #	GABRIEL #	O.E.M. #	GABRIEL #
REYCO SUSP. ...Cont'd		RIDEWELL CORPORATION		SAF HOLLAND ...Cont'd		SAF HOLLAND ...Cont'd	
19623-01	83123 or 89405	1275943B	85005 or 89430	680268	85323 or 89436	90044915	83127
19824-01	85006	57645	85005 or 89430	680645	85321	90044968
20125-01	85030 or 89440	665198	85005 or 89430	90044001	85005 or 89430	90044977	83115
20126-01	89440	665267	85005 or 89430	90044008	85000 or 89436	90044978	85059
20129-01	85713	665526	85014	90044011	85004	90044979	83113
20960-01	83204	680101	85702	90044012	85006	90044980	85907
21497-01	85005 or 89430	90-2610-SP1	★87017	90044016	85300 or 89419	90044981	85000 or 89436
23524-01	85738	90F-2152	90044017	83204	90044982	85000 or 89436
23553-01	85938	AS1894B	90044025	83209 or 89414	90044991	85000 or 89436
23614-01	85717	AS30698	85005 or 89430	90044046	83123 or 89405	90044992	85000 or 89436
24392-01	85051	AS3069B	85005 or 89430	90044071	85000 or 89436	90045000	85906
665519	89414	AS546B	85006	90044081	85000 or 89436	90045001	85323 or 89436
665813	85051	AS563B	83203 or 89436	90044086	85000 or 89436	90045002	85906
665830	85045	AS575B	85005 or 89430	90044089	83124 or 89407	90045003	85323 or 89436
665833	85052	AS789B	85014	90044089C	83124 or 89407	90045019	85913
671707	85052	AS789B000	85014	90044095	83203 or 89436	90045028	85907
680551	85738	S2607B	85702	90044162	83128	90045031	★85968
680552	85938	S4025B	85734	90044162	83128	90045040	83130
680700	85938	S5477B	85307	90044448	85051	90045048	85905
700098-01	83203 or 89436	S5478B	85307	900444625	83125	90045049	85905
700098-03	85052	S5813B	85704	90044626	83126 or 89430	90045050	85914
702135-01	85045	S5878B	83207 or 89407	90044626	83126 or 89430	90045053	85908
702136-01	85052	S6009B	83203 or 89436	90044642	83127	90045054	85051
702209-01	85014	S7120B	85304	90044642	83127	90045068	89441
704672-01	85938	S7172B	83207 or 89407	90044679	83122 or 89406	90045075	85911
REYCO/GRANNING		S7249B	85307	90044680	83125	90045080	85912
701071-01	665937	S7365B	85305	90044681	83204	90045083	85910
RIDEWELL CORP.		SAF HOLLAND		90044682	83209 or 89414	90045084	★85968
1310002	665937	57639	85000 or 89436	90044683	83122 or 89406	90045096	85916
1310004	665937	57643	85013 or 89414	90044684	83124 or 89407	90045099	85906
1317570B001	646155	6025	83122 or 89406	90044685	83128	90045110	83137
RIDEWELL CORPORATION		6026	83204	90044686	85051	90045132	85909
1250005	85901	665002	85004	90044687	83125	90045138	85910
1250546B000	85006	665003	85300 or 89419	90044688	83122 or 89406	90045175	85916
1250563B000	85000 or 89436	665197	85051	90044769	83207 or 89407	90045188	85910
1250789B000	85014	665454	85045	90044770	83207 or 89407	90045207	89405
1252607B000	85702	665514	83127	90044779	83127	90045298	83128
1253069B000	85005 or 89430	665969	89430	90044833	85052	90045299	85000 or 89436
1254025B000	85712	671921	85916	90044834	85052	90045337	85911
1260008	★87017	671922	89405	90044868	85045	90045338	85060
12651527B000	85712	671923	89440	90044878	85045	90045381	83150
1265583B001	671931	85916	90044907	83635	90045384	89430
1267120B000	85734	680234	85906			90045418	85916
1267395B000	85302 or 89420					90045419	89405
1270007	85045					90045420	89440
1270563B000	85000 or 89436					90045432	85321
1270563B003	85934					90045433	85916
1270789B000	85014					90045455	85909
1275813B000	85704					90045466	89406
						90045471	83150
						90045504	85030

★ Will be available in first quarter of 2011.

O.E.M. INTERCHANGE

INTERCAMBIOS CON PIEZAS O.E.M.

ARTICLES DU MARCHÉ DES ÉQUIPEMENTS D'ORIGINE

O.E.M. #	GABRIEL #	O.E.M. #	GABRIEL #	O.E.M. #	GABRIEL #	O.E.M. #	GABRIEL #
SAF HOLLAND ...Cont'd		STERLING TRUCK ...Cont'd		STERLING TRUCK ...Cont'd		THOMAS SCHOOL BUS	
AR-1008	85006	47902-28	85013 or 89414	F6HT-18045-EC	85055 or 89439	128745	83102
AR-1141	83204	4C4Z-18124-N	85957	F6HT-18045-GC	85030 or 89440	300-0614966	85307
AR-1141-C	83204	4C4Z-18125-DA	85926	F6HT-18045-HB	85054 or 89438	6130-0114	89437
AR-1202	85300 or 89419	57241-2	83109	F6HT-18045-HC	85054 or 89438	61300112	83613
AR-134-C	85005 or 89430	6803230200	85043	F6HT-18045-JB	83200	61300224	85918 or 89449
AR-1404	85301	6803230300	85006	F6HT-18045-JC	83200	61300240	85918 or 89449
AR-1425	85301	6803260000	83120	F6HT-18045-JA	83200	61300285	83102
AR-1434	83203 or 89436	680611	85724 or 89443	F6HT-18045-KA	83200	6130029	85712
AR-1654	83209 or 89414	AT-560	G61150	F6HT-18045-LA	85376	61310101	85736
AR-1822	85304	AX267A	83309 or 89446	F6HT-18080-CA	85314 or 89425	61310102	85308 or 89422
AR-2451	83203 or 89436	AX310	83215	F6HT-18080-FC	85013 or 89414	61310103	85308 or 89422
AR-2598	83123 or 89405	C4HZ-18124-E	83309 or 89446	F6HT-18124-JC	83200	61310104	85713
AR-718-C	83203 or 89436	C4TZ-18124-AB	83308	F6HT-18124-KA	83200	61310232	85000 or 89436
AR-718-C-HD	85000 or 89436	D8HZ-18124-A	85301	F6HZ-18124-A	85054 or 89438	61310434	85724 or 89443
AR-781	83203 or 89436	E6HZ-18124-D	85301	F6HZ-18124-B	83308	61310478	85724 or 89443
AR-958	83207 or 89407	E6HZ-18125-D	83215	F6HZ-18124-C	85055 or 89439	614974	85304
AR-995	85734	E7HZ-18124-A	85301	F6HZ-18124-D	85055 or 89439	63-0001	85713
SICARD		E7XZ-18124-A	G60023	F6HZ-18124-E	85055 or 89439	651442	83102
3166657	85700	E7XZ-18125-B	G60024	F6HZ-18124-F	85055 or 89439	659287	83102
SPARTAN MOTORS		E9HZ-18124-A	83309 or 89446	F6HZ-18124-G	85054 or 89438	680-323-0300	85006
0272-SS5	85712	F0HZ-18124-B	85006	F6HZ-18124-H	85054 or 89438	680-326-0000	83120
0346-SS5	85013 or 89414	F1HZ-18124-A	83309 or 89446	F6HZ-18124-I	85054 or 89438	680010	85304
0377-SS5	85029	F1HZ-18124-B	83308	F6HZ-18124-J	83200	680054	85307
59011	83214	F1HZ-18124-C	85006 or 89401	F6HZ-18124-K	83109	680088	85713
78068	85304	F1HZ-18124-D	85006 or 89401	F6HZ-18124-L	85054 or 89438	728802	85736
AS 4025B	85734	F1HZ-18124-E	85006 or 89401	F6HZ-18124-M	83200	87002	85736
B46-1594	85013 or 89414	F1HZ-18124-H	85040	F6HZ-18124-N	83109	A-4890	85712
B46-1725	85029	F1HZ-18124-J	83308	F6HZ-18125-B	85013 or 89414	GBL654725	83120
B46-2151	85007	F1HZ-18124-K	89402	F6HZ-18125-D	85013 or 89414	GBL665538	85006
SPRING VALLEY		F2HZ-18124-A	85376	F81A-18045-AGB	G61150	P101977	85010
632155	646177	F2HZ-18124-B	85301	SDA47170000440	85959	TIMBREN INDUSTRIES	
STERLING		F5HZ-18124-A	83314	SDA471700002809	85724 or 89443	665804	85939
1202-1043	83025	F5HZ-18124-B	83107	XC45-18080-BA	85724 or 89443	TRAILMOBILE CANADA	
18-45067-000	83034	F5HZ-18124-C	85063	STOUGHTON TRAILERS INC.		CORP.	
F6HZ-5K407-AB	83034	F5HZ-18124-D	83125	HTA20001	85000 or 89436	43-4-235	85051
F6HZ-5K407-BA	83033	F5HZ-18124-E	85314 or 89425	HTA20002	85000 or 89436	43-4-236	85029
F8HT-5K407-AA	83033	F5HZ-18125-A	85001 or 89410	NW90044162	83128	43-4-237	85000 or 89436
STERLING TRUCK		F6HT-18045-AA	85054 or 89438	NW90044448	85051	43-4-239	83207 or 89407
10-12388-000	85920	F6HT-18045-AC	85054 or 89438	NW90044978	85059	43-4-241	85006
10-12390-000	85920	F6HT-18045-BC	85047 or 89435	NW90044979	83113	43-4-277	85000 or 89436
10-13592-000	85959	F6HT-18045-CC	85055 or 89439	RT18165-01	85006	43-4-278	85059
1210-0528	85904	F6HT-18045-EB	85055 or 89439	SUSPENSIONS INC.		43-4-279	83204
16-15817-000	85724 or 89443			200188	646155	43-6-028	85000 or 89436
16-18708-000	85724 or 89443			THE BINKLEY COMPANY		43-6-118	85000 or 89436
				16965	85006	43-6-137	85006
				6898	83125		

★ Will be available in first quarter of 2011.

O.E.M. INTERCHANGE

INTERCAMBIOS CON PIEZAS O.E.M.

ARTICLES DU MARCHÉ DES ÉQUIPEMENTS D'ORIGINE

O.E.M. #	GABRIEL #	O.E.M. #	GABRIEL #	O.E.M. #	GABRIEL #	O.E.M. #	GABRIEL #
TRAILMOBILE CANADA		TRANSPORTATION MFG.		VOLVO ...Cont'd		VOLVO ...Cont'd	
CORP. ...Cont'd		CORP ...Cont'd		1091367	85000 or 89436	22046483	85304
43-6-158	85013 or 89414	695279	85710	1091368	85003 or 89411	22052336	85304
43-6-164	83207 or 89407	74410	85701	1091370	85006	3082284	83400
43-8-002	83209 or 89414	G1011822	85702	1091371	85300 or 89419	3092842	85061 or 89450
43-8-011	83207 or 89407	G1101590	85713	1091372	85301	3130140	85315
43-8-013	85000 or 89436	TWIN COACH		1091373	85302 or 89420	3171696	85307
43-8-014	85013 or 89414	90044089	83124 or 89407	1091374	85303 or 89422	3172948	85303 or 89422
43-8-015	85006	90044089C	83124 or 89407	1091375	85304	35901-0001	83209 or 89414
43-8-022	83225	90044162	83128	1091376	85305	35901-0003	85301
43-8-031	85029	AR-718-C-HD	85000 or 89436	1091377	85307	35901-0004	83219
90044089	83124 or 89407	AR-958	83207 or 89407	1091378	85308 or 89422	35901-0005	83219
90044625	83125	UNITED MANUFACTURING		1091379	85310 or 89423	35901-0008	85060
90044642	83127	K-96-41	85304	1091384	85310 or 89423	35901-0011	83123 or 89405
90044977	83115	UNIVERSAL COACH		1091388	85735	35901-0017	83314
90044978	85059	12-05-1199	85729	1093100	85027 or 89418	35901-0022	83635
90044979	83113	680777	85729	1093174	83353	35901-3201	85024 or 89416
90044992	85000 or 89436	VAN HOOL		1093176	85024 or 89416	35901-3406	85305
90045054	85051	6243-13790	85708	1093177	85025	35901-3409	85304
A-2212	85029	6243-14040	85708	1093178	85026 or 89417	35901-3410	85307
TRANSPORTATION MFG.		665562	85708	1093180	85030 or 89440	35901-3413	85006
CORP		665563	85708	1093178	85026 or 89417	35901-3420	85303 or 89422
12-05-6000	85711	VOLVO		1093178	85026 or 89417	37001-5	83401
12-05-6002	85339	02-7005976	83400	1093180	85030 or 89440	37301-0001	85013 or 89414
12-05-6033	85339	02-7005977	83400	1202-0012	83023	37301-0008	83400
12B-5-1	85700	03-1106460	85005 or 89430	1202-0022	83046	37301-0016	85026 or 89417
12G-5-1	85700	1-0200-32-888-1	83104	1202-0032	83016	37301-0018	85005 or 89430
12J-5-10	85733	1091347	83125	1505190	85722	37301-0020
12J-5-11	85313	1091348	83122 or 89406	1590439	83104	37301-0021	85026 or 89417
12J-5-12	85312	1091349	83204	1591501	85722	37301-3201	85027 or 89418
12J-5-3	85313	1091350	83207 or 89407	1591735	83104	37301-3202	85026 or 89417
12J-5-4	85312	1091351	83209 or 89414	1593843	83215	3915917	85319 or 89428
12J-5-6	85313	1091355	83215	1716824	85304	3915947	85001 or 89410
12J-5-9	85700	1091357	83219	20433424	85061 or 89450	3915948	85311 or 89424
12L-5-69	85700	1091358	83456 or 89447	20433425	85066 or 89448	3916352	85013 or 89414
12L-5-70	85700	1091359	83123 or 89405	20433426	85081	3919055	85007 or 89412
12L-5-99	85339	1091360	83303	20433427	85065	3919056	83203 or 89436
12TA-01-13	85303 or 89422	1091361	83304	20485633	85933 or 89454	3919057	83225
22012079	85701	1091362	83309 or 89446	20496217	83029	3919526	83314
22024673	85710	1091363	83221	20513881	85061 or 89450	3919561	85314 or 89425
22045526	85702	1091364	83312 or 89409	20551628	85066 or 89448		
22046485	85710	1091365	83400	20704334	83048		
22052014	85702	1091366	83401	20721254	83048		
4975515	85701			20782199	85072		
680349	85702			20863239	85080		
680350	85710			20874147	83050		
680470	85713			22012065	85304		
695117	85701						
695273	85710						

★ Will be available in first quarter of 2011.

O.E.M. INTERCHANGE

INTERCAMBIOS CON PIEZAS O.E.M.

ARTICLES DU MARCHÉ DES ÉQUIPEMENTS D'ORIGINE

O.E.M. #	GABRIEL #	O.E.M. #	GABRIEL #	O.E.M. #	GABRIEL #	O.E.M. #	GABRIEL #
VOLVO ...Cont'd		VOLVO ...Cont'd		VOLVO-AUTOCAR		WABASH NATIONAL ...Cont'd	
3919585	83209 or 89414	66010-0007	83004	03-1106460	85005 or 89430	NEW900-45-298	83128
3919588	83216	66010-0008	83004	1011839	83216	NEW900-45-299	85000 or 89436
3919958	85046 or 89434	66010-0016	85025	28CFG-910	83216	WATSON & CHALIN MFG. INC.	
3919964	85304	665410	85027 or 89418	28R010	83216	10147	83203 or 89436
3945806	89417	665539	85026 or 89417	35901-3201	85024 or 89416	10147HD	85000 or 89436
3945807	89416	665607	85047 or 89435	37301-3201	85027 or 89418	10148	83204
3945808	89407	665623	85046 or 89434	37301-3202	85026 or 89417	10634	G60015
3945809	89410	665739	85047 or 89435	660186	83216	11418	646155
3945810	89420	6668302	83216	8026658	85046 or 89434	11418	646155
3945811	89409	676081	83401	8071524	85024 or 89416	11604	83125
3945812	89423	676082	83401	849246	83216	11724	83123 or 89405
3945813	89428	6771501	85040	WABASH NATIONAL		12128	85005 or 89430
3945814	89424	6772218	85040	202447	85919	17069	632147
3945815	89406	6775411	85040	203447	85919	17079	85300 or 89419
3945816	89430	6790756	83215	DANSR1VJ100	85078	17186	85323 or 89436
3945817	89422	6794358	85040	FLL83203-07I	83203 or 89436	17186-01	85323 or 89436
3945818	89415	6857668	83105	FLL83207-07I	83207 or 89407	17218	85029
3945819	89411	6876828	83105	FLL85000-07I	85000 or 89436	17297	85938
3945820	89413	6876831	FLL85030-07I	85030 or 89440	17300	85052
3945821	89419	70042	85302 or 89420	FLL85030-07I	85030 or 89440	17306	85938
3946210	83103	8026658	85046 or 89434	FRUUCE1295-1	85300 or 89419	17382	85014
3946219	83400	8056892	85023 or 89415	FRUUCE1295-901	85300 or 89419	17430	85321
3949241	85061 or 89450	8060026	85065	FRUUCE2983-1	85322	17474	85009
3953643	85040	8061167	FRUUCF8339-1	85321	19036	85934
47902-24	83137	8065787	85026 or 89417	HENS-20001	85000 or 89436	3946219	83400
494-660	83219	8071524	85024 or 89416	HENS-20002	85000 or 89436	665724	85000 or 89436
4940640	83216	8073212	85065	HENS-20126	85323 or 89436	665727	85005 or 89430
4975479	83400	8075257	85065	HENS-21292	85052	665728	85060
4975480	83400	8075287	85065	HENS-23566	85000 or 89436	665769	85052
4975549	83216	8077874-P01	85047 or 89435	HENS-24088	85000 or 89436	665770	85938
530596	85308 or 89422	8078195	85061 or 89450	NEW900-44-089	83124 or 89407	665862	85000 or 89436
5322338	83214	8078546	83028	NEW900-44-162	83128	680547	85323 or 89436
5513989	83216	8078547	83029	NEW900-44-625	83125	680584	85938
5531435	85307	8086053	85047 or 89435	NEW900-44-626	83126 or 89430	680714	85934
5531436	85307	8086651	85066 or 89448	NEW900-44-642	83127	727603	83203 or 89436
5531437	85307	8162662	83004	NEW900-44-794	83127	727604	83204
5534430	85303 or 89422	8168617	83030	NEW900-44-868	85045	WESTERN STAR	
5534447	85303 or 89422	8169859	85047 or 89435	NEW900-44-978	85059	02-7005976	83400
5549899	83207 or 89407	8174749	85906	NEW900-44-979	83113	02-7005977	83400
5549925	85304	SDA471700131258	85081	NEW900-45-040	83130	04-9041375	85315
5554959	83401			NEW900-45-054	85051	10-13809-000	85958
57241-3	83112					1011839	83216
60657-007	85072					1202-0012	83023
629398	85307					1202-0022	83046
629501	85307					1202-0032	83016
635869	83004						
646220	85734						
64838-001	85933 or 89454						
64838-002	85933 or 89454						

★ Will be available in first quarter of 2011.

O.E.M. INTERCHANGE

INTERCAMBIOS CON PIEZAS O.E.M.

ARTICLES DU MARCHÉ DES ÉQUIPEMENTS D'ORIGINE

O.E.M. #	GABRIEL #	O.E.M. #	GABRIEL #	O.E.M. #	GABRIEL #	O.E.M. #	GABRIEL #
WESTERN STAR ...Cont'd		WESTERN STAR ...Cont'd		WESTERN STAR ...Cont'd		WESTERN UNIT "STABIL- AIRE" SUSPENSION	
16-15770-000	85956	37301-3409	85053 or 89442	617547	83022	101030	85307
28R010	83216			654846	83027	101364	85305
35066-4413	83122 or 89406	37301-3412	85053 or 89442	654916	83026	4939967	85308 or 89422
35901-0001	83209 or 89414	37390-4401	85053 or 89442	66010-3404	83022	80370	85304
35901-3406	85305	37390-4402	85053 or 89442	66010-3405	83026	80600	85300 or 89419
35901-3409	85304	37390-4403	85053 or 89442	665682	85053 or 89442	WORKHORSE	
35901-3410	85307			676081	83401	659222	83144
35901-3413	85006	47902-13	83122 or 89406	676082	83401	659223	G61866
35901-3420	85303 or 89422	47902-24	83137	725470	83010	680672	85919
35901-4403	85060	47902-8	83122 or 89406	90044025	83209 or 89414	7805-X-1012	85919
37301-3401	85053 or 89442	57241-1	83111	90044907	83635	W0007363	83144
37301-3404	85053 or 89442	58913-003	85932 or 89453	90045099	85906	W0007365	G61866
37301-3405	85053 or 89442	615016	83401	CP-5222	85315		
				SDA471700003920	85958		
				SDA481700125969	85956		

★ Will be available in first quarter of 2011.

FLEETLINE



GasSLX

Interchange Intercambio Échange



GasSLX ~~X~~ **FLEETLINE**

IMPORTANT NOTE: Interchange must only be used for FLEETLINE to GASSLX upgrade. Interchange is **NOT REVERSABLE**.

NOTA IMPORTANTE: El intercambio se debe utilizar solamente de FLEETLINE a GASSLX mejorado. El intercambio **NO ES REVERSIBLE**.

REMARQUE IMPORTANTE: L'échange ne peut se faire que pour le surclassement du FLEETLINE au GASSLX. L'échange **N'EST PAS RÉVERSIBLE**.

Gabriel®

*Available first quarter, 2011

Fleetline	Gabriel GasSLX Upgrade
83122	89406
83123	89405
83124	89407
83126	89430
83203	89436
83207	89407
83209	89414
83309	89446
83312	89409
83456	89447
85000	89436
85001	89410
85003	89411
85005	89430
85007	89412
85012	89413
85013	89414
85023	89415
85024	89416
85026	89417
85027	89418
85030	89440
85033	89427
85036	89405
85046	89434
85047	89435
85053	89442
85054	89438
85055	89439
85058	89431
85061	89450
85062	89408
85066	89448
85067	89451
85069	89455
85070*	89459*
85084*	89460*
85300	89419
85302	89420
85303	89422
85308	89422
85310	89423
85311	89424
85314	89425
85316	89426
85319	89428
85320	89429
85323	89436
85705	89447
85724	89443
85918	89449
85923	89458
85924	89457
85931	89458
85932	89453
85933	89454
85936	89456

Manufacturer No. to Catalog No. Interchange
Correspondencia del No. de fabricante con el No. de catálogo
Correspondance n. du fabricant/n. de catalogue

Mfg. #	Catalog #	Mfg. #	Catalog #	Mfg. #	Catalog #	Mfg. #	Catalog #	Mfg. #	Catalog #	Mfg. #	Catalog #
630811	630811	728604	85300	737510	G60015	737590	G60098	737925	G60008	737973	G60086
632147	632147	728605	85301	737511	G60017	737591	G60097	737926	G60015	737973	G60086
632155	632155	728606	85302	737512	G60023	737592	G60099	737926	G60015	737974	G60104
646155	646155	728607	85303	737514	G60026	737593	G60100	737927	G60078	737974	G60104
680088	85713	728608	85304	737515	G60028	737594	G60101	737927	G60078	737975	G60171
680102	85712	728609	85305	737516	G60029	737596	G60103	737928	G60076	737976	G60080
680307	85705	728611	85307	737517	G60030	737597	G60104	737928	G60076	737976	G60260
680308	85706	728612	85308	737518	G60031	737598	G60106	737929	G60077	737976	G60080
680320	85703	728614	85310	737519	G60033	737599	G60107	737929	G60077	737978	G60180
680322	85704	728615	85311	737521	G60035	737654	G60043	737930	G60079	737979	G60181
680323	85700	728616	85004	737522	G60038	737691	G60309	737931	G60014	737980	G60184
680332	85701	728617	85005	737523	G60039	737692	G60303	737931	G60014	737984	G60075
680333	85708	728618	85006	737525	G60043	737693	G60307	737932	G60042	737984	G60075
680334	85709	728619	85007	737526	G60044	737694	G60304	737932	G60042	737985	G60196
680349	85702	728620	85008	737527	G60045	737695	G60310	737933	G60038	737986	G60110
680350	85710	728621	85009	737528	G60046	737696	G60313	737934	G60039	737987	G60084
680352	85711	728622	85010	737529	G60047	737900	G60012	737935	G60021	737987	G61152
695172	85707	728623	85011	737530	G60048	737900	G60012	737936	G60024	737987	G60084
727513	G60024	728624	85012	737531	G60049	737901	G60031	737937	G60010	737988	G60204
727600	83200	728625	85013	737532	G60050	737901	G60031	737937	G60010	737989	G60205
727601	83201	728626	85312	737533	G60051	737902	G60048	737938	G60028	737990	G60206
727602	83218	728627	85313	737534	G60052	737902	G60048	737938	G60028	737991	G60194
727603	83203	728628	85314	737535	G60053	737903	G60046	737939	G60029	737992	G60197
727604	83204	728629	85315	737536	G60062	737903	G60046	737939	G60029	737993	G60081
727607	83207	728630	85014	737538	G60021	737904	G60051	737940	G60052	737994	G60091
727609	83205	728631	85029	737540	G60064	737904	G60051	737940	G61204	737994	G60091
727609	83209	728632	85030	737541	G60065	737905	G60049	737941	G60053	737995	G60096
727613	83213	728633	85316	737542	G60066	737905	G60049	737941	G60053	737995	G60096
727614	83214	728634	85317	737543	G60067	737906	G60063	737943	G60097	737996	G60106
727615	83215	728635	85318	737544	G60068	737906	G60063	737943	G60097	737999	G60111
727616	83216	728636	85023	737545	G60069	737907	G60007	737944	G60098	745518	G60137
727617	83217	728637	85024	737546	G60070	737907	G61150	737944	G60098	745519	G60136
727619	83219	728638	85025	737547	G60071	737907	G60007	737946	G60100	747500	G60109
727621	83221	728639	85026	737548	G60072	737908	G60062	737946	G60100	747501	G60110
727621	83310	728640	85027	737549	G60073	737908	G60233	737948	G60030	747502	G60111
727625	83225	728800	85711	737550	G60063	737908	G60062	737949	G60103	747503	G60113
727627	83300	728803	85700	737551	G60076	737909	G60087	737949	G60103	747504	G60114
727628	83301	728804	85735	737555	G60112	737909	G60087	737952	G60041	747506	G60120
727629	83206	728806	85736	737556	G60088	737910	G60033	737952	G60041	747507	G60121
727629	83202	728811	85707	737557	G60096	737910	G60033	737953	G60074	747508	G60122
727630	83303	728812	85705	737558	G60074	737914	G60044	737954	G60043	747510	G60124
727631	83304	728813	85706	737560	G60069	737915	G60017	737956	G60083	747514	G60128
727635	83308	735678	G60301	737561	G60091	737915	G60017	737957	G60026	747515	G60129
727636	83309	736800	83400	737562	G60105	737917	G60035	737957	G60026	747529	G60143
727639	83312	736801	83401	737568	G60075	737917	G60035	737962	G60143	747530	G60144
727641	83314	737500	G60002	737571	G60078	737918	G60050	737962	G61115	747538	G60153
727644	83317	737501	G60003	737572	G60079	737918	G60050	737963	G60144	747539	G60154
727645	83318	737502	G60006	737573	G60041	737919	G60101	737963	G61113	747543	G60158
727672	83242	737502	G60042	737574	G60077	737919	G60101	737965	G60099	747544	G60160
727692	83353	737503	G60007	737575	G60080	737920	G60105	737965	G60099	747545	G60152
727741	83362	737504	G60008	737576	G60081	737922	G60011	737966	G60129	747546	G60119
727761	83613	737506	G60010	737578	G60084	737923	G60023	737967	G60153	747547	G60161
728600	85000	737507	G60011	737580	G60086	737924	G60003	737968	G60154	747548	G60162
728601	85001	737508	G60012	737581	G60083	737924	G60003	737971	G60161	747549	G60163
728603	85003	737509	G60014	737586	G60087	737925	G60008	737972	G60162	747550	G60164

Manufacturer No. to Catalog No. Interchange
Intercambio del número de fabricantes al número de catálogo
Échange du numéro du fabricant au numéro du catalogue

Mfg. #	Catalog #	Mfg. #	Catalog #	Mfg. #	Catalog #	Mfg. #	Catalog #	Mfg. #	Catalog #	Mfg. #	Catalog #
747551	G60165	747911	G60164	747942	G60232	748613	G60330	750710	G61873	83015	83015
747552	G60169	747912	G60002	747943	G60233	748613	G60330	750712	G61875	83016	83016
747553	G60171	747912	G60002	747944	G60235	748614	G60306	750714	G61877	83017	83017
747558	G60179	747913	G60045	747944	G60235	748614	G60306	750715	G61878	83018	83018
747559	G60176	747913	G60045	747954	G60249	748615	G60305	750716	G61879	83019	83019
747560	G60177	747914	G60218	747955	G60250	748615	G60305	750717	G61880	83020	83020
747561	G60180	747914	G60047	747955	G60250	748652	G60338	750718	G61881	83021	83021
747562	G60181	747915	G60064	747956	G60251	748652	G60338	750719	G61882	83022	83022
747563	G60182	747915	G60064	747956	G60251	748792	G60354	750720	G61883	83023	83023
747564	G60183	747916	G60065	747958	G60253	750611	G61139	750721	G61884	83024	83024
747565	G60184	747916	G60065	747958	G60253	750611	G61139	750722	G61885	83025	83025
747566	G60185	747917	G60066	747960	G60255	750612	G61140	750725	G61886	83026	83026
747567	G60186	747917	G60066	747960	G60255	750612	G61140	750726	G61887	83027	83027
747575	G60194	747918	G60067	747962	G60257	750614	G61112	750727	G61888	83028	83028
747578	G60196	747918	G60067	747962	G60257	750614	G61112	750728	G61889	83029	83029
747579	G60197	747919	G60068	747963	G60258	750615	G61150	750729	G61890	83030	83030
747580	G60199	747919	G60068	747963	G60258	750619	G61151	750730	G61891	83031	83031
747585	G60204	747920	G60069	747964	G60259	750622	G61144	750731	G61892	83032	83032
747586	G60205	747921	G60070	747964	G60259	750622	G61144	750732	G61893	83033	83033
747587	G60206	747921	G60070	747965	G60260	750626	G60182	750733	G61894	83034	83034
747595	G60214	747922	G60071	747968	G60263	750626	G61148	750734	G61895	83035	83035
747597	G60216	747923	G60072	747968	G60263	750627	G61149	750735	G61896	83038	83038
747598	G60217	747923	G60072	747969	G60264	750627	G61149	750736	G61897	83039	83039
747599	G60218	747924	G60073	747969	G60264	750628	G61152	750737	G61898	83040	83040
747600	G60219	747924	G60073	747970	G60265	750629	G61153	750739	G61918	83041	83041
747603	G60222	747925	G60165	747970	G60265	750629	G61153	750740	G61919	83042	83042
747613	G60237	747925	G60165	747974	G60269	750630	G61154	750741	G61959	83044	83044
747682	G61113	747926	G60176	747974	G60269	750630	G61154	750743	G61961	83045	83045
747684	G61115	747926	G60176	748050	G60302	750631	G60164	750744	G61962	83046	83046
747685	G61116	747927	G60177	748057	G60303	750631	G61155	750745	G61963	83047	83047
747687	G61118	747927	G60177	748058	G60304	750632	G61156	750746	G61964	83048	83048
747687	G61118	747928	G60179	748059	G60305	750632	G61156	750747	G61965	83049	83049
747690	G61121	747928	G60179	748062	G60306	750634	G61158	750748	G61966	83100	83100
747690	G61121	747929	G60182	748066	G60307	750634	G61158	750749	G61967	83101	83101
747691	G61122	747930	G60183	748076	G60308	750635	G60163	750751	G61969	83102	83102
747691	G61122	747930	G60183	748077	G60309	750635	G61159	750752	G61970	83103	83103
747692	G61124	747931	G60185	748081	G60310	750635	G61159	750753	G61971	83104	83104
747900	G60112	747931	G60185	748085	G60313	750658	G61170	753528	G60105	83105	83105
747900	G60112	747932	G60199	748120	G60312	750663	G61169	753530	G60074	83106	83106
747901	G60113	747932	G60199	748154	G60329	750664	G61173	753587	G60052	83107	83107
747901	G60113	747933	G60214	748155	G60330	750672	G61175	797983	G60107	83109	83109
747902	G60119	747933	G60214	748169	G60331	750673	G61177	83001	83001	83110	83110
747902	G60119	747934	G60216	748176	G60334	750674	G61178	83002	83002	83111	83111
747903	G60121	747935	G60217	748329	G60353	750675	G61180	83003	83003	83112	83112
747904	G60122	747936	G60218	748329	G60353	750681	G61182	83004	83004	83113	83113
747905	G60128	747937	G60219	748338	G60354	750696	G61860	83005	83005	83114	83114
747905	G60128	747937	G60219	748432	G61872	750698	G61862	83006	83006	83115	83115
747906	G60136	747938	G60221	748607	G60308	750700	G61864	83007	83007	83116	83116
747907	G60137	747938	G60221	748607	G60308	750701	G61865	83008	83008	83117	83117
747908	G60152	747939	G60222	748608	G60301	750702	G61866	83009	83009	83118	83118
747908	G60152	747939	G60222	748608	G60301	750703	G61958	83010	83010	83119	83119
747909	G60158	747940	G60186	748609	G60312	750704	G63867	83011	83011	83120	83120
747909	G60158	747940	G60226	748609	G60312	750705	G61868	83012	83012	83121	83121
747910	G60160	747940	G60226	748612	G60329	750706	G61869	83013	83013	83122	83122
747910	G60160	747942	G60232	748612	G60329	750707	G63870	83014	83014	83123	83123

Manufacturer No. to Catalog No. Interchange
Correspondencia del No. de fabricante con el No. de catálogo
Correspondance n. du fabricant/n. de catalogue

Mfg. #	Catalog #	Mfg. #	Catalog #	Mfg. #	Catalog #	Mfg. #	Catalog #	Mfg. #	Catalog #	Mfg. #	Catalog #
83124	83124	85009	85009	85071	85071	85700	85700	85908	85908	89410	89410
83125	83125	85010	85010	85072	85072	85701	85701	85909	85909	89411	89411
83126	83126	85011	85011	85079	85079	85702	85702	85910	85910	89412	89412
83127	83127	85012	85012	85300	85300	85703	85703	85911	85911	89413	89413
83128	83128	85013	85013	85301	85301	85704	85704	85912	85912	89414	89414
83130	83130	85014	85014	85302	85302	85705	85705	85913	85913	89415	89415
83131	83131	85023	85023	85303	85303	85706	85706	85914	85914	89416	89416
83132	83132	85024	85024	85304	85304	85707	85707	85915	85915	89417	89417
83134	83134	85025	85025	85305	85305	85708	85708	85916	85916	89418	89418
83135	83135	85026	85026	85307	85307	85709	85709	85918	85918	89419	89419
83136	83136	85027	85027	85308	85308	85710	85710	85919	85919	89420	89420
83137	83137	85029	85029	85310	85310	85711	85711	85920	85920	89422	89422
83138	83138	85030	85030	85311	85311	85712	85712	85921	85921	89423	89423
83140	83140	85031	85031	85312	85312	85713	85713	85922	85922	89424	89424
83141	83141	85033	85033	85313	85313	85714	85714	85923	85923	89425	89425
83142	83142	85036	85036	85314	85314	85715	85715	85924	85924	89426	89426
83143	83143	85040	85040	85315	85315	85716	85716	85925	85925	89427	89427
83144	83144	85042	85042	85316	85316	85717	85717	85926	85926	89428	89428
83145	83145	85043	85043	85317	85317	85718	85718	85927	85927	89429	89429
83146	83146	85044	85044	85318	85318	85719	85719	85928	85928	89430	89430
83147	83147	85045	85045	85319	85319	85720	85720	85929	85929	89431	89431
83148	83148	85046	85046	85320	85320	85722	85722	85930	85930	89432	89432
83149	83149	85047	85047	85321	85321	85723	85723	85931	85931	89434	89434
83153	83153	85048	85048	85322	85322	85724	85724	85932	85932	89435	89435
83154	83154	85049	85049	85323	85323	85727	85727	85933	85933	89436	89436
83242	83242	85050	85050	85324	85324	85728	85728	85934	85934	89437	89437
83634	83634	85051	85051	85325	85325	85729	85729	85935	85935	89438	89438
83635	83635	85052	85052	85326	85326	85730	85730	85936	85936	89439	89439
83636	83636	85053	85053	85327	85327	85731	85731	85937	85937	89440	89440
849000	G62000	85054	85054	85328	85328	85732	85732	85938	85938	89441	89441
849001	G62001	85055	85055	85329	85329	85733	85733	85939	85939	89442	89442
849002	G62002	85056	85056	85330	85330	85734	85734	85953	85953	89443	89443
849003	G62003	85057	85057	85331	85331	85735	85735	85954	85954	89446	89446
849004	G62004	85058	85058	85332	85332	85736	85736	85955	85955	89447	89447
849005	G62005	85059	85059	85333	85333	85737	85737	87001	87001	89448	89448
849006	G62006	85060	85060	85334	85334	85738	85738	87002	87002	89449	89449
849007	G62007	85061	85061	85335	85335	85900	85900	89401	89401	89450	89450
849008	G62008	85062	85062	85336	85336	85901	85901	89402	89402	89451	89451
85000	85000	85063	85063	85337	85337	85902	85902	89403	89403	89453	89453
85001	85001	85064	85064	85338	85338	85903	85903	89405	89405	89454	89454
85003	85003	85065	85065	85339	85339	85904	85904	89406	89406	89455	89455
85004	85004	85066	85066	85376	85376	85905	85905	89407	89407	89456	89456
85005	85005	85067	85067	85377	85377	85906	85906	89408	89408	89457	89457
85006	85006	85069	85069	85378	85378	85907	85907	89409	89409	89458	89458
85007	85007	85070	85070								

HOW TO DETERMINE THE CORRECT SHOCK FOR YOUR TRUCK

COMO ESCOGER EL MEJOR AMORTIGUADOR PARA SU CAMIÓN

COMMENT CHOISIR LE BON AMORTISSEUR POUR VOTRE CAMION.

STEP 1: Measure the diameter of the dust tube and cylinder to determine the series.

1ER PASO Mida el diámetro del tubo de polvo y del cilindro para determinar la serie.

1RE ÉTAPE Mesurez le diamètre du tube de poussière et du cylindre pour déterminer la série.

EXTERNAL DIMENSIONS DIMENSIONES EXTERNAS DIMENSIONS EXTÉRIEURES

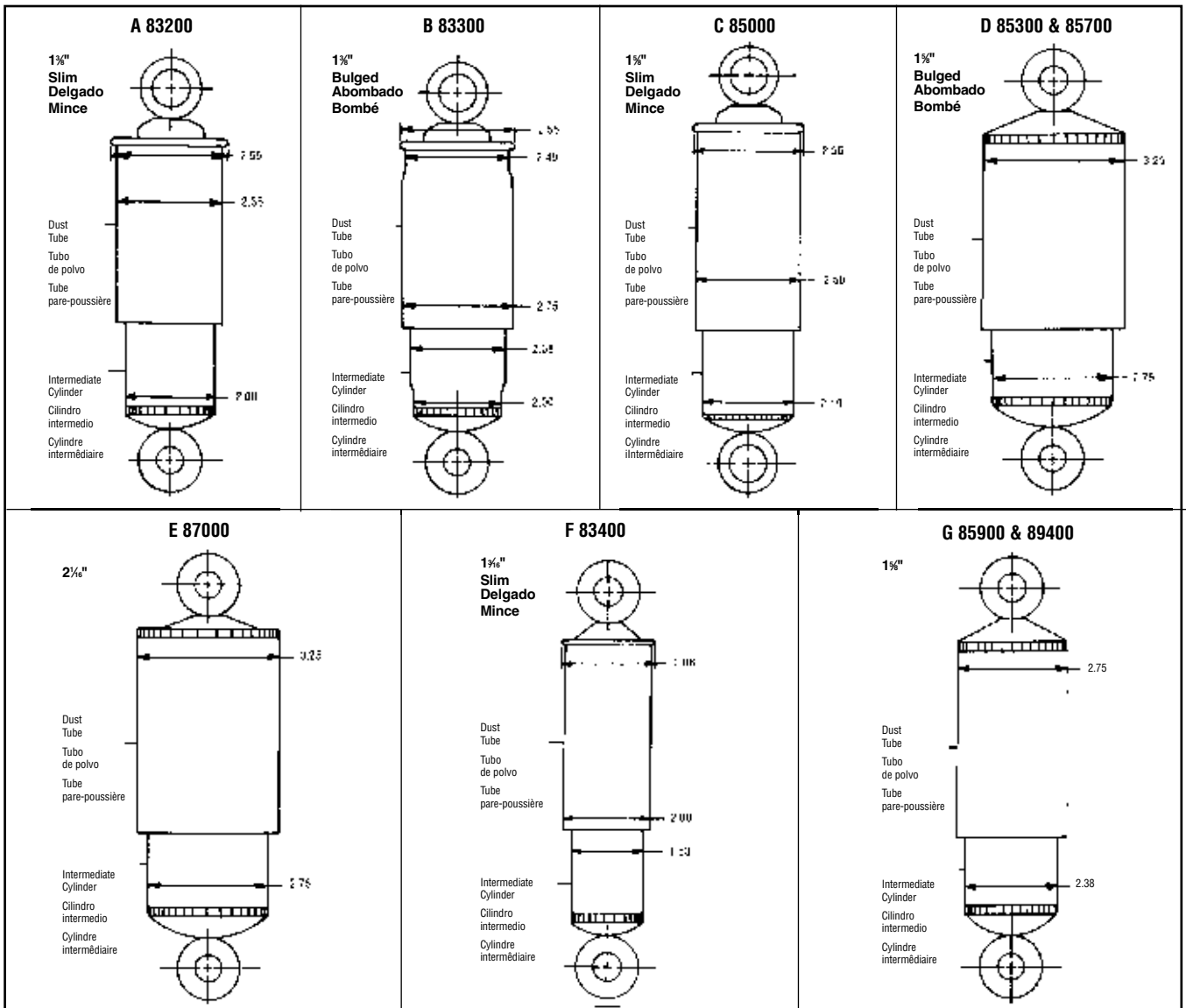

STEP 2: Identify the mounting style. Measure fully extended and fully collapsed lengths at the locations indicated for mounting style.

2° PASO Identifique el método de fijación. Mida la extensión máxima y la compresión máxima en los lugares indicados para la fijación.

2^E ÉTAPE Identifiez la méthode de fixation. Mesurez la longueur en pleine extension et en pleine compression, aux endroits indiqués pour la méthode de fixation.

HOW TO MEASURE EXTENDED & COLLAPSED LENGTHS OF SHOCK ABSORBERS COMO MEDIR LAS LONGITUDES EXTENDIDA Y COMPRIMIDA DE LOS AMORTIGUADORES COMMENT MESURER LES LONGUEURS ALLONGÉ ET COMPRIMÉ DES AMORTISSEURS

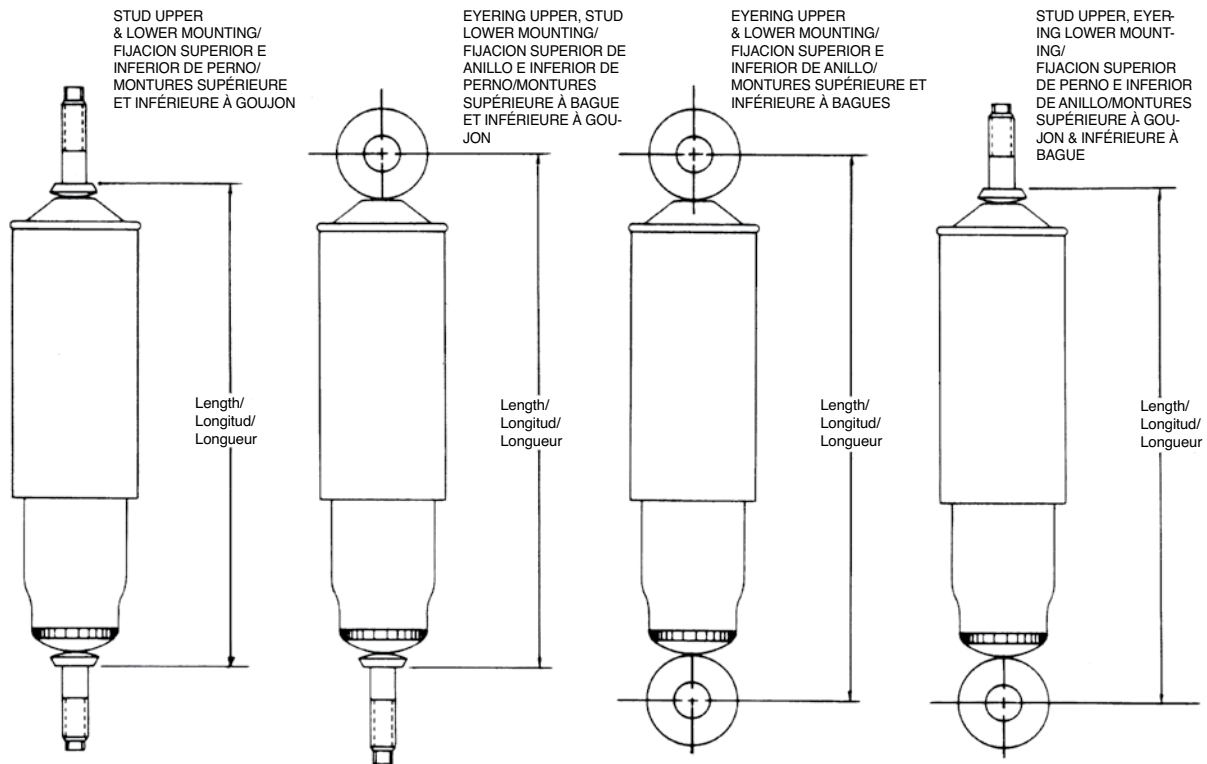

INSTRUCTIONS:

- Using the proper measuring points as shown above find the nearest replacement shock absorber from the listing by increments of extended length.
- Identify the proper mounting from the mounting codes and match these requirements by carefully measuring the mounting dimensions (top and bottom) of the shock absorber to be replaced.
- Carefully take note of the following requirements:
 - Dust tubes** - This requirement should be noted in comparison with the shock absorber to be replaced. Shock absorber environment in its application makes this requirement necessary for piston rod protection and extended shock absorber life.
 - Recoil Cutoff and Compression Bumper** - Carefully note these specifications - deviation of length requirements should not exceed $\pm \frac{1}{8}$ ". These shock absorber designs are footnoted for easy identification.

Note: Shock Absorbers used for installations other than those recommended in our catalog are **not subject to warranty**.

INSTRUCCIONES :

- Usando los puntos de medida adecuados como mencionado, encuentre el amortiguador más cercano en la lista por incrementos de la longitud extendida.
- Identifique la fijación adecuada por medio de los códigos de fijación y compare estas especificaciones, midiendo cuidadosamente las dimensiones de la fijación (superior e inferior) del amortiguador por reemplazar.
- Note cuidadosamente las exigencias siguientes :
 - Guarda polvo** : esta exigencia debe notarse en comparación con el amortiguador por reemplazar. Esta exigencia es necesaria en cuanto a los amortiguadores para proteger al vástago del pistón y extender la duración del amortiguador.
 - Topo de retorno y topo de compresión**. Note cuidadosamente las especificaciones siguientes : las exigencias de longitud no deben de ser excedidas $\pm \frac{1}{8}$ ". Estos diseños de amortiguadores están marcados para facilitar su identificación.

Nota : Los amortiguadores usados para instalaciones otras que las recomendadas en nuestro catálogo **no son garantizados**.

INSTRUCTIONS:

- En utilisant les points de mesure appropriés comme indiqués ci-dessus, trouvez l'amortisseur de rechange le plus près de cette mesure d'après la longueur allongée.
- Repérez les montures appropriées sur les codes des montures et faites correspondre ces exigences en mesurant attentivement les dimensions des montures (haut et bas) de l'amortisseur à replacer.
- Avec soin, prenez note des exigences suivantes:
 - Tubes pare-poussière** - Cette exigence devrait être notée en comparaison de l'amortisseur à remplacer. Le milieu de service rend cette exigence nécessaire pour la protection de la tige de piston et une meilleure longévité de l'amortisseur.
 - Arrêt de retour et butée de compression** - Notez avec soin ces spécifications. La déviation par rapport aux exigences de longueurs ne doit pas dépasser $\pm \frac{1}{8}$ po. Ces modèles d'amortisseurs portent une note pour une identification facile.

Note: Les amortisseurs utilisés pour des installations autres que celles recommandées dans notre catalogue **ne sont pas couverts par la garantie**.

STEP 3: Measure end mount diameters, widths, and lengths. Refer to the following Endmount tables to determine the appropriate or matching mounting code

3ER PASO Mida las dimensiones del tubo, así como el diámetro, la anchura y la longitud de las fijaciones. Consulte las tablas siguientes de conteras para determinar el código de montaje apropiado o concorde

3E ÉTAPE Mesurez le diamètre, la largeur et la longueur des bagues. Consultez les tableaux d'embouts suivants afin d'établir le code de montage approprié ou concordant

MOUNTING CODE "EB" EYERING AND BUSHING CODIGO DE FIJACION «EB» - ANILLO Y BUJE CODE DE MONTURE «EB» À BAGUE ET MANCHON

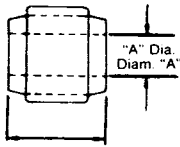
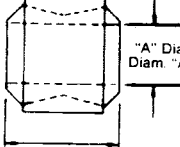
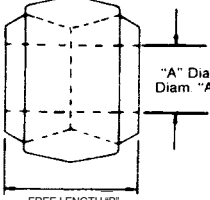
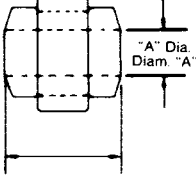
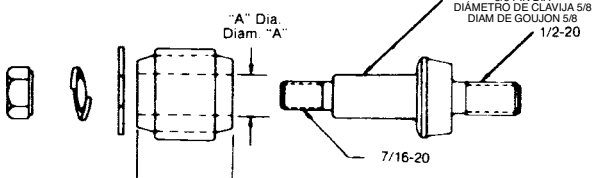
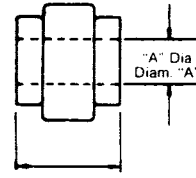
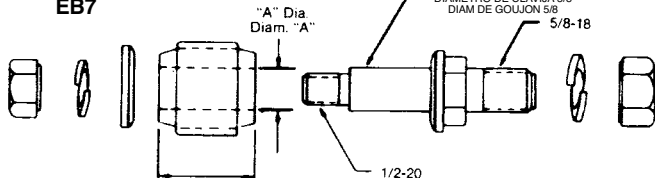
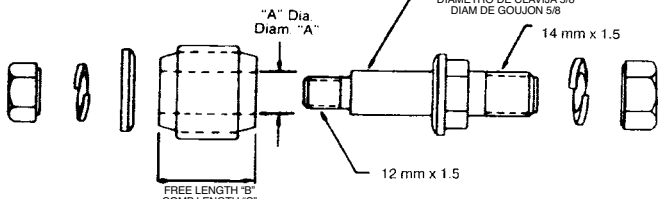
<p>EB1</p>  <p>FREE LENGTH "B" COMP LENGTH "C" LONGITUD LIBRE "B" LONGITUD COMPRIMIDA "C" LONGUEUR NON COMP "B" LONGUEUR COMP "C"</p>	<p>EB2</p>  <p>FREE LENGTH "B" COMP LENGTH "C" LONGITUD LIBRE "B" LONGITUD COMPRIMIDA "C" LONGUEUR NON COMP "B" LONGUEUR COMP "C"</p>	<p>EB3</p>  <p>FREE LENGTH "B" COMP LENGTH "C" LONGITUD LIBRE "B" LONGITUD COMPRIMIDA "C" LONGUEUR NON COMP "B" LONGUEUR COMP "C"</p>	
<p>EB4</p>  <p>FREE LENGTH "B" COMP LENGTH "C" LONGITUD LIBRE "B" LONGITUD COMPRIMIDA "C" LONGUEUR NON COMP "B" LONGUEUR COMP "C"</p>	<p>EB6</p>  <p>FREE LENGTH "B" COMP LENGTH "C" LONGITUD LIBRE "B" LONGITUD COMPRIMIDA "C" LONGUEUR NON COMP "B" LONGUEUR COMP "C"</p> <p>5/8 PIN DIA DIÁMETRO DE CLAVIJA 5/8 DIAM DE GOUJON 5/8 1/2-20 7/16-20</p>		
<p>EB5</p>  <p>FREE LENGTH "B" COMP LENGTH "C" LONGITUD LIBRE "B" LONGITUD COMPRIMIDA "C" LONGUEUR NON COMP "B" LONGUEUR COMP "C"</p>	<p>EB7</p>  <p>FREE LENGTH "B" COMP LENGTH "C" LONGITUD LIBRE "B" LONGITUD COMPRIMIDA "C" LONGUEUR NON COMP "B" LONGUEUR COMP "C"</p> <p>5/8 PIN DIA DIÁMETRO DE CLAVIJA 5/8 DIAM DE GOUJON 5/8 1/2-20 5/8-18</p>		
<p>EB8</p>  <p>FREE LENGTH "B" COMP LENGTH "C" LONGITUD LIBRE "B" LONGITUD COMPRIMIDA "C" LONGUEUR NON COMP "B" LONGUEUR COMP "C"</p> <p>5/8 PIN DIA DIÁMETRO DE CLAVIJA 5/8 DIAM DE GOUJON 5/8 14 mm x 1.5 12 mm x 1.5</p>			

Mounting Code Código de fijación Code de monture	"A" Dia. Diámetro "A" Diam. "A"	B Free Length Longitud libre Long. non comp.	C Comp. Length Longitud comprimida Long. comp.	Vehicle Mounting Pin Dia. Diámetro de clavija de fijación del vehículo Diam. du goujon de montage du véhicule
EB1	5/8	1.44	1.31/1.25	5/8
EB2	3/4	1.75	1.50	3/4
EB3	1	1.91	1.75	1
EB4	11/16	1.72	1.55	11/16
EB5	5/8	1.51	1.25	5/8
EB6	5/8	1.44	1.31/1.25	Mounting pin furnished with shock absorber for 1/2" dia. vehicle mounting hole. Clavija de fijación provista con amortiguador para agujero de montaje de 1/2" de diámetro en el vehículo. Goujon de montage fourni avec l'amortisseur pour trou de montage de 1/2 po de diam. sur véhicule.
EB7	5/8	1.44	1.31/1.25	Mounting pin furnished with shock absorber for 5/8" dia. vehicle mounting hole. Clavija de fijación provista con amortiguador para agujero de montaje de 5/8" de diámetro en el vehículo. Goujon de montage fourni avec l'amortisseur pour trou de montage de 5/8 po de diam. sur véhicule.
EB8	5/8	1.44	1.31/1.25	Mounting pin furnished with shock absorber for 14 mm dia. vehicle mounting hole. Clavija de fijación provista con amortiguador para agujero de montaje de 14 mm de diámetro en el vehículo. Goujon de montage fourni avec l'amortisseur pour trou de montage de 14 mm de diam. sur véhicule.

MOUNTING CODE "BP" EYERING AND BUSHING WITH BAR PIN
CODIGO DE FIJACION «BP» ANILLO Y BUJE CON CLAVIJA TIPO BARRA
CODE DE MONTURE "BP" BAGUE ET MANCHON AVEC GOUPILLE

Type 1/Tipo 1			Type 2 /Tipo 2			Type 3 /Tipo 3					
Code	Type	A	B	C	D	Code	Type	A	B	C	D
BP1	1	2.72	2.20	0.33	---	BP16	2	3.70	2.91	0.35	0.44
BP3	1	2.82	2.38	0.33	---	BP17	1	3.11	2.61	0.33	---
BP4	1	3.19	2.38	0.33	---	BP18	1	3.75	3.14	0.39	---
BP5	1	3.19	2.75	0.33	---	BP19	1	3.19	2.62	0.33	---
BP6	1	4.25	3.62	0.33	---	BP20	1	3.59	3.12	0.33	---
BP7	2	3.13	2.50	0.35	0.42	BP26	3	3.06	2.37	0.26	---
BP8	2	3.50	2.87	0.35	0.42	BP27	2	4.00	2.95	0.52	---
BP11	1	2.96	2.52	0.33	---	BP30	1	3.00	2.25	0.34	---
BP12	1	3.75	3.14	0.33	---	BP31	3	3.50	2.87	0.35	---
BP13	1	3.45	3.00	0.33	---	BP32	2	3.45	2.83	0.42	---
BP14	2	3.43	2.87	0.43	---	BP33	2	3.50	2.87	0.35	0.42

MOUNTING CODE "ES" & "CB" EYERING AND BUSHING WITH STEEL SLEEVE
CODIGO DE FIJACION «ES» Y «CB» ANILLO Y BUJE CON CAMISA DE ACERO
CODE DE MONTURE "ES" & "CB" BAGUE ET MANCHON AVEC COLLET EN ACIER

TYPE 1/TIPO 1
CENTERED IN
EYERING
CENTRADO EN
EL ANILLO
CENTRÉ DANS
LA BAGUE

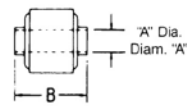

TYPE 2/TIPO 2
OFFSET IN
EYERING
DESCENTRADO
EN EL ANILLO
DÉCALÉ SUR
LA BAGUE

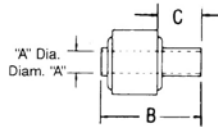

TYPE 3/TIPO 3
CAPTURED
BUSHING
BUJE
CAPTURADO
MANCHON
PRISONNIER

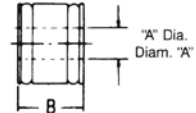

Code	Type	"A" Dia.	B	C	Code	Type	"A" Dia.	B	C	Code	Type	"A" Dia.	B	C
CB2	3	1/2	1.43	---	ES56	1	14 mm	1.58	---	ES137	1	1/2	1.73	---
CB3	3	1/2	1.58	---	ES57	1	10 mm	1.03	---	ES138	1	5/8	1.7	---
CB4	3	9/16	1.67	---	ES58	1	7/16	2.44	---	ES139	1	12 mm	1.35	---
CB5	3	12 mm	1.48	---	ES59	1	3/8	1.82	---	ES141	1	12 mm	1.61	---
CB6	3	10 mm	1.59	---	ES60	1	14 mm	1.26	---	ES142	1	16 mm	1.43	---
CB7	3	12 mm	2.15	---	ES61	1	12 mm	1.76	---	ES143	1	9/16	1.60	---
CB8	3	1/2	2.15	---	ES62	1	12 mm	.98	---	ES144	1	9/16	1.97	---
ES1	1	10 mm	1.25	---	ES64	1	14 mm	1.19	---	ES145	1	7/16	2.25	---
ES2	1	10 mm	1.42	---	ES65	1	12 mm	1.38	---	ES146	1	12 mm	1.37	---
ES3	1	10 mm	1.56	---	ES69	1	12 mm	1.58	---	ES147	1	12 mm	1.97	---
ES4	1	10 mm	1.97	---	ES73	1	5/8	1.32	---	ES148	1	3/4	1.56	---
ES5	1	10 mm	2.07	---	ES78	1	10 mm	1.92	---	ES149	1	1/2	2.36	---
ES6	1	10 mm	2.36	---	ES82	1	1/2	1.67	---	ES150	1	3/4	2.24	---
ES7	1	10 mm	2.65	---	ES83	1	12 mm	1.48	---	ES151	1	1/2	2.44	---
ES8	1	7/16	1.25	---	ES84	1	10 mm	1.62	---	ES152	1	20 mm	1.69	---
ES9	1	7/16	1.31	---	ES85	1	12 mm	2.36	---	ES153	1	14 mm	1.55	---
ES10	1	7/16	1.38	---	ES86	1	14 mm	2.44	---	ES154	1	1/2	1.62	---
ES11	1	7/16	1.50	---	ES87	1	9/16	1.66	---	ES155	1	12 mm	2.15	---
ES12	1	7/16	1.62	---	ES88	1	12 mm	1.81	---	ES157	2	1/2	2.05	0.95
ES14	1	7/16	1.88	---	ES90	1	5/8	2.00	---	ES158	1	3/4	3.80	---
ES16	1	7/16	3.15	---	ES91	1	1/2	2.00	---	ES159	2	3/4	3.21	1.03
ES17	1	12 mm	1.25	---	ES94	1	1/2	2.15	---	ES160	1	1.00	2.01	---
ES18	1	12 mm	1.65	---	ES98	1	12 mm	2.20	---	ES161	1	5/8	3.95	---
ES19	1	12 mm	1.88	---	ES104	1	20 mm	1.58	---	ES162	1	16 mm	2.60	---
ES20	1	12 mm	1.95	---	ES105	1	8 mm	1.80	---	ES163	1	7/16	2.50	---
ES21	1	12 mm	2.28	---	ES106	1	10 mm	1.48	---	ES164	1	1/2	2.26	---
ES22	1	1/2	1.25	---	ES107	1	12 mm	2.15	---	ES165	1	1/2	1.75	---
ES23	1	1/2	1.31	---	ES109	1	10 mm	0.95	---	ES166	1	5/8	2.97	---
ES24	1	1/2	1.38	---	ES110	1	16 mm	1.61	---	ES167	1	14 mm	2.31	---
ES25	1	1/2	1.50	---	ES111	1	9 mm	1.78	---	ES168	1	14 mm	2.62	---
ES26	1	1/2	1.56	---	ES112	1	12 mm	1.08	---	ES169	1	14 mm	1.91	---
ES27	1	1/2	1.62	---	ES113	1	16 mm	1.49	---	ES170	1	10 mm	1.18	---
ES31	2	1/2	2.25	1.00	ES114	1	12 mm	2.04	---	ES171	1	1/2	1.88	---
ES32	1	1/2	3.34	---	ES115	1	10 mm	2.02	---	ES172	1	1/2	2.72	---
ES34	1	9/16	1.66	---	ES116	1	10 mm	1.24	---	ES173	1	7/8	2.28	---
ES35	1	5/8	1.38	---	ES118	1	12 mm	1.31	---	ES174	1	5/8	3.25	---
ES36	1	3/4	1.75	---	ES120	1	3/4	2.76	---	ES175	1	16 mm	1.96	---
ES37	1	12 mm	1.01	---	ES121	1	3/4	2.06	---	ES176	1	16 mm	3.72	---
ES38	1	7/16	2.16	---	ES122	1	10 mm	1.26	---	ES177	1	16 mm	3.55	---
ES39	1	10 mm	1.31	---	ES126	1	1/2	2.44	---	ES178	1	3/4	1.96	---
ES40	1	7/16	3.38	---	ES127	1	7/8	1.75	---	ES179	1	20 mm	1.75	---
ES41	1	9 mm	.81	---	ES128	1	1/2	1.66	---	ES180	1	20 mm	2.24	---
ES44	1	10 mm	2.28	---	ES130	1	1/2	1.56	---	ES181	1	7/16	1.98	---
ES45	1	1/2	1.53	---	ES131	1	1/2	1.38	---	ES182	1	20 mm	1.96	---
ES46	2	12 mm	1.88	0.62	ES132	1	9 mm	1.50	---	ES183	1	20 mm	3.80	---
ES47	1	8 mm	1.25	---	ES133	1	12 mm	1.93	---	ES184	1	20 mm	2.44	---
ES52	1	12 mm	1.19	---	ES134	1	12 mm	1.95	---	ES185	1	12 mm	2.44	---
ES53	1	10 mm	1.38	---	ES135	2	12 mm	1.77	---	ES186	2	14 mm	1.89	---
ES54	1	12 mm	2.91	---	ES136	1	5/8	1.75	---	ES187	1	1.00	1.75	---
ES55	1	12 mm	1.56	---						ES188	1	16mm	1.81	---

MOUNTING CODES "S" & "DS" STUD MOUNTS CODIGOS DE FIJACION «S» Y «DS» FIJACIONES DE DOBLE PERNO CODES DE MONTURE "S" & "DS" À GOUJON

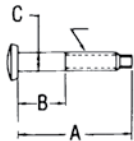
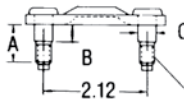
S					DS									
														
D (Thread Size) D (Tamaño de filete) D (Filet)					D (Thread Size) D (Tamaño de filete) D (Filet)									
Code	A	B	C	D	Code	A	B	C	D	Code	A	B	C	D
DS1	1.25	0.44	3/8	5/16 - 24	S13	2.06	1.35	3/8	3/8 - 24	S33	3.44	2.17	10 mm	10 mm
S1	2.37	1.00	3/8	3/8 - 24	S14	2.25	1.33	7/16	3/8 - 24	S36	1.24	0.65	3/8	3/8 - 24
S2	2.06	1.00	3/8	3/8 - 24	S16	2.95	1.45	16 mm	16 x 1.5	S38	2.75	1.70	14 mm	12 mm
S4	1.75	1.00	3/8	3/8 - 24	S17	2.15	1.03	7/16	3/8 - 24	S39	3.55	1.75	5/8	5/8 - 18
S6	2.58	1.47	7/16	3/8 - 24	S21	3.28	1.75	5/8	5/8 - 18	S40	2.52	1.33	7/16	3/8 - 24
S7	1.97	1.00	3/8	3/8 - 24	S23	1.84	1.05	3/8	3/8 - 24	S41	3.48	2.32	5/8	1/2 - 20
S10	2.37	1.33	7/16	3/8 - 24	S28	2.34	1.33	7/16	3/8 - 16	S42	3.50	2.00	5/8	5/8 - 18
S11	2.37	1.21	7/16	3/8 - 24	S29	2.99	1.87	3/8	3/8 - 24	S43	2.75	1.25	5/8	5/8 - 18
S12	2.37	1.15	7/16	3/8 - 24	S30	3.44	1.30	7/16	10 mm					

EXPLANATION OF COLUMN HEADINGS EXPLICACION DE LOS TITULOS DE LAS COLUMNA EXPLICATION DES EN-TÊTES DE COLUMNS

SHOCK ABSORBER PART NUMBER:

The catalog number for the individual shock absorber.

Número de parte del amortiguador :

El número de catálogo para el amortiguador individual

Numéro de pièce de l'amortisseur:

Le numéro de catalogue pour l'amortisseur individuel.

EXTENDED LENGTH:*

The length of the shock absorber when it is fully extended. See "How to Measure" instructions.

Longitud extendida :

La longitud del amortiguador cuando es totalmente extendido. Ver instrucciones «Cómo medir»

Longueur étirée:*

La longueur de l'amortisseur entièrement étiré. Voir "Comment mesurer".

COLLAPSED LENGTH:*

The length of the shock absorber when it is fully compressed. See "How to Measure" instructions.

Longitud comprimida :

La longitud del amortiguador cuando es totalmente comprimido. Ver instrucciones «Cómo medir»

Longueur comprimée:*

La longueur de l'amortisseur entièrement comprimé. Voir "Comment mesurer".

STROKE:

This is the approximate length of the stroke of the individual shock absorber being described.

Carrera :

Es la longitud aproximada de la carrera del amortiguador descrito

Course:

C'est la longueur approximative de la course de l'amortisseur individuel décrit.

MOUNTING CODES:

Indicates the type of mounting ends for the upper and lower end of each shock absorber.

They are listed as follows:

- Stud Type Mounts ("S" & "DS")
- Eye Ring and Bushing Mounts ("EB")
- Eye Ring and Bushing with Sleeve Mounts ("ES")
- Eye Ring and Bushing with Bar Pin Mounts ("BP")
- Special Mounting Codes ("SP")

Códigos de fijación :

Indica el tipo de montantes de fijación superior e inferior para cada amortiguador.

Se listan como sigue :

- Fijaciones de tipo perno («S» y «DS»)
- Fijaciones de anillo y buje («EB»)
- Fijaciones de anillo y buje con camisa («ES»)
- Fijaciones de anillo y buje con clavija («BP»)
- Códigos de fijación especiales («SP»)

Codes de montage:

Indique le type de montures supérieure et inférieure de chaque amortisseur.

Ils sont énumérés comme suit:

- Montures de type goujon ("S" & "DS")
- Montures à bague et manchon ("EB")
- Montures à bague et manchon avec collet ("ES")
- Montures à bague et manchon avec goupille ("BP")
- Codes de montures spéciales ("SP")

DUST TUBE:

Indicates whether the shock absorber is supplied with a dust tube.

Tubo de polvo :

Indica si el amortiguador está provisto con un tubo de polvo.

Tube pare-poussière:

Indique que l'amortisseur est fourni avec un tube pare-poussière.

MOUNTING ACCESSORY PACKAGE NUMBER:

The part number of the Mount Accessory Package supplied with the shock absorber.

Número de paquete de accesorios de fijación :

El número de parte del paquete de accesorios de fijación provisto con el amortiguador

Numéro d'emballage d'accessoires de montage:

Le numéro de pièce de l'emballage d'accessoires de montage fourni avec l'amortisseur.

*NOTE:

All dimensions shown are in inches

*NOTA :

Todas las dimensiones son en pulgadas

*NOTE:

Toutes les dimensions indiquées sont en pouces

STEP 4: Refer to shock absorber specifications by end mount. Start first by finding the appropriate series. Next, match the extended/collapsed length and find the correct mounting codes. Refer to the far left column of the chart for the correct Gabriel Shock Absorber part number.

4º PASO

Consulte las especificaciones del amortiguador mostradas al final del catálogo. Encuentre primero la serie adecuada. Luego, compare las longitudes de extensión y de compresión, y encuentre los códigos de fijación correctos. Consulte la columna del extremo izquierdo de la tabla para identificar el número de parte del amortiguador Gabriel correcto.

4^E ÉTAPE

Reportez-vous aux spécifications d'amortisseur énoncées à la fin du catalogue. Trouvez d'abord la série appropriée. Comparez ensuite les longueurs d'extension et de compression et trouvez les bons codes de fixation. Reportez-vous à la colonne située à l'extrême gauche du tableau pour identifier le bon numéro de pièce pour un amortisseur Gabriel.

SPECIFICATIONS BY END MOUNT

ESPECIFICACIONES POR FIJACIÓN DE EXTREMIDADES

SPÉCIFICATIONS PAR FIXATION DES EXTRÉMITÉS

Gabriel	Mounting		Bore	External Diameter Illustration	Extended	Lengths		Stroke	Dust Tube	Recoil Cutoff	Controls *	
	Upper	Lower				Collapsed	Rebound				Compression	
G62010			1-3/8"		26.94	16	10.94					
G62013			1-3/8"		26.52	16.33	10.19					
G62012			1-3/8"		24.11	15.17	8.94					
G62011			1-3/8"		23.36	14.21	9.14					
G62009			1-3/8"		23.29	14.25	9.04					
G62014			1-3/8"		22.75	14.56	8.19					
630811			1-3/16"		22.45	14.10	8.35	NO	NO			
632147			1-3/16"		22.45	14.10	8.35	NO	NO			
G62015			1-3/8"		21.32	13.63	7.69					
G62016			1-3/8"		15.91	11.22	4.69					
G62008	373768	ES26	1-3/8"		21.79	13.60	8.19					
G61885	375166	413004	1-3/8"		22.24	13.56	8.69					
G61969	412847	ES34	1-3/8"		20.75	13.31	7.44					
G61872	412998	ES82	1-3/8"		21.65	13.29	8.36					
G61877	413000	413000	1-3/8"		16.93	11.24	5.69					
G62003	413000	413000	1-3/8"		16.83	11.27	5.56					
G61878	413001	ES186	1-3/8"		24.16	14.97	9.19					
G61883	413001	ES186	1-3/8"		22.82	14.38	8.44					
G61867	413002	413002	1-3/8"		27.31	16.37	10.94					
G61870	413002	413002	1-3/8"		24.89	15.20	9.69					
G61873	413002	413002	1-3/8"		15.75	10.56	5.19					
G60110	BP1	ES130	1-3/8"		25.58	15.30	10.28	YES	NO			
G60083	BP1	ES27	1-3/8"		23.16	14.13	9.03	YES	NO			
G61967	BP18	ES130	1-3/8"		22.62	14.43	8.19					
G61966	BP18	ES130	1-3/8"		22.44	14.50	7.94					
G61880	BP18	ES18	1-3/8"		22.50	14.06	8.44					
G60265	BP18	ES24	1-3/8"		19.49	12.21	7.28	YES	NO			
G60053	BP2	EB1	1-3/8"		20	12.47	7.53	YES	NO			
83041	BP27	S10	1-3/8"	A	10.51†	8.34†	3.02	YES	YES	486	189	
G60161	BP33	ES83	1-3/8"		25.58	15.30	10.28	YES	NO			
G61879	BP34	ES34	1-3/8"		23	14.31	8.69					
G61882	BP34	ES34	1-3/8"		21	13.31	7.69					
83013	BP8	BP8	1-3/16"	2" D/T	7.66	6.63†	1.70	YES	NO	646	480	
G61965	BP8	ES24	1-3/8"		24.13	15.20	8.94					
G60097	BP8	ES34	1-3/8"		26.61	16.33	10.28	YES	YES			
G61898	BP8	ES34	1-3/8"		25.19	15.31	9.88					
G60196	BP8	ES34	1-3/8"		24.33	14.80	9.53	YES	NO			
G60050	BP8	ES34	1-3/8"		24	14.47	9.53	YES	NO			
G61897	BP8	ES34	1-3/8"		23.87	14.68	9.19					
G61896	BP8	ES34	1-3/8"		22.36	13.92	8.44					
G61177	BP8	ES83	1-3/8"		28.23	17.95	10.28					
G60222	BP8	ES83	1-3/8"		25	14.97	10.03	YES	NO			
83015	BP8	S1	1-3/8"	A	9.79	7.55	2.24	YES	YES	735	430	
83005	BP8	S10	1-3/16"	2" D/T	7.34	5.87	1.47	YES	NO	858	216	
G60235	EB1	EB1	1-3/8"		27.58	16.30	11.28	YES	NO			
G60067	EB1	EB1	1-3/8"		26.33	15.55	10.78	NO	NO			
G60204	EB1	EB1	1-3/8"		25.08	15.05	10.03	YES	NO			
83401	EB1	EB1	1-3/16"	F	24.09	14.26	9.83	YES	NO	341	252	
G60075	EB1	EB1	1-3/8"		24.08	14.55	9.53	YES	NO			
G60069	EB1	EB1	1-3/8"		23.33	13.95	9.38	NO	NO			
G60329	EB1	EB1	1-3/8"		22.73	13.87	8.86	YES	YES			
G60101	EB1	EB1	1-3/8"		22.58	13.80	8.78	YES	NO			

★ Will be available in first quarter of 2011.

* Damping force, in pounds, to either extend or collapse the shock absorber at an average operating velocity.
 Fuerza de amortiguación en libras para extender o comprimir el amortiguador a una velocidad de operación promedio.
 La puissance d'amortissement en poids de l'amortisseur, soit comprimé, soit détendu, à une vitesse de fonctionnement moyenne.

† At bumper contact / Al contacto cone el tope de goma. / Au contact avec le butoir.

SPECIFICATIONS BY END MOUNT

ESPECIFICACIONES POR FIJACIÓN DE EXTREMIDADES

SPÉCIFICATIONS PAR FIXATION DES EXTRÉMITÉS

Gabriel	Mounting		Bore	External Diameter Illustration	Lengths			Dust Tube	Recoil Cutoff	Controls *	
	Upper	Lower			Extended	Collapsed	Stroke			Rebound	Compression
G60096	EB1	EB1	1-3/8"		21.99	13.71	8.28	YES	NO		
G60308	EB1	EB1	1-3/8"		20.23	12.37	7.86	YES	NO		
G60031	EB1	EB1	1-3/8"		20	12.47	7.53	YES	NO		
G60232	EB1	EB1	1-3/8"		19.08	12.05	7.03	YES	NO		
83007	EB1	EB1	1-3/8"	A	18.54	11.67	6.87	NO	NO	489	343
G60003	EB1	EB1	1-3/8"		18.08	11.55	6.53	YES	NO		
G60353	EB1	EB1	1-3/8"		17.73	11.12	6.61	YES	NO		
83011	EB1	EB1	1-3/8"	A	11.55†	8.43	3.62	YES	YES	738	330
83012	EB1	EB1	1-3/8"	A	11.05†	8.18	3.37	YES	YES	738	330
G60048	EB1	ES106	1-3/8"		27.08	16.05	11.03	NO	NO		
G60063	EB1	ES106	1-3/8"		23.08	14.05	9.03	YES	NO		
G60152	EB1	ES142	1-3/8"		19.74	12.46	7.28	YES	NO		
G60113	EB1	ES24	1-3/8"		16	10.47	5.53	YES	NO		
G60068	EB1	ES25	1-3/8"		26.33	15.55	10.78	NO	NO		
G60007	EB1	ES25	1-3/8"		23	13.97	9.03	YES	NO		
G60042	EB1	ES25	1-3/8"		20.08	12.55	7.53	YES	NO		
G60099	EB1	ES25	1-3/8"		19.08	12.05	7.03	YES	NO		
G60065	EB1	ES34	1-3/8"		29.33	17.30	12.03	NO	NO		
G61151	EB1	ES83	1-3/8"		31.51	18.48	13.03	YES	NO		
G61888	EB1	ES83	1-3/8"		31.36	18.67	12.69				
G60066	EB1	ES83	1-3/8"		29.75	17.22	12.53	NO	NO		
G61887	EB1	ES83	1-3/8"		29.71	17.77	11.94				
G61149	EB1	ES83	1-3/8"		28.86	17.08	11.78	YES	NO		
G60143	EB1	ES83	1-3/8"		27.08	16.05	11.03	YES	NO		
G61115	EB1	ES83	1-3/8"		27.08	16.05	11.03	YES	NO		
G60081	EB1	ES83	1-3/8"		26.76	15.98	10.78	YES	NO		
G60084	EB1	ES83	1-3/8"		25.50	15.22	10.28	YES	NO		
G61152	EB1	ES83	1-3/8"		25.50	15.22	10.28	YES	NO		
G61964	EB1	ES83	1-3/8"		25.47	15.53	9.94				
G61963	EB1	ES83	1-3/8"		24.75	15.06	9.69				
G60144	EB1	ES83	1-3/8"		23.08	14.05	9.03	YES	NO		
G61113	EB1	ES83	1-3/8"		23.08	14.05	9.03	YES	NO		
G61150	EB1	ES83	1-3/8"		23	13.97	9.03	YES	NO		
G60035	EB1	ES83	1-3/8"		21.58	13.30	8.28	YES	NO		
G60100	EB1	S1	1-3/8"		19.05	11.77	7.28	YES	NO		
G60180	EB1	S7	1-3/8"		19.55	12.27	7.28	YES	YES		
85063	EB2	EB2	1-5/8"	C	32.01	18.85	13.16	YES	NO	762	174
83107	EB2	EB2	1-3/8"	A	31.60	18.36	13.24	YES	NO	352	77
83314	EB2	EB2	1-3/8"	B	30.64	18.11	12.53	YES	YES	633	143
85024	EB2	EB2	1-5/8"	C	28.74	17.21	11.53	YES	YES	1008	539
83309	EB2	EB2	1-3/8"	B	28.64	17.11	11.53	YES	YES	589	135
89416	EB2	EB2	1-5/8"	G	28.62	17.54	11.08	YES	YES	1155‡	514‡
89401	EB2	EB2	1-5/8"	G	28.41	17.16	11.25	YES	NO	665‡	194‡
89446	EB2	EB2	1-5/8"	G	28.36	17.41	10.95	YES	YES	702‡	204‡
85046	EB2	EB2	1-5/8"	C	27.51	16.60	10.91	YES	YES	1008	539
89434	EB2	EB2	1-5/8"	G	27.12	16.79	10.33	YES	YES	1155‡	514‡
89403	EB2	EB2	1-5/8"	G	26.86	17.16	9.70	YES	YES	929‡	281‡
83312	EB2	EB2	1-3/8"	B	26.64	16.11	10.53	YES	YES	527	152
89409	EB2	EB2	1-5/8"	G	26.36	16.41	9.95	YES	YES	567‡	165‡
89439	EB2	EB2	1-5/8"	G	25.67	15.79	9.88	YES	NO	518‡	103‡
85055	EB2	EB2	1-5/8"	C	25.63	15.60	10.03	YES	NO	577	102
85047	EB2	EB2	1-5/8"	C	25.25	15.47	9.78	YES	YES	1008	539

★ Will be available in first quarter of 2011.

* Damping force, in pounds, to either extend or collapse the shock absorber at an average operating velocity.

Fuerza de amortiguación en libras para extender o comprimir el amortiguador a una velocidad de operación promedio.

La puissance d'amortissement en poids de l'amortisseur, soit comprimé, doit détendu, à une vitesse de fonctionnement moyenne.

† At bumper contact / Al contacto con el tope de goma. / Au contact avec le butoir.

‡ For GasSLX Series, forces are at the "Firm" (F) setting. / Para la serie Gas SLX, las fuerzas están ajustada en (F) "Firme". / Pour la série GasSLX, le réglage de la force est sur « Ferme » (F).

SPECIFICATIONS BY END MOUNT

ESPECIFICACIONES POR FIJACIÓN DE EXTREMIDADES

SPÉCIFICATIONS PAR FIXATION DES EXTRÉMITÉS

Gabriel	Mounting		Bore	External Diameter Illustration	Extended	Lengths		Stroke	Dust Tube	Recoil Cutoff	Controls *	
	Upper	Lower				Collapsed	Rebound				Compression	
83308	EB2	EB2	1-3/8"	B	25.14	15.36	9.78	YES	YES	445	180	
89435	EB2	EB2	1-5/8"	G	24.86	15.66	9.20	YES	YES	1155‡	514‡	
83200	EB2	EB2	1-3/8"	A	24.51	14.98	9.53	YES	NO	806	370	
89402	EB2	EB2	1-5/8"	G	24.41	15.16	9.25	YES	NO	874‡	206‡	
83216	EB2	EB2	1-3/8"	A	23.51	14.48	9.03	YES	NO	776	262	
85054	EB2	EB2	1-5/8"	C	23.26	14.35	8.91	YES	NO	602	104	
89438	EB2	EB2	1-5/8"	G	23.17	14.54	8.63	YES	NO	583‡	103‡	
G60103	EB2	EB2	1-3/8"		22.39	13.86	8.53	YES	NO			
83159★	EB2	EB2	1-3/8"	A	21.62	13.40	8.14	YES	NO	658	149	
G60128	EB2	EB2	1-3/8"		21.39	13.36	8.03	YES	NO			
85012	EB2	EB2	1-5/8"	C	21	13.22	7.78	YES	NO	523	199	
89413	EB2	EB2	1-5/8"	G	20.91	13.41	7.50	YES	NO	536‡	201‡	
85023	EB2	EB2	1-5/8"	C	20.24	12.96	7.28	YES	YES	1008	539	
89415	EB2	EB2	1-5/8"	G	20.12	13.29	6.83	YES	YES	1155‡	514‡	
83219	EB2	EB2	1-3/8"	A	20.01	12.73	7.28	YES	NO	299	125	
85062	EB2	EB2	1-5/8"	C	19.76	12.60	7.20	YES	NO	523	199	
89408	EB2	EB2	1-5/8"	G	19.67	12.79	6.88	YES	NO	536‡	201‡	
G60119	EB2	ES27	1-3/8"		24.24	14.71	9.53	YES	NO			
85025	EB2	S21	1-5/8"	C	23	13.97	9.03	YES	NO	1079	539	
G60088	EB2	S32	1-3/8"		22.78	14	8.78	YES	NO			
85376	EB3	EB3	1-5/8"	D	33.25	19.72	13.53	YES	NO	668	134	
85301	EB3	EB3	1-5/8"	D	31.92	19.03	12.89	YES	NO	1442	455	
85339	EB3	EB3	1-5/8"	D	31.68	19.02	12.66	YES	YES	804	463	
85040	EB3	EB3	1-5/8"	C	30.90	18.49	12.41	YES	NO	889	114	
85730	EB3	EB3	1-5/8"	D	30.75	18.72	12.03	YES	YES	1517	293	
85315	EB3	EB3	1-5/8"	D	29.66	18.15	11.51	YES	NO	380	142	
85901	EB3	EB3	1-5/8"	G	29.05	17.64	11.41	YES	NO	1830	418	
85704	EB3	EB3	1-5/8"	D	28.75	18.72	10.03	YES	YES	1435	186	
83104	EB3	EB3	1-3/8"	A	28.24	17.12	11.12	YES	NO	698	133	
85305	EB3	EB3	1-5/8"	D	27.25	16.72	10.53	YES	NO	1120	225	
83362	EB3	EB3	1-3/8"	B	27	16.25	10.75	YES	NO	539	202	
87004	EB3	EB3	2-1/16"	E	26.76	16.76	10	YES	YES	1158	190	
85735	EB3	EB3	1-5/8"	D	26.74	16.71	10.03	YES	YES	1288	227	
83215	EB3	EB3	1-3/8"	A	26.64	16.36	10.28	YES	NO	661	125	
89425	EB3	EB3	1-5/8"	G	26.50	16.80	9.70	YES	YES	1352‡	167‡	
85314	EB3	EB3	1-5/8"	D	26.50	16.47	10.03	YES	YES	1216	169	
89410	EB3	EB3	1-5/8"	G	26.33	16.42	9.91	YES	NO	1185‡	182‡	
85001	EB3	EB3	1-5/8"	C	26.27	16.36	9.91	YES	NO	1202	186	
87003	EB3	EB3	2-1/16"	E	26.26	16.51	9.75	YES	YES	1332	395	
85313	EB3	EB3	1-5/8"	D	26.26	16.35	9.91	YES	YES	717	111	
89429	EB3	EB3	1-5/8"	G	26.18	16.43	9.75	YES	NO	553‡	266‡	
85700	EB3	EB3	1-5/8"	D	26.13	16.60	9.53	YES	YES	1446	328	
85320	EB3	EB3	1-5/8"	D	26.13	16.35	9.78	YES	NO	970	308	
83140	EB3	EB3	1-3/8"	A	25.27	15.52	9.75	YES	NO	738	88	
83141	EB3	EB3	1-3/8"	A	25.27	15.52	9.75	YES	NO	408	113	
83132	EB3	EB3	1-3/8"	A	25.24	15.50	9.74	YES	NO	828	150	
89422	EB3	EB3	1-5/8"	G	25.13	16.18	8.95	YES	YES	794‡	253‡	
85308	EB3	EB3	1-5/8"	D	25.13	15.85	9.28	YES	YES	764	254	
85714	EB3	EB3	1-5/8"	D	25.13	15.85	9.28	YES	YES	1220	175	
85715	EB3	EB3	1-5/8"	D	25.13	15.85	9.28	YES	YES	1915	200	
85717	EB3	EB3	1-5/8"	D	25.13	15.85	9.28	YES	YES	1915	200	
85303	EB3	EB3	1-5/8"	D	24.75	15.47	9.28	YES	NO	1019	221	

★ Will be available in first quarter of 2011.

* Damping force, in pounds, to either extend or collapse the shock absorber at an average operating velocity.

Fuerza de amortiguación en libras para extender o comprimir el amortiguador a una velocidad de operación promedio.

La puissance d'amortissement en poids de l'amortisseur, soit comprimé, soit détendu, à une vitesse de fonctionnement moyenne.

‡ For GasSLX Series, forces are at the "Firm" (F) setting. / Para la serie Gas SLX, las fuerzas están ajustada en (F) "Firme". / Pour la série GasSLX, le réglage de la force est sur « Ferme » (F).

SPECIFICATIONS BY END MOUNT

ESPECIFICACIONES POR FIJACIÓN DE EXTREMIDADES

SPÉCIFICATIONS PAR FIXATION DES EXTRÉMITÉS

Gabriel	Mounting		Bore	External Diameter Illustration	Extended	Lengths Collapsed	Stroke	Dust Tube	Recoil Cutoff	Controls *	
	Upper	Lower								Rebound	Compression
85053	EB3	EB3	1-5/8"	C	24.65	15.49	9.16	YES	NO	1019	227
89442	EB3	EB3	1-5/8"	G	24.55	15.55	9	YES	NO	1055‡	224‡
85329	EB3	EB3	1-5/8"	D	24.50	15.47	9.03	YES	YES	1550	232
85713	EB3	EB3	1-5/8"	D	24.50	15.47	9.03	YES	YES	1157	180
89412	EB3	EB3	1-5/8"	G	24.26	15.68	8.58	YES	YES	1155‡	169‡
85007	EB3	EB3	1-5/8"	C	24.21	15.30	8.91	YES	YES	1008	171
83225	EB3	EB3	1-3/8"	A	24.14	15.11	9.03	YES	YES	482	159
85307	EB3	EB3	1-5/8"	D	24.01	15.10	8.91	YES	NO	1094	173
85702	EB3	EB3	1-5/8"	D	23.76	15.85	7.91	YES	YES	1093	825
87006	EB3	EB3	2-1/16"	E	23.75	15.25	8.50	YES	YES	1158	272
85736	EB3	EB3	1-5/8"	D	23.62	15.21	8.41	YES	YES	1155	352
87002	EB3	EB3	2-1/16"	E	23.50	15.41	8.09	YES	YES	879	203
89420	EB3	EB3	1-5/8"	G	22.81	14.68	8.13	YES	NO	862‡	258‡
83217	EB3	EB3	1-3/8"	A	22.77	14.49	8.28	YES	YES	539	202
85302	EB3	EB3	1-5/8"	D	22.75	14.66	8.09	YES	NO	836	253
85304	EB3	EB3	1-5/8"	D	22.25	14.22	8.03	YES	NO	767	325
85732	EB3	EB3	2-1/16"	E	22.13	15.11	7.03	YES	YES	2632	382
85718	EB3	EB3	1-5/8"	D	22.13	15.04	7.09	YES	YES	2506	206
85716	EB3	EB3	1-5/8"	D	22.01	14.35	7.66	YES	YES	1220	175
87001	EB3	EB3	2-1/16"	E	20.76	13.76	7	YES	YES	1158	190
85734	EB3	EB3	1-5/8"	D	20.74	13.71	7.03	YES	YES	1288	227
85004	EB3	EB3	1-5/8"	C	20.68	13.67	7.01	YES	YES	1019	219
85042	EB3	EB3	1-5/8"	C	20.64	13.61	7.03	YES	YES	333	161
85712	EB3	EB3	1-5/8"	D	20.50	13.47	7.03	YES	YES	1435	562
85720	EB3	EB3	1-5/8"	D	20.50	13.47	7.03	YES	YES	1435	562
85968★	EB3	EB3	1-5/8"	G	19.87	13.39	6.48	YES	YES	1069	227
83214	EB3	EB3	1-3/8"	A	19.64	12.86	6.78	YES	NO	269	90
89419	EB3	EB3	1-5/8"	G	18	12.55	5.45	YES	YES	1352‡	636‡
85300	EB3	EB3	1-5/8"	D	18	12.22	5.78	YES	YES	1435	676
85719	EB3	EB3	1-5/8"	D	17.25	11.97	5.28	YES	YES	1517	213
85334	EB3	EB3	1-5/8"	D	14.50	10.47	4.03	YES	YES	1271	319
85327	EB3	ES160	1-5/8"	D	16.01	12.10	3.91	YES	YES	764	162
85322	EB3	ES160	1-5/8"	D	15.26	11.85	3.41	YES	YES	764	162
85912	EB3	ES36	1-5/8"	G	18.68	12.57	6.11	YES	YES	1020	219
83353	EB3	S21	1-3/8"	B	24.84	15.06	9.78	YES	NO	432	214
85740★	EB3	S21	1-5/8"	D	24.70	15.15	9.55	YES	YES	848	305
85312	EB3	S21	1-5/8"	D	23.69	14.85	8.84	YES	YES	717	111
85733	EB3	S21	1-5/8"	D	23.57	14.73	8.84	YES	YES	717	111
85330	EB3	S21	1-5/8"	D	22.44	14.16	8.28	YES	YES	1140	176
85729	EB3	S21	1-5/8"	D	21.58	13.80	7.78	YES	YES	783	111
85723	EB3	S21	1-5/8"	D	19.94	12.91	7.03	YES	YES	1318	248
83117	EB4	EB1	1-3/8"	A	23.94	14.45	9.49	YES	NO	354	300
G60028	EB4	EB4	1-3/8"		20.89	13.11	7.78	YES	NO		
83119	EB4	ES165	1-3/8"	A	23.96	14.84	9.12	YES	NO	354	300
G60226	EB5	ES24	1-3/8"		21.16	13.38	7.78	YES	YES		
G60079	EB5	ES25	1-3/8"		18.14	11.61	6.53	YES	NO		
G60186	EB5	ES83	1-3/8"		21.16	13.38	7.78	YES	NO		
G60014	EB7	ES24	1-3/8"		15	9.97	5.03	YES	NO		
G60010	EB7	ES34	1-3/8"		23.33	14.30	9.03	YES	NO		
83303	EB7	ES36	1-3/8"	B	24.86	15.08	9.78	YES	NO	470	122
83304	EB7	ES36	1-3/8"	B	22.86	14.08	8.78	YES	NO	470	122
G60185	EB7	ES36	1-3/8"		22.48	13.96	8.53	YES	NO		

★ Will be available in first quarter of 2011.

* Damping force, in pounds, to either extend or collapse the shock absorber at an average operating velocity.

Fuerza de amortiguación en libras para extender o comprimir el amortiguador a una velocidad de operación promedio.

La puissance d'amortissement en poids de l'amortisseur, soit comprimé, soit détendu, à une vitesse de fonctionnement moyenne.

‡ For GasSLX Series, forces are at the "Firm" (F) setting. / Para la serie Gas SLX, las fuerzas estan ajustada en (F) "Firme". / Pour la série GasSLX, le réglage de la force est sur « Ferme » (F).

SPECIFICATIONS BY END MOUNT

ESPECIFICACIONES POR FIJACIÓN DE EXTREMIDADES

SPÉCIFICATIONS PAR FIXATION DES EXTRÉMITÉS

Gabriel	Mounting		Bore	External Diameter Illustration	Extended	Lengths		Stroke	Dust Tube	Recoil Cutoff	Controls *	
	Upper	Lower				Collapsed	Rebound				Compression	
G60121	ES1	EB1	1-3/8"		14.98	10.20	4.78	YES	YES			
G60077	ES1	ES18	1-3/8"		22.81	14.03	8.78	YES	NO			
G60062	ES1	ES18	1-3/8"		18	11.47	6.53	YES	NO			
G60120	ES1	ES25	1-3/8"		18.41	11.88	6.53	YES	NO			
83023	ES10		1"	1-5/8"	8.70	7.09†	2.14	NO	YES	484	157	
83002	ES10	ES10	1-3/8"	A	11.61	8.62	3	YES	YES	3112	590	
83024	ES10	ES10	1-3/8"	2-1/2" D/T	11.61	8.62	2.99	YES	YES	811	320	
83016	ES10	ES10	1"	1-5/8"	11.51	8.14	3.37	NO	YES	506	139	
83031	ES10	ES10	1-3/8"	2-1/2" D/T	11.49	8.62	2.87	YES	YES	811	314	
83051	ES10	ES10	1-3/8"	2-1/2" D/T	9.41	7.40	2.01	YES	YES	579	163	
83021	ES10	ES10	1-3/8"	A	9.36	7.37	1.99	YES	YES	745	315	
83046	ES10	ES181	1-3/16"		9.23†	7.62†	2.73	NO	YES	514	173	
G60197	ES104	ES69	1-3/8"		24.16	14.63	9.53	YES	NO			
G60255	ES110	ES19	1-3/8"		22.58	13.80	8.78	YES	NO			
83034	ES115	ES115	1-3/16"	1-5/8"	10.04†	7.32	2.97	NO	YES	430	129	
G61919	ES117	ES153	1-3/8"		20.25	13.06	7.19					
G60237	ES119	S38	1-3/8"		22.28	13.50	8.78	YES	NO			
83634	ES120	ES120	1-3/8"	A	27.48	16.23	11.25	YES	YES	779	157	
85011	ES120	ES121	1-5/8"	C	27.49	16.46	11.03	YES	NO	1268	186	
83120	ES120	S21	1-3/8"	A	22.12	13.63	8.49	YES	YES	779	164	
83154	ES120	S21	1-3/8"	A	20.78	12.72	8.06	YES	YES	599	140	
G61864	ES123	ES190	1-3/8"		15	10.56	4.44					
G61159	ES126	ES128	1-3/8"		16.50	10.97	5.53	YES	NO			
G60302	ES126	ES128	1-3/8"		16.48	10.87	5.61	YES	NO			
83008	ES136	ES136	1-3/8"	A	12.98†	10.15†	3.99	YES	YES	699	307	
83042	ES136	ES136	1-3/8"	A	9.88†	8.44†	2.38	YES	YES	954	541	
83030	ES136	ES136	1-3/8"	A	9.60†	7.61	2.49	YES	YES	308	87	
85026	ES136	S21	1-5/8"	C	23	13.97	9.03	YES	NO	1079	539	
89417	ES136	S21	1-5/8"	G	22.93	14.18	8.75	YES	NO	1226‡	515‡	
83047	ES149	EB1	1-3/8"	A	11.78†	9.74†	3	YES	YES	364	314	
83006	ES149	EB1	1-3/8"	A	10.66	8.48†	2.77	YES	YES	525	182	
83001	ES149	EB1	1-3/8"	A	10.41†	8.36†	3	YES	YES	793	363	
83038	ES149	EB1	1-3/8"	A	10.41†	8.36†	2.99	YES	YES	336	242	
83017	ES149	ES149	1-3/8"	A	10.93	8.35†	3.13	YES	YES	353	138	
83009	ES149	ES149	1-3/8"	A	10.41†	8.36†	2.99	YES	YES	793	363	
83039	ES149	ES149	1-3/8"	A	10.41†	8.36†	2.99	YES	YES	876	326	
89449	ES150	ES150	1-5/8"	G	23.09	14.71	8.38	YES	NO	1519‡	324‡	
85918	ES150	ES150	1-5/8"	G	22.96	14.55	8.41	YES	NO	1726	412	
85958	ES150	ES150	1-5/8"	G	22.96	14.55	8.41	YES	YES	1926	281	
85920	ES150	ES150	1-5/8"	G	21.19	13.53	7.66	YES	NO	845	49	
85922	ES150	ES150	1-5/8"	G	21.19	13.53	7.66	YES	NO	878	185	
85959	ES150	ES150	1-5/8"	G	21.19	13.53	7.66	YES	YES	1021	123	
G60163	ES151	ES128	1-3/8"		16.50	10.97	5.53	YES	YES			
G60199	ES152	ES153	1-3/8"		23.89	15.11	8.78	YES	YES			
G60160	ES152	ES153	1-3/8"		21.39	13.61	7.78	YES	YES			
83025	ES158	ES158	1-3/8"	A	7.98	6.49	1.49	YES	YES	710	230	
85724	ES158	ES159	1-5/8"	D	22.78	14.50	8.28	YES	YES	1235	454	
89443	ES158	ES159	1-5/8"	G	22.17	14.31	7.86	YES	YES	1206‡	466‡	
85331	ES158	ES159	1-5/8"	D	19.66	12.88	6.78	YES	YES	1757	396	
85335	ES158	ES159	1-5/8"	D	19.66	12.88	6.78	YES	YES	827	107	
87017★	ES160	ES160	2-1/16"	E	23.35	15.31	8.07	YES	YES	1876	220	
85061	ES161	ES162	1-5/8"	C	24.75	15.22	9.53	YES	YES	1216	195	

★ Will be available in first quarter of 2011.

* Damping force, in pounds, to either extend or collapse the shock absorber at an average operating velocity.

Fuerza de amortiguación en libras para extender o comprimir el amortiguador a una velocidad de operación promedio.

La puissance d'amortissement en poids de l'amortisseur, soit comprimé, soit détendu, à une vitesse de fonctionnement moyenne.

† At bumper contact / Al contacto cone el tope de goma. / Au contact avec le butoir.

‡ For GasSLX Series, forces are at the "Firm" (F) setting. / Para la serie Gas SLX, las fuerzas estan ajustada en (F) "Firme". / Pour la série GasSLX, le réglage de la force est sur « Ferme » (F).

SPECIFICATIONS BY END MOUNT

ESPECIFICACIONES POR FIJACIÓN DE EXTREMIDADES

SPÉCIFICATIONS PAR FIXATION DES EXTRÉMITÉS

Gabriel	Mounting		Bore	External Diameter Illustration	Extended	Lengths Collapsed	Stroke	Dust Tube	Recoil Cutoff	Controls *	
	Upper	Lower								Rebound	Compression
85066	ES161	ES162	1-5/8"	C	24.63	15.22	9.41	YES	YES	812	322
89448	ES161	ES162	1-5/8"	G	24.62	15.54	9.08	YES	YES	782‡	323‡
89450	ES161	ES162	1-5/8"	G	24.62	15.54	9.08	YES	YES	1282‡	193‡
85065	ES161	S21	1-5/8"	C	28.02	16.99	11.03	YES	YES	1059	300
85083	ES162	S42	1-5/8"	C	27.81	16.53	11.28	YES	YES	1429	184
83142	ES162	S42	1-3/8"	A	23.92	14.50	9.43	YES	YES	367	131
83143	ES162	S42	1-3/8"	A	21.92	13.50	8.43	YES	YES	403	137
83049	ES163	ES163	1-3/8"	A	8.02	6.53	1.48	YES	YES	2879	705
83032	ES163	ES163	1-3/8"	A	7.85	6.36	1.49	NO	YES	779	135
83116	ES164	ES165	1-3/8"	A	23.81	14.68	9.12	YES	NO	354	300
83118	ES164	ES90	1-3/8"	A	24.45	14.71	9.74	YES	NO	410	311
83035	ES166	ES136	1-3/8"	A	12.96†	9.33	4.13	YES	YES	320	100
83029	ES168	ES169	1-5/8"	C	10.35	7.94	2.41	YES	NO	1303	1349
83040	ES171	ES172	1-3/8"	A	10.41†	8.36†	2.99	YES	YES	876	326
87015	ES173	ES173	45MM	E	15.51	11.18	4.33	YES	YES	4950	900
85737	ES173	ES173	1-5/8"	D	15.11	10.84	4.27	YES	YES	3066	782
89459★	ES174	EB3	1-5/8"	G	25.62	15.86	9.78	YES	NO	1179	314
85070	ES174	EB3	1-5/8"	C	25.60	15.82	9.78	YES	NO	1100	310
85067	ES174	ES136	1-5/8"	C	30.51	18.10	12.41	YES	YES	676	170
89451	ES174	ES136	1-5/8"	G	30.36	18.41	11.95	YES	YES	645‡	172‡
85084★	ES174	ES136	1-5/8"	C	20.59	13.03	7.57	YES	NO	1145	407
89460★	ES174	ES136	1-5/8"	G	20.58	13.03	7.55	YES	NO	997	384
85937	ES174	S43	1-5/8"	G	18.98	12.26	6.72	YES	YES	1479	337
85936	ES174	S43	1-5/8"	G	17.23	11.38	5.85	YES	YES	1479	337
89456	ES174	S43	1-5/8"	G	17.02	11.29	5.73	YES	YES	975‡	377‡
85955	ES175	ES150	1-5/8"	G	21.25	13.66	7.59	YES	YES	1034	397
89454	ES175	ES175	1-5/8"	G	18.23	12.78	5.45	YES	YES	938‡	388‡
85933	ES175	ES175	1-5/8"	G	18.23	12.71	5.52	YES	YES	1089	383
85081	ES175	S21	1-5/8"	C	23.44	14.33	9.11	YES	YES	1658	250
85080	ES175	S21	1-5/8"	C	22.51	13.78	8.74	YES	NO	447	138
85031	ES176	EB2	1-5/8"	C	25.63	15.85	9.78	YES	NO	941	257
85923	ES177	ES161	1-5/8"	G	22.48	14.50	7.98	YES	YES	1940	221
85931	ES177	ES161	1-5/8"	G	22.48	14.50	7.98	YES	YES	1435	220
89458	ES177	ES161	1-5/8"	G	22.47	14.25	7.95	YES	YES	1575‡	222‡
85930	ES177	ES161	1-5/8"	G	17.86	12	5.86	YES	YES	1617	342
85932	ES178	ES150	1-5/8"	G	21.23	13.62	7.61	YES	YES	1102	430
89453	ES178	ES150	1-5/8"	G	21.10	13.78	7.32	YES	YES	860‡	435‡
85965★	ES178	ES161	1-5/8"	G	24.24	15.15	9.09	YES	YES	2206	238
85966★	ES178	ES161	1-5/8"	G	23.25	14.64	8.62	YES	YES	2206	238
85967★	ES178	ES176	1-5/8"	G	23.93	14.86	9.07	YES	YES	2206	238
85961	ES178	ES176	1-5/8"	G	22.83	14.17	8.66	YES	YES	2206	240
85962	ES178	ES176	1-5/8"	G	21.80	13.66	8.15	YES	YES	2206	240
83148	ES179	ES179	1-3/8"	A	30	17.83	12.17	YES	YES	604	149
83147	ES179	ES179	1-3/8"	A	28.53	17.34	11.15	YES	YES	358	128
G61175	ES18	ES126	1-3/8"		23.33	14.80	8.53				
G61180	ES18	ES138	1-3/8"		24.58	14.80	9.78				
G61890	ES18	ES18	1-3/8"		23.97	15.28	8.69				
G61891	ES18	ES18	1-3/8"		23.97	15.28	8.69				
G60233	ES18	ES18	1-3/8"		18	11.47	6.53	YES	NO		
85377	ES182	ES182	1-5/8"	D	23.80	14.84	8.96	YES	YES	1937	570
85378	ES182	ES182	1-5/8"	D	23.80	14.84	8.96	YES	YES	1110	240
85956	ES183	ES184	1-5/8"	G	30.63	18.75	11.87	YES	YES	979	373

★ Will be available in first quarter of 2011.

* Damping force, in pounds, to either extend or collapse the shock absorber at an average operating velocity.

Fuerza de amortiguación en libras para extender o comprimir el amortiguador a una velocidad de operación promedio.

La puissance d'amortissement en poids de l'amortisseur, soit comprimé, soit détendu, à une vitesse de fonctionnement moyenne.

‡ For GasSLX Series, forces are at the "Firm" (F) setting. / Para la serie Gas SLX, las fuerzas estan ajustada en (F) "Firme". / Pour la série GasSLX, le réglage de la force est sur « Ferme » (F).

† At bumper contact / Al contacto cone el tope de goma. / Au contact avec le butoir.

SPECIFICATIONS BY END MOUNT

ESPECIFICACIONES POR FIJACIÓN DE EXTREMIDADES

SPÉCIFICATIONS PAR FIXATION DES EXTRÉMITÉS

Gabriel	Mounting		Bore	External Diameter Illustration	Extended	Lengths		Stroke	Dust Tube	Recoil Cutoff	Controls *	
	Upper	Lower				Collapsed	Rebound				Compression	
83053	ES185	ES185	1-3/8"	A	10.91	7.93	2.97	YES	YES	968	214	
83054	ES185	ES185	1-3/8"	A	10.28	7.56	2.72	YES	YES	1004	184	
83052	ES185	ES185	1-3/8"	2-1/2" D/T	9.41	7.19	2.23	YES	NO	1101	149	
G61875	ES186	ES186	1-3/8"		17.67	11.73	5.94					
85739	ES187	ES187	1-5/8"	D	20.73	13.54	7.19	YES	YES	3247	334	
85341★	ES188	S21	1-5/8"	D	30.95	18.10	12.85	YES	YES	1807	333	
85970★	ES188	S21	1-5/8"	G	27.19	16.40	10.78	YES	YES	1092	147	
85340★	ES188	S21	1-5/8"	D	26.46	15.85	10.61	YES	YES	1807	165	
G61892	ES19	ES141	1-3/8"		23.97	15.28	8.69					
G61178	ES19	ES141	1-3/8"		22.58	13.80	8.78					
83045	ES19	S1	1-3/8"	A	11.53†	8.58†	3.81	YES	NO	510	153	
83050	ES19	S1	1-3/8"	A	10.43†	8.38†	2.90	YES	YES	599	321	
G60029	ES2	EB4	1-3/8"		28.74	16.96	11.78	YES	NO			
G60012	ES2	EB4	1-3/8"		24.74	14.96	9.78	YES	NO			
G60045	ES2	ES24	1-3/8"		22.08	13.55	8.53	YES	NO			
G60021	ES2	ES24	1-3/8"		19.86	12.58	7.28	YES	NO			
G60307	ES2	ES27	1-3/8"		20.49	12.63	7.86	YES	NO			
83158★	ES22	ES22	1-3/8"	A	12.96	8.97	4	YES	NO	783	484	
G60015	ES24	ES24	1-3/8"		15	9.97	5.03	YES	NO			
83022	ES24	ES24	1"	2" D/T	14.28	9.33	4.95	YES	NO	840	152	
83010	ES24	ES24	1"	2" D/T	14.15†	9.33	5.07	YES	YES	188	70	
83026	ES24	ES24	1-3/8"	A	13.11	9.12	3.99	YES	YES	602	104	
83018	ES24	S1	1-3/8"	A	10.30†	8.42†	3.24	YES	YES	515	174	
83019	ES24	S1	1-3/8"	A	9.42	8.16†	2.28	YES	YES	509	121	
83027	ES24	S10	1-3/8"	A	13.80	9.18	4.62	YES	YES	602	104	
G60260	ES25	ES25	1-3/8"		23	13.97	9.03	YES	NO			
83044	ES27	ES164	1-3/8"	A	10.91	7.93	2.98	YES	YES	789	296	
G60039	ES27	ES27	1-3/8"		20.76	12.98	7.78	YES	NO			
G60309	ES3	ES24	1-3/8"		18.23	11.37	6.86	YES	NO			
G60008	ES3	ES24	1-3/8"		18.08	11.55	6.53	YES	NO			
G60047	ES3	ES34	1-3/8"		26.76	15.98	10.78	YES	NO			
G60112	ES3	ES82	1-3/8"		18.58	11.80	6.78	YES	NO			
G61868	ES31	412715	1-3/8"		15.62	10.68	4.94					
G60064	ES31	ES24	1-3/8"		23.33	14.05	9.28	NO	NO			
G61918	ES34	ES141	1-3/8"		21.25	13.56	7.69					
G61970	ES34	ES34	1-3/8"		27.58	17.14	10.44					
G61971	ES34	ES34	1-3/8"		27.58	17.14	10.44					
G62000	ES34	ES34	1-3/8"		27.36	17.67	9.69					
G60218	ES34	ES34	1-3/8"		26.86	16.08	10.78	YES	NO			
G61961	ES34	ES34	1-3/8"		26.51	16.12	10.39					
G61962	ES34	ES34	1-3/8"		26.05	15.87	10.18					
G61959	ES34	ES34	1-3/8"		24.78	15.84	8.94					
G60206	ES34	ES34	1-3/8"		24.58	15.05	9.53	YES	NO			
G60044	ES34	ES34	1-3/8"		23.36	14.33	9.03	YES	NO			
G61866	ES34	ES34	1-3/8"		22.81	14.12	8.69					
83153	ES34	ES34	1-3/8"	A	21.69	13.62	8.07	YES	YES	974	206	
83155	ES34	ES34	1-3/8"	A	21.69	13.62	8.07	YES	YES	507	80	
G61153	ES34	ES36	1-3/8"		22.49	13.95	8.53	YES	NO			
83004	ES35	ES136	1"	2" D/T	9.36†	7.29	2.32	YES	YES	539	324	
85905	ES36	EB3	1-5/8"	G	23.81	16.16	7.66	YES	YES	1020	219	
85913	ES36	EB3	1-5/8"	G	22.56	15.20	7.36	YES	YES	1020	219	
85057	ES36	EB3	1-5/8"	C	21.45	14.23	7.22	YES	YES	1216	115	

★ Will be available in first quarter of 2011.

* Damping force, in pounds, to either extend or collapse the shock absorber at an average operating velocity.
 Fuerza de amortiguación en libras para extender o comprimir el amortiguador a una velocidad de operación promedio.
 La puissance d'amortissement en poids de l'amortisseur, soit comprimé, soit détendu, à une vitesse de fonctionnement moyenne.

† At bumper contact / Al contacto cone el tope de goma. / Au contact avec le butoir.

SPECIFICATIONS BY END MOUNT

ESPECIFICACIONES POR FIJACIÓN DE EXTREMIDADES

SPÉCIFICATIONS PAR FIXATION DES EXTRÉMITÉS

Gabriel	Mounting		Bore	External Diameter Illustration	Extended	Lengths Collapsed	Stroke	Dust Tube	Recoil Cutoff	Controls *	
	Upper	Lower								Rebound	Compression
85907	ES36	EB3	1-5/8"	G	21.43	14.20	7.23	YES	YES	1216	251
83113	ES36	EB3	1-3/8"	A	20.42	13.43	6.99	YES	YES	997	238
85059	ES36	EB3	1-5/8"	C	19.07	12.79	6.28	YES	YES	928	151
85915	ES36	EB3	1-5/8"	G	19.06	12.70	6.36	YES	YES	1020	219
83115	ES36	EB3	1-3/8"	A	16.19	13.32	4.87	YES	YES	997	238
85072	ES36	ES176	1-5/8"	C	24.17	14.83	9.34	YES	YES	1387	305
83242	ES36	ES36	1-3/8"	A	33.73	20.98	12.75	YES	YES	721	135
85903	ES36	ES36	1-5/8"	G	31.99	19.13	12.86	YES	YES	666	113
83121	ES36	ES36	1-3/8"	A	30.25	18.32	11.93	YES	YES	689	126
83137	ES36	ES36	1-3/8"	A	30.03	17.78	12.25	YES	YES	517	132
85013	ES36	ES36	1-5/8"	C	29.74	17.71	12.03	YES	YES	1019	219
83205	ES36	ES36	1-3/8"	A	29.69	17.69	12	YES	YES	660	76
83209	ES36	ES36	1-3/8"	A	29.64	17.61	12.03	YES	YES	670	78
89414	ES36	ES36	1-5/8"	G	29.62	18.04	11.58	YES	YES	1045‡	217‡
85337	ES36	ES36	1-5/8"	D	28.72	17.45	11.28	YES	YES	1318	374
85006	ES36	ES36	1-5/8"	C	28.50	17.09	11.41	YES	YES	1019	219
83125	ES36	ES36	1-3/8"	A	28.12	17.13	10.99	YES	YES	625	115
85043	ES36	ES36	1-5/8"	C	27.63	16.85	10.78	YES	YES	628	163
85904	ES36	ES36	1-5/8"	G	27.61	16.88	10.73	YES	YES	666	113
85010	ES36	ES36	1-5/8"	C	26.74	16.21	10.53	YES	YES	1019	219
83123	ES36	ES36	1-3/8"	A	26.62	16.38	10.24	YES	YES	589	119
85036	ES36	ES36	1-5/8"	C	26.38	16.29	10.09	YES	YES	633	119
89405	ES36	ES36	1-5/8"	G	26.24	16.41	9.83	YES	YES	1009‡	249‡
85321	ES36	ES36	1-5/8"	D	25.36	15.58	9.78	YES	YES	1435	676
83149	ES36	ES36	1-3/8"	A	25.28	15.78	9.49	YES	YES	332	101
83122	ES36	ES36	1-3/8"	A	25.24	15.75	9.49	YES	YES	661	201
83218	ES36	ES36	1-3/8"	A	25.19	15.44	9.75	YES	YES	721	194
665472	ES36	ES36	1-5/8"	G	25.14	15.61	9.53	NO	NO	925	977
89406	ES36	ES36	1-5/8"	G	24.74	15.66	9.08	YES	YES	658‡	125‡
89430	ES36	ES36	1-5/8"	G	24.74	15.54	9.53	YES	YES	1462‡	279‡
85005	ES36	ES36	1-5/8"	C	24.74	15.21	9.53	YES	YES	1019	219
85916	ES36	ES36	1-5/8"	G	24.61	15.51	9.11	YES	YES	1149	219
83126	ES36	ES36	1-3/8"	A	24.37	15.25	9.12	YES	YES	625	115
85909	ES36	ES36	1-5/8"	G	24.24	15.13	9.11	YES	YES	700	255
83310	ES36	ES36	1-3/8"	B	24.06	14.69	9.37	YES	NO	559	153
83221	ES36	ES36	1-3/8"	A	24.01	14.73	9.28	YES	NO	599	153
85030	ES36	ES36	1-5/8"	C	24	14.84	9.16	YES	YES	1019	219
89440	ES36	ES36	1-5/8"	G	23.86	15.16	8.70	YES	YES	1498‡	561‡
83144	ES36	ES36	1-3/8"	A	23.78	15.03	8.75	YES	YES	596	93
85050	ES36	ES36	1-5/8"	C	23.50	14.47	9.03	YES	NO	525	138
89432	ES36	ES36	1-5/8"	G	23.41	14.66	8.75	YES	NO	1507‡	561‡
665937	ES36	ES36	1-5/8"	G	22.91	16.09	6.82	YES	NO		
85058	ES36	ES36	1-5/8"	C	22.63	14.22	8.41	YES	YES	722	114
85044	ES36	ES36	1-5/8"	C	22.63	14.10	8.53	YES	NO	722	212
85919	ES36	ES36	1-5/8"	G	22.48	14.25	8.23	YES	YES	1265	121
632155	ES36	ES36	1-3/16"		22.45	14.10	8.35	NO	NO		
646155	ES36	ES36	1-3/16"		22.45	14.10	8.35	NO	NO		
646177	ES36	ES36	1-3/16"		22.45	14.10	8.35	NO	NO		
89431	ES36	ES36	1-5/8"	G	22.41	14.16	8.25	YES	NO	751‡	211‡
85014	ES36	ES36	1-5/8"	C	21.74	13.71	8.03	YES	YES	1019	219
85906	ES36	ES36	1-5/8"	G	21.73	14	7.73	YES	YES	700	255
83124	ES36	ES36	1-3/8"	A	21.65	13.75	7.87	YES	YES	750	137

★ Will be available in first quarter of 2011.

* Damping force, in pounds, to either extend or collapse the shock absorber at an average operating velocity.

Fuerza de amortiguación en libras para extender o comprimir el amortiguador a una velocidad de operación promedio.

La puissance d'amortissement en poids de l'amortisseur, soit comprimé, soit détendu, à une vitesse de fonctionnement moyenne.

‡ For GasSLX Series, forces are at the "Firm" (F) setting. / Para la serie Gas SLX, las fuerzas estan ajustada en (F) "Firme". / Pour la série GasSLX, le réglage de la force est sur « Ferme » (F).

SPECIFICATIONS BY END MOUNT

ESPECIFICACIONES POR FIJACIÓN DE EXTREMIDADES

SPÉCIFICATIONS PAR FIXATION DES EXTRÉMITÉS

Gabriel	Mounting		Bore	External Diameter Illustration	Extended	Lengths		Stroke	Dust Tube	Recoil Cutoff	Controls *	
	Upper	Lower				Collapsed	Rebound				Compression	
83207	ES36	ES36	1-3/8"	A	21.64	13.61	8.03	YES	YES	553	143	
89407	ES36	ES36	1-5/8"	G	21.62	14.04	7.58	YES	YES	652‡	218‡	
85910	ES36	ES36	1-5/8"	G	20.73	13.50	7.23	YES	YES	1074	219	
85029	ES36	ES36	1-5/8"	C	20.50	13.09	7.41	YES	YES	1019	219	
83204	ES36	ES36	1-3/8"	A	20.14	12.86	7.28	YES	YES	451	110	
89437	ES36	ES36	1-5/8"	G	20.12	13.29	6.83	YES	YES	1155‡	514‡	
83127	ES36	ES36	1-3/8"	A	20.12	13.13	6.99	YES	YES	940	218	
85060	ES36	ES36	1-5/8"	C	19.75	12.72	7.03	YES	YES	943	405	
85338	ES36	ES36	1-5/8"	D	19.47	12.70	6.77	YES	YES	1664	420	
85051	ES36	ES36	1-5/8"	C	18.75	12.22	6.53	YES	YES	1019	139	
85908	ES36	ES36	1-5/8"	G	18.48	12.25	6.23	YES	YES	1020	219	
83130	ES36	ES36	1-3/8"	A	17.99	12.01	5.99	YES	YES	871	177	
85934	ES36	ES36	1-5/8"	G	17.73	12	5.73	YES	YES	3511	1063	
85738	ES36	ES36	1-5/8"	D	17.47	11.70	5.77	YES	YES	1830	416	
85323	ES36	ES36	1-5/8"	D	17.36	11.58	5.78	YES	YES	1085	163	
89436	ES36	ES36	1-5/8"	G	17.24	11.91	5.33	YES	YES	998‡	217‡	
85000	ES36	ES36	1-5/8"	C	17.22	11.46	5.76	YES	YES	1019	219	
83203	ES36	ES36	1-3/8"	A	17.10	11.36	5.74	YES	YES	609	114	
83128	ES36	ES36	1-3/8"	A	16.87	11.51	5.37	YES	YES	940	218	
85911	ES36	ES36	1-5/8"	G	16.86	11.50	5.36	YES	YES	1020	219	
85938	ES36	ES36	1-5/8"	G	16.06	10.78	5.28	YES	YES	1581	432	
85064	ES36	ES36	1-5/8"	C	16.01	10.72	5.28	YES	YES	1481	340	
83150	ES36	ES36	1-3/8"	A	15.24	10.43	4.81	YES	YES	940	216	
85078	ES36	ES36	1-5/8"	C	14.77	10.13	4.64	YES	YES	1409	282	
85045	ES36	ES36	1-5/8"	C	14.51	10.10	4.41	YES	YES	1020	219	
85939	ES36	ES36	1-5/8"	G	14.44	10.03	4.41	YES	YES	1719	420	
85914	ES36	ES36	1-5/8"	G	14.36	10.25	4.11	YES	YES	1020	219	
85052	ES36	ES36	1-5/8"	C	13.25	9.47	3.78	YES	YES	1019	139	
85079	ES36	ES36	1-5/8"	C	12.04	8.87	3.17	YES	YES	1494	325	
83157★	ES36	ES90	1-3/8"	A	26.38	15.76	10.61	YES	NO	446	303	
83635	ES36	S21	1-3/8"	A	21.74	13.25	8.49	YES	NO	558	119	
83109	ES36	S42	1-3/8"	A	26.14	15.90	10.24	YES	YES	345	78	
83111	ES36	S42	1-3/8"	A	26.14	15.90	10.24	YES	YES	560	141	
83138	ES36	S42	1-3/8"	A	23.55	14.42	9.12	YES	YES	997	231	
83110	ES36	S42	1-3/8"	A	22.89	14.27	8.62	YES	YES	450	143	
83112	ES36	S42	1-3/8"	A	21.52	13.40	8.12	YES	YES	1064	343	
83033	ES53	ES53	1-3/8"	A	13.99	10.37	3.62	YES	YES	494	312	
G61170	ES61	ES65	1-3/8"		22.58	13.80	8.78					
G60219	ES69	ES69	1-3/8"		15.58	10.55	5.03	YES	YES			
G60051	ES8	ES82	1-3/8"		16.75	10.72	6.03	NO	NO			
G60080	ES8	ES83	1-3/8"		23	13.97	9.03	YES	NO			
83160★	ES82	ES36	1-3/8"	A	24.31	14.90	9.37	YES	YES	920	161	
G60111	ES82	ES82	1-3/8"		24.58	14.80	9.78	YES	NO			
G60214	ES82	ES82	1-3/8"		22.58	13.80	8.78	YES	NO			
G60179	ES83	EB1	1-3/8"		27.58	16.30	11.28	YES	NO			
83131	ES83	ES83	1-3/8"	A	27.80	18.18	9.62	YES	NO	212	129	
G61116	ES83	ES83	1-3/8"		20.76	12.98	7.78	YES	NO			
G61869	ES83	ES83	1-3/8"		20.26	12.82	7.44					
G62002	ES83	ES83	1-3/8"		20.15	13.95	6.19					
83145	ES83	ES83	1-3/8"	A	19.93	12.32	7.54	YES	NO	479	153	
83048	ES86	ES167	1-3/8"	A	9.97	8.43†	2.37	YES	YES	904	415	
83028	ES86	ES167	1-3/8"	A	9.94	7.57	2.37	YES	YES	445	531	

★ Will be available in first quarter of 2011.

* Damping force, in pounds, to either extend or collapse the shock absorber at an average operating velocity.

Fuerza de amortiguación en libras para extender o comprimir el amortiguador a una velocidad de operación promedio.

La puissance d'amortissement en poids de l'amortisseur, soit comprimé, soit détendu, à une vitesse de fonctionnement moyenne.

‡ For GasSLX Series, forces are at the "Firm" (F) setting. / Para la serie Gas SLX, las fuerzas están ajustada en (F) "Firme". / Pour la série GasSLX, le réglage de la force est sur « Ferme » (F).

† At bumper contact / Al contacto con el tope de goma. / Au contact avec le butoir.

SPECIFICATIONS BY END MOUNT

ESPECIFICACIONES POR FIJACIÓN DE EXTREMIDADES

SPÉCIFICATIONS PAR FIXATION DES EXTRÉMITÉS

Gabriel	Mounting		Bore	External Diameter Illustration	Extended	Lengths Collapsed	Stroke	Dust Tube	Recoil Cutoff	Controls *	
	Upper	Lower								Rebound	Compression
85963	ES90	ES36	1-5/8"	G	25.49	18.68	6.81	YES	YES	1490	206
85964	ES90	ES36	1-5/8"	G	25.49	18.68	6.81	YES	YES	1981	205
85954	ES90	ES36	1-5/8"	G	20.43	12.96	7.46	YES	NO	1812	148
85924	ES90	ES36	1-5/8"	G	20.41	12.96	7.46	YES	NO	1036	122
89457	ES90	ES36	1-5/8"	G	19.95	12.71	6.97	YES	NO	941‡	156‡
85969★	ES90	ES36	1-5/8"	G	18.38	11.93	6.45	YES	NO	1612	125
83146	ES90	ES83	1-3/8"	A	24.02	14.68	9.33	YES	YES	479	119
85082	ES90	ES90	1-5/8"	C	28.60	20.64	7.97	YES	YES	1435	266
83636	ES90	ES90	1-3/8"	A	27.72	16.95	10.77	YES	YES	505	148
83100	ES90	ES90	1-3/8"	A	26.60	16.11	10.49	YES	YES	481	142
85926	ES90	ES90	1-5/8"	G	26.48	17.96	8.53	YES	YES	1387	279
85953	ES90	ES90	1-5/8"	G	26.13	15.86	10.27	YES	NO	2001	153
85003	ES90	ES90	1-5/8"	C	25.37	15.59	9.78	YES	YES	437	182
89411	ES90	ES90	1-5/8"	G	25.36	15.59	9.78	YES	YES	436‡	186‡
85927	ES90	ES90	1-5/8"	G	24.74	15.38	9.36	YES	YES	1288	388
83101	ES90	ES90	1-3/8"	A	24.60	15.11	9.49	YES	YES	481	142
85925	ES90	ES90	1-5/8"	G	22.54	15.59	6.96	YES	NO	761	144
85957	ES90	ES90	1-5/8"	G	20.78	13.15	7.63	YES	NO	1583	138
85928	ES90	ES90	1-5/8"	G	20.28	13.21	7.08	YES	NO	957	229
85929	ES90	ES90	1-5/8"	G	20.28	13.21	7.08	YES	NO	2214	267
83135	ES90	ES90	1-3/8"	A	19.48	12.36	7.12	YES	YES	519	121
83156	ES90	ES90	1-3/8"	A	18.55	11.91	6.64	YES	NO	778	135
83020	ES91	ES91	1-3/8"	A	9.41	7.17	2.24	YES	YES	796	255
G60251	ES99	EB2	1-3/8"		19.74	12.46	7.28	YES	NO		
G62006	S1	413003	1-3/8"		22.75	13.81	8.94				
G62007	S1	413003	1-3/8"		22.75	13.81	8.94				
G61889	S1	413003	1-3/8"		20.44	12.75	7.69				
G62005	S1	413003	1-3/8"		19.75	12.31	7.44				
G62004	S1	413003	1-3/8"		19.07	12.13	6.94				
G60043	S1	BP13	1-3/8"		15.80	10.02	5.78	NO	NO		
G60017	S1	BP13	1-3/8"		13.80	9.02	4.78	NO	NO		
G60338	S1	BP17	1-3/8"		14.70	9.34	5.36	NO	NO		
G60301	S1	BP26	1-3/8"		14.10	9.34	4.76	YES	YES		
G60049	S1	BP30	1-3/8"		13.80	9.02	4.78	NO	NO		
G60074	S1	BP4	1-3/8"		14.05	9.27	4.78	YES	NO		
G60078	S1	BP4	1-3/8"		13.80	9.02	4.78	NO	NO		
G60052	S1	BP7	1-3/8"		20.47	12.69	7.78	YES	YES		
G61204	S1	BP7	1-3/8"		20.47	12.69	7.78				
G60354	S1	BP7	1-3/8"		14.20	9.09	5.11	NO	NO		
G60076	S1	BP7	1-3/8"		13.95	9.28	4.67	NO	NO		
G60313	S1	BP7	1-3/8"		13.20	8.59	4.61	NO	NO		
83003	S1	BP7	1-3/8"	A	11.76	8.95†	3.40	YES	YES	248	100
G60304	S1	BP8	1-3/8"		14.70	9.34	5.36	YES	NO		
G61860	S1	EB1	1-3/8"		24.33	14.39	9.94				
G60137	S1	EB1	1-3/8"		22.95	13.67	9.28	YES	NO		
G60107	S1	EB1	1-3/8"		22.45	13.42	9.03	YES	NO		
G60164	S1	EB1	1-3/8"		21.55	13.27	8.28	YES	NO		
83161★	S1	EB1	1-3/8"	A	20.82	12.56	8.25	YES	NO	400	70
G61139	S1	EB1	1-3/8"		15.97	10.19	5.78	YES	NO		
G61862	S1	EB2	1-3/8"		25.07	14.94	10.13				
G60091	S1	EB2	1-3/8"		21.21	12.93	8.28	YES	NO		
G61121	S1	ES113	1-3/8"		18.45	11.93	6.52	YES	YES		

★ Will be available in first quarter of 2011.

* Damping force, in pounds, to either extend or collapse the shock absorber at an average operating velocity.

Fuerza de amortiguación en libras para extender o comprimir el amortiguador a una velocidad de operación promedio.

La puissance d'amortissement en poids de l'amortisseur, soit comprimé, soit détendu, à une vitesse de fonctionnement moyenne.

‡ For GasSLX Series, forces are at the "Firm" (F) setting. / Para la serie Gas SLX, las fuerzas estan ajustada en (F) "Firme". / Pour la série GasSLX, le réglage de la force est sur « Ferme » (F).

† At bumper contact / Al contacto cone el tope de goma. / Au contact avec le butoir.

SPECIFICATIONS BY END MOUNT

ESPECIFICACIONES POR FIJACIÓN DE EXTREMIDADES

SPÉCIFICATIONS PAR FIXATION DES EXTRÉMITÉS

Gabriel	Mounting		Bore	External Diameter Illustration	Extended	Lengths		Stroke	Dust Tube	Recoil Cutoff	Controls *	
	Upper	Lower				Collapsed	Rebound				Compression	
G60086	S1	ES113	1-3/8"		14.05	9.27	4.78	YES	NO			
G60153	S1	ES113	1-3/8"		13.71	9.18	4.53	YES	NO			
G61122	S1	ES118	1-3/8"		13.80	9.27	4.53	YES	NO			
G60253	S1	ES153	1-3/8"		18.96	11.93	7.03	YES	NO			
G60070	S1	ES17	1-3/8"		23.30	14.02	9.28	NO	YES			
G60105	S1	ES17	1-3/8"		17.05	11.02	6.03	YES	YES			
G60104	S1	ES17	1-3/8"		15.05	9.77	5.28	YES	NO			
G60165	S1	ES17	1-3/8"		15.05	9.77	5.28	YES	NO			
G60136	S1	ES17	1-3/8"		14.95	9.67	5.28	YES	NO			
G60305	S1	ES17	1-3/8"		14.95	9.59	5.36	YES	NO			
G60109	S1	ES17	1-3/8"		14.45	9.42	5.03	YES	NO			
G60310	S1	ES17	1-3/8"		14.11	9	5.11	YES	NO			
G60303	S1	ES17	1-3/8"		12.60	8.59	4.01	YES	YES			
G60306	S1	ES24	1-3/8"		14.70	9.34	5.36	NO	NO			
G60024	S1	ES25	1-3/8"		23.33	14.05	9.28	YES	NO			
G60129	S1	ES25	1-3/8"		22.55	13.52	9.03	YES	NO			
G60030	S1	ES25	1-3/8"		22.33	13.80	8.53	YES	YES			
G60011	S1	ES25	1-3/8"		18.83	11.80	7.03	YES	NO			
G61881	S1	ES25	1-3/8"		14.71	9.48	5.22					
G60217	S1	ES34	1-3/8"		23.27	14.24	9.03	YES	YES			
G60216	S1	ES34	1-3/8"		22.30	13.77	8.53	YES	YES			
G60205	S1	ES34	1-3/8"		13.87	9.59	4.28	YES	YES			
G60194	S1	ES69	1-3/8"		14.55	9.52	5.03	YES	NO			
G60002	S1	S1	1-3/8"		23.02	13.49	9.53	YES	NO			
83400	S1	S1	1-3/16"	F	22.02	12.82	9.20	YES	NO	301	120	
G60046	S1	S1	1-3/8"		20.52	12.24	8.28	YES	NO			
83014	S1	S1	1-3/8"	A	10.48	7.11	3.37	NO	NO	544	501	
G61140	S1	S12	1-3/8"		18.55	11.77	6.78	YES	NO			
G60264	S10	BP11	1-3/8"		20.21	12.43	7.78	YES	NO			
G60181	S10	BP7	1-3/8"		16.46	10.93	5.53	YES	YES			
G60072	S10	EB6	1-3/8"		23.30	14.02	9.28	NO	YES			
G60033	S10	EB6	1-3/8"		18.55	11.77	6.78	YES	YES			
G60250	S10	ES17	1-3/8"		15.80	10.27	5.53	YES	NO			
G60073	S10	ES25	1-3/8"		30.18	17.65	12.53	NO	YES			
G60071	S10	ES25	1-3/8"		23.24	13.99	9.25	NO	YES			
G60041	S10	ES25	1-3/8"		18.55	11.77	6.78	YES	YES			
G60026	S10	ES25	1-3/8"		16.55	10.77	5.78	YES	YES			
G61124	S12	BP11	1-3/8"		14.80	10.27	4.53	YES	NO			
G60154	S12	EB2	1-3/8"		21.21	13.18	8.03	YES	YES			
G60269	S12	EB2	1-3/8"		20.96	12.93	8.03	YES	NO			
G60258	S12	ES25	1-3/8"		28.55	16.52	12.03	YES	NO			
G61118	S12	ES25	1-3/8"		24.55	14.52	10.03	YES	NO			
G60259	S12	ES26	1-3/8"		15.54	10.01	5.53	YES	NO			
G61158	S12	ES60	1-3/8"		15.80	11.02	4.78	YES	NO			
G61144	S12	U-Brkt	1-3/8"		15.48	10.69	4.79	YES	NO			
83317	S16	ES90	1-3/8"	B	27.33	15.99	11.34	YES	NO			
83301	S16	ES90	1-3/8"	B	24.52	14.74	9.78	YES	YES	653	86	
83318	S16	S16	1-3/8"	B	22.53	13.50	9.03	YES	NO	323	77	
83613	S16	S16	1-3/8"	A	21.04	12.76	8.28	YES				
G60122	S17	ES114	1-3/8"		21.95	13.42	8.53	YES	YES			
85731	S21	EB3	1-5/8"	D	30.57	18.54	12.03	YES	YES	1517	293	
85703	S21	EB3	1-5/8"	D	29.57	18.54	11.03	YES	YES	1435	186	

★ Will be available in first quarter of 2011.

* Damping force, in pounds, to either extend or collapse the shock absorber at an average operating velocity.

Fuerza de amortiguación en libras para extender o comprimir el amortiguador a una velocidad de operación promedio.

La puissance d'amortissement en poids de l'amortisseur, soit comprimé, doit détendu, à une vitesse de fonctionnement moyenne.

SPECIFICATIONS BY END MOUNT

ESPECIFICACIONES POR FIJACIÓN DE EXTREMIDADES

SPÉCIFICATIONS PAR FIXATION DES EXTRÉMITÉS

Gabriel	Mounting		Bore	External Diameter Illustration	Extended	Lengths Collapsed	Stroke	Dust Tube	Recoil Cutoff	Controls *	
	Upper	Lower								Rebound	Compression
85033	S21	EB3	1-5/8"	C	27.21	17.37	9.84	YES	YES	764	254
89427	S21	EB3	1-5/8"	G	27.20	17.50	9.70	YES	YES	794‡	253‡
85317	S21	EB3	1-5/8"	D	27.18	17.42	9.76	YES	YES	764	254
85711	S21	EB3	1-5/8"	D	24.57	15.29	9.28	YES	YES	1435	208
87000	S21	EB3	2-1/16"	E	24.46	15.21	9.25	YES	YES	1332	300
85311	S21	EB3	1-5/8"	D	23.95	14.79	9.16	YES	YES	764	254
89424	S21	EB3	1-5/8"	G	23.70	15	8.70	YES	YES	794‡	253‡
85710	S21	EB3	1-5/8"	D	23.45	15.10	8.34	YES	YES	994	248
87016★	S21	EB3	2-1/16"	E	21.17	13.91	7.26	YES	YES	1808	238
85319	S21	ES150	1-5/8"	D	22.20	13.92	8.28	YES	YES	988	454
89428	S21	ES150	1-5/8"	G	21.96	14.13	7.83	YES	YES	958‡	446‡
G61173	S21	ES153	1-3/8"		17.16	11.38	5.78				
85009	S21	ES36	1-5/8"	C	23.52	14.36	9.16	YES	YES	857	144
G61169	S21	ES36	1-3/8"		23.16	15.13	8.03				
83134	S21	ES36	1-3/8"	A	22.24	13.50	8.74	YES	NO	430	49
85921	S21	ES36	1-5/8"	G	22.03	13.50	8.53	YES	NO	2053	339
85316	S21	ES36	1-5/8"	D	20.61	12.85	7.76	YES	NO	943	443
89426	S21	ES36	1-5/8"	G	20.43	12.93	7.50	YES	NO	926‡	419‡
85056	S21	ES36	1-5/8"	C	20.15	12.87	7.28	YES	YES	732	114
89441	S21	ES36	1-5/8"	G	20.14	13.06	7.08	YES	YES	761‡	126‡
85935	S21	ES36	1-5/8"	G	18.70	11.92	6.78	YES	NO	1054	419
85709	S21	S21	1-5/8"	D	31.64	18.36	13.28	YES	YES	700	203
85727	S21	S21	1-5/8"	D	29.89	17.36	12.53	YES	YES	783	111
83106	S21	S21	1-3/8"	A	29.25	16.76	12.49	YES	NO	451	80
83136	S21	S21	1-3/8"	A	29.25	16.76	12.49	YES	NO	914	65
85048	S21	S21	1-5/8"	C	29.16	16.88	12.28	YES	NO	432	106
85318	S21	S21	1-5/8"	D	27.37	16.36	11.01	YES	YES	1372	192
85722	S21	S21	1-5/8"	D	27.15	16.43	10.72	YES	YES	1264	369
85069	S21	S21	1-5/8"	C	26.28	15.94	10.34	YES	YES	762	255
89455	S21	S21	1-5/8"	G	26.28	15.92	10.36	YES	YES	791‡	276‡
85328	S21	S21	1-5/8"	D	25.64	15.36	10.28	YES	NO	930	383
85071	S21	S21	1-5/8"	C	25.57	15.04	10.53	YES	NO	610	107
85049	S21	S21	1-5/8"	C	25.53	15	10.53	YES	NO	597	107
85085★	S21	S21	1-5/8"	C	24.95	14.67	10.23	YES	NO	970	101
85728	S21	S21	1-5/8"	D	24.39	14.86	9.53	YES	YES	1435	510
83456	S21	S21	1-3/8"	B	24.03	14.25	9.78	YES	NO	566	80
89447	S21	S21	1-5/8"	G	23.65	14.57	9.08	YES	YES	702‡	241‡
85707	S21	S21	2-1/16"	D	23.65	14.40	9.25	YES	YES	1761	986
87011	S21	S21	2-1/16"	E	23.65	14.40	9.25	YES	YES	1750	1050
87012	S21	S21	2-1/16"	E	23.65	14.40	9.25	YES	YES	650	364
87013	S21	S21	2-1/16"	E	23.65	14.40	9.25	YES	YES	1075	585
85705	S21	S21	1-5/8"	D	23.65	14.24	9.41	YES	YES	639	436
85706	S21	S21	1-5/8"	D	23.65	14.24	9.41	YES	YES	1086	696
85325	S21	S21	1-5/8"	D	23.64	14.36	9.28	YES	NO	1024	240
83102	S21	S21	1-3/8"	A	22.94	13.56	9.38	YES	YES	513	333
85324	S21	S21	1-5/8"	D	22.14	13.61	8.53	YES	NO	579	114
85027	S21	S21	1-5/8"	C	21.52	12.99	8.53	YES	NO	1008	539
89418	S21	S21	1-5/8"	G	21.44	13.19	8.25	YES	NO	1266‡	515‡
85708	S21	S21	1-5/8"	D	20.64	12.86	7.78	YES	YES	914	204
85326	S21	S21	1-5/8"	D	19.64	12.36	7.28	YES	NO	799	142
83103	S21	S21	1-3/8"	A	19.64	11.89	7.75	YES	YES	517	301
85902	S21	S21	1-5/8"	G	19.01	12.03	6.98	YES	YES	1441	267

★ Will be available in first quarter of 2011.

* Damping force, in pounds, to either extend or collapse the shock absorber at an average operating velocity.

Fuerza de amortiguación en libras para extender o comprimir el amortiguador a una velocidad de operación promedio.

La puissance d'amortissement en poids de l'amortisseur, soit comprimé, soit détendu, à une vitesse de fonctionnement moyenne.

‡ For GasSLX Series, forces are at the "Firm" (F) setting. / Para la serie Gas SLX, las fuerzas estan ajustada en (F) "Firme". / Pour la série GasSLX, le réglage de la force est sur « Ferme » (F).

SPECIFICATIONS BY END MOUNT

ESPECIFICACIONES POR FIJACIÓN DE EXTREMIDADES

SPÉCIFICATIONS PAR FIXATION DES EXTRÉMITÉS

Gabriel	Mounting		Bore	External Diameter Illustration	Extended	Lengths		Stroke	Dust Tube	Recoil Cutoff	Controls *	
	Upper	Lower				Collapsed	Rebound				Compression	
85336	S21	S21	1-5/8"	D	18.76	11.86	6.90	YES	NO	861	200	
89423	S21	S21	1-5/8"	G	18.65	12.07	6.58	YES	YES	1352‡	573‡	
85900	S21	S21	1-5/8"	G	17.27	11.16	6.11	YES	YES	1467	337	
85701	S21	S21	1-5/8"	D	15.64	10.36	5.28	YES	YES	914	204	
G60114	S28	ES25	1-3/8"		15.09	10.06	5.03	NO	YES			
G60038	S28	ES83	1-3/8"		15.09	10.06	5.03	NO	YES			
G61895	S29	413042	1-3/8"		14.12	9.68	4.44					
G61894	S29	413042	1-3/8"		12.82	8.88	3.94					
G60098	S29	BP11	1-3/8"		14.44	9.66	4.78	NO	YES			
G61958	S29	BP13	1-3/8"		13.80	9.13	4.67					
G60312	S29	ES84	1-3/8"		21.12	16.31	4.81	YES	YES			
G61893	S29	U-Brkt	1-3/8"		15.07	10.44	4.64					
G62001	S29	U-Brkt	1-3/8"		14.67	11.47	3.19					
G60089	S32	S32	1-3/8"		21.42	12.64	8.78	YES	NO			
G60124	S32	S32	1-3/8"		21.41	12.88	8.53	YES	NO			
G60221	S36	BP7	1-3/8"		18.09	13.56	4.53	YES	NO			
G60182	S36	EB1	1-3/8"		15.42	10.39	5.03	YES	YES			
G61148	S36	EB1	1-3/8"		15.32	10.29	5.03	YES	NO			
G60171	S36	EB1	1-3/8"		15.12	10.09	5.03	NO	YES			
G60330	S36	EB1	1-3/8"		14.72	9.71	5.01	YES	YES			
G60162	S36	EB1	1-3/8"		14.58	9.81	4.78	YES	YES			
G60023	S36	ES25	1-3/8"		17.19	11.16	6.03	NO	YES			
G60183	S36	ES83	1-3/8"		22.67	14.39	8.28	YES	YES			
G60184	S36	ES83	1-3/8"		20.17	12.64	7.53	YES	YES			
G60158	S36	ES83	1-3/8"		16.11	10.58	5.53	YES	YES			
G60177	S38	EB2	1-3/8"		23.78	14.25	9.53	YES	NO			
G61886	S38	ES34	1-3/8"		20.80	13.36	7.44					
G61182	S38	ES34	1-3/8"		15.87	10.59	5.28					
G60176	S38	S38	1-3/8"		23.66	13.88	9.78	YES	NO			
G60238	S38	S38	1-3/8"		23.06	13.53	9.53	YES	NO			
G61155	S39	EB1	1-3/8"		21.45	13.17	8.28	YES	YES			
G61884	S39	ES112	1-3/8"		14.72	9.78	4.94					
G61156	S39	ES17	1-3/8"		22.05	13.27	8.78	YES	NO			
G61154	S39	ES17	1-3/8"		12.30	8.50	3.80	YES	NO			
G61865	S39	ES36	1-3/8"		22.49	13.55	8.94					
G60249	S39	ES83	1-3/8"		18.05	11.27	6.78	YES	NO			
G60087	S4	EB1	1-3/8"		20.05	12.52	7.53	YES	NO			
G60106	S4	ES17	1-3/8"		22.45	13.42	9.03	YES	NO			
83162★	S40	EB3	1-3/8"	A	24.35	14.69	9.67	YES	NO	877	52	
83105	S40	ES179	1-3/8"	A	31.91	18.29	13.62	YES	NO	559	150	
83114	S40	ES35	1-3/8"	A	23	13.76	9.24	YES	NO	450	102	
85332	S42	ES36	1-5/8"	D	20.64	12.98	7.66	YES	YES	2351	967	
85333	S42	ES36	1-5/8"	D	20.64	12.98	7.66	YES	YES	1241	534	
85310	S42	S42	1-5/8"	D	18.65	11.74	6.91	YES	YES	1379	578	
G61114	S6	BP35	1-3/8"		17.95	13.42	4.53	YES	YES			
G61112	S6	BP35	1-3/8"		13.83	9.55	4.28	YES	YES			
G60257	S6	BP7	1-3/8"		15.54	10.01	5.53	YES	NO			
G60263	S6	ES22	1-3/8"		21.30	13.02	8.28	YES	NO			
G60169	S7	ES17	1-3/8"		14.55	9.77	4.78					

★ Will be available in first quarter of 2011.

* Damping force, in pounds, to either extend or collapse the shock absorber at an average operating velocity.
Fuerza de amortiguación en libras para extender o comprimir el amortiguador a una velocidad de operación promedio.

La puissance d'amortissement en poids de l'amortisseur, soit comprimé, soit détendu, à une vitesse de fonctionnement moyenne.

‡ For GasSLX Series, forces are at the "Firm" (F) setting. / Para la serie Gas SLX, las fuerzas estan ajustada en (F) "Firme". / Pour la série GasSLX, le réglage de la force est sur « Ferme » (F).

SPECIFICATIONS BY PART NUMBER

ESPECIFICACIONES POR NÚMERO DE PIEZA

SPÉCIFICATIONS PAR NUMÉRO DE PIÈCE

Gabriel	Mounting		Bore	External Diameter Illustration	Extended	Lengths Collapsed	Stroke	Dust Tube	Recoil Cutoff	Controls *	
	Upper	Lower								Rebound	Compression
630811			1-3/16"		22.45	14.10	8.35	NO	NO		
632147			1-3/16"		22.45	14.10	8.35	NO	NO		
632155	ES36	ES36	1-3/16"		22.45	14.10	8.35	NO	NO		
646155	ES36	ES36	1-3/16"		22.45	14.10	8.35	NO	NO		
646177	ES36	ES36	1-3/16"		22.45	14.10	8.35	NO	NO		
665472	ES36	ES36	1-5/8"	G	25.14	15.61	9.53	NO	NO	925	977
665937	ES36	ES36	1-5/8"	G	22.91	16.09	6.82	YES	NO		
83001	ES149	EB1	1-3/8"	A	10.41†	8.36†	3	YES	YES	793	363
83002	ES10	ES10	1-3/8"	A	11.61	8.62	3	YES	YES	3112	590
83003	S1	BP7	1-3/8"	A	11.76	8.95†	3.40	YES	YES	248	100
83004	ES35	ES136	1"	2" D/T	9.36†	7.29	2.32	YES	YES	539	324
83005	BP8	S10	1-3/16"	2" D/T	7.34	5.87	1.47	YES	NO	858	216
83006	ES149	EB1	1-3/8"	A	10.66	8.48†	2.77	YES	YES	525	182
83007	EB1	EB1	1-3/8"	A	18.54	11.67	6.87	NO	NO	489	343
83008	ES136	ES136	1-3/8"	A	12.98†	10.15†	3.99	YES	YES	699	307
83009	ES149	ES149	1-3/8"	A	10.41†	8.36†	2.99	YES	YES	793	363
83010	ES24	ES24	1"	2" D/T	14.15†	9.33	5.07	YES	YES	188	70
83011	EB1	EB1	1-3/8"	A	11.55†	8.43	3.62	YES	YES	738	330
83012	EB1	EB1	1-3/8"	A	11.05†	8.18	3.37	YES	YES	738	330
83013	BP8	BP8	1-3/16"	2" D/T	7.66	6.63†	1.70	YES	NO	646	480
83014	S1	S1	1-3/8"	A	10.48	7.11	3.37	NO	NO	544	501
83015	BP8	S1	1-3/8"	A	9.79	7.55	2.24	YES	YES	735	430
83016	ES10	ES10	1"	1-5/8"	11.51	8.14	3.37	NO	YES	506	139
83017	ES149	ES149	1-3/8"	A	10.93	8.35†	3.13	YES	YES	353	138
83018	ES24	S1	1-3/8"	A	10.30†	8.42†	3.24	YES	YES	515	174
83019	ES24	S1	1-3/8"	A	9.42	8.16†	2.28	YES	YES	509	121
83020	ES91	ES91	1-3/8"	A	9.41	7.17	2.24	YES	YES	796	255
83021	ES10	ES10	1-3/8"	A	9.36	7.37	1.99	YES	YES	745	315
83022	ES24	ES24	1"	2" D/T	14.28	9.33	4.95	YES	NO	840	152
83023	ES10		1"	1-5/8"	8.70	7.09†	2.14	NO	YES	484	157
83024	ES10	ES10	1-3/8"	2-1/2" D/T	11.61	8.62	2.99	YES	YES	811	320
83025	ES158	ES158	1-3/8"	A	7.98	6.49	1.49	YES	YES	710	230
83026	ES24	ES24	1-3/8"	A	13.11	9.12	3.99	YES	YES	602	104
83027	ES24	S10	1-3/8"	A	13.80	9.18	4.62	YES	YES	602	104
83028	ES86	ES167	1-3/8"	A	9.94	7.57	2.37	YES	YES	445	531
83029	ES168	ES169	1-5/8"	C	10.35	7.94	2.41	YES	NO	1303	1349
83030	ES136	ES136	1-3/8"	A	9.60†	7.61	2.49	YES	YES	308	87
83031	ES10	ES10	1-3/8"	2-1/2" D/T	11.49	8.62	2.87	YES	YES	811	314
83032	ES163	ES163	1-3/8"	A	7.85	6.36	1.49	NO	YES	779	135
83033	ES53	ES53	1-3/8"	A	13.99	10.37	3.62	YES	YES	494	312
83034	ES115	ES115	1-3/16"	1-5/8"	10.04†	7.32	2.97	NO	YES	430	129
83035	ES166	ES136	1-3/8"	A	12.96†	9.33	4.13	YES	YES	320	100
83038	ES149	EB1	1-3/8"	A	10.41†	8.36†	2.99	YES	YES	336	242
83039	ES149	ES149	1-3/8"	A	10.41†	8.36†	2.99	YES	YES	876	326
83040	ES171	ES172	1-3/8"	A	10.41†	8.36†	2.99	YES	YES	876	326
83041	BP27	S10	1-3/8"	A	10.51†	8.34†	3.02	YES	YES	486	189
83042	ES136	ES136	1-3/8"	A	9.88†	8.44†	2.38	YES	YES	954	541
83044	ES27	ES164	1-3/8"	A	10.91	7.93	2.98	YES	YES	789	296
83045	ES19	S1	1-3/8"	A	11.53†	8.58†	3.81	YES	NO	510	153
83046	ES10	ES181	1-3/16"		9.23†	7.62†	2.73	NO	YES	514	173
83047	ES149	EB1	1-3/8"	A	11.78†	9.74†	3	YES	YES	364	314
83048	ES86	ES167	1-3/8"	A	9.97	8.43†	2.37	YES	YES	904	415

★ Will be available in first quarter of 2011.

* Damping force, in pounds, to either extend or collapse the shock absorber at an average operating velocity. Fuerza de amortiguación en libras para extender o comprimir el amortiguador a una velocidad de operación promedio. La puissance d'amortissement en poids de l'amortisseur, soit comprimé, doit détendu, à une vitesse de fonctionnement moyenne.

† At bumper contact / Al contacto cone el tope de goma. / Au contact avec le butoir.

SPECIFICATIONS BY PART NUMBER

ESPECIFICACIONES POR NÚMERO DE PIEZA

SPÉCIFICATIONS PAR NUMÉRO DE PIÈCE

Gabriel	Mounting		Bore	External Diameter Illustration	Extended	Lengths		Stroke	Dust Tube	Recoil Cutoff	Controls *	
	Upper	Lower				Collapsed	Rebound				Compression	
83049	ES163	ES163	1-3/8"	A	8.02	6.53	1.48	YES	YES	2879	705	
83050	ES19	S1	1-3/8"	A	10.43†	8.38†	2.90	YES	YES	599	321	
83051	ES10	ES10	1-3/8"	2-1/2" D/T	9.41	7.40	2.01	YES	YES	579	163	
83052	ES185	ES185	1-3/8"	2-1/2" D/T	9.41	7.19	2.23	YES	NO	1101	149	
83053	ES185	ES185	1-3/8"	A	10.91	7.93	2.97	YES	YES	968	214	
83054	ES185	ES185	1-3/8"	A	10.28	7.56	2.72	YES	YES	1004	184	
83100	ES90	ES90	1-3/8"	A	26.60	16.11	10.49	YES	YES	481	142	
83101	ES90	ES90	1-3/8"	A	24.60	15.11	9.49	YES	YES	481	142	
83102	S21	S21	1-3/8"	A	22.94	13.56	9.38	YES	YES	513	333	
83103	S21	S21	1-3/8"	A	19.64	11.89	7.75	YES	YES	517	301	
83104	EB3	EB3	1-3/8"	A	28.24	17.12	11.12	YES	NO	698	133	
83105	S40	ES179	1-3/8"	A	31.91	18.29	13.62	YES	NO	559	150	
83106	S21	S21	1-3/8"	A	29.25	16.76	12.49	YES	NO	451	80	
83107	EB2	EB2	1-3/8"	A	31.60	18.36	13.24	YES	NO	352	77	
83109	ES36	S42	1-3/8"	A	26.14	15.90	10.24	YES	YES	345	78	
83110	ES36	S42	1-3/8"	A	22.89	14.27	8.62	YES	YES	450	143	
83111	ES36	S42	1-3/8"	A	26.14	15.90	10.24	YES	YES	560	141	
83112	ES36	S42	1-3/8"	A	21.52	13.40	8.12	YES	YES	1064	343	
83113	ES36	EB3	1-3/8"	A	20.42	13.43	6.99	YES	YES	997	238	
83114	S40	ES35	1-3/8"	A	23	13.76	9.24	YES	NO	450	102	
83115	ES36	EB3	1-3/8"	A	16.19	13.32	4.87	YES	YES	997	238	
83116	ES164	ES165	1-3/8"	A	23.81	14.68	9.12	YES	NO	354	300	
83117	EB4	EB1	1-3/8"	A	23.94	14.45	9.49	YES	NO	354	300	
83118	ES164	ES90	1-3/8"	A	24.45	14.71	9.74	YES	NO	410	311	
83119	EB4	ES165	1-3/8"	A	23.96	14.84	9.12	YES	NO	354	300	
83120	ES120	S21	1-3/8"	A	22.12	13.63	8.49	YES	YES	779	164	
83121	ES36	ES36	1-3/8"	A	30.25	18.32	11.93	YES	YES	689	126	
83122	ES36	ES36	1-3/8"	A	25.24	15.75	9.49	YES	YES	661	201	
83123	ES36	ES36	1-3/8"	A	26.62	16.38	10.24	YES	YES	589	119	
83124	ES36	ES36	1-3/8"	A	21.65	13.75	7.87	YES	YES	750	137	
83125	ES36	ES36	1-3/8"	A	28.12	17.13	10.99	YES	YES	625	115	
83126	ES36	ES36	1-3/8"	A	24.37	15.25	9.12	YES	YES	625	115	
83127	ES36	ES36	1-3/8"	A	20.12	13.13	6.99	YES	YES	940	218	
83128	ES36	ES36	1-3/8"	A	16.87	11.51	5.37	YES	YES	940	218	
83130	ES36	ES36	1-3/8"	A	17.99	12.01	5.99	YES	YES	871	177	
83131	ES83	ES83	1-3/8"	A	27.80	18.18	9.62	YES	NO	212	129	
83132	EB3	EB3	1-3/8"	A	25.24	15.50	9.74	YES	NO	828	150	
83134	S21	ES36	1-3/8"	A	22.24	13.50	8.74	YES	NO	430	49	
83135	ES90	ES90	1-3/8"	A	19.48	12.36	7.12	YES	YES	519	121	
83136	S21	S21	1-3/8"	A	29.25	16.76	12.49	YES	NO	914	65	
83137	ES36	ES36	1-3/8"	A	30.03	17.78	12.25	YES	YES	517	132	
83138	ES36	S42	1-3/8"	A	23.55	14.42	9.12	YES	YES	997	231	
83140	EB3	EB3	1-3/8"	A	25.27	15.52	9.75	YES	NO	738	88	
83141	EB3	EB3	1-3/8"	A	25.27	15.52	9.75	YES	NO	408	113	
83142	ES162	S42	1-3/8"	A	23.92	14.50	9.43	YES	YES	367	131	
83143	ES162	S42	1-3/8"	A	21.92	13.50	8.43	YES	YES	403	137	
83144	ES36	ES36	1-3/8"	A	23.78	15.03	8.75	YES	YES	596	93	
83145	ES83	ES83	1-3/8"	A	19.93	12.32	7.54	YES	NO	479	153	
83146	ES90	ES83	1-3/8"	A	24.02	14.68	9.33	YES	YES	479	119	
83147	ES179	ES179	1-3/8"	A	28.53	17.34	11.15	YES	YES	358	128	
83148	ES179	ES179	1-3/8"	A	30	17.83	12.17	YES	YES	604	149	
83149	ES36	ES36	1-3/8"	A	25.28	15.78	9.49	YES	YES	332	101	

★ Will be available in first quarter of 2011.

* Damping force, in pounds, to either extend or collapse the shock absorber at an average operating velocity. Fuerza de amortiguación en libras para extender o comprimir el amortiguador a una velocidad de operación promedio. La puissance d'amortissement en poids de l'amortisseur, soit comprimé, doit détendu, à une vitesse de fonctionnement moyenne.

† At bumper contact / Al contacto con el tope de goma. / Au contact avec le butoir.

SPECIFICATIONS BY PART NUMBER

ESPECIFICACIONES POR NÚMERO DE PIEZA

SPÉCIFICATIONS PAR NUMÉRO DE PIÈCE

Gabriel	Mounting		Bore	External Diameter Illustration	Extended	Lengths Collapsed	Stroke	Dust Tube	Recoil Cutoff	Controls *	
	Upper	Lower								Rebound	Compression
83150	ES36	ES36	1-3/8"	A	15.24	10.43	4.81	YES	YES	940	216
83153	ES34	ES34	1-3/8"	A	21.69	13.62	8.07	YES	YES	974	206
83154	ES120	S21	1-3/8"	A	20.78	12.72	8.06	YES	YES	599	140
83155	ES34	ES34	1-3/8"	A	21.69	13.62	8.07	YES	YES	507	80
83156	ES90	ES90	1-3/8"	A	18.55	11.91	6.64	YES	NO	778	135
83157★	ES36	ES90	1-3/8"	A	26.38	15.76	10.61	YES	NO	446	303
83158★	ES22	ES22	1-3/8"	A	12.96	8.97	4	YES	NO	783	484
83159★	EB2	EB2	1-3/8"	A	21.62	13.40	8.14	YES	NO	658	149
83160★	ES82	ES36	1-3/8"	A	24.31	14.90	9.37	YES	YES	920	161
83161★	S1	EB1	1-3/8"	A	20.82	12.56	8.25	YES	NO	400	70
83162★	S40	EB3	1-3/8"	A	24.35	14.69	9.67	YES	NO	877	52
83200	EB2	EB2	1-3/8"	A	24.51	14.98	9.53	YES	NO	806	370
83203	ES36	ES36	1-3/8"	A	17.10	11.36	5.74	YES	YES	609	114
83204	ES36	ES36	1-3/8"	A	20.14	12.86	7.28	YES	YES	451	110
83205	ES36	ES36	1-3/8"	A	29.69	17.69	12	YES	YES	660	76
83207	ES36	ES36	1-3/8"	A	21.64	13.61	8.03	YES	YES	553	143
83209	ES36	ES36	1-3/8"	A	29.64	17.61	12.03	YES	YES	670	78
83214	EB3	EB3	1-3/8"	A	19.64	12.86	6.78	YES	NO	269	90
83215	EB3	EB3	1-3/8"	A	26.64	16.36	10.28	YES	NO	661	125
83216	EB2	EB2	1-3/8"	A	23.51	14.48	9.03	YES	NO	776	262
83217	EB3	EB3	1-3/8"	A	22.77	14.49	8.28	YES	YES	539	202
83218	ES36	ES36	1-3/8"	A	25.19	15.44	9.75	YES	YES	721	194
83219	EB2	EB2	1-3/8"	A	20.01	12.73	7.28	YES	NO	299	125
83221	ES36	ES36	1-3/8"	A	24.01	14.73	9.28	YES	NO	599	153
83225	EB3	EB3	1-3/8"	A	24.14	15.11	9.03	YES	YES	482	159
83242	ES36	ES36	1-3/8"	A	33.73	20.98	12.75	YES	YES	721	135
83301	S16	ES90	1-3/8"	B	24.52	14.74	9.78	YES	YES	653	86
83303	EB7	ES36	1-3/8"	B	24.86	15.08	9.78	YES	NO	470	122
83304	EB7	ES36	1-3/8"	B	22.86	14.08	8.78	YES	NO	470	122
83308	EB2	EB2	1-3/8"	B	25.14	15.36	9.78	YES	YES	445	180
83309	EB2	EB2	1-3/8"	B	28.64	17.11	11.53	YES	YES	589	135
83310	ES36	ES36	1-3/8"	B	24.06	14.69	9.37	YES	NO	559	153
83312	EB2	EB2	1-3/8"	B	26.64	16.11	10.53	YES	YES	527	152
83314	EB2	EB2	1-3/8"	B	30.64	18.11	12.53	YES	YES	633	143
83317	S16	ES90	1-3/8"	B	27.33	15.99	11.34	YES	NO		
83318	S16	S16	1-3/8"	B	22.53	13.50	9.03	YES	NO	323	77
83353	EB3	S21	1-3/8"	B	24.84	15.06	9.78	YES	NO	432	214
83362	EB3	EB3	1-3/8"	B	27	16.25	10.75	YES	NO	539	202
83400	S1	S1	1-3/16"	F	22.02	12.82	9.20	YES	NO	301	120
83401	EB1	EB1	1-3/16"	F	24.09	14.26	9.83	YES	NO	341	252
83456	S21	S21	1-3/8"	B	24.03	14.25	9.78	YES	NO	566	80
83613	S16	S16	1-3/8"	A	21.04	12.76	8.28	YES	YES		
83634	ES120	ES120	1-3/8"	A	27.48	16.23	11.25	YES	YES	779	157
83635	ES36	S21	1-3/8"	A	21.74	13.25	8.49	YES	NO	558	119
83636	ES90	ES90	1-3/8"	A	27.72	16.95	10.77	YES	YES	505	148
85000	ES36	ES36	1-5/8"	C	17.22	11.46	5.76	YES	YES	1019	219
85001	EB3	EB3	1-5/8"	C	26.27	16.36	9.91	YES	NO	1202	186
85003	ES90	ES90	1-5/8"	C	25.37	15.59	9.78	YES	YES	437	182
85004	EB3	EB3	1-5/8"	C	20.68	13.67	7.01	YES	YES	1019	219
85005	ES36	ES36	1-5/8"	C	24.74	15.21	9.53	YES	YES	1019	219
85006	ES36	ES36	1-5/8"	C	28.50	17.09	11.41	YES	YES	1019	219
85007	EB3	EB3	1-5/8"	C	24.21	15.30	8.91	YES	YES	1008	171

★ Will be available in first quarter of 2011.

* Damping force, in pounds, to either extend or collapse the shock absorber at an average operating velocity. Fuerza de amortiguación en libras para extender o comprimir el amortiguador a una velocidad de operación promedio. La puissance d'amortissement en poids de l'amortisseur, soit comprimé, doit détendu, à une vitesse de fonctionnement moyenne.

SPECIFICATIONS BY PART NUMBER

ESPECIFICACIONES POR NÚMERO DE PIEZA

SPÉCIFICATIONS PAR NUMÉRO DE PIÈCE

Gabriel	Mounting		Bore	External Diameter Illustration	Extended	Lengths		Stroke	Dust Tube	Recoil Cutoff	Controls *	
	Upper	Lower				Collapsed	Rebound				Compression	
85009	S21	ES36	1-5/8"	C	23.52	14.36	9.16	YES	YES	857	144	
85010	ES36	ES36	1-5/8"	C	26.74	16.21	10.53	YES	YES	1019	219	
85011	ES120	ES121	1-5/8"	C	27.49	16.46	11.03	YES	NO	1268	186	
85012	EB2	EB2	1-5/8"	C	21	13.22	7.78	YES	NO	523	199	
85013	ES36	ES36	1-5/8"	C	29.74	17.71	12.03	YES	YES	1019	219	
85014	ES36	ES36	1-5/8"	C	21.74	13.71	8.03	YES	YES	1019	219	
85023	EB2	EB2	1-5/8"	C	20.24	12.96	7.28	YES	YES	1008	539	
85024	EB2	EB2	1-5/8"	C	28.74	17.21	11.53	YES	YES	1008	539	
85025	EB2	S21	1-5/8"	C	23	13.97	9.03	YES	NO	1079	539	
85026	ES136	S21	1-5/8"	C	23	13.97	9.03	YES	NO	1079	539	
85027	S21	S21	1-5/8"	C	21.52	12.99	8.53	YES	NO	1008	539	
85029	ES36	ES36	1-5/8"	C	20.50	13.09	7.41	YES	YES	1019	219	
85030	ES36	ES36	1-5/8"	C	24	14.84	9.16	YES	YES	1019	219	
85031	ES176	EB2	1-5/8"	C	25.63	15.85	9.78	YES	NO	941	257	
85033	S21	EB3	1-5/8"	C	27.21	17.37	9.84	YES	YES	764	254	
85036	ES36	ES36	1-5/8"	C	26.38	16.29	10.09	YES	YES	633	119	
85040	EB3	EB3	1-5/8"	C	30.90	18.49	12.41	YES	NO	889	114	
85042	EB3	EB3	1-5/8"	C	20.64	13.61	7.03	YES	YES	333	161	
85043	ES36	ES36	1-5/8"	C	27.63	16.85	10.78	YES	YES	628	163	
85044	ES36	ES36	1-5/8"	C	22.63	14.10	8.53	YES	NO	722	212	
85045	ES36	ES36	1-5/8"	C	14.51	10.10	4.41	YES	YES	1020	219	
85046	EB2	EB2	1-5/8"	C	27.51	16.60	10.91	YES	YES	1008	539	
85047	EB2	EB2	1-5/8"	C	25.25	15.47	9.78	YES	YES	1008	539	
85048	S21	S21	1-5/8"	C	29.16	16.88	12.28	YES	NO	432	106	
85049	S21	S21	1-5/8"	C	25.53	15	10.53	YES	NO	597	107	
85050	ES36	ES36	1-5/8"	C	23.50	14.47	9.03	YES	NO	525	138	
85051	ES36	ES36	1-5/8"	C	18.75	12.22	6.53	YES	YES	1019	139	
85052	ES36	ES36	1-5/8"	C	13.25	9.47	3.78	YES	YES	1019	139	
85053	EB3	EB3	1-5/8"	C	24.65	15.49	9.16	YES	NO	1019	227	
85054	EB2	EB2	1-5/8"	C	23.26	14.35	8.91	YES	NO	602	104	
85055	EB2	EB2	1-5/8"	C	25.63	15.60	10.03	YES	NO	577	102	
85056	S21	ES36	1-5/8"	C	20.15	12.87	7.28	YES	YES	732	114	
85057	ES36	EB3	1-5/8"	C	21.45	14.23	7.22	YES	YES	1216	115	
85058	ES36	ES36	1-5/8"	C	22.63	14.22	8.41	YES	YES	722	114	
85059	ES36	EB3	1-5/8"	C	19.07	12.79	6.28	YES	YES	928	151	
85060	ES36	ES36	1-5/8"	C	19.75	12.72	7.03	YES	YES	943	405	
85061	ES161	ES162	1-5/8"	C	24.75	15.22	9.53	YES	YES	1216	195	
85062	EB2	EB2	1-5/8"	C	19.76	12.60	7.20	YES	NO	523	199	
85063	EB2	EB2	1-5/8"	C	32.01	18.85	13.16	YES	NO	762	174	
85064	ES36	ES36	1-5/8"	C	16.01	10.72	5.28	YES	YES	1481	340	
85065	ES161	S21	1-5/8"	C	28.02	16.99	11.03	YES	YES	1059	300	
85066	ES161	ES162	1-5/8"	C	24.63	15.22	9.41	YES	YES	812	322	
85067	ES174	ES136	1-5/8"	C	30.51	18.10	12.41	YES	YES	676	170	
85069	S21	S21	1-5/8"	C	26.28	15.94	10.34	YES	YES	762	255	
85070	ES174	EB3	1-5/8"	C	25.60	15.82	9.78	YES	NO	1100	310	
85071	S21	S21	1-5/8"	C	25.57	15.04	10.53	YES	NO	610	107	
85072	ES36	ES176	1-5/8"	C	24.17	14.83	9.34	YES	YES	1387	305	
85078	ES36	ES36	1-5/8"	C	14.77	10.13	4.64	YES	YES	1409	282	
85079	ES36	ES36	1-5/8"	C	12.04	8.87	3.17	YES	YES	1494	325	
85080	ES175	S21	1-5/8"	C	22.51	13.78	8.74	YES	NO	447	138	
85081	ES175	S21	1-5/8"	C	23.44	14.33	9.11	YES	YES	1658	250	
85082	ES90	ES90	1-5/8"	C	28.60	20.64	7.97	YES	YES	1435	266	

★ Will be available in first quarter of 2011.

* Damping force, in pounds, to either extend or collapse the shock absorber at an average operating velocity. Fuerza de amortiguación en libras para extender o comprimir el amortiguador a una velocidad de operación promedio. La puissance d'amortissement en poids de l'amortisseur, soit comprimé, doit détendu, à une vitesse de fonctionnement moyenne.

SPECIFICATIONS BY PART NUMBER

ESPECIFICACIONES POR NÚMERO DE PIEZA

SPÉCIFICATIONS PAR NUMÉRO DE PIÈCE

Gabriel	Mounting		Bore	External Diameter Illustration	Extended	Lengths Collapsed	Stroke	Dust Tube	Recoil Cutoff	Controls *	
	Upper	Lower								Rebound	Compression
85083	ES162	S42	1-5/8"	C	27.81	16.53	11.28	YES	YES	1429	184
85084★	ES174	ES136	1-5/8"	C	20.59	13.03	7.57	YES	NO	1145	407
85085★	S21	S21	1-5/8"	C	24.95	14.67	10.23	YES	NO	970	101
85300	EB3	EB3	1-5/8"	D	18	12.22	5.78	YES	YES	1435	676
85301	EB3	EB3	1-5/8"	D	31.92	19.03	12.89	YES	NO	1442	455
85302	EB3	EB3	1-5/8"	D	22.75	14.66	8.09	YES	NO	836	253
85303	EB3	EB3	1-5/8"	D	24.75	15.47	9.28	YES	NO	1019	221
85304	EB3	EB3	1-5/8"	D	22.25	14.22	8.03	YES	NO	767	325
85305	EB3	EB3	1-5/8"	D	27.25	16.72	10.53	YES	NO	1120	225
85307	EB3	EB3	1-5/8"	D	24.01	15.10	8.91	YES	NO	1094	173
85308	EB3	EB3	1-5/8"	D	25.13	15.85	9.28	YES	YES	764	254
85310	S42	S42	1-5/8"	D	18.65	11.74	6.91	YES	YES	1379	578
85311	S21	EB3	1-5/8"	D	23.95	14.79	9.16	YES	YES	764	254
85312	EB3	S21	1-5/8"	D	23.69	14.85	8.84	YES	YES	717	111
85313	EB3	EB3	1-5/8"	D	26.26	16.35	9.91	YES	YES	717	111
85314	EB3	EB3	1-5/8"	D	26.50	16.47	10.03	YES	YES	1216	169
85315	EB3	EB3	1-5/8"	D	29.66	18.15	11.51	YES	NO	380	142
85316	S21	ES36	1-5/8"	D	20.61	12.85	7.76	YES	NO	943	443
85317	S21	EB3	1-5/8"	D	27.18	17.42	9.76	YES	YES	764	254
85318	S21	S21	1-5/8"	D	27.37	16.36	11.01	YES	YES	1372	192
85319	S21	ES150	1-5/8"	D	22.20	13.92	8.28	YES	YES	988	454
85320	EB3	EB3	1-5/8"	D	26.13	16.35	9.78	YES	NO	970	308
85321	ES36	ES36	1-5/8"	D	25.36	15.58	9.78	YES	YES	1435	676
85322	EB3	ES160	1-5/8"	D	15.26	11.85	3.41	YES	YES	764	162
85323	ES36	ES36	1-5/8"	D	17.36	11.58	5.78	YES	YES	1085	163
85324	S21	S21	1-5/8"	D	22.14	13.61	8.53	YES	NO	579	114
85325	S21	S21	1-5/8"	D	23.64	14.36	9.28	YES	NO	1024	240
85326	S21	S21	1-5/8"	D	19.64	12.36	7.28	YES	NO	799	142
85327	EB3	ES160	1-5/8"	D	16.01	12.10	3.91	YES	YES	764	162
85328	S21	S21	1-5/8"	D	25.64	15.36	10.28	YES	NO	930	383
85329	EB3	EB3	1-5/8"	D	24.50	15.47	9.03	YES	YES	1550	232
85330	EB3	S21	1-5/8"	D	22.44	14.16	8.28	YES	YES	1140	176
85331	ES158	ES159	1-5/8"	D	19.66	12.88	6.78	YES	YES	1757	396
85332	S42	ES36	1-5/8"	D	20.64	12.98	7.66	YES	YES	2351	967
85333	S42	ES36	1-5/8"	D	20.64	12.98	7.66	YES	YES	1241	534
85334	EB3	EB3	1-5/8"	D	14.50	10.47	4.03	YES	YES	1271	319
85335	ES158	ES159	1-5/8"	D	19.66	12.88	6.78	YES	YES	827	107
85336	S21	S21	1-5/8"	D	18.76	11.86	6.90	YES	NO	861	200
85337	ES36	ES36	1-5/8"	D	28.72	17.45	11.28	YES	YES	1318	374
85338	ES36	ES36	1-5/8"	D	19.47	12.70	6.77	YES	YES	1664	420
85339	EB3	EB3	1-5/8"	D	31.68	19.02	12.66	YES	YES	804	463
85340★	ES188	S21	1-5/8"	D	26.46	15.85	10.61	YES	YES	1807	165
85341★	ES188	S21	1-5/8"	D	30.95	18.10	12.85	YES	YES	1807	333
85376	EB3	EB3	1-5/8"	D	33.25	19.72	13.53	YES	NO	668	134
85377	ES182	ES182	1-5/8"	D	23.80	14.84	8.96	YES	YES	1937	570
85378	ES182	ES182	1-5/8"	D	23.80	14.84	8.96	YES	YES	1110	240
85700	EB3	EB3	1-5/8"	D	26.13	16.60	9.53	YES	YES	1446	328
85701	S21	S21	1-5/8"	D	15.64	10.36	5.28	YES	YES	914	204
85702	EB3	EB3	1-5/8"	D	23.76	15.85	7.91	YES	YES	1093	825
85703	S21	EB3	1-5/8"	D	29.57	18.54	11.03	YES	YES	1435	186
85704	EB3	EB3	1-5/8"	D	28.75	18.72	10.03	YES	YES	1435	186
85705	S21	S21	1-5/8"	D	23.65	14.24	9.41	YES	YES	639	436

★ Will be available in first quarter of 2011.

* Damping force, in pounds, to either extend or collapse the shock absorber at an average operating velocity. Fuerza de amortiguación en libras para extender o comprimir el amortiguador a una velocidad de operación promedio. La puissance d'amortissement en poids de l'amortisseur, soit comprimé, doit détendu, à une vitesse de fonctionnement moyenne.

SPECIFICATIONS BY PART NUMBER

ESPECIFICACIONES POR NÚMERO DE PIEZA

SPÉCIFICATIONS PAR NUMÉRO DE PIÈCE

Gabriel	Mounting		Bore	External Diameter Illustration	Extended	Lengths		Stroke	Dust Tube	Recoil Cutoff	Controls *	
	Upper	Lower				Collapsed	Rebound				Compression	
85706	S21	S21	1-5/8"	D	23.65	14.24	9.41	YES	YES	1086	696	
85707	S21	S21	2-1/16"	D	23.65	14.40	9.25	YES	YES	1761	986	
85708	S21	S21	1-5/8"	D	20.64	12.86	7.78	YES	YES	914	204	
85709	S21	S21	1-5/8"	D	31.64	18.36	13.28	YES	YES	700	203	
85710	S21	EB3	1-5/8"	D	23.45	15.10	8.34	YES	YES	994	248	
85711	S21	EB3	1-5/8"	D	24.57	15.29	9.28	YES	YES	1435	208	
85712	EB3	EB3	1-5/8"	D	20.50	13.47	7.03	YES	YES	1435	562	
85713	EB3	EB3	1-5/8"	D	24.50	15.47	9.03	YES	YES	1157	180	
85714	EB3	EB3	1-5/8"	D	25.13	15.85	9.28	YES	YES	1220	175	
85715	EB3	EB3	1-5/8"	D	25.13	15.85	9.28	YES	YES	1915	200	
85716	EB3	EB3	1-5/8"	D	22.01	14.35	7.66	YES	YES	1220	175	
85717	EB3	EB3	1-5/8"	D	25.13	15.85	9.28	YES	YES	1915	200	
85718	EB3	EB3	1-5/8"	D	22.13	15.04	7.09	YES	YES	2506	206	
85719	EB3	EB3	1-5/8"	D	17.25	11.97	5.28	YES	YES	1517	213	
85720	EB3	EB3	1-5/8"	D	20.50	13.47	7.03	YES	YES	1435	562	
85722	S21	S21	1-5/8"	D	27.15	16.43	10.72	YES	YES	1264	369	
85723	EB3	S21	1-5/8"	D	19.94	12.91	7.03	YES	YES	1318	248	
85724	ES158	ES159	1-5/8"	D	22.78	14.50	8.28	YES	YES	1235	454	
85727	S21	S21	1-5/8"	D	29.89	17.36	12.53	YES	YES	783	111	
85728	S21	S21	1-5/8"	D	24.39	14.86	9.53	YES	YES	1435	510	
85729	EB3	S21	1-5/8"	D	21.58	13.80	7.78	YES	YES	783	111	
85730	EB3	EB3	1-5/8"	D	30.75	18.72	12.03	YES	YES	1517	293	
85731	S21	EB3	1-5/8"	D	30.57	18.54	12.03	YES	YES	1517	293	
85732	EB3	EB3	2-1/16"	E	22.13	15.11	7.03	YES	YES	2632	382	
85733	EB3	S21	1-5/8"	D	23.57	14.73	8.84	YES	YES	717	111	
85734	EB3	EB3	1-5/8"	D	20.74	13.71	7.03	YES	YES	1288	227	
85735	EB3	EB3	1-5/8"	D	26.74	16.71	10.03	YES	YES	1288	227	
85736	EB3	EB3	1-5/8"	D	23.62	15.21	8.41	YES	YES	1155	352	
85737	ES173	ES173	1-5/8"	D	15.11	10.84	4.27	YES	YES	3066	782	
85738	ES36	ES36	1-5/8"	D	17.47	11.70	5.77	YES	YES	1830	416	
85739	ES187	ES187	1-5/8"	D	20.73	13.54	7.19	YES	YES	3247	334	
85740★	EB3	S21	1-5/8"	D	24.70	15.15	9.55	YES	YES	848	305	
85900	S21	S21	1-5/8"	G	17.27	11.16	6.11	YES	YES	1467	337	
85901	EB3	EB3	1-5/8"	G	29.05	17.64	11.41	YES	NO	1830	418	
85902	S21	S21	1-5/8"	G	19.01	12.03	6.98	YES	YES	1441	267	
85903	ES36	ES36	1-5/8"	G	31.99	19.13	12.86	YES	YES	666	113	
85904	ES36	ES36	1-5/8"	G	27.61	16.88	10.73	YES	YES	666	113	
85905	ES36	EB3	1-5/8"	G	23.81	16.16	7.66	YES	YES	1020	219	
85906	ES36	ES36	1-5/8"	G	21.73	14	7.73	YES	YES	700	255	
85907	ES36	EB3	1-5/8"	G	21.43	14.20	7.23	YES	YES	1216	251	
85908	ES36	ES36	1-5/8"	G	18.48	12.25	6.23	YES	YES	1020	219	
85909	ES36	ES36	1-5/8"	G	24.24	15.13	9.11	YES	YES	700	255	
85910	ES36	ES36	1-5/8"	G	20.73	13.50	7.23	YES	YES	1074	219	
85911	ES36	ES36	1-5/8"	G	16.86	11.50	5.36	YES	YES	1020	219	
85912	EB3	ES36	1-5/8"	G	18.68	12.57	6.11	YES	YES	1020	219	
85913	ES36	EB3	1-5/8"	G	22.56	15.20	7.36	YES	YES	1020	219	
85914	ES36	ES36	1-5/8"	G	14.36	10.25	4.11	YES	YES	1020	219	
85915	ES36	EB3	1-5/8"	G	19.06	12.70	6.36	YES	YES	1020	219	
85916	ES36	ES36	1-5/8"	G	24.61	15.51	9.11	YES	YES	1149	219	
85918	ES150	ES150	1-5/8"	G	22.96	14.55	8.41	YES	NO	1726	412	
85919	ES36	ES36	1-5/8"	G	22.48	14.25	8.23	YES	YES	1265	121	
85920	ES150	ES150	1-5/8"	G	21.19	13.53	7.66	YES	NO	845	49	

★ Will be available in first quarter of 2011.

* Damping force, in pounds, to either extend or collapse the shock absorber at an average operating velocity. Fuerza de amortiguación en libras para extender o comprimir el amortiguador a una velocidad de operación promedio. La puissance d'amortissement en poids de l'amortisseur, soit comprimé, doit détendu, à une vitesse de fonctionnement moyenne.

SPECIFICATIONS BY PART NUMBER

ESPECIFICACIONES POR NÚMERO DE PIEZA

SPÉCIFICATIONS PAR NUMÉRO DE PIÈCE

Gabriel	Mounting		Bore	External Diameter Illustration	Extended	Lengths Collapsed	Stroke	Dust Tube	Recoil Cutoff	Controls *	
	Upper	Lower								Rebound	Compression
85921	S21	ES36	1-5/8"	G	22.03	13.50	8.53	YES	NO	2053	339
85922	ES150	ES150	1-5/8"	G	21.19	13.53	7.66	YES	NO	878	185
85923	ES177	ES161	1-5/8"	G	22.48	14.50	7.98	YES	YES	1940	221
85924	ES90	ES36	1-5/8"	G	20.41	12.96	7.46	YES	NO	1036	122
85925	ES90	ES90	1-5/8"	G	22.54	15.59	6.96	YES	NO	761	144
85926	ES90	ES90	1-5/8"	G	26.48	17.96	8.53	YES	YES	1387	279
85927	ES90	ES90	1-5/8"	G	24.74	15.38	9.36	YES	YES	1288	388
85928	ES90	ES90	1-5/8"	G	20.28	13.21	7.08	YES	NO	957	229
85929	ES90	ES90	1-5/8"	G	20.28	13.21	7.08	YES	NO	2214	267
85930	ES177	ES161	1-5/8"	G	17.86	12	5.86	YES	YES	1617	342
85931	ES177	ES161	1-5/8"	G	22.48	14.50	7.98	YES	YES	1435	220
85932	ES178	ES150	1-5/8"	G	21.23	13.62	7.61	YES	YES	1102	430
85933	ES175	ES175	1-5/8"	G	18.23	12.71	5.52	YES	YES	1089	383
85934	ES36	ES36	1-5/8"	G	17.73	12	5.73	YES	YES	3511	1063
85935	S21	ES36	1-5/8"	G	18.70	11.92	6.78	YES	NO	1054	419
85936	ES174	S43	1-5/8"	G	17.23	11.38	5.85	YES	YES	1479	337
85937	ES174	S43	1-5/8"	G	18.98	12.26	6.72	YES	YES	1479	337
85938	ES36	ES36	1-5/8"	G	16.06	10.78	5.28	YES	YES	1581	432
85939	ES36	ES36	1-5/8"	G	14.44	10.03	4.41	YES	YES	1719	420
85953	ES90	ES90	1-5/8"	G	26.13	15.86	10.27	YES	NO	2001	153
85954	ES90	ES36	1-5/8"	G	20.43	12.96	7.46	YES	NO	1812	148
85955	ES175	ES150	1-5/8"	G	21.25	13.66	7.59	YES	YES	1034	397
85956	ES183	ES184	1-5/8"	G	30.63	18.75	11.87	YES	YES	979	373
85957	ES90	ES90	1-5/8"	G	20.78	13.15	7.63	YES	NO	1583	138
85958	ES150	ES150	1-5/8"	G	22.96	14.55	8.41	YES	YES	1926	281
85959	ES150	ES150	1-5/8"	G	21.19	13.53	7.66	YES	YES	1021	123
85961	ES178	ES176	1-5/8"	G	22.83	14.17	8.66	YES	YES	2206	240
85962	ES178	ES176	1-5/8"	G	21.80	13.66	8.15	YES	YES	2206	240
85963	ES90	ES36	1-5/8"	G	25.49	18.68	6.81	YES	YES	1490	206
85964	ES90	ES36	1-5/8"	G	25.49	18.68	6.81	YES	YES	1981	205
85965★	ES178	ES161	1-5/8"	G	24.24	15.15	9.09	YES	YES	2206	238
85966★	ES178	ES161	1-5/8"	G	23.25	14.64	8.62	YES	YES	2206	238
85967★	ES178	ES176	1-5/8"	G	23.93	14.86	9.07	YES	YES	2206	238
85968★	EB3	EB3	1-5/8"	G	19.87	13.39	6.48	YES	YES	1069	227
85969★	ES90	ES36	1-5/8"	G	18.38	11.93	6.45	YES	NO	1612	125
85970★	ES188	S21	1-5/8"	G	27.19	16.40	10.78	YES	YES	1092	147
87000	S21	EB3	2-1/16"	E	24.46	15.21	9.25	YES	YES	1332	300
87001	EB3	EB3	2-1/16"	E	20.76	13.76	7	YES	YES	1158	190
87002	EB3	EB3	2-1/16"	E	23.50	15.41	8.09	YES	YES	879	203
87003	EB3	EB3	2-1/16"	E	26.26	16.51	9.75	YES	YES	1332	395
87004	EB3	EB3	2-1/16"	E	26.76	16.76	10	YES	YES	1158	190
87006	EB3	EB3	2-1/16"	E	23.75	15.25	8.50	YES	YES	1158	272
87011	S21	S21	2-1/16"	E	23.65	14.40	9.25	YES	YES	1750	1050
87012	S21	S21	2-1/16"	E	23.65	14.40	9.25	YES	YES	650	364
87013	S21	S21	2-1/16"	E	23.65	14.40	9.25	YES	YES	1075	585
87015	ES173	ES173	45MM	E	15.51	11.18	4.33	YES	YES	4950	900
87016★	S21	EB3	2-1/16"	E	21.17	13.91	7.26	YES	YES	1808	238
87017★	ES160	ES160	2-1/16"	E	23.35	15.31	8.07	YES	YES	1876	220
89401	EB2	EB2	1-5/8"	G	28.41	17.16	11.25	YES	NO	665‡	194‡
89402	EB2	EB2	1-5/8"	G	24.41	15.16	9.25	YES	NO	874‡	206‡
89403	EB2	EB2	1-5/8"	G	26.86	17.16	9.70	YES	YES	929‡	281‡
89405	ES36	ES36	1-5/8"	G	26.24	16.41	9.83	YES	YES	1009‡	249‡

★ Will be available in first quarter of 2011.

* Damping force, in pounds, to either extend or collapse the shock absorber at an average operating velocity. Fuerza de amortiguación en libras para extender o comprimir el amortiguador a una velocidad de operación promedio. La puissance d'amortissement en poids de l'amortisseur, soit comprimé, doit détendu, à une vitesse de fonctionnement moyenne.

‡ For GasSLX Series, forces are at the "Firm" (F) setting. / Para la serie Gas SLX, las fuerzas estan ajustada en (F) "Firme". / Pour la série GasSLX, le réglage de la force est sur « Ferme » (F).

SPECIFICATIONS BY PART NUMBER

ESPECIFICACIONES POR NÚMERO DE PIEZA

SPÉCIFICATIONS PAR NUMÉRO DE PIÈCE

Gabriel	Mounting		Bore	External Diameter Illustration	Lengths		Stroke	Dust Tube	Recoil Cutoff	Controls *	
	Upper	Lower			Extended	Collapsed				Rebound	Compression
89406	ES36	ES36	1-5/8"	G	24.74	15.66	9.08	YES	YES	658‡	125‡
89407	ES36	ES36	1-5/8"	G	21.62	14.04	7.58	YES	YES	652‡	218‡
89408	EB2	EB2	1-5/8"	G	19.67	12.79	6.88	YES	NO	536‡	201‡
89409	EB2	EB2	1-5/8"	G	26.36	16.41	9.95	YES	YES	567‡	165‡
89410	EB3	EB3	1-5/8"	G	26.33	16.42	9.91	YES	NO	1185‡	182‡
89411	ES90	ES90	1-5/8"	G	25.36	15.59	9.78	YES	YES	436‡	186‡
89412	EB3	EB3	1-5/8"	G	24.26	15.68	8.58	YES	YES	1155‡	169‡
89413	EB2	EB2	1-5/8"	G	20.91	13.41	7.50	YES	NO	536‡	201‡
89414	ES36	ES36	1-5/8"	G	29.62	18.04	11.58	YES	YES	1045‡	217‡
89415	EB2	EB2	1-5/8"	G	20.12	13.29	6.83	YES	YES	1155‡	514‡
89416	EB2	EB2	1-5/8"	G	28.62	17.54	11.08	YES	YES	1155‡	514‡
89417	ES136	S21	1-5/8"	G	22.93	14.18	8.75	YES	NO	1226‡	515‡
89418	S21	S21	1-5/8"	G	21.44	13.19	8.25	YES	NO	1266‡	515‡
89419	EB3	EB3	1-5/8"	G	18	12.55	5.45	YES	YES	1352‡	636‡
89420	EB3	EB3	1-5/8"	G	22.81	14.68	8.13	YES	NO	862‡	258‡
89422	EB3	EB3	1-5/8"	G	25.13	16.18	8.95	YES	YES	794‡	253‡
89423	S21	S21	1-5/8"	G	18.65	12.07	6.58	YES	YES	1352‡	573‡
89424	S21	EB3	1-5/8"	G	23.70	15	8.70	YES	YES	794‡	253‡
89425	EB3	EB3	1-5/8"	G	26.50	16.80	9.70	YES	YES	1352‡	167‡
89426	S21	ES36	1-5/8"	G	20.43	12.93	7.50	YES	NO	926‡	419‡
89427	S21	EB3	1-5/8"	G	27.20	17.50	9.70	YES	YES	794‡	253‡
89428	S21	ES150	1-5/8"	G	21.96	14.13	7.83	YES	YES	958‡	446‡
89429	EB3	EB3	1-5/8"	G	26.18	16.43	9.75	YES	NO	553‡	266‡
89430	ES36	ES36	1-5/8"	G	24.74	15.54	9.53	YES	YES	1462‡	279‡
89431	ES36	ES36	1-5/8"	G	22.41	14.16	8.25	YES	NO	751‡	211‡
89432	ES36	ES36	1-5/8"	G	23.41	14.66	8.75	YES	NO	1507‡	561‡
89434	EB2	EB2	1-5/8"	G	27.12	16.79	10.33	YES	YES	1155‡	514‡
89435	EB2	EB2	1-5/8"	G	24.86	15.66	9.20	YES	YES	1155‡	514‡
89436	ES36	ES36	1-5/8"	G	17.24	11.91	5.33	YES	YES	998‡	217‡
89437	ES36	ES36	1-5/8"	G	20.12	13.29	6.83	YES	YES	1155‡	514‡
89438	EB2	EB2	1-5/8"	G	23.17	14.54	8.63	YES	NO	583‡	103‡
89439	EB2	EB2	1-5/8"	G	25.67	15.79	9.88	YES	NO	518‡	103‡
89440	ES36	ES36	1-5/8"	G	23.86	15.16	8.70	YES	YES	1498‡	561‡
89441	S21	ES36	1-5/8"	G	20.14	13.06	7.08	YES	YES	761‡	126‡
89442	EB3	EB3	1-5/8"	G	24.55	15.55	9	YES	NO	1055‡	224‡
89443	ES158	ES159	1-5/8"	G	22.17	14.31	7.86	YES	YES	1206‡	466‡
89446	EB2	EB2	1-5/8"	G	28.36	17.41	10.95	YES	YES	702‡	204‡
89447	S21	S21	1-5/8"	G	23.65	14.57	9.08	YES	YES	702‡	241‡
89448	ES161	ES162	1-5/8"	G	24.62	15.54	9.08	YES	YES	782‡	323‡
89449	ES150	ES150	1-5/8"	G	23.09	14.71	8.38	YES	NO	1519‡	324‡
89450	ES161	ES162	1-5/8"	G	24.62	15.54	9.08	YES	YES	1282‡	193‡
89451	ES174	ES136	1-5/8"	G	30.36	18.41	11.95	YES	YES	645‡	172‡
89453	ES178	ES150	1-5/8"	G	21.10	13.78	7.32	YES	YES	860‡	435‡
89454	ES175	ES175	1-5/8"	G	18.23	12.78	5.45	YES	YES	938‡	388‡
89455	S21	S21	1-5/8"	G	26.28	15.92	10.36	YES	YES	791‡	276‡
89456	ES174	S43	1-5/8"	G	17.02	11.29	5.73	YES	YES	975‡	377‡
89457	ES90	ES36	1-5/8"	G	19.95	12.71	6.97	YES	NO	941‡	156‡
89458	ES177	ES161	1-5/8"	G	22.47	14.25	7.95	YES	YES	1575‡	222‡
89459★	ES174	EB3	1-5/8"	G	25.62	15.86	9.78	YES	NO	1179	314
89460★	ES174	ES136	1-5/8"	G	20.58	13.03	7.55	YES	NO	997	384
G60002	S1	S1	1-3/8"		23.02	13.49	9.53	YES	NO		
G60003	EB1	EB1	1-3/8"		18.08	11.55	6.53	YES	NO		

★ Will be available in first quarter of 2011.

* Damping force, in pounds, to either extend or collapse the shock absorber at an average operating velocity. Fuerza de amortiguación en libras para extender o comprimir el amortiguador a una velocidad de operación promedio. La puissance d'amortissement en poids de l'amortisseur, soit comprimé, doit détendu, à une vitesse de fonctionnement moyenne.

‡ For GasSLX Series, forces are at the "Firm" (F) setting. / Para la serie Gas SLX, las fuerzas estan ajustada en (F) "Firme". / Pour la série GasSLX, le réglage de la force est sur « Ferme » (F).

SPECIFICATIONS BY PART NUMBER

ESPECIFICACIONES POR NÚMERO DE PIEZA

SPÉCIFICATIONS PAR NUMÉRO DE PIÈCE

Gabriel	Mounting		Bore	External Diameter Illustration	Extended	Lengths Collapsed	Stroke	Dust Tube	Recoil Cutoff	Controls *	
	Upper	Lower								Rebound	Compression
G60007	EB1	ES25	1-3/8"		23	13.97	9.03	YES	NO		
G60008	ES3	ES24	1-3/8"		18.08	11.55	6.53	YES	NO		
G60010	EB7	ES34	1-3/8"		23.33	14.30	9.03	YES	NO		
G60011	S1	ES25	1-3/8"		18.83	11.80	7.03	YES	NO		
G60012	ES2	EB4	1-3/8"		24.74	14.96	9.78	YES	NO		
G60014	EB7	ES24	1-3/8"		15	9.97	5.03	YES	NO		
G60015	ES24	ES24	1-3/8"		15	9.97	5.03	YES	NO		
G60017	S1	BP13	1-3/8"		13.80	9.02	4.78	NO	NO		
G60021	ES2	ES24	1-3/8"		19.86	12.58	7.28	YES	NO		
G60023	S36	ES25	1-3/8"		17.19	11.16	6.03	NO	YES		
G60024	S1	ES25	1-3/8"		23.33	14.05	9.28	YES	NO		
G60026	S10	ES25	1-3/8"		16.55	10.77	5.78	YES	YES		
G60028	EB4	EB4	1-3/8"		20.89	13.11	7.78	YES	NO		
G60029	ES2	EB4	1-3/8"		28.74	16.96	11.78	YES	NO		
G60030	S1	ES25	1-3/8"		22.33	13.80	8.53	YES	YES		
G60031	EB1	EB1	1-3/8"		20	12.47	7.53	YES	NO		
G60033	S10	EB6	1-3/8"		18.55	11.77	6.78	YES	YES		
G60035	EB1	ES83	1-3/8"		21.58	13.30	8.28	YES	NO		
G60038	S28	ES83	1-3/8"		15.09	10.06	5.03	NO	YES		
G60039	ES27	ES27	1-3/8"		20.76	12.98	7.78	YES	NO		
G60041	S10	ES25	1-3/8"		18.55	11.77	6.78	YES	YES		
G60042	EB1	ES25	1-3/8"		20.08	12.55	7.53	YES	NO		
G60043	S1	BP13	1-3/8"		15.80	10.02	5.78	NO	NO		
G60044	ES34	ES34	1-3/8"		23.36	14.33	9.03	YES	NO		
G60045	ES2	ES24	1-3/8"		22.08	13.55	8.53	YES	NO		
G60046	S1	S1	1-3/8"		20.52	12.24	8.28	YES	NO		
G60047	ES3	ES34	1-3/8"		26.76	15.98	10.78	YES	NO		
G60048	EB1	ES106	1-3/8"		27.08	16.05	11.03	NO	NO		
G60049	S1	BP30	1-3/8"		13.80	9.02	4.78	NO	NO		
G60050	BP8	ES34	1-3/8"		24	14.47	9.53	YES	NO		
G60051	ES8	ES82	1-3/8"		16.75	10.72	6.03	NO	NO		
G60052	S1	BP7	1-3/8"		20.47	12.69	7.78	YES	YES		
G60053	BP2	EB1	1-3/8"		20	12.47	7.53	YES	NO		
G60062	ES1	ES18	1-3/8"		18	11.47	6.53	YES	NO		
G60063	EB1	ES106	1-3/8"		23.08	14.05	9.03	YES	NO		
G60064	ES31	ES24	1-3/8"		23.33	14.05	9.28	NO	NO		
G60065	EB1	ES34	1-3/8"		29.33	17.30	12.03	NO	NO		
G60066	EB1	ES83	1-3/8"		29.75	17.22	12.53	NO	NO		
G60067	EB1	EB1	1-3/8"		26.33	15.55	10.78	NO	NO		
G60068	EB1	ES25	1-3/8"		26.33	15.55	10.78	NO	NO		
G60069	EB1	EB1	1-3/8"		23.33	13.95	9.38	NO	NO		
G60070	S1	ES17	1-3/8"		23.30	14.02	9.28	NO	YES		
G60071	S10	ES25	1-3/8"		23.24	13.99	9.25	NO	YES		
G60072	S10	EB6	1-3/8"		23.30	14.02	9.28	NO	YES		
G60073	S10	ES25	1-3/8"		30.18	17.65	12.53	NO	YES		
G60074	S1	BP4	1-3/8"		14.05	9.27	4.78	YES	NO		
G60075	EB1	EB1	1-3/8"		24.08	14.55	9.53	YES	NO		
G60076	S1	BP7	1-3/8"		13.95	9.28	4.67	NO	NO		
G60077	ES1	ES18	1-3/8"		22.81	14.03	8.78	YES	NO		
G60078	S1	BP4	1-3/8"		13.80	9.02	4.78	NO	NO		
G60079	EB5	ES25	1-3/8"		18.14	11.61	6.53	YES	NO		
G60080	ES8	ES83	1-3/8"		23	13.97	9.03	YES	NO		

★ Will be available in first quarter of 2011.

* Damping force, in pounds, to either extend or collapse the shock absorber at an average operating velocity. Fuerza de amortiguación en libras para extender o comprimir el amortiguador a una velocidad de operación promedio. La puissance d'amortissement en poids de l'amortisseur, soit comprimé, doit détendu, à une vitesse de fonctionnement moyenne.

SPECIFICATIONS BY PART NUMBER

ESPECIFICACIONES POR NÚMERO DE PIEZA

SPÉCIFICATIONS PAR NUMÉRO DE PIÈCE

Gabriel	Mounting		Bore	External Diameter Illustration	Extended	Lengths		Stroke	Dust Tube	Recoil Cutoff	Controls *	
	Upper	Lower				Collapsed	Rebound				Compression	
G60081	EB1	ES83	1-3/8"		26.76	15.98	10.78	YES	NO			
G60083	BP1	ES27	1-3/8"		23.16	14.13	9.03	YES	NO			
G60084	EB1	ES83	1-3/8"		25.50	15.22	10.28	YES	NO			
G60086	S1	ES113	1-3/8"		14.05	9.27	4.78	YES	NO			
G60087	S4	EB1	1-3/8"		20.05	12.52	7.53	YES	NO			
G60088	EB2	S32	1-3/8"		22.78	14	8.78	YES	NO			
G60089	S32	S32	1-3/8"		21.42	12.64	8.78	YES	NO			
G60091	S1	EB2	1-3/8"		21.21	12.93	8.28	YES	NO			
G60096	EB1	EB1	1-3/8"		21.99	13.71	8.28	YES	NO			
G60097	BP8	ES34	1-3/8"		26.61	16.33	10.28	YES	YES			
G60098	S29	BP11	1-3/8"		14.44	9.66	4.78	NO	YES			
G60099	EB1	ES25	1-3/8"		19.08	12.05	7.03	YES	NO			
G60100	EB1	S1	1-3/8"		19.05	11.77	7.28	YES	NO			
G60101	EB1	EB1	1-3/8"		22.58	13.80	8.78	YES	NO			
G60103	EB2	EB2	1-3/8"		22.39	13.86	8.53	YES	NO			
G60104	S1	ES17	1-3/8"		15.05	9.77	5.28	YES	NO			
G60105	S1	ES17	1-3/8"		17.05	11.02	6.03	YES	YES			
G60106	S4	ES17	1-3/8"		22.45	13.42	9.03	YES	NO			
G60107	S1	EB1	1-3/8"		22.45	13.42	9.03	YES	NO			
G60109	S1	ES17	1-3/8"		14.45	9.42	5.03	YES	NO			
G60110	BP1	ES130	1-3/8"		25.58	15.30	10.28	YES	NO			
G60111	ES82	ES82	1-3/8"		24.58	14.80	9.78	YES	NO			
G60112	ES3	ES82	1-3/8"		18.58	11.80	6.78	YES	NO			
G60113	EB1	ES24	1-3/8"		16	10.47	5.53	YES	NO			
G60114	S28	ES25	1-3/8"		15.09	10.06	5.03	NO	YES			
G60119	EB2	ES27	1-3/8"		24.24	14.71	9.53	YES	NO			
G60120	ES1	ES25	1-3/8"		18.41	11.88	6.53	YES	NO			
G60121	ES1	EB1	1-3/8"		14.98	10.20	4.78	YES	YES			
G60122	S17	ES114	1-3/8"		21.95	13.42	8.53	YES	YES			
G60124	S32	S32	1-3/8"		21.41	12.88	8.53	YES	NO			
G60128	EB2	EB2	1-3/8"		21.39	13.36	8.03	YES	NO			
G60129	S1	ES25	1-3/8"		22.55	13.52	9.03	YES	NO			
G60136	S1	ES17	1-3/8"		14.95	9.67	5.28	YES	NO			
G60137	S1	EB1	1-3/8"		22.95	13.67	9.28	YES	NO			
G60143	EB1	ES83	1-3/8"		27.08	16.05	11.03	YES	NO			
G60144	EB1	ES83	1-3/8"		23.08	14.05	9.03	YES	NO			
G60152	EB1	ES142	1-3/8"		19.74	12.46	7.28	YES	NO			
G60153	S1	ES113	1-3/8"		13.71	9.18	4.53	YES	NO			
G60154	S12	EB2	1-3/8"		21.21	13.18	8.03	YES	YES			
G60158	S36	ES83	1-3/8"		16.11	10.58	5.53	YES	YES			
G60160	ES152	ES153	1-3/8"		21.39	13.61	7.78	YES	YES			
G60161	BP33	ES83	1-3/8"		25.58	15.30	10.28	YES	NO			
G60162	S36	EB1	1-3/8"		14.58	9.81	4.78	YES	YES			
G60163	ES151	ES128	1-3/8"		16.50	10.97	5.53	YES	YES			
G60164	S1	EB1	1-3/8"		21.55	13.27	8.28	YES	NO			
G60165	S1	ES17	1-3/8"		15.05	9.77	5.28	YES	NO			
G60169	S7	ES17	1-3/8"		14.55	9.77	4.78					
G60171	S36	EB1	1-3/8"		15.12	10.09	5.03	NO	YES			
G60176	S38	S38	1-3/8"		23.66	13.88	9.78	YES	NO			
G60177	S38	EB2	1-3/8"		23.78	14.25	9.53	YES	NO			
G60179	ES83	EB1	1-3/8"		27.58	16.30	11.28	YES	NO			
G60180	EB1	S7	1-3/8"		19.55	12.27	7.28	YES	YES			

★ Will be available in first quarter of 2011.

* Damping force, in pounds, to either extend or collapse the shock absorber at an average operating velocity. Fuerza de amortiguación en libras para extender o comprimir el amortiguador a una velocidad de operación promedio. La puissance d'amortissement en poids de l'amortisseur, soit comprimé, doit détendu, à une vitesse de fonctionnement moyenne.

SPECIFICATIONS BY PART NUMBER

ESPECIFICACIONES POR NÚMERO DE PIEZA

SPÉCIFICATIONS PAR NUMÉRO DE PIÈCE

Gabriel	Mounting		Bore	External Diameter Illustration	Extended	Lengths Collapsed	Stroke	Dust Tube	Recoil Cutoff	Controls *	
	Upper	Lower								Rebound	Compression
G60181	S10	BP7	1-3/8"		16.46	10.93	5.53	YES	YES		
G60182	S36	EB1	1-3/8"		15.42	10.39	5.03	YES	YES		
G60183	S36	ES83	1-3/8"		22.67	14.39	8.28	YES	YES		
G60184	S36	ES83	1-3/8"		20.17	12.64	7.53	YES	YES		
G60185	EB7	ES36	1-3/8"		22.48	13.96	8.53	YES	NO		
G60186	EB5	ES83	1-3/8"		21.16	13.38	7.78	YES	NO		
G60194	S1	ES69	1-3/8"		14.55	9.52	5.03	YES	NO		
G60196	BP8	ES34	1-3/8"		24.33	14.80	9.53	YES	NO		
G60197	ES104	ES69	1-3/8"		24.16	14.63	9.53	YES	NO		
G60199	ES152	ES153	1-3/8"		23.89	15.11	8.78	YES	YES		
G60204	EB1	EB1	1-3/8"		25.08	15.05	10.03	YES	NO		
G60205	S1	ES34	1-3/8"		13.87	9.59	4.28	YES	YES		
G60206	ES34	ES34	1-3/8"		24.58	15.05	9.53	YES	NO		
G60214	ES82	ES82	1-3/8"		22.58	13.80	8.78	YES	NO		
G60216	S1	ES34	1-3/8"		22.30	13.77	8.53	YES	YES		
G60217	S1	ES34	1-3/8"		23.27	14.24	9.03	YES	YES		
G60218	ES34	ES34	1-3/8"		26.86	16.08	10.78	YES	NO		
G60219	ES69	ES69	1-3/8"		15.58	10.55	5.03	YES	YES		
G60221	S36	BP7	1-3/8"		18.09	13.56	4.53	YES	NO		
G60222	BP8	ES83	1-3/8"		25	14.97	10.03	YES	NO		
G60226	EB5	ES24	1-3/8"		21.16	13.38	7.78	YES	YES		
G60232	EB1	EB1	1-3/8"		19.08	12.05	7.03	YES	NO		
G60233	ES18	ES18	1-3/8"		18	11.47	6.53	YES	NO		
G60235	EB1	EB1	1-3/8"		27.58	16.30	11.28	YES	NO		
G60237	ES119	S38	1-3/8"		22.28	13.50	8.78	YES	NO		
G60238	S38	S38	1-3/8"		23.06	13.53	9.53	YES	NO		
G60249	S39	ES83	1-3/8"		18.05	11.27	6.78	YES	NO		
G60250	S10	ES17	1-3/8"		15.80	10.27	5.53	YES	NO		
G60251	ES99	EB2	1-3/8"		19.74	12.46	7.28	YES	NO		
G60253	S1	ES153	1-3/8"		18.96	11.93	7.03	YES	NO		
G60255	ES110	ES19	1-3/8"		22.58	13.80	8.78	YES	NO		
G60257	S6	BP7	1-3/8"		15.54	10.01	5.53	YES	NO		
G60258	S12	ES25	1-3/8"		28.55	16.52	12.03	YES	NO		
G60259	S12	ES26	1-3/8"		15.54	10.01	5.53	YES	NO		
G60260	ES25	ES25	1-3/8"		23	13.97	9.03	YES	NO		
G60263	S6	ES22	1-3/8"		21.30	13.02	8.28	YES	NO		
G60264	S10	BP11	1-3/8"		20.21	12.43	7.78	YES	NO		
G60265	BP18	ES24	1-3/8"		19.49	12.21	7.28	YES	NO		
G60269	S12	EB2	1-3/8"		20.96	12.93	8.03	YES	NO		
G60301	S1	BP26	1-3/8"		14.10	9.34	4.76	YES	YES		
G60302	ES126	ES128	1-3/8"		16.48	10.87	5.61	YES	NO		
G60303	S1	ES17	1-3/8"		12.60	8.59	4.01	YES	YES		
G60304	S1	BP8	1-3/8"		14.70	9.34	5.36	YES	NO		
G60305	S1	ES17	1-3/8"		14.95	9.59	5.36	YES	NO		
G60306	S1	ES24	1-3/8"		14.70	9.34	5.36	NO	NO		
G60307	ES2	ES27	1-3/8"		20.49	12.63	7.86	YES	NO		
G60308	EB1	EB1	1-3/8"		20.23	12.37	7.86	YES	NO		
G60309	ES3	ES24	1-3/8"		18.23	11.37	6.86	YES	NO		
G60310	S1	ES17	1-3/8"		14.11	9	5.11	YES	NO		
G60312	S29	ES84	1-3/8"		21.12	16.31	4.81	YES	YES		
G60313	S1	BP7	1-3/8"		13.20	8.59	4.61	NO	NO		
G60329	EB1	EB1	1-3/8"		22.73	13.87	8.86	YES	YES		

★ Will be available in first quarter of 2011.

* Damping force, in pounds, to either extend or collapse the shock absorber at an average operating velocity. Fuerza de amortiguación en libras para extender o comprimir el amortiguador a una velocidad de operación promedio. La puissance d'amortissement en poids de l'amortisseur, soit comprimé, soit détendu, à une vitesse de fonctionnement moyenne.

SPECIFICATIONS BY PART NUMBER

ESPECIFICACIONES POR NÚMERO DE PIEZA

SPÉCIFICATIONS PAR NUMÉRO DE PIÈCE

Gabriel	Mounting		Bore	External Diameter Illustration	Extended	Lengths		Stroke	Dust Tube	Recoil Cutoff	Controls *	
	Upper	Lower				Collapsed	Rebound				Compression	
G60330	S36	EB1	1-3/8"		14.72	9.71	5.01	YES	YES			
G60338	S1	BP17	1-3/8"		14.70	9.34	5.36	NO	NO			
G60353	EB1	EB1	1-3/8"		17.73	11.12	6.61	YES	NO			
G60354	S1	BP7	1-3/8"		14.20	9.09	5.11	NO	NO			
G61112	S6	BP35	1-3/8"		13.83	9.55	4.28	YES	YES			
G61113	EB1	ES83	1-3/8"		23.08	14.05	9.03	YES	NO			
G61114	S6	BP35	1-3/8"		17.95	13.42	4.53	YES	YES			
G61115	EB1	ES83	1-3/8"		27.08	16.05	11.03	YES	NO			
G61116	ES83	ES83	1-3/8"		20.76	12.98	7.78	YES	NO			
G61118	S12	ES25	1-3/8"		24.55	14.52	10.03	YES	NO			
G61121	S1	ES113	1-3/8"		18.45	11.93	6.52	YES	YES			
G61122	S1	ES118	1-3/8"		13.80	9.27	4.53	YES	NO			
G61124	S12	BP11	1-3/8"		14.80	10.27	4.53	YES	NO			
G61139	S1	EB1	1-3/8"		15.97	10.19	5.78	YES	NO			
G61140	S1	S12	1-3/8"		18.55	11.77	6.78	YES	NO			
G61144	S12	U-Brkt	1-3/8"		15.48	10.69	4.79	YES	NO			
G61148	S36	EB1	1-3/8"		15.32	10.29	5.03	YES	NO			
G61149	EB1	ES83	1-3/8"		28.86	17.08	11.78	YES	NO			
G61150	EB1	ES83	1-3/8"		23	13.97	9.03	YES	NO			
G61151	EB1	ES83	1-3/8"		31.51	18.48	13.03	YES	NO			
G61152	EB1	ES83	1-3/8"		25.50	15.22	10.28	YES	NO			
G61153	ES34	ES36	1-3/8"		22.49	13.95	8.53	YES	NO			
G61154	S39	ES17	1-3/8"		12.30	8.50	3.80	YES	NO			
G61155	S39	EB1	1-3/8"		21.45	13.17	8.28	YES	YES			
G61156	S39	ES17	1-3/8"		22.05	13.27	8.78	YES	NO			
G61158	S12	ES60	1-3/8"		15.80	11.02	4.78	YES	NO			
G61159	ES126	ES128	1-3/8"		16.50	10.97	5.53	YES	NO			
G61169	S21	ES36	1-3/8"		23.16	15.13	8.03					
G61170	ES61	ES65	1-3/8"		22.58	13.80	8.78					
G61173	S21	ES153	1-3/8"		17.16	11.38	5.78					
G61175	ES18	ES126	1-3/8"		23.33	14.80	8.53					
G61177	BP8	ES83	1-3/8"		28.23	17.95	10.28					
G61178	ES19	ES141	1-3/8"		22.58	13.80	8.78					
G61180	ES18	ES138	1-3/8"		24.58	14.80	9.78					
G61182	S38	ES34	1-3/8"		15.87	10.59	5.28					
G61204	S1	BP7	1-3/8"		20.47	12.69	7.78					
G61860	S1	EB1	1-3/8"		24.33	14.39	9.94					
G61862	S1	EB2	1-3/8"		25.07	14.94	10.13					
G61864	ES123	ES190	1-3/8"		15	10.56	4.44					
G61865	S39	ES36	1-3/8"		22.49	13.55	8.94					
G61866	ES34	ES34	1-3/8"		22.81	14.12	8.69					
G61867	413002	413002	1-3/8"		27.31	16.37	10.94					
G61868	ES31	412715	1-3/8"		15.62	10.68	4.94					
G61869	ES83	ES83	1-3/8"		20.26	12.82	7.44					
G61870	413002	413002	1-3/8"		24.89	15.20	9.69					
G61872	412998	ES82	1-3/8"		21.65	13.29	8.36					
G61873	413002	413002	1-3/8"		15.75	10.56	5.19					
G61875	ES186	ES186	1-3/8"		17.67	11.73	5.94					
G61877	413000	413000	1-3/8"		16.93	11.24	5.69					
G61878	413001	ES186	1-3/8"		24.16	14.97	9.19					
G61879	BP34	ES34	1-3/8"		23	14.31	8.69					
G61880	BP18	ES18	1-3/8"		22.50	14.06	8.44					

★ Will be available in first quarter of 2011.

* Damping force, in pounds, to either extend or collapse the shock absorber at an average operating velocity. Fuerza de amortiguación en libras para extender o comprimir el amortiguador a una velocidad de operación promedio. La puissance d'amortissement en poids de l'amortisseur, soit comprimé, doit détendu, à une vitesse de fonctionnement moyenne.

SPECIFICATIONS BY PART NUMBER

ESPECIFICACIONES POR NÚMERO DE PIEZA

SPÉCIFICATIONS PAR NUMÉRO DE PIÈCE

Gabriel	Mounting		Bore	External Diameter Illustration	Extended	Lengths Collapsed	Stroke	Dust Tube	Recoil Cutoff	Controls *	
	Upper	Lower								Rebound	Compression
G61881	S1	ES25	1-3/8"		14.71	9.48	5.22				
G61882	BP34	ES34	1-3/8"		21	13.31	7.69				
G61883	413001	ES186	1-3/8"		22.82	14.38	8.44				
G61884	S39	ES112	1-3/8"		14.72	9.78	4.94				
G61885	375166	413004	1-3/8"		22.24	13.56	8.69				
G61886	S38	ES34	1-3/8"		20.80	13.36	7.44				
G61887	EB1	ES83	1-3/8"		29.71	17.77	11.94				
G61888	EB1	ES83	1-3/8"		31.36	18.67	12.69				
G61889	S1	413003	1-3/8"		20.44	12.75	7.69				
G61890	ES18	ES18	1-3/8"		23.97	15.28	8.69				
G61891	ES18	ES18	1-3/8"		23.97	15.28	8.69				
G61892	ES19	ES141	1-3/8"		23.97	15.28	8.69				
G61893	S29	U-Brkt	1-3/8"		15.07	10.44	4.64				
G61894	S29	413042	1-3/8"		12.82	8.88	3.94				
G61895	S29	413042	1-3/8"		14.12	9.68	4.44				
G61896	BP8	ES34	1-3/8"		22.36	13.92	8.44				
G61897	BP8	ES34	1-3/8"		23.87	14.68	9.19				
G61898	BP8	ES34	1-3/8"		25.19	15.31	9.88				
G61918	ES34	ES141	1-3/8"		21.25	13.56	7.69				
G61919	ES117	ES153	1-3/8"		20.25	13.06	7.19				
G61958	S29	BP13	1-3/8"		13.80	9.13	4.67				
G61959	ES34	ES34	1-3/8"		24.78	15.84	8.94				
G61961	ES34	ES34	1-3/8"		26.51	16.12	10.39				
G61962	ES34	ES34	1-3/8"		26.05	15.87	10.18				
G61963	EB1	ES83	1-3/8"		24.75	15.06	9.69				
G61964	EB1	ES83	1-3/8"		25.47	15.53	9.94				
G61965	BP8	ES24	1-3/8"		24.13	15.20	8.94				
G61966	BP18	ES130	1-3/8"		22.44	14.50	7.94				
G61967	BP18	ES130	1-3/8"		22.62	14.43	8.19				
G61969	412847	ES34	1-3/8"		20.75	13.31	7.44				
G61970	ES34	ES34	1-3/8"		27.58	17.14	10.44				
G61971	ES34	ES34	1-3/8"		27.58	17.14	10.44				
G62000	ES34	ES34	1-3/8"		27.36	17.67	9.69				
G62001	S29	U-Brkt	1-3/8"		14.67	11.47	3.19				
G62002	ES83	ES83	1-3/8"		20.15	13.95	6.19				
G62003	413000	413000	1-3/8"		16.83	11.27	5.56				
G62004	S1	413003	1-3/8"		19.07	12.13	6.94				
G62005	S1	413003	1-3/8"		19.75	12.31	7.44				
G62006	S1	413003	1-3/8"		22.75	13.81	8.94				
G62007	S1	413003	1-3/8"		22.75	13.81	8.94				
G62008	373768	ES26	1-3/8"		21.79	13.60	8.19				
G62009			1-3/8"		23.29	14.25	9.04				
G62010			1-3/8"		26.94	16	10.94				
G62011			1-3/8"		23.36	14.21	9.14				
G62012			1-3/8"		24.11	15.17	8.94				
G62013			1-3/8"		26.52	16.33	10.19				
G62014			1-3/8"		22.75	14.56	8.19				
G62015			1-3/8"		21.32	13.63	7.69				
G62016			1-3/8"		15.91	11.22	4.69				

★ Will be available in first quarter of 2011.

* Damping force, in pounds, to either extend or collapse the shock absorber at an average operating velocity. Fuerza de amortiguación en libras para extender o comprimir el amortiguador a una velocidad de operación promedio. La puissance d'amortissement en poids de l'amortisseur, soit comprimé, doit détendu, à une vitesse de fonctionnement moyenne.

MOUNTING ACCESSORY PACKAGES AND COMPONENT PARTS

PAQUETES DE ACCESORIOS DE MONTAJE Y PIEZAS COMPONENTES ENSEMBLES D'ACCESSOIRES DE MONTURES ET DE PIÈCES DÉTACHÉES

140126			
401006	1	Hex nut / Tuerca hexagonal / Écrou hexagonal	3/8" x 24 UNF thread
401383	2	Retainer (washer) / Seguro (arandala) / Arrêt (rondelle)	3/8 in. I.D. x 1-1/2 in. O.D. x .093 in. thick
402263	2	Bushing / Anillo / Bague	7/8" centering lip for 3/8" O.D. stud
140149			
401011	4	Bushing / Anillo / Bague	EB2 style - for 1-3/4" O.D. eye ring - 3/4" diam. Stud
140169			
401011	2	Bushing / Anillo / Bague	EB2 style - for 1-3/4" O.D. eye ring - 3/4" diam. Stud
140357			
401164	1	Hex nut / Tuerca hexagonal / Écrou hexagonal	1/2" x 20 UNF Thread
401166	1	Lock washer / Arandela de freno / Rondelle-frein	1/2" lock washer
401174	1	Hex nut / Tuerca hexagonal / Écrou hexagonal	5/8" x 18 thread
401193	1	Lock washer / Arandela de freno / Rondelle-frein	5/8" I.D. (thin)
401266	1	Retainer (washer) / Seguro (arandala) / Arrêt (rondelle)	5/8" I.D. x 1-1/4" O.D. x .075" thick
402519	1	Retainer (washer) / Seguro (arandala) / Arrêt (rondelle)	1/2" I.D. x 1-1/4" O.D. x .104" thick
403050	1	Stud / Pasador / Goujon	1/2" x 20 and 5/8" x 18 thread
140455			
401006	1	Hex nut / Tuerca hexagonal / Écrou hexagonal	3/8" x 24 UNF thread
401008	2	Retainer (washer) / Seguro (arandala) / Arrêt (rondelle)	3/8 in. I.D. x 1-1/4 in. O.D. x .075 in. thick
403489	2	Bushing / Anillo / Bague	5/8" centering lip for 3/8" O.D. stud
140524			
401006	1	Hex nut / Tuerca hexagonal / Écrou hexagonal	3/8" x 24 UNF thread
401376	2	Retainer (washer) / Seguro (arandala) / Arrêt (rondelle)	3/8 in. I.D. x 1-3/8 in. O.D. x .089 in. thick
402294	2	Bushing / Anillo / Bague	5/8" lip for 3/8" dia. stud-5/8" or 7/8" holes
140526			
403813	2	Boot / Tubo / Gaine	
403815	2	Cotter pin / Clavija / Goupille	
404046	2	Nut / Tuerca / Écrou	1/2" x 20 UNF Thread
140673			
401006	1	Hex nut / Tuerca hexagonal / Écrou hexagonal	3/8" x 24 UNF thread
401008	2	Retainer (washer) / Seguro (arandala) / Arrêt (rondelle)	3/8 in. I.D. x 1-1/4 in. O.D. x .075 in. thick
403962	2	Bushing / Anillo / Bague	1/2" centering lip for 3/8" O.D. stud
140689			
401006	3	Hex nut / Tuerca hexagonal / Écrou hexagonal	3/8" x 24 UNF thread
402263	2	Bushing / Anillo / Bague	7/8" centering lip for 3/8" O.D. stud
404001	2	Retainer (washer) / Seguro (arandala) / Arrêt (rondelle)	10 mm I.D. x 1-1/2" O.D. x .120" thick
140702			
401174	1	Hex nut / Tuerca hexagonal / Écrou hexagonal	5/8" x 18 thread
401184	1	Lock washer / Arandela de freno / Rondelle-frein	7/16" Lock washer
401193	1	Lock washer / Arandela de freno / Rondelle-frein	5/8" I.D. (thin)
402844	1	Hex nut / Tuerca hexagonal / Écrou hexagonal	7/16" x 20 UNF Thread
403878	1	Washer / Arandela / Rondelle	0.453" I.D. x 1.25" O.D. x .075" thick
404782	1	Stud / Pasador / Goujon	5/8" x 18 and 7/16" x 20
140719			
402653-001	2	Lock washer / Arandela de freno / Rondelle-frein	5/16" I.D. (med.)
403870-001	2	Bolt / Tornillo / Boulon	Hex Head 5/16" x 18 x 3/4 in. long
403871-001	2	Hex nut / Tuerca hexagonal / Écrou hexagonal	5/16" x 18 thread
140780			
401006	1	Hex nut / Tuerca hexagonal / Écrou hexagonal	3/8" x 24 UNF thread
402943	1	Retainer (washer) / Seguro (arandala) / Arrêt (rondelle)	0.457" I.D. x 1.68" O.D. x .120" thick
403298	1	Retainer (washer) / Seguro (arandala) / Arrêt (rondelle)	0.390" I.D. x 1.68" O.D. x .120" thick
403299	2	Bushing / Anillo / Bague	7/8" centering lip for 7/16" O.D. stud
140857			
401006	1	Hex nut / Tuerca hexagonal / Écrou hexagonal	3/8" x 24 UNF thread
401008	1	Retainer (washer) / Seguro (arandala) / Arrêt (rondelle)	3/8 in. I.D. x 1-1/4 in. O.D. x .075 in. thick
401383	1	Retainer (washer) / Seguro (arandala) / Arrêt (rondelle)	3/8 in. I.D. x 1-1/2 in. O.D. x .093 in. thick
403489	2	Bushing / Anillo / Bague	5/8" centering lip for 3/8" O.D. stud
429680-030	1	Instruction sheet / Hoja de direc. / Feuillet d'instr.	

MOUNTING ACCESSORY PACKAGES AND COMPONENT PARTS

PAQUETES DE ACCESORIOS DE MONTAJE Y PIEZAS COMPONENTES ENSEMBLES D'ACCESSOIRES DE MONTURES ET DE PIÈCES DÉTACHÉES

140884		
401267	1 Retainer (washer) / Seguro (arandala) / Arrêt (rondelle)	5/8" I.D. x 1-1/4" O.D. x .075" thick
402662	1 Spacer / Tirante / Entretoise	5/8" I.D. x 1-1/4" O.D. x 1/4" thick
412016	1 Extn nut / Tuerca ext. / Écrou ext.	7/16" x 20 UNF Thread
427030	1 Instruction sheet / Hoja de direc. / Feuillet d'instr.	
140885		
401267	1 Retainer (washer) / Seguro (arandala) / Arrêt (rondelle)	5/8" I.D. x 1-1/4" O.D. x .075" thick
402662	1 Spacer / Tirante / Entretoise	5/8" I.D. x 1-1/4" O.D. x 1/4" thick
403189	2 Spacer / Tirante / Entretoise	1/2" I.D. x 1-1/4" O.D.
411012	2 Sleeve / Manguito / Manchon	13 mm I.D. x 5/8 in. O.D. x 1-5/16 in. long
412016	1 Extn nut / Tuerca ext. / Écrou ext.	7/16" x 20 UNF Thread
427031	1 Instruction sheet / Hoja de direc. / Feuillet d'instr.	
140921		
401006	1 Hex nut / Tuerca hexagonal / Écrou hexagonal	3/8" x 24 UNF thread
401007	1 Pal nut / Tuerca Pal / Écrou Pal	3/8" x 24 UNF thread
401011	2 Bushing / Anillo / Bague	EB2 style - for 1-3/4" O.D. eye ring - 3/4" diam. Stud
401377	1 Retainer (washer) / Seguro (arandala) / Arrêt (rondelle)	1/2" I.D. x 1-3/8" O.D. x .075" thick
401383	1 Retainer (washer) / Seguro (arandala) / Arrêt (rondelle)	3/8 in. I.D. x 1-1/2 in. O.D. x .093 in. thick
402267	2 Bushing / Anillo / Bague	9/16" centering lip for 7/16" O.D. stud
140947		
401193	1 Lock washer / Arandela de freno / Rondelle-frein	5/8" I.D. (thin)
404451	2 Hex nut / Tuerca hexagonal / Écrou hexagonal	16 x 1.5 metric thread
404452	4 Retainer (washer) / Seguro (arandala) / Arrêt (rondelle)	5/8" I.D. x 2-3/4" O.D. x .180" thick
404453	2 Sleeve / Manguito / Manchon	16 mm I.D. x 1-3/16" O.D. x 1-1/2" long
404454	4 Bushing / Anillo / Bague	1-3/16" centering lip for 13/16" O.D. stud
141041		
401006	1 Hex nut / Tuerca hexagonal / Écrou hexagonal	3/8" x 24 UNF thread
401376	2 Retainer (washer) / Seguro (arandala) / Arrêt (rondelle)	3/8 in. I.D. x 1-3/8 in. O.D. x .089 in. thick
404652	2 Bushing / Anillo / Bague	Used with 5/8" dia. hole or 7/8" dia. Hole
141045		
401006	1 Hex nut / Tuerca hexagonal / Écrou hexagonal	3/8" x 24 UNF thread
401377	1 Retainer (washer) / Seguro (arandala) / Arrêt (rondelle)	1/2" I.D. x 1-3/8" O.D. x .075" thick
401383	1 Retainer (washer) / Seguro (arandala) / Arrêt (rondelle)	3/8 in. I.D. x 1-1/2 in. O.D. x .093 in. thick
402284	2 Bushing / Anillo / Bague	5/8" centering lip for 3/8" O.D. stud
141047		
401006	1 Hex nut / Tuerca hexagonal / Écrou hexagonal	3/8" x 24 UNF thread
401164	1 Hex nut / Tuerca hexagonal / Écrou hexagonal	1/2" x 20 UNF Thread
401166	1 Lock washer / Arandela de freno / Rondelle-frein	1/2" lock washer
401184	1 Lock washer / Arandela de freno / Rondelle-frein	7/16" Lock washer
402844	1 Hex nut / Tuerca hexagonal / Écrou hexagonal	7/16" x 20 UNF Thread
402943	1 Retainer (washer) / Seguro (arandala) / Arrêt (rondelle)	0.457" I.D. x 1.68" O.D. x .120" thick
403298	1 Retainer (washer) / Seguro (arandala) / Arrêt (rondelle)	0.390" I.D. x 1.68" O.D. x .120" thick
403299	2 Bushing / Anillo / Bague	7/8" centering lip for 7/16" O.D. stud
403877	1 Stud / Pasador / Goujon	1/2" x 20 and 7/16" x 20
403878	1 Washer / Arandela / Rondelle	0.453" I.D. x 1.25" O.D. x .075" thick
141083		
401193	1 Lock washer / Arandela de freno / Rondelle-frein	5/8" I.D. (thin)
404451	1 Hex nut / Tuerca hexagonal / Écrou hexagonal	16 x 1.5 metric thread
404452	2 Retainer (washer) / Seguro (arandala) / Arrêt (rondelle)	5/8" I.D. x 2-3/4" O.D. x .180" thick
404453	1 Sleeve / Manguito / Manchon	16 mm I.D. x 1-3/16" O.D. x 1-1/2" long
404454	2 Bushing / Anillo / Bague	1-3/16" centering lip for 13/16" O.D. stud
141108		
401174	2 Hex nut / Tuerca hexagonal / Écrou hexagonal	5/8" x 18 thread
405360	4 Retainer (washer) / Seguro (arandala) / Arrêt (rondelle)	5/8" I.D. x 2-3/16" O.D. x .120" thick
405361-000	4 Bushing / Anillo / Bague	1" centering lip for 5/8" O.D. stud (1.00" thick)
141137		
402812	1 Sleeve / Manguito / Manchon	13 mm I.D. x 5/8 in. O.D. x 1-5/16 in. long

MOUNTING ACCESSORY PACKAGES AND COMPONENT PARTS

PAQUETES DE ACCESORIOS DE MONTAJE Y PIEZAS COMPONENTES ENSEMBLES D'ACCESSOIRES DE MONTURES ET DE PIÈCES DÉTACHÉES

141138			
401006	2	Hex nut / Tuerca hexagonal / Écrou hexagonal	3/8" x 24 UNF thread
403489	4	Bushing / Anillo / Bague	5/8" centering lip for 3/8" O.D. stud
403575	4	Retainer (washer) / Seguro (arandala) / Arrêt (rondelle)	25/64" I.D. x 1-1/4" O.D. x .12" thick
404949	4	Washer / Arandela / Rondelle	1/2" I.D. x 1-1/2" O.D. x .04" thick
141168			
401006	1	Hex nut / Tuerca hexagonal / Écrou hexagonal	3/8" x 24 UNF thread
401008	1	Retainer (washer) / Seguro (arandala) / Arrêt (rondelle)	3/8 in. I.D. x 1-1/4 in. O.D. x .075 in. thick
404350	1	Retainer (washer) / Seguro (arandala) / Arrêt (rondelle)	3/8 in. I.D. x 1-5/8 in. O.D. x .119 in. thick
404985	1	Bushing / Anillo / Bague	5/8" centering lip for 3/8" O.D. stud
404986	1	Bushing / Anillo / Bague	5/8" centering lip for 3/8" O.D. stud
429680-015	1	Instruction sheet / Hoja de direc. / Feuillet d'instr.	
141247			
401174	1	Hex nut / Tuerca hexagonal / Écrou hexagonal	5/8" x 18 thread
401754	2	Bushing / Anillo / Bague	EB3 - style for 2.39 in. O.D. eye ring - 1" diam. Stud
405360	2	Retainer (washer) / Seguro (arandala) / Arrêt (rondelle)	5/8" I.D. x 2-3/16" O.D. x .120" thick
405361	2	Bushing / Anillo / Bague	1" centering lip for 5/8" O.D. stud
141349			
401006	1	Hex nut / Tuerca hexagonal / Écrou hexagonal	3/8" x 24 UNF thread
401007	1	Pal nut / Tuerca Pal / Écrou Pal	3/8" x 24 UNF thread
401376	2	Retainer (washer) / Seguro (arandala) / Arrêt (rondelle)	3/8 in. I.D. x 1-3/8 in. O.D. x .089 in. thick
404652	2	Bushing / Anillo / Bague	Used with 5/8" dia. hole or 7/8" dia. Hole
429680-030	1	Instruction sheet / Hoja de direc. / Feuillet d'instr.	
141350			
401006	1	Hex nut / Tuerca hexagonal / Écrou hexagonal	3/8" x 24 UNF thread
401376	2	Retainer (washer) / Seguro (arandala) / Arrêt (rondelle)	3/8 in. I.D. x 1-3/8 in. O.D. x .089 in. thick
402294	2	Bushing / Anillo / Bague	5/8" lip for 3/8" dia. stud-5/8" or 7/8" holes
411520	1	Jam nut / Contratuercas / Contre-Écrou	3/8" x 24 UNF thread
141353			
401006	1	Hex nut / Tuerca hexagonal / Écrou hexagonal	3/8" x 24 UNF thread
401007	1	Jam nut / Contratuercas / Contre-Écrou	3/8" x 24 UNF thread
401383	2	Retainer (washer) / Seguro (arandala) / Arrêt (rondelle)	3/8 in. I.D. x 1-1/2 in. O.D. x .093 in. thick
402263	2	Bushing / Anillo / Bague	7/8" centering lip for 3/8" O.D. stud
141354			
401006	1	Hex nut / Tuerca hexagonal / Écrou hexagonal	3/8" x 24 UNF thread
401007	1	Pal nut / Tuerca Pal / Écrou Pal	3/8" x 24 UNF thread
404350	1	Retainer (washer) / Seguro (arandala) / Arrêt (rondelle)	3/8 in. I.D. x 1-5/8 in. O.D. x .119 in. thick
404485	1	Retainer (washer) / Seguro (arandala) / Arrêt (rondelle)	0.453" I.D. x 1.63" O.D. x 0.120" thick
404959	2	Bushing / Anillo / Bague	3/4" centering lip for 7/16" O.D. stud
141356			
401006	1	Hex nut / Tuerca hexagonal / Écrou hexagonal	3/8" x 24 UNF thread
401007	1	Pal nut / Tuerca Pal / Écrou Pal	3/8" x 24 UNF thread
401008	2	Retainer (washer) / Seguro (arandala) / Arrêt (rondelle)	3/8 in. I.D. x 1-1/4 in. O.D. x .075 in. thick
403962	2	Bushing / Anillo / Bague	1/2" centering lip for 3/8" O.D. stud
141368			
401006	1	Hex nut / Tuerca hexagonal / Écrou hexagonal	3/8" x 24 UNF thread
401007	1	Jam nut / Contratuercas / Contre-Écrou	3/8" x 24 UNF thread
401008	1	Retainer (washer) / Seguro (arandala) / Arrêt (rondelle)	3/8 in. I.D. x 1-1/4 in. O.D. x .075 in. thick
401383	1	Retainer (washer) / Seguro (arandala) / Arrêt (rondelle)	3/8 in. I.D. x 1-1/2 in. O.D. x .093 in. thick
403489	2	Bushing / Anillo / Bague	5/8" centering lip for 3/8" O.D. stud
429680-030	1	Instruction sheet / Hoja de direc. / Feuillet d'instr.	
141376			
401006	1	Hex nut / Tuerca hexagonal / Écrou hexagonal	3/8 in.-24 thread
401007	1	Pal nut / Tuerca Pal / Écrou Pal	3/8" x 24 UNF thread
401008	2	Retainer (washer) / Seguro (arandala) / Arrêt (rondelle)	3/8 in. I.D. x 1-1/4 in. O.D. x .075 in. thick
403489	2	Bushing / Anillo / Bague	5/8" centering lip for 3/8" O.D. stud

MOUNTING ACCESSORY PACKAGES AND COMPONENT PARTS

PAQUETES DE ACCESORIOS DE MONTAJE Y PIEZAS COMPONENTES ENSEMBLES D'ACCESSOIRES DE MONTURES ET DE PIÈCES DÉTACHÉES

141439			
401011	2	Bushing / Anillo / Bague	EB2 style - for 1-3/4" O.D. eye ring - 3/4" diam. Stud
411165	1	Lock nut / Contratuerca / Contre-Écrou	12 x 1.25 metric thread
411445	2	Bushing / Anillo / Bague	Flat Bushing for 9/16" O.D. stud
411446	2	Retainer (washer) / Seguro (arandala) / Arrêt (rondelle)	3/4" I.D. x 1 7/8" O.D. x .047" thick
411447	1	Retainer (washer) / Seguro (arandala) / Arrêt (rondelle)	9/16" I.D. x 1-3/4" O.D. x .087" thick
412554	1	Retainer (washer) / Seguro (arandala) / Arrêt (rondelle)	0.485" O.D x 1.76" O.D. x .089" thick
141448			
404715	1	Spacer / Tirante / Entretoise	0.737" I.D x 1.75" O.D. x .120 thick
411165	1	Lock nut / Contratuerca / Contre-Écrou	12 x 1.25 metric thread
411445	2	Bushing / Anillo / Bague	Flat Bushing for 9/16" O.D. stud
411446	1	Retainer (washer) / Seguro (arandala) / Arrêt (rondelle)	3/4" I.D. x 1 7/8" O.D. x .047" thick
411447	1	Washer / Arandela / Rondelle	9/16" I.D. x 1-3/4" O.D. x .087" thick
412554	1	Retainer (washer) / Seguro (arandala) / Arrêt (rondelle)	0.485" O.D x 1.76" O.D. x .089" thick
141514			
401006	1	Hex nut / Tuerca hexagonal / Écrou hexagonal	3/8" x 24 UNF thread
401007	1	Pal nut / Tuerca Pal / Écrou Pal	3/8" x 24 UNF thread
401383	2	Retainer (washer) / Seguro (arandala) / Arrêt (rondelle)	3/8 in. I.D. x 1-1/2 in. O.D. x .093 in. thick
404947	2	Bushing / Anillo / Bague	3/8 in. I.D. x 1-3/16 in. x 9/16 in. thick
141537			
401006	1	Hex nut / Tuerca hexagonal / Écrou hexagonal	3/8" x 24 UNF thread
404350	2	Retainer (washer) / Seguro (arandala) / Arrêt (rondelle)	3/8 in. I.D. x 1-5/8 in. O.D. x .119 in. thick
404985	2	Bushing / Anillo / Bague	5/8" centering lip for 3/8" O.D. stud
141665			
401006	1	Hex nut / Tuerca hexagonal / Écrou hexagonal	3/8" x 24 UNF thread
402943	1	Retainer (washer) / Seguro (arandala) / Arrêt (rondelle)	0.457" I.D. x 1.68" O.D. x .120" thick
403298	1	Retainer (washer) / Seguro (arandala) / Arrêt (rondelle)	0.390" I.D. x 1.68" O.D. x .120" thick
404959	2	Bushing / Anillo / Bague	3/4" centering lip for 7/16" O.D. stud
411520	1	Jam nut / Contratuerca / Contre-Écrou	3/8" x 24 UNF thread
142036			
411497	1	Lock nut / Contratuerca / Contre-Écrou	10 x 1.25 metric thread
142069			
411165	2	Lock nut / Contratuerca / Contre-Écrou	12 x 1.25 metric thread
411447	2	Washer / Arandela / Rondelle	9/16" I.D. x 1-3/4" O.D. x .087" thick
412103	2	Retainer (washer) / Seguro (arandala) / Arrêt (rondelle)	9/16" I.D. x 1-3/4" O.D. x 1/4" thick
412116	4	Bushing / Anillo / Bague	Flat bushing for 9/16" O.D. Stud
412554	2	Retainer (washer) / Seguro (arandala) / Arrêt (rondelle)	0.485" O.D x 1.76" O.D. x .089" thick
142095			
411165	1	Lock nut / Contratuerca / Contre-Écrou	12 x 1.25 metric thread
411447	2	Retainer (washer) / Seguro (arandala) / Arrêt (rondelle)	9/16" I.D. x 1-3/4" O.D. x .087" thick
412103	1	Retainer (washer) / Seguro (arandala) / Arrêt (rondelle)	9/16" I.D. x 1-3/4" O.D. x 1/4" thick
412116	2	Bushing / Anillo / Bague	Flat bushing for 9/16" O.D. Stud
142280			
411633	2	Bushing / Anillo / Bague	0.810" centering lip for 7/16" O.D. stud
411672	1	Retainer (washer) / Seguro (arandala) / Arrêt (rondelle)	0.410" I.D. x 2.05" O.D. x 0.175" thick
412046	1	Lock nut / Contratuerca / Contre-Écrou	10 x 1.5 metric thread
412479	1	Retainer (washer) / Seguro (arandala) / Arrêt (rondelle)	0.490" I.D. x 2.15" O.D. x 0.180" thick
142389			
404287	2	Retainer (washer) / Seguro (arandala) / Arrêt (rondelle)	0.453" I.D x 1.50" O.D x 0.090" thick
404947	2	Bushing / Anillo / Bague	For 3/8" O.D. stud- no centering lip
411497	1	Lock nut / Contratuerca / Contre-Écrou	10 x 1.25 metric thread
142592			
402539	2	Bolt / Tornillo / Boulon	5/16" x 24 UNF thread x 1" long
402573	2	Nut / Tuerca / Écrou	5/16" x 24 UNF thread
402653	2	Lock washer / Arandala de freno / Rondelle-frein	5/16" Lock washer
411385	2	Retainer (washer) / Seguro (arandala) / Arrêt (rondelle)	0.355" I.D x 0.74" O.D. x 0.075" thick

MOUNTING ACCESSORY PACKAGES AND COMPONENT PARTS

PAQUETES DE ACCESORIOS DE MONTAJE Y PIEZAS COMPONENTES ENSEMBLES D'ACCESSOIRES DE MONTURES ET DE PIÈCES DÉTACHÉES

142615			
401006	1	Hex nut / Tuerca hexagonal / Écrou hexagonal	3/8" x 24 UNF thread
401376	1	Retainer (washer) / Seguro (arandala) / Arrêt (rondelle)	3/8 in. I.D. x 1-3/8 in. O.D. x .089 in. thick
402943	1	Retainer (washer) / Seguro (arandala) / Arrêt (rondelle)	0.457" I.D. x 1.68" O.D. x .120" thick
404652	2	Bushing / Anillo / Bague	Used with 5/8" dia. hole or 7/8" dia. Hole
142617			
401006	1	Hex nut / Tuerca hexagonal / Écrou hexagonal	3/8" x 24 UNF thread
402943	1	Retainer (washer) / Seguro (arandala) / Arrêt (rondelle)	0.457" I.D. x 1.68" O.D. x .120" thick
403298	1	Retainer (washer) / Seguro (arandala) / Arrêt (rondelle)	0.390" I.D. x 1.68" O.D. x .120" thick
412661	2	Bushing / Anillo / Bague	0.790" centering lip for 7/16" O.D. stud
142656			
411165	1	Lock nut / Contratuerca / Contre-Écrou	12 x 1.25 metric thread
411446	1	Retainer (washer) / Seguro (arandala) / Arrêt (rondelle)	3/4" I.D. x 1 7/8" O.D. x .047" thick
411447	1	Retainer (washer) / Seguro (arandala) / Arrêt (rondelle)	9/16" I.D. x 1-3/4" O.D. x .087" thick
412103	1	Retainer (washer) / Seguro (arandala) / Arrêt (rondelle)	9/16" I.D. x 1-3/4" O.D. x 1/4" thick
412116	2	Bushing / Anillo / Bague	Flat bushing for 9/16" O.D. Stud
412554	1	Retainer (washer) / Seguro (arandala) / Arrêt (rondelle)	0.485" O.D x 1.76" O.D. x .089" thick
142657			
411165	2	Lock nut / Contratuerca / Contre-Écrou	12 x 1.25 metric thread
411446	2	Retainer (washer) / Seguro (arandala) / Arrêt (rondelle)	3/4" I.D. x 1 7/8" O.D. x .047" thick
411447	2	Retainer (washer) / Seguro (arandala) / Arrêt (rondelle)	9/16" I.D. x 1-3/4" O.D. x .087" thick
412103	2	Retainer (washer) / Seguro (arandala) / Arrêt (rondelle)	9/16" I.D. x 1-3/4" O.D. x 1/4" thick
412116	4	Bushing / Anillo / Bague	Flat bushing for 9/16" O.D. Stud
412554	2	Retainer (washer) / Seguro (arandala) / Arrêt (rondelle)	0.485" O.D x 1.76" O.D. x .089" thick
142700			
401006	1	Hex nut / Tuerca hexagonal / Écrou hexagonal	3/8" x 24 UNF thread
402943	1	Retainer (washer) / Seguro (arandala) / Arrêt (rondelle)	0.457" I.D. x 1.68" O.D. x .120" thick
403298	1	Retainer (washer) / Seguro (arandala) / Arrêt (rondelle)	0.390" I.D. x 1.68" O.D. x .120" thick
404959	2	Bushing / Anillo / Bague	3/4" centering lip for 7/16" O.D. stud
411520	1	Jam nut / Contratuerca / Contre-Écrou	3/8" x 24 UNF thread
412682	1	Sleeve / Manguito / Manchon	0.479" I.D. x 0.548" O.D. x 1.48" long
429680-008	1	Instruction sheet / Hoja de direc. / Feuillet d'instr.	
142731			
411165	1	Lock nut / Contratuerca / Contre-Écrou	12 x 1.25 metric thread
411447	1	Retainer (washer) / Seguro (arandala) / Arrêt (rondelle)	9/16" I.D. x 1-3/4" O.D. x .087" thick
412554	1	Retainer (washer) / Seguro (arandala) / Arrêt (rondelle)	0.485" O.D x 1.76" O.D. x .089" thick
412675	2	Bushing / Anillo / Bague	0.950" centering lip for 9/16" O.D. stud
142973			
411633	2	Bushing / Anillo / Bague	0.810" centering lip for 7/16" O.D. stud
411672	1	Retainer (washer) / Seguro (arandala) / Arrêt (rondelle)	0.410" I.D. x 2.05" O.D. x 0.175" thick
412046	1	Lock nut / Contratuerca / Contre-Écrou	10 x 1.5 metric thread
412479	1	Retainer (washer) / Seguro (arandala) / Arrêt (rondelle)	0.490" I.D. x 2.15" O.D. x 0.180" thick
142976			
401174	1	Hex nut / Tuerca hexagonal / Écrou hexagonal	5/8" x 18 thread
405360	2	Retainer (washer) / Seguro (arandala) / Arrêt (rondelle)	5/8" I.D. x 2-3/16" O.D. x .120" thick
405361-000	2	Bushing / Anillo / Bague	1" centering lip for 5/8" O.D. stud (1.00" thick)
429680-031	1	Instruction sheet / Hoja de direc. / Feuillet d'instr.	
142998			
404452	2	Retainer (washer) / Seguro (arandala) / Arrêt (rondelle)	5/8" I.D. x 2-3/4" O.D. x .180" thick
404454	2	Bushing / Anillo / Bague	1-3/16" centering lip for 13/16" O.D. stud
405862	1	Self locking nut / Tuerca de secur. / Écrou indesserrable	5/8" x 18 thread
412872	1	Sleeve / Manguito / Manchon	0.643" I.D. x .815" O.D. x 1.44" long

MOUNTING ACCESSORY PACKAGES AND COMPONENT PARTS

PAQUETES DE ACCESORIOS DE MONTAJE Y PIEZAS COMPONENTES ENSEMBLES D'ACCESSOIRES DE MONTURES ET DE PIÈCES DÉTACHÉES

143000			
404695	1	Retainer (washer) / Seguro (arandala) / Arrêt (rondelle)	0.709" centering lip x 1.97" O.D. x .060" thick
404715	1	Spacer / Tirante / Entretoise	0.737" I.D. x 1.75" O.D. x .120 thick
411165	1	Lock nut / Contratuerca / Contre-Écrou	12 x 1.25 metric thread
411447	1	Retainer (washer) / Seguro (arandala) / Arrêt (rondelle)	9/16" I.D. x 1-3/4" O.D. x .087" thick
412116	2	Bushing / Anillo / Bague	Flat bushing for 9/16" O.D. Stud
412554	1	Retainer (washer) / Seguro (arandala) / Arrêt (rondelle)	0.485" O.D. x 1.76" O.D. x .089" thick
429680-033	1	Instruction sheet / Hoja de direc. / Feuillet d'instr.	
143078			
401006	1	Hex nut / Tuerca hexagonal / Écrou hexagonal	3/8" x 24 UNF thread
404969	1	Sleeve / Manguito / Manchon	0.400" I.D. x .620" O.D. x 1.48" long
412554	2	Retainer (washer) / Seguro (arandala) / Arrêt (rondelle)	0.485" O.D. x 1.76" O.D. x .089" thick
412675	2	Bushing / Anillo / Bague	0.950" centering lip for 9/16" O.D. stud
143146			
411165	1	Lock nut / Contratuerca / Contre-Écrou	12 x 1.25 metric thread
411447	2	Retainer (washer) / Seguro (arandala) / Arrêt (rondelle)	9/16" I.D. x 1-3/4" O.D. x .087" thick
412675	2	Bushing / Anillo / Bague	0.950" centering lip for 9/16" O.D. stud
145054			
401174	1	Hex nut / Tuerca hexagonal / Écrou hexagonal	5/8 in. - 18 thread
401175	1	Lock washer / Contratuerca / Contre-Écrou	
405360	2	Retainer (washer) / Seguro (arandala) / Arrêt (rondelle)	5/8" I.D. x 2-3/16" O.D. x .120" thick
405361-000	2	Bushing / Anillo / Bague	1" centering lip for 5/8" O.D. stud (1.00" thick)
145075			
401750	1	Retainer (washer) / Seguro (arandala) / Arrêt (rondelle)	3/4" I.D. x 2-3/8" O.D. x .105" thick
401752	1	Retainer (washer) / Seguro (arandala) / Arrêt (rondelle)	1" I.D. x 2-3/8" O.D. x .105" thick
401754	2	Bushing / Anillo / Bague	EB3 - style for 2.39 in. O.D. eye ring - 1" diam. Stud
405360	2	Retainer (washer) / Seguro (arandala) / Arrêt (rondelle)	5/8" I.D. x 2-3/16" O.D. x .120" thick
405361-000	2	Bushing / Anillo / Bague	1" centering lip for 5/8" O.D. stud (1.00" thick)
145080			
401011	2	Bushing / Anillo / Bague	EB2 style - for 1-3/4" O.D. eye ring - 3/4" diam. Stud
401429	1	Retainer (washer) / Seguro (arandala) / Arrêt (rondelle)	1/2" I.D. x 1-5/8" O.D. x .090" thick
401430	1	Retainer (washer) / Seguro (arandala) / Arrêt (rondelle)	3/4" I.D. x 1-5/8" O.D. x .090" thick
145089-000			
405360	2	Retainer (washer) / Seguro (arandala) / Arrêt (rondelle)	5/8" I.D. x 2-3/16" O.D. x .120" thick
405361-000	2	Bushing / Anillo / Bague	1" centering lip for 5/8" O.D. stud (1.00" thick)
405862	1	Self locking nut / Tuerca de secur. / Écrou indesserrable	5/8" x 18 thread
145089-200			
405360	2	Retainer (washer) / Seguro (arandala) / Arrêt (rondelle)	5/8" I.D. x 2-3/16" O.D. x .120" thick
405361-100	2	Bushing / Anillo / Bague	1" centering lip for 5/8" O.D. stud (0.75" thick)
415196-001	1	Nylon lock nut / Contratuerca / Contre-Écrou	5/8" x 18 thread
145090			
404276	1	Instruction sheet / Hoja de direc. / Feuillet d'instr.	
405643	1	Sleeve / Manguito / Manchon	0.645" I.D. x .795" O.D. x 2.00" long
405859	2	Bushing / Anillo / Bague	1.15" centering lip x .815" I.D.
405860	2	Retainer (washer) / Seguro (arandala) / Arrêt (rondelle)	5/8" I.D. x 2-3/4" O.D. x .180" thick
405862	1	Self locking nut / Tuerca de secur. / Écrou indesserrable	5/8" x 18 thread
145093			
401750	2	Retainer (washer) / Seguro (arandala) / Arrêt (rondelle)	3/4" I.D. x 2-3/8" O.D. x .105" thick
401752	2	Retainer (washer) / Seguro (arandala) / Arrêt (rondelle)	1" I.D. x 2-3/8" O.D. x .105" thick
401754	4	Bushing / Anillo / Bague	2.39" O.D. eye ring - 1" diam. Stud
145099			
401174	1	Hex nut / Tuerca hexagonal / Écrou hexagonal	5/8" x 18 thread
401175	1	Lock washer / Arandala de freno / Rondelle-frein	
401754	2	Bushing / Anillo / Bague	EB3 - style for 2.39 in. O.D. eye ring - 1" diam. Stud
405360	2	Retainer (washer) / Seguro (arandala) / Arrêt (rondelle)	5/8" I.D. x 2-3/16" O.D. x .120" thick
405361-000	2	Bushing / Anillo / Bague	1" centering lip for 5/8" O.D. stud (1.00" thick)
424274	1	Instruction sheet / Hoja de direc. / Feuillet d'instr.	

MOUNTING ACCESSORY PACKAGES AND COMPONENT PARTS

PAQUETES DE ACCESORIOS DE MONTAJE Y PIEZAS COMPONENTES ENSEMBLES D'ACCESSOIRES DE MONTURES ET DE PIÈCES DÉTACHÉES

145112			
401164	1	Hex nut / Tuerca hexagonal / Écrou hexagonal	1/2" x 20 UNF Thread
401165	1	Lock washer / Arandala de freno / Rondelle-frein	1/2" lock washer
405360	1	Retainer (washer) / Seguro (arandala) / Arrêt (rondelle)	5/8" I.D. x 2-3/16" O.D. x .120" thick
405361-000	2	Bushing / Anillo / Bague	1" centering lip for 5/8" O.D. stud (1.00" thick)
405934	1	Retainer (washer) / Seguro (arandala) / Arrêt (rondelle)	0.530" I.D. x 2-3/16" O.D. x .120" thick
145116			
401750	1	Retainer (washer) / Seguro (arandala) / Arrêt (rondelle)	3/4" I.D. x 2-3/8" O.D. x .105" thick
401752	1	Retainer (washer) / Seguro (arandala) / Arrêt (rondelle)	1" I.D. x 2-3/8" O.D. x .105" thick
415169	2	Bushing / Anillo / Bague (Durometer 80)	EB3 - style for 2.39 in. O.D. eye ring - 1" diam. Stud
145123			
405360	2	Retainer (washer) / Seguro (arandala) / Arrêt (rondelle)	5/8" I.D. x 2-3/16" O.D. x .120" thick
405862	1	Self locking nut / Tuerca de secur. / Écrou indesserrable	5/8" x 18 thread
415017-001	2	Bushing / Anillo / Bague	1" centering lip for a 5/8" O.D. stud
145126			
401750	2	Retainer (washer) / Seguro (arandala) / Arrêt (rondelle)	3/4" I.D. x 2-3/8" O.D. x .105" thick
401754	2	Bushing / Anillo / Bague	EB3 - style for 2.39 in. O.D. eye ring - 1" diam. Stud
403752	1	Sleeve / Manguito / Manchon	3/4" I.D. x 15/16" O.D. x 1-3/4" long
415277	1	Spacer / Tirante / Entretoise	1-3/16" I.D. x 1-1/4" O.D. x .200" thick
424281	1	Instruction sheet / Hoja de direc. / Feuillet d'instr.	
145128			
405360	2	Retainer (washer) / Seguro (arandala) / Arrêt (rondelle)	5/8" I.D. x 2-3/16" O.D. x .120" thick
405361-000	2	Bushing / Anillo / Bague	1" centering lip for 5/8" O.D. stud (1.00" thick)
415196-001	1	Nylon locknut / Contratuerca nylon / Contre-Écrou nylon	5/8" x 18 thread
145132			
415305-000	2	Rubber spacer / Tirante de goma / Entretoise de caout.	0.910" I.D. x 1.58" O.D. x 1.1" long
415305-001	2	Rubber spacer / Tirante de goma / Entretoise de caout.	0.910" I.D. x 1.58" O.D. x 0.427" long
424282	1	Instruction sheet / Hoja de direc. / Feuillet d'instr.	
145140			
405360	2	Retainer (washer) / Seguro (arandala) / Arrêt (rondelle)	5/8" I.D. x 2-3/16" O.D. x .120" thick
405862	1	Self locking nut / Tuerca de secur. / Écrou indesserrable	5/8" x 18 thread
415326-001	2	Urethane bushing / Anillo uretano / Bague urÉthane	1" centering lip for 5/8" O.D. stud (replacing Bushing P/N 415017)
145143			
415305-001	2	Rubber spacer / Tirante de goma / Entretoise de caout.	0.910" I.D. x 1.58" O.D. x 0.427" long
424284	1	Instruction sheet / Hoja de direc. / Feuillet d'instr.	
145144			
415305-000	2	Rubber spacer / Tirante de goma / Entretoise de caout.	0.910" I.D. x 1.58" O.D. x 1.1" long
424284	1	Instruction sheet / Hoja de direc. / Feuillet d'instr.	
145147			
401429	1	Retainer (washer) / Seguro (arandala) / Arrêt (rondelle)	1/2" I.D. x 1-5/8" O.D. x .090" thick
401430	1	Retainer (washer) / Seguro (arandala) / Arrêt (rondelle)	3/4" I.D. x 1-5/8" O.D. x .090" thick
145148			
401750	1	Retainer (washer) / Seguro (arandala) / Arrêt (rondelle)	3/4" I.D. x 2-3/8" O.D. x .105" thick
401752	1	Retainer (washer) / Seguro (arandala) / Arrêt (rondelle)	1" I.D. x 2-3/8" O.D. x .105" thick
145149			
401265	1	Retainer (washer) / Seguro (arandala) / Arrêt (rondelle)	1/2" I.D. x 1-1/4" O.D. x .075" thick
401266	1	Retainer (washer) / Seguro (arandala) / Arrêt (rondelle)	5/8" I.D. x 1-1/4" O.D. x .075" thick
401011			
	1	Bushing / Anillo / Bague	EB2 style - for 1-3/4" O.D. eye ring - 3/4" diam. Stud
401754			
	1	Bushing / Anillo / Bague	EB3 - style for 2.39 in. O.D. eye ring - 1" diam. Stud
404702			
	1	Bushing / Anillo / Bague	EB1 style - 1 pc Spool shaped bushing (5/8" I.D.)
405360			
	1	Retainer (washer) / Seguro (arandala) / Arrêt (rondelle)	5/8" I.D. x 2-3/16" O.D. x .120" thick

MOUNTING ACCESSORY PACKAGES AND COMPONENT PARTS

PAQUETES DE ACCESORIOS DE MONTAJE Y PIEZAS COMPONENTES ENSEMBLES D'ACCESSOIRES DE MONTURES ET DE PIÈCES DÉTACHÉES

405361-000	1 Bushing / Anillo / Bague	1" centering lip for 5/8" O.D. stud (1.00" thick)
415010-802	1 Sleeve / Manguito / Manchon	22 mm I.D. x 1.00" O.D. x 1-3/4" long
415015-001	1 Urethane bushing / Anillo uretano / Bague urÉthane	EB2 style for 1-3/4" O.D. eye ring - 3/4" diam. Stud
415017	1 Urethane bushing / Anillo uretano / Bague urÉthane	1" centering lip for 5/8" O.D. stud
415025-001	1 Urethane bushing / Anillo uretano / Bague urÉthane	EB2 style for 1-3/4" O.D. eye ring - 3/4" diam. Stud
415326-001	1 Urethane bushing / Anillo uretano / Bague urÉthane	1" centering lip for 5/8" O.D. stud (replacing Bushing P/N 415017)

Mounting Accessory Packages — Buyer's Guide

Conjuntos de accesorios de fijación - Guía del comprador

Ensemble d'accessoires pour la fixation — Guide de l'acheteur

140126	83027 G60011 G60017 G60024 G60043 G60078 G61881	140702	83303 83304 G60014 G60113 G60185	141247 (cont'd)	85703 85710 85711 87000 89424	143078	G61893 G61894 G61895 G61958 G62001 G61969	145090	85081 85316 85705 85706 85707 85708
		140719	G60161 G60222 G61114	141277 141349	G60098 G60091 G60105	143146 145054	83103 83106 83134 83136 83635 85009 85025 85026 85027 85049 85071 85080 85085★		85709 85722 85740★ 85935 87016 89426
140149	83200 83216 83219 83308 83309 83312 83314 85023 85024 85046 85047 89401 89402 89403 89409 89415 89416 89434 89435 G60103 G60128	140780	83018 83019 83041 83045 83050 83105 83114 83162★ G60023 G60026 G60038 G60041 G60071 G60073 G60076 G60114 G60158 G60162 G60171 G60181 G60184 G60330	141350	G60104 G60136 G60137 G60153 G61121 G61122 G60052 G60129 G61204 G60250 G60074 G60305 G60310 G60304 G60180 G60088 G60089 G60124 G60237 G60238 G61140 G60264 G61112 G61124 G61144			145093	85714 85715 85716 85717 85718 85719 83353 85033 89427 83162★ 85732 87016★
140169	85025 85031 G60091 G60119 G60177 G60251	140857 140884 140885 140921	G60303 G60031 G60003 G60154 G60269 G60070 G61889 G62004 G62005 G62006 G62007 G60122 G60033 G60072 83301 83317 83318 83613 85310 89423 89447 89455 G60042 G60101 G60255 G60002 G60046	141514 141665	G61140 G60264 G61112 G61124 G61144 G61884 G61885			145116	83110 83111 83112 83138 83142 83143 85065 85083 85332 85333 85727 85728 83120 85065 83140 83141 83159★ 85031 89446
140357	G60010 G60065	141041	G60070 G61889 G62004 G62005 G62006 G62007 G60122 G60033 G60072 83301 83317 83318 83613 85310 89423 89447 89455 G60042 G60101 G60255 G60002 G60046	142036 142280 142280 142389 142592 142615 142617 142656 142657 142700 142731	G61884 G61885 G60164 G61865 G61204 G60076 G60182 G60183 G60177 G60176 G60258 G61118 G60217 G60257 G60259 G61182 G61886 G62009 G62011 G62008 G61169 G61173 83456 G60205 G60216	145075 145080	85723 83107 85012 85054 85055 85062 85063 89408 89413 89438 89439 83102 83120 83154 85069 85319 85340★ 85341★ 85733 85970 89428 85936 85937 89456	145126 145128	85053 89442 83109 83110 83111 83112 83138 83142 83143 85065 85083 85332 85333 85727 85728 83120 85065 83140 83141 83159★ 85031 89446
140455	83003 83005 83014 83015 83400 G60049 G60354 G61139 G61860 G61862	141045 141047 141083	G60122 G60033 G60072 83301 83317 83318 83613 85310 89423 89447 89455 G60042 G60101 G60255 G60002 G60046	142389 142592 142615 142617 142656 142657 142700 142731	G60164 G61865 G61204 G60076 G60182 G60183 G60177 G60176 G60258 G61118 G60217 G60257 G60259 G61182 G61886 G62009 G62011 G62008 G61169 G61173 83456 G60205 G60216	145089-000	85723 83107 85012 85054 85055 85062 85063 89408 89413 89438 89439 83102 83120 83154 85069 85319 85340★ 85341★ 85733 85970 89428 85936 85937 89456	145140 145143 145144 145148 401011 401754	85727 85728 83120 85065 83140 83141 83159★ 85031 89446 83132 83214 83215 83217 83225 83362 85001 85004 85007 85040 85042 85057 85070 85300
140524	83161★ G60086 G60087 G60100 G60106 G60109 83161 G60165 G60194	141108 141137	83318 83613 85310 89423 89447 89455 G60042 G60101 G60255 G60002 G60046	142973 142976	G62008 G61169 G61173 83456 G60205 G60216	145089-200	85936 85937 89456		85042 85057 85070 85300
140526	630811	141138	G60002 G60046	142998	83456 G60205 G60216				85042 85057 85070 85300
140673	G60301 G60338	141247	85311 85312 85317	143000	G60205 G60216				85042 85057 85070 85300
140689	G60030		85312 85317		G60216				85070 85300

★ Will be available in first quarter of 2011.

Mounting Accessory Packages — Buyer's Guide

Conjuntos de accesorios de fijación - Guía del comprador

Ensemble d'accessoires pour la fixation — Guide de l'acheteur

401754	85301	401754	85329	401754	85729	401754	87001	404702	83001
(cont'd)	85302	(cont'd)	85334	(cont'd)	85730	(cont'd)	87002		83006
	85303		85339		85731		87003		83007
	85304		85376		85734		87004		83011
	85305		85700		85735		87006		83012
	85307		85702		85736		89410		83038
	85308		85703		85740★		89412		83047
	85313		85704		85901		89419		83117
	85314		85710		85905		89420		83161★
	85315		85711		85912		89422		83401
	85320		85712		85913		89425	405360	85727
	85322		85713		85915		89429	415010-802	83140
	85327		85720		85968★		89459★		83141

★ Will be available in first quarter of 2011.

Gabriel®

AMORTIGUADORES PARA CAMIONES,
SEMIRREMOLQUES Y AUTOBUSES



Índice

Acerca de los Amortiguadores Gabriel para Vehículos Comerciales	
Información de Producto	326
¿Cuándo Deben Cambiarse los Amortiguadores?.....	333
Instrucciones para Desechar Amortiguadores.....	336
Póliza de Garantía	337
Cambios de Catálogo	13
Lista de Aplicaciones	
Amortiguadores para Cabinas	14
Amortiguadores para Aplicaciones Especiales	21
(Estabilizadores de Dirección, Amortiguadores de Capó)	
Camionetas	23
Camiones Pesados y Medianos, Semirremolques y Autobuses	59
Lista por Números	
Amortiguadores para Aplicaciones Especiales	231
De Gas para Camionetas	231
Fleetline®.....	234
GasSLX®	242
Lista de Intercambiables	
Intercambiables con la Competencia	245
Intercambiables por equipo original	256
Intercambiables Fleetline® /GasSLX®	278
Intercambio de No. de Fabricante a No. de Catálogo	279
Cómo Determinar el Amortiguador Ideal para Su Camión	
Cómo Determinar la Serie/Cómo Medir las Dimensiones Externas	282
Cómo Identificar el Tipo de Soporte/Cómo Medir la Longitud Extendida y Colapsada.....	283
Cómo Determinar el Código de Montaje/los Diseños de Montaje Final Gabriel.....	284
Cómo Encontrar el Número de Parte/Especificaciones Correctos por Montaje Final.....	287
Especificaciones por Número de Parte	300
Paquetes de Accesorios de Montaje	
Listas de Partes de Componentes	313
Guía del Comprador.....	321
Sección en español	
Tabla de materias.....	324
Section française	
Table des matières.....	339

Gabriel®

AMORTIGUADORES PARA CAMIONES,
SEMIRREMOLQUES Y AUTOBUSES

Evolución hacia Amortiguadores de Desempeño Superior

Las demandas de desempeño cada vez más estrictas de los vehículos de hoy en día exigen amortiguadores que estén a la altura de tales desafíos.

Las suspensiones pesadas de hoja múltiple son de carrera muy limitada y su nivel de fricción inherente es alto. La suspensión de hoja múltiple amortigua rápidamente la oscilación de la suspensión, limitando la cantidad de trabajo que deben realizar los amortiguadores.

Las suspensiones de baja fricción de hoy en día, como las de Muelles Neumáticos y de Muelles Ahusados, están diseñadas para presentar muy escasa fricción de amortiguación de la suspensión y abundante carrera vertical. Estas características mejoran el control operativo y el desempeño de los vehículos actuales. Además, contribuyen a reducir la fatiga física para el conductor al aislar el equipo y su carga del daño generado por la vibración de la carretera.

En general, las suspensiones de baja fricción han aumentado la necesidad de controlar la oscilación de la suspensión, con lo cual, la importancia de que los amortiguadores sean de alto desempeño cobra cada vez mayor importancia.



Suspensión de Hoja Múltiple



La fricción inherente de amortiguación limita la carrera de la suspensión de 2 a 3".

Suspensión de Muelles Neumáticos



Suspensión de Hoja Ahusada



La carga de amortiguación ha sido desplazada a los amortiguadores. Estas suspensiones pueden tener una carrera de más de 9".

Gabriel®

AMORTIGUADORES PARA CAMIONES,
SEMIRREMOLQUES Y AUTOBUSES

GasSLX (Amortiguadores de Gas Ajustables para Camiones Pesados)

Serie 89000

Nuestros amortiguadores de gas ajustables premium para Camiones Pesados.

- Distintivo doble sello de Célula de Gas para máxima retención de gas
- Ajustable en tres posiciones, permite seleccionar el tipo de marcha en forma personalizada
- Su diámetro interior de 1-5/8", sus soportes de 360° soldados por arco en los extremos ofrecen mayor durabilidad
- Su fluido de Alta Temperatura especialmente formulado reduce la fricción y el desgaste en condiciones de operación extremas
- Muchas mejoras de componentes premium adicionales se combinan para ofrecer el máximo nivel de desempeño y durabilidad



FleetLine (Amortiguadores para Camiones Pesados)

Serie 83000*

Un producto para trabajo pesado, especialmente apto para camionetas o suspensiones de camiones pesados donde la distancia libre disponible es limitada.

- Diámetro interior de 1-3/8"
- Válvulas de 10 etapas

Serie 85000/85300*

Su mayor durabilidad hace de estas dos series el producto estándar de trabajo pesado para las suspensiones de baja fricción de la actualidad.

- Diámetro interior de 1-5/8" para mayor durabilidad
- Soportes de 360° soldados por arco en los extremos protegen contra ruptura del soporte en los extremos
- Tope de rebote hidráulico¹ evita que sufran daños el amortiguador y los componentes de montaje del vehículo
- Sello de vástago de pistón de labio múltiple que ofrece protección de resguardo para el sello
- Cierre soldado para máxima resistencia a la tracción



Serie 85700*

Diseñada para aplicaciones especiales en camiones y para aplicaciones de trabajo severo en autobuses. Las características especiales de esta serie aseguran una vida útil constante y prolongada.

- Su diámetro interior de 1-5/8" con diseño abultado ofrece mayor capacidad de fluido para una operación a más bajas temperaturas
- Su material de sello de vástago patentado aumenta notablemente la vida útil del sello
- Su Fluido de Alta Temperatura especialmente mezclado reduce la fricción y el desgaste en condiciones de operación extremas
- Además, todas las características especializadas propias de las Series 85000 y 85300



* Su sello de pistón autocompensante ofrece una amortiguación constante a lo largo de toda la vida útil del amortiguador

¹ Si es necesario

Gabriel®

AMORTIGUADORES PARA CAMIONES,
SEMIRREMOLQUES Y AUTOBUSES

Amortiguadores FleetLine para Cabinas

Amortiguadores para Cabinas

Diseñados específicamente para eliminar la vibración en la cabina.

- Sus diámetros interiores de 1", 1-3/16", 1-3/8", 1-5/8" ofrecen suspensión personalizada para diferentes diseños de cabinas
- Su diseño exclusivo de Celda de Gas³ reduce el desvanecimiento gracias a la aeración del fluido
- Sus exclusivas válvulas de 10 etapas ofrecen una marcha constante a cualquier velocidad
- Vástago de pistón cromado premium, resistente a la corrosión y que reduce el desgaste del sello del vástago
- Sello de vástago de pistón de labio múltiple ofrece protección de resguardo para el sello y mayor durabilidad



1
AÑO
DE GARANTÍA
SIN LÍMITE
DE MILLAS

De Gas para Camionetas

Serie G6000

Para un desempeño constante y confiable.

Diseñado para aplicaciones estándar en camionetas y vans.

- Diámetro interior de 1-3/8"
- Amortiguadores de gas
- Sello de vástago de pistón y de labio radial
- Sólo aplicaciones no comerciales



1
AÑO
25,000 MILLAS
DE GARANTÍA

Estabilizadores de Dirección

- Soportes reforzados, soldados por arco en los extremos, protegen contra ruptura del soporte en los extremos y ofrecen mayor durabilidad
- Su exclusivo diseño de Celda de Gas separa el aire y el aceite para que el amortiguador funcione correctamente en la posición horizontal
- Soportes diseñados especialmente (estilo equipo original) para mejor acoplamiento y mayor durabilidad

Amortiguadores diseñados con el mismo enfoque de calidad, diseño, longevidad y resistencia que ha venido a caracterizar a nuestros amortiguadores de Equipo Original de renombre mundial.

³ Si el diseño lo permite

Gabriel®

AMORTIGUADORES PARA CAMIONES,
SEMIRREMOLQUES Y AUTOBUSES

Amortiguadores FleetLine para Cabinas¹

Diseñados específicamente para eliminar la vibración en la cabina.
"Ver la lista de aplicaciones específicas en las páginas 14 a 18".



- Su exclusivo diseño de CELDA DE GAS² reduce el desvanecimiento
- Sus exclusivas válvulas de 10 etapas ofrecen un control constante a cualquier velocidad
- Vástago de pistón cromado premium, resistente a la corrosión y que reduce el desgaste del sello del vástago
- Sello de vástago de pistón de labio múltiple de goma de nitrilo para mayor durabilidad
- El fluido de amortiguador para todo clima mantiene al amortiguador funcionando normalmente a temperaturas extremas

¹ Sólo para aplicaciones en camiones

² Si el diseño lo permite

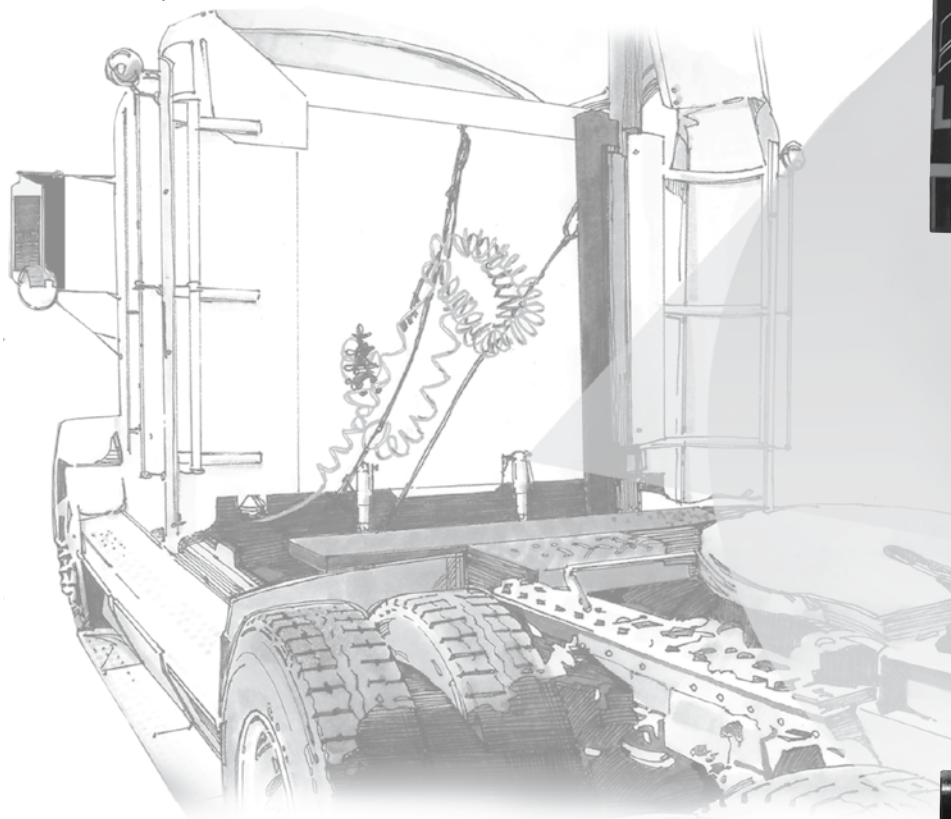

Gabriel®

AMORTIGUADORES PARA CAMIONES,
SEMIRREMOLQUES Y AUTOBUSES

GasSLX – ¡Lo máximo en "SLXción" de marcha!

- Los amortiguadores ajustables de tres posiciones GasSLX le permiten seleccionar una de 3 posiciones – Firme, Regular y Extrafirme.
- Firme – la más cercana al desempeño de marcha de equipo original
- Regular – una marcha más suave que la de un amortiguador de equipo original
- Extra firme – marcha más controlada

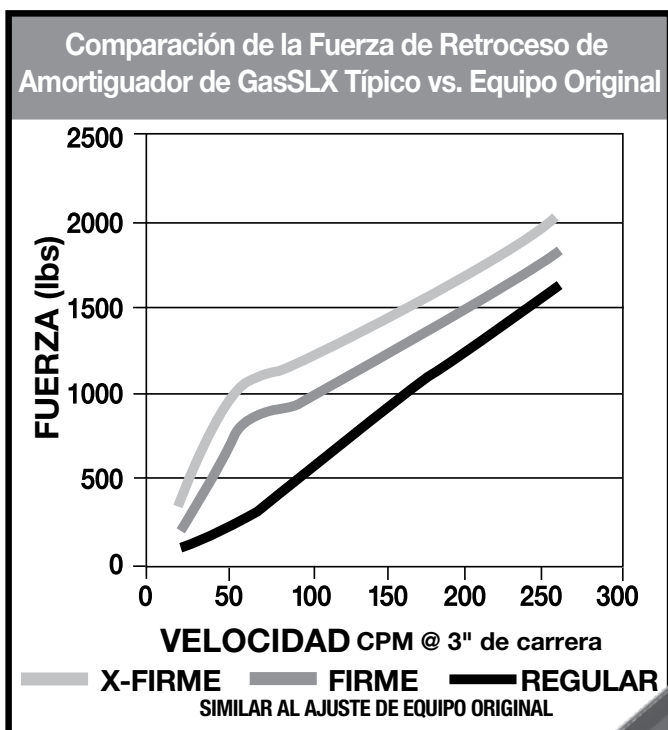

Gabriel®

AMORTIGUADORES PARA CAMIONES, SEMIRREMOLQUES Y AUTOBUSES

GasSLX – Amortiguador que ofrece confiabilidad, control, comodidad y selección de marcha

Creemos que una mejora premium, más que una promesa, es un compromiso que hay que cumplir. El amortiguador Gabriel GasSLX fue diseñado con componentes premium de eficacia comprobada para ofrecer beneficios notables.

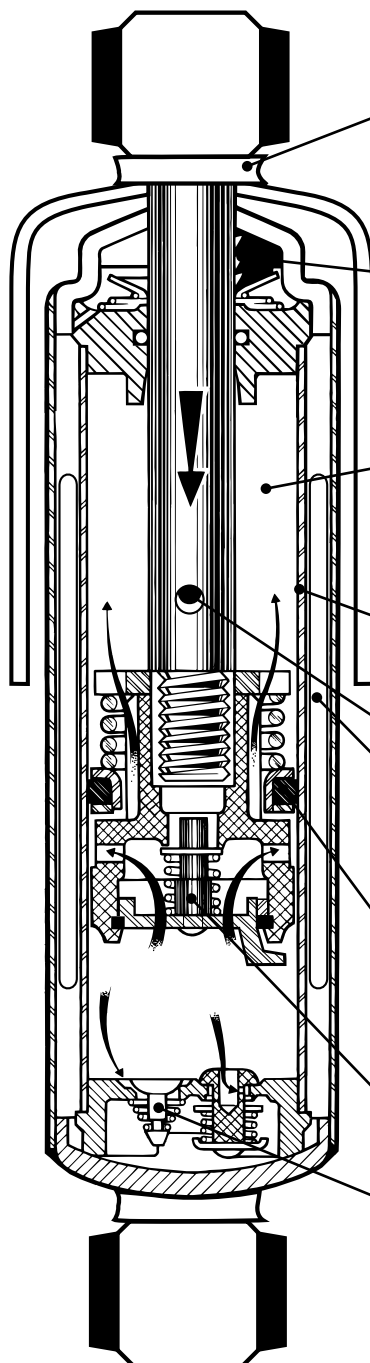

SOPORTES DE 360° CON SOLDADURA DE ARCO EN LOS EXTREMOS
Protegen Contra Rupturas del Soporte en los Extremos.

Las suspensiones de hoy en día requieren amortiguadores capaces de resistir el flexionamiento multidireccional. Reforzando la soldadura en 360° se asegura una superioridad estructural.

Resistencia a la Tracción Mejorada.

Confiere resistencia adicional para limitar la carrera en suspensiones neumáticas.

SELLO DE VITON DE LABIOS MÚLTIPLES

Diseño Más Robusto para Mayor Retención de Fluidos y Desempeño a Alta temperatura.

Sus labios de sellado múltiple actúan como respaldo para mantener el fluido en el interior.

FLUIDO DE ALTA TEMPERATURA (HT)

Reduce la Fricción y el Desgaste en Condiciones de Operación Extremas.

Las presiones y temperaturas extremas pueden causar la desintegración de los fluidos estándar para amortiguadores. El fluido HT Gabriel está especialmente formulado para mantener sus propiedades lubricantes a presiones y temperaturas de 2 a 3 veces superiores a las de los fluidos estándar para amortiguadores.



DISEÑO DE DIÁMETRO INTERIOR GRANDE

Diámetro interior de 1-5/8". Diseño de Equipo Original de Eficacia Comprobada.

Esta área de trabajo ideal, combinada con nuestro fluido HT, ofrece desempeño y durabilidad confiables.

TOPE DE REBOTE HIDRÁULICO¹

Evita Daños por Impacto al Amortiguador y a los Componentes de Montaje del Vehículo.

Totalmente extendido, el agujero de restricción en el vástago se cierra, atrapando el fluido entre el pistón y la cabeza superior del cilindro, creando así un cojín hidráulico.

CELDA DE GAS

Sella Doblemente el Gas de Hexafluoruro de Azufre (SF6) para Asegurar que Permanezca Dentro del Amortiguador.

La celda de gas separa el gas del fluido para que no se puedan mezclar, manteniendo el fluido libre de burbujas que pudieran causar desvanecimiento.

ANILLO DE PISTÓN METÁLICO PRESURIZADO

Energizado Hidráulicamente para Mantener las Características de Amortiguación Requeridas.

Conforme se va desgastando este anillo, las fuerzas de presión hidráulica van forzando el anillo hacia fuera del tubo para mantener sus características de sellado y amortiguación.

VÁLVULAS DE 10 ETAPAS

Mejora el Manejo y Mantiene la Comodidad de Marcha.

Permite ajustar la amortiguación de manera independiente.



¹ Si se requiere por diseño

Gabriel®

AMORTIGUADORES PARA CAMIONES,
SEMIRREMOLQUES Y AUTOBUSES

FleetLine

Componentes de máxima calidad para asegurar un desempeño superior a lo largo de toda la vida útil del amortiguador, reduciendo el desgaste de otras partes costosas de la suspensión.



Soportes de 360° Moldeados en Frío Soldados por Arco*

- Resistencia a la tracción mejorada
- Reduce considerablemente las fallas de soportes en los extremos

Sello de Labio Múltiple

- Protección con sellos adicionales = Mejor retención de fluido
- Mejor retención de fluido = Vida útil más prolongada del amortiguador

Diseño de Diámetro Interior Grande de 1-5/8"*

- Resistencia a la tracción mejorada
- Diseñado para mayor control
- Diseño de eficacia comprobada para suspensiones de baja fricción

Diseño Abultado**

- Mayor capacidad de fluido
- Temperaturas de operación más bajas
- Menos desgaste interno gracias a su disipación del calor

Tope de Extensión Hidráulico¹

- Evita que los amortiguadores toquen techo y que las suspensiones se sobreextiendan
- Diseñado para suspensiones de baja fricción, tales como las Suspensiones de Muelles Neumáticos, etc.

Diseño de Sello de Pistón Flotante

- Reduce las variabilidades fuerza-velocidad
- Aumenta las capacidades de control a bajas velocidades
- Permite autocompensación por desgaste
- Menor desgaste entre el cilindro y el sello del pistón significa menos espacio libre lo cual, a su vez, se traduce en menos desvanecimiento
- Menos desvanecimiento significa desempeño más constante a lo largo del rango completo

Válvulas de Resortes Totalmente Helicoidales de 10 Etapas

- Para mayor comodidad y control
- Durabilidad más prolongada
- De autolimpieza

¹ Si se requiere por diseño

* Excluyendo la Serie 83000

** Incluyendo las Series 85300 y 85700

Nota: Las características pueden variar según el número de parte.





Gabriel®

AMORTIGUADORES PARA CAMIONES,
SEMIRREMOLQUES Y AUTOBUSES

¿Cuándo Deben Cambiarse los Amortiguadores?

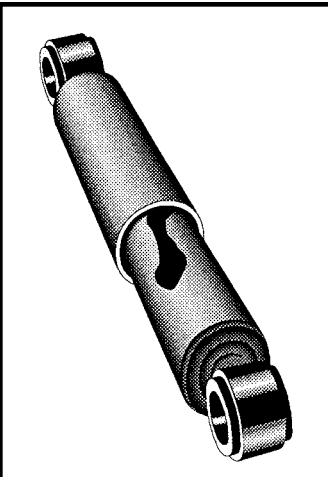
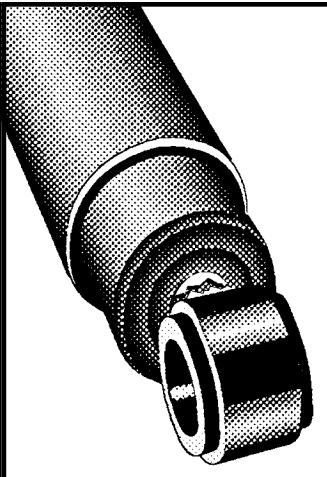
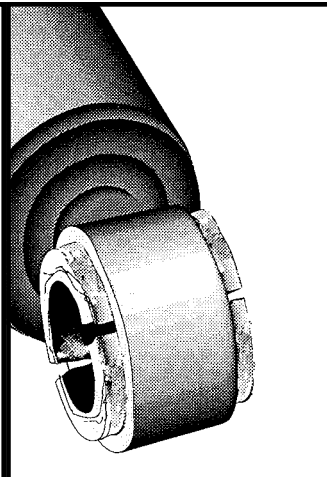
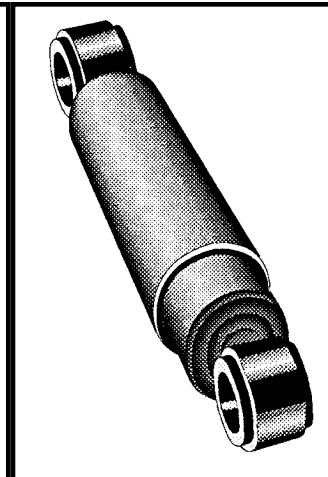
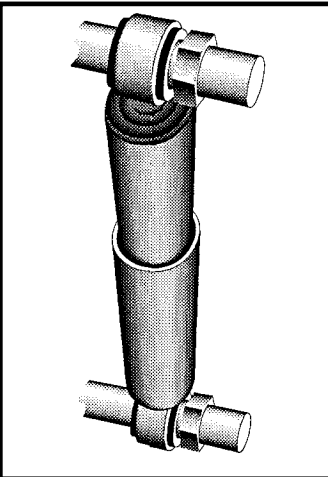
Todas las siguientes condiciones indican que ha llegado la hora de cambiar sus amortiguadores. Recuerde que los amortiguadores desgastados pueden causar vibración que ocasiona daños eléctricos, en el bastidor y en el motor. La inspección regular de sus amortiguadores puede prolongar la vida útil de su vehículo.

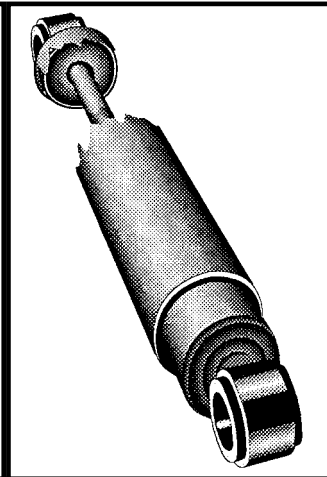
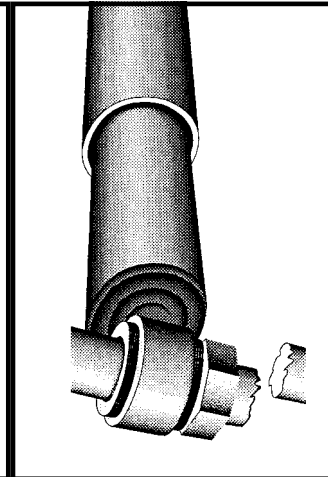
			
L Fuga (Asegúrese de limpiar la suciedad de la carretera del amortiguador)	UMB/LMB Soporte superior o inferior roto	UBB/LBB Buje superior o inferior roto	BI/S Roto internamente Bloqueado (Atorado en posición colapsada)
	<ul style="list-style-type: none">• Marcha suave ondulante• Inclinación excesiva del frente• Demasiado áspero 		
II Instalación Incorrecta (por ejemplo: este amortiguador está instalado al revés)	RC Quejas Acerca de la Marcha	DT Tubo de Polvo Roto	TMF Falla de Soporte en Camión

Gabriel®

AMORTIGUADORES PARA CAMIONES,
SEMIRREMOLQUES Y AUTOBUSES

Guía para Inspeccionar Amortiguadores de Camiones

El mantenimiento de amortiguadores regularmente programado no ocasiona gastos a largo plazo – al contrario, ahorra.

Al igual que con otros componentes del chasis, el mantenimiento regularmente programado para amortiguadores le ayudará a evitar tiempos fuera de servicio no programados y a reducir los costos generales de mantenimiento.

El papel de los amortiguadores ha cambiado dramáticamente. Anteriormente, las suspensiones solían tener muelles de hoja múltiple pesados de carrera limitada y de alta fricción inherente. Tales suspensiones amortiguaban rápidamente, por sí mismas, y por consiguiente, limitaban la cantidad de trabajo que debían realizar los amortiguadores.

Las suspensiones de baja fricción, como la Suspensión Neumática y de Muelles Ahusados han cambiado dramáticamente el papel que desempeñan los amortiguadores. Los amortiguadores ahora desempeñan un papel decisivo en la tarea de amortiguar la oscilación de la suspensión. Cuando los amortiguadores funcionan correctamente, pueden ayudar a reducir el desgaste de componentes más costosos de la suspensión, tales como bolsas neumáticas, reduciendo al mismo tiempo el desgaste de las llantas y el daño a la cabina y al chasis causado por la vibración. Asimismo, contribuyen a reducir la fatiga del conductor. Los amortiguadores gastados simplemente no pueden cumplir su función de proporcionar control a los sofisticados sistemas de suspensión de hoy en día.

Amortiguadores con Fuga vs. Con Evaporación

Los amortiguadores con evaporación suelen diagnosticarse erróneamente como fallas. La evaporación es el proceso mediante el cual muy pequeñas cantidades de fluido de amortiguador se evaporan a altas temperaturas de operación a través del sello superior del amortiguador. Cuando la “evaporación” se combina con el aire más frío del exterior, se condensa formando una fina película en el exterior del cuerpo del amortiguador. Al mezclarse con desechos de la carretera y polvo, se forma una suciedad que va cubriendo todo el cuerpo del amortiguador. La evaporación es un proceso perfectamente normal y necesario del amortiguador. El fluido que se evapora a través del área del sello ayuda a lubricar y prolongar la vida útil del sello.

A muchos técnicos les resulta difícil distinguir entre un amortiguador que presenta evaporación y uno que presenta una verdadera fuga y que necesita ser reemplazado. Cuando hay una fuga, el amortiguador presenta claros signos de fluido que se escurre del sello superior. Tales escurrimientos pueden verse con mayor facilidad cuando el amortiguador está totalmente extendido, y al inspeccionar lo más profundo posible hacia arriba del amortiguador (debajo de la cubierta de polvo o tubo).

Inspeccione con los amortiguadores totalmente extendidos

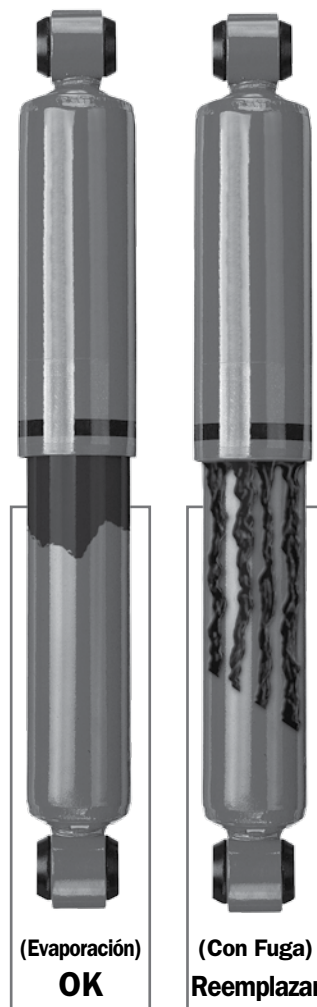

¿Cuándo deben cambiarse los amortiguadores?

Hay varios signos que indican que tal vez haya llegado la hora de cambiar los amortiguadores. Inspeccione lo siguiente:

- **Desgaste Desigual de Llantas** – Primero debe revisarse el balanceo
- **Deterioro de la Marcha**
- **Vibración Excesiva**
- **Muelles de Hoja Ahusada Agotados** – Esto no es causado por amortiguadores débiles
- **Desgaste prematuro** de componentes de la cabina y del sistema eléctrico y de aire acondicionado
- **Muelles Neumáticos Rotos o Torcidos** – Los amortiguadores sólo causan esto si están rotos o no están presentes

Gabriel®

AMORTIGUADORES PARA CAMIONES,
SEMIRREMOLQUES Y AUTOBUSES

Haga la Prueba de Calor

Los amortiguadores operan a temperaturas que van desde la temperatura ambiental hasta 350°F. La función de un amortiguador consiste en amortiguar la oscilación de los muelles del camión. A tal efecto, el amortiguador transforma en calor la energía generada por el muelle, para luego disiparla. Como resultado de esto, el amortiguador debe estar de ligeramente tibio a caliente, después de un uso normal.

Si se aprecia algún deterioro de la marcha y se sospecha que algún amortiguador ha fallado internamente, lo cual no es detectable visualmente, haga la siguiente "PRUEBA DE CALOR DEL AMORTIGUADOR" unos minutos después de operar el equipo:

1. Conduzca el vehículo a velocidades moderadas por lo menos 15 minutos.
2. Unos minutos después de haber conducido el vehículo, toque con cuidado cada amortiguador, sobre el cuerpo, debajo de la cubierta de polvo o tubo, después de haber tocado una parte cercana del chasis, a fin de establecer una temperatura de referencia ambiental del metal.
3. Todos los amortiguadores deben estar más calientes que el chasis. Si algún amortiguador está notablemente más fresco que su contraparte, en el extremo opuesto del eje, sospeche que existe una falla. Las diferencias de temperatura entre un eje y otro no son indicaciones de falla, pero la temperatura más fresca en cualquiera de los ejes si justifica desmontar y examinar el amortiguador que esté más fresco.
4. Para inspeccionar si existe una falla interna, desmonte y agite el amortiguador sospechoso. Escuche el sonido de las partes metálicas que cascabelean en su interior. Si las partes internas cascabelean quiere decir que el amortiguador tiene una falla interna.



Inspecciones Visuales de los Amortiguadores

Mire si están presentes los siguientes problemas potenciales

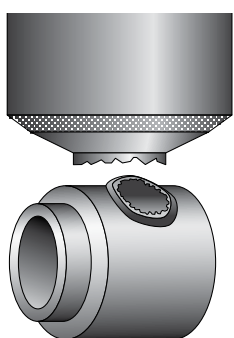

UMB/LMB

Soporte superior o inferior roto

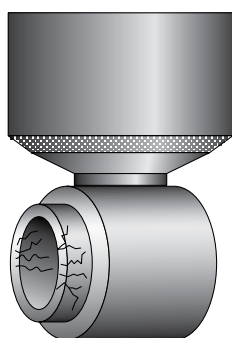

UBB/LBB

Buje superior o inferior roto (los bujes pueden reemplazarse si el diseño lo permite)

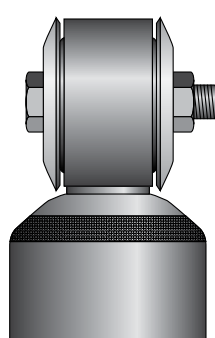

II

Instalación Incorrecta (por ejemplo: arandelas instaladas al revés)

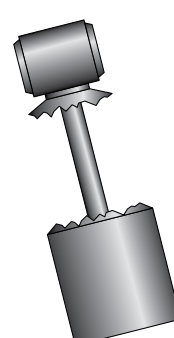

DT

Tubo de Polvo Roto

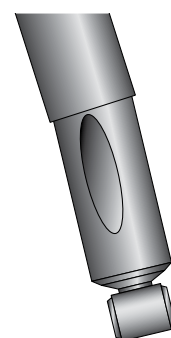

Doblado/ abollado

Gabriel®

AMORTIGUADORES PARA CAMIONES, SEMIRREMOLQUES Y AUTOBUSES

Instrucciones para el Desecho

Nota General

Para retirar el aceite y gas de amortiguadores desechados y defectuosos deben tomarse medidas de protección, tales como el uso de gafas de seguridad y guantes de protección.

Procedimiento

1. Fije el amortiguador en posición horizontal.
2. Extienda totalmente el vástago del pistón antes de perforar la unidad.
3. Utilizando una broca de 1/8" (3 mm), perforo un orificio en dirección hacia abajo, aproximadamente 1.0" (25 mm) del fondo del amortiguador a una profundidad de aproximadamente 1.0" (25 mm) (vea la fig. A).
4. Perfore un segundo orificio de aproximadamente 1/8" (3 mm) a 2.0" (50 mm) de la parte superior del amortiguador a una profundidad de aproximadamente 1.0" (25 mm), para hacer que todo el aceite fluya hacia el exterior (vea la fig. B).
5. Moviendo el vástago del pistón hacia dentro y hacia fuera, comience a accionar la unidad para purgar completamente el aceite del cilindro de ésta (vea la fig. C).

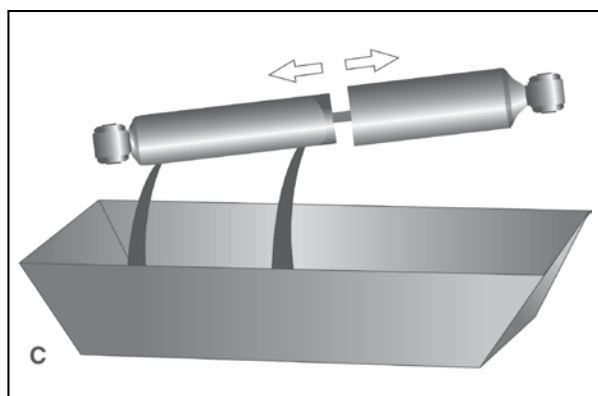
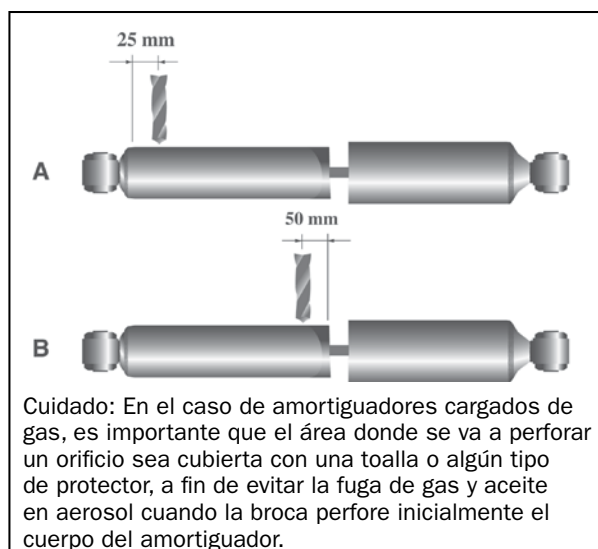

Información Ambiental

6. Acumule todo el aceite usado, **teniendo cuidado de no mezclar aceite con ningún otro desecho o basura.** Almacene el aceite usado en un contenedor aprobado, identificado claramente como "Aceite Usado".
7. Deseche el cuerpo restante y las partes internas del amortiguador de conformidad con los reglamentos Estatales o Municipales locales con respecto a aceite de desecho y otros desechos.
8. Almacene, deseche y transporte el aceite usado de acuerdo con los reglamentos ambientales y reglamentos de programas de aceite usado en su estado o municipio.

El aceite usado de amortiguadores puede depositarse en el mismo contenedor que se utiliza para reciclar aceites de motor. La información sobre dónde desechar el aceite y las otras partes puede obtenerse de las autoridades ambientales o de los proveedores de aceite.

Gabriel®

AMORTIGUADORES PARA CAMIONES,
SEMIRREMOLQUES Y AUTOBUSES

Póliza de Garantía para Amortiguadores Gabriel (Programa de Camiones Pesados)

Garantía Comercial

Los Amortiguadores Gabriel cuentan con la siguiente garantía:

Los Amortiguadores **GasSLX** (Serie 89000) contra defectos de fabricación por dos años a partir de la fecha de compra o por 200,000 millas (322,000 km), lo que ocurra primero.

Los Amortiguadores **FleetLine** (Series 83000, 85000, 85300, 85700, 85900 y 87000) contra defectos de fabricación por un año a partir de la fecha de compra, sin límite de millas.

ESTA GARANTÍA COMERCIAL ESTÁ LIMITADA ÚNICAMENTE AL REEMPLAZO DEL PRODUCTO DEFECTUOSO. No está incluido el costo de embarque, desmontaje e instalación. Esta garantía aplica al comprador original en condiciones de operación normales.

Las disposiciones de esta garantía no aplican a producto: (a) Instalado en cualquier vehículo registrado o usado para fines de carreras o de competencia; (b) usado para cualquier fin distinto al propósito para el cual fue diseñado; (c) que haya sido alterado o sujeto a abuso, negligencia o accidente; (d) que haya sido instalado incorrectamente.

Garantía No Comercial

Los Amortiguadores Gabriel cuentan con la siguiente garantía:

Los Amortiguadores **de Gas para Camionetas** (Serie G60000) contra defectos de fabricación por un año a partir de la fecha de compra o por 25,000 millas (40,250 km), lo que ocurra primero. Esta garantía aplica al comprador original, para uso únicamente en camionetas y vans de pasajeros, en condiciones de operación normales.

ESTA GARANTÍA ESTÁ LIMITADA ÚNICAMENTE AL REEMPLAZO DEL PRODUCTO DEFECTUOSO. No está incluido el costo de embarque, desmontaje e instalación.

Las disposiciones de esta garantía no aplican a producto: (a) Instalado en cualquier vehículo registrado o usado para fines comerciales, carreras o de competencia; (b) usado para cualquier fin distinto al propósito para el cual fue diseñado, (c) que haya sido alterado o sujeto a abuso, negligencia o accidente; (d) que haya sido instalado incorrectamente.

Gabriel®

**AMORTISSEURS POUR POIDS LOURDS,
SEMI-REMORQUES ET AUTOBUS**



Table des matières

À propos des amortisseurs Gabriel pour véhicules commerciaux	
Information technique.....	340
Quand faut-il remplacer les amortisseurs.....	347
Directives de recyclage des amortisseurs.....	350
Politique de garantie.....	351
Modifications apportées au catalogue.....	13
Liste des applications	
Amortisseurs pour cabines.....	14
Amortisseurs pour applications spéciales.....	21
(amortisseurs de direction, supports de capot)	
Camionnettes.....	23
Camions de poids moyen et poids lourds, semi-remorques et autobus.....	59
Liste des applications	
Amortisseurs pour applications spéciales.....	231
Amortisseurs à gaz pour camionnettes.....	231
Fleetline®.....	234
GasSLX®.....	242
Liste de correspondances	
Liste de correspondances des marques concurrentes.....	245
Liste de correspondances du constructeur.....	256
Liste de correspondances des amortisseurs Fleetline® et GasSLX®.....	278
Liste de correspondances, numéros du constructeur et numéros de catalogue.....	279
Comment déterminer l'amortisseur approprié pour votre camion	
Choix des séries et mesure des dimensions extérieures.....	282
Identification du type de montage et mesure de longueur des amortisseurs en détente et en compression.....	283
Comment déterminer les codes de montage et types de support Gabriel.....	284
Comment déterminer les numéros de pièce et les caractéristiques en fonction des supports appropriés.....	287
Spécifications par numéro de pièce.....	300
Ensembles d'accessoires de montage	
Liste de pièce des composants.....	313
Guide d'achat.....	321
Sección en español	
Tabla de materias.....	324
Section française	
Table des matières.....	339

Gabriel®

AMORTISSEURS POUR POIDS LOURDS,
SEMI-REMORQUES ET AUTOBUS

L'évolution vers la haute performance

Les performances élevées des véhicules d'aujourd'hui demandent des amortisseurs de plus en plus performants.

Les ressorts à lames multiples qui équipent les poids lourds possèdent une course très limitée et un coefficient de frottement important. Les ressorts à lames multiples amortissent les oscillations de la suspension, ce qui allège la tâche des amortisseurs.

Les nouvelles générations de suspensions à coefficient de frottement réduit, telles que les suspensions pneumatiques ou à lames paraboliques, possèdent un très faible coefficient d'amortissement et un débattement vertical important. Ces caractéristiques optimisent le contrôle et les performances des nouveaux véhicules. Elles contribuent également à réduire la fatigue du conducteur en isolant mieux les éléments du véhicule ainsi que son chargement des vibrations occasionnées par les routes en mauvais état.

L'évolution des suspensions à coefficient de frottement réduit demande un meilleur contrôle d'oscillation de la suspension, ce qui impose une nouvelle norme de performance des amortisseurs.



Suspension à ressorts à lames multiples

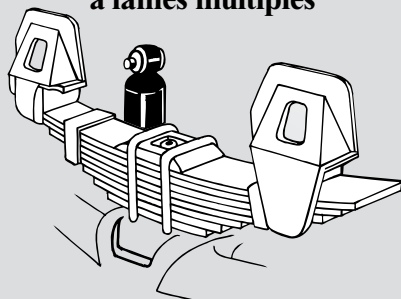

Le coefficient de frottement important de ces ressorts limite le débattement de la suspension à environ 50 à 75 mm (2 à 3 po).

Suspension à ressorts pneumatiques



Dorénavant, le travail d'amortissement est presque entièrement confié aux amortisseurs. Le débattement de ces suspensions peut aller jusqu'à 230 mm (9 po).

Suspension à lames paraboliques

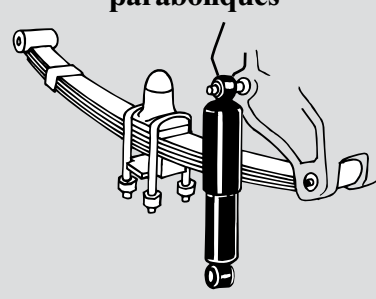

Gabriel®

AMORTISSEURS POUR POIDS LOURDS,
SEMI-REMQUES ET AUTOBUS

GasSLX (amortisseurs à gaz réglables pour poids lourds)

Série 89000

Amortisseur à gaz réglable de catégorie supérieure pour poids lourds

- Cellule de gaz unique améliorant la rétention du gaz grâce à ses deux points d'étanchéité
- Les trois positions de réglage offrent des gammes d'amortissement adaptées à chaque application
- Alésage de 1 5/8 po et supports à œil soudés à l'arc sur 360° pour une durabilité maximale
- Le fluide haute température spécialement formulé réduit le frottement et l'usure dans des conditions de fonctionnement extrêmes
- Plusieurs composants haut de gamme améliorés contribuent à une performance et une durabilité incomparables



FleetLine (amortisseurs pour poids lourds)

Série 83000*

Amortisseur robuste destiné aux camionnettes ou aux suspensions de poids lourds à dégagement limité.

- Alésage de 1 3/8 po
- Jeu de clapets à 10 étages

Séries 85000 et 85300*

De conception renforcée, ces deux séries constituent la norme pour les suspensions à coefficient de frottement réduit qui équipent les poids lourds d'aujourd'hui.

- Alésage de 1 5/8 po pour une durabilité accrue
- Les supports à œil soudés à l'arc sur 360° évitent les bris
- La butée de rebond hydraulique¹ protège les amortisseurs et les éléments de montage du véhicule contre les dommages dus aux impacts
- La conception du joint de tige de piston multilèvre apporte une protection additionnelle
- Extrémités soudées pour une résistance à la rupture optimale



Série 85700*

Amortisseurs conçus pour répondre aux applications de poids lourds spécifiques et aux autobus soumis à un service intensif. Les caractéristiques spécifiques de cette série assurent une longue durée de vie et un fonctionnement uniforme.

- Alésage de 1 5/8 po et tube renflé augmentant la capacité de fluide et réduisant ainsi la surchauffe
- Le matériau de joint de piston breveté augmente de façon significative sa durée de vie
- Le fluide haute température spécialement formulé réduit le frottement et l'usure dans des conditions de fonctionnement extrêmes
- Comprend également toutes les caractéristiques particulières aux séries 85000 et 85300



* Le joint de piston à auto-compensation assure un fonctionnement uniforme durant toute la vie utile de l'amortisseur

¹ Sur demande.

Gabriel®

AMORTISSEURS POUR POIDS LOURDS,
SEMI-REMORQUES ET AUTOBUS

Amortisseurs pour cabines FleetLine

Amortisseurs pour cabines

Amortisseurs conçus spécifiquement pour éliminer les vibrations dans la cabine.

- Un choix d'alésages de 1 po, 1 3/16 po, 1 3/8 po et 1 5/8 po permet d'adapter la capacité d'amortissement à tous les types de cabine
- La cellule de gaz unique³ réduit la perte d'efficacité due à l'effet d'émulsion du fluide
- Jeu de clapets exclusif à 10 étages procurant un confort uniforme sur toute la plage de vitesse du véhicule
- La tige de piston chromée de qualité supérieure augmente la résistance à la corrosion et réduit l'usure du joint de tige de piston
- La conception du joint de tige de piston multilèvre apporte une protection additionnelle et augmente la durabilité



Garantie de
1 AN
et kilométrage
illimité

Amortisseurs pour camionnettes

Série G6000

Amortisseurs conçus pour une performance uniforme et fiable.

Conçus spécifiquement pour les camionnettes et fourgonnettes de tourisme.

- Alésage de 1 3/8 po
- Amortisseurs de type à gaz
- Joint de tige de piston à lèvre radiale
- Applications non commerciales seulement



Garantie de 1
AN
ou 40 000 km
(25 000 mi)

Amortisseurs de direction

- Les supports soudés à l'arc assurent la protection contre le bris et procurent une grande durabilité
- La cellule de gaz unique sépare l'air de l'huile pour un fonctionnement optimal en position horizontale
- Les points de montage de même type que ceux d'origine facilitent l'installation et augmentent la durabilité

Ces amortisseurs partagent les mêmes qualités de conception, de longévité et d'endurance qui ont fait la réputation mondiale de nos amortisseurs d'origine.

³ Selon la conception de l'amortisseur.

Gabriel®

AMORTISSEURS POUR POIDS LOURDS,
SEMI-REMORQUES ET AUTOBUS

Amortisseurs pour cabine FleetLine¹

**Amortisseurs conçus spécifiquement pour éliminer les vibrations dans la cabine
(consultez les pages 14 à 18 pour la liste des applications spécifiques).**

Garantie de
AN
et kilométrage
illimité

- La cellule de gaz unique² réduit les pertes d'efficacité
- Jeu de clapets exclusif à 10 étages procurant un contrôle uniforme sur toute la plage de vitesse du véhicule
- La tige de piston chromée de qualité supérieure augmente la résistance à la corrosion et réduit l'usure du joint de tige de piston
- Le joint de tige de piston multilèvre en nitrile augmente la durabilité
- Le fluide toutes saisons assure un rendement uniforme malgré les écarts de température extrêmes

¹ Pour camions seulement

² Selon la conception de l'amortisseur.

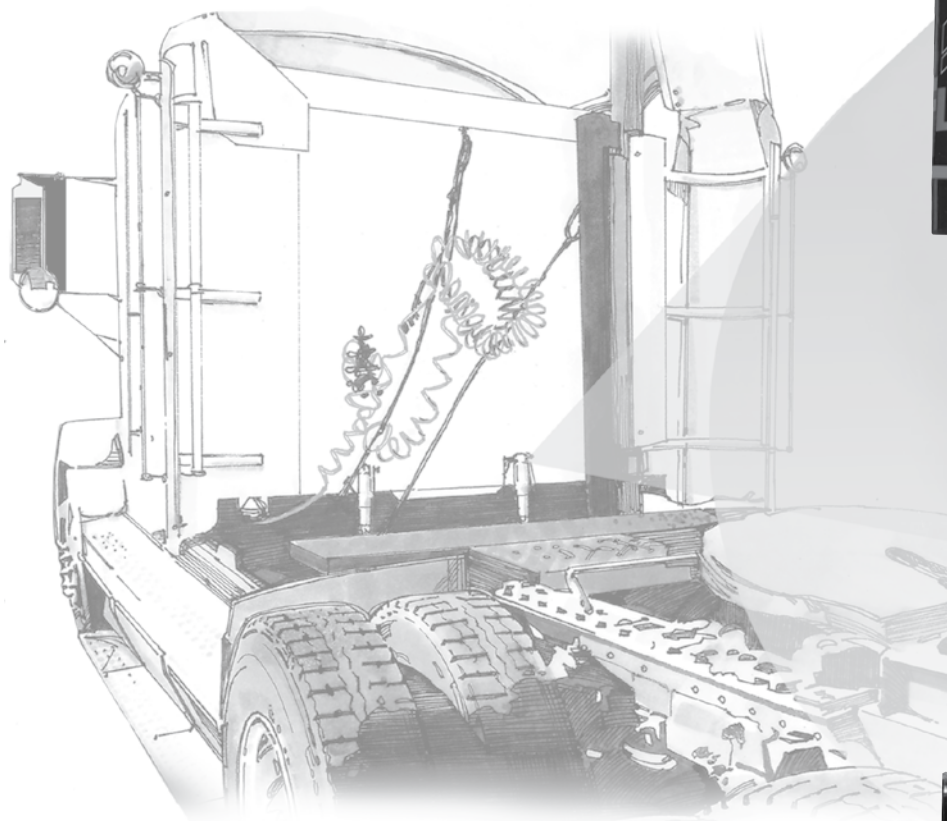

Gabriel®

AMORTISSEURS POUR POIDS LOURDS,
SEMI-REMORQUES ET AUTOBUS

GasSLX – Un confort d'exception!

- L'amortisseur GasSLX réglable s'adapte à vos applications grâce à ses trois positions de réglage : ferme, normal et extra ferme.
- Ferme – correspond aux performances d'origine du véhicule
- Normal – apporte une plus grande douceur que celle de l'équipement d'origine
- Extra ferme – procure un meilleur contrôle

Force de détente des amortisseurs à gaz typiques comparée à celle de l'équipement d'origine

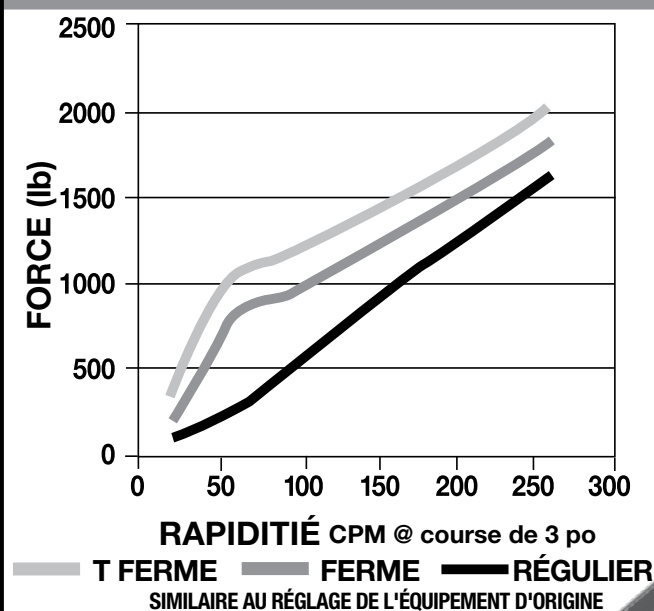

Gabriel®

AMORTISSEURS POUR POIDS LOURDS,
SEMI-REMORQUES ET AUTOBUS

GasSLX – Fiabilité, maîtrise, confort et degré
d'amortissement réglable

Une classe supérieure qui fait la différence! Les amortisseurs Gabriel GasSLX sont dotés d'éléments de qualité supérieure reconnus pour faire la différence.

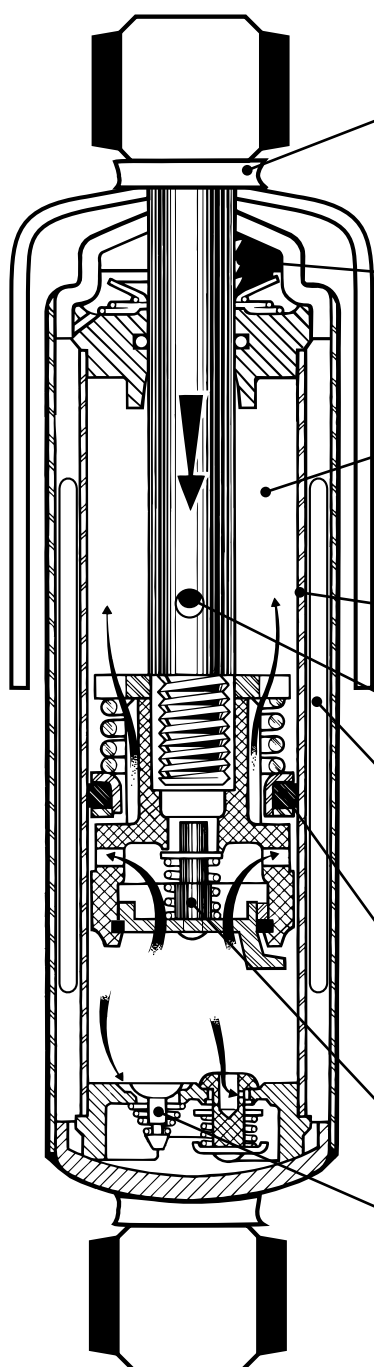

SUPPORTS À ŒIL SOUDÉS À L'ARC SUR 360°
Protègent contre les bris d'amortisseur.

Les suspensions d'aujourd'hui imposent des contraintes multidirectionnelles aux amortisseurs. Une soudure renforcée sur 360° assure une rigidité structurelle supérieure.

Résistance à la rupture améliorée

Procure la résistance accrue nécessaire pour limiter le débattement des suspensions pneumatiques.

JOINT D'ÉTANCHÉITÉ MULTILÈVRE EN VITONL
Joint plus robuste pour une meilleure rétention du fluide et une performance élevée à haute température.

La conception multilèvre du joint retient mieux le fluide.

FLUIDE HAUTE TEMPÉRATURE (HT)
Réduit le frottement et l'usure dans des conditions de température extrêmes.

Les pressions et températures extrêmes peuvent dégrader les fluides d'un amortisseur standard. Le fluide haute température Gabriel HT est spécialement formulé pour maintenir ses propriétés lubrifiantes à des pressions et températures dépassant de deux ou trois fois les limites des fluides pour amortisseur standard.



ALÉSAGE DE GRAND DIAMÈTRE
Alésage de 1 5/8 po. Conception éprouvée du constructeur.

La grande surface de travail de l'amortisseur combinée à l'action du fluide HT garantit une performance et une durabilité sans faille.

BUTÉE DE REBOND HYDRAULIQUE¹
Protège les amortisseurs et les éléments de montage du véhicule contre les dommages dus aux impacts.

En fin de course de détente, l'orifice calibré de la tige de piston se ferme et emprisonne le fluide entre le piston et le haut de l'alésage de l'amortisseur pour créer une zone d'amortissement hydraulique.

CELLULE DE GAZ
La cellule de gaz à l'hexafluorure de soufre (SF6) à joint double assure une parfaite étanchéité au sein de l'amortisseur.

La cellule de gaz sépare l'air du fluide afin de prévenir le phénomène d'émulsion qui mène à une perte d'efficacité.

SEGMENTS DE PISTON EN MÉTAL SOUS EFFET DE PRESSION
La pression hydraulique permet de maintenir les caractéristiques d'amortissement requises.

Lorsque le segment s'use, la pression hydraulique plaque le segment contre le tube afin de maintenir l'étanchéité et les caractéristiques d'amortissement d'origine.

JEU DE CLAPETS À 10 ÉTAGES
Améliore la tenue de route et le confort du conducteur.
Permet de régler indépendamment le degré d'amortissement.



¹ Si la conception l'exige

Gabriel®

AMORTISSEURS POUR POIDS LOURDS,
SEMI-REMORQUES ET AUTOBUS

FleetLine

Les composants de qualité d'origine assurent une performance supérieure durant toute la vie utile de l'amortisseur, en plus de réduire l'usure et la fatigue des autres éléments de suspension onéreux de votre véhicule.



Supports formés à froid et soudés à l'arc sur 360°*

- Résistance à la rupture améliorée
- Permet de réduire les bris de support d'amortisseur

Joint multilèvre

- Une protection du joint additionnelle signifie une meilleure rétention du fluide
- Une meilleure rétention du fluide signifie une plus longue durée de vie de l'amortisseur

Alésage de grand diamètre de 1 5/8 po*

- Résistance à la rupture améliorée
- Meilleur contrôle de la suspension
- Conception éprouvée pour les suspensions à coefficient de frottement réduit

Tube renflé**

- Capacité de fluide augmentée
- Températures de fonctionnement plus basses
- Réduction de l'usure interne grâce à une meilleure dissipation de la chaleur

Butée de rebond hydraulique¹

- Évite la surcourse de détente et limite le débattement de la suspension
- Conçus pour les suspensions à coefficient de frottement réduit, p. ex., les suspensions pneumatiques

Joint de piston flottant

- Réduit les variations de force et de vitesse
- Augmente le contrôle à faible vitesse
- Compense automatiquement l'usure
- Une réduction de l'usure entre le cylindre et le joint de piston se traduit par un jeu minimal et une perte d'efficacité réduite
- Une perte d'efficacité réduite signifie un rendement uniforme sur toute la plage de fonctionnement de l'amortisseur

Jeu de clapets à ressort à 10 étages

- Meilleur confort et contrôle plus efficace de la suspension
- Durabilité optimisée
- Effet d'autonettoyage

¹ Si la conception l'exige

* Sauf pour la série 83000

** Incluant les séries 85300 et 85700

Nota : Les caractéristiques peuvent varier selon le numéro de pièce.





Gabriel®

AMORTISSEURS POUR POIDS LOURDS,
SEMI-REMORQUES ET AUTOBUS

Quand faut-il remplacer les amortisseurs

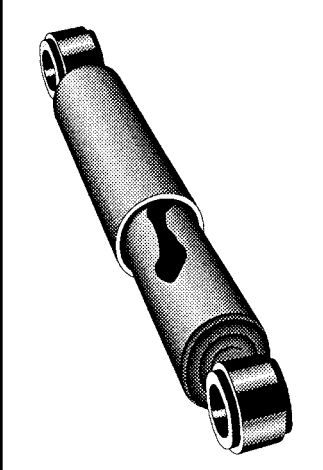
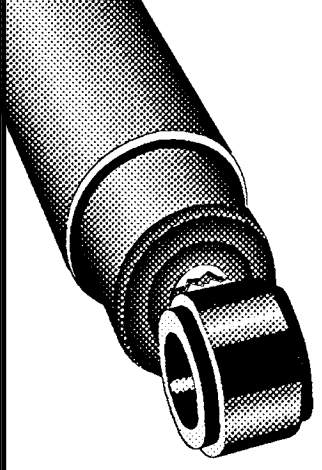
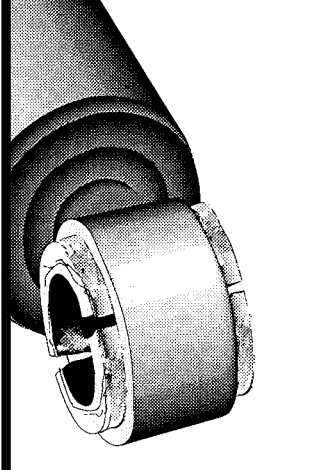
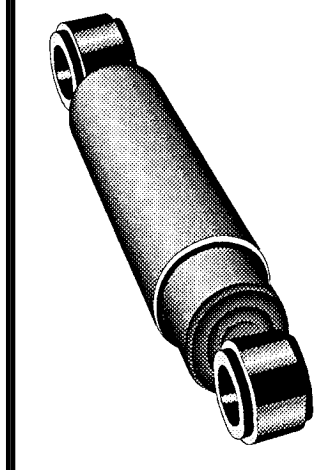
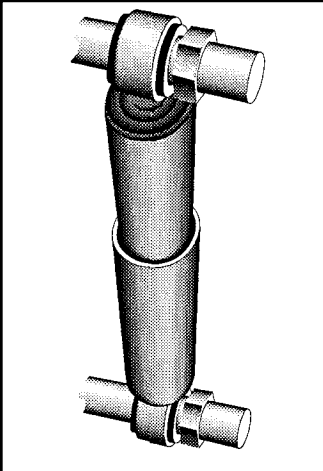
Toutes les conditions suivantes indiquent qu'il est temps de remplacer vos amortisseurs. Notez que des amortisseurs usés peuvent causer des vibrations pouvant engendrer des dommages au système électrique du véhicule, au châssis ou au moteur. Un contrôle périodique de vos amortisseurs peut prolonger la vie utile de votre véhicule.

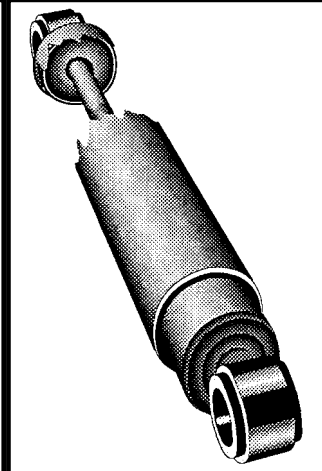
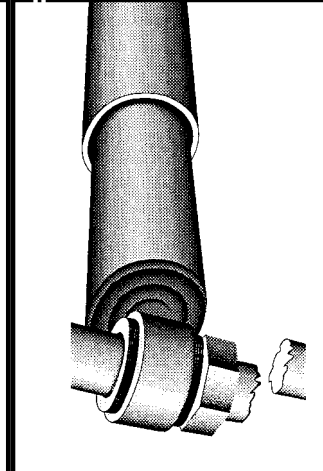
			
L Fuite (assurez-vous d'essuyer les salissures de la route)	UMB/LMB Rupture du support supérieur ou inférieur	UBB/LBB Rupture de la bague supérieure ou inférieure	BI/S Rupture des éléments internes de l'amortisseur Grip-page (coincé en compression)
	 <ul style="list-style-type: none">• Balancement du véhicule, suspension trop molle• L'avant du véhicule plonge au freinage• Suspension trop dure		
RC Montage inapproprié (par exemple : amortisseur monté à l'envers)	DT Problème de comportement routier	TMF Séparation du tube pare-poussière	Rupture du point de montage du véhicule

Gabriel®

AMORTISSEURS POUR POIDS LOURDS,
SEMI-REMORQUES ET AUTOBUS

Guide d'inspection des amortisseurs de camions

Le contrôle périodique des amortisseurs n'est pas une solution coûteuse à long terme, bien au contraire!

Comme pour tout autre composant du véhicule, un programme de contrôle périodique de vos amortisseurs permettra d'éviter les temps morts imprévus et de réduire les coûts d'entretien du véhicule.

Aujourd'hui, le rôle des amortisseurs a changé de façon importante. Jadis, les suspensions de poids lourds comportaient des ressorts à lames multiples qui possédaient une course très limitée et un coefficient de frottement important. Les ressorts à lames multiples amortissent rapidement les oscillations de la suspension, ce qui allège la tâche des amortisseurs.

Les suspensions à coefficient de frottement réduit, telles que les suspensions pneumatiques ou à lames paraboliques, ont défié le travail de l'amortisseur. Les amortisseurs jouent maintenant un rôle primordial dans le contrôle d'oscillation de la suspension. Des amortisseurs en bon état peuvent aider à réduire l'usure des éléments plus onéreux de la suspension, tels que les ressorts pneumatiques, tout en réduisant l'usure des pneus et les dommages à la cabine et au châssis causés par les vibrations. Ils préviennent également la fatigue du conducteur. Des amortisseurs usés ne peuvent tout simplement pas assurer le contrôle des systèmes de suspension évolués d'aujourd'hui.

Fuite ou suintement

Un suintement des amortisseurs est souvent interprété comme une déféctuosité. Le suintement est causé par une très faible quantité de fluide qui s'évapore à haute température par le joint supérieur de l'amortisseur. Lorsque cette « vapeur » atteint l'air extérieur, elle se condense et forme une pellicule sur la surface de l'amortisseur. Lorsque les souillures de la route et la poussière s'accumulent, l'amortisseur s'encrasse. Le suintement est un phénomène normal et nécessaire au bon fonctionnement de l'amortisseur. En effet, le fluide qui s'évapore par le joint participe à sa lubrification et prolonge sa durée de vie.

Plusieurs techniciens ne peuvent avec certitude distinguer un amortisseur qui suinte d'un amortisseur qui fuit et qui, par conséquent, doit être remplacé. Une fuite laisse clairement paraître un filet de fluide qui s'échappe par le joint supérieur de l'amortisseur. Une fuite est plus facile à détecter lorsque l'amortisseur est en fin de course de détente, vers le haut du corps principal, sous le pare-poussière.

Vérifiez l'amortisseur lorsqu'il est en fin de course de détente

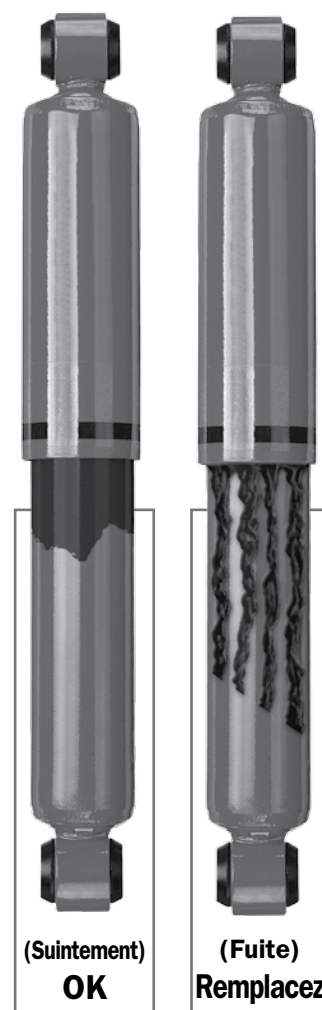

Quand faut-il remplacer les amortisseurs?

Plusieurs conditions indiquent qu'il est temps de remplacer vos amortisseurs. Recherchez les conditions suivantes :

- **Usure inégale des pneus** - Vérifiez d'abord l'équilibrage des roues
- **Tenue de route qui se dégrade**
- **Vibrations excessives**
- **Affaissement des ressorts à lames paraboliques** - Cette condition n'est pas causée par des amortisseurs peu performants
- **Usure prématurée** des composants de la cabine, des éléments électriques et du système de refroidissement
- **Ressorts pneumatiques endommagés** - Causés par les amortisseurs uniquement s'ils sont cassés ou manquants

Gabriel®

AMORTISSEURS POUR POIDS LOURDS,
SEMI-REMORQUES ET AUTOBUS

Essai de température

Les amortisseurs fonctionnent à des températures allant de la température ambiante jusqu'à 175° C (350° F). Le rôle d'un amortisseur consiste à amortir les oscillations de la suspension du camion. Pour ce faire, il doit transformer l'énergie produite par les ressorts en chaleur et la dissiper dans l'atmosphère. Ainsi, un amortisseur qui travaille dans des conditions normales doit devenir légèrement chaud au toucher.

Si la tenue de route du véhicule se dégrade et que l'on suspecte la défaillance interne d'un amortisseur (condition indétectable par un contrôle visuel), procédez à l'ESSAI DE TEMPÉRATURE des amortisseurs après avoir utilisé le véhicule :

1. Roulez à vitesse modérée pendant au moins une quinzaine de minutes.
2. Placez ensuite la main sur chacun des amortisseurs, particulièrement sur la partie du tube qui émerge du pare-poussière, puis sur une partie du châssis du camion afin de pouvoir constater la différence avec la température ambiante.
3. Tous les amortisseurs doivent être plus chauds au toucher que le châssis du camion. Si l'un des deux amortisseurs d'un même essieu semble moins chaud que l'autre, vérifiez l'état de cet amortisseur. Il est possible que la température des amortisseurs diffère d'un essieu à l'autre, mais une différence de température relevée sur un même essieu peut indiquer une défaillance de l'amortisseur moins chaud, et ce dernier doit être déposé pour être vérifié.
4. Pour contrôler l'état des éléments internes de l'amortisseur suspect, il faut d'abord le déposer puis le secouer. Il s'agit de rechercher un bruit métallique à l'intérieur de l'amortisseur. Un bruit métallique qui se produit à l'intérieur de l'amortisseur lorsqu'on le secoue indique une défaillance.



Contrôle visuel des amortisseurs

Recherchez les conditions suivantes :

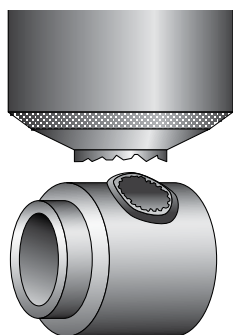

UMB/LMB

Rupture du support supérieur ou inférieur

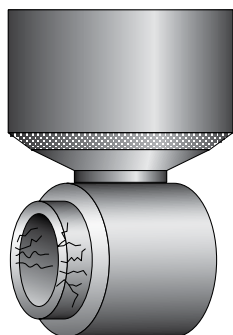

UBB/LBB

Rupture de la bague supérieure ou inférieure (Les bagues sont remplaçables sur certains amortisseurs)

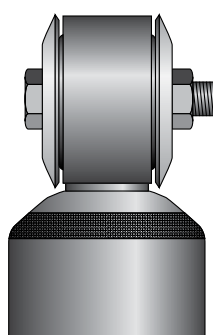

II

Montage inapproprié (par exemple : rondelles installées dans le mauvais sens)

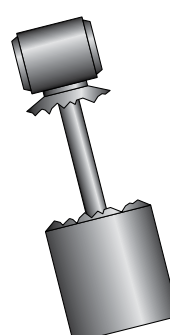

DT

Séparation du tube pare-poussière

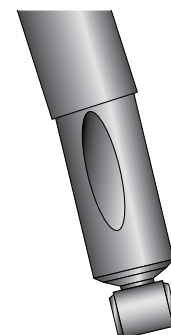

Corps plié ou bosselé

Gabriel®

AMORTISSEURS POUR POIDS LOURDS,
SEMI-REMORQUES ET AUTOBUS

Directives de recyclage des amortisseurs

Remarque générale

Des mesures de protection appropriées, telles que le port de lunettes et de gants de protection, doivent être prises au moment d'extraire l'huile et le gaz d'un amortisseur défectueux et rendu non utilisable.

Procédure

1. Immobilisez l'amortisseur en position horizontale.
2. Tirez complètement l'amortisseur jusqu'en fin de course de détente.
3. À l'aide d'un foret de 3 mm (1/8 po), percez un trou perpendiculaire au tube à environ 25 mm (1 po) du bas de l'amortisseur, à une profondeur d'environ 25 mm (1 po) (figure A).
4. Percez un second trou de 25 mm (1 po) à environ 25 mm (1 po) du haut de l'amortisseur, à une profondeur d'environ 25 mm (1 po), de façon que toute l'huile puisse s'en échapper (figure B).
5. Actionnez l'amortisseur sur toute sa course dans les deux sens de façon à purger complètement l'huile du cylindre de l'amortisseur (figure C).

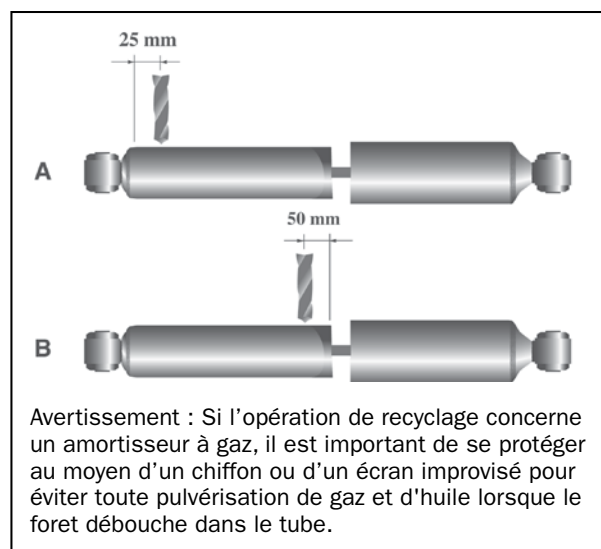

Information environnementale

6. Récupérez la totalité de l'huile en prenant soin de **ne pas la mélanger à d'autres matériaux à recycler**. Entreposez l'huile dans un contenant portant la mention « Huile usée ».
7. Recyclez le reste de l'amortisseur inutilisable en respect des réglementations fédérales ou provinciales relatives aux huiles usées et autres types de déchets.
8. Entreposez, transportez et recyclez l'huile usée en respect des réglementations environnementales fédérales ou provinciales relatives aux huiles usées.

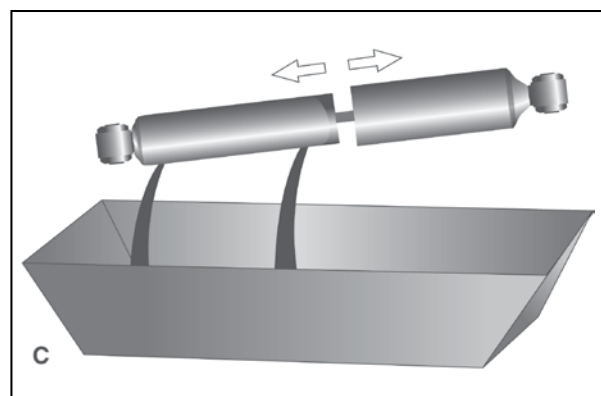

L'huile usée des amortisseurs peut être entreposée dans un contenant utilisé pour le recyclage des huiles à moteur. Les renseignements concernant le recyclage de l'huile et des autres pièces peuvent être obtenus auprès des autorités environnementales ou des fournisseurs d'huile.

Gabriel®

**AMORTISSEURS POUR POIDS LOURDS,
SEMI-REMORQUES ET AUTOBUS**

Politique de garantie sur les amortisseurs Gabriel (Programme de garantie pour poids lourds)

Garantie commerciale

La garantie des amortisseurs Gabriel se détaille comme suit :

Les amortisseurs GasSLX (série 89000) sont garantis contre tout défaut de fabrication pour une période de deux (2) ans à partir de la date d'achat ou pour 300 000 km (200 000 milles), selon la première éventualité.

Les amortisseurs (séries 83000, 85000, 85300, 85700, 85900 et 87000) sont garantis contre tout défaut de fabrication pour une période de un (1) an à partir de la date d'achat et pour un kilométrage illimité.

CETTE GARANTIE COMMERCIALE SE LIMITE UNIQUEMENT AU REMPLACEMENT DU PRODUIT DÉFECTUEUX. Les frais relatifs à l'expédition, au retrait et à la pose du produit ne sont pas couverts. Cette garantie s'applique au premier acheteur et uniquement lorsque le produit a été utilisé dans des conditions normales de fonctionnement.

Cette garantie ne s'applique pas lorsque le produit : (a) a été installé sur un véhicule utilisé pour la course sur circuit ou pour tout autre événement sportif; (b) a été utilisé à des fins non prévues; (c) a été modifié ou soumis à un usage abusif, à des négligences ou à un accident; (d) a été installé de façon incorrecte.

Garantie non commerciale

La garantie des amortisseurs Gabriel se détaille comme suit :

Les amortisseurs pour camionnettes (série G60000) sont garantis contre tout défaut de fabrication pour une période de un (1) an à partir de la date d'achat ou pour 40 000 km (25 000 milles), selon la première éventualité. Cette garantie s'applique au premier acheteur et uniquement lorsque le produit a été installé sur une camionnette ou fourgonnette de tourisme et utilisé dans des conditions normales de fonctionnement.

CETTE GARANTIE SE LIMITE UNIQUEMENT AU REMPLACEMENT DU PRODUIT DÉFECTUEUX. Les frais relatifs à l'expédition, au retrait et à la pose du produit ne sont pas couverts.

Cette garantie ne s'applique pas lorsque le produit : (a) a été installé sur un véhicule utilisé pour un usage commercial, pour la course sur circuit ou pour tout autre événement sportif; (b) a été utilisé à des fins non prévues; (c) a été modifié ou soumis à un usage abusif, à des négligences ou à un accident; (d) a été installé de façon incorrecte.

Distributed by:

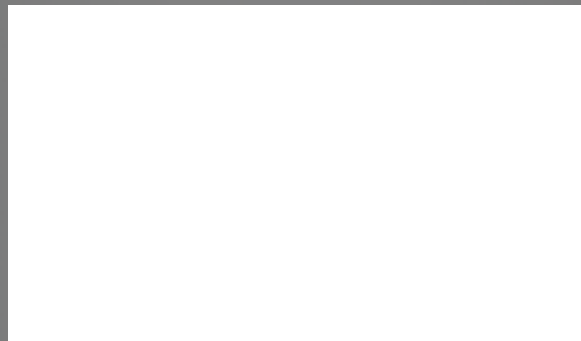

Gabriel® is a registered brand of Ride Control, LLC.
Ultra®, Fleetline® and GasSLX® are registered
trademarks of Ride Control, LLC.

Information contained in this publication was in effect at
the time the publication was approved for printing and is
subject to change without notice or liability. Meritor
reserves the right to revise the information presented or
discontinue the production of parts at any time.



Meritor Heavy Vehicle Systems, LLC
7975 Dixie Highway
Florence, KY 41042 USA
1-888-725-9355
CAN 1-800-387-3889
meritor.com

Litho in Canada
Revised 01-11
754 (47865/11900)
©2011 Meritor, Inc.