

MASTER CATALOG



FAIRVIEW FITTINGS & Manufacturing

WAREHOUSE / SALES LOCATIONS

Canadian

- Vancouver BC
- Calgary AB
- Edmonton AB
- Saskatoon SK
- Winnipeg MB
- Toronto ON
- Montreal PQ
- Moncton NB

U.S.A.

- Wheatfield NY
- Woburn MA
- Elkhart IN

	<p>FITTINGS</p> <p>SECTION A 1 TO 54</p>
	<p>HOSE ENDS</p> <p>SECTION B 55 TO 78</p>
	<p>HOSE & ASSEMBLIES</p> <p>SECTION C 79 TO 140</p>
	<p>TUBE</p> <p>SECTION D 141 TO 148</p>
	<p>CLAMPS & TUBE STRAPS</p> <p>SECTION E 149 TO 158</p>
	<p>VALVES & COCKS</p> <p>SECTION F 159 TO 174</p>
	<p>QUICK DISCONNECTS</p> <p>SECTION G 175 TO 192</p>
	<p>GAUGES</p> <p>SECTION H 193 TO 198</p>
	<p>GAS CONTROL COMPONENTS</p> <p>SECTION I 199 TO 230</p>
	<p>TOOLS & ACCESSORIES</p> <p>SECTION J 231 TO 248</p>
	<p>CABINETS & DISPLAY UNITS</p> <p>SECTION K 249 TO 270</p>



Fairview Fittings & Manufacturing Limited
Canadian Head Office: Toronto Canada



Fairview Fittings & Manufacturing Incorporated
U.S.A. Corporate HQ: Wheatfield, New York

FAILURE OR IMPROPER SELECTION OR IMPROPER USE OF THE PRODUCTS AND/OR SYSTEMS DESCRIBED HERE IN OR RELATED ITEMS CAN CAUSE DEATH, PERSONAL INJURY AND PROPERTY DAMAGE.

This document and other information from Fairview Fittings & Mfg., its subsidiaries and authorized distributors provide product and/or system options for further investigation by users having technical expertise. It is important that you analyze all aspects of your application and review the information concerning the product or system, in the current catalogue. Due to the variety of operating conditions and applications for these products or systems, the user, through its own analysis and testing, is solely responsible for making the final selection of the products and systems and assuming that all performance, safety and warning requirements are met.

AGGRESSIVE WATER WARNING:

Water quality can significantly influence the life of Fairview products. Test for corrosive elements, acidity and other relevant contaminants, including chlorine and treat water appropriately. Failure to do so will void warranty and may lead to premature failure of tubes, valves and fittings.

The product described herein, including without limitation, product features, specifications, designs, availability and pricing, are subject to change by Fairview Fittings & Mfg. and its subsidiaries at any time without notice.

LA DÉFAILLANCE, LA MAUVAISE SÉLECTION OU LE MAUVAIS USAGE DES PRODUITS OU SYSTÈMES DÉCRITS CI-DESSOUS OU ARTICLES CONNEXES PEUT CAUSER LA MORT, DES BLESSURES CORPORELLES OU DES DOMMAGES MATÉRIELS.

Ce document et les autres renseignements fournis par Fairview Fittings, ses filiales et distributeurs autorisés offrent des options de produits ou systèmes pour les utilisateurs ayant de l'expertise technique. Il est important d'analyser tous les aspects de votre application et de revoir l'information concernant le produit ou système dans le catalogue actuel. À cause des conditions de fonctionnement et des applications variées de ces produits ou systèmes, l'utilisateur, par sa propre analyse et ses essais, est le seul responsable de la sélection finale des produits et systèmes, en présumant que toutes les exigences de rendement, de sécurité et d'avertissement sont respectées.

AVERTISSEMENT RELATIF À L'EAU AGRESSIVE

La qualité de l'eau peut avoir une incidence sur la durée de vie des produits Fairview. Analyser l'eau pour vérifier le niveau d'acidité, la présence d'éléments corrosifs ou d'autres polluants connexes, y compris le chlore, et traiter l'eau en conséquence. L'inobservation de cet avertissement annulera la garantie et pourrait causer la défaillance prématurée des tubes, des robinets et des raccords.

Le produit décrit aux présentes, y compris mais sans s'y limiter, les caractéristiques du produit, spécifications, conceptions, disponibilité et prix sont sujets à changement par Fairview Fittings et ses filiales en tout temps et sans préavis.

LA FALTA DE SELECCIÓN, UNA SELECCIÓN INADECUADA O EL USO INDEBIDO DE LOS PRODUCTOS, SISTEMAS O ARTÍCULOS AFINES QUE SE DESCRIBEN AQUÍ PUEDEN CAUSAR LA MUERTE, LESIONES A LAS PERSONAS Y DAÑOS A LA PROPIEDAD.

Este documento, junto con otra información de parte de Fairview Fittings & Mfg., sus subsidiarias y distribuidores autorizados ofrecen opciones de productos o sistemas para que los usuarios que tengan pericia técnica realicen una investigación posterior. Es importante que analice todos los aspectos de su aplicación y revise la información del presente catálogo con respecto al producto o sistema. Debido a la diversidad de condiciones operativas y aplicaciones de estos productos o sistemas, el usuario - a través de su propio análisis y prueba - es el único responsable de hacer la selección final de los productos y sistemas, y de que se cumplan todos los requisitos de rendimiento, seguridad y advertencia.

ADVERTENCIA DE AGUA AGRESIVA: La calidad del agua puede influir en forma significativa en la vida de los productos Fairview. Haga los análisis necesarios para determinar si existen elementos corrosivos, acidez y otros contaminantes pertinentes, incluso cloro, y trate al agua de manera adecuada.

El incumplimiento de este requisito anulará la garantía y podría causar la falla prematura de los tubos, las válvulas y los accesorios. Los productos que se describen en el presente, que incluyen sin ningún límite, las características, las especificaciones, los diseños, la disponibilidad y los precios de los productos, están sujetos a cambios sin aviso en cualquier momento por parte de Fairview Fittings & Mfg. y sus subsidiarias.

TABLE OF CONTENTS



SECTION A FITTINGS

AIR BRAKE FITTINGS (D.O.T. COMPRESSION FOR COPPER)	23
AIR BRAKE FITTINGS (D.O.T. COMPRESSION FOR NYLON TUBE)	24
AIR BRAKE FITTINGS-BRASS (D.O.T. PUSH-TO-CONNECT)	25 - 26
AIR BRAKE FITTINGS -FIELD KITS	27 & 29
AIR BRAKE HOSE COUPLINGS	28
AIR BRAKE HOSE MENDERS	29
AIR BRAKE TERMINAL BOLTS	28
AIR SHIFT TRANSMISSION FITTINGS AND KIT	8 - 9
AUTOMOTIVE FITTINGS	8
BRAKE LINE NUT AND ADAPTER KIT	7
COMPRESSION FITTINGS -BRASS	10 - 11
COMPRESSION FITTINGS FOR POLY TUBE -BRASS	12
COMPRESSION FITTINGS - NYLON	13 - 14
FLANGE ADAPTERS (CODE 61 & 62) -STEEL HYDRAULIC	45
FLANGE KITS -STEEL HYDRAULIC	45
FLARE BULKHEAD ADAPTERS -STEEL HYDRAULIC	44
FLARE (J.I.C. 37°) FITTINGS -BRASS	5
FLARE (J.I.C. 37°) SWIVEL ADAPTERS -STEEL HYDRAULIC	41
FLARE (S.A.E. 37°) ADAPTERS -STEEL HYDRAULIC	42 - 44
FLARE (S.A.E. 45°) FITTINGS -BRASS	2 - 4
FLARELESS ADAPTERS -STEEL HYDRAULIC	49
GAS APPLIANCE ORIFICES -BRASS	37
GREASE FITTINGS AND KITS	39
GREASE WHIP COUPLER	39
HVAC SERVICE KIT	4
INVERTED FLARE FITTINGS -BRASS	6 - 7
L.P.G. ADAPTERS FITTINGS AND VALVES	35 - 36
MULTI-CUTTER	16
NPSM SWIVEL ADAPTERS -STEEL HYDRAULIC	53
O-RING BOSS ADAPTERS -STEEL HYDRAULIC	46 - 47, 52
O-RING FACE SEAL ADAPTERS -STEEL HYDRAULIC	48 - 49
PILOT LINE KIT	37
PIPE FITTINGS -BLACK IRON	21 - 23
PIPE FITTINGS -BRASS	17 - 20
PIPE FITTINGS -STEEL HYDRAULIC	50 - 52
PIPE FITTINGS -MERCHANT STEEL	23
PROPANE GAS FITTINGS	32 - 34
PUSH-TO-CONNECT FITTINGS -BRASS	15 - 16
RV FIELD KIT	5
SWEAT FITTINGS -BRASS	9
THREADED SLEEVE FITTINGS -BRASS	8
WATER HOSE FITTINGS AND ACCESSORIES	30 - 31
WATER HOSE QUICK DISCONNECT	31
WELDING FITTINGS -BRASS	38

SECTION B HOSE ENDS

COMBINATION HOSE NIPPLES \ MENDERS -STEEL	58
CRIMP INSTRUCTIONS / SPECS	71, 73, 74, 76 - 77
FERRULES -BRASS	58
FUEL LINE HOSE BARBS -BRASS	58
GRIP-TITE HOSE BARBS -BRASS	59
HOSE BARB FITTINGS -BRASS	56 - 58
HOSE BARB FITTINGS -NYLON	57
PEX FITTINGS AND KITS - BRASS	62
PEX FITTINGS - PLASTIC	61
PTFE HOSE CRIMP ENDS -ONE PIECE STYLE	71
PTFE HOSE REUSABLE ENDS	72
REUSABLE HOSE ENDS -BRASS	63
RING BARB FITTINGS -BRASS	63
S.A.E. 100R1, T1SN HOSE CRIMP ENDS -BITE WIRE STYLE	67
S.A.E. 100R1, T1SN HOSE CRIMP ENDS -COMPRESSION STYLE	64 - 66
S.A.E. 100R1, T1SN HOSE ENDS -REUSABLE	71
S.A.E. 100R2, T2SN HOSE CRIMP ENDS -BITE WIRE STYLE	67
S.A.E. 100R2, T2SN HOSE CRIMP ENDS -COMPRESSION STYLE	64 - 66
S.A.E. 100R2, T2SN HOSE ENDS -REUSABLE	71
S.A.E. 100R3 HOSE CRIMP ENDS -COMPRESSION STYLE	64 - 65
S.A.E. 100R4 HOSE CRIMP ENDS -COMPRESSION STYLE	64 - 65
S.A.E. 100R4 HOSE INSERTS	73
S.A.E. 100R5 HOSE CRIMP ENDS	69
S.A.E. 100R5 HOSE REUSABLE ENDS	70
S.A.E. 100R7 HOSE CRIMP ENDS	73
S.A.E. 100R12 HOSE CRIMP ENDS -BITE WIRE STYLE	68 - 69
S.A.E. 100R14 HOSE CRIMP ENDS -ONE PIECE STYLE	71
S.A.E. 100R14 HOSE REUSABLE ENDS	72
S.A.E. 100R16 HOSE CRIMP ENDS -BITE WIRE STYLE	67
S.A.E. 100R16 HOSE CRIMP ENDS -COMPRESSION STYLE	64 - 66
S.A.E. 100R17 HOSE CRIMP ENDS -BITE WIRE STYLE	67
S.A.E. 100R17 HOSE CRIMP ENDS -COMPRESSION STYLE	64 - 66
SELF STORING AIR HOSE ENDS - BRASS	87
SEWER HOSE ENDS	74
SYNFLEX PERMANENT HOSE ENDS	75 - 76
SYNFLEX REUSABLE HOSE END	75
SYNFLEX CRIMP HOSE ENDS SPECIFICATIONS CHARTS	76 - 77

SECTION C HOSE & ASSEMBLIES

AIR BRAKE HOSE (D.O.T.)	94
AIR BRAKE HOSE ASSEMBLIES (D.O.T.)	95 - 98
AIR HOSE ASSEMBLIES	80 - 87, 99
AIR HOSE ASSEMBLY REPAIR KITS	88
AIR SEAT GUN KIT	106
AIR SHIFT TRANSMISSION ASSEMBLIES	106
ARGON GAS HOSE ASSEMBLY	133
BRAKE LINE ASSEMBLIES -STEEL	140
BREATHING AIR HOSE	101
COOLANT HOSE - SILICONE	103
DISHWASHER HOSE	90
FIFTH WHEEL SLIDER ASSEMBLY	99
FIFTH WHEEL SLIDER KIT	106
FUEL LINE HOSE	101
GAS APPLIANCE CONNECTORS (N.S.F.)	134 - 137
GAS ASSEMBLIES (LPG-NATURAL) TYPE I, II, & III (C.S.A. U.L.)	123 - 133
GAS PIGTAILS AND HOGTAILS (COPPER)	139
GAS PURGE KITS	133
GENERAL PURPOSE HOSE - PVC	84 - 86
GENERAL PURPOSE HOSE - RUBBER	80 - 82
GREASE WHIP ASSEMBLIES	106
GRIP-TITE HOSE	105
HEATER HOSE	103 - 104
HYDRAULIC HOSE ASSEMBLIES	113 - 122
HYDRAULIC HOSE -S.A.E. 100R1	107 - 108
HYDRAULIC HOSE -S.A.E. 100R2	107 - 108
HYDRAULIC HOSE -S.A.E. 100R3	109, 115
HYDRAULIC HOSE -S.A.E. 100R4	109
HYDRAULIC HOSE -S.A.E. 100R5	100
HYDRAULIC HOSE -S.A.E. 100R7	110, 116 - 117
HYDRAULIC HOSE -S.A.E. 100R12	110
HYDRAULIC HOSE -S.A.E. 100R8	118
HYDRAULIC HOSE -S.A.E. 100R14	102
HYDRAULIC HOSE -S.A.E. 100R16	111
HYDRAULIC HOSE -S.A.E. 100R17	111
HYDRAULIC HOSE -S.A.E. 100R18	120
PRESSURE WASH HOSE	91
PRESSURE WASH HOSE ASSEMBLIES	92 - 93
PTFE HOSE (S.A.E. 100R14)	102
PTFE HOSE ASSEMBLIES	102
SELFSTORING COILED AIR HOSE ASSEMBLIES	86 - 87
SEWER CLEANING HOSE ASSEMBLIES	90
STAINLESS STEEL C.S.A. METAL HOSE ASSEMBLIES	138
SUPERFLEX HOSE	83
SYNFLEX HOSE	115 - 122
TORCH ASSEMBLIES (PROPANE)	236
TURBO CHARGER CONNECTORS	103
VAPOR HOSE	138
WATER HOSE ASSEMBLIES	89
WETLINE KITS	112

SECTION D TUBE

AIR BRAKE TUBE D.O.T.	142
ALUMINUM TUBE	148
COPPER TUBE	146 - 148
NYLON TUBE	143
POLYETHYLENE TUBE	145
POLYURETHANE (FUEL LINE) TUBE	143
P.V.C. - CLEAR	144
P.V.C. - CLEAR BRAIDED	144
STEEL TUBE (S.A.E. 527)	148
TAPE - PIPE LINE IDENTIFICATION	147

SECTION E CLAMPS AND TUBE STRAPS

AIR BRAKE HOSE SPACERS	156
AIR BRAKE HOSE SUPPORTS & SPRINGS	156
EXTENDED TONGUE GEAR CLAMPS	150
FLEX SEAL CLAMPS	152
FUEL INJECTION HOSE CLAMPS	153
GEAR CLAMPS	150
O-CLAMPS - (EAR CLAMPS)	153 - 156
OETIKER / TST CONVERSION CHART	155
PEX CLAMPS AND CRIMP RINGS	156
PEX TUBE SUPPORTS	156
PIPE STAY	158
PIPE SUPPORT BLOCK	158
QUICK RELEASE CLAMPS	153
SPRING LOADED GEAR CLAMPS	150
T-BOLT CLAMPS	151
TUBE STRAPS AND HANGERS	157



TABLE OF CONTENTS

SECTION F VALVES & COCKS

AIR CHUCKS	172
AIR TANK VALVES	172
ANGLE VALVES	167
BALL VALVES COMPRESSION - BRASS	168
BALL VALVES GAS (VAPOR) - BRASS	163 - 164
BALL VALVES GENERAL PURPOSE - BRASS	160
BALL VALVES MINIATURE - BRASS	161
BALL VALVES PEX - BRASS	166
BALL VALVES STEEL & STAINLESS STEEL	161 - 162
CHECK VALVES	173
DRAIN COCKS & VALVES	171
DRUM & BARREL FAUCETS	168
GATE VALVES - MOLASSES & OIL	167 - 168
GLADHANDS	174
METER VALVES	164
NEEDLE VALVES - HUMIDIFIER BRASS	165 - 166
NEEDLE VALVES - PRECISION GAS	165
OIL TANK VALVES	168
PEX WATER VALVES	166
PRESSURE PROTECTION VALVES	172
SELECTOR VALVES	167
SHUT-OFF COCKS	166, 169 - 170
SWING CHECK VALVES	173
WATER THREAD VALVES	168

SECTION G QUICK DISCONNECTS

AGRICULTURAL INTERCHANGE	178
ARO 210 / 310 INTERCHANGES	187
AUTOMOTIVE STANDARD INTERCHANGE (TRU-FLATE)	187
CEJN INTERCHANGE	190
CROSSOVER LISTING -HYDRAULIC	176
CROSSOVER LISTING -PNEUMATIC	184
HIGH PRESSURE FLUSH FACE	180
HTMA FLUSH FACE ISO 16028	180
INDUSTRIAL INTERCHANGES	185 - 186
ISO "A" INTERCHANGE.	179
ISO "B" INTERCHANGE	177
LINCOLN INTERCHANGE	188
MINIATURE PNEUMATIC	188
PRESSURE WASH COUPLINGS	191
PROPANE / NATURAL GAS COUPLINGS	192
SNAPTITE VALVED & NON-VALVED SERIES	181
SNOW PLOW	178
SWING COUPLINGS	189 - 190
THREAD-TO-CONNECT HIGH PRESS. (PARKER 3000) INTERCHANGE	179
THREAD-TO-CONNECT (UNDER PRESSURE)	183
UNIVERSAL PNEUMATIC INTERCHANGE	188
WATER COUPLINGS	191
WING SERIES (HEAVY DUTY) INTERCHANGE	182

SECTION H GAUGES

AIR PRESSURE GAUGE	195
DRY	194 - 196
GAUGE PROTECTOR COVERS	198
LIQUID FILLED	197 - 198
MOUNTING BRACKETS	198
SNUBBERS	198
TEST GAUGE	194
TRIDICATORS	196
VACUUM SERVICE	195
WATER TIGHT	194

SECTION I GAS CONTROL COMPONENTS

CSST AND FITTINGS	213 - 216
GAS CONTROL VALVE (ELECTRIC)	212
GAS DETECTOR / ALARMS	212
GAS VENT FITTINGS & PIPE	226
LIFT TRUCK CHECK CONNECTORS	227 - 228
LP-GAS CYLINDERS AND TANK EQUIPMENT	227 - 230
LP-GAS REGULATORS DOMESTIC APPLICATIONS	200 - 201
LP-GAS REGULATORS GAS GRILL (BARBECUE)	204 - 205
LP-GAS REGULATORS HIGH PRESSURE - INDUSTRIAL	206 - 207
LP-GAS REGULATORS LOW PRESSURE - R. V.	202 - 203
LP-GAS REGULATORS NATURAL OR LP GAS APPLIANCE - LINE	208
NATURAL GAS / PROPANE GAS OUTLETS	209 - 211
POLYETHYLENE GAS PIPE AND MECHANICAL FITTINGS	217 - 225

SECTION J TOOLS AND ACCESSORIES

AIR CONTROL PRESSURE REGULATOR	232
AIR GUNS AND WANDS	239
AIR VENTS AND MUFFLERS	238
BEND PROTECTORS	248
FIFTH WHEEL SLIDER CYLINDER	232
FLARING TOOLS	244
GAUGING DRILLS	237
GREASE PRODUCTS	240
HOSE CUT-OFF BLADES	248
HOSE CRIMPER AND DIES - HYDRAULIC	246
HOSE CRIMPER - MANUAL FERRULE	246
HOSE SWAGING MACHINES AND DIES - SYNFLX	247
HOSE SWAGE TOOLS - SEWER HOSE ENDS	247
HYDRONIC PRESSURE TEST KIT	242
NOZZLES (WATER)	241
NYLON SLEEVE HOSE PROTECTOR	248
PEX TOOLS & ACCESSORIES	242
PINCERS	243
ROTO REEL	243
SOLENOID VALVES	232
SPRING GUARDS	248
THREAD GAUGES	243
THREAD SEALANTS	245
TORCHES (PROPANE)	233 - 236
TUBE AND HOSE CUTTERS	243 - 244
TUBE BENDERS	244
TUBE REAMER	244
UNIVERSAL JOINT SWIVELS	243

SECTION K CABINETS AND DISPLAYS

AIR HOSE ASSEMBLY RACK	263
BIN STORAGE - WALL	253
CABINETS - DRAWER	251 - 253
CABINET - SLIDER STYLE (Up To 336 Bin)	250
DISPLAY RACK - AIR BRAKE ASSEMBLY	262
DISPLAY RACK - GANG HOOK STYLE	257
DISPLAY RACK - GEAR CLAMP	264
DISPLAY RACK - T-BOLT CLAMP	264
DISPLAY RACK - WATER HOSE ASSEMBLY	262
FITTING PACKAGES	255 - 256
LABEL SETS	254
PRODUCT SELECTION PACKAGE - GAS-FLO PRODUCTS	260 - 261
PRODUCT SELECTION PACKAGE - GREASE PRODUCTS	259
PRODUCT SELECTION PACKAGE - PNEUMATIC PRODUCTS	258
REFERENCE CHARTS & INFORMATION	265 - 267
STOCK BOXES	264

FITTINGS

BRASS - STEEL - NYLON - BLACK IRON



WHAT'S NEW IN THIS SECTION

- Air Brake Hose MenderPg 29
- Dishwasher inlet water Supply ConnectionPg 31
- LPG Adapters, Connectors and ValvesPg 35 -36

AIR BRAKE FITTINGS (D.O.T. COMPRESSION FOR COPPER)	23
AIR BRAKE FITTINGS (D.O.T. COMPRESSION FOR NYLON TUBE) ..	24
AIR BRAKE FITTINGS-BRASS (D.O.T. PUSH-TO-CONNECT) ...	25 - 26
AIR BRAKE FITTINGS -FIELD KITS	27 & 29
AIR BRAKE HOSE COUPLINGS	28
AIR BRAKE HOSE MENDERS	29
AIR BRAKE TERMINAL BOLTS	28
AIR SHIFT TRANSMISSION FITTINGS AND KIT	8 - 9
AUTOMOTIVE FITTINGS	8
BRAKE LINE NUT AND ADAPTER KIT	7
COMPRESSION FITTINGS -BRASS	10 - 11
COMPRESSION FITTINGS FOR POLY TUBE -BRASS	12
COMPRESSION FITTINGS - NYLON	13 - 14
FLANGE ADAPTERS (CODE 61 & 62) -STEEL HYDRAULIC	45
FLANGE KITS -STEEL HYDRAULIC	45
FLARE (J.I.C. 37°) FITTINGS -BRASS	5
FLARE (J.I.C. 37°) SWIVEL ADAPTERS -STEEL HYDRAULIC	41
FLARE (S.A.E. 37°) ADAPTERS -STEEL HYDRAULIC	42 - 44
FLARE (S.A.E. 45°) FITTINGS -BRASS	2 - 4
FLARE BULKHEAD ADAPTERS -STEEL HYDRAULIC	44
FLARELESS ADAPTERS -STEEL HYDRAULIC	49
GAS APPLIANCE ORIFICES -BRASS	37
GREASE FITTINGS AND KITS	39
GREASE WHIP COUPLER	39
HVAC SERVICE KIT	4
INVERTED FLARE FITTINGS -BRASS	6 - 7
L.P.G. ADAPTERS FITTINGS AND VALVES	35 - 36
MULTI-CUTTER	16
NPSM SWIVEL ADAPTERS -STEEL HYDRAULIC	53
O-RING BOSS ADAPTERS -STEEL HYDRAULIC	46 - 47, 52
O-RING FACE SEAL ADAPTERS -STEEL HYDRAULIC	48 - 49
PILOT LINE KIT	37
PIPE FITTINGS -BLACK IRON	21 - 23
PIPE FITTINGS -BRASS	17 - 20
PIPE FITTINGS -STEEL HYDRAULIC	50 - 52
PIPE FITTINGS -MERCHANT STEEL	23
PROPANE GAS FITTINGS	32 - 34
PUSH-TO-CONNECT FITTINGS -BRASS	15 - 16
RV FIELD KIT	5
SWEAT FITTINGS -BRASS	9
THREADED SLEEVE FITTINGS -BRASS	8
WATER HOSE FITTINGS AND ACCESSORIES	30 - 31
WATER HOSE QUICK DISCONNECT	31
WELDING FITTINGS -BRASS	38

A



FORGED NUT Long Standard Type

PART No.	Tube
39-4	1/4
39-5	5/16
39-6	3/8
39-8	1/2
39-10	5/8
39-12	3/4



FORGED NUT Short Standard Type

PART No.	Hex Size	Tube
40-3	1/2	3/16
40-4	5/8	1/4
40-5	11/16	5/16
40-6	13/16	3/8
40-8	15/16	1/2
40-10	1-1/16	5/8
40-12	1-5/16	3/4
40-14	1-5/8	7/8

	Reducing	Tube
40R-64	13/16	3/8 to 1/4
40R-86	15/16	1/2 to 3/8
40R-106	1-1/16	5/8 to 3/8
40R-108	1-1/16	5/8 to 1/2



MILLED NUT Short Type

PART No.	Length	Tube
41S-3	5/8	3/16
41S-4	3/4	1/4
41S-5	7/8	5/16
41S-6	7/8	3/8
41S-8	1	1/2

FORGED NUTS

PART No.	Length	Tube
FO41S-6	7/8	3/8
FO41S-8	1	1/2
FO41S-10	1-1/8	5/8
FO41S-12	1-1/2	3/4
FO41S-16	1-3/4	1

NOTE: For reducing size use 40R series.



MILLED NUT Long Type

PART No.	Length	Tube
41-3	13/16	3/16
41-4	15/16	1/4
41-5	1-1/8	5/16
41-6	1-5/16	3/8
41-8	1-5/8	1/2
41-10	1-7/8	5/8
41-12	2-3/16	3/4



BULKHEAD UNION Tube to Tube

PART No.	Tube	Description
31-6	3/8	INCLUDES L.N.
31-8	1/2	INCLUDES L.N.

NOTE: Locknuts supplied in steel.

Note: Fairview 40 Series Flare Nuts are hot forged and marked C37700 in accordance with CAN/CSA-B149 gas installation code requirements.



TUBE COUPLING Female Flare to Female Flare

PART No.	Tube
32-4	1/4
32-6	3/8



TUBE COUPLING Swivel Flare (FORGED NUTS)

PART No.	Tube
34-4	1/4
34-5	5/16
34-6	3/8
34-8	1/2
34-10	5/8
34-12	3/4

	Reducing
34R-64	3/8 to 1/4
34R-86	1/2 to 3/8



TUBE COUPLING Female Flare to Male Flare

PART No.	Tube Female	Tube Male
35-46	1/4	3/8
35-64	3/8	1/4
35-68	3/8	1/2
35-84	1/2	1/4
35-86	1/2	3/8
35-810	1/2	5/8
35-108	5/8	1/2

NOTE: Female size listed first in above part

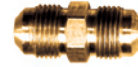

UNION COUPLING Tube to Tube

PART No.	Tube
42-2	1/8
42-3	3/16
42-4	1/4
42-5	5/16
42-6	3/8
42-8	1/2
42-10	5/8
42-12	3/4

PART No.	Reducing Tube
42R-64	3/8 to 1/4
42R-65	3/8 to 5/16
42R-84	1/2 to 1/4
42R-86	1/2 to 3/8
42R-106	5/8 to 3/8
42R-108	5/8 to 1/2
42R-128	3/4 to 1/2

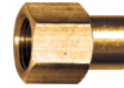

CONNECTOR Female Flare to Female Pipe

PART No.	Tube	Pipe
30-6B	3/8	1/4



CONNECTOR Female Flare to Male Pipe

PART No.	Tube	Pipe
33-4A	1/4	1/8
33-4B	1/4	1/4
33-6B	3/8	1/4
33-8C	1/2	3/8
33-8D	1/2	1/2

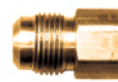

CONNECTOR Tube To Female Pipe

PART No.	Tube	Pipe
46-3A	3/16	1/8
46-4A	1/4	1/8
46-4B	1/4	1/4
46-4C	1/4	3/8
46-4D	1/4	1/2
46-5A	5/16	1/8
46-5B	5/16	1/4
46-6A	3/8	1/8
46-6B	3/8	1/4
46-6C	3/8	3/8
46-6D	3/8	1/2
46-6E	3/8	3/4
46-8B	1/2	1/4
46-8C	1/2	3/8
46-8D	1/2	1/2
46-8E	1/2	3/4
46-10D	5/8	1/2
46-10E	5/8	3/4
46-12D	3/4	1/2
46-12E	3/4	3/4

BRASS S.A.E. 45° FLARE



A

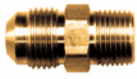

CONNECTOR Tube To Male Pipe

PART No.	Tube	Pipe
48-2A	1/8	1/8
48-3A	3/16	1/8
48-4A	1/4	1/8
48-4B	1/4	1/4
48-4C	1/4	3/8
48-4D	1/4	1/2
48-5A	5/16	1/8
48-5B	5/16	1/4
48-5C	5/16	3/8
48-6A	3/8	1/8
48-6B	3/8	1/4
48-6C	3/8	3/8
48-6D	3/8	1/2
48-6E	3/8	3/4
48-8B	1/2	1/4
48-8C	1/2	3/8
48-8D	1/2	1/2
48-8E	1/2	3/4
48-10C	5/8	3/8
48-10D	5/8	1/2
48-10E	5/8	3/4
48-12D	3/4	1/2
48-12E	3/4	3/4
48-14E	7/8	3/4
48-16E	1	3/4
48-16H	1	1



90° ELBOW Tube To Male Pipe

PART No.	Tube	Pipe
49-3A	3/16	1/8
49-4A	1/4	1/8
49-4B	1/4	1/4
49-4C	1/4	3/8
49-4D	1/4	1/2
49-5A	5/16	1/8
49-5B	5/16	1/4
49-5C	5/16	3/8
49-6A	3/8	1/8
49-6B	3/8	1/4
49-6C	3/8	3/8
49-6D	3/8	1/2
49-6E	3/8	3/4
49-8B	1/2	1/4
49-8C	1/2	3/8
49-8D	1/2	1/2
49-8E	1/2	3/4
49-10C	5/8	3/8
49-10D	5/8	1/2
49-10E	5/8	3/4
49-12D	3/4	1/2
49-12E	3/4	3/4
49-12H	3/4	1
49-16H	1	1



FLANGED 90° ELBOW Tube To Female Pipe

PART No.	Tube	Pipe
S50-6D	3/8	1/2
S50-8D	1/2	1/2
S50-10D	5/8	1/2



90° ELBOW Tube To Swivel Female Flare

PART No.	Tube
47-44	1/4
47-66	3/8

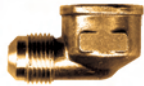

90° ELBOW Tube To Female Pipe

PART No.	Tube	Pipe
50-3A	3/16	1/8
50-4A	1/4	1/8
50-4B	1/4	1/4
50-6A	3/8	1/8
50-6B	3/8	1/4
50-6C	3/8	3/8
50-6D	3/8	1/2
50-6E	3/8	3/4
50-8C	1/2	3/8
50-8D	1/2	1/2
50-8E	1/2	3/4
50-10C	5/8	3/8
50-10D	5/8	1/2
50-10E	5/8	3/4
50-12D	3/4	1/2
50-12E	3/4	3/4



90° ELBOW Tube To Tube

PART No.	Tube
55-4	1/4
55-5	5/16
55-6	3/8
55-8	1/2
55-10	5/8
55-12	3/4
	Reducing
55R-64	3/8 to 1/4
55R-86	1/2 to 3/8
55R-108	5/8 to 1/2



45° ELBOW Tube To Male Pipe

PART No.	Tube	Pipe
54-4A	1/4	1/8
54-4B	1/4	1/4
54-4C	1/4	3/8
54-5A	5/16	1/8
54-5B	5/16	1/4
54-6B	3/8	1/4
54-6C	3/8	3/8
54-6D	3/8	1/2
54-8C	1/2	3/8
54-8D	1/2	1/2
54-10D	5/8	1/2
54-12D	3/4	1/2
54-12E	3/4	3/4



TEE Tube To Female Pipe

PART No.	Tube	Pipe
36-4B	1/4	1/4
36-6B	3/8	1/4
36-6C	3/8	3/8
36-8C	1/2	3/8
36-8D	1/2	1/2



TEE Ends Male And Female Pipe Center Tube

PART No.	Tube	Pipe
53-4A	1/4	1/8

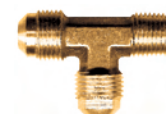

TEE Ends Tube And Male Pipe Center Tube

PART No.	Tube	Pipe
51-4A	1/4	1/8
51-4B	1/4	1/4
51-6A	3/8	1/8
51-6B	3/8	1/4
51-6C	3/8	3/8
51-6D	3/8	1/2
51-8C	1/2	3/8
51-8D	1/2	1/2
51-10D	5/8	1/2



BRASS S.A.E. 45° FLARE

A



TEE Tube Three Ends

PART No.	Tube
44-3	3/16
44-4	1/4
44-5	5/16
44-6	3/8
44-8	1/2
44-10	5/8
44-12	3/4

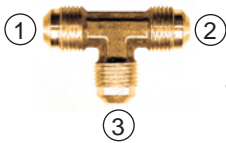

TEE Tube Three Ends

PART No.	Reducing		
	1	2	3
44R-68	3/8	3/8	3/8
44R-86	1/2	1/2	3/8
44R-866	1/2	3/8	3/8
44R-868	1/2	3/8	1/2
44R-810	1/2	1/2	5/8
44R-106	5/8	5/8	3/8
44R-108	5/8	5/8	1/2
44R-1088	5/8	1/2	1/2
44R-128	3/4	3/4	1/2

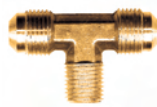

TEE Ends Tube Center Male Pipe

PART No.	Tube	Pipe
45-3A	3/16	1/8
45-4A	1/4	1/8
45-4B	1/4	1/4
45-5A	5/16	1/8
45-5B	5/16	1/4
45-6B	3/8	1/4
45-6C	3/8	3/8
45-6D	3/8	1/2
45-8B	1/2	1/4
45-8C	1/2	3/8
45-8D	1/2	1/2
45-10D	5/8	1/2
45-12D	3/4	1/2
45-12E	3/4	3/4

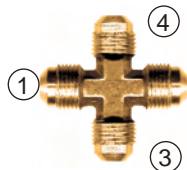

CROSS Tube Four Ends

PART No.	Reducing			
	1	2	3	4
52-6		3/8		
52-8		1/2		
52R-866	1/2	3/8	3/8	3/8



SEALING CAP NUT

PART No.	Tube
56-4	1/4
56-5	5/16
56-6	3/8
56-8	1/2
56-10	5/8
56-12	3/4



SEALING PLUG

PART No.	Tube
58-4	1/4
58-5	5/16
58-6	3/8
58-8	1/2
58-10	5/8
58-12	3/4



COPPER FLARE GASKET

PART No.	Tube
59-4	1/4
59-6	3/8
59-8	1/2
59-10	5/8
59-12	3/4

HVAC SERVICE KIT

Designed for HVAC Gas System Maintenance

Service Kit Selection: PART No. FKGf-KIT-1

Includes a selection of products for the Service / Maintenance of Gas Systems.

Single sided carry case, with handle.

Gas Systems should only be maintained by Licensed Technicians.

Kit Dimensions

Height: 11.75 In.

Width: 14.5 In.

Depth: 2.375 In.



Item	Description	Qty.	PART No.	Description	Qty.	PART No.	Description	Qty.
40-6	3/8 Flare Nut	3	49-8C	1/2 Flare to 3/8 Pipe Elbow	1	60-4	1/4 Compression Sleeve	10
40-8	1/2 Flare Nut	2	49-8D	1/2 Flare to 1/2 Pipe Elbow	1	61-2	1/8 Compression Nut	10
42-6	3/8 Flare Union	2	56-4	1/4 Sealing Flare Cap Nut	4	61-3	3/16 Compression Nut	10
42-8	1/2 Flare Union	2	56-6	3/8 Sealing Flare Cap Nut	3	61-4	1/4 Compression Nut	10
48-6B	3/8 Flare to 1/4 Pipe	2	56-8	1/2 Sealing Flare Cap Nut	2	81-4N	1/4 Breakaway Pilot Nut	10
48-6C	3/8 Flare to 3/8 Pipe	2	58-4	1/4 Sealing Flare Plug	4	121-M8UL	Thread Sealant	1
48-6D	3/8 Flare to 1/2 Pipe	2	58-6	3/8 Sealing Flare Plug	3	BV5042-6	3/8 Flare Ball Valve	1
48-8C	1/2 Flare to 3/8 Pipe	2	58-8	1/2 Sealing Flare Plug	2	BV5042-8	1/2 Flare Ball Valve	1
48-8D	1/2 Flare to 1/2 Pipe	2	58-10	5/8 Sealing Flare Plug	2	GO100-72	Orifice Repair Adapter	10
49-6B	3/8 Flare to 1/4 Pipe Elbow	2	60-2	1/8 Compression Sleeve	10	GO3020	Pilot Broach Hex Handle	3
49-6C	3/8 Flare to 3/8 Pipe Elbow	2	60-3	3/16 Compression Sleeve	10	TTSG-2	Thread Sealant Tube	1
						PM-GFRB-1	Reference Booklet	1

R.V. FIELD KIT

Designed for Recreational Vehicle Propane Gas Repairs



R.V. Repair Selection: PART No. FKRV-KIT-1

This One Sided Case is designed for use in the field. Kit includes a selection of items to complete many Recreational Vehicle propane product repairs.



Kit Dimensions

Height: 11.75 In.

Width: 14.5 In.

Depth: 2.375 In.

Item	Description	Qty.	Item	Description	Qty.	Item	Description	Qty.
34-6	Tube Coupling 3/8 Swivel	2	46-8D	1/2 Flare to 1/2 FPT	1	81-4N	Breakaway Pilot Nut 1/4	3
34-8	Tube Coupling 1/2 Swivel	2	48-6B	3/8 Flare to 1/4 Pipe	3	121-M8UL	Thread Sealant Tape	1
40-6	Nut 3/8 Flare	5	48-6C	3/8 Flare to 3/8 Pipe	3	148-4B	1/4 Inv. Flare to 1/4 MPT	2
40-8	Nut 1/2 Flare	2	48-6D	3/8 Flare to 1/2 Pipe	2	149-4B	1/4 Inv. Flare to 1/4 MPT	2
42-6	Union 3/8 Flare	3	49-6C	Elbow 3/8 Flare to 3/8 Pipe	2	2000	Manifold Tee 1/4 Inv. Flare to 1/4 MPT	1
42-8	Union 1/2 Flare	1	50-6D	Flanged Elbow 3/8 Flare X 1/2 FPT	2	2002	Tailpeice Assy. 1/4	2
44-6	Tee 3/8 Flare	2	55-6	Elbow 3/8 Tube to Tube	2	2003-T	Tailpeice Assy. w/Excess Flow	2
46-6B	3/8 Flare to 1/4 FPT	2	56-6	Sealing Cap Nut 3/8 Flare	3	QD-GMRVN4-4M	Gas-Flo QD Nipple	2
46-6C	3/8 Flare to 3/8 FPT	2	56-8	Sealing Cap Nut 1/2 Flare	2	GR-1B-500	1-5/16 QCC1 Connector	2
46-6D	3/8 Flare to 1/2 FPT	2	58-6	Sealing Plug 3/8 Flare	5	G3020	Pilot Broach w/ Handle	2
						TTSG-2	Tube of Thread Sealant	1

BRASS J.I.C. 37° FLARE



NUT

PART No.	Tube
3720-4	1/4
3720-6	3/8
3720-8	1/2



SLEEVE

PART No.	Tube
3721-4	1/4
3721-6	3/8
3721-8	1/2



UNION COUPLING

PART No.	Tube
3742-4	1/4
3742-6	3/8
3742-8	1/2

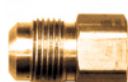

CONNECTOR

Tube To

Female Pipe

PART No.	Tube	Pipe
3746-4A	1/4	1/8
3746-6B	3/8	1/4
3746-8D	1/2	1/2

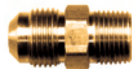

CONNECTOR

Tube To

Male Pipe

PART No.	Tube	Pipe
3748-4A	1/4	1/8
3748-4B	1/4	1/4
3748-6A	3/8	1/8
3748-6B	3/8	1/4
3748-6C	3/8	3/8
3748-8C	1/2	3/8
3748-8D	1/2	1/2
3748-10D	5/8	1/2
3748-12E	3/4	3/4



90° ELBOW

Tube To

Male Pipe

PART No.	Tube	Pipe
3749-4A	1/4	1/8
3749-4B	1/4	1/4
3749-6B	3/8	1/4
3749-6C	3/8	3/8
3749-8C	1/2	3/8
3749-10D	5/8	1/2
3749-12E	3/4	3/4



45° ELBOW

Tube To

Male Pipe

PART No.	Tube	Pipe
3754-4A	1/4	1/8
3754-4B	1/4	1/4
3754-6B	3/8	1/4
3754-6C	3/8	3/8
3754-8C	1/2	3/8

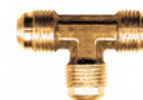

TEE Tube Three Ends

PART No.	Tube
3744-4	1/4
3744-6	3/8



BRASS S.A.E. 45° INVERTED FLARE

A



BRASS NUT

PART No.	Tube	Thread
141-3	3/16	3/8-24
141-4	1/4	7/16-24
141-5	5/16	1/2-20
141-6	3/8	5/8-18
141-8	1/2	3/4-18
141-10	5/8	7/8-18

STEEL NUT

PART No.	Tube	Thread
S141-2	1/8	5/16-28
S141-3	3/16	3/8-24
S141-3-7/16	3/16	7/16-24
S141-3-1/2	3/16	1/2-20
S141-3-9/16	3/16	9/16-18
S141-4	1/4	7/16-24
S141-4-1/2	1/4	1/2-20
S141-4-9/16	1/4	9/16-18
S141-5	5/16	1/2-20
S141-6	3/8	5/8-18
S141-8	1/2	3/4-18
S141-10	5/8	7/8-18



SPECIALTY NUTS European Standard (Colors May Vary)

PART No.	Tube	Thread
SE141-3	3/16	M10 X 1.0
SE141-3-11MM	3/16	M11 X 1.5
SE141-3-12MM	3/16	M12 X 1.0
SE141-3-13MM	3/16	M13 X 1.5



Japanese Standard

PART No.	Tube	Thread
SJ141-3	3/16	M10 X 1.0 (with 11mm Hex)



British Standard

PART No.	Tube	Thread
SB141-3	3/16	3/8-24



STEEL NUT (Long Style)

PART No.	Tube
SL141-3	3/16
SL141-4	1/4

European Standard

PART No.	Tube	Thread
SLE141-3	3/16	M10 X 1.0

Japanese Standard

PART No.	Tube	Thread
SLJ141-3	3/16	M10 X 1.0



FUEL LINE NUT GM

PART No.	Tube	Thread
SFL-5-14MM	5/16	14mm X 1.5
SFL-6-16MM	3/8	16mm X 1.5



SEALING PLUG

PART No.	Tube
PL141-3	3/16
PL141-4	1/4
PL141-5	5/16
PL141-6	3/8



UNION COUPLING Tube To Tube

PART No.	Tube
142-2	1/8
142-3	3/16
142-4	1/4
142-5	5/16
142-6	3/8
142-8	1/2

European Standard Union (Bubble Flare 10x1.0mm Thread)

PART No.	Tube
142EU-3	3/16

Japanese Standard Union (10x1.0mm Thread)

PART No.	Tube
142JA-3	3/16

British Standard Union

PART No.	Tube
142BR-3	3/16



UNION COUPLING Tube To Tube Metric Bubble Flare

PART No.	Tube	Thread
142MM-3	3/16	M10.0 X 1.0

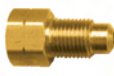

ADAPTER Tube To Tube European Std. (Bubble Flare 10x1.0mm Thread)

PART No.	Tube
SE143-3	3/16

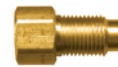

ADAPTER Tube To Tube Japanese Std. (10x1.0mm Thread)

PART No.	Tube
SJ143-3	3/16

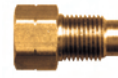

DUAL MASTER CYLINDER ADAPTER

PART No.	Male	Female
	Tube	Tube
WH-1441	3/16	3/16
WH-7897	5/16	3/16



METRIC ADAPTER Male Metric To Female Tube

PART No.	Male	Female
	Tube	Tube
WH-1442	M10X1.0	3/16 (3/8-24)
WH-1443	M10X1.0	3/16 (3/8-24)
WH-7935	M11X1.5	3/16 (M10X1.0)
WH-7936	M12X1.0	3/16 (M10X1.0)
WH-7937	M13X1.5	3/16 (M10X1.0)

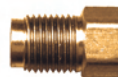

DUAL MASTER CYLINDER ADAPTER

PART No.	Male	Female
	Tube	Tube
WH-7727 *	5/16	1/4
WH-7732 *	7/16-20	1/4
WH-7817 *	5/16	3/16
WH-7908	1/4 (9/16-18)	1/4
WH-7909	5/16	3/16
WH-7910	3/16 (9/16-20)	3/16
WH-7911	3/16 (9/16-18)	3/16
WH-7912	5/16	3/16 (9/16-18)
WH-7913	3/16 (9/16-18)	3/16 (1/2-20)
WH-7917	1/4	5/16

* Seals on Hex Face

BRASS S.A.E. 45° INVERTED FLARE



A



CONNECTOR
Tube To
Male Pipe

PART No.	Tube	Pipe
148-2A	1/8	1/8
148-3A	3/16	1/8
148-4A	1/4	1/8
148-4B	1/4	1/4
148-5A	5/16	1/8
148-5B	5/16	1/4
148-6A	3/8	1/8
148-6B	3/8	1/4
148-6C	3/8	3/8
148-8B	1/2	1/4
148-8C	1/2	3/8
148-8D	1/2	1/2
148-10D	5/8	1/2
148-12E	3/4	3/4



90° ELBOW
Tube To
Female Pipe

PART No.	Tube	Pipe
150-4A	1/4	1/8
150-6B	3/8	1/4



TEE
Ends Tube
Male Pipe
Center Tube

PART No.	Tube	Pipe
151-3A	3/16	1/8
151-4A	1/4	1/8
151-6B	3/8	1/4



45° ELBOW
Tube To
Male Pipe

PART No.	Tube	Pipe
154-3A	3/16	1/8
154-4A	1/4	1/8
154-6B	3/8	1/4
154-8C	1/2	3/8

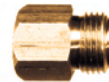

CONNECTOR
Female Tube
To
Male Tube

PART No.	Female Tube	Male Tube
WH-7818	3/16	1/4
WH-7828	1/4	3/16
WH-7829	1/4	5/16



90° ELBOW
Tube To
Male Pipe

PART No.	Tube	Pipe
149-2A	1/8	1/8
149-3A	3/16	1/8
149-4A	1/4	1/8
149-4B	1/4	1/4
149-5A	5/16	1/8
149-5B	5/16	1/4
149-6A	3/8	1/8
149-6B	3/8	1/4
149-6C	3/8	3/8
149-8C	1/2	3/8
149-8D	1/2	1/2
149-10D	5/8	1/2
149-12D	3/4	1/2



TEE
Tube
Three Ends

PART No.	Tube
144-3	3/16
144-4	1/4
144-5	5/16
144-6	3/8



CONNECTOR
Tube To
Female Pipe

PART No.	Tube	Pipe
146-3A	3/16	1/8
146-4A	1/4	1/8
146-6B	3/8	1/4



TEE
Ends Tube
Center
Male Pipe

PART No.	Tube	Pipe
145-3A	3/16	1/8
145-4A	1/4	1/8



CONNECTOR
45° Flare To
Male Inverted
Flare

PART No.	Flare	Tube
WH-1522	1/4	1/4
WH-1554	3/8	7/16

BRAKE LINE NUT AND ADAPTER KIT

Service Kit Selection: PART No. BLN-KIT-1

Fairview's Brake Line Nut and Adapter kit provides the most popular brake line fittings all in a light weight compact kit. It is ideal for any shop.

Flip Top carry case.

PART No.	Description	Qty.	PART No.	Description	Qty.
142-3	Union, 3/16 FINV FL	10	SE141-3	Steel Nut, Euro,3/16	10
142-4	Union, 1/4 FINV FL	10	SE141-3-11MM	Steel Nut, Euro,3/16,11MM	6
142-5	Union, 5/16 FINV FL	4	SE141-3-12MM	Steel Nut, Euro,3/16,12MM	6
142EU-3	Union, 3/16, Euro	1	SE141-3-13MM	Steel Nut, Euro, 3/16,13MM	6
142JA-3	Union, 3/16, Japanese	1	SE143-3	Adapter, Euro, 3/16	1
S141-3	Steel Nut, 3/16	10	SFL-5-14MM	Fuel Line Nut, 14MM, GM	4
S141-3-7/16	Steel Nut, 3/16x7/16	10	SFL-6-16MM	Fuel Line Nut, 16MM, GM	4
S141-3-1/2	Steel Nut, 3/16x1/2	10	SJ141-3	Steel Nut,Japanese, 3/16	5
S141-3-9/16	Steel Nut, 3/16x9/16	6	SJ143-3	Adapter, Japanese, 3/16	1
S141-4	Steel Nut, 1/4	10	SL141-3	Steel Long Nut, 3/16	10
S141-4-1/2	Steel Nut, 1/4x1/2	6	SL141-4	Steel Long Nut,1/4	10
S141-4-9/16	Steel Nut, 1/4x9/16	6	SLJ141-3	Long Nut,10MMx1.0, VW/Toy/GM	5
S141-5	Steel Nut, 5/16	6			



Overall:

Height	6-7/8 inches
Width	10-3/4 inches
Depth	1-3/4 inches



AUTOMOTIVE FITTINGS

A

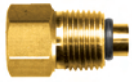

METRIC POWER STEERING ADAPTER
Female Inverted Flare To Metric Male Thread

PART No.	Tube	Thread
WH-1446	3/8	M16X1.5
WH-1447	3/8	M18X1.5



FUEL LINE ADAPTER
Male Inverted Flare To Male Pipe

PART No.	Tube	Pipe
WH-1514	1/2-20	1/8



PART No. WH-1548

THROTTLE STOP

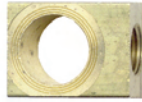

PART No. WH-7709

INVERTED FLARE BRAKE FITTING

Tube	Bolt Hole
1/4	19/32



PART No. WH-7812
WH-7765

INVERTED FLARE STRAP TEE ASSEMBLY

Tube	Bolt Hole
3/16	11/32
1/4	11/32



PART No. WH-7805

INVERTED FLARE REAR AXLE TEE

Tube Seat	Bolt Hole	Hose Port
3/16	9/32	3/8-24



PART No. WH-7900

INVERTED FLARE TOWED TRAILER BRAKE TEE

Tube
3/16



PART No. WH-6600

GASOLINE SHUT-OFF with SCREEN FILTER

Hose I.D.	Pipe
1/4	1/8

BRASS THREADED SLEEVE TUBE FITTINGS

(FOR USE WITH BLT TUBE: SEE PAGE 148)



NUT

PART No.	Tube
181-2	1/8
181-3	3/16
181-4	1/4



CONNECTOR Tube To Male Pipe

PART No.	Tube	Pipe
188-2A	1/8	1/8
188-3A	3/16	1/8
188-4A	1/4	1/8
188-6B	3/8	1/4



90° ELBOW Tube To Male Pipe

PART No.	Tube	Pipe
189-2A	1/8	1/8
189-3A	3/16	1/8
189-4A	1/4	1/8

AIR SHIFT TRANSMISSION KIT

PART No. ASTM-KIT

Fairview's Air Shift Transmission Kit has a selection of fittings in a light weight compact kit. It is ideal for any shop.

Kit Contains:

PART No.	Description	Qty
862-2	Union, 1/8 Tube	3
862-2-1/2	Union, 5/32 Tube	3
868-2-1	Connector, 1/8 Tube 1/16 Pipe	3
868-2-1/2-1	Connector, 5/32 Tube 1/16 Pipe	3
868-2-1/2A	Connector, 5/32 Tube 1/8 Pipe	3
868-2A	Connector, 1/8 Tube 1/8 Pipe	3
869-2-1/2A	Elbow, 5/32 Tube 1/8 Pipe	3
869-2A	Elbow, 1/8 Tube 1/8 Pipe	3
FKTM-BOX	Multi-compartment box	1



ASTM Fittings Have split sleeves

Kit Dimensions
Height: 3.50 In.
Width: 6.25 In.
Depth: 1.25 In.



BRASS AIR SHIFT TRANSMISSION FITTINGS



SLEEVE

PART No.	Tube	Fuller No.
860-2	1/8	83001
860-2-1/2	5/32	83002



**UNION
COUPLING**

PART No.	Tube	Fuller No.
862-2	1/8	84101
862-2-1/2	5/32	84102



**90° ELBOW
Tube To
Male Pipe**

PART No.	Tube	Pipe	Fuller No.
869-2A	1/8	1/8	85002
869-2-1/2A	5/32	1/8	85001



NUT

PART No.	Tube	Fuller No.
861-2	1/8	83501
861-2-1/2	5/32	83502



**CONNECTOR
Tube To
Male Pipe**

PART No.	Tube	Pipe	Fuller No.
868-2-1	1/8	1/16	84001
868-2A	1/8	1/8	84002
868-2-1/2-1	5/32	1/16	83003
868-2-1/2A	5/32	1/8	N/A

TO ASSEMBLE

- 1 PLACE NUT AND SLEEVE OVER TUBE
- 2 PUSH TUBE INTO FITTING AS FAR AS POSSIBLE
- 3 FINGER TIGHTEN NUT
4. COMPLETE SEAL WITH WRENCH ONE FULL TURN



See page 106 for D.O.T. Air Shift Transmission Assemblies

BRASS SWEAT FITTINGS

(Bar Stock)



**UNION
Female Solder
Both Ends**

PART No.	Type K / L	Actual
	Size	Tube O.D.
42SW-10	1/2	5/8
42SW-14	3/4	7/8



**CONNECTOR
Female Solder
End
To Female Pipe**

PART No.	Type K / L	Actual
	Size	Tube O.D. Pipe
46SW-10B	1/2	5/8 1/4
46SW-10C	1/2	5/8 3/8
46SW-10D	1/2	5/8 1/2
46SW-10E	1/2	5/8 3/4
46SW-14D	3/4	7/8 1/2
46SW-14E	3/4	7/8 3/4

46SW SERIES IS ANNEALED (HEAT TREATED)
TO HELP PREVENT CRACKING.

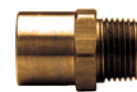

**CONNECTOR
Female Solder
End
To Male Pipe**

PART No.	Type K / L	Actual
	Size	Tube O.D. Pipe
48SW-10B	1/2	5/8 1/4
48SW-10C	1/2	5/8 3/8
48SW-10D	1/2	5/8 1/2
48SW-10E	1/2	5/8 3/4
48SW-14D	3/4	7/8 1/2
48SW-14E	3/4	7/8 3/4

A



STANDARD SLEEVE

PART No.	Tube
60-2	1/8
60-2-1/2	5/32
60-3	3/16
60-4	1/4
60-5	5/16
60-6	3/8
60-7	7/16
60-8	1/2
60-10	5/8
60-12	3/4
60-14	7/8
60-16	1



IN-LINE SLEEVE

PART No.	Tube
260-2	1/8
260-3	3/16
260-4	1/4
260-6	3/8
260-8	1/2

THIS SLEEVE IS FOR USE WITH NYLON TUBE FEATURED ON PAGE 143.



STANDARD NUT

PART No.	Tube
61-2	1/8
61-2-1/2	5/32
61-3	3/16
61-4	1/4
61-5	5/16
61-6	3/8
61-7	7/16
61-8	1/2
61-10	5/8
61-12	3/4
61-14	7/8
61-16	1



CAPTURED SLEEVE

PART No.	Tube
61CS-4	1/4
61CS-6	3/8



CAP

PART No.	Tube
61CAP-4	1/4
61CAP-6	3/8
61CAP-8	1/2
61CAP-10	5/8



LONG NUT

PART No.	Tube
161-6	3/8
161-10	5/8

LONG NUTS PROVIDE EXTRA TUBE SUPPORT WHEN SEVERE VIBRATION IS A FACTOR.



UNION COUPLING

PART No.	Tube
62-2	1/8
62-2-1/2	5/32
62-3	3/16
62-4	1/4
62-5	5/16
62-6	3/8
62-8	1/2
62-10	5/8
62-12	3/4
62-14	7/8

PART No.	Grease Nipple
62GR-6	3/8

PART No.	Reducing
62R-42	1/4 to 1/8
62R-43	1/4 to 3/16
62R-54	5/16 to 1/4
62R-64	3/8 to 1/4
62R-65	3/8 to 5/16
62R-86	1/2 to 3/8
62R-106	5/8 to 3/8
62R-108	5/8 to 1/2

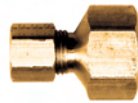

CONNECTOR Tube To Female Pipe

PART No.	Tube	Pipe
66-2A	1/8	1/8
66-3A	3/16	1/8
66-4A	1/4	1/8
66-4B	1/4	1/4
66-4C	1/4	3/8
66-4D	1/4	1/2
66-5A	5/16	1/8
66-5B	5/16	1/4
66-6A	3/8	1/8
66-6B	3/8	1/4
66-6C	3/8	3/8
66-6D	3/8	1/2
66-8C	1/2	3/8
66-8D	1/2	1/2
66-10C	5/8	3/8
66-10D	5/8	1/2
66-10E	5/8	3/4
66-12D	3/4	1/2
66-12E	3/4	3/4
66-14E	7/8	3/4



SEALING PLUG

PART No.	Tube
67-4	1/4

USED TO PLUG 1/4 O.D. TUBE



CONNECTOR Tube To Male Pipe

PART No.	Tube	Pipe
68-2-1	1/8	1/16
68-2A	1/8	1/8
68-2-1/2A	5/32	1/8
68-3A	3/16	1/8
68-3B	3/16	1/4
68-4A	1/4	1/8
68-4B	1/4	1/4
68-4C	1/4	3/8
68-4D	1/4	1/2
68-5A	5/16	1/8
68-5B	5/16	1/4
68-5C	5/16	3/8
68-6A	3/8	1/8
68-6B	3/8	1/4
68-6C	3/8	3/8
68-6D	3/8	1/2
68-6E	3/8	3/4
68-8B	1/2	1/4
68-8C	1/2	3/8
68-8D	1/2	1/2
68-8E	1/2	3/4
68-10C	5/8	3/8
68-10D	5/8	1/2
68-10E	5/8	3/4
68-12D	3/4	1/2
68-12E	3/4	3/4
68-14E	7/8	3/4



TANK FITTING Tube To Male Pipe

PART No.	Tube	Pipe
T68-2A	1/8	1/8
T68-3A	3/16	1/8
T68-3B	3/16	1/4
T68-4A	1/4	1/8
T68-4B	1/4	1/4
T68-4C	1/4	3/8
T68-5B	5/16	1/4
T68-6C	3/8	3/8
T68-6D	3/8	1/2
T68-8D	1/2	1/2
T68-10D	5/8	1/2

THESE COMPRESSION FITTINGS ARE DRILLED THROUGH TO ALLOW THE TUBE TO PASS THROUGH THE FITTING INTO THE CONTAINER.



BULKHEAD UNION

PART No.	Tube
77-4	1/4
77-6	3/8



**45° ELBOW
Tube To
Male Pipe**

PART No.	Tube	Pipe
74-3A	3/16	1/8
74-4A	1/4	1/8
74-4B	1/4	1/4
74-5A	5/16	1/8
74-6B	3/8	1/4
74-8C	1/2	3/8
74-8D	1/2	1/2
74-10D	5/8	1/2



**90° ELBOW
Tube
To Tube**

PART No.	Tube
65-2	1/8
65-3	3/16
65-4	1/4
65-5	5/16
65-6	3/8
65-8	1/2
65-10	5/8
65-12	3/4
65-14	7/8
	Reducing
65R-64	3/8 to 1/4
65R-86	1/2 to 3/8



**90° ELBOW
Tube To
Male Pipe**

PART No.	Tube	Pipe
69-2A	1/8	1/8
69-2-1/2A	5/32	1/8
69-3A	3/16	1/8
69-3B	3/16	1/4
69-4A	1/4	1/8
69-4B	1/4	1/4
69-4C	1/4	3/8
69-4D	1/4	1/2
69-5A	5/16	1/8
69-5B	5/16	1/4
69-5C	5/16	3/8
69-6A	3/8	1/8
69-6B	3/8	1/4
69-6C	3/8	3/8
69-6D	3/8	1/2
69-6E	3/8	3/4
69-7B	7/16	1/4
69-8B	1/2	1/4
69-8C	1/2	3/8
69-8D	1/2	1/2
69-8E	1/2	3/4
69-10C	5/8	3/8
69-10D	5/8	1/2
69-10E	5/8	3/4
69-12D	3/4	1/2
69-12E	3/4	3/4
69-14E	7/8	3/4



**90° ELBOW
Tube To
Female Pipe**

PART No.	Tube	Pipe
70-3A	3/16	1/8
70-4A	1/4	1/8
70-4B	1/4	1/4
70-4C	1/4	3/8
70-5A	5/16	1/8
70-5B	5/16	1/4
70-6A	3/8	1/8
70-6B	3/8	1/4
70-6C	3/8	3/8
70-6D	3/8	1/2
70-6E	3/8	3/4
70-8B	1/2	1/4
70-8C	1/2	3/8
70-8D	1/2	1/2
70-10D	5/8	1/2
70-12D	3/4	1/2
70-12E	3/4	3/4

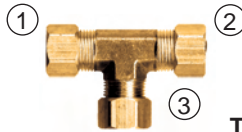

**TEE
Tube
Three Ends**

PART No.	Tube		
	1	2	3
64-2	1/8		
64-2-1/2	5/32		
64-3	3/16		
64-4	1/4		
64-5	5/16		
64-6	3/8		
64-8	1/2		
64-10	5/8		
64-12	3/4		
64-14	7/8		
	Reducing		
64R-46	1/4	1/4	3/8
64R-64	3/8	3/8	1/4
64R-84	1/2	1/2	1/4
64R-86	1/2	1/2	3/8
64R-106	5/8	5/8	3/8

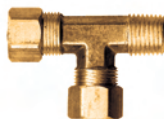

**TEE
Ends Tube
And Male Pipe
Center Tube**

PART No.	Tube	Pipe
71-3A	3/16	1/8
71-4A	1/4	1/8
71-4B	1/4	1/4
71-6A	3/8	1/8
71-6B	3/8	1/4
71-6C	3/8	3/8
71-8D	1/2	1/2
71-12D	3/4	1/2



**TEE
Ends Tube
Center Male Pipe**

PART No.	Tube	Pipe
72-3A	3/16	1/8
72-4A	1/4	1/8
72-4B	1/4	1/4
72-5A	5/16	1/8
72-5B	5/16	1/4
72-6A	3/8	1/8
72-6B	3/8	1/4
72-6C	3/8	3/8
72-6D	3/8	1/2
72-8C	1/2	3/8
72-8D	1/2	1/2
72-10D	5/8	1/2
72-12D	3/4	1/2

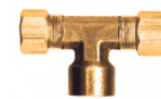

**TEE
Ends Tube
Center
Female Pipe**

PART No.	Tube	Pipe
78-4B	1/4	1/4
78-6A	3/8	1/8
78-6B	3/8	1/4

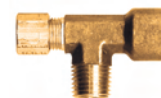

**TEE
Ends Tube
And
Female Pipe
Center Male Pipe**

PART No.	Tube	Pipe
79-4A	1/4	1/8

The compression connection is a three-piece assembly that consists of a cap-shaped nut with female threads, a compression sleeve that looks like a simple wedding ring and a seat section with male threads. The cap nut and the seat are screwed together causing the compression sleeve to squeeze tightly against them, as well as the adjoining tube. This causes a compressed or compression type watertight connection.



BRASS FITTINGS FOR POLY TUBE

(COMPLETE WITH FIXED INSERTS)

A



BRASS INSERT

PART No.	Tube I.D.
481-4H	.125
481-4	.170
481-5	.187
481-6	.250
481-8	.375
481-10	.500

THE 480 SLEEVE AND 481 INSERT WILL CONVERT STANDARD COMPRESSION FITTINGS AND VALVES FOR USE WITH POLY TUBE. SEE PAGE 145



DELTRIN SLEEVE

PART No.	Tube O.D.
480-4	1/4
480-5	5/16
480-6	3/8
480-8	1/2
480-10	5/8



NUT

PART No.	Tube O.D.
61-4	1/4
61-5	5/16
61-6	3/8
61-8	1/2
61-10	5/8



UNION COUPLING Poly Tube To Poly Tube

PART No.	Tube O.D.
462-4	1/4
462-5	5/16
462-6	3/8
462-8	1/2

Reducing	Tube
462R-64	3/8 to 1/4
462R-86	1/2 to 3/8



COUPLING Poly Tube To Copper Tube

PART No.	Tube
467-44	1/4
467-66	3/8



BULKHEAD Poly Tube To Poly Tube

PART No.	Tube
477-4	1/4
477-6	3/8

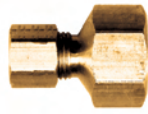

CONNECTOR Poly Tube To Female Pipe

PART No.	Tube	Pipe
466-4A	1/4	1/8
466-4B	1/4	1/4
466-6B	3/8	1/4
466-6C	3/8	3/8
466-8C	1/2	3/8



CONNECTOR Poly Tube To Male Pipe

PART No.	Tube	Pipe
468-4A	1/4	1/8
468-4B	1/4	1/4
468-4C	1/4	3/8
468-4D	1/4	1/2
468-5A	5/16	1/8
468-5B	5/16	1/4
468-6A	3/8	1/8
468-6B	3/8	1/4
468-6C	3/8	3/8
468-6D	3/8	1/2
468-8B	1/2	1/4
468-8C	1/2	3/8
468-8D	1/2	1/2
468-8E	1/2	3/4
468-10C	5/8	3/8
468-10D	5/8	1/2



90° ELBOW Poly Tube To Poly Tube

PART No.	Tube
465-4	1/4
465-6	3/8



90° ELBOW Poly Tube To Male Pipe

PART No.	Tube	Pipe
469-4A	1/4	1/8
469-4B	1/4	1/4
469-4C	1/4	3/8
469-5B	5/16	1/4
469-6A	3/8	1/8
469-6B	3/8	1/4
469-6C	3/8	3/8
469-6D	3/8	1/2
469-8B	1/2	1/4
469-8C	1/2	3/8
469-8D	1/2	1/2



90° ELBOW Poly Tube To Female Pipe

PART No.	Tube	Pipe
470-4A	1/4	1/8
470-4B	1/4	1/4
470-6B	3/8	1/4
470-8D	1/2	1/2



45° ELBOW Poly Tube To Male Pipe

PART No.	Tube	Pipe
474-4A	1/4	1/8
474-4B	1/4	1/4
474-6B	3/8	1/4

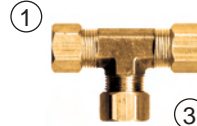

TEE Poly Tube Three Ends

PART No.	Tube
464-4	1/4
464-6	3/8
464-8	1/2

Reducing	1	2	3
464R-64	3/8	3/8	1/4

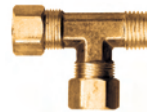

TEE Ends Poly Tube and Male Pipe Center Poly

PART No.	Tube	Pipe
471-4A	1/4	1/8
471-4B	1/4	1/4
471-6B	3/8	1/4



TEE Ends Poly Tube Center Male Pipe

PART No.	Tube	Pipe
472-4A	1/4	1/8
472-4B	1/4	1/4
472-6B	3/8	1/4

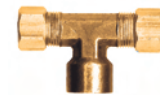

TEE Ends Poly Tube Center Female Pipe

PART No.	Tube	Pipe
478-4A	1/4	1/8
478-6B	3/8	1/4

TO ASSEMBLE

- 1 PLACE NUT AND SLEEVE OVER TUBE
- 2 PUSH INSERT INSIDE TUBE
- 3 PUSH TUBE INTO FITTING AS FAR AS POSSIBLE
- 4 TIGHTEN NUT

Selecting Material

1 - NYLON has good resistance to organic solvents, oils and gasoline • Good strength at high temperatures • Cold and hot-water applications • Longtime weathering resistance • Good impact resistance, both single and repeated • Not recommended for use with ammonium, boric acid, calcium, sulfuric acid, or hydrochloric acid • F.D.A. listed. • N.S.F. listed.

2 - CELCON or acetal copolymer, has high tensile strength and good impact resistance over a broad temperature range. • Translucent white color • Not affected by continuous hot-water service and works smoothly with metal tube • Celcon cannot be recommended for continuous exposure to solutions with a chlorine concentration greater than 1 ppm • Suggested maximum continuous temperature is +220°F (+104°C) in air and +180°F (+82°C) in water • Unaffected by most inorganics, except sulfuric, nitric and hydrochloric acids • Listed by U.S.D.A. and F.D.A. for coffee, milk and antibiotics • N.S.F. listed. • Should not be continuously exposed to sunlight.

3 - POLYPROPYLENE has good chemical resistance • Withstand continuous temperatures up to +215°F (+102°C) • Opaque • Unaffected by most weak acids and alkalis • Below +175°F (+79°C) it has good resistance to organic solvents • Do not use with oxidants or strong acids or in continuous sunlight • N.S.F. listed • 20% glass filled for improved stiffness.

4 - KYNAR a polyvinylidene fluoride, has outstanding chemical resistance for handling highly corrosive fluids • F.D.A. listed • N.S.F. listed.

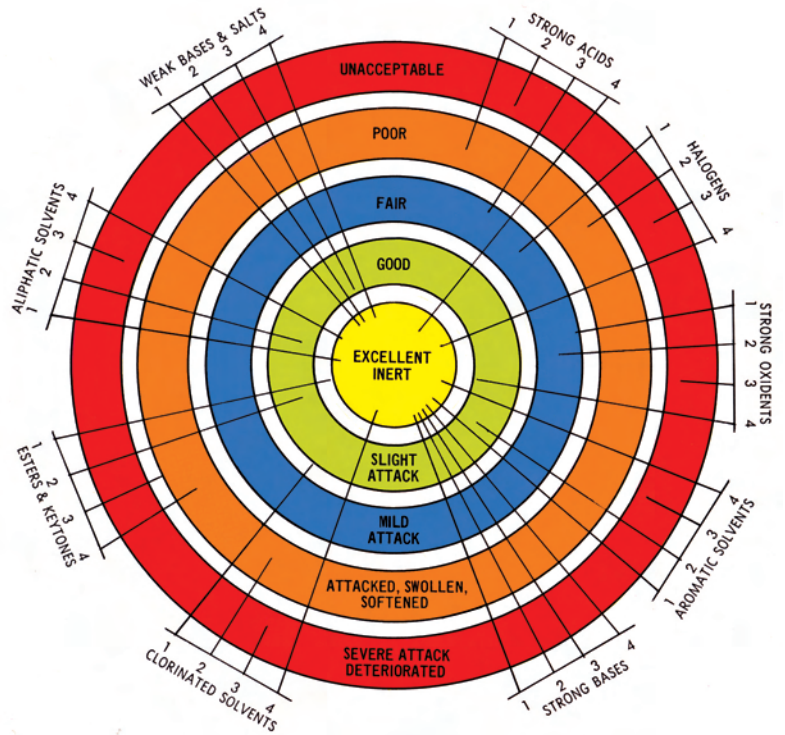

- CHART KEY**
- 1 - NYLON
 - * 2 - CELCON® (ACETAL)
 - 3 - POLYPROPYLENE
 - ** 4 - KYNAR®

* TRADEMARK OF Hoechst Celanese Corporation.
** TRADEMARK OF Atochem North America, Inc.

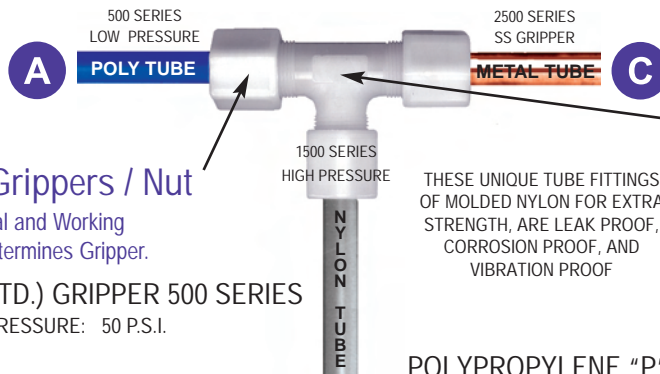

Select Grippers / Nut

Tube Material and Working Pressure Determines Gripper.

- A** NYLON (STD.) GRIPPER 500 SERIES
• WORKING PRESSURE: 50 P.S.I.
- B** PLASTIC GRIPPER 1500 SERIES
• WORKING PRESSURE: 220 P.S.I. AVAILABLE
- C** STAINLESS STEEL GRIPPER 2500 SERIES
• WORKING PRESSURE: 220 P.S.I. AVAILABLE

THESE UNIQUE TUBE FITTINGS OF MOLDED NYLON FOR EXTRA STRENGTH, ARE LEAK PROOF, CORROSION PROOF, AND VIBRATION PROOF

Select Body Material

Chemical and Temperature Requirements Determines Material.

NYLON (STANDARD 500 SERIES) SERIES
• TEMPERATURE: -40°F to +220°F
-40°C to +104°C

POLYPROPYLENE "P" (GOOD CHEMICAL RESISTANCE) SERIES
• TEMPERATURE: -30°F to +215°F
-34°C to +102°C

KYNAR "K" (HIGH CHEMICAL RESISTANCE) SERIES
• WORKING PRESSURE: 220 P.S.I.
TEMPERATURE: -80°F to +275°F
-62°C to +135°C

Minimum orders may apply.

ALL FITTING PART NUMBERS ARE SHOWN WITH OUR STANDARD 561 NUT.	FOR POLYPROPYLENE PREFIX PART NUMBER WITH P. (EXAMPLE: P568-) •
FOR PLASTIC GRIPPER TYPE PREFIX WITH NO. 1 (EXAMPLE: 1568).	FOR KYNAR PREFIX PART NUMBER WITH K. (EXAMPLE: K568-) •
FOR STAINLESS STEEL GRIPPER TYPE PREFIX WITH NO. 2 (EXAMPLE: 2568) • (SPECIAL ORDER, MIN. QTY. MAY APPLY	FOR CELCON PREFIX PART NUMBER WITH C. (EXAMPLE: C568-) •
ALL FITTINGS WILL BE SUPPLIED IN NYLON UNLESS OTHERWISE SPECIFIED.	NYLON FITTINGS ARE ALSO AVAILABLE IN BLACK ON A SPECIAL ORDER. (568BLK) •

Operating pressures are governed by ambient and fluid temperatures, type of fluid being conveyed, tube type, and conditions of mechanical abuse.



NYLON FITTINGS FOR POLY TUBE

(COMPLETE WITH 560 INSERTS)

A



STANDARD NUT

PART No.	Tube
561-4	1/4
561-6	3/8
561-8	1/2



FOR USE WITH SOFT WALL PLASTIC TUBE, POLY ETC. FOR 50 P.S.I. W.P.

NUT ASSEMBLY



PLASTIC GRIPPER TYPE

PART No.	Tube
1561-4	1/4
1561-6	3/8
1561-8	1/2



FOR USE WITH HARDWALL PLASTIC TUBE, NYLON ETC. FOR 220 P.S.I. W.P.



INSERT (Use With Soft wall Tube)

PART No.	Tube
560-4	1/4
560-6	3/8
560-8	1/2



UNION COUPLING Tube To Tube

PART No.	Tube
562-4	1/4
562-6	3/8
562-8	1/2
562R-86	Reducing 1/2 to 3/8



BULKHEAD UNION With Locknut

PART No.	Tube
577-4	1/4
577-6	3/8



CONNECTOR Tube To Female Pipe

PART No.	Tube	Pipe
566-4B	1/4	1/4
566-6B	3/8	1/4
566-6C	3/8	3/8
566-8C	1/2	3/8
566-8D	1/2	1/2



CONNECTOR Tube To Male Pipe

PART No.	Tube	Pipe
568-4A	1/4	1/8
568-4B	1/4	1/4
568-4C	1/4	3/8
568-6B	3/8	1/4
568-6C	3/8	3/8
568-8C	1/2	3/8
568-8D	1/2	1/2



90° ELBOW Tube To Tube

PART No.	Tube
565-4	1/4
565-6	3/8
565-8	1/2



90° ELBOW Tube To Male Pipe

PART No.	Tube	Pipe
569-4A	1/4	1/8
569-4B	1/4	1/4
569-6B	3/8	1/4
569-6C	3/8	3/8
569-8C	1/2	3/8
569-8D	1/2	1/2



90° ELBOW Tube To Female Pipe

PART No.	Tube	Pipe
570-6B	3/8	1/4
570-6C	3/8	3/8



TEE Tube Three Ends

PART No.	Tube
564-4	1/4
564-6	3/8
564-8	1/2



TEE Ends Tube Center Male Pipe

PART No.	Tube	Pipe
572-4B	1/4	1/4
572-6B	3/8	1/4



NOTE:
NYLON FITTINGS ARE ALSO AVAILABLE IN BLACK ON A SPECIAL ORDER. (568BLK)
Minimum orders may apply.

BRASS PUSH-TO-CONNECT FITTINGS



- QUICK CONNECT • FULL FLOW DESIGN • BRASS CONSTRUCTION
- FOR USE WITH POLYETHYLENE, NYLON AND POLYURETHANE TUBES.

A



**UNION
COUPLING**

PART No.	Tube
PC62-2	1/8
PC62-2-1/2	5/32
PC62-4	1/4
PC62-6	3/8
PC62-8	1/2
PC62R-64	3/8 to 1/4

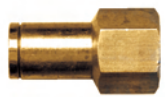

**CONNECTOR
Tube
To
Female Pipe**

PART No.	Tube	Pipe
PC66-2A	1/8	1/8
PC66-2-1/2A	5/32	1/8
PC66-4A	1/4	1/8
PC66-4B	1/4	1/4
PC66-6B	3/8	1/4
PC66-6C	3/8	3/8

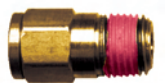

**CONNECTOR
Tube
To
Male Pipe**

PART No.	Tube	Pipe
PC68-2X1	1/8	1/16
PC68-2A	1/8	1/8
PC68-2-1/2X0	5/32	10-32
PC68-2-1/2A	5/32	1/8
PC68-2-1/2B	5/32	1/4
PC68-3A	3/16	1/8
PC68-4X0	1/4	10-32
PC68-4X1	1/4	1/16
PC68-4A	1/4	1/8
PC68-4B	1/4	1/4
PC68-4C	1/4	3/8
PC68-6A	3/8	1/8
PC68-6B	3/8	1/4
PC68-6C	3/8	3/8
PC68-6D	3/8	1/2
PC68-8B	1/2	1/4
PC68-8C	1/2	3/8
PC68-8D	1/2	1/2

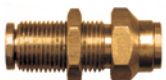

**BULKHEAD
UNION**

PART No.	Tube
PC77-4	1/4
PC77-6	3/8

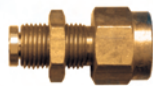

**BULKHEAD
UNION
Tube To
Female Pipe**

PART No.	Tube	Pipe
PC86-4A	1/4	1/8
PC86-4B	1/4	1/4
PC86-6B	3/8	1/4



**90°ELBOW
Tube
To
Tube**

PART No.	Tube
PC65-2	1/8
PC65-4	1/4
PC65-6	3/8
PC65-8	1/2



**90° ELBOW
Tube To
Female Pipe**

PART No.	Tube	Pipe
PC70-2-1/2A	5/32	1/8
PC70-4A	1/4	1/8
PC70-4B	1/4	1/4



**90° ELBOW
Tube To
Swivel
Female Pipe**

PART No.	Tube	Pipe
PC70SW-4A	1/4	1/8
PC70SW-4B	1/4	1/4



**90° ELBOW
Tube
To
Male Pipe**

PART No.	Tube	Pipe
PC69-2A	1/8	1/8
PC69-2-1/2A	5/32	1/8
PC69-3A	3/16	1/8
PC69-4A	1/4	1/8
PC69-4B	1/4	1/4
PC69-4C	1/4	3/8
PC69-6A	3/8	1/8
PC69-6B	3/8	1/4
PC69-6C	3/8	3/8
PC69-8B	1/2	1/4
PC69-8C	1/2	3/8
PC69-8D	1/2	1/2



**90° ELBOW
Tube To
Male Pipe
Swivel**

PART No.	Tube	Pipe
PC69SW-2A	1/8	1/8
PC69SW-2-1/2X0	5/32	10-32
PC69SW-2-1/2A	5/32	1/8
PC69SW-2-1/2B	5/32	1/4
PC69SW-3A	3/16	1/8
PC69SW-4A	1/4	1/8
PC69SW-4B	1/4	1/4
PC69SW-4C	1/4	3/8
PC69SW-6A	3/8	1/8
PC69SW-6B	3/8	1/4
PC69SW-6C	3/8	3/8
PC69SW-6D	3/8	1/2
PC69SW-8C	1/2	3/8
PC69SW-8D	1/2	1/2



**UNION TEE
Tube
Each End**

PART No.	Tube
PC64-2	1/8
PC64-2-1/2	5/32
PC64-3	3/16
PC64-4	1/4
PC64-6	3/8
PC64-8	1/2



**TEE
Ends Tube and
Male Pipe
Center Tube**

PART No.	Tube	Pipe
PC71-4B	1/4	1/4



**TEE
Ends Tube and
Male Pipe Swivel
Center Tube**

PART No.	Tube	Pipe
PC71SW-4A	1/4	1/8
PC71SW-4B	1/4	1/4
PC71SW-6C	3/8	3/8



**TEE
Ends Tube
Center M. Pipe**

PART No.	Tube	Pipe
PC72-4A	1/4	1/8
PC72-4B	1/4	1/4
PC72-6B	3/8	1/4
PC72-6C	3/8	3/8
PC72-8C	1/2	3/8



BRASS PUSH-TO-CONNECT FITTINGS

A

- QUICK CONNECT • FULL FLOW DESIGN • BRASS CONSTRUCTION
- FOR USE WITH POLYETHYLENE, NYLON AND POLYURETHANE TUBES.

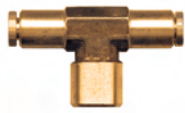

TEE
Ends Tube
Center Male
Pipe Swivel

PART No.	Tube	Pipe
PC72SW-4A	1/4	1/8
PC72SW-4B	1/4	1/4
PC72SW-6B	3/8	1/4
PC72SW-6C	3/8	3/8
PC72SW-8D	1/2	1/2



TEE
Ends Tube
Center
Female Pipe

PART No.	Tube	Pipe
PC78-4B	1/4	1/4
PC78-6B	3/8	1/4



PLUG

PART No.	Tube
PC67-2	1/8
PC67-2-1/2	5/32
PC67-4	1/4
PC67-6	3/8
PC67-8	1/2

ASSEMBLY INSTRUCTIONS



TO CONNECT TUBE:

Cut plastic as squarely as possible. Insert tube end into fitting until friction is felt as tube slides past the O-ring. Using a slight twisting motion while inserting the tube is often helpful. After this initial friction is felt, continue to push in the tube until it bottoms firmly against the internal tube stop.



TO DISCONNECT TUBE:

With thumb and forefinger, hold down the top of the insert against the fitting body and then, with the other hand, pull out the tube. No tools are needed.



FAIRVIEW CARRIES A WIDE VARIETY OF TUBE AVAILABLE IN COILS AND REELS SEE SECTION "C"

MULTI-CUTTER



ALL METAL CONSTRUCTION

PART No.	O.D. Capacity
MC-1	1-1/8
MCB-1	Replacement Blade

*P.V.C. Coated
Handles*

WILL CUT: • RUBBER HOSE & PLASTIC TUBE

BRASS PIPE FITTINGS



A



CLOSE NIPPLE

PART No.	Pipe
112-A	1/8
112-B	1/4
112-C	3/8
112-D	1/2
112-E	3/4
112-H	1
112-J	1-1/4
112-K	1-1/2
112-M	2
112-N	2-1/2
112-P	3

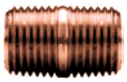

CLOSE NIPPLE (Red Brass)

PART No.	Pipe
112RED-D	1/2
112RED-E	3/4

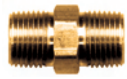

HEX NIPPLE

PART No.	Length (IN.)	Pipe
122-A		1/8
122-B		1/4
122L-B *	1-3/8	1/4
122-C		3/8
122-D		1/2
122L-D *	1-3/4	1/2
122-E		3/4
122-H		1

* LONG PATTERN

PART No.	Pipe	to	Pipe
122-BA	1/4	to	1/8
122-CA	3/8	to	1/8
122-CB	3/8	to	1/4
122-DB	1/2	to	1/4
122-DC	1/2	to	3/8
122-ED	3/4	to	1/2



LONG NIPPLE

PART No.	Pipe	Length (IN.)
113-A1-1/2	1/8	1-1/2
113-A2	1/8	2
113-A2-1/2	1/8	2-1/2
113-A3	1/8	3
113-A3-1/2	1/8	3-1/2
113-A4	1/8	4
113-A4-1/2	1/8	4-1/2
113-A5	1/8	5
113-A6	1/8	6
1/4 NPT		
113-B1-1/2	1/4	1-1/2
113-B2	1/4	2
113-B2-1/2	1/4	2-1/2
113-B3	1/4	3
113-B3-1/2	1/4	3-1/2
113-B4	1/4	4
113-B4-1/2	1/4	4-1/2
113-B5	1/4	5
113-B5-1/2	1/4	5-1/2
113-B6	1/4	6
3/8 NPT		
113-C1-1/2	3/8	1-1/2
113-C2	3/8	2
113-C2-1/2	3/8	2-1/2
113-C3	3/8	3
113-C3-1/2	3/8	3-1/2
113-C4	3/8	4
113-C4-1/2	3/8	4-1/2
113-C5	3/8	5
113-C5-1/2	3/8	5-1/2
113-C6	3/8	6
1/2 NPT		
113-D1-1/2	1/2	1-1/2
113-D2	1/2	2
113-D2-1/2	1/2	2-1/2
113-D3	1/2	3
113-D3-1/2	1/2	3-1/2
113-D4	1/2	4
113-D4-1/2	1/2	4-1/2
113-D5	1/2	5
113-D5-1/2	1/2	5-1/2
113-D6	1/2	6
3/4 NPT		
113-E2	3/4	2
113-E2-1/2	3/4	2-1/2
113-E3	3/4	3
113-E3-1/2	3/4	3-1/2
113-E4	3/4	4
113-E4-1/2	3/4	4-1/2
113-E5	3/4	5
113-E5-1/2	3/4	5-1/2
113-E6	3/4	6
1 NPT		
113-H2	1	2
113-H2-1/2	1	2-1/2
113-H3	1	3
113-H3-1/2	1	3-1/2
113-H4	1	4
113-H4-1/2	1	4-1/2
113-H5	1	5
113-H5-1/2	1	5-1/2
113-H6	1	6



LONG NIPPLE

PART No.	Pipe	Length (IN.)
113-J2	1-1/4	2
113-J2-1/2	1-1/4	2-1/2
113-J3	1-1/4	3
113-J3-1/2	1-1/4	3-1/2
113-J4	1-1/4	4
113-J5	1-1/4	5
113-J6	1-1/4	6
1-1/2 NPT		
113-K2	1-1/2	2
113-K2-1/2	1-1/2	2-1/2
113-K3	1-1/2	3
113-K3-1/2	1-1/2	3-1/2
113-K4	1-1/2	4
113-K5	1-1/2	5
113-K6	1-1/2	6
2 NPT		
113-M2-1/2	2	2-1/2
113-M3	2	3
113-M3-1/2	2	3-1/2
113-M4	2	4
113-M5	2	5
113-M6	2	6

LONGER LENGTHS AVAILABLE ON REQUEST.



LONG NIPPLE (Red Brass)

PART No.	Pipe	Length (IN.)
1/2 NPT		
113RED-D1-1/2	1/2	1-1/2
113RED-D2	1/2	2
113RED-D2-1/2	1/2	2-1/2
113RED-D3	1/2	3
113RED-D4	1/2	4
3/4 NPT		
113RED-E1-1/2	3/4	1-1/2
113RED-E2	3/4	2
113RED-E2-1/2	3/4	2-1/2
113RED-E3	3/4	3
113RED-E4	3/4	4



COUPLING

PART No.	Pipe
103-A	1/8
103-B	1/4
103-C	3/8
103-D	1/2
103-E	3/4

A



COUPLING (Cast Bronze)

PART No.	Pipe
103CA-D	1/2
103CA-E	3/4
103-H	1
103-J	1-1/4
103-K	1-1/2
103-M	2
103-N	2-1/2

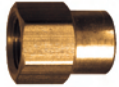

REDUCING COUPLING

PART No.	Pipe	Pipe
119-BA	1/4	to 1/8
119-CA	3/8	to 1/8
119-CB	3/8	to 1/4
119-DA	1/2	to 1/8
119-DB	1/2	to 1/4
119-DC	1/2	to 3/8
119-ED	3/4	to 1/2



REDUCING COUPLING (Cast Bronze)

PART No.	Pipe	Pipe
119-EB	3/4	to 1/4
119-EC	3/4	to 3/8
119-HD	1	to 1/2
119-HE	1	to 3/4
119-JE	1-1/4	to 3/4
119-JH	1-1/4	to 1
119-KH	1-1/2	to 1
119-KJ	1-1/2	to 1-1/4
119-MK	2	to 1-1/2



UNION COUPLING

PART No.	Pipe
104-A	1/8
104-B	1/4
104-C	3/8
104-D	1/2
104-E	3/4



UNION COUPLING (Cast Bronze)

PART No.	Pipe
104-H	1
104-J	1-1/4
104-K	1-1/2
104-M	2



ADAPTER

PART No.	Female Pipe	to	Male Pipe
120-AA	1/8	to	1/8
120-BB	1/4	to	1/4
120-CC	3/8	to	3/8
120-DD	1/2	to	1/2

PART No.	Female Pipe	to	Male Pipe
120-A-1	1/8	to	1/16
120-BA	1/4	to	1/8
120-CA	3/8	to	1/8
120-CB	3/8	to	1/4
120-DB	1/2	to	1/4
120-DC	1/2	to	3/8
120-ED	3/4	to	1/2



BUSHING

PART No.	Male Pipe	to	Female Pipe
110-BA	1/4	to	1/8
110-CA	3/8	to	1/8
110-CB	3/8	to	1/4
110-DA	1/2	to	1/8
110-DB	1/2	to	1/4
110-DC	1/2	to	3/8
110-EA	3/4	to	1/8
110-EB	3/4	to	1/4
110-EC	3/4	to	3/8
110-ED	3/4	to	1/2
110-HB	1	to	1/4
110-HC	1	to	3/8
110-HD	1	to	1/2
110-HE	1	to	3/4



BUSHING (Cast Bronze)

PART No.	Male Pipe	to	Female Pipe
110CA-ED	3/4	to	1/2
110CA-HB	1	to	1/4
110CA-HC	1	to	3/8
110CA-HD	1	to	1/2
110CA-HE	1	to	3/4
110-JD	1-1/4	to	1/2
110-JE	1-1/4	to	3/4
110-JH	1-1/4	to	1
110-KD	1-1/2	to	1/2
110-KE	1-1/2	to	3/4
110-KH	1-1/2	to	1
110-KJ	1-1/2	to	1-1/4
110-ME	2	to	3/4
110-MH	2	to	1
110-MJ	2	to	1-1/4
110-MK	2	to	1-1/2
110-NM	2-1/2	to	2
110-PM	3	to	2
110-PN	3	to	2-1/2



LOCK NUT

PART No.	Pipe
111-A	1/8
111-B	1/4
111-C	3/8
111-D	1/2
111-E	3/4



LOCK NUT (Cast Bronze)

PART No.	Pipe
111-H	1



PLUG Square Head

PART No.	Pipe
109-A	1/8
109-B	1/4
109-C	3/8
109-D	1/2
109-E	3/4



PLUG Square Head (Cast Bronze)

PART No.	Pipe
109-H	1
109-J	1-1/4
109-K	1-1/2
109-M	2
109-N	2-1/2



PLUG Slotted

PART No.	Pipe
117-A	1/8
117-B	1/4
117-C	3/8



PLUG Hex Countersunk

PART No.	Pipe
118-A	1/8
118-B	1/4
118-C	3/8
118-D	1/2
118-E	3/4 *

* SQUARE COUNTERSUNK



PLUG Hex Head

PART No.		Pipe
121-1	Cored	1/16
121-A	Cored	1/8
121-B	Cored	1/4
121-C	Cored	3/8
121-D	Cored	1/2
121-E	Cored	3/4
121-H	Cored	1

PART No.		Pipe
121S-A	Solid	1/8
121S-B	Solid	1/4
121S-C	Solid	3/8
121S-D	Solid	1/2
121S-E	Solid	3/4



CAP

PART No.	Pipe
108-A	1/8
108-B	1/4
108-C	3/8
108-D	1/2
108-E	3/4



CAP (Cast Bronze)

PART No.	Pipe
108CA-D	1/2
108CA-E	3/4
108-H	1
108-J	1-1/4
108-K	1-1/2
108-M	2



FORGED 90° ELBOW

PART No.	Pipe
99-A	1/8
99-B	1/4
99-C	3/8
99-D	1/2

PART No.	Pipe		Pipe
99-BA	1/4	to	1/8
99-CA	3/8	to	1/8
99-CB	3/8	to	1/4
99-DC	1/2	to	3/8



EXTRUDED 90° STREET ELBOW

PART No.	Pipe
X115-A	1/8
X115-B	1/4
X115-C	3/8
X115-D	1/2
X115-E	3/4

PART No.	Female Pipe		Male Pipe
X115-BA	1/4	to	1/8
X115-DC	1/2	to	3/8



FORGED 90° STREET ELBOW

PART No.	Pipe
116-A	1/8
116-B	1/4
116-C	3/8
116-D	1/2
116-E	3/4

PART No.	Female Pipe		Male Pipe
116-AB	1/8	to	1/4
116-BA	1/4	to	1/8
116-CB	3/8	to	1/4
116-CD	3/8	to	1/2
116-DC	1/2	to	3/8



90° STREET ELBOW (Cast Bronze)

PART No.	Pipe
116CA-D	1/2
116CA-E	3/4
116-H	1
116-J	1-1/4
116-K	1-1/2
116-M	2
116-N	2-1/2
116-P	3



FORGED 90° STREET ELBOW Heavy Pattern

PART No.	Pipe
116H-B	1/4
116H-C	3/8



FORGED 90° ELBOW

PART No.	Pipe
100-A	1/8
100-B	1/4
100-C	3/8
100-D	1/2
100-E	3/4

PART No.	Pipe		Pipe
100-BA	1/4	to	1/8
100-CB	3/8	to	1/4
100-DC	1/2	to	3/8



90° ELBOW (Cast Bronze)

PART No.	Pipe
100CA-D	1/2
100CA-E	3/4
100-H	1
100-J	1-1/4
100-K	1-1/2
100-M	2
100-N	2-1/2
100-P	3



90° ELBOW (Cast Bronze)

PART No.	Pipe		Pipe
100-ED	3/4	to	1/2
100-HE	1	to	3/4
100-JH	1-1/4	to	1

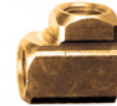

EXTRUDED 90° ELBOW

PART No.	Pipe
X100-A	1/8
X100-B	1/4
X100-C	3/8
X100-D	1/2



FORGED 45° STREET ELBOW

PART No.	Pipe
124-A	1/8
124-B	1/4
124-C	3/8



45° STREET ELBOW (Cast Bronze)

PART No.	Pipe
124-D	1/2
124-E	3/4
124-H	1
124-J	1-1/4



EXTRUDED 45° STREET ELBOW

PART No.	Pipe
X124-A	1/8
X124-B	1/4
X124-C	3/8
X124-D	1/2
X124-E	3/4

A



**45° ELBOW
(Cast Bronze)**

PART No.	Pipe
105-B	1/4
105-C	3/8
105-D	1/2
105-E	3/4
105-H	1
105-J	1-1/4
105-K	1-1/2
105-M	2



**EXTRUDED
45° ELBOW**

PART No.	Pipe
X105-A	1/8
X105-B	1/4



**FORGED
CROSS**

PART No.	Pipe
102-A	1/8
102-B	1/4
102-C	3/8
102-D	1/2



**CROSS
(Cast Bronze)**

PART No.	Pipe
102-E	3/4
102-H	1



**EXTRUDED
CROSS**

PART No.	Pipe
X102-A	1/8
X102-B	1/4
X102-C	3/8
X102-D	1/2



**FORGED
MALE BRANCH
TEE**

PART No.	Pipe
106-A	1/8
106-B	1/4
106-C	3/8
106-D	1/2



**EXTRUDED
MALE BRANCH
TEE**

PART No.	Pipe
X106-A	1/8
X106-B	1/4
X106-C	3/8



**FORGED
MALE
TEE**

PART No.	Pipe
101M-A	1/8
101M-B	1/4
101M-C	3/8
101M-D	1/2
101M-E	3/4



**FORGED
STREET
TEE**

PART No	Pipe
107-A	1/8
107-B	1/4
107-C	3/8
107-D	1/2
107-E	3/4

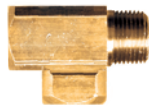

**EXTRUDED
STREET
TEE**

PART No	Pipe
X107-A	1/8
X107-B	1/4
X107-C	3/8
X107-D	1/2
X107-E	3/4



**FORGED
TEE**

PART No.	Pipe
101-A	1/8
101-B	1/4
101-C	3/8
101-D	1/2
101-E	3/4



**TEE
(Cast Bronze)**

PART No.	Pipe
101CA-C	3/8
101CA-D	1/2
101CA-E	3/4
101-H	1
101-J	1-1/4
101-K	1-1/2
101-M	2
101-N	2-1/2



**EXTRUDED
TEE**

PART No.	Pipe
X101-A	1/8
X101-B	1/4
X101-C	3/8
X101-D	1/2

①



②

**REDUCING
FORGED
TEE**

③

PART No.	Reducing		
	1	2	3
101-BA	1/4	1/4	1/8
101-CB	3/8	3/8	1/4
101-DC	1/2	1/2	3/8
101-ED	3/4	3/4	1/2

①



②

**REDUCING
TEE**

(Cast Bronze)

③

PART No.	Reducing		
	1	2	3
101-DB	1/2	1/2	1/4
101-HD	1	1	1/2
101-HE	1	1	3/4
101-JH	1-1/4	1-1/4	1



**FLOOR
FLANGE**

PART No.	Pipe
114-D	1/2



**"Y"
BLOCK**

PART No.	Female	Male
	Pipe	Pipe
678-YB	1/4	1/4

BLACK IRON PIPE FITTINGS

SCHEDULE 40 (150 LB.)



A



BUSHING

PART No.	Pipe	to	Pipe
BI-110-BA	1/4	to	1/8
BI-110-CA	3/8	to	1/8
BI-110-CB	3/8	to	1/4
BI-110-DA	1/2	to	1/8
BI-110-DB	1/2	to	1/4
BI-110-DC	1/2	to	3/8
BI-110-EB	3/4	to	1/4
BI-110-EC	3/4	to	3/8
BI-110-ED	3/4	to	1/2
BI-110-HB	1	to	1/4
BI-110-HC	1	to	3/8
BI-110-HD	1	to	1/2
BI-110-HE	1	to	3/4
BI-110-JD	1-1/4	to	1/2
BI-110-JE	1-1/4	to	3/4
BI-110-JH	1-1/4	to	1
BI-110-KD	1-1/2	to	1/2
BI-110-KE	1-1/2	to	3/4
BI-110-KH	1-1/2	to	1
BI-110-KJ	1-1/2	to	1-1/4
BI-110-MD	2	to	1/2
BI-110-ME	2	to	3/4
BI-110-MH	2	to	1
BI-110-MJ	2	to	1-1/4
BI-110-MK	2	to	1-1/2
BI-110-NH	2-1/2	to	1
BI-110-NJ	2-1/2	to	1-1/4
BI-110-NK	2-1/2	to	1-1/2
BI-110-NM	2-1/2	to	2
BI-110-PM	3	to	2
BI-110-PN	3	to	2-1/2
BI-110-SM	4	to	2
BI-110-SN	4	to	2-1/2
BI-110-SP	4	to	3



REDUCING COUPLING

PART No.	Pipe	to	Pipe
BI-119-BA	1/4	to	1/8
BI-119-CA	3/8	to	1/8
BI-119-CB	3/8	to	1/4
BI-119-DB	1/2	to	1/4
BI-119-DC	1/2	to	3/8
BI-119-EB	3/4	to	1/4
BI-119-EC	3/4	to	3/8
BI-119-ED	3/4	to	1/2
BI-119-HB	1	to	1/4
BI-119-HC	1	to	3/8
BI-119-HD	1	to	1/2
BI-119-HE	1	to	3/4
BI-119-JD	1-1/4	to	1/2
BI-119-JE	1-1/4	to	3/4
BI-119-JH	1-1/4	to	1
BI-119-KE	1-1/2	to	3/4
BI-119-KH	1-1/2	to	1
BI-119-KJ	1-1/2	to	1-1/4
BI-119-ME	2	to	3/4
BI-119-MH	2	to	1
BI-119-MJ	2	to	1-1/4
BI-119-MK	2	to	1-1/2
BI-119-NK	2-1/2	to	1-1/2
BI-119-NM	2-1/2	to	2
BI-119-PM	3	to	2
BI-119-PN	3	to	2-1/2
BI-119-SP	4	to	3



COUPLING FOR REDUCING COUPLING SEE PART No BI-119 SERIES

PART No.	Pipe
BI-103-A	1/8
BI-103-B	1/4
BI-103-C	3/8
BI-103-D	1/2
BI-103-E	3/4
BI-103-H	1
BI-103-J	1-1/4
BI-103-K	1-1/2
BI-103-M	2
BI-103-N	2-1/2
BI-103-P	3
BI-103-S	4



UNION

PART No.	Pipe
BI-104-A	1/8
BI-104-B	1/4
BI-104-C	3/8
BI-104-D	1/2
BI-104-E	3/4
BI-104-H	1
BI-104-J	1-1/4
BI-104-K	1-1/2
BI-104-M	2
BI-104-N	2-1/2
BI-104-P	3
BI-104-S	4



CLOSE NIPPLE

PART No.	Pipe
BI-112-A	1/8
BI-112-B	1/4
BI-112-C	3/8
BI-112-D	1/2
BI-112-E	3/4
BI-112-H	1
BI-112-J	1-1/4
BI-112-K	1-1/2
BI-112-M	2
BI-112-N	2-1/2
BI-112-P	3
BI-112-S	4



LONG NIPPLE

PART No.	Pipe	Length (IN.)
BI-113-A1-1/2	1/8	1-1/2
BI-113-A2	1/8	2
BI-113-A2-1/2	1/8	2-1/2
BI-113-A3	1/8	3
BI-113-A3-1/2	1/8	3-1/2
BI-113-A4	1/8	4
BI-113-A4-1/2	1/8	4-1/2
BI-113-A5	1/8	5
BI-113-A6	1/8	6
BI-113-B1-1/2	1/4	1-1/2
BI-113-B2	1/4	2
BI-113-B2-1/2	1/4	2-1/2
BI-113-B3	1/4	3
BI-113-B3-1/2	1/4	3-1/2
BI-113-B4	1/4	4
BI-113-B4-1/2	1/4	4-1/2
BI-113-B5	1/4	5
BI-113-B5-1/2	1/4	5-1/2
BI-113-B6	1/4	6

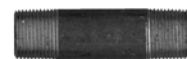

LONG NIPPLE

PART No.	Pipe	Length (IN.)
BI-113-C1-1/2	3/8	1-1/2
BI-113-C2	3/8	2
BI-113-C2-1/2	3/8	2-1/2
BI-113-C3	3/8	3
BI-113-C3-1/2	3/8	3-1/2
BI-113-C4	3/8	4
BI-113-C4-1/2	3/8	4-1/2
BI-113-C5	3/8	5
BI-113-C5-1/2	3/8	5-1/2
BI-113-C6	3/8	6
BI-113-D1-1/2	1/2	1-1/2
BI-113-D2	1/2	2
BI-113-D2-1/2	1/2	2-1/2
BI-113-D3	1/2	3
BI-113-D3-1/2	1/2	3-1/2
BI-113-D4	1/2	4
BI-113-D4-1/2	1/2	4-1/2
BI-113-D5	1/2	5
BI-113-D5-1/2	1/2	5-1/2
BI-113-D6	1/2	6
BI-113-D7	1/2	7
BI-113-D8	1/2	8
BI-113-E1-1/2	3/4	1-1/2
BI-113-E2	3/4	2
BI-113-E2-1/2	3/4	2-1/2
BI-113-E3	3/4	3
BI-113-E3-1/2	3/4	3-1/2
BI-113-E4	3/4	4
BI-113-E4-1/2	3/4	4-1/2
BI-113-E5	3/4	5
BI-113-E5-1/2	3/4	5-1/2
BI-113-E6	3/4	6
BI-113-H2	1	2
BI-113-H2-1/2	1	2-1/2
BI-113-H3	1	3
BI-113-H3-1/2	1	3-1/2
BI-113-H4	1	4
BI-113-H4-1/2	1	4-1/2
BI-113-H5	1	5
BI-113-H5-1/2	1	5-1/2
BI-113-H6	1	6
BI-113-J2	1-1/4	2
BI-113-J2-1/2	1-1/4	2-1/2
BI-113-J3	1-1/4	3
BI-113-J3-1/2	1-1/4	3-1/2
BI-113-J4	1-1/4	4
BI-113-J4-1/2	1-1/4	4-1/2
BI-113-J5	1-1/4	5
BI-113-J5-1/2	1-1/4	5-1/2
BI-113-J6	1-1/4	6
BI-113-K2	1-1/2	2
BI-113-K2-1/2	1-1/2	2-1/2
BI-113-K3	1-1/2	3
BI-113-K3-1/2	1-1/2	3-1/2
BI-113-K4	1-1/2	4
BI-113-K4-1/2	1-1/2	4-1/2
BI-113-K5	1-1/2	5
BI-113-K5-1/2	1-1/2	5-1/2
BI-113-K6	1-1/2	6
BI-113-M2-1/2	2	2-1/2
BI-113-M3	2	3
BI-113-M3-1/2	2	3-1/2
BI-113-M4	2	4
BI-113-M5	2	5
BI-113-M6	2	6

A



LONG NIPPLE (Continued)

PART No.	Pipe	Length (IN.)
2-1/2 NPT		
BI-113-N3	2-1/2	3
BI-113-N3-1/2	2-1/2	3-1/2
BI-113-N4	2-1/2	4
BI-113-N6	2-1/2	6
3 NPT		
BI-113-P3	3	3
BI-113-P4	3	4
BI-113-P6	3	6
4 NPT		
BI-113-S4	4	4
BI-113-S6	4	6



CAP

PART No.	Pipe
BI-108-A	1/8
BI-108-B	1/4
BI-108-C	3/8
BI-108-D	1/2
BI-108-E	3/4
BI-108-H	1
BI-108-J	1-1/4
BI-108-K	1-1/2
BI-108-M	2
BI-108-N	2-1/2
BI-108-P	3
BI-108-S	4



PLUG (Square Head)

PART No.	Pipe
BI-109-A	1/8
BI-109-B	1/4
BI-109-C	3/8
BI-109-D	1/2
BI-109-E	3/4
BI-109-H	1
BI-109-J	1-1/4
BI-109-K	1-1/2
BI-109-M	2
BI-109-N	2-1/2
BI-109-P	3
BI-109-S	4



LOCK NUT

PART No.	Pipe
BI-111-B	1/4
BI-111-C	3/8
BI-111-D	1/2
BI-111-E	3/4



90° ELBOW

PART No.	Pipe
BI-100-A	1/8
BI-100-B	1/4
BI-100-C	3/8
BI-100-D	1/2
BI-100-E	3/4
BI-100-H	1
BI-100-J	1-1/4
BI-100-K	1-1/2
BI-100-M	2
BI-100-N	2-1/2
BI-100-P	3
BI-100-S	4



REDUCING 90° ELBOW

PART No.	Pipe
BI-100-CB	3/8 to 1/4
BI-100-DB	1/2 to 1/4
BI-100-DC	1/2 to 3/8
BI-100-EC	3/4 to 3/8
BI-100-ED	3/4 to 1/2
BI-100-HD	1 to 1/2
BI-100-HE	1 to 3/4
BI-100-JE	1-1/4 to 3/4
BI-100-JH	1-1/4 to 1
BI-100-KH	1-1/2 to 1
BI-100-KJ	1-1/2 to 1-1/4
BI-100-MJ	2 to 1-1/4
BI-100-MK	2 to 1-1/2
BI-100-NM	2-1/2 to 2



45° ELBOW

PART No.	Pipe
BI-105-A	1/8
BI-105-B	1/4
BI-105-C	3/8
BI-105-D	1/2
BI-105-E	3/4
BI-105-H	1
BI-105-J	1-1/4
BI-105-K	1-1/2
BI-105-M	2
BI-105-N	2-1/2
BI-105-P	3
BI-105-S	4



90° STREET ELBOW

PART No.	Pipe
BI-116-A	1/8
BI-116-B	1/4
BI-116-C	3/8
BI-116-D	1/2
BI-116-E	3/4
BI-116-H	1
BI-116-J	1-1/4
BI-116-K	1-1/2
BI-116-M	2
BI-116-N	2-1/2
BI-116-P	3
BI-116-S	4



45° STREET ELBOW

PART No.	Pipe
BI-124-A	1/8
BI-124-B	1/4
BI-124-C	3/8
BI-124-D	1/2
BI-124-E	3/4
BI-124-H	1
BI-124-J	1-1/4
BI-124-K	1-1/2
BI-124-M	2



TEE

PART No.	Pipe
BI-101-A	1/8
BI-101-B	1/4
BI-101-C	3/8
BI-101-D	1/2
BI-101-E	3/4
BI-101-H	1
BI-101-J	1-1/4
BI-101-K	1-1/2
BI-101-M	2
BI-101-N	2-1/2
BI-101-P	3
BI-101-S	4

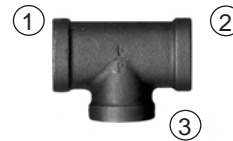

REDUCING TEE

PART No.	Pipe Size		
	1	2	3
BI-101-ED	3/4	3/4	1/2
BI-101-EDD	3/4	1/2	1/2
BI-101-EDE	3/4	1/2	3/4
BI-101-HD	1	1	1/2
BI-101-HE	1	1	3/4
BI-101-HEE	1	3/4	3/4
BI-101-HEH	1	3/4	1
BI-101-JE	1-1/4	1-1/4	3/4
BI-101-JH	1-1/4	1-1/4	1
BI-101-KJ	1-1/2	1-1/2	1-1/4
BI-101-MK	2	2	1-1/2



CROSS

PART No.	Pipe
BI-102-C	3/8
BI-102-D	1/2
BI-102-E	3/4
BI-102-H	1
BI-102-J	1-1/4
BI-102-K	1-1/2
BI-102-M	2

**NOTE: FOR GALVANIZED IRON: REPLACE PREFIX BI- WITH GI- (Minimums may apply)
SCHEDULE 80: REPLACE PREFIX BI- WITH BI80- FOR SCHEDULE 80 (300LB.)**

STEEL MERCHANT PIPE FITTINGS

(Weldable)



A



BUSHING

PART No.	Pipe	Pipe
BI-110MC-CB	3/8	to 1/4
BI-110MC-DB	1/2	to 1/4
BI-110MC-DC	1/2	to 3/8
BI-110MC-EA	3/4	to 1/8
BI-110MC-EB	3/4	to 1/4
BI-110MC-EC	3/4	to 3/8
BI-110MC-ED	3/4	to 1/2

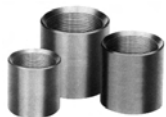

COUPLING

PART No.	Pipe
BI-103MC-A	1/8
BI-103MC-B	1/4
BI-103MC-C	3/8
BI-103MC-D	1/2
BI-103MC-E	3/4
BI-103MC-H	1
BI-103MC-J	1-1/4
BI-103MC-K	1-1/2
BI-103MC-M	2
BI-103MC-N	2-1/2
BI-103MC-P	3
BI-103MC-S	4



COUPLING (Half Height)

PART No.	Pipe
BI-103HMC-A	1/8
BI-103HMC-B	1/4
BI-103HMC-C	3/8
BI-103HMC-D	1/2
BI-103HMC-E	3/4
BI-103HMC-H	1
BI-103HMC-J	1-1/4
BI-103HMC-K	1-1/2
BI-103HMC-M	2



PLUG (Square Head)

PART No.	Pipe
BI-109MC-A	1/8
BI-109MC-B	1/4
BI-109MC-C	3/8
BI-109MC-D	1/2
BI-109MC-E	3/4
BI-109MC-H	1

BRASS D.O.T. AIR BRAKE FITTINGS

(FOR COPPER TUBE)

**NOTE: CERTAIN ITEMS IN THE 1100 SERIES ARE BEING DISCONTINUED
PLEASE CONFIRM AVAILABILITY OF INVENTORY PRIOR TO ORDERING**



SLEEVE

PART No.	Tube
1160-4	1/4
1160-6	3/8
1160-8	1/2



NUT

PART No.	Tube
1161-4	1/4
1161-6	3/8
1161-8	1/2



UNION COUPLING

PART No.	Tube
1162-4	1/4
1162-6	3/8
1162-8	1/2



CONNECTOR Tube To Male Pipe

PART No.	Tube	Pipe
1168-4A	1/4	1/8
1168-4B	1/4	1/4
1168-6B	3/8	1/4
1168-6C	3/8	3/8
1168-8C	1/2	3/8
1168-8D	1/2	1/2



45° ELBOW Tube To Male Pipe

PART No.	Tube	Pipe
1174-6B	3/8	1/4
1174-6C	3/8	3/8



90° ELBOW Tube To Male Pipe

PART No.	Tube	Pipe
1169-4A	1/4	1/8
1169-4B	1/4	1/4
1169-6B	3/8	1/4
1169-6C	3/8	3/8
1169-8C	1/2	3/8



90° ELBOW Tube To Female Pipe

PART No.	Tube	Pipe
1170-4A	1/4	1/8
1170-6B	3/8	1/4

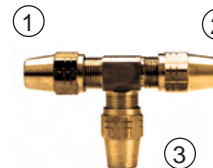

TEE Tube Three Ends

PART No.	Tube
1164-4	1/4
1164-6	3/8



TEE Ends Tube To Male Pipe Center Tube

PART No.	Tube	Pipe
1171-4B	1/4	1/4



TEE Ends Tube Center Male Pipe

PART No.	Tube	Pipe
1172-6B	3/8	1/4
1172-6C	3/8	3/8



BRASS D.O.T. AIR BRAKE FITTINGS

(FOR D.O.T. AIR BRAKE TUBE: SEE PAGE 142)

COMPLETE WITH FIXED INSERTS

A



INSERT

PART No.	For Tube I.D.
1481-2	.078
1481-4	.170
1481-5	.232
1481-6	.250
1481-8	.375
1481-10	.440
1481-12	.566



SLEEVE

PART No.	Tube
1460-4	1/4
1460-6	3/8
1460-8	1/2
1460-10	5/8
1460-12	3/4



NUT

PART No.	Tube
1461-4	1/4
1461-6	3/8
1461-8	1/2
1461-10	5/8
1461-12	3/4



UNION COUPLING

PART No.	Tube
1462-4	1/4
1462-6	3/8
1462-8	1/2
1462-10	5/8
1462-12	3/4

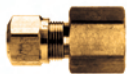

CONNECTOR Tube To Female Pipe

PART No.	Tube	Pipe
1466-4A	1/4	1/8
1466-4B	1/4	1/4
1466-4C	1/4	3/8
1466-6A	3/8	1/8
1466-6B	3/8	1/4
1466-6C	3/8	3/8
1466-8C	1/2	3/8
1466-8D	1/2	1/2
1466-10C	5/8	3/8
1466-10D	5/8	1/2
1466-12D	3/4	1/2
1466-12E	3/4	3/4



CONNECTOR Tube To Male Pipe

PART No.	Tube	Pipe
1468-4A	1/4	1/8
1468-4B	1/4	1/4
1468-4C	1/4	3/8
1468-4D	1/4	1/2
1468-6A	3/8	1/8
1468-6B	3/8	1/4
1468-6C	3/8	3/8
1468-6D	3/8	1/2
1468-8B	1/2	1/4
1468-8C	1/2	3/8
1468-8D	1/2	1/2
1468-8E	1/2	3/4
1468-10C	5/8	3/8
1468-10D	5/8	1/2
1468-10E	5/8	3/4
1468-12D	3/4	1/2
1468-12E	3/4	3/4



45° ELBOW Tube To Male Pipe

PART No.	Tube	Pipe
1474-4A	1/4	1/8
1474-4B	1/4	1/4
1474-6B	3/8	1/4
1474-6C	3/8	3/8
1474-6D	3/8	1/2
1474-8B	1/2	1/4
1474-8C	1/2	3/8
1474-8D	1/2	1/2
1474-10D	5/8	1/2



90° ELBOW Tube To Tube

PART No.	Tube
1465-4	1/4
1465-6	3/8
1465-8	1/2
1465-10	5/8
1465-12	3/4



90° ELBOW Tube To Male Pipe

PART No.	Tube	Pipe
1469-4A	1/4	1/8
1469-4B	1/4	1/4
1469-4C	1/4	3/8
1469-4D	1/4	1/2
1469-6A	3/8	1/8
1469-6B	3/8	1/4
1469-6C	3/8	3/8
1469-6D	3/8	1/2
1469-8B	1/2	1/4
1469-8C	1/2	3/8
1469-8D	1/2	1/2
1469-10C	5/8	3/8
1469-10D	5/8	1/2
1469-10E	5/8	3/4
1469-12D	3/4	1/2
1469-12E	3/4	3/4



90° ELBOW Tube To Female Pipe

PART No.	Tube	Pipe
1470-4A	1/4	1/8
1470-4B	1/4	1/4
1470-6A	3/8	1/8
1470-6B	3/8	1/4
1470-6C	3/8	3/8
1470-8C	1/2	3/8
1470-8D	1/2	1/2
1470-10D	5/8	1/2
1470-12D	3/4	1/2



TEE Tube Three Ends

PART No.	Tube
1464-4	1/4
1464-6	3/8
1464-8	1/2
1464-10	5/8
1464-12	3/4

Reducing		
1	2	3
1464R-64	3/8	3/8
1464R-86	1/2	1/2



TEE Ends Tube To Male Pipe Center Tube

PART No.	Tube	Pipe
1471-4A	1/4	1/8
1471-4B	1/4	1/4
1471-6B	3/8	1/4
1471-6C	3/8	3/8
1471-8C	1/2	3/8
1471-8D	1/2	1/2
1471-10D	5/8	1/2
1471-12D	3/4	1/2



TEE Ends Tube Center Male Pipe

PART No.	Tube	Pipe
1472-4A	1/4	1/8
1472-4B	1/4	1/4
1472-6A	3/8	1/8
1472-6B	3/8	1/4
1472-6C	3/8	3/8
1472-8B	1/2	1/4
1472-8C	1/2	3/8
1472-8D	1/2	1/2
1472-10D	5/8	1/2
1472-12D	3/4	1/2
1472-12E	3/4	3/4



TEE Female To Male Pipe Center Tube

PART No.	Tube	Pipe
1476-4A	1/4	1/8
1476-6B	3/8	1/4

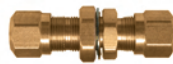

BULKHEAD UNION (With Lock Washer)

PART No.	Tube
1477-4	1/4
1477-6	3/8
1477-8	1/2
1477-10	5/8



TEE Tube To Female Pipe Center Male Pipe

PART No.	Tube	Pipe
1479-4B	1/4	1/4

BRASS PUSH-TO-CONNECT D.O.T. AIR BRAKE FITTINGS



(FOR D.O.T. AIR BRAKE TUBE: SEE PAGE 142)

D.O.T. RECOGNIZED FOR ALL AIR BRAKE APPLICATIONS EXCEPT THOSE FOR USE BETWEEN FRAME AND AXLE OR BETWEEN TOWED AND TOWING VEHICLES.

A



**UNION
COUPLING**

PART No.	Tube
PC1462-5/32	5/32
PC1462-4	1/4
PC1462-6	3/8
PC1462-8	1/2
PC1462-10	5/8
PC1462-12	3/4

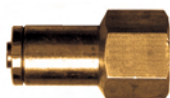

**CONNECTOR
Tube
To
Female Pipe**

PART No.	Tube	Pipe
PC1466-4A	1/4	1/8
PC1466-4B	1/4	1/4
PC1466-6B	3/8	1/4
PC1466-6C	3/8	3/8
PC1466-8C	1/2	3/8
PC1466-8D	1/2	1/2

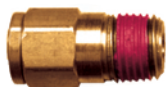

**CONNECTOR
Tube To
Male Pipe**

PART No.	Tube	Pipe
PC1468-5/32X1	5/32	1/16
PC1468-5/32A	5/32	1/8
PC1468-4A	1/4	1/8
PC1468-4B	1/4	1/4
PC1468-4C	1/4	3/8
PC1468-6A	3/8	1/8
PC1468-6B	3/8	1/4
PC1468L-6B	3/8 Long	1/4
PC1468-6C	3/8	3/8
PC1468-6D	3/8	1/2
PC1468-8B	1/2	1/4
PC1468-8C	1/2	3/8
PC1468-8D	1/2	1/2
PC1468-10C	5/8	3/8
PC1468-10D	5/8	1/2
PC1468-12D	3/4	1/2
PC1468-12E	3/4	3/4



**BULKHEAD
UNION**

PART No.	Tube
PC1477-4	1/4
PC1477-6	3/8
PC1477-8	1/2
PC1477-10	5/8



**BULKHEAD
UNION
Tube To
Female Pipe**

PART No.	Tube	Pipe
PC1486-4B	1/4	1/4
PC1486-6C	3/8	3/8
PC1486-8C	1/2	3/8

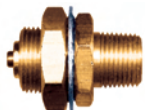

**BULKHEAD
UNION
Tube To
Male Pipe**

PART No.	Tube	Pipe
PC1483-6D	3/8	1/2
PC1483-8D	1/2	1/2



**90° ELBOW
Tube To
Tube**

PART No.	Tube
PC1465-4	1/4
PC1465-6	3/8
PC1465-8	1/2



**90° ELBOW
Tube To
Female Pipe**

PART No.	Tube	Pipe
PC1470-4A	1/4	1/8
PC1470-4B	1/4	1/4
PC1470-6B	3/8	1/4
PC1470-6C	3/8	3/8
PC1470-8D	1/2	1/2

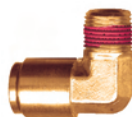

**90° ELBOW
Tube
To
Male Pipe**

PART No.	Tube	Pipe
PC1469-5/32A	5/32	1/8
PC1469-4A	1/4	1/8
PC1469-4B	1/4	1/4
PC1469-4C	1/4	3/8
PC1469-6A	3/8	1/8
PC1469-6B	3/8	1/4
PC1469-6C	3/8	3/8
PC1469-6D	3/8	1/2
PC1469-8B	1/2	1/4
PC1469-8C	1/2	3/8
PC1469-8D	1/2	1/2
PC1469-10C	5/8	3/8
PC1469-10D	5/8	1/2
PC1469-12D	3/4	1/2
PC1469-12E	3/4	3/4



**90° ELBOW
Tube To
Male Pipe
Swivel**

PART No.	Tube	Pipe
PC1469SW-4A	1/4	1/8
PC1469SW-4B	1/4	1/4
PC1469SW-4C	1/4	3/8
PC1469SW-6A	3/8	1/8
PC1469SW-6B	3/8	1/4
PC1469SW-6C	3/8	3/8
PC1469SW-6D	3/8	1/2
PC1469SW-8B	1/2	1/4
PC1469SW-8C	1/2	3/8
PC1469SW-8D	1/2	1/2
PC1469SW-10C	5/8	3/8
PC1469SW-10D	5/8	1/2
PC1469SW-12D	3/4	1/2
PC1469SW-12E	3/4	3/4



**45° ELBOW
Tube
To
Male Pipe**

PART No.	Tube	Pipe
PC1474-4A	1/4	1/8
PC1474-4B	1/4	1/4
PC1474-6A	3/8	1/8
PC1474-6B	3/8	1/4
PC1474-6C	3/8	3/8
PC1474-8B	1/2	1/4
PC1474-8C	1/2	3/8
PC1474-8D	1/2	1/2
PC1474-10D	5/8	1/2
PC1474-12D	3/4	1/2
PC1474-12E	3/4	3/4



**45° ELBOW
Tube To
Male Pipe
Swivel**

PART No.	Tube	Pipe
PC1474SW-4A	1/4	1/8
PC1474SW-4B	1/4	1/4
PC1474SW-6A	3/8	1/8
PC1474SW-6B	3/8	1/4
PC1474SW-6C	3/8	3/8
PC1474SW-6D	3/8	1/2
PC1474SW-8B	1/2	1/4
PC1474SW-8C	1/2	3/8
PC1474SW-8D	1/2	1/2
PC1474SW-10D	5/8	1/2



**UNION TEE
Tube Each
End**

PART No.	Tube
PC1464-4	1/4
PC1464-6	3/8
PC1464R-64	3/8 TO 1/4
PC1464-8	1/2
PC1464-10	5/8
PC1464-12	3/4



BRASS PUSH-TO-CONNECT D.O.T. AIR BRAKE FITTINGS (FOR D.O.T. AIR BRAKE TUBE: SEE PAGE 142)

D.O.T. RECOGNIZED FOR ALL AIR BRAKE APPLICATIONS EXCEPT THOSE FOR USE BETWEEN FRAME AND AXLE OR BETWEEN TOWED AND TOWING VEHICLES.

A

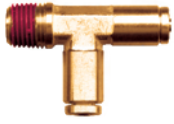

TEE
Ends Tube
and
Male Pipe
Center Tube

PART No.	Tube	Pipe
PC1471-4A	1/4	1/8
PC1471-4B	1/4	1/4
PC1471-6B	3/8	1/4
PC1471-6C	3/8	3/8
PC1471-8C	1/2	3/8

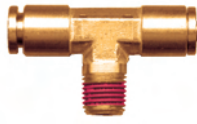

TEE
Ends Tube
Center
Male Pipe

PART No.	Tube	Pipe
PC1472-4A	1/4	1/8
PC1472-4B	1/4	1/4
PC1472-6A	3/8	1/8
PC1472-6B	3/8	1/4
PC1472-6C	3/8	3/8
PC1472-8B	1/2	1/4
PC1472-8C	1/2	3/8

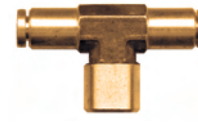

TEE
Ends Tube
Center
Female Pipe

PART No.	Tube	Pipe
PC1478-4A	1/4	1/8
PC1478-4B	1/4	1/4
PC1478-6B	3/8	1/4

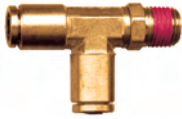

TEE
Ends Tube
and Male Pipe
Swivel
Center Tube

PART No.	Tube	Pipe
PC1471SW-4A	1/4	1/8
PC1471SW-4B	1/4	1/4
PC1471SW-6B	3/8	1/4
PC1471SW-6C	3/8	3/8
PC1471SW-8C	1/2	3/8
PC1471SW-8D	1/2	1/2

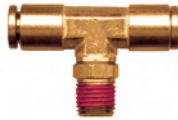

TEE
Ends Tube
Center Male
Pipe Swivel

PART No.	Tube	Pipe
PC1472SW-4A	1/4	1/8
PC1472SW-4B	1/4	1/4
PC1472SW-6B	3/8	1/4
PC1472SW-6C	3/8	3/8
PC1472SW-8B	1/2	1/4
PC1472SW-8C	1/2	3/8
PC1472SW-8D	1/2	1/2

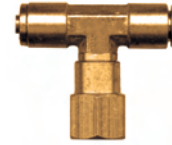

TEE
Ends Tube
Center Female
Pipe Swivel

PART No.	Tube	Pipe
PC1478SW-4A	1/4	1/8
PC1478SW-6B	3/8	1/4



**TUBE
INSERT**

PART No.	Tube
PC1400-4	1/4
PC1400-6	3/8
PC1400-8	1/2

ASSEMBLY INSTRUCTIONS

PUSH-TO-CONNECT FITTINGS FEATURE A LABOR SAVING FULL FLOW DESIGN THAT REQUIRES NO TOOLS.



TO CONNECT TUBE:

Cut tube as squarely as possible. Insert tube end into fitting, slide the I.D. of the tube over the tube support until friction is felt as tube slides past the O-ring. Using a slight twisting motion while inserting the tube is often helpful. After this initial friction is felt, continue to push in the tube until it bottoms firmly against the internal tube support.



TO DISCONNECT TUBE:

With thumb and forefinger, hold down the top of the insert against the fitting body and then, with the other hand, pull out the tube. No tools are needed.

AIR BRAKE TUBE FIELD REPAIR KIT

PART No. ABRF-KIT-1-PC

This kit includes a selection of Push-To-Connect fittings and tube to complete many temporary air brake tube repairs in the field or shop.

Single sided carry case, with handle.

Push-To-Connect; Repair Kit Selection:

PART No.	Qty	PART No.	Qty
1485-4-CUT	24 In.	PC1468-6C	2
1485-6-CUT	24 In.	PC1468-8C	1
1485-8-CUT	24 In.	PC1469-4A	2
PC1462-4	2	PC1469-6B	2
PC1462-6	2	PC1469-8C	1
PC1462-8	2	TK-1	1
PC1468-4A	2	ABRF-BOX-1	1
PC1468-6B	2		

**No Tools
Required**

Overall:
Height 12 inches
Width 14-1/2 inches
Depth 2-3/8 inches



AIR BRAKE SERVICE KIT

PART No. ABRF-KIT-2

Designed for use in the field or shop, this kit includes a selection of items to complete many general repairs.

New Compact Double sided carry case, with handle.

D.O.T. Air Brake & Pipe; Service Kit Selection:

PART No.	Qty	PART No.	Qty	PART No.	Qty
103-A	2	1460-6	3	1468-8C	2
103-B	2	1460-8	3	1469-4A	2
103-C	2	1460-10	2	1469-4B	2
103-D	1	1461-4	3	1469-6B	2
110-BA	3	1461-6	3	1469-6C	2
110-CB	2	1461-8	3	1469-8C	2
110-DC	2	1461-10	2	1481-4	3
121-B	3	1462-4	2	1481-6	3
121-C	2	1462-6	2	1481-8	3
121-D	2	1462-8	2	1481-10	3
121-M8	2	1462-10	1	X115-B	2
122-B	3	1468-4A	2	X115-C	2
122-C	2	1468-4B	2	ABRF-BOX-2	1
122-D	2	1468-6B	2		
1460-4	3	1468-6C	2		



Overall:
Height 9-3/4 inches
Width 14 inches
Depth 4 inches

BRASS D.O.T. AIR BRAKE FITTINGS ASSEMBLY INSTRUCTIONS

1. Cut tube squarely.
2. Slide nut and then sleeve onto tube.
3. Insert tube fitting until it bottoms on seat.

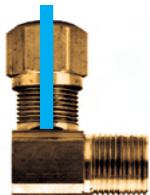

Full Turns
Clockwise

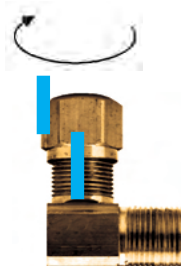

Wrench turns as per chart.

USE WITH 1485 TUBE

Tube Size	Additional number of full turns from hand tight.
1/4"	3
3/8", 1/2", and 5/8"	4
3/4"	3-1/2

4. Hand tighten and mark body.



BRASS D.O.T. AIR BRAKE HOSE COUPLINGS AND STEEL TERMINAL BOLTS

A



SLEEVE

PART No.	For Hose I.D.
1490-6	3/8
1490-8	1/2



NUT

PART No.	For Hose I.D.
1491-6	3/8
1491-8	1/2

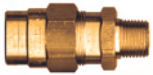

COUPLER ASSEMBLY (NUT, SLEEVE AND COUPLER)

PART No.	For Hose I.D.	Pipe
1492-6B	3/8	1/4
1492-6C	3/8	3/8
1492-6D	3/8	1/2
1492-8C	1/2	3/8
1492-8D	1/2	1/2

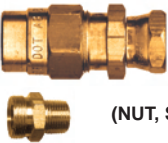

SWIVEL COUPLER ASSEMBLY (NUT, SLEEVE AND COUPLER)

PART No.	Hose I.D.	Pipe
1492SW-6	3/8	--
1492SW-8	1/2	--
1492SW-6B *	3/8	1/4
1492SW-6C *	3/8	3/8
1492SW-6D *	3/8	1/2
1492SW-8C *	1/2	3/8

* Complete with 4134 series adapter.



HOSE SPLICER

PART No.	For Hose I.D.
1492-6S	3/8
1492-8S	1/2

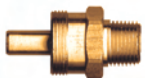

COUPLER

PART No.	For Hose I.D.	Pipe
B1492-6B	3/8	1/4
B1492-6C	3/8	3/8
B1492-6D	3/8	1/2
B1492-8C	1/2	3/8
B1492-8D	1/2	1/2

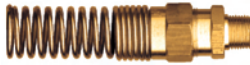

COUPLER ASSEMBLY WITH SPRING GUARD (NUT, SLEEVE, COUPLER AND SPRING)

PART No.	For Hose I.D.	Pipe
1493-6B	3/8	1/4
1493-6C	3/8	3/8
1493-6D	3/8	1/2
1493-8C	1/2	3/8
1493-8D	1/2	1/2



SWIVEL COUPLER ASSEMBLY WITH SPRING GUARD (NUT, SLEEVE, COUPLER AND SPRING)

PART No.	For Hose I.D.	Pipe
1493SW-6	3/8	--
1493SW-8	1/2	--
1493SW-6B *	3/8	1/4
1493SW-6C *	3/8	3/8
1493SW-8C *	1/2	3/8

* Complete with 4134 series adapter.



NUT WITH SPRING HOSE GUARD

PART No.	For Hose I.D.
1494-6	3/8
1494-8	1/2



TERMINAL BOLT (STEEL)

PART No.	Female Pipe	Length (IN.)
1495-C	3/8 X 3/8	1-3/8
1495-L	1/4 X 1/4	1-1/2
1495-S	1/4 X 1/4	31/32



TERMINAL BOLT (BRASS)

PART No.	Female Pipe	Length (IN.)
1495B-A	1/8 X 1/8	1-1/2
1495B-C	3/8 X 3/8	1-1/4
1495B-D	1/2 X 1/2	1-1/2
1495B-L	1/4 X 1/4	1-1/2
1495B-S	1/4 X 1/4	31/32



TERMINAL BOLT (STEEL)

PART No.	Pipe	Length (IN.)
1496-DC	1/2M X 3/8F	2

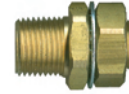

TERMINAL BOLT

PART No.	Pipe	Material	Length (IN.)
1497-DB	1/2M X 1/4F	Steel	2-3/4
1497-DBS	1/2M X 1/4F (Short)	Brass	1-5/8

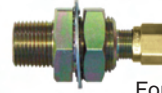

For Nylon



For Copper

TERMINAL BOLT (STEEL)

PART No.	For Nylon Tube	Pipe	Length (IN.)
1498N-6D	3/8 O.D.	1/2M X 1/4F	2-5/8

(Complete with 1461 series brass nut.)

PART No.	For Copper Tube	Pipe	Length (IN.)
1498-6D	3/8 O.D.	1/2M X 1/4F	3-1/4

(Complete with 1161 series brass nut & sleeve.)

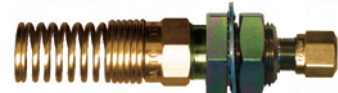

For Nylon



For Copper

TERMINAL BOLT (STEEL)

PART No.	For Nylon Tube	For Hose I.D.
1499N-6 *	3/8 O.D.	3/8

* Complete with 1461 series nut.

PART No.	For Copper Tube	For Hose I.D.
1499-6	3/8 O.D.	3/8



HOSE CONNECTOR FOR HAB ASSEMBLIES

PART No.	Straight Thread	Pipe
4134-6B	3/4-20	1/4
4134-6C	3/4-20	3/8
4134-6D	3/4-20	1/2
4134-8C	3/4-20	3/8
4134-8D	3/4-20	1/2
4134-8C-WH	7/8-20	3/8
4134-8D-WH	7/8-20	1/2

USED WITH HAB ASSEMBLIES.

BRASS D.O.T. AIR BRAKE COUPLINGS AND STEEL TERMINAL BOLTS



AIR BRAKE HOSE FIELD REPAIR KIT

Repair Kit Selection:
PART No. ABFR-KIT-HAB

Designed for use in the field, this kit includes a selection of items to complete many temporary air brake hose repairs.
Single sided carry case, with handle.



Kit Contains

PART No.	Qty	PART No.	Qty
HAB-6-CUT	16 In.	1492SW-8	1
HAB-8-CUT	16 In.	4134-6B	2
110-CB	2	4134-6C	2
110-DC	2	4134-8C-WH	2
121-M8	1	4134-8D-WH	2
1492-6S	1	TK-1	1
1492-8S	1	ABFR-BOX-1	1
1492SW-6	1		

Overall:

Height	12 inches
Width	14-1/2 inches
Depth	2-3/8 inches

AIR BRAKE HOSE MENDER KIT

Designed for use with **Type A, AI & AII SAE J1402 Air Brake Hose**, this kit includes two hose repair couplers and an Allen Wrench to make fast, temporary air brake hose repairs.
Hanger retail packaging, complete with assembly instructions.

PART No.	Packaging	Pipe	Hose	Minimum Hose O.D.
4120R-6C-RK	English / French	3/8	3/8	.750
4120R-6D-RK	English / French	1/2	3/8	.750
4120R-8C-RK	English / French	3/8	1/2	.875

PART No.
DSR
Countertop Display Rack
Available.



4120R-6C-RK



4120R-8C-RK

A



SWIVEL CONNECTOR
Hose Barb To Female Hose

HEX NUT (201-H)

PART No.	Hose I.D.
195-6	3/8
195-8	1/2
195-10	5/8
195-12	3/4
195-16 *	1

* 1" NPS - 11-1/2 T.P.I.

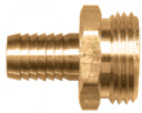

CONNECTOR
Hose Barb To Male Hose

PART No.	Hose I.D.
193-6	3/8
193-8	1/2
193-10	5/8
193-12	3/4
193-16 *	1

* 1" NPS - 11-1/2 T.P.I.



(FLAT STYLE) GHW



(FLAT STYLE) GHW-EPDM



(FLAT STYLE) GHW-S

PART No.	Description
GHW	GARDEN HOSE WASHER
GHW-EPDM	EPDM WASHER
GHW-S	STAINLESS STEEL SCREENED WASHER



200-W



201-H

PART No.	Description
200-W	KNURLED CAP NUT
201-H	OPEN HEX NUT



WATER PLUG

PART No.	Description
206-WP	(Square Head Plug)



HEX-KNURL CAP NUT

PART No.	Description
200-HKC	(With Chain)



SWIVEL COUPLING
Female Hose Both Ends

PART No.	Description
203-W	Water Thread



SWIVEL COUPLING
Female Hose To Female Pipe

PART No.	Pipe
199S-D	1/2
199S-E	3/4



SWIVEL CONNECTOR
Female Hose To Male Pipe

PART No.	Pipe
194-B	1/4
194-C	3/8
194-D	1/2

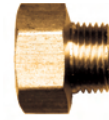

Female Hose To Male Pipe

PART No.	Pipe
199-D	1/2
199-E	3/4



COUPLING
Male Hose To Female Pipe

PART No.	Pipe
197-B	1/4
197-C	3/8
197-D	1/2
197-E	3/4

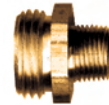

COUPLING
Male Hose To Male Pipe

PART No.	Pipe
196-C	3/8
196-D	1/2
196-E	3/4

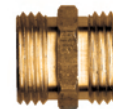

COUPLING
Male Hose To Male Hose

PART No.	Description
196-W	MALE HOSE TO MALE HOSE



COUPLING
Female Hose To Female Pipe

PART No.	Pipe
198-D	1/2
198-E	3/4

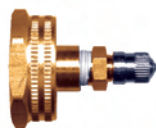

WATER LINE AIR DRAIN VALVE

PART No.
204

Description
HEX KNURLED CAP NUT TO AIR VALVE

Ideally suited for Recreational Vehicle Winter Prep.

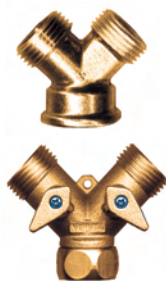

Y COUPLINGS Male Hose To Female Hose

PART No.
202-WV
202-W

Style
VALVED
PLAIN



STRAIGHT COUPLING Male Hose To Female Hose

PART No.
199-WV

Style
VALVED

DISHWASHER INLET WATER SUPPLY CONNECTION



For Use With Copper or Flexible Water Supply Lines on New Style Inlet (Male Water Thread)

INCLUDES EPDM WASHER.



PART No.
DWF-6

Description
FEMALE WATER HOSE TO 3/8 COMPRESSION

DWF-6P

Packaged (Complete with Washer, Compression Nut & Sleeve) (Poly Bagged) English & French Description with UPC

BRASS WATER HOSE (GARDEN HOSE) QUICK DISCONNECTS

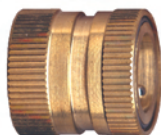

PART No.
QD-WHCF

DESCRIPTION
Quick Disconnect Coupler X Water Hose Thread



PART No.
QD-WHNM

DESCRIPTION
Quick Disconnect Nipple X Water Hose Thread

QD-WHVCF

Valved QD Coupler X Water Hose Thread

• TO BE USED WITH DOMESTIC (CITY) WATER SUPPLY. • WATER NOZZLES SEE PAGE 241

KARCHER STYLE PRESSURE WASH HOSE ADAPTERS



PART No.

QD-KARCHER-6F
QD-KARCHER-6M



Pipe Size

3/8 FPT X M22 X 1.5
3/8 MPT X M22 X 1.5

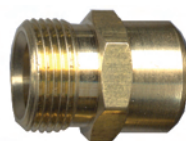

PART No.

QD-KARN-6F
QD-KARN-6M



Pipe Size

3/8 FPT X M22 X 1.5
3/8 MPT X M22 X 1.5

• USED TO ADAPT STANDARD PRESSURE WASH HOSES TO KARCHER STYLE EQUIPMENT. • ABOVE PRESSURE WASH COUPLINGS COME WITH EPR O-RING GOOD FOR HOT WATER UP TO 200°F • PRESSURE RATING: 4000 PSI

A

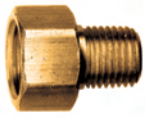

CONNECTOR INVERTED FLARE TO MALE PIPE



PART No.	Inverted Flare	Pipe
148-4B	1/4	1/4
148CV-4B	1/4 With Check	1/4
BB-148CV-4B Blister Box Packaging. (Packaged X 2)		

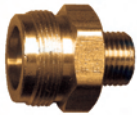

CYLINDER PRIMUS BY PROPANE THREAD

PART No.	Cylinder Thread	Primus Thread	Propane Thread
1985	1"-20	M14 X 1.5	9/16-18 LH
1985P Bag Packaged			
2093	1"-20	M14 X 1.5 (With Check)	9/16-18 LH



CYLINDER PRIMUS BY S.A.E. FLARE

PART No.	Cylinder Thread	Primus Thread	Tube
2091	1"-20	M14 X 1.5 (With Check)	3/8



CYLINDER PRIMUS BY FEMALE PIPE

PART No.	Cylinder Thread	Primus Thread	Pipe
2092	1"-20	M14 X 1.5	1/4

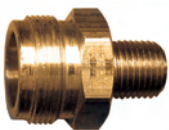

CYLINDER PRIMUS BY MALE PIPE

PART No.	Cylinder Thread	Primus Thread	Pipe
2096	1"-20	M14 X 1.5 (with check)	1/4



CYLINDER ADAPTER

PART No.	Cylinder Thread	Male Pipe
2098	1"-20 With Check	1/4
BB-2098	1"-20 Blister Boxed	1/4

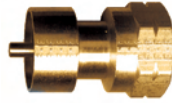

RESERVE CYLINDER ADAPTER



PART No.	Cylinder Thread	P.O.L.
2097	F. 1"-20	Female
BB-2097	Blister Boxed	

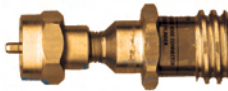

LAST CHANCE CYLINDER ADAPTER



PART No.	Cylinder Thread	QCC1
2491	F. 1"-20	Female
BB-2491	Blister Boxed	



CYLINDER ADAPTER

PART No.	Thread	QCC1
2399	1/4 M.P.T.	Female

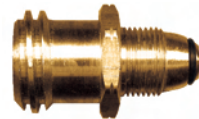

P.O.L. TO QCC1 ADAPTER



PART No.	QCC1	P.O.L.
2087	Female	Male
BB-2087	Blister Boxed	



PROPANE MOTOR FUEL FILL ADAPTER

PART No.	Female P.O.L. X
2017	1-3/4 ACME THREAD

ALLOWS A STANDARD P.O.L. FITTING TO BE ADAPTED TO FILL AN ENGINE FUEL TANK.

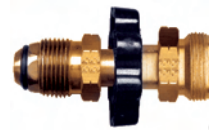

P.O.L. TO CYLINDER PRIMUS ADAPTER

(With Handwheel)

PART No.	Cylinder Thread	Primus Thread	P.O.L.
2095	1"-20	M14 X 1.5	Male
BB-2095	Blister Boxed		



TAILPIECE ASSEMBLY

PART No.	Thread	O.A.L.
2002	1/4 M.P.T.	2-1/2"

O.A.L. - OVERALL LENGTH IN INCHES

TAILPIECE ASSEMBLY WITH HEX HEAD (Nut & Stem)

PART No.	Thread	O.A.L.
2002-H-HN	1/4 M.P.T.	2"



TAILPIECE COUPLING (SOLID)

PART No.	Thread	O.A.L.
2014-D	1/2 M.P.T.	2"



EXCESS FLOW TAILPIECE ASSEMBLY



PART No.	Thread	O.A.L.
2003-T	1/4 M.P.T.	2-3/8"
BB-2003-T	Blister Boxed	



PROPANE GAS FITTINGS



A

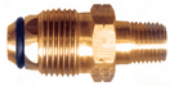

RESTRICTED FLOW TAILPIECE ASSEMBLY

WITH O-RING

PART No.	Thread	O.A.L.
2003-T-GH-60	1/4 M.P.T.	2"

(#60 ORIFICE HOLE WITH O-Ring HEX-HEAD)

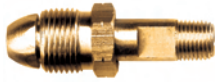

HIGH FLOW TAILPIECE ASSEMBLY 1.8 G.P.M.



HARD NOSE (NO O-RING)

PART No.	Thread	O.A.L.
2003-T-HN-HF	1/4 M.P.T.	2-3/8"
BB-2003-T-HN-HF		Blister Boxed

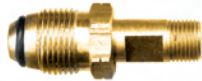

TAILPIECE ASSEMBLY

WITH O-RING

PART No.	Thread	O.A.L.
2018-L	9/16-18 L.H.	2-1/2"
2018-LP	9/16-18 L.H. (Packaged)	2-1/2"

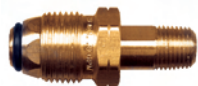

EXCESS FLOW TAILPIECE ASSEMBLY



WITH O-RING

PART No.	Thread	O.A.L.
2019-L	9/16-18 L.H.	2-3/8"



COUPLING P.O.L. BY S.A.E. FLARE

WITH O-RING

PART No.	Tube
2005-6	3/8
2005-8	1/2



COUPLING P.O.L. BY Female PIPE

PART No.	Pipe
2008-B	1/4



COUPLING Female P.O.L. BY MALE PIPE

PART No.	Pipe
2011-B	1/4
2011-D	1/2
2011-E	3/4



COUPLING Female P.O.L. BY Female PIPE

PART No.	Pipe
2016-B	1/4
2016-D	1/2



U.L. LISTED QCC1 CONNECTION 1-5/16" Female ACME TAILPIECE ASSEMBLY

PART No.	Thread	BTU * Capacity	Color Code
GR-1B-100	1/4 M.P.T.	100,000	Black
BB-GR-1B-100		Blister Box Packaging.	
GR-1B-200	1/4 M.P.T.	200,000	Green
BB-GR-1B-200		Blister Box Packaging.	

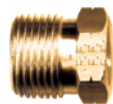

P.O.L. NUT

PART No.	Hex
2002-B	7/8"



HAND WHEEL

PART No.
HW

• WILL FIT 2002-B P.O.L. NUT.



PLASTIC ACME CAP

	To Cover Thread
2081	1-5/16 ACME
BB-2081	Blister Boxed

FOR USE WITH QCC1 CYLINDER VALVE



P.O.L. CAP NUT

PART No.
2004



BRASS CYLINDER THREAD CAP

PART No.	Thread
2082	1" - 20



PLASTIC POL PLUG (WITH STRAP)

PART No.
BB-PLUG-POL
Blister Boxed



P.O.L. O-Ring

PART No.
BB-OR-POL5
(Pack of 5)



P.O.L. SEALING PLUG

PART No.	HARD NOSE (NO O-RING)
2010	

CYLINDER PRIMUS BY O-Ring P.O.L

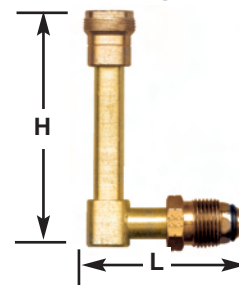

PART No.	Cylinder Thread	Primus Thread	H	L
8815	1" - 20	M14X1.5	4-1/4"	3"

SUFFIX PART NUMBER WITH THE LETTER "P" FOR RETAIL SALES PACKAGING.

A

DUAL TANK MANIFOLD TEE



PART No.	Inlets	Outlet
2000	1/4 Inv. Flare	1/4 Male Pipe
BB-2000	Blister Boxed	

MANIFOLD BLOCK TEE ASSEMBLY For Dual Tank Installations



Female P.O.L.
By
Male P.O.L.

PART No.	Description
2001-S	COMPLETE WITH O-Ring
2001-SX	EXCESS FLOW TAILPIECE COMPLETE WITH HARD NOSE P.O.L.

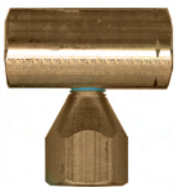

Female P.O.L.
All
Ends

2001-F	Female P.O.L. (x3)
--------	--------------------

PROPANE BRANCH TEE (With P.O.L.)

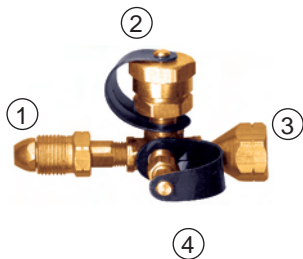

PART No.	1	2	3	4
2090	Male P.O.L.	Male 1"-20 Cylinder Thread With Cap	Female P.O.L.	1/4" Female Inverted Flare With Plug

PROPANE BRANCH TEE (With QCC1)

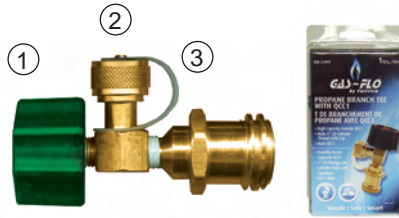

PART No.	1	2	3
2499	High Capacity Female QCC1	Male 1"-20 Cylinder Thread With Cap	Male QCC1

BB-2499 Blister Boxed

WARNING:

GAS LANTERNS ARE NOT TO BE USED IN CONJUNCTION WITH QCC1 CONNECTIONS.

PROPANE BRANCH TEE (With Handwheel)

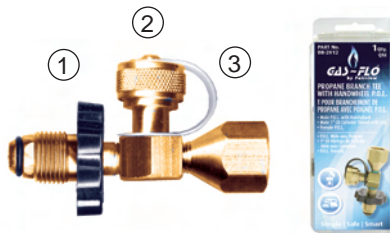

PART No.	1	2	3
2012	Male P.O.L.	Male 1"-20 Cylinder Thread With Cap	Female P.O.L.

BB-2012 Blister Boxed

PROPANE BRANCH TEE (With QCC1)

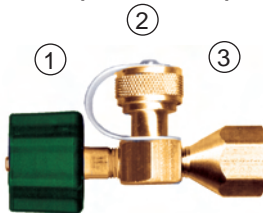

PART No.	1	2	3
2013	High Capacity Female QCC1	Male 1"-20 Cylinder Thread With Cap	Female P.O.L.

WARNING:

GAS LANTERNS ARE NOT TO BE USED IN CONJUNCTION WITH QCC1 CONNECTIONS.

PROPANE BRANCH TEE (With Handwheel)

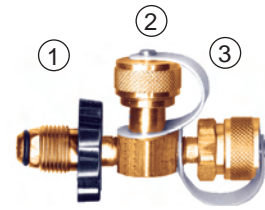

PART No.	1	2 & 3
2099	Male P.O.L.	Male 1"-20 Cylinder Thread With Cap

BB-2099 Blister Boxed

PROPANE BRANCH TEE (With Cylinder Thread)

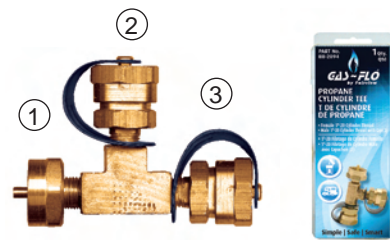

PART No.	1	2 & 3
2094	Female Cylinder Thread	Male 1"-20 Cylinder Thread With Cap

BB-2094 Blister Boxed

PROPANE BRANCH TEE (With QCC1)

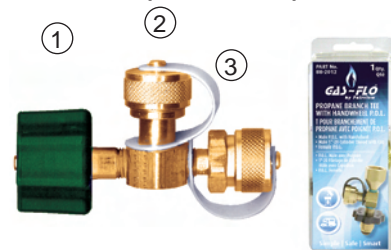

PART No.	1	2 & 3
2015	High Capacity Male QCC1	Male 1"-20 Cylinder Thread With Cap

BB-2015 Blister Boxed

WARNING:

GAS LANTERNS ARE NOT TO BE USED IN CONJUNCTION WITH QCC1 CONNECTIONS.

ACME DUST CAPS

2309



Plastic Acme Caps

PART No.	Description
2309	1-3/4" Female Acme Cap - Yellow Plastic
2309-1	1-3/4" Female Acme Cap w/ Chain Assembly - Yellow Plastic

ACME FITTINGS

2320

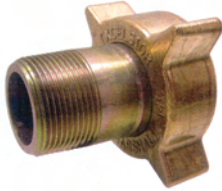

Brass Filler Couplings

PART No.	Description
2320	2-1/4" F. Acme x 1-1-4" M.NPT Filler Coupling - Brass Nut/Brass Nipple
2330	3-1/4" F. Acme x 2" M.NPT Filler Coupling - Brass Nut/Steel Nipple

2410



Brass Male Acme x FNPT Adapters

PART No.	Description
2410	1-3/4" Male Acme x 1/4" F.NPT

2341

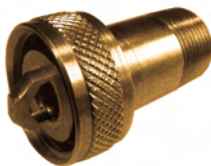

Brass Vapor Couplings

PART No.	Description
2341	1-1/4" F.Acme x 1/2" M.NPT Vapor Return Valve

TEST KIT

2329



Low Pressure Test Kits

PART No.	Description
2329	Low Pressure Test Kit, 0-35" w.c. Gauge Assembly

A

QUICK ACTING VALVES FOR CYLINDER CHARGING HOSES

APPLICATION

These valves are designed for use primarily on cylinder filling operations and industrial applications where quick and precise on and off opening is necessary. • Positive shut-off • One hand operation • Non corrosive brass construction • Locking and non locking handle.

2360

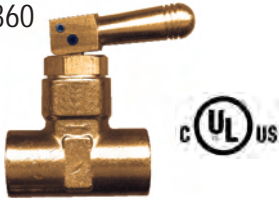

Quick Acting Toggle Valves	
PART No.	Description
2360	1/2" F.NPT x 1/4" F. NPT

FILLER HOSE ADAPTERS

APPLICATION

These adapters are intended to be attached to the LP-gas delivery truck hose outlets. All have minimal flow restriction which allows for fast delivery and also gives the user the ability to remove the filler hose in the event that the valve fails to close. In the event of a filler valve failure the integral check valve prevents loss of product.



Filler Hose Adapters	
PART No.	Description
2368 *	1-3/4" Female Acme x Female POL
2370	1-3/4" Female Acme x 1"-3/4" Male Acme
2372	1-3/4" Female Acme x 1"-3/4" Male Acme

* Primarily used where fill operation and connections have limited access, allowing for use on smaller POL type fill valve assembly



HYDROSTATIC RELIEF VALVES

APPLICATION

Hydrostatic Relief Valves. Compact Design to fit any application. Specifically designed internal components to increase flow at discharge. Non-adjustable, tamper resistant design. Protective vinyl cap included. Brass construction for LP-Gas applications Stainless Steel construction for Anhydrous Ammonia applications.

2480

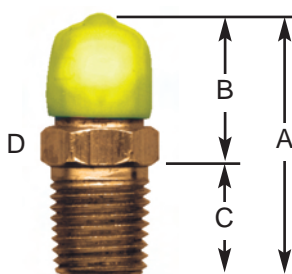

PART No.	Material	Start to Discharge Setting	Inlet (IN.)	A (IN.)	B (IN.)	C (IN.)	Wrenching Hex (D)
2480	Brass	440 PSIG	1/4" NPT	1-1/16"	13/16"	1/4"	9/16"



BRASS GAS APPLIANCE ORIFICES



A

Field Service Orifice Kit
Fairview's FKGO KIT includes 12 of the most commonly used orifices.



Kit Contains:

PART No.	Kit Qty.	Part No.	Kit Qty.
GO6	20	GO30	15
GO8	15	GO100	25
GO9	15	81-3N	10
GO15	10	81-4N	10
GO17	10	181-2	20
GO26	20	181-4	20

PART No.	Description	Drill Size	Box Size
FKGO-LP	LP Gas	#72 (.0250)	11x6-3/4x1-3/4
FKGO-NG	Natural Gas	#56 (.0465)	11x6-3/4x1-3/4
FKGO-BOX	Plastic Box Only		11x6-3/4x1-3/4

STARTING HOLES:

-72 = .0250, -80 = .0135, -BL = NO STARTING HOLE
OTHER STARTING HOLES AND IDENTIFICATION STAMPING AVAILABLE ON REQUEST. SEE PAGE 237 FOR DRILL SIZING.



PART No. GO5-72
Thread Size 1/4-32



PART No. GO6-72
Thread Size 1/4-28



PART No. GO8-72
Thread Size 11/32-32



PART No. GO9-72
Thread Size 7/16-27

CAP ORIFICES



PART No. GO15-72
Thread Size 3/8-27



PART No. GO17-72
Thread Size 1/8 F.P.T.



PART No. GO26-72
Thread Size 5/16-32



PART No. GO30-72
Thread Size 1/8 M.P.T.



PART No. GO31-72
Thread Size 1/4 M.P.T.

PILOT NUTS

BREAKAWAY TYPE

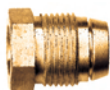

PART No.
81-2N 1/8
81-3N 3/16
81-4N 1/4
81L-4N Long 1/4

ONE PIECE TYPE

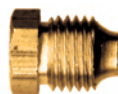

PART No.
181-2 1/8
181-3 3/16
181-4 1/4

GAS SPUD AND ORIFICE



PART No. GS21
GO9-72

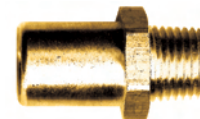

Orifice Thread 7/16-27
7/16-27
Thread Size 1/4 M.P.T.
Orifice

GAS SLOTTED CAP JET



PART No.
GS22-67 1/8 M.P.T. 1/2" HEX 67
GS22-76 1/8 M.P.T. 1/2" HEX 76
GS22-B BODY ONLY
GS22-C CAP ONLY

ORIFICE REPAIR ADAPTER



GO100
Repairs obsolete and modern cap orifices quickly.
PART No. GO100-Blank
GO100-72



ADAPTER INSTALLED

TAPERED PILOT BROACHES



PART No. G1008 - Tapers from .008" to .017"
G3015 - Tapers from .003" to .013"



Hexagon Brass Handle
G3020 - Tapers from .003 to .013

PILOT LINE KIT

PART No. FKPL-1

Designed for use in the field, Fairview's Pilot Line Kit offers a selection of popular brass compression and gas orifice fittings in an impact resistant, single sided carry case.

Kit Contains:

PART No.	Qty.	PART No.	Qty.	PART No.	Qty.	PART No.	Qty.
60-2	5	62-3	4	81-2N	5	GO9-72	1
60-3	10	62-4	4	81-3N	5	GO17-72	2
60-4	10	68-2A	2	81-4N	10	GO100-BLANK	2
61-2	5	68-3A	2	121-M8UL	1	GO100-BLANK	2
61-3	10	68-3B	2	ABFR-BOX-1	1	D56	1
61-4	10	68-4A	2	G3015	6		
62-2	2	68-4B	2	G3020	1		



Overall:

Height 12 inches
Width 14-1/2 inches
Depth 2-3/8 inches



BRASS WELDING FITTINGS

A



**OXYGEN
TYPE "B"
STANDARD
Right Hand
Thread**

HOSE NUT

PART No.	Thread	Hex Dia.
137-R	9/16-18 R.H.	11/16

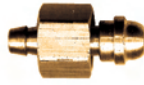

**OXYGEN
TYPE "B"
STANDARD
Combination
137-R Nut
and 138 Nipple**

HOSE NUT & NIPPLE SET

PART No.	Hose I.D.	Thread
132-3R	3/16	9/16-18 R.H.
132-4R	1/4	9/16-18 R.H.
132-5R	5/16	9/16-18 R.H.
132-6R	3/8	9/16-18 R.H.

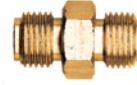

**OXYGEN
TYPE "B"
STANDARD
Right Hand
Thread**

HOSE COUPLER

PART No.	Thread	Hex Dia.
136-R	9/16-18 R.H.	11/16

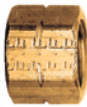

**ACETYLENE
TYPE "B"
STANDARD
Left Hand
Thread**

HOSE NUT

PART No.	Thread	Hex Dia.
137-L	9/16-18 L.H.	11/16

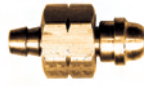

**ACETYLENE
TYPE "B"
STANDARD
Combination
137-L Nut
and 138 Nipple**

HOSE NUT & NIPPLE SET

PART No.	Hose I.D.	Thread
133-3L	3/16	9/16-18 L.H.
133-4L	1/4	9/16-18 L.H.
133-6L	3/8	9/16-18 L.H.

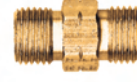

**ACETYLENE
TYPE "B"
STANDARD
Left Hand
Thread
Both Ends**

HOSE COUPLER

PART No.	Thread	Hex Dia.
136-L	9/16-18 L.H.	5/8



**OXYGEN
TYPE "B"
STANDARD
Right Hand
Thread**

OUTLET BUSHING

PART No.	Thread
135-RB	9/16-18 R.H. X 1/4 M.P.T.



**TYPE "B"
STANDARD
Use With
137-R or
L Nuts**

HOSE BARB NIPPLE

PART No.	Hose I.D.
138-3	3/16
138-4	1/4
138-6	3/8

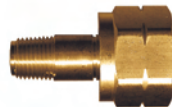

**CGA 555
SWIVEL
ADAPTER**

PART No.	Nipple Thread	Nut Thread
GR-555	1/4 MPT	903-14 NGO L.H.

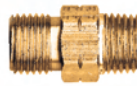

**ACETYLENE
TYPE "B"
STANDARD
Left Hand
Thread**

OUTLET BUSHING

PART No.	Thread
135-LB	9/16-18 L.H. X 1/4 M.P.T.
135-LC	9/16-18 L.H. X 3/8 M.P.T.
135-LD	9/16-18 L.H. X 1/2 M.P.T.

C.S.A. APPROVED TYPE I PROPANE HOSE ASSEMBLIES

C.S.A. Approved to C.G.A. Standard 8.1 (Thermoplastic 8.3) Used To Conduct Propane In Either A Liquid Or Gaseous State Up To 350 P.S.I.



**FW
FEMALE WELDING
9/16-18 L.H.**



**FW
FEMALE WELDING
9/16-18 L.H.**

For Welding Hose Assemblies See Page 236

STEEL GREASE FITTINGS



A



STRAIGHT

PART No.	Thread Size	Overall Length (IN.)
GN-607	1/8 x 27	1.25
GN-610	1/8 x 27	0.62
GN-627	1/4 x 18	0.80
GN-641	1/4 x 28	0.54
GN-652	1/4 x 28	0.67
GN-680	1/4 x 28	0.93



STRAIGHT METRIC

PART No.	Thread Size	Overall Length (mm)
GNM-301	10mm x 1	15.2
GNM-601	6mm x 1	13.5
GNM-901	8mm x 1	15.0

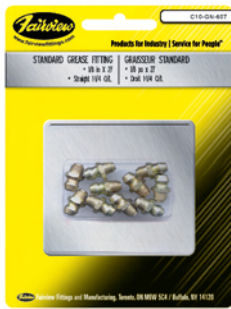

Grease fittings are available packaged on carded blister packs, ten per card.

Prefix PART No. with C10- (10 Pcs.)
egample C10-GN607

GREASE WHIP COUPLER

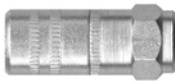

4-Jaw steel coupler for use with rubber or nylon grease whip hose assemblies.

PART No.	Pipe
GWC-A	1/8
C-GWC-A	Carded X 1



GREASE FITTING KIT
GN-100-KIT



45° ANGLE

PART No.	Thread Size	Overall Length (IN.)
GN-637	1/4 x 28	0.88
GN-688	1/8 x 27	0.98



45° ANGLE METRIC

PART No.	Thread Size	Overall Length (mm)
GNM-045	6mm x 1	22.6
GNM-345	10mm x 1	23.5
GNM-445	8mm x 1	22.6



90° ANGLE

PART No.	Thread Size	Overall Length (IN.)
GN-613	1/8 X 27	0.82
GN-911	1/4 X 28	0.69



90° ANGLE METRIC

PART No.	Thread Size	Overall Length (mm)
GNM-090	6mm x 1	18.0
GNM-390	10mm x 1	19.0
GNM-490	8mm x 1	18.0



65° ANGLE

PART No.	Thread Size	Overall Length (IN.)
GN-612	1/8 X 27	0.88
GN-629	1/4 X 18	0.96



DRIVE FIT

PART No.	Thread Size	Overall Length (IN.)
GN-608	5/16	0.58
GN-728	3/16	0.50
GN-743	1/4	0.50

GREASE FITTING KITS

Fairview's Grease Fitting kits provide the most popular grease nipple fittings all in one place when you need them. This light weight compact kit is ideal for any shop.

PART No.	Description
GN-100-KIT	Standard
GNM-100-KIT	Metric

GREASE FITTINGS ASSORTMENT KITS

PART No. GN-100-KIT
100 STANDARD GREASE FITTINGS IN 6 POPULAR SIZES
KIT CONTAINS:

PART No.	Quantity	Style	Thread Size	Overall Length (IN.)
GN-610	20	Straight	1/8 x 27	0.62
GN-613	4	90°	1/8 X 27	0.82
GN-637	6	45°	1/4 x 28	0.88
GN-641	60	Straight	1/4 x 28	0.54
GN-688	4	45°	1/8 x 27	0.98
GN-911	6	90°	1/4 X 28	0.69

PART No. GNM-100-KIT
100 METRIC GREASE FITTINGS IN 6 POPULAR SIZES
KIT CONTAINS:

PART No.	Quantity	Style	Thread Size	Overall Length (mm)
GNM-045	10	45°	6mm x 1	22.6
GNM-090	10	90°	6mm x 1	18.0
GNM-301	10	Straight	10mm x 1	15.2
GNM-445	10	45°	8mm x 1	22.6
GNM-601	40	Straight	6mm x 1	13.5
GNM-901	20	Straight	8mm x 1	15.0

OPERATING AND BURST PRESSURES OF HYDRAULIC FITTINGS

A

MAXIMUM OPERATING (P.S.I.)

Dash Size	37° S.A.E.		NPTF			O-Ring Boss		O-Ring Face Seal		Flareless Tube
	Male	Swivel	Male Pipe	Female Pipe	Female Pipe Swivel	Male	Female	Studs	Adjusting Studs	
-5	5000	4000	-	-	-	5000	5000	-	-	5000
-6	5000	4000	4000	4000	4000	5000	5000	6000	6000	4000
-8	4500	4000	3000	3000	4000	4500	4500	6000	6000	3000
-10	3500	3000	-	-	-	3500	3500	6000	6000	3000
-12	3500	3000	2500	2500	3000	3500	3500	6000	6000	2500
-14	3000	2500	-	-	-	3000	3000	-	-	2500
-16	3000	2500	2000	2000	2500	3000	3000	6000	5000	2000
-20	2500	2000	1150	1150	2000	2500	2500	4000	4000	1150
-24	2000	1500	1000	1000	1500	2000	2000	4000	3000	1000
-32	1500	1125	1000	1000	1125	1500	-	-	-	1000

MINIMUM BURST (P.S.I.)

Dash Size	37° S.A.E.		NPTF			O-Ring Boss		O-Ring Face Seal		Flareless Tube
	Male	Swivel	Male Pipe	Female Pipe	Female Pipe Swivel	Male	Female	Studs	Adjusting Studs	
-4	20000	18000	20000	20000	18000	20000	20000	24000	24000	20000
-5	20000	16000	-	-	-	20000	20000	-	-	20000
-6	20000	16000	16000	16000	16000	20000	20000	24000	24000	16000
-8	18000	16000	12000	12000	16000	18000	18000	24000	24000	12000
-10	14000	12000	-	-	-	14000	14000	24000	24000	12000
-12	14000	12000	10000	10000	12000	14000	14000	24000	24000	10000
-14	12000	10000	-	-	-	12000	12000	-	-	10000
-16	12000	10000	8000	8000	10000	12000	12000	24000	20000	8000
-20	10000	8000	4600	4600	8000	10000	10000	16000	16000	4600
-24	8000	6000	4000	4000	6000	8000	8000	16000	12000	4000
-32	6000	4500	4000	4000	4500	6000	-	-	-	4000
-40	5000	4500	5000	5000	4500	5000	5000	6000	6000	5000

NOTE: If a fitting has multiple ends, (i.e. 1/2 male pipe to 3/8 male pipe) or one or more different style ends, (i.e. O-ring boss to male pipe threads.), it is recommended that the lower pressure of the two end styles must be recognized as the working pressure rating for that fitting.

STEEL 37° J.I.C. FLARE SWIVEL ADAPTERS



A



CONNECTOR
Female 37°
Swivel To
Male Pipe

PART No.	Swivel	Pipe
S3520-4A	1/4	1/8
S3520-4B	1/4	1/4
S3520-6B	3/8	1/4
S3520-6C	3/8	3/8
S3520-8C	1/2	3/8
S3520-8D	1/2	1/2
S3520-10D	5/8	1/2
S3520-10E	5/8	3/4
S3520-12D	3/4	1/2
S3520-12E	3/4	3/4
S3520-16E	1	3/4
S3520-16H	1	1
S3520-20J	1-1/4	1-1/4
S3520-24K	1-1/2	1-1/2
S3520-32M	2	2



CONNECTOR
Female 37°
Swivel To
Male O-Ring

PART No.	Swivel	O-Ring
S3522-4	1/4	7/16 - 20
S3522-6	3/8	9/16 - 18
S3522-8	1/2	3/4 - 16
S3522-8E	1/2	9/16 - 18
S3522-10	5/8	7/8 - 14
S3522-12	3/4	1-1/16 - 12
S3522-16	1	1-5/16 - 12
S3522-20	1-1/4	1-5/8 - 12



CONNECTOR
Female 37°
Swivel To
Female Pipe

PART No.	Swivel	Pipe
S3526-4A	1/4	1/8
S3526-4B	1/4	1/4
S3526-6B	3/8	1/4
S3526-6C	3/8	3/8
S3526-8C	1/2	3/8
S3526-8D	1/2	1/2
S3526-10D	5/8	1/2
S3526-12E	3/4	3/4
S3526-16H	1	1
S3526-20J	1-1/4	1-1/4
S3526-24K	1-1/2	1-1/2



UNION
Female 37°
Swivel

PART No.	Swivel
S3542-4	1/4
S3542-6	3/8
S3542-8	1/2
S3542-12	3/4
S3542-16	1



CONNECTOR
Female 37°
Swivel To
Male JIC

PART No.	Swivel	Tube
S3548-4	1/4	1/4
S3548-6	3/8	3/8
S3548-8	1/2	1/2
S3548-10	5/8	5/8
S3548-12	3/4	3/4
S3548-16	1	1



90° ELBOW
Female 37°
Swivel To
Male Pipe

PART No.	Swivel	Pipe
S3516-4A	1/4	1/8
S3516-4B	1/4	1/4
S3516-6B	3/8	1/4
S3516-6C	3/8	3/8
S3516-8C	1/2	3/8
S3516-8D	1/2	1/2
S3516-10D	5/8	1/2
S3516-12E	3/4	3/4
S3516-16H	1	1



90° ELBOW
Female 37°
Swivel To
Male O-Ring

PART No.	Swivel	O-Ring
S3599-6	3/8	9/16 - 18
S3599-8	1/2	3/4 - 16
S3599-10	5/8	7/8 - 14
S3599-12	3/4	1-1/16 - 12
S3599-16	1	1-5/16 - 12



90° ELBOW
Female 37°
Swivel To
Male JIC

PART No.	Swivel	Tube
S3549-4	1/4	1/4
S3549-5	5/16	5/16
S3549-6	3/8	3/8
S3549-6B	3/8	1/2
S3549-8	1/2	1/2
S3549-8E	1/2	3/8
S3549-810	1/2	5/8
S3549-10	5/8	5/8
S3549-12	3/4	3/4
S3549-16	1	1
S3549-20	1-1/4	1-1/4
S3549-24	1-1/2	1-1/2
S3549-32	2	2



90° BENT TUBE ELBOW
Female 37°
Swivel To
Male JIC

PART No.	Swivel	Tube	Drop Length
S3549BT-4	1/4	1/4	0.68
S3549BT-8	1/2	1/2	1.09
S3549BT-10	5/8	5/8	1.23
S3549BT-12	3/4	3/4	1.83
S3549BT-16	1	1	2.14
S3549BT-20	1-1/4	1-1/4	9999



90° BENT TUBE ELBOW (LONG STYLE)
Female 37°
Swivel To M. JIC

PART No.	Swivel	Tube	Drop Length
S3549LBT-8	1/2	1/2	2.44
S3549LBT-10	5/8	5/8	2.58
S3549LBT-12	3/4	3/4	3.73
S3549LBT-16	1	1	4.33



45° ELBOW
Female 37°
Swivel To
Male JIC

PART No.	Swivel	Tube
S3554-4	1/4	1/4
S3554-6	3/8	3/8
S3554-8	1/2	1/2
S3554-10	5/8	5/8
S3554-12	3/4	3/4
S3554-16	1	1
S3554-20	1-1/4	1-1/4
S3554-24	1-1/2	1-1/2



TEE
Male JIC To
Male JIC To
Female 37°
Swivel

PART No.	Swivel	Tube
S3545-4	1/4	1/4
S3545-6	3/8	3/8
S3545-8	1/2	1/2
S3545-10	5/8	5/8
S3545-12	3/4	3/4
S3545-16	1	1
S3545-20	1-1/4	1-1/4



TEE
Tube To Female
37° Swivel To
Male JIC

PART No.	Swivel	Tube
S3551-4	1/4	1/4
S3551-6	3/8	3/8
S3551-8	1/2	1/2
S3551-10	5/8	5/8
S3551-12	3/4	3/4
S3551-16	1	1
S3551-20	1-1/4	1-1/4

A



SLEEVE

PART No.	Tube
S3721-4	1/4
S3721-6	3/8
S3721-8	1/2
S3721-10	5/8
S3721-12	3/4
S3721-16	1
S3721-20	1-1/4



SLEEVE NUT

PART No.	Tube
S3720-4	1/4
S3720-6	3/8
S3720-8	1/2
S3720-10	5/8
S3720-12	3/4
S3720-16	1
S3720-20	1-1/4



REDUCER Female JIC To Male JIC (ONE PIECE TYPE)

PART No.	Female Tube	Male Tube
S3735-46	1/4	3/8
S3735-64	3/8	1/4
S3735-65	3/8	5/16
S3735-68	3/8	1/2
S3735-84	1/2	1/4
S3735-86	1/2	3/8
S3735-810	1/2	5/8
S3735-812	1/2	3/4
S3735-106	5/8	3/8
S3735-108	5/8	1/2
S3735-1012	5/8	3/4
S3735-124	3/4	1/4
S3735-126	3/4	3/8
S3735-128	3/4	1/2
S3735-1210	3/4	5/8
S3735-1216	3/4	1
S3735-164	1	1/4
S3735-166	1	3/8
S3735-168	1	1/2
S3735-1610	1	5/8
S3735-1612	1	3/4
S3735-1620	1	1-1/4
S3735-2012	1-1/4	3/4
S3735-2016	1-1/4	1
S3735-2024	1-1/4	1-1/2
S3735-2416	1-1/2	1
S3735-2420	1-1/2	1-1/4
S3735-3220	2	1-1/4
S3735-3224	2	1-1/2



UNION Male JIC To Male JIC

PART No.	Tube	Tube
S3742-4	1/4	1/4
S3742-43	1/4	3/16
S3742-5	5/16	5/16
S3742-6	3/8	3/8
S3742-64	3/8	1/4
S3742-65	3/8	5/16
S3742-8	1/2	1/2
S3742-84	1/2	1/4
S3742-86	1/2	3/8
S3742-10	5/8	5/8
S3742-106	5/8	3/8
S3742-108	5/8	1/2
S3742-12	3/4	3/4
S3742-126	3/4	3/8
S3742-128	3/4	1/2
S3742-1210	3/4	5/8
S3742-16	1	1
S3742-1612	1	3/4
S3742-20	1-1/4	1-1/4
S3742-2016	1-1/4	1
S3742-24	1-1/2	1-1/2
S3742-32	2	2



UNION Male JIC To Male JIC (LARGE HEX)

PART No.	Tube
S3742H-6	3/8

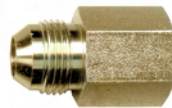

CONNECTOR Male JIC To Female Pipe

PART No.	Tube	Pipe
S3746-4A	1/4	1/8
S3746-4B	1/4	1/4
S3746-6B	3/8	1/4
S3746-6C	3/8	3/8
S3746-6D	3/8	1/2
S3746-8B	1/2	1/4
S3746-8C	1/2	3/8
S3746-8D	1/2	1/2
S3746-10D	5/8	1/2
S3746-10E	5/8	3/4
S3746-12D	3/4	1/2
S3746-12E	3/4	3/4
S3746-12H	3/4	1
S3746-16E	1	3/4
S3746-16H	1	1
S3746-20J	1-1/4	1-1/4
S3746-24K	1-1/2	1-1/2
S3746-32M	2	2



CONNECTOR Male JIC To Male Pipe

PART No.	Tube	Pipe
S3748-2A	1/8	1/8
S3748-3A	3/16	1/8
S3748-4A	1/4	1/8
S3748-4B	1/4	1/4
S3748-4C	1/4	3/8
S3748-4D	1/4	1/2
S3748-5A	5/16	1/8
S3748-5B	5/16	1/4
S3748-5C	5/16	3/8
S3748-6A	3/8	1/8
S3748-6B	3/8	1/4
S3748-6C	3/8	3/8
S3748-6D	3/8	1/2
S3748-6E	3/8	3/4
S3748-8B	1/2	1/4
S3748-8C	1/2	3/8
S3748-8D	1/2	1/2
S3748-8E	1/2	3/4
S3748-8H	1/2	1
S3748-10C	5/8	3/8
S3748-10D	5/8	1/2
S3748-10E	5/8	3/4
S3748-10H	5/8	1
S3748-12C	3/4	3/8
S3748-12D	3/4	1/2
S3748-12E	3/4	3/4
S3748-12H	3/4	1
S3748-16D	1	1/2
S3748-16E	1	3/4
S3748-16H	1	1
S3748-16J	1	1-1/4
S3748-16K	1	1-1/2
S3748-20H	1-1/4	1
S3748-20J	1-1/4	1-1/4
S3748-20K	1-1/4	1-1/2
S3748-24J	1-1/2	1-1/4
S3748-24K	1-1/2	1-1/2
S3748-32K	2	1-1/2
S3748-32M	2	2



CONNECTOR 37° Tube to British Standard Pipe Parallel Male

PART No.	Tube	BSPP
S3748BSPP-44	1/4	1/4
S3748BSPP-64	3/8	1/4
S3748BSPP-66	3/8	3/8
S3748BSPP-88	1/2	1/2

STEEL 37° J.I.C. FLARE ADAPTERS

A



Male JIC PLUG

PART No.	Tube
S3758-3	3/16
S3758-4	1/4
S3758-5	5/16
S3758-6	3/8
S3758-8	1/2
S3758-10	5/8
S3758-12	3/4
S3758-14	7/8
S3758-16	1
S3758-20	1-1/4
S3758-24	1-1/2
S3758-32	2



CAP NUT

PART No.	Tube
S3756-3	3/16
S3756-4	1/4
S3756-5	5/16
S3756-6	3/8
S3756-8	1/2
S3756-10	5/8
S3756-12	3/4
S3756-14	7/8
S3756-16	1
S3756-20	1-1/4
S3756-24	1-1/2
S3756-32	2



**90° ELBOW
Male JIC To
Male Pipe**

PART No.	Tube	Pipe
S3749-2A	1/8	1/8
S3749-4A	1/4	1/8
S3749-4B	1/4	1/4
S3749-4C	1/4	3/8
S3749-4D	1/4	1/2
S3749-5B	5/16	1/4
S3749-5C	5/16	3/8
S3749-6A	3/8	1/8
S3749-6B	3/8	1/4
S3749-6C	3/8	3/8
S3749-6D	3/8	1/2
S3749-6E	3/8	3/4
S3749-8B	1/2	1/4
S3749-8C	1/2	3/8
S3749-8D	1/2	1/2
S3749-8E	1/2	3/4
S3749-8H	1/2	1
S3749-10C	5/8	3/8
S3749-10D	5/8	1/2
S3749-10E	5/8	3/4
S3749-12D	3/4	1/2
S3749-12E	3/4	3/4
S3749-12H	3/4	1
S3749-12J	3/4	1-1/4
S3749-16E	1	3/4
S3749-16H	1	1
S3749-16J	1	1-1/4
S3749-20H	1-1/4	1
S3749-20J	1-1/4	1-1/4
S3749-20K	1-1/4	1-1/2
S3749-24J	1-1/2	1-1/4
S3749-24K	1-1/2	1-1/2
S3749-32M	2	2



**90° ELBOW
(LONG STYLE)
Male JIC To
Male Pipe**

PART No.	Tube	Pipe
S3749L-4A	1/4	1/8
S3749L-4B	1/4	1/4
S3749L-6B	3/8	1/4
S3749L-8D	1/2	1/2



**90° ELBOW
(EXTRA LONG
STYLE)
Male JIC To
Male Pipe**

PART No.	Tube	Pipe
S3749EL-4A	1/4	1/8
S3749EL-4B	1/4	1/4
S3749EL-8D	1/2	1/2



**90° ELBOW
(EXTRA-EXTRA
LONG STYLE)
Male JIC To
Male Pipe**

PART No.	Tube	Pipe
S3749EEL-4A	1/4	1/8
S3749EEL-4B	1/4	1/4



**90° ELBOW
37° Tube to
British Standard
Pipe Parallel
Male**

PART No.	Tube	BSP
S3749BSPP-42	1/4	1/8



**90° ELBOW
Male JIC To
Female Pipe**

PART No.	Tube	Pipe
S3750-4A	1/4	1/8
S3750-4B	1/4	1/4
S3750-6A	3/8	1/8
S3750-6B	3/8	1/4
S3750-6C	3/8	3/8
S3750-6D	3/8	1/2
S3750-8C	1/2	3/8
S3750-8D	1/2	1/2
S3750-10D	5/8	1/2
S3750-12D	3/4	1/2
S3750-12E	3/4	3/4
S3750-16H	1	1



**90° ELBOW
Male JIC To Male
JIC**

PART No.	Tube	Tube
S3755-4	1/4	1/4
S3755-6	3/8	3/8
S3755-8	1/2	1/2
S3755-10	5/8	5/8
S3755-12	3/4	3/4
S3755-12B	3/4	1/2
S3755-16	1	1
S3755-1612	1	3/4
S3755-20	1-1/4	1-1/4



**45° ELBOW
Male JIC To
Male Pipe**

PART No.	Tube	Pipe
S3754-4A	1/4	1/8
S3754-4B	1/4	1/4
S3754-6B	3/8	1/4
S3754-6C	3/8	3/8
S3754-6D	3/8	1/2
S3754-8C	1/2	3/8
S3754-8D	1/2	1/2
S3754-8E	1/2	3/4
S3754-10C	5/8	3/8
S3754-10D	5/8	1/2
S3754-10E	5/8	3/4
S3754-12D	3/4	1/2
S3754-12E	3/4	3/4
S3754-12H	3/4	1
S3754-16E	1	3/4
S3754-16H	1	1
S3754-20J	1-1/4	1-1/4
S3754-24K	1-1/2	1-1/2

STEEL 37° J.I.C. FLARE ADAPTERS

A

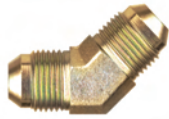

**45° ELBOW
Male JIC To
Male JIC**

PART No.	Tube	Tube
S3705-6	3/8	3/8
S3705-8	1/2	1/2



**TEE
Male JIC
All Ends**

PART No.	Tube	Tube
S3744-4	1/4	1/4
S3744-6	3/8	3/8
S3744-8	1/2	1/2
S3744-10	5/8	5/8
S3744-12	3/4	3/4
S3744-16	1	1
S3744-20	1-1/4	1-1/4



**TEE
Male JIC To
Male Pipe To
Tube**

PART No.	Tube	Pipe
S3751-4A	1/4	1/8
S3751-4B	1/4	1/4
S3751-6B	3/8	1/4
S3751-6C	3/8	3/8
S3751-6D	3/8	1/2
S3751-8C	1/2	3/8
S3751-8D	1/2	1/2
S3751-12E	3/4	3/4
S3751-16H	1	1



**TEE
Male JIC To
Male JIC To
Female Pipe**

PART No.	Tube	Pipe
S3736-6B	3/8	1/4
S3736-8C	1/2	3/8
S3736-8D	1/2	1/2
S3736-12E	3/4	3/4



**TEE
Male JIC To
Male JIC To
Male Pipe**

PART No.	Tube	Pipe
S3745-4B	1/4	1/4
S3745-6B	3/8	1/4
S3745-6C	3/8	3/8
S3745-8C	1/2	3/8
S3745-8D	1/2	1/2
S3745-12E	3/4	3/4
S3745-16H	1	1



**CROSS
Male JIC
All Ends**

PART No.	Tube
S3752-6	3/8
S3752-8	1/2

STEEL 37° S.A.E. FLARE BULKHEAD ADAPTERS

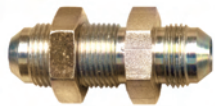

**BULKHEAD
UNION
Male JIC To
Male JIC**

PART No.	Tube
S3842-4	1/4
S3842-6	3/8
S3842-8	1/2
S3842-10	5/8
S3842-12	3/4
S3842-16	1
S3842-20	1-1/4



**BULKHEAD
CONNECTOR
Tube To
Female Pipe**

PART No.	Tube	Pipe
S3846-4A	1/4	1/8
S3846-4B	1/4	1/4
S3846-6C	3/8	3/8
S3846-8D	1/2	1/2
S3846-12E	3/4	3/4
S3846-16H	1	1



**BULKHEAD
TEE
Tube All Ends**

PART No.	Tube
S3845-4	1/4
S3845-6	3/8
S3845-8	1/2
S3845-12	3/4



**BULKHEAD
CONNECTOR
Tube To Pipe**

PART No.	Tube	Pipe
S3848-4A	1/4	1/8
S3848-4B	1/4	1/4
S3848-6B	3/8	1/4
S3848-6C	3/8	3/8
S3848-8D	1/2	1/2
S3848-10D	5/8	1/2
S3848-12E	3/4	3/4
S3848-16H	1	1
S3848-20J	1-1/4	1-1/4



**45° BULKHEAD
ELBOW
Tube To Tube**

PART No.	Tube
S3854-6	3/8
S3854-8	1/2
S3854-12	3/4
S3854-16	1



**BULKHEAD
TEE
Tube All Ends**

PART No.	Tube
S3851-4	1/4

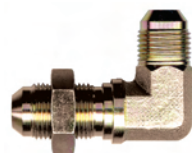

**90° BULKHEAD
ELBOW
Tube To Tube**

PART No.	Tube
S3855-4	1/4
S3855-6	3/8
S3855-8	1/2
S3855-12	3/4
S3855-16	1



**BULKHEAD
LOCKNUT**

PART No.	Tube
S3831N-4	1/4
S3831N-6	3/8
S3831N-8	1/2
S3831N-12	3/4
S3831N-16	1

NOTE:
BULKHEADS COME COMPLETE
WITH LOCKNUTS

FLANGE ADAPTERS AND KITS

(CODE 61 MAXIMUM WORKING PRESSURE 3000 PSI)
(CODE 62 MAXIMUM WORKING PRESSURE 6000 PSI)



A



SPLIT FLANGE ADAPTER
Male JIC To
Code 61 Flange

PART No.	Tube	Split Flange
S3700BT-1212	3/4	3/4
S3700BT-1216	3/4	1
S3700BT-1616	1	1



90° ELBOW SPLIT FLANGE
Male JIC To
Code 61 Flange

PART No.	Tube	Split Flange
S3790BT-1212	3/4	3/4
S3790BT-1616	1	1
S3790BT-1620	1	1-1/4
S3790BT-2020	1-1/4	1-1/4
S3790BT-2424	1-1/2	1-1/2
S3790BT-2432	1-1/2	2



45° ELBOW SPLIT FLANGE
Male JIC To
Code 61 Flange

PART No.	Tube	Split Flange
S3740BT-812	1/2	3/4
S3740BT-1212	3/4	3/4
S3740BT-1616	1	1



HALVES KIT
Code 61 Split Flange

** Includes Bolts, Lock Washers and O-Ring.

PART No.	Flange Size	Head Size
SFK61-12	3/4	1.50
SFK61-16	1	1.75
SFK61-20	1-1/4	2.00
SFK61-24	1-1/2	2.38
SFK61-32	2	2.81
SFK61-40	2-1/2	3.31

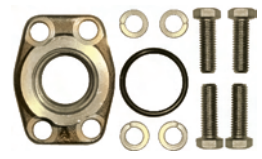

FLANGE PAD KIT
Code 61 Female Pipe

** Includes Bolts, Lock Washers and O-Ring.

PART No.	Pipe	Pad Size
SFPK2661-12E	3/4	3/4
SFPK2661-16H	1	1
SFPK2661-20J	1-1/4	1-1/4
SFPK2661-24K	1-1/2	1-1/2
SFPK2661-32M	2	2

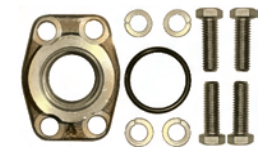

FLANGE PAD KIT
Code 61 Female O-Ring

** Includes Bolts, Lock Washers and O-Ring.

PART No.	O-Ring	Pad Size
SFPK3461-1616	1-5/16 - 12	1
SFPK3461-2020	1-5/8-12	1-1/4



SPLIT FLANGE ADAPTER
Male JIC To
Code 62 Flange

PART No.	Tube	Split Flange
S3700BT62-1212	3/4	3/4
S3700BT62-1616	1	1
S3700BT62-1620	1	1-1/4
S3700BT62-2020	1-1/4	1-1/4



90° ELBOW SPLIT FLANGE
Male JIC To
Code 62 Flange

PART No.	Tube	Split Flange
S3790BT62-1216	3/4	1
S3790BT62-1616	1	1
S3790BT62-1620	1	1-1/4
S3790BT62-2020	1-1/4	1-1/4
S3790BT62-2024	1-1/4	1-1/2



BUNA-N SPLIT FLANGE O-Ring

PART No.	Flange Size	Dia.
SFO-12	3/4	.984
SFO-16	1	1.296
SFO-24	1-1/2	1.859
SFO-32	2	2.234



HALVES KIT
Code 62 Split Flange

** Includes Bolts, Lock Washers and O-Ring.

PART No.	Flange Size	Head Size
SFK62-12	3/4	1.63
SFK62-16	1	1.88
SFK62-20	1-1/4	2.12
SFK62-24	1-1/2	2.50
SFK62-32	2	3.13



FLANGE PAD KIT
Code 62 Female Pipe

** Includes Bolts, Lock Washers and O-Ring.

PART No.	Pipe	Pad Size
SFPK2662-12E	3/4	3/4
SFPK2662-16H	1	1
SFPK2662-20J	1-1/4	1-1/4

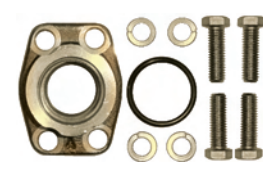

FLANGE PAD KIT
Code 62 Female O-Ring

** Includes Bolts, Lock Washers and O-Ring.

PART No.	O-Ring	Pad Size
SFPK3462-1212	1-1/16 - 12	3/4
SFPK3462-1616	1-5/16 - 12	1
SFPK3462-2020	1-5/8-12	1-1/4

STEEL S.A.E. O-RING BOSS ADAPTERS

(BUNA-N O-RING STANDARD)

A



**CONNECTOR
Male O-Ring To
Female Pipe**

PART No.	O-Ring	Pipe
S3620-4A	7/16 - 20	1/8
S3620-4B	7/16 - 20	1/4
S3620-5A	1/2 - 20	1/8
S3620-5B	1/2 - 20	1/4
S3620-6A	9/16 - 18	1/8
S3620-6B	9/16 - 18	1/4
S3620-6C	9/16 - 18	3/8
S3620-6D	9/16 - 18	1/2
S3620-8C	3/4 - 16	3/8
S3620-8D	3/4 - 16	1/2
S3620-10C	7/8 - 14	3/8
S3620-10D	7/8 - 14	1/2
S3620-10E	7/8 - 14	3/4
S3620-12D	1-1/16 - 12	1/2
S3620-12E	1-1/16 - 12	3/4
S3620-16D	1-5/16 - 12	1/2
S3620-16E	1-5/16 - 12	3/4
S3620-16H	1-5/16 - 12	1
S3620-20H	1-5/8 - 12	1
S3620-20J	1-5/8 - 12	1-1/4
S3620-24K	1-7/8 - 12	1-1/2

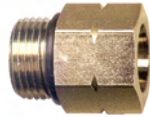

**CONNECTOR
MALE O-RING
TO FEMALE
O-RING**

PART No.	Male	Female
S3623-4	7/16 - 20	7/16 - 20
S3623-6	9/16 - 18	9/16 - 18
S3623-64	9/16 - 18	7/16 - 20
S3623-68	9/16 - 18	3/4 - 16
S3623-8	3/4 - 16	3/4 - 16
S3623-86	3/4 - 16	9/16 - 18
S3623-810	3/4 - 16	7/8 - 14
S3623-106	7/8 - 14	9/16 - 18
S3623-108	7/8 - 14	3/4 - 16
S3623-1012	7/8 - 14	1-1/16 - 12
S3623-128	1-1/16 - 12	3/4 - 16
S3623-1210	1-1/16 - 12	7/8 - 14
S3623-1216	1-1/16 - 12	1-5/16 - 12
S3623-1612	1-5/16 - 12	1-1/16 - 12
S3623-2012	1-5/8 - 12	1-1/16 - 12
S3623-2016	1-5/8 - 12	1-5/16 - 12
S3623-2416	1-7/8 - 12	1-5/16 - 12
S3623-2420	1-7/8 - 12	1-5/8 - 12

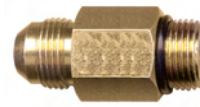

**CONNECTOR
(LONG STYLE)
Tube To
Male O-Ring**

PART No.	Tube	O-Ring
S3648L-6	3/8	9/16 - 18
S3648L-8	1/2	3/4 - 16
S3648L-12	3/4	1-1/16 - 12



**UNION
Male O-Ring To
Male O-Ring**

PART No.	O-Ring
S3642-6	9/16 - 18
S3642-8	3/4 - 16
S3642-12	1-1/16 - 12
S3642-16	1-5/16 - 12
S3642-20	1-5/8 - 12



**CONNECTOR
Male O-Ring To
Male Pipe**

PART No.	O-Ring	Pipe
S3622-4B	7/16 - 20	1/4
S3622-6A	9/16 - 18	1/8
S3622-6B	9/16 - 18	1/4
S3622-6C	9/16 - 18	3/8
S3622-6D	9/16 - 18	1/2
S3622-8B	3/4 - 16	1/4
S3622-8C	3/4 - 16	3/8
S3622-8D	3/4 - 16	1/2
S3622-10C	7/8 - 14	3/8
S3622-10D	7/8 - 14	1/2
S3622-10E	7/8 - 14	3/4
S3622-12D	1-1/16 - 12	1/2
S3622-12E	1-1/16 - 12	3/4
S3622-12H	1-1/16 - 12	1
S3622-16H	1-5/16 - 12	1
S3622-20J	1-5/8 - 12	1-1/4



**CONNECTOR
Tube To
Male O-Ring**

PART No.	Tube	O-Ring
S3648-4	1/4	7/16 - 20
S3648-42	1/4	5/16 - 24
S3648-43	1/4	3/8 - 24
S3648-45	1/4	1/2 - 20
S3648-46	1/4	9/16 - 18
S3648-48	1/4	3/4 - 16
S3648-5	5/16	1/2 - 20
S3648-56	5/16	9/16 - 18
S3648-6	3/8	9/16 - 18
S3648-64	3/8	7/16 - 20
S3648-65	3/8	1/2 - 20
S3648-68	3/8	3/4 - 16
S3648-610	3/8	7/8 - 14
S3648-612	3/8	1-1/16 - 12
S3648-8	1/2	3/4 - 16
S3648-84	1/2	7/16 - 20
S3648-85	1/2	1/2 - 20
S3648-86	1/2	9/16 - 18
S3648-810	1/2	7/8 - 14
S3648-812	1/2	1-1/16 - 12
S3648-816	1/2	1-5/16 - 12
S3648-10	5/8	7/8 - 14
S3648-108	5/8	3/4 - 16
S3648-1012	5/8	1-1/16 - 12
S3648-12	3/4	1-1/16 - 12
S3648-128	3/4	3/4 - 16
S3648-1210	3/4	7/8 - 14
S3648-1216	3/4	1-5/16 - 12
S3648-1220	3/4	1-5/8 - 12
S3648-16	1	1-5/16 - 12
S3648-1610	1	7/8 - 14
S3648-1612	1	1-1/16 - 12
S3648-1620	1	1-5/8 - 12
S3648-1624	1	1-7/8 - 12
S3648-20	1-1/4	1-5/8 - 12
S3648-2012	1-1/4	1-1/16 - 12
S3648-2016	1-1/4	1-5/16 - 12
S3648-2024	1-1/4	1-7/8 - 12
S3648-24	1-1/2	1-7/8 - 12
S3648-2420	1-1/4	1-5/8 - 12
S3648-32	2	2-1/2 - 12



**PLUG
Counter Sunk
Hex**

PART No.	O-Ring
S3618-2	5/16 - 24
S3618-4	7/16 - 20
S3618-5	1/2 - 20
S3618-6	9/16 - 18
S3618-8	3/4 - 16
S3618-10	7/8 - 14
S3618-12	1-1/16 - 12
S3618-16	1-5/16 - 12

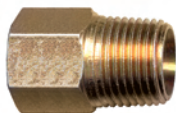

**CONNECTOR
Female O-Ring
To Male Pipe**

PART No.	O-Ring	Pipe
S3622F-4B	7/16 - 20	1/4
S3622F-6B	9/16 - 18	1/4
S3622F-6C	9/16 - 18	3/8
S3622F-6D	9/16 - 18	1/2
S3622F-8D	3/4 - 16	1/2
S3622F-10D	7/8 - 14	1/2
S3622F-12E	1-1/16 - 12	3/4
S3622F-16H	1-5/16 - 12	1



**PLUG
Hex
Head**

PART No.	O-Ring
S3621-4	7/16 - 20
S3621-5	1/2 - 20
S3621-6	9/16 - 18
S3621-8	3/4 - 16
S3621-10	7/8 - 14
S3621-12	1-1/16 - 12
S3621-14	1-3/16 - 12
S3621-16	1-5/16 - 12
S3621-20	1-5/8 - 12
S3621-24	1-7/8 - 12
S3621-32	2-1/2 - 12

STEEL S.A.E. O-RING BOSS ADAPTERS

(BUNA-N O-RING STANDARD)



A



**90° ELBOW
Male O-Ring To
Female Pipe**

PART No.	O-Ring	Pipe
S3616-6B	9/16 - 18	1/4
S3616-8C	3/4 - 16	3/8
S3616-8D	3/4 - 16	1/2
S3616-10D	7/8 - 14	1/2
S3616-12E	1-1/16 - 12	3/4
S3616-16H	1-5/16 - 12	1
S3616-20J	1-5/8 - 12	1-1/4



**90° ELBOW
Tube To
Male O-Ring**

PART No.	Tube	O-Ring
S3649-4	1/4	7/16 - 20
S3649-45	1/4	1/2 - 20
S3649-46	1/4	9/16 - 18
S3649-48	1/4	3/4 - 16
S3649-5	5/16	1/2 - 20
S3649-6	3/8	9/16 - 18
S3649-64	3/8	7/16 - 20
S3649-65	3/8	1/2 - 20
S3649-68	3/8	3/4 - 16
S3649-610	3/8	7/8 - 14
S3649-612	3/8	1-1/16 - 12
S3649-8	1/2	3/4 - 16
S3649-86	1/2	9/16 - 18
S3649-810	1/2	7/8 - 14
S3649-812	1/2	1-1/16 - 12
S3649-10	5/8	7/8 - 14
S3649-108	5/8	3/4 - 16
S3649-1012	5/8	1-1/16 - 12
S3649-12	3/4	1-1/16 - 12
S3649-126	3/4	9/16 - 18
S3649-128	3/4	3/4 - 16
S3649-1210	3/4	7/8 - 14
S3649-1216	3/4	1-5/16 - 12
S3649-1220	3/4	1-5/8 - 12
S3649-16	1	1-5/16 - 12
S3649-1612	1	1-1/16 - 12
S3649-1620	1	1-5/8 - 12
S3649-20	1-1/4	1-5/8 - 12
S3649-2016	1-1/4	1-5/16 - 12
S3649-2024	1-1/4	1-7/8 - 12
S3649-24	1-1/2	1-7/8 - 12
S3649-32	2	2-1/2 - 12



**90° ELBOW
(EXTRA LONG
STYLE)
Tube To
Male O-Ring**

PART No.	Tube	O-Ring
S3649EL-6	3/8	9/16 - 18
S3649EL-8	1/2	3/4 - 16
S3649EL-12	3/4	1-1/16 - 12



**90° ELBOW
Male O-Ring To
Male O-Ring**

PART No.	O-Ring
S3655-6	9/16 - 18
S3655-8	3/4 - 16



**90° ELBOW
Male O-Ring To
Male Pipe**

PART No.	O-Ring	Pipe
S3699-6B	9/16 - 18	1/4
S3699-8C	3/4 - 16	3/8
S3699-8D	3/4 - 16	1/2
S3699-10D	7/8 - 14	1/2
S3699-12E	1-1/16 - 12	3/4
S3699-16H	1-5/16 - 12	1



**45° ELBOW
Tube To
Male O-Ring**

PART No.	Tube	O-Ring
S3654-4	1/4	7/16 - 20
S3654-46	1/4	9/16 - 18
S3654-6	3/8	9/16 - 18
S3654-68	3/8	3/4 - 16
S3654-8	1/2	3/4 - 16
S3654-86	1/2	9/16 - 18
S3654-810	1/2	7/8 - 14
S3654-10	5/8	7/8 - 14
S3654-108	5/8	3/4 - 16
S3654-1012	5/8	1-1/16 - 12
S3654-12	3/4	1-1/16 - 12
S3654-1210	3/4	7/8 - 14
S3654-1216	3/4	1-5/16 - 12
S3654-16	1	1-5/16 - 12
S3654-1612	1	1-1/16 - 12
S3654-1620	1	1-5/8 - 12
S3654-20	1-1/4	1-5/8 - 12
S3654-24	1-1/2	1-7/8 - 12



**TEE
Tube To Tube To
Male O-Ring**

PART No.	Tube	O-Ring
S3645-4	1/4	7/16 - 20
S3645-6	3/8	9/16 - 18
S3645-8	1/2	3/4 - 16
S3645-810	1/2	7/8 - 14
S3645-10	5/8	7/8 - 14
S3645-108	5/8	3/4 - 16
S3645-12	3/4	1-1/16 - 12
S3645-16	1	1-5/16 - 12
S3645-20	1-1/4	1-5/8 - 12



**TEE
Tube To
Male O-Ring To
Tube**

PART No.	Tube	O-Ring
S3651-4	1/4	7/16 - 20
S3651-6	3/8	9/16 - 18
S3651-8	1/2	3/4 - 16
S3651-810	1/2	7/8 - 14
S3651-10	5/8	7/8 - 14
S3651-12	3/4	1-1/16 - 12
S3651-16	1	1-5/16 - 12
S3651-20	1-1/4	1-5/8 - 12



**BUNA-N
O-RING**

PART No.	O-Ring	Dia.
S3631R-2	1/8	.239
S3631R-3	3/16	.301
S3631R-4	1/4	.351
S3631R-5	5/16	.414
S3631R-6	3/8	.468
S3631R-8	1/2	.644
S3631R-10	5/8	.755
S3631R-12	3/4	.924
S3631R-14	7/8	1.048
S3631R-16	1	1.171
S3631R-20	1-1/4	1.475
S3631R-24	1-1/2	1.720
S3631R-32	2	2.337

STEEL O-RING FACE SEAL ADAPTERS

(BUNA-N O-RING STANDARD)

A



CONNECTOR
Female O-Ring
Face Seal To
Male O-Ring
Face Seal

PART No.	Female ORFS	Male ORFS
S3935-86	13/16 - 16	11/16 - 16
S3935-1012	1 - 14	1-3/16 - 12
S3935-126	1-3/16 - 12	11/16 - 16
S3935-128	1-3/16 - 12	13/16 - 16
S3935-1210	1-3/16 - 12	1 - 14
S3935-1612	1-7/16 - 12	1-3/16 - 12

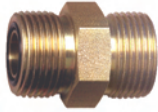

UNION
O-Ring Face
Seal

PART No.	ORFS	ORFS
S3942-6	1-1/16 - 16	
S3942-64	1-1/16 - 16	9/16 - 18
S3942-8	13/16 - 16	
S3942-86	1-1/16 - 16	11/16 - 16
S3942-10	1 - 14	
S3942-12	1-3/16 - 12	
S3942-1210	1-3/16 - 12	1 - 14
S3942-16	1-7/16 - 12	

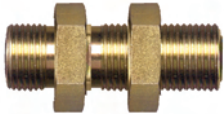

BULKHEAD
UNION O-Ring
Face Seal

PART No.	ORFS
S3942BH-4	9/16 - 18
S3942BH-6	11/16 - 16



CONNECTOR
O-Ring Face Seal
To Male Pipe

PART No.	ORFS	Pipe
S3948-4A	9/16 - 18	1/8
S3948-6B	11/16 - 16	1/4
S3948-6C	11/16 - 16	3/8
S3948-8D	13/16 - 16	1/2
S3948-10D	1 - 14	1/2
S3948-12E	1-3/16 - 12	3/4
S3948-16H	1-7/16 - 12	1



CONNECTOR
O-Ring Face Seal
To Male
O-Ring Boss

PART No.	ORFS	O-Ring
S3968-4	9/16 - 18	7/16 - 20
S3968-46	9/16 - 18	9/16 - 18
S3968-6	11/16 - 16	9/16 - 18
S3968-68	11/16 - 16	3/4 - 16
S3968-610	11/16 - 16	7/8 - 14
S3968-612	11/16 - 16	1-1/16 - 12
S3968-8	13/16 - 16	3/4 - 16
S3968-86	13/16 - 16	9/16 - 18
S3968-810	13/16 - 16	7/8 - 14
S3968-10	1 - 14	7/8 - 14
S3968-108	1 - 14	3/4 - 16
S3968-1012	1 - 14	1-1/16 - 12
S3968-12	1-3/16 - 12	1-1/16 - 12
S3968-1210	1-3/16 - 12	7/8 - 14
S3968-1216	1-3/16 - 12	1-5/16 - 12
S3968-16	1-7/16 - 12	1-5/16 - 12
S3968-1612	1-7/16 - 12	1-1/16 - 12
S3968-20	1-11/16 - 12	1-5/8 - 12
S3968-2016	1-11/16 - 12	1-5/16 - 12

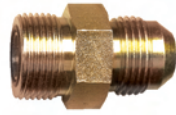

CONNECTOR
O-Ring Face
Seal To
Male JIC

PART No.	ORFS	Tube
S3937-4	9/16 - 18	1/4
S3937-6	11/16 - 16	3/8
S3937-8	13/16 - 16	1/2
S3937-10	1 - 14	5/8
S3937-12	1-3/16 - 12	3/4
S3937-16	1-7/16 - 12	1

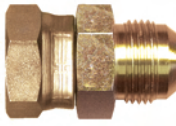

CONNECTOR
Female
O-Ring Face
Seal To
Male JIC

PART No.	Female ORFS	Tube
S3937F-4	9/16 - 18	1/4
S3937F-6	11/16 - 16	3/8
S3937F-8	13/16 - 16	1/2
S3937F-10	1 - 14	5/8
S3937F-12	1-3/16 - 12	3/4
S3937F-16	1-7/16 - 12	1



PLUG
O-Ring Face
Seal

PART No.	ORFS
S3958-4	9/16 - 18
S3958-6	11/16 - 16
S3958-8	13/16 - 16
S3958-10	1 - 14
S3958-12	1-3/16 - 12
S3958-16	1-7/16 - 12
S3958-20	1-11/16 - 12
S3958-24	2 - 12



CAP
O-Ring Face
Seal

PART No.	ORFS
S3956-4	9/16 - 18
S3956-6	11/16 - 16
S3956-8	13/16 - 16
S3956-10	1 - 14
S3956-12	1-3/16 - 12
S3956-16	1-7/16 - 12
S3956-20	1-11/16 - 12



BUNA-N
O-RING
Face Seal

PART No.	ORFS	DIA.
S3931R-4	9/16 - 18	.301
S3931R-6	11/16 - 16	.364
S3931R-8	13/16 - 16	.489
S3931R-10	1 - 14	.614
S3931R-12	1-3/16 - 12	.739
S3931R-16	1-7/16 - 12	.926
S3931R-20	1-11/16 - 12	1.176



LOCK NUT

PART No.	ORFS
S3931N-4	9/16 - 18
S3931N-6	11/16 - 16
S3931N-8	13/16 - 16
S3931N-10	1 - 14
S3931N-12	1-3/16 - 12
S3931N-16	1-7/16 - 12



90° ELBOW
Male O-Ring
Face Seal To
Female O-Ring
Face Seal

PART No.	Male ORFS	Female ORFS
S3947-4	9/16 - 18	9/16 - 18
S3947-6	11/16 - 16	11/16 - 16
S3947-8	13/16 - 16	13/16 - 16
S3947-10	1 - 14	1 - 14
S3947-12	1-3/16 - 12	1-3/16 - 12
S3947-16	1-7/16 - 12	1-7/16 - 12
S3947-20	1-11/16 - 12	1-11/16 - 12



90° ELBOW
O-Ring Face
Seal To
O-Ring Face
Seal

PART No.	ORFS
S3955-4	9/16 - 18
S3955-6	11/16 - 16
S3955-8	13/16 - 16
S3955-12	1-3/16 - 12



90° ELBOW
Male O-Ring Face
Seal To Male
O-Ring Boss

PART No.	Male ORFS	Male O-Ring
S3969-4	9/16 - 18	7/16 - 20
S3969-46	9/16 - 18	9/16 - 18
S3969-6	11/16 - 16	9/16 - 18
S3969-610	11/16 - 16	7/8 - 14
S3969-8	13/16 - 16	3/4 - 16
S3969-86	13/16 - 16	9/16 - 18
S3969-810	13/16 - 16	7/8 - 14
S3969-812	13/16 - 16	1-1/16 - 12
S3969-10	1 - 14	7/8 - 14
S3969-108	1 - 14	3/4 - 16
S3969-12	1-3/16 - 12	1-1/16 - 12
S3969-1210	1-3/16 - 12	7/8 - 14
S3969-1216	1-3/16 - 12	1-5/16 - 12
S3969-16	1-7/16 - 12	1-5/16 - 12
S3969-20	1-11/16 - 12	1-5/8 - 12
S3969-2016	1-11/16 - 12	1-5/16 - 12

STEEL O-RING FACE SEAL ADAPTERS

(BUNA-N O-RING STANDARD)



A



90° ELBOW
Female O-Ring
Face Seal To
O-Ring Boss

PART No.	Female ORFS	O-Ring
S3969F-4	9/16 - 18	7/16 - 20
S3969F-6	11/16 - 16	9/16 - 18

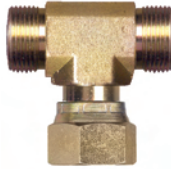

TEE
Male O-Ring
Face Seal To
Female O-Ring
Face Seal

PART No.	Male ORFS	Female ORFS
S3945F-6	11/16 - 16	11/16 - 16
S3945F-8	13/16 - 16	13/16 - 16

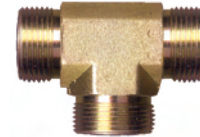

TEE
O-Ring Face
Seal All Ends

PART No.	ORFS
S3944-6	11/16 - 16
S3944-8	13/16 - 16
S3944-10	1 - 14
S3944-12	1-3/16 - 12

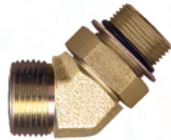

45° ELBOW
O-Ring Face
Seal To Male
O-Ring Boss

PART No.	ORFS	O-Ring
S3974-4	9 - 16	7/16 - 20
S3974-6	11/16 - 16	9/16 - 18
S3974-8	13/16 - 16	3/4 - 16
S3974-10	1 - 14	7/8 - 14
S3974-12	1-3/16 - 12	1-1/16 - 12
S3974-1216	1-3/16 - 12	1-5/16 - 12



TEE
O-Ring Face
Seal To
O-Ring Boss To
O-Ring Face
Seal

PART No.	ORFS	O-Ring
S3971-4	9 - 16	7/16 - 20
S3971-6	11/16 - 16	9/16 - 18
S3971-8	13/16 - 16	3/4 - 16
S3971-12	1-3/16 - 12	1-1/16 - 12

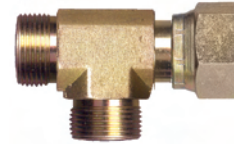

TEE
Male To Female
To Male O-Ring
Face Seal

PART No.	Male ORFS	Female ORFS
S3951F-4	9/16 - 18	9/16 - 18
S3951F-6	11/16 - 16	11/16 - 16
S3951F-8	13/16 - 16	13/16 - 16
S3951F-10	1 - 14	1 - 14
S3951F-12	1-3/16 - 12	1-3/16 - 12
S3951F-16	1-7/16 - 12	1-7/16 - 12

STEEL FLARELESS ADAPTERS

TUBE SLEEVE

PART No.	Tube
S6760-4	1/4
S6760-6	3/8
S6760-8	1/2
S6760-10	5/8
S6760-12	3/4
S6760-16	1



TUBE NUT

PART No.	Tube
S6761-4	1/4
S6761-6	3/8
S6761-8	1/2
S6761-10	5/8
S6761-12	3/4
S6761-16	1



UNION Tube To Tube

PART No.	Tube
S6762-3	3/16
S6762-4	1/4
S6762-6	3/8
S6762-8	1/2
S6762-10	5/8
S6762-12	3/4
S6762-16	1

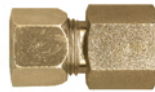

CONNECTOR Tube To Female Pipe

PART No.	Tube	Pipe
S6766-4A	1/4	1/8
S6766-4B	1/4	1/4
S6766-6B	3/8	1/4
S6766-6C	3/8	3/8
S6766-8C	1/2	3/8
S6766-10D	5/8	1/2
S6766-12E	3/4	3/4
S6766-16H	1	1



CONNECTOR Tube To Male Pipe

PART No.	Tube	Pipe
S6768-2A	1/8	1/8
S6768-4A	1/4	1/8
S6768-4B	1/4	1/4
S6768-6B	3/8	1/4
S6768-6C	3/8	3/8
S6768-6D	3/8	1/2
S6768-8C	1/2	3/8
S6768-8D	1/2	1/2
S6768-10C	5/8	3/8
S6768-10D	5/8	1/2
S6768-12D	3/4	1/2
S6768-12E	3/4	3/4
S6768-16H	1	1

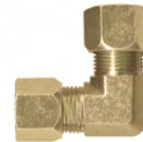

90° ELBOW Tube To Tube

PART No.	Tube
S6765-4	1/4
S6765-6	3/8
S6765-8	1/2
S6765-12	3/4



90° ELBOW Tube To Male Pipe

PART No.	Tube	Pipe
S6769-4A	1/4	1/8
S6769-4B	1/4	1/4
S6769-6B	3/8	1/4
S6769-6C	3/8	3/8
S6769-8C	1/2	3/8
S6769-8D	1/2	1/2
S6769-10D	5/8	1/2
S6769-12E	3/4	3/4



TEE Tube Three Ends

PART No.	Tube
S6764-4	1/4
S6764-6	3/8
S6764-8	1/2
S6764-10	5/8

A

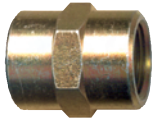

COUPLING
Female Both
Ends

PART No.	Pipe	Pipe
S1003-A	1/8	1/8
S1003-B	1/4	1/4
S1003-BA	1/4	1/8
S1003-C	3/8	3/8
S1003-CA	3/8	1/8
S1003-CB	3/8	1/4
S1003-D	1/2	1/2
S1003-DB	1/2	1/4
S1003-DC	1/2	3/8
S1003-E	3/4	3/4
S1003-ED	3/4	1/2
S1003-H	1	1
S1003-HE	1	3/4
S1003-J	1-1/4	1-1/4
S1003-K	1-1/2	1-1/2
S1003-M	2	2

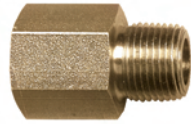

REDUCER
Female To Male
(Cont.)

PART No.	Female Pipe	Male Pipe
S1020-DC	1/2	3/8
S1020-DD	1/2	1/2
S1020-DE	1/2	3/4
S1020-EB	3/4	1/4
S1020-EC	3/4	3/8
S1020-ED	3/4	1/2
S1020-EE	3/4	3/4
S1020-EH	3/4	1
S1020-HD	1	1/2
S1020-HE	1	3/4
S1020-HH	1	1
S1020-JH	1-1/4	1
S1020-KJ	1-1/2	1-1/4



PLUG
COUNTER SUNK
HEX

PART No.	Pipe
S1018-A	1/8
S1018-B	1/4
S1018-C	3/8
S1018-D	1/2
S1018-E	3/4
S1018-H	1
S1018-J	1-1/4
S1018-K	1-1/2
S1018-M	2



BUSHING
Male To
Female

PART No.	Male Pipe	Female Pipe
S1010-BA	1/4	1/8
S1010-CA	3/8	1/8
S1010-CB	3/8	1/4
S1010-DA	1/2	1/8
S1010-DB	1/2	1/4
S1010-DC	1/2	3/8
S1010-EB	3/4	1/4
S1010-EC	3/4	3/8
S1010-ED	3/4	1/2
S1010-HB	1	1/4
S1010-HC	1	3/8
S1010-HD	1	1/2
S1010-HE	1	3/4
S1010-JD	1-1/4	1/2
S1010-JE	1-1/4	3/4
S1010-JH	1-1/4	1
S1010-KE	1-1/2	3/4
S1010-KH	1-1/2	1
S1010-KJ	1-1/2	1-1/4
S1010-MH	2	1
S1010-MJ	2	1-1/4
S1010-MK	2	1-1/2

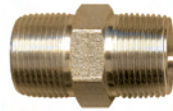

HEX NIPPLE
Male Both
Ends

PART No.	Pipe	Pipe
S1022-A	1/8	1/8
S1022-B	1/4	1/4
S1022-BA	1/4	1/8
S1022-C	3/8	3/8
S1022-CA	3/8	1/8
S1022-CB	3/8	1/4
S1022-D	1/2	1/2
S1022-DB	1/2	1/4
S1022-DC	1/2	3/8
S1022-E	3/4	3/4
S1022-EC	3/4	3/8
S1022-ED	3/4	1/2
S1022-H	1	1
S1022-HD	1	1/2
S1022-HE	1	3/4
S1022-J	1-1/4	1-1/4
S1022-JH	1-1/4	1
S1022-K	1-1/2	1-1/2
S1022-KH	1-1/2	1
S1022-KJ	1-1/2	1-1/4
S1022-M	2	2

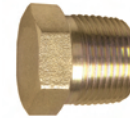

PLUG
HEX HEAD

PART No.	Pipe
S1021-A	1/8
S1021-B	1/4
S1021-C	3/8
S1021-D	1/2
S1021-E	3/4
S1021-H	1
S1021-J	1-1/4
S1021-K	1-1/2
S1021-M	2



SHORT NIPPLE

PART No.	Pipe	Length
S1012-A	1/8	3/4
S1012-B	1/4	7/8
S1012-C	3/8	1
S1012-D	1/2	1-1/8
S1012-E	3/4	1-3/8
S1012-H	1	1-1/2

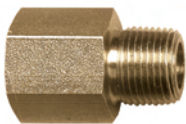

REDUCER
Female To Male

PART No.	Female Pipe	Male Pipe
S1020-AA	1/8	1/8
S1020-BA	1/4	1/8
S1020-BB	1/4	1/4
S1020-BC	1/4	3/8
S1020-BD	1/4	1/2
S1020-CA	3/8	1/8
S1020-CB	3/8	1/4
S1020-CC	3/8	3/8
S1020-CD	3/8	1/2
S1020-DA	1/2	1/8
S1020-DB	1/2	1/4

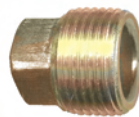

PLUG
SQUARE
HEAD

PART No.	Pipe
S1009-A	1/8
S1009-B	1/4
S1009-C	3/8
S1009-D	1/2
S1009-E	3/4
S1009-H	1
S1009-K	1-1/2



LONG NIPPLE

PART No.	Pipe	Length
S1013-A1-1/2	1/8	1-1/2
S1013-B1-1/2	1/4	1-1/2
S1013-B2	1/4	2
S1013-B2-1/2	1/4	2-1/2
S1013-B3	1/4	3
S1013-B4	1/4	4
S1013-B6	1/4	6
S1013-C1-1/2	3/8	1-1/2
S1013-C2	3/8	2
S1013-C3	3/8	3
S1013-C4	3/8	4
S1013-D1-1/2	1/2	1-1/2
S1013-D2	1/2	2
S1013-D3	1/2	3
S1013-D4	1/2	4
S1013-E3	3/4	3
S1013-E4	3/4	4

STEEL S.A.E. PIPE ADAPTERS

A



**90° ELBOW
Female To
Female**

PART No.	Pipe	Pipe
S1000-A	1/8	1/8
S1000-B	1/4	1/4
S1000-C	3/8	3/8
S1000-CB	3/8	1/4
S1000-D	1/2	1/2
S1000-DC	1/2	3/8
S1000-E	3/4	3/4
S1000-ED	3/4	1/2
S1000-H	1	1
S1000-J	1-1/4	1-1/4
S1000-K	1-1/2	1-1/2
S1000-M	2	2



**90° ELBOW
Male To Female**

PART No.	Male Pipe	Female Pipe
S1016-A	1/8	1/8
S1016-AB	1/8	1/4
S1016-B	1/4	1/4
S1016-BC	1/4	3/8
S1016-C	3/8	3/8
S1016-CB	3/8	1/4
S1016-CD	3/8	1/2
S1016-D	1/2	1/2
S1016-DC	1/2	3/8
S1016-DE	1/2	3/4
S1016-E	3/4	3/4
S1016-ED	3/4	1/2
S1016-H	1	1
S1016-J	1-1/4	1-1/4
S1016-JH	1-1/4	1
S1016-K	1-1/2	1-1/2
S1016-M	2	2



**90° ELBOW
Female To Male
Swivel**

PART No.	Female Pipe	Male Pipe
S1016SW-B	1/4	1/4
S1016SW-C	3/8	3/8
S1016SW-D	1/2	1/2



**90° ELBOW
Male To
Male Swivel**

PART No.	Pipe	Swivel
S1099SW-B	1/4	1/4



**90° ELBOW
Male To
Male**

PART No.	Pipe	Pipe
S1099-A	1/8	1/8
S1099-B	1/4	1/4
S1099-C	3/8	3/8
S1099-CB	3/8	1/4
S1099-D	1/2	1/2
S1099-DC	1/2	3/8
S1099-E	3/4	3/4
S1099-ED	3/4	1/2
S1099-H	1	1
S1099-J	1-1/4	1-1/4
S1099-K	1-1/2	1-1/2



**45° ELBOW
Female To
Female**

PART No.	Pipe
S1005-B	1/4
S1005-C	3/8
S1005-D	1/2
S1005-E	3/4
S1005-H	1



**45° ELBOW
Male To
Male**

PART No.	Pipe
S1005M-B	1/4
S1005M-C	3/8
S1005M-D	1/2
S1005M-E	3/4
S1005M-H	1
S1005M-J	1-1/4



**45° ELBOW
Male To
Female**

PART No.	Male Pipe	Female Pipe
S1024-A	1/8	1/8
S1024-B	1/4	1/4
S1024-C	3/8	3/8
S1024-D	1/2	1/2
S1024-E	3/4	3/4
S1024-H	1	1
S1024-J	1-1/4	1-1/4



**TEE
Female
All Ends**

PART No.	Pipe
S1001-A	1/8
S1001-B	1/4
S1001-C	3/8
S1001-D	1/2
S1001-E	3/4
S1001-H	1
S1001-J	1-1/4
S1001-K	1-1/2
S1001-M	2

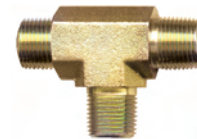

**TEE
Male
All Ends**

PART No.	Pipe
S1001M-B	1/4
S1001M-C	3/8
S1001M-D	1/2
S1001M-E	3/4



**TEE
Male To
Female To
Male**

PART No.	Female Pipe	Male Pipe
S1004-B	1/4	1/4
S1004-C	3/8	3/8
S1004-D	1/2	1/2
S1004-E	3/4	3/4
S1004-H	1	1



**TEE
Female To
Female To
Male**

PART No.	Female Pipe	Male Pipe
S1006-A	1/8	1/8
S1006-B	1/4	1/4
S1006-C	3/8	3/8
S1006-D	1/2	1/2
S1006-E	3/4	3/4
S1006-H	1	1



**TEE
Male To Male
To Female**

PART No.	Male Pipe	Female Pipe
S1006M-B	1/4	1/4
S1006M-C	3/8	3/8
S1006M-D	1/2	1/2
S1006M-E	3/4	3/4
S1006M-H	1	1

A

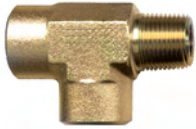

TEE
Female To
Male To
Female

PART No.	Female Pipe	Male Pipe
S1007-A	1/8	1/8
S1007-B	1/4	1/4
S1007-C	3/8	3/8
S1007-D	1/2	1/2
S1007-E	3/4	3/4
S1007-H	1	1
S1007-J	1-1/4	1-1/4



CROSS
Female All
Ends

PART No.	Pipe
S1002-B	1/4
S1002-C	3/8
S1002-D	1/2
S1002-E	3/4
S1002-H	1



CAP
Female

PART No.	Pipe
S1008-A	1/8
S1008-B	1/4
S1008-C	3/8
S1008-D	1/2
S1008-E	3/4

O-RING BOSS TO NPSM (BUNA-N O-RING STANDARD)



CONNECTOR
Male O-Ring To
NPSM Swivel

PART No.	O-Ring	Swivel
SO1120-4B	7/16 - 20	1/4
SO1120-6B	9/16 - 18	1/4
SO1120-6C	9/16 - 18	3/8
SO1120-6D	9/16 - 18	1/2
SO1120-8B	3/4 - 16	1/4
SO1120-8C	3/4 - 16	3/8
SO1120-8D	3/4 - 16	1/2
SO1120-8E	3/4 - 16	3/4
SO1120-10C	7/8 - 14	3/8
SO1120-10D	7/8 - 14	1/2
SO1120-10E	7/8 - 14	3/4
SO1120-12D	1-1/16 - 12	1/2
SO1120-12E	1-1/16 - 12	3/4
SO1120-16E	1-5/16 - 12	3/4
SO1120-16H	1-5/16 - 12	1
SO1120-20J	1-5/8 - 12	1-1/4

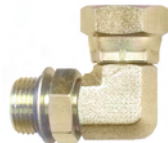

90° ELBOW
Male O-Ring To
NPSM Swivel

PART No.	O-Ring	Swivel
SO1116-4B	7/16 - 20	1/4
SO1116-4C	7/16 - 20	3/8
SO1116-6B	9/16 - 18	1/4
SO1116-6C	9/16 - 18	3/8
SO1116-6D	9/16 - 18	1/2
SO1116-8C	3/4 - 16	3/8
SO1116-8D	3/4 - 16	1/2
SO1116-8E	3/4 - 16	3/4
SO1116-10C	7/8 - 14	3/8
SO1116-10D	7/8 - 14	1/2
SO1116-10E	7/8 - 14	3/4
SO1116-12D	1-1/16 - 12	1/2
SO1116-12E	1-1/16 - 12	3/4
SO1116-16E	1-5/16 - 12	3/4
SO1116-16H	1-5/16 - 12	1
SO1116-20J	1-5/8 - 12	1-1/4



45° ELBOW
Male O-Ring To
NPSM Swivel

PART No.	O-Ring	Swivel
SO1124-4B	7/16 - 20	1/4
SO1124-6B	9/16 - 18	1/4
SO1124-6C	9/16 - 18	3/8
SO1124-8C	3/4 - 16	3/8
SO1124-8D	3/4 - 16	1/2
SO1124-10D	7/8 - 14	1/2
SO1124-10E	7/8 - 14	3/4
SO1124-12D	1-1/16 - 12	1/2
SO1124-12E	1-1/16 - 12	3/4
SO1124-16H	1-5/16 - 12	1

STEEL S.A.E. SWIVEL NPSM ADAPTERS



A



CONNECTOR
Female Pipe To
NPSM Swivel

PART No.	Pipe	Swivel
S1103-AA	1/8	1/8
S1103-BB	1/4	1/4
S1103-BC	1/4	3/8
S1103-CB	3/8	1/4
S1103-CC	3/8	3/8
S1103-CD	3/8	1/2
S1103-DC	1/2	3/8
S1103-DD	1/2	1/2
S1103-EE	3/4	3/4
S1103-HE	1	3/4
S1103-HH	1	1
S1103-JJ	1-1/4	1-1/4
S1103-KK	1-1/2	1-1/2
S1103-MM	2	2



CONNECTOR
Male Pipe To
NPSM Swivel

PART No.	Pipe	Swivel
S1120-AA	1/8	1/8
S1120-AB	1/8	1/4
S1120-BA	1/4	1/8
S1120-BB	1/4	1/4
*S1120-BB.000	1/4	1/4
S1120-BC	1/4	3/8
S1120-CB	3/8	1/4
S1120-CC	3/8	3/8
*S1120-CC.000	3/8	3/8
S1120-CD	3/8	1/2
S1120-DB	1/2	1/4
S1120-DC	1/2	3/8
S1120-DD	1/2	1/2
*S1120-DD.000	1/2	1/2
S1120-DE	1/2	3/4
S1120-ED	3/4	1/2
S1120-EE	3/4	3/4
S1120-EH	3/4	1
S1120-HE	1	3/4
S1120-HH	1	1
S1120-HJ	1	1-1/4
S1120-JH	1-1/4	1
S1120-JJ	1-1/4	1-1/4
S1120-KJ	1-1/2	1-1/4
S1120-KK	1-1/2	1-1/2
S1120-MM	2	2



90° ELBOW
Female Pipe To
NPSM Swivel

PART No.	Pipe	Swivel
S1100-AA	1/8	1/8
S1100-BB	1/4	1/4
S1100-CC	3/8	3/8
S1100-DD	1/2	1/2
S1100-EE	3/4	3/4
S1100-HH	1	1



90° ELBOW
Male Pipe To
NPSM Swivel

PART No.	Pipe	Swivel
S1116-AA	1/8	1/8
S1116-AB	1/8	1/4
S1116-BB	1/4	1/4
S1116-BC	1/4	3/8
S1116-CB	3/8	1/4
S1116-CC	3/8	3/8
S1116-CD	3/8	1/2
S1116-DB	1/2	1/4
S1116-DC	1/2	3/8
S1116-DD	1/2	1/2
S1116-DE	1/2	3/4
S1116-ED	3/4	1/2
S1116-EE	3/4	3/4
S1116-EH	3/4	1
S1116-HE	1	3/4
S1116-HH	1	1
S1116-HJ	1	1-1/4
S1116-JH	1-1/4	1
S1116-JJ	1-1/4	1-1/4
S1116-KK	1-1/2	1-1/2
S1116-MM	2	2

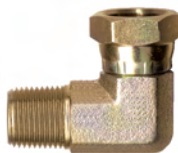

**90° ELBOW
(LONG STYLE)**
Male Pipe To
NPSM Swivel

PART No.	Pipe	Swivel
S1116L-CC	3/8	3/8
S1116L-DD	1/2	1/2

<<< * When ordering restricted flow adapters suffix part number with required restriction hole size. (example: S1120-BB.040)



45° ELBOW
Male Pipe To
NPSM Swivel

PART No.	Pipe	Swivel
S1124-AA	1/8	1/8
S1124-BB	1/4	1/4
S1124-CC	3/8	3/8
S1124-CD	3/8	1/2
S1124-DC	1/2	3/8
S1124-DD	1/2	1/2
S1124-EE	3/4	3/4
S1124-HE	1	3/4
S1124-HH	1	1
S1124-JJ	1-1/4	1-1/4
S1124-KK	1-1/2	1-1/2
S1124-MM	2	2



45° ELBOW
Female Pipe To
NPSM Swivel

PART No.	Pipe	Swivel
S1105-CC	3/8	3/8
S1105-DD	1/2	1/2
S1105-EE	3/4	3/4
S1105-HH	1	1



TEE
NPSM Swivel To
NPSM Swivel To
Female Pipe

PART No.	Pipe	Swivel
S1101-BB	1/4	1/4
S1101-CC	3/8	3/8
S1101-DD	1/2	1/2



TEE
NPSM Swivel To
NPSM Swivel To
Male Pipe

PART No.	Pipe	Swivel
S1106-BB	1/4	1/4
S1106-CC	3/8	3/8
S1106-DD	1/2	1/2
S1106-EE	3/4	3/4
S1106-HH	1	1



TEE
NPSM Swivel
All Ends

PART No.	Swivel
S1111-B	1/4
S1111-C	3/8
S1111-D	1/2
S1111-E	3/4
S1111-H	1

A

The New Look for Fairview's Accutek Hydraulic and Pneumatic Product Lines.

**ACCUTEK™**

Products for Industry | Service for People®

**HYDRAULIC
PRODUCTS**

HOSE ENDS



**WHAT'S NEW
IN THIS SECTION**

- Plastic PEX FittingsPg 61

COMBINATION HOSE NIPPLES \ MENDERS -STEEL58

CRIMP INSTRUCTIONS / SPECS71, 73, 74, 76 -77

FERRULES -BRASS58

FUEL LINE HOSE BARBS -BRASS58

GRIP-TITE HOSE BARBS -BRASS59

HOSE BARB FITTINGS -BRASS56 - 58

HOSE BARB FITTINGS -NYLON57

PEX FITTINGS AND KITS - BRASS62

PEX FITTINGS - PLASTIC61

PTFE HOSE CRIMP ENDS -ONE PIECE STYLE71

PTFE HOSE REUSABLE ENDS72

REUSABLE HOSE ENDS -BRASS63

RING BARB FITTINGS -BRASS63

S.A.E. 100R1, T1SN HOSE CRIMP ENDS -BITE WIRE STYLE67

S.A.E. 100R1, T1SN HOSE CRIMP ENDS -COMPRESSION STYLE .64 - 66

S.A.E. 100R1, T1SN HOSE ENDS -REUSABLE71

S.A.E. 100R2, T2SN HOSE CRIMP ENDS -BITE WIRE STYLE67

S.A.E. 100R2, T2SN HOSE CRIMP ENDS -COMPRESSION STYLE .64 - 66

S.A.E. 100R2, T2SN HOSE ENDS -REUSABLE71

S.A.E. 100R3 HOSE CRIMP ENDS -COMPRESSION STYLE64 - 65

S.A.E. 100R4 HOSE CRIMP ENDS -COMPRESSION STYLE64 - 65

S.A.E. 100R4 HOSE INSERTS73

S.A.E. 100R5 HOSE CRIMP ENDS69

S.A.E. 100R5 HOSE REUSABLE ENDS70

S.A.E. 100R7 HOSE CRIMP ENDS73

S.A.E. 100R12 HOSE CRIMP ENDS -BITE WIRE STYLE68 - 69

S.A.E. 100R14 HOSE CRIMP ENDS -ONE PIECE STYLE71

S.A.E. 100R14 HOSE REUSABLE ENDS72

S.A.E. 100R16 HOSE CRIMP ENDS -BITE WIRE STYLE67

S.A.E. 100R16 HOSE CRIMP ENDS -COMPRESSION STYLE64 - 66

S.A.E. 100R17 HOSE CRIMP ENDS -BITE WIRE STYLE67

S.A.E. 100R17 HOSE CRIMP ENDS -COMPRESSION STYLE64 - 66

SELF STORING AIR HOSE ENDS - BRASS87

SEWER HOSE ENDS74

SYNFLEX PERMANENT HOSE ENDS75 - 76

SYNFLEX REUSABLE HOSE END75

SYNFLEX CRIMP HOSE ENDS SPECIFICATIONS CHARTS76 - 77



BRASS HOSE BARB FITTINGS

B



COUPLER
Hose Barb To
Male Pipe

PART No.	Hose I.D.	Pipe
125-2-10/32	1/8	10/32
125-2A	1/8	1/8
125-2B	1/8	1/4
125-3A	3/16	1/8
125-3B	3/16	1/4
125-4A	1/4	1/8
125-4B	1/4	1/4
125-4C	1/4	3/8
125-4D	1/4	1/2
125-5A	5/16	1/8
125-5B	5/16	1/4
125-5C	5/16	3/8
125-6A	3/8	1/8
125-6B	3/8	1/4
125-6C	3/8	3/8
125-6D	3/8	1/2
125-6E	3/8	3/4
125-8B	1/2	1/4
125-8C	1/2	3/8
125-8D	1/2	1/2
125-8E	1/2	3/4
125-10C	5/8	3/8
125-10D	5/8	1/2
125-10E	5/8	3/4
125-12D	3/4	1/2
125-12E	3/4	3/4
125-16E	1	3/4
125-16H	1	1
125CA-8D	1/2 Cast Brass	1/2
125CA-12E	3/4 Cast Brass	3/4
125CA-16H	1 Cast Brass	1
125CA-20J	1-1/4 Cast Brass	1-1/4
125CA-24K	1-1/2 Cast Brass	1-1/2
125CA-32M	2 Cast Brass	2



**WORKING SWIVEL
COUPLER**
Hose Barb To
Male Pipe

PART No.	Hose I.D.	Pipe
1925-4B	1/4	1/4
1925-6B	3/8	1/4
1925-6C	3/8	3/8
1925-8C	1/2	3/8
1925-8D	1/2	1/2

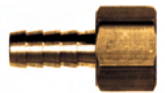

COUPLER
Hose Barb To
Female Pipe

PART No.	Hose I.D.	Pipe
126-2A	1/8	1/8
126-2B	1/8	1/4
126-3A	3/16	1/8
126-3B	3/16	1/4
126-4A	1/4	1/8
126-4B	1/4	1/4
126-4C	1/4	3/8
126-5A	5/16	1/8
126-5B	5/16	1/4
126-5C	5/16	3/8
126-6A	3/8	1/8
126-6B	3/8	1/4
126-6C	3/8	3/8
126-6D	3/8	1/2
126-8B	1/2	1/4
126-8C	1/2	3/8
126-8D	1/2	1/2
126-12D	3/4	1/2
126-16H	1	1



**SWIVEL
COUPLER**
Hose Barb Flat
Seat With Gasket
To Female
Straight Pipe

PART No.	Hose I.D.	Straight Pipe
130-4A	1/4	1/8
130-4B	1/4	1/4
130-6B	3/8	1/4
130-6C	3/8	3/8
130-6D	3/8	1/2
130-8C	1/2	3/8
130-8D	1/2	1/2



**SWIVEL
COUPLER**
Hose Barb Ball
Seat To Female
Straight Pipe

Use With PART No. 134

PART No.	Hose I.D.	Straight Pipe
131-3A	3/16	1/8
131-3B	3/16	1/4
131-4A	1/4	1/8
131-4B	1/4	1/4
131-4C	1/4	3/8
131-5B	5/16	1/4
131-6B	3/8	1/4
131-6C	3/8	3/8
131-8C	1/2	3/8
131-8D	1/2	1/2
131-12E	3/4	3/4



COUPLER
Hose Barb To
Male 45°
S.A.E. Flare

PART No.	Hose I.D.	Tube
127-44	1/4	1/4
127-46	1/4	3/8
127-55	5/16	5/16
127-66	3/8	3/8
127-68	3/8	1/2
127-88	1/2	1/2

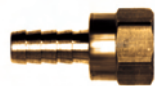

**SWIVEL
COUPLER**
Hose Barb To
Female 45°
S.A.E. Flare

PART No.	Hose I.D.	Tube
128-34	3/16	1/4
128-44	1/4	1/4
128-45	1/4	5/16
128-46	1/4	3/8
128-55	5/16	5/16
128-56	5/16	3/8
128-66	3/8	3/8
128-68	3/8	1/2
128-88	1/2	1/2
128-810	1/2	5/8
128-1010	5/8	5/8
128-1212	3/4	3/4



CONNECTOR
Male Straight
Pipe Thread With
Ball Seat To Male
Taper Pipe Thread

Use With PART No. 130, 131

PART No.	Straight Pipe	Pipe
134-BB	1/4	1/4
134-CC	3/8	3/8
134-CD	3/8	1/2
134-DD	1/2	1/2

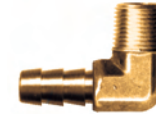

90° ELBOW
Hose Barb
To
Male Pipe

PART No.	Hose I.D.	Pipe
139-3A	3/16	1/8
139-4A	1/4	1/8
139-4B	1/4	1/4
139-4C	1/4	3/8
139-5A	5/16	1/4
139-5B	5/16	1/4
139-5C	5/16	3/8
139-6A	3/8	1/8
139-6B	3/8	1/4
139-6C	3/8	3/8
139-6D	3/8	1/2
139-8B	1/2	1/4
139-8C	1/2	3/8
139-8D	1/2	1/2
139-10C	5/8	3/8
139-10D	5/8	1/2
139-12D	3/4	1/2
139-12E	3/4	3/4
139-16E	1	3/4
139-16H	1	1



45° ELBOW
Hose Barb To
Male Pipe

PART No.	Hose I.D.	Pipe
140-4A	1/4	1/8
140-4B	1/4	1/4
140-5A	5/16	1/8
140-6A	3/8	1/8
140-6B	3/8	1/4
140-6C	3/8	3/8
140-8C	1/2	3/8
140-10C	5/8	3/8

HOSE BARB FITTINGS



SPLICER
Hose Barb

PART No.	Hose I.D.
129-3	3/16
129-4	1/4
129-5	5/16
129-6	3/8
129-8	1/2
129-10	5/8
129-12	3/4



TEE
Hose Barb
All Ends

PART No.	Hose I.D.
123-4	1/4
123-5	5/16
123-6	3/8



ELBOW
Hose Barb
To
Hose Barb

PART No.	Hose I.D.
99HB-4	1/4
99HB-5	5/16
99HB-6	3/8
99HB-8	1/2



CROSS
Hose Barb
All Ends

PART No.	Hose I.D.
102HB-4	1/4

NYLON HOSE BARB FITTINGS (MADE WITH NSF APPROVED RESINS)



COUPLER
Hose Barb
To
Male Pipe

PART No.	Hose I.D.	Pipe
525-4A	1/4	1/8
525-4B	1/4	1/4
525-4D	1/4	1/2
525-5A	5/16	1/8
525-6B	3/8	1/4
525-6C	3/8	3/8
525-6D	3/8	1/2
525-8C	1/2	3/8
525-8D	1/2	1/2
525-8E	1/2	1/2
525-10D	5/8	1/2
525-10E	5/8	3/4
525-12D	3/4	1/2
525-12E	3/4	3/4



COUPLER
Hose Barb
To
Female Pipe

PART No.	Hose I.D.	Pipe
526-4B	1/4	1/4
526-4D	1/4	1/2
526-6B	3/8	1/4
526-6C	3/8	3/8
526-8C	1/2	3/8
526-8D	1/2	1/2

OTHER SIZES AVAILABLE.
MINIMUM RUNS APPLY.



SPLICER
Hose Barb

PART No.	Hose I.D.
529-4	1/4
529-6	3/8
529-8	1/2
Reducing	
529-42	1/4 to 1/8
529-64	3/8 to 1/4
529-86	1/2 to 3/8



90° ELBOW
Hose Barb
To
Male Pipe

PART No.	Hose I.D.	Pipe
539-4A	1/4	1/8
539-4B	1/4	1/4
539-6B	3/8	1/4
539-6C	3/8	3/8
539-6D	3/8	1/2
539-8C	1/2	3/8
539-8D	1/2	1/2
539-10D	5/8	1/2
539-10E	5/8	3/4



90° ELBOW
Hose Barb
To
Female Pipe

PART No.	Hose I.D.	Pipe
539F-4B	1/4	1/4
539F-8D	1/2	1/2



90° ELBOW
Hose Barb
To
Hose Barb

PART No.	Hose I.D.
555-4	1/4
555-6	3/8
555-8	1/2
555-10	5/8
555-12	3/4



TEE
Hose Barb
All Ends

PART No.	Hose I.D.
544-3	3/16
544-4	1/4
544-6	3/8
544-8	1/2
544-10	5/8

B



BRASS FUEL LINE HOSE BARBS

B



COUPLER
Hose Barb
To Male Pipe

PART No.	Hose I.D.	Pipe
325-3A	3/16	1/8
325-4A	1/4	1/8
325-4B	1/4	1/4
325-5A	5/16	1/8
325-5B	5/16	1/4
325-6A	3/8	1/8
325-6B	3/8	1/4
325-6C	3/8	3/8
325-10C	5/8	3/8
325-10D	5/8	1/2
325-12D	3/4	1/2



CONNECTOR
Hose Barb To
Male Inverted
Flare

PART No.	Hose I.D.	Tube Size
335-54	5/16	1/4
335-55	5/16	5/16
335-65	3/8	5/16
335-66	3/8	3/8



90° ELBOW
Hose Barb
To
Male Pipe

PART No.	Hose I.D.	Pipe
339-4A	1/4	1/8
339-5A	5/16	1/8
339-5B	5/16	1/4
339-6A	3/8	1/8
339-6B	3/8	1/4
339-10C	5/8	3/8

FOR FUEL LINE HOSE SEE PAGE 101.

STEEL COMBINATION NIPPLES AND HOSE MENDERS (NOT RECOMMENDED FOR USE WITH AIR)



COMBINATION NIPPLE
Hose Barb To
Male Pipe

PART No.	Hose I.D.	Pipe
BI-125-8D	1/2	1/2
BI-125-12E	3/4	3/4
BI-125-16H	1	1
BI-125-20J	1-1/4	1-1/4
BI-125-24K	1-1/2	1-1/2
BI-125-32M	2	2
BI-125-40N	2-1/2	2-1/2

ALSO AVAILABLE IN GALVANIZED. REPLACE PREFIX BI- WITH GI-
EXAMPLE: GI-125-24K



HOSE MENDER
Hose Barb

PART No.	Hose I.D.
BI-129-8	1/2
BI-129-12	3/4
BI-129-16	1
BI-129-20	1-1/4
BI-129-24	1-1/2

ALSO AVAILABLE IN GALVANIZED. REPLACE PREFIX BI- WITH GI-
EXAMPLE: GI-129-24

BRASS STANDARD FERRULES FBL – Ferrules Brass Long



FBL



FBS

- SIZE RANGE FROM 3/8 TO 1 INCH OUTSIDE DIAMETER
- THE PART NUMBER DESIGNATES THE OUTSIDE DIAMETER OF THE HOSE OR TUBE
- WALL THICKNESS OF THE FERRULE IS .025
- TO ORDER A FERRULE CRIMPER SEE PAGE 246

PART No.	Inside Dia. (IN.)	Ferrule Length (IN.)	Hole Size (IN.)	PART No.	Inside Dia. (IN.)	Ferrule Length (IN.)	Hole Size (IN.)	PART No.	Inside Dia. (IN.)	Ferrule Length (IN.)	Hole Size (IN.)
FBL-400	.400	23/32	.265	FBL-675	.675	31/32	.500	FBL-925	.925	31/32	.750
FBL-450	.450	23/32	.328	FBL-700	.700	31/32	.500	FBL-975	.975	31/32	.875
FBL-475	.475	23/32	.328	FBL-725	.725	31/32	.500	FBL-1000	1.000	31/32	.875
FBL-500	.500	23/32	.328	FBL-750	.750	31/32	.500	FBL-1025	1.025	31/32	.875
FBL-525	.525	23/32	.453	FBL-775	.775	31/32	.500	FBL-1100	1.100	31/32	.875
FBL-550	.550	23/32	.438	FBL-800	.800	31/32	.625	FBL-1125	1.125	31/32	.875
FBL-575	.575	31/32	.438	FBL-825	.825	31/32	.625	FBL-1150	1.150	31/32	.875
FBL-600	.600	31/32	.453	FBL-850	.850	31/32	.687	FBL-1175	1.175	55/64	.875
FBL-625	.625	31/32	.453	FBL-875	.875	31/32	.750	FBL-1275	1.275	31/32	.875
FBL-650	.650	31/32	.453	FBL-900	.900	31/32	.750	FBL-1500	1.500	31/32	.875

BRASS SHORT FERRULES FBS – Ferrules Brass Short

PART No.	Inside Dia. (IN.)	Ferrule Length (IN.)	Hole Size (IN.)	PART No.	Inside Dia. (IN.)	Ferrule Length (IN.)	Hole Size (IN.)	PART No.	Inside Dia. (IN.)	Ferrule Length (IN.)	Hole Size (IN.)
FBS-500	.500	1/2	.328	FBS-575	.575	15/32	.453	FBS-700	.700	17/32	.500
FBS-550	.550	9/16	.453	FBS-600	.600	15/32	.453				

BRASS GRIP-TITE HOSE FITTINGS

(USE WITH GRIP-TITE HOSE: SEE PAGE 105)



Male Pipe

PART No.	Hose I.D.	Pipe
725-4A	1/4	1/8
725-4B	1/4	1/4
725-4C	1/4	3/8
725-5A	5/16	1/8
725-5B	5/16	1/4
725-6A	3/8	1/8
725-6B	3/8	1/4
725-6C	3/8	3/8
725-6D	3/8	1/2
725-8B	1/2	1/4
725-8C	1/2	3/8
725-8D	1/2	1/2
725-8E	1/2	3/4
725-10C	5/8	3/8
725-10D	5/8	1/2
725-10E	5/8	3/4
725-12D	3/4	1/2
725-12E	3/4	3/4



Working Male Pipe Swivel

PART No.	Hose I.D.	Pipe
725SW-4B	1/4	1/4
725SW-6B	3/8	1/4
725SW-6C	3/8	3/8
725SW-8C	1/2	3/8
725SW-8D	1/2	1/2
725SW-12E	3/4	3/4

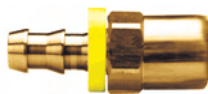

RIGID Female Pipe

PART No.	Hose I.D.	Tube
726-4A	1/4	1/8
726-4B	1/4	1/4
726-6B	3/8	1/4
726-6C	3/8	3/8
726-8C	1/2	3/8
726-8D	1/2	1/2
726-8E	1/2	3/4
726-12E	3/4	3/4



45° S.A.E. Male Flare

PART No.	Hose I.D.	Tube
727-44	1/4	1/4
727-45	1/4	5/16
727-66	3/8	3/8
727-88	1/2	1/2



45° S.A.E. Female Flare Swivel

PART No.	Hose I.D.	Tube
728-44	1/4	1/4
728-45	1/4	5/16
728-66	3/8	3/8
728-68	3/8	1/2
728-86	1/2	3/8
728-88	1/2	1/2
728-810	1/2	5/8
728-108	5/8	1/2
728-1010	5/8	5/8
728-1212	3/4	3/4



HOSE SPLICER

PART No.	Hose I.D.
729-4	1/4
729-5	5/16
729-6	3/8
729-8	1/2
729-10	5/8
729-12	3/4



Female Straight Pipe Swivel

GASKET TYPE

PART No.	Hose I.D.	Straight Pipe
730-4B	1/4	1/4



Female Straight Pipe Swivel

BALL TYPE

PART No.	Hose I.D.	Straight Pipe
731-4A	1/4	1/8
731-4B	1/4	1/4
731-6B	3/8	1/4
731-6C	3/8	3/8
731-8D	1/2	1/2
731-12E	3/4	3/4



RIGID Tube Shank

PART No.	Hose I.D.	Tube
732-44	1/4	1/4
732-66	3/8	3/8



45° S.A.E. Male Inverted Flare Swivel

PART No.	Hose I.D.	Tube
735-43	1/4	3/16
735-44	1/4	1/4
735-45	1/4	5/16
735-65	3/8	5/16
735-66	3/8	3/8
735-88	1/2	1/2
735-1010	5/8	5/8



45° S.A.E. Female Inverted Flare

PART No.	Hose I.D.	Tube
736-44	1/4	1/4
736-45	1/4	5/16
736-65	3/8	5/16
736-66	3/8	3/8



37° J.I.C. Male Flare

PART No.	Hose I.D.	Tube
737-44	1/4	1/4
737-66	3/8	3/8
737-88	1/2	1/2



37° J.I.C. Female Flare Swivel

PART No.	Hose I.D.	Tube
738-44	1/4	1/4
738-45	1/4	5/16
738-66	3/8	3/8
738-88	1/2	1/2
738-1010	5/8	5/8
738-1212	3/4	3/4



90° ELBOW Hose To Male Pipe

PART No.	Hose I.D.	Pipe
739-4A	1/4	1/8
739-4B	1/4	1/4
739-6B	3/8	1/4
739-6C	3/8	3/8
739-8C	1/2	3/8
739-8D	1/2	1/2
739-12E	3/4	3/4

ASSEMBLY INSTRUCTIONS

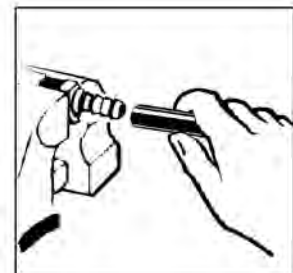

- LUBRICATE HOSE AND BARB.
- PUSH HOSE ON FITTING UNTIL SEATED UNDER PROTECTIVE CAP.
- NO CLAMPS REQUIRED WHEN USED WITH GRIP-TITE HOSE.

B

B

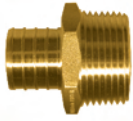

ADAPTER
Pex To
Male Pipe

PART No.	Pex	Pipe
PEX-125-8D	3/8	1/2
PEX-125-10D	1/2	1/2
PEX-125-10E	1/2	3/4
PEX-125-14D	3/4	1/2
PEX-125-14E	3/4	3/4
PEX-125-14H	3/4	1
PEX-125-18E	1	3/4
PEX-125-18H	1	1



ADAPTER
Pex to
Male Sweat

PART No.	Pex	Copper Tube
PEX-125SW-10	1/2	1/2 K
PEX-125SW-14	3/4	3/4 K
PEX-125SW-18	1	1 K

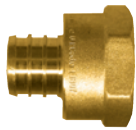

ADAPTER
Pex To
Female Pipe

PART No.	Pex	Pipe
PEX-126-10D	1/2	1/2
PEX-126-10E	1/2	3/4
PEX-126-14E	3/4	3/4
PEX-126-14H	3/4	1
PEX-126-18H	1	1



ADAPTER
Pex to FPT
Swivel Adapter

PART No.	Pex	Pipe
PEX-126SPN-8D	3/8	1/2
PEX-126SPN-10D	1/2	1/2
PEX-126SPN-10E	1/2	3/4



ADAPTER
Pex to
Female Sweat

PART No.	Pex	Copper Tube
PEX-126SW-10	1/2	1/2 K
PEX-126SW-14	3/4	3/4 K
PEX-126SW-18	1	1 K



COUPLING
Pex To Pex

PART No.	Pex	Pex
PEX-129-8	3/8	3/8
PEX-129-10	1/2	1/2
PEX-129-108	1/2	3/8
PEX-129-14	3/4	3/4
PEX-129-1410	3/4	1/2
PEX-129-18	1	1
PEX-129-1814	1	3/4



**PEX
PLUG**

PART No.	Pex
PEX-121HB-8	3/8
PEX-121HB-10	1/2
PEX-121HB-14	3/4
PEX-121HB-18	1



90° ELBOW
Pex To
Pex

PART No.	Pex	Pex
PEX-99HB-8	3/8	3/8
PEX-99HB-10	1/2	1/2
PEX-99HB-14	3/4	3/4
PEX-99HB-1410	3/4	1/2
PEX-99HB-18	1	1

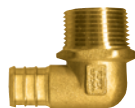

90° ELBOW
Pex To
Male Pipe

PART No.	Pex	Pipe
PEX-139-10D	1/2	1/2
PEX-139-14E	3/4	3/4



**FLANGED
90° ELBOW**
Pex To
Female Pipe

PART No.	Pex	Pipe
PEX-S139F-10D	1/2	1/2
PEX-S139F-14E	3/4	3/4



90° ELBOW
Pex To FPT
Swivel Adapter

PART No.	Pex	Pipe
PEX-139FSPN-8D	3/8	1/2
PEX-139FSPN-10D	1/2	1/2
PEX-139FSPN-14E	3/4	3/4



90° ELBOW
Pex To Male
Sweat

PART No.	Pex	Copper Tube
PEX-139SW-10	1/2	1/2 K
PEX-139SW-1014	1/2	3/4 K
PEX-139SW-14	3/4	3/4 K



90° ELBOW
Pex To Female
Sweat

PART No.	Pex	Copper Tube
PEX-139FSW-10	1/2	1/2 K
PEX-139FSW-1014	1/2	3/4 K
PEX-139FSW-14	3/4	3/4 K

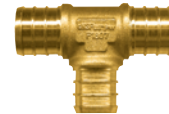

**TEE
Pex
Three Ends**

PART No.	Pex	Pex
PEX-123-8	3/8	3/8
PEX-123-10	1/2	1/2
PEX-123-14	3/4	3/4
PEX-123-18	1	1

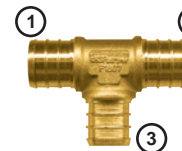

**Reducing
TEE
Pex
Three Ends**

PART No.	①	②	③
PEX-123-1014	1/2	1/2	3/4
PEX-123-1410	3/4	3/4	1/2
PEX-123-141010	3/4	1/2	1/2
PEX-123-141014	3/4	1/2	3/4
PEX-123-1418	3/4	3/4	1
PEX-123-1810	1	1	1/2
PEX-123-1814	1	1	3/4



PLASTIC PEX FITTINGS

(ASTM F877,ASTM F2159,CSA B137.5, NSF 14, NSF/ANSI 61)



ADAPTER
Pex To
Male Pipe

PART No.	Pex	Pipe
PEXPL-125-10D	1/2	1/2
PEXPL-125-10E	1/2	3/4
PEXPL-125-14D	3/4	1/2
PEXPL-125-14E	3/4	3/4
PEXPL-125-18H	1	1



ADAPTER
Pex To
Female Pipe

PART No.	Pex	Pipe
PEXPL-126-10D	1/2	1/2
PEXPL-126-14E	3/4	3/4
PEXPL-126-18H	1	1



COUPLING
Pex To Pex

PART No.	Pex	Pex
PEXPL-129-8	3/8	3/8
PEXPL-129-10	1/2	1/2
PEXPL-129-108	1/2	3/8
PEXPL-129-14	3/4	3/4
PEXPL-129-1410	3/4	1/2
PEXPL-129-18	1	1
PEXPL-129-1814	1	3/4



PEX
PLUG

PART No.	Pex
PEXPL-121HB-8	3/8
PEXPL-121HB-10	1/2
PEXPL-121HB-14	3/4
PEXPL-121HB-18	1



90° ELBOW
Pex To
Pex

PART No.	Pex	Pex
PEXPL-99HB-8	3/8	3/8
PEXPL-99HB-10	1/2	1/2
PEXPL-99HB-14	3/4	3/4
PEXPL-99HB-1410	3/4	1/2
PEXPL-99HB-18	1	1



90° ELBOW
Pex To
Male Pipe

PART No.	Pex	Pipe
PEXPL-139-10D	1/2	1/2
PEXPL-139-14E	3/4	3/4



TEE
Pex
Three Ends

PART No.	Pex	Pex
PEXPL-123-8	3/8	3/8
PEXPL-123-10	1/2	1/2
PEXPL-123-14	3/4	3/4
PEXPL-123-18	1	1



Reducing
TEE
Pex
Three Ends

PART No.	①	②	③
PEXPL-123-1014	1/2	1/2	3/4
PEXPL-123-1410	3/4	3/4	1/2
PEXPL-123-141010	3/4	1/2	1/2
PEXPL-123-141014	3/4	1/2	3/4
PEXPL-123-1418	3/4	3/4	1
PEXPL-123-1810	1	1	1/2

Note: Male / Female thread fittings must only use PTFE tape as thread sealant. Lock force should be 25 lbs/inch.

Material: Polyphenylsulphone (PPSU) Black color.

CONNECTING PEX TUBE TO INSERT FITTINGS

1. Cut Pex pipe squarely. Check pipe I.D. and O.D. and remove any burrs.
2. Apply copper ring or PEX clamp on top of PEX pipe.
3. Insert fitting into the end of the pipe and pull clamp or ring over the fitting within 1/8 to 1/4 inch from the end of the tube. This process presses the fitting ribs into the pipe.
4. Crimp copper ring or PEX clamp using the required Fairview tool.
5. Check crimp using the Go-No-Go Gauge to determine if the crimp connection was properly made.
6. The GO opening should go freely across a crimped ring. The No-Go opening should not go across a crimped ring.



STEP 1



STEP 2

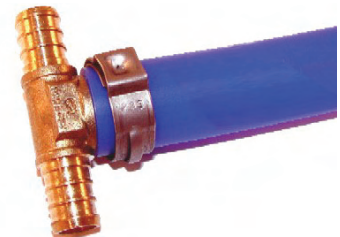

STEP 3



STEP 4



STEP 5



STEP 6

B

PEX FITTINGS ASSORTMENT KITS

PART No. PEX-KIT-BCR
(WITH BLACK COPPER CRIMP RINGS)



PART No. PEX-KIT-HC
(WITH STAINLESS STEEL STEPLESS CLAMPS)



PART No.	Qty	PART No.	Qty
PEX-99HB-10	2	PEX-126-14E	2
PEX-99HB-14	2	PEX-126SW-10	2
PEX-121HB-10	2	PEX-126SW-14	2
PEX-121HB-14	2	PEX-129-10	2
PEX-123-10	1	PEX-129-14	2
PEX-123-14	1	PEX-S139F-10D	1
PEX-125-10D	2	PEX-S139F-14E	1
PEX-125-10E	2	BVPEX2129-10	1
PEX-125-14D	2	BVPEX2129-14	1
PEX-125-14E	2	HCPEX-10-BCR	10
PEX-125SW-10	2	HCPEX-14-BCR	10
PEX-125SW-14	2	HCPEX-GNG	1
PEX-126-10D	2	PEX-JC-10	10
PEX-126-10E	2	PEX-JC-14	10

PART No.	Qty	PART No.	Qty
PEX-99HB-10	2	PEX-126-14E	2
PEX-99HB-14	2	PEX-126SW-10	2
PEX-121HB-10	2	PEX-126SW-14	2
PEX-121HB-14	2	PEX-129-10	2
PEX-123-10	1	PEX-129-14	2
PEX-123-14	1	PEX-S139F-10D	1
PEX-125-10D	2	PEX-S139F-14E	1
PEX-125-10E	2	BVPEX2129-10	1
PEX-125-14D	2	BVPEX2129-14	1
PEX-125-14E	2	HCPEX-10	10
PEX-125SW-10	2	HCPEX-14	10
PEX-125SW-14	2	HCPEX-GNG	1
PEX-126-10D	2	PEX-JC-10	10
PEX-126-10E	2	PEX-JC-14	10

Designed for use in the field, these kits include an excellent start-up selection of PEX fittings and PEX ball valves. **Single sided carry case, with handle.**

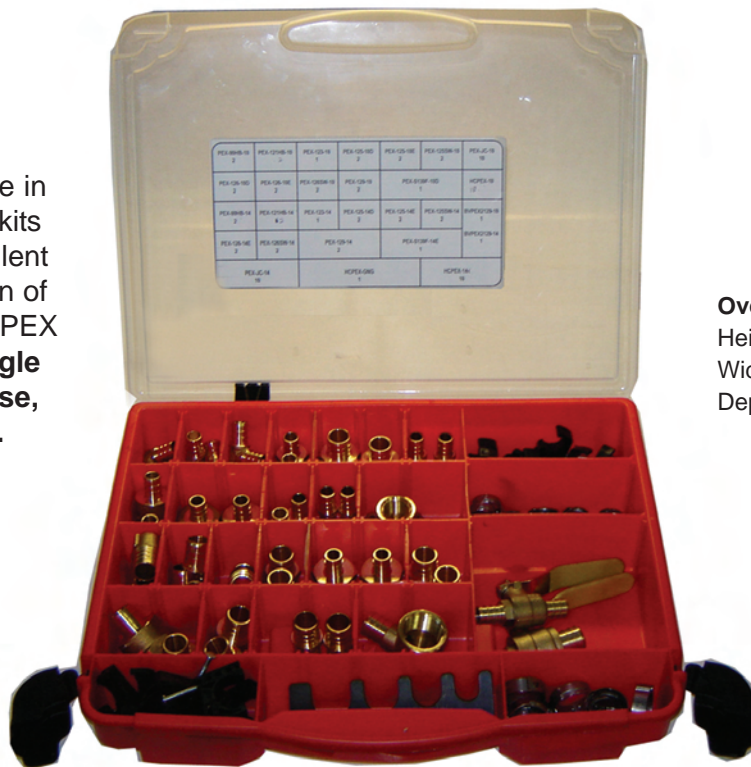

Overall:

Height 12 inches
Width 14-1/2 inches
Depth 2-3/8 inches

BRASS RING-BARB FITTINGS FOR POLY TUBE

(USE WITH POLYETHYLENE TUBE: Page 145)



COUPLING

Tube
To
Tube

PART No.	Tube O.D.	Tube I.D.
962-4	1/4	.170
962-6	3/8	.250
962-8	1/2	.375



BULKHEAD UNION

PART No.	Tube O.D.	Tube I.D.
977-4	1/4	.170



TEE Tube Three Ends

PART No.	Tube O.D.	Tube I.D.
964-4	1/4	.170
964-6	3/8	.250
964-8	1/2	.375

CONNECTOR

Tube
To
Female Pipe

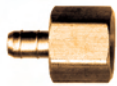

PART No.	Tube O.D.	Tube I.D.	Pipe
966-4A	1/4	.170	1/8
966-4B	1/4	.170	1/4
966-6B	3/8	.250	1/4

90° ELBOW

Tube
To
Tube



PART No.	Tube O.D.	Tube I.D.
965-4	1/4	.170
965-6	3/8	.250
965-8	1/2	.375

CONNECTOR

Tube
To
Male Pipe



PART No.	Tube O.D.	Tube I.D.	Pipe
968-4A	1/4	.170	1/8
968-4B	1/4	.170	1/4
968-6A	3/8	.250	1/8
968-6B	3/8	.250	1/4

90° ELBOW

Tube
To
Male Pipe



PART No.	Tube O.D.	Tube I.D.	Pipe
969-4A	1/4	.170	1/8
969-4B	1/4	.170	1/4
969-6A	3/8	.250	1/8
969-6B	3/8	.250	1/4

RING-BARB FITTINGS ARE DESIGNED FOR USE WITH POLYETHYLENE TUBE. THE BARB HAS A RAISED RING THAT IMBEDS INTO THE TUBE. THIS ASSURES A LEAKPROOF CONNECTION WHEN USED WITHIN THE NORMAL TEMPERATURE AND PRESSURE RANGE OF THE TUBE. SIMPLY PUSH FITTING INTO TUBE TO ASSEMBLE. NO TOOLS OR CLAMPS REQUIRED.



360-4YEL-100
SEE PAGE 145

BRASS SCREW-ON REUSABLE HOSE FITTINGS



HOSE FERRULES

PART No.	Hose O.D.	Hose I. D.
750-84	1/2	1/4
750-106	5/8	3/8
750-116	11/16	3/8
750-126	3/4	3/8
750-148	7/8	1/2
750-168	1	1/2

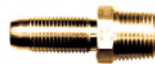

HOSE STEM

With
Male Pipe
Thread

PART No.	Hose I.D.	Pipe
751-4B	1/4	1/4
751-6B	3/8	1/4
751-6C	3/8	3/8
751-8B	1/2	1/4
751-8C	1/2	3/8
751-8D	1/2	1/2



HOSE STEM

With Female
Pipe Thread
(Two Piece
Swivel)

PART No.	Hose I.D.	Pipe
752-4B	1/4	1/4
752-6B	3/8	1/4
752-6C	3/8	3/8

B

STEEL ONE PIECE CRIMP HOSE ENDS (COMPRESSION STYLE)

FOR USE WITH S.A.E. 100R1-AT, 100R2-AT, T1SN, T2SN, 100R3, 100R4, 100R16 AND
100R17 HOSE (Pages 107 - 109, 111)

**ITEMS SHOWN ARE INTERCHANGEABLE WITH WEATHERHEAD "U" SERIES COUPLINGS.
(They are Fairview Equivalents and are NOT WeatherHead Original Product.)**

B



**Male
Pipe**

PART No.	Hose I.D.	Pipe
SC625-4A	1/4	1/8
SC625-4B	1/4	1/4
SC625-4C	1/4	3/8
SC625-4D	1/4	1/2
SC625-6B	3/8	1/4
SC625-6C	3/8	3/8
SC625-6D	3/8	1/2
SC625-8C	1/2	3/8
SC625-8D	1/2	1/2
SC625-8E	1/2	3/4
SC625-10D	5/8	1/2
SC625-10E	5/8	3/4
SC625-12D	3/4	1/2
SC625-12E	3/4	3/4
SC625-12H	3/4	1
SC625-16E	1	3/4
SC625-16H	1	1
SC625-20J	1-1/4	1-1/4



**Male Pipe
(Working
Swivel)**

PART No.	Hose I.D.	Pipe
SC625SW-4B	1/4	1/4
SC625SW-6B	3/8	1/4
SC625SW-6C	3/8	3/8
SC625SW-6D	3/8	1/2
SC625SW-8D	1/2	1/2
SC625SW-12E	3/4	3/4
SC625SW-16H	1	1



**Female
Pipe**

PART No.	Hose I.D.	Pipe
SC626-4A	1/4	1/8
SC626-4B	1/4	1/4
SC626-6B	3/8	1/4
SC626-6C	3/8	3/8
SC626-8D	1/2	1/2



**S.A.E. 37°
Male Flare**

PART No.	Hose I.D.	Tube
SC637-44	1/4	1/4
SC637-45	1/4	5/16
SC637-46	1/4	3/8
SC637-66	3/8	3/8
SC637-68	3/8	1/2
SC637-610	3/8	5/8
SC637-88	1/2	1/2
SC637-810	1/2	5/8
SC637-812	1/2	3/4
SC637-108	5/8	1/2
SC637-1010	5/8	5/8
SC637-1012	5/8	3/4
SC637-1212	3/4	3/4
SC637-1216	3/4	1
SC637-1616	1	1



**Female
N.P.S.M. Pipe
(Swivel)**

PART No.	Hose I.D.	Pipe
SC626SW-4B	1/4	1/4
SC626SW-6C	3/8	3/8
SC626SW-6D	3/8	1/2
SC626SW-8D	1/2	1/2
SC626SW-12E	3/4	3/4
SC626SW-16H	1	1



**Female
(Grease Tap)**

PART No.	Hose I.D.	Thread
SC626GT-4A	1/4	1/2 - 27



**S.A.E. 37°
Female Flare
(Swivel)**

PART No.	Hose I.D.	Tube
SC638-44	1/4	1/4
SC638-45	1/4	5/16
SC638-46	1/4	3/8
SC638-64	3/8	1/4
SC638-66	3/8	3/8
SC638-68	3/8	1/2
SC638-610	3/8	5/8
SC638-86	1/2	3/8
SC638-88	1/2	1/2
SC638-810	1/2	5/8
SC638-812	1/2	3/4
SC638-108	5/8	1/2
SC638-1010	5/8	5/8
SC638-1012	5/8	3/4
SC638-1210	3/4	5/8
SC638-1212	3/4	3/4
SC638-1214	3/4	7/8
SC638-1216	3/4	1
SC638-1612	1	3/4
SC638-1616	1	1
SC638-2020	1-1/4	1-1/4



**S.A.E. 45°
Female Flare
(Swivel)**

PART No.	Hose I.D.	Tube
SC628-46	1/4	3/8
SC628-66	3/8	3/8
SC628-1212	3/4	3/4



**S.A.E. 45°
Inverted Flare
(Swivel)**

PART No.	Hose I.D.	Tube
SC635-44	1/4	1/4
SC635-45	1/4	5/16
SC635-65	3/8	5/16
SC635-66	3/8	3/8
SC635-88	1/2	1/2



**Male
O-Ring Boss**

PART No.	Hose I.D.	O-Ring
SC643-66	3/8	9/16 - 18
SC643-68	3/8	3/4 - 16
SC643-610	3/8	7/8 - 14
SC643-88	1/2	3/4 - 16
SC643-810	1/2	7/8 - 14
SC643-1212	3/4	1-1/16 - 12



**Male
O-Ring Boss
(Swivel)**

PART No.	Hose I.D.	O-Ring
SC643SW-68	3/8	3/4 - 16
SC643SW-88	1/2	3/4 - 16
SC643SW-810	1/2	7/8 - 14



**Male O-Ring
Face Seal**

PART No.	Hose I.D.	ORFS
SC653-66	3/8	11/16 - 16
SC653-68	3/8	13/16 - 16
SC653-88	1/2	13/16 - 16
SC653-810	1/2	1 - 14
SC653-1212	3/4	1-3/16 - 12



**Female O-Ring
Face Seal
(Swivel)**

PART No.	Hose I.D.	ORFS
SC658-44	1/4	9/16 - 18
SC658-46	1/4	11/16 - 16
SC658-66	3/8	11/16 - 16
SC658-68	3/8	13/16 - 16
SC658-88	1/2	13/16 - 16
SC658-810	1/2	1 - 14
SC658-1010	5/8	1 - 14
SC658-1012	5/8	1-3/16 - 12
SC658-1212	3/4	1-3/16 - 12
SC658-1616	1	1-7/16 - 12

STEEL ONE PIECE CRIMP HOSE ENDS (COMPRESSION STYLE)



FOR USE WITH S.A.E. 100R1-AT, 100R2-AT, T1SN, T2SN, 100R3, 100R4, 100R16 AND
100R17 HOSE (Pages 107 - 109, 111)

**ITEMS SHOWN ARE INTERCHANGEABLE WITH WEATHERHEAD "U" SERIES COUPLINGS.
(They are Fairview Equivalents and are NOT WeatherHead Original Product.)**

B



**Tube Repair
(Flareless)**

PART No.	Hose I.D.	Tube
SC667-44	1/4	1/4
SC667-65	3/8	5/16
SC667-66	3/8	3/8
SC667-88	1/2	1/2
SC667-810	1/2	5/8
SC667-1212	3/4	3/4

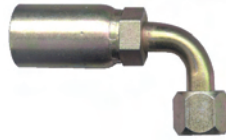

**90° ELBOW
S.A.E. 37°
Female Flare
(Swivel)**

PART No.	Hose I.D.	Tube
SC639-44	1/4	1/4
SC639-45	1/4	5/16
SC639-46	1/4	5/16
SC639-66	3/8	3/8
SC639-68	3/8	1/2
SC639-88	1/2	1/2
SC639-810	1/2	5/8
SC639-1010	5/8	5/8
SC639-1212	3/4	3/4
SC639-1616	1	1



**90° ELBOW
Female O-Ring
Face Seal
(Swivel)**

PART No.	HOSE	ORFS
SC659-44	1/4	9/16 - 18
SC659-46	1/4	11/16 - 16
SC659-66	3/8	11/16 - 16
SC659-68	3/8	13/16 - 16
SC659-88	1/2	13/16 - 16
SC659-810	1/2	1 - 14
SC659-1010	5/8	1 - 14
SC659-1012	5/8	1-3/16 - 12
SC659-1212	3/4	1-3/16 - 12
SC659-1616	1	1-7/16 - 12



**Hose
Splicer**

PART No.	Hose I.D.
SC629-44	1/4
SC629-66	3/8
SC629-88	1/2
SC629-1212	3/4
SC629-1616	1



**90° ELBOW
(LONG STYLE)
S.A.E. 37°
Female Flare
(Swivel)**

PART No.	Hose I.D.	Tube
SC639L-44	1/4	1/4
SC639L-66	3/8	3/8
SC639L-88	1/2	1/2
SC639L-1212	3/4	3/4
SC639L-1616	1	1



**45° ELBOW
S.A.E. 37°
Female Flare
(Swivel)**

PART No.	Hose I.D.	Tube
SC640-44	1/4	1/4
SC640-66	3/8	3/8
SC640-68	3/8	1/2
SC640-88	1/2	1/2
SC640-810	1/2	5/8
SC640-1212	3/4	3/4
SC640-1616	1	1



**British
Standard
Pipe Parallel
Female (Swivel)
(BSPP)**

PART No.	Hose I.D.	Pipe
SCK631BSP-66	3/8	3/8 - 19
SCK631BSP-88	1/2	1/2 - 14
SCK631BSP-1212	3/4	3/4 - 14

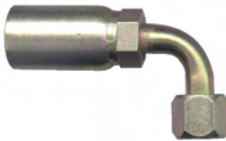

**90° ELBOW
S.A.E. 45°
Female Flare
(Swivel)**

PART No.	Hose I.D.	Tube
SC641-66	3/8	3/8



**45° ELBOW
S.A.E. 45°
Inverted Flare
(Swivel)**

PART No.	Hose I.D.	Tube
SC632-44	1/4	1/4
SC632-66	3/8	3/8

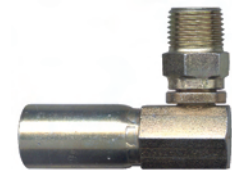

**90° ELBOW
Male Pipe
(Working
Swivel)**

PART No.	Hose I.D.	Pipe
SC616SW-4B	1/4	1/4
SC616SW-6C	3/8	3/8
SC616SW-8D	1/2	1/2

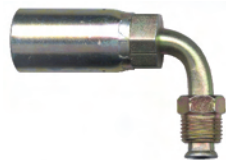

**90° ELBOW
S.A.E. 45°
Inverted
Flare
(Swivel)**

PART No.	Hose I.D.	Tube
SC631-44	1/4	1/4
SC631-45	1/4	5/16
SC631-66	3/8	3/8
SC631-88	1/2	1/2



**45° ELBOW
S.A.E. 45°
Female Flare
(Swivel)**

PART No.	Hose I.D.	Tube
SC642-66	3/8	3/8

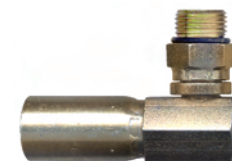

**90° ELBOW
Male O-Ring
Boss
(Working
Swivel)**

PART No.	Hose I.D.	O-Ring
SC636-66	3/8	9/16 - 18
SC636-68	3/8	3/4 - 16
SC636-610	3/8	7/8 - 14
SC636-88	1/2	3/4 - 16
SC636-810	1/2	7/8 - 14

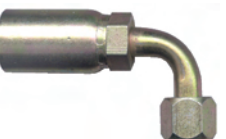

**90° ELBOW
British Standard
Parallel Pipe
Female (Swivel)
(BSPP)**

PART No.	Hose I.D.	BSPP
SCK639BSP-66	3/8	3/8 - 19
SCK639BSP-88	1/2	1/2 - 14



**45° ELBOW
Female O-Ring
Face Seal
(Swivel)**

PART No.	Hose I.D.	ORFS
SC650-44	1/4	9/16 - 18
SC650-46	1/4	11/16 - 16
SC650-66	3/8	11/16 - 16
SC650-88	1/2	13/16 - 16
SC650-810	1/2	1 - 14

STEEL ONE PIECE CRIMP HOSE ENDS (COMPRESSION STYLE)

FOR USE WITH S.A.E. 100R1-AT, 100R2-AT, T1SN, T2SN, 100R16 AND
100R17 HOSE (Pages 107 - 108, 111)

**ITEMS SHOWN ARE INTERCHANGEABLE WITH PARKER "43" SERIES COUPLINGS.
(They are Fairview Equivalents and are NOT PARKER Original Product.)**

B



Male Pipe

PART No.	Hose I.D.	Pipe
SC925-4A	1/4	1/8
SC925-4B	1/4	1/4
SC925-4C	1/4	3/8
SC925-4D	1/4	1/2
SC925-6B	3/8	1/4
SC925-6C	3/8	3/8
SC925-6D	3/8	1/2
SC925-8C	1/2	3/8
SC925-8D	1/2	1/2
SC925-8E	1/2	3/4
SC925-10D	5/8	1/2
SC925-12D	3/4	1/2
SC925-12E	3/4	3/4
SC925-12H	3/4	1
SC925-16E	1	3/4
SC925-16H	1	1
SC925-20J	1-1/4	1-1/4



**Male Pipe
(Working Swivel)**

PART No.	Hose I.D.	Pipe
SC925SW-4B	1/4	1/4
SC925SW-6B	3/8	1/4
SC925SW-6C	3/8	3/8
SC925SW-6D	3/8	1/2
SC925SW-8D	1/2	1/2
SC925SW-12E	3/4	3/4
SC925SW-16H	1	1



Female Pipe

PART No.	Hose I.D.	Pipe
SC926-4B	1/4	1/4
SC926-6B	3/8	1/4
SC926-6C	3/8	3/8
SC926-8D	1/2	1/2



**S.A.E. 37°
Male Flare**

PART No.	Hose I.D.	Tube
SC937-44	1/4	1/4
SC937-45	1/4	5/16
SC937-46	1/4	3/8
SC937-66	3/8	3/8
SC937-68	3/8	1/2
SC937-610	3/8	5/8
SC937-88	1/2	1/2
SC937-810	1/2	5/8
SC937-812	1/2	3/4
SC937-1010	5/8	5/8
SC937-1012	5/8	3/4
SC937-1212	3/4	3/4
SC937-1216	3/4	1
SC937-1616	1	1



**S.A.E. 37°
Female Flare
(Swivel)**

PART No.	Hose I.D.	Tube
SC938-44	1/4	1/4
SC938-45	1/4	5/16
SC938-46	1/4	3/8
SC938-64	3/8	1/4
SC938-66	3/8	3/8
SC938-68	3/8	1/2
SC938-610	3/8	5/8
SC938-86	1/2	3/8
SC938-88	1/2	1/2
SC938-810	1/2	5/8
SC938-812	1/2	3/4
SC938-108	5/8	1/2
SC938-1010	5/8	5/8
SC938-1012	5/8	3/4
SC938-1210	3/4	5/8
SC938-1212	3/4	3/4
SC938-1214	3/4	7/8
SC938-1216	3/4	1
SC938-1612	1	3/4
SC938-1616	1	1
SC938-2020	1-1/4	1-1/4



**Female
NPSM Pipe
(Swivel)**

PART No.	Hose I.D.	Pipe
SC926SW-4B	1/4	1/4
SC926SW-6C	3/8	3/8
SC926SW-8D	1/2	1/2
SC926SW-12E	3/4	3/4
SC926SW-16H	1	1



**Female
(Grease Tap)**

PART No.	Hose I.D.	Thread
SC926GT-4A	1/4	1/2 - 27



**S.A.E. 45°
Female Flare
(Swivel)**

PART No.	Hose I.D.	Tube
SC928-66	3/8	3/8
SC928-1212	3/4	3/4



**S.A.E. 45°
Inverted Flare
(Swivel)**

PART No.	Hose I.D.	Tube
SC935-44	1/4	1/4
SC935-66	3/8	3/8



**Male
O-Ring Boss**

PART No.	Hose I.D.	O-Ring
SC943-44	1/4	7/16 - 18
SC943-46	1/4	9/16 - 18
SC943-66	3/8	9/16 - 18
SC943-68	3/8	3/4 - 16
SC943-88	1/2	3/4 - 16
SC943-810	1/2	7/8 - 14
SC943-1212	3/4	1-1/16 - 12



**Male
O-Ring Boss
(Working Swivel)**

PART No.	Hose I.D.	O-Ring
SC943SW-44	1/4	7/16 - 18
SC943SW-68	3/8	3/4 - 16
SC943SW-88	1/2	3/4 - 16



**Male
O-Ring Face
Seal**

PART No.	Hose I.D.	ORFS
SC953-44	1/4	9/16 - 18
SC953-66	3/8	11/16 - 16
SC953-68	3/8	13/16 - 16
SC953-88	1/2	13/16 - 16
SC953-810	1/2	1 - 14
SC953-1010	5/8	1 - 14
SC953-1212	3/4	1-3/16 - 12

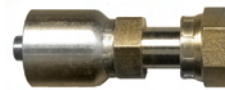

**Female
O-Ring Face
Seal
(Swivel)**

PART No.	Hose I.D.	ORFS
SC958-44	1/4	9/16 - 18
SC958-46	1/4	11/16 - 16
SC958-66	3/8	11/16 - 16
SC958-68	3/8	13/16 - 16
SC958-88	1/2	13/16 - 16
SC958-810	1/2	1 - 14
SC958-1010	5/8	1 - 14
SC958-1012	5/8	1-3/16 - 12
SC958-1212	3/4	1-3/16 - 12
SC958-1616	1	1-7/16 - 12



**Tube
Repair
(Flareless)**

PART No.	Hose I.D.	Tube
SC967-65	3/8	5/16
SC967-66	3/8	3/8
SC967-88	1/2	1/2
SC967-810	1/2	5/8
SC967-1212	3/4	3/4

STEEL ONE PIECE CRIMP HOSE ENDS (BITE-TO-THE-WIRE)



FOR USE WITH S.A.E. 100R1-AT, 100R2-AT, T1SN, T2SN, 100R16 AND
100R17 HOSE (Pages 107 - 108, 111)

**ITEMS SHOWN ARE INTERCHANGEABLE WITH PARKER "43" SERIES COUPLINGS.
(They are Fairview Equivalents and are NOT PARKER Original Product.)**



**Hose
Splicer**

PART No.	Hose I.D.
SC929-44	1/4
SC929-66	3/8
SC929-88	1/2
SC929-1212	3/4



**British
Standard
Pipe Parallel
Female (Swivel)
(BSPP)**

PART No.	Hose I.D.	Pipe
SC931BSP-44	1/4	1/4 - 19
SC931BSP-66	3/8	3/8 - 19
SC931BSP-88	1/2	1/2 - 14



**Female 30°
JIS Flare
Parallel Pipe
Female
(Swivel)**

PART No.	Hose I.D.	Pipe
SC931JIS-66	3/8	3/8
SC931JIS-1212	5/8	5/8



**Universal
Seat
(Light) Female
(Swivel) (DIN)**

PART No.	Hose I.D.	Tube	Metric
SC931LM-4-14	1/4	8 MM	M14X1.5
SC931LM-6-16	3/8	10 MM	M16X1.5
SC931LM-6-18	3/8	12 MM	M18X1.5
SC931LM-8-22	1/2	15 MM	M22X1.5



**90° ELBOW
Male Pipe
(Working
Swivel)**

PART No.	Hose I.D.	Pipe
SC916SW-4B	1/4	1/4
SC916SW-6C	3/8	3/8
SC916SW-8D	1/2	1/2



**90° ELBOW
Male O-Ring
Boss
(Working
Swivel)**

PART No.	Hose I.D.	O-Ring
SC936-66	3/8	9/16 - 18
SC936-68	3/8	3/4 - 16
SC936-88	1/2	3/4 - 16
SC936-810	1/2	7/8 - 14



**90° ELBOW
S.A.E. 37°
Female Flare
(Swivel)**

PART No.	Hose I.D.	Tube
SC939-44	1/4	1/4
SC939-46	1/4	3/8
SC939-66	3/8	3/8
SC939-68	3/8	1/2
SC939-88	1/2	1/2
SC939-810	1/2	5/8
SC939-1010	5/8	5/8
SC939-1212	3/4	3/4
SC939-1616	1	1



**90° ELBOW
(LONG STYLE)
S.A.E. 37°
Female Flare
(Swivel)**

PART No.	Hose I.D.	Tube
SC939L-44	1/4	1/4
SC939L-46	1/4	3/8
SC939L-66	3/8	3/8
SC939L-88	1/2	1/2
SC939L-810	1/2	5/8
SC939L-1212	3/4	3/4
SC939L-1616	1	1



**90° ELBOW
S.A.E. 45°
Female Flare
(Swivel)**

PART No.	Hose I.D.	Tube
SC941-66	3/8	3/8



**90° ELBOW
S.A.E. 45°
Inverted
Flare
(Swivel)**

PART No.	Hose I.D.	Tube
SC931-44	1/4	1/4
SC931-66	3/8	3/8



**90° ELBOW
Female O-Ring
Face Seal
(Swivel)**

PART No.	HOSE	ORFS
SC959-44	1/4	9/16 - 18
SC959-46	1/4	11/16 - 16
SC959-66	3/8	11/16 - 16
SC959-68	3/8	13/16 - 16
SC959-88	1/2	13/16 - 16
SC959-810	1/2	1 - 14
SC959-1010	5/8	1 - 14
SC959-1212	3/4	1-3/16 - 12
SC959-1616	1	1-7/16 - 12



**90° ELBOW
British Standard
Pipe Parallel
Female (Swivel)
(BSPP)**

PART No.	Hose I.D.	Pipe
SC939BSP-44	1/4	1/4 - 19
SC939BSP-66	3/8	3/8 - 19
SC939BSP-88	1/2	1/2 - 14



**45° ELBOW
S.A.E. 37°
Female Flare
(Swivel)**

PART No.	Hose I.D.	Tube
SC940-44	1/4	1/4
SC940-66	3/8	3/8
SC940-68	3/8	1/2
SC940-88	1/2	1/2
SC940-810	1/2	5/8
SC940-1010	5/8	5/8
SC940-1212	3/4	3/4
SC940-1616	1	1



**45° ELBOW
Female O-Ring
Face Seal
(Swivel)**

PART No.	Hose I.D.	ORFS
SC950-44	1/4	9/16 - 18
SC950-46	1/4	11/16 - 16
SC950-66	3/8	11/16 - 16
SC950-68	3/8	13/16 - 16
SC950-88	1/2	13/16 - 16
SC950-810	1/2	1 - 14
SC950-1010	5/8	1 - 14
SC950-1212	3/4	1-3/16 - 12
SC950-1616	1	1-7/16 - 12



**45° ELBOW
British Standard
Pipe Parallel
Female (Swivel)
(BSPP)**

PART No.	Hose I.D.	Pipe
SC940BSP-44	1/4	1/4 - 19
SC940BSP-66	3/8	3/8 - 19

B

FOR USE WITH S.A.E. 100R12 HOSE (Page 110)

**ITEMS SHOWN ARE INTERCHANGEABLE WITH PARKER "71" SERIES COUPLINGS.
(They are Fairview Equivalents and are NOT PARKER Original Product.)**

B



Male Pipe

PART No.	Hose I.D.	Pipe
SCT925MS-8D	1/2	1/2
SCT925MS-12E	3/4	3/4
SCT925MS-16H	1	1
SCT925MS-20J	1-1/4	1-1/4
SCT925MS-24K	1-1/2	1-1/2



**Split Flange
Code 61**

PART No.	Hose I.D.	Flange
SCT900MS-1212	3/4	3/4
SCT900MS-1616	1	1
SCT900MS-2020	1-1/4	1-1/4

Code 62 Available SCT900MS62 in series.



**90° ELBOW
S.A.E. 37°
Female Flare
(Swivel)**

PART No.	Hose I.D.	Tube
SCT939MS-88	1/2	1/2
SCT939MS-810	1/2	5/8
SCT939MS-1212	3/4	3/4
SCT939MS-1616	1	1
SCT939MS-2020	1-1/4	1-1/4



**S.A.E. 37°
Male Flare**

PART No.	Hose I.D.	Tube
SCT937MS-88	1/2	1/2
SCT937MS-810	1/2	5/8
SCT937MS-1212	3/4	3/4
SCT937MS-1616	1	1
SCT937MS-2020	1-1/4	1-1/4



**45° ELBOW
S.A.E. 37°
Female Flare
(Swivel)**

PART No.	Hose I.D.	Tube
SCT940MS-88	1/2	1/2
SCT940MS-1212	3/4	3/4
SCT940MS-1616	1	1
SCT940MS-2020	1-1/4	1-1/4

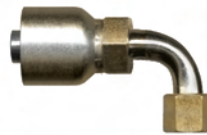

**90° ELBOW
Female O-Ring
Face Seal
(Swivel)**

PART No.	Hose I.D.	ORFS
SCT959MS-88	1/2	13/16 - 16
SCT959MS-810	1/2	1 - 14
SCT959MS-1212	3/4	1-3/16 - 12
SCT959MS-1616	1	1-7/16 - 12



**S.A.E. 37°
Female Flare
(Swivel)**

PART No.	Hose I.D.	Tube
SCT938MS-88	1/2	1/2
SCT938MS-810	1/2	5/8
SCT938MS-1212	3/4	3/4
SCT938MS-1616	1	1
SCT938MS-2020	1-1/4	1-1/4
SCT938MS-2424	1-1/2	1-1/2



**90° ELBOW
Split Flange
Code 61**

PART No.	Hose I.D.	Flange
SCT990MS-1212	3/4	3/4
SCT990MS-1216	3/4	1
SCT990MS-1616	1	1
SCT990MS-1620	1	1-1/4
SCT990MS-2020	1-1/4	1-1/4

Code 62 Available SCT990MS62 series.



**Female O-Ring
Face Seal
(Swivel)**

PART No.	Hose I.D.	ORFS
SCT958MS-88	1/2	13/16 - 16
SCT958MS-810	1/2	1 - 14
SCT958MS-1212	3/4	1-3/16 - 12
SCT958MS-1616	1	1-7/16 - 12
SCT958MS-2020	1-1/4	1-11/16 - 12



**45° ELBOW
Female O-Ring
Face Seal
(Swivel)**

PART No.	Hose I.D.	ORFS
SCT950MS-88	3/4	13/16 - 16
SCT950MS-1212	3/4	1-3/16 - 12
SCT950MS-1616	1	1-7/16 - 12



**British Standard
Pipe Parallel
Female
60° Cone
(Swivel)**

PART No.	Hose I.D.	Thread
SCT931BSPMS-1212	3/4	3/4 - 14
SCT931BSPMS-1616	1	1 - 11

STEEL ONE PIECE CRIMP HOSE ENDS (BITE-TO-THE-WIRE)



FOR USE WITH S.A.E. 100R12 HOSE AND S.A.E. 100R2 (Pages 107 - 108, 110)

**ITEMS SHOWN ARE INTERCHANGEABLE WITH WEATHERHEAD "430U" SERIES COUPLINGS.
(They are Fairview Equivalents and are NOT WeatherHead Original Product.)**



**S.A.E. 37°
Female Flare
(Swivel)**

PART No.	Hose I.D.	Tube
SCTGW638-88	1/2	1/2
SCTGW638-1212	3/4	3/4
SCTGW638-1616	1	1
SCTGW638-2020	1-1/4	1-1/4



**Female
O-Ring Face
Seal
(Swivel)**

PART No.	Hose I.D.	ORFS
SCTGW658-88	1/2	13/16 - 16
SCTGW658-1212	3/4	1-3/16-12
SCTGW658-1616	1	1-7/16-12



**90° ELBOW
S.A.E. 37°
Female Flare
(Swivel)**

PART No.	Hose I.D.	Tube
SCTGW639-1212	3/4	3/4
SCTGW639-1616	1	1

FOR USE WITH S.A.E. 100R5 HOSE (Page 100)

**ITEMS SHOWN ARE INTERCHANGEABLE WITH WEATHERHEAD "069E" SERIES COUPLINGS.
(THEY ARE FAIRVIEW EQUIVALENTS AND ARE NOT WEATHERHEAD ORIGINAL PRODUCT.)**



**Male
Pipe**

PART No.	Nominal Hose I.D.	Pipe
SCW525-4A	1/4	1/8
SCW525-4B	1/4	1/4
SCW525-5B	5/16	1/4
SCW525-6B	3/8	1/4
SCW525-6C	3/8	3/8
SCW525-8C	1/2	3/8
SCW525-8D	1/2	1/2
SCW525-10D	5/8	1/2
SCW525-12E	3/4	3/4
SCW525-16H	1	1
SCW525-20J	1-1/4	1-1/4
SCW525-32M	2	2



**S.A.E. 37°
Female Flare
(Swivel)**

PART No.	Nominal Hose I.D.	Tube
SCW538-44	1/4	1/4
SCW538-55	5/16	5/16
SCW538-66	3/8	3/8
SCW538-68	3/8	1/2
SCW538-88	1/2	1/2
SCW538-108	5/8	1/2
SCW538-1010	5/8	5/8
SCW538-1212	3/4	3/4
SCW538-1616	1	1
SCW538-2020	1-1/4	1-1/4
SCW538-3232	2	2



**45° ELBOW
S.A.E. 37°
Female Flare
(Swivel)**

PART No.	Nominal Hose I.D.	Tube
SCW540-44	1/4	1/4
SCW540-55	5/16	5/16
SCW540-66	3/8	3/8
SCW540-88	1/2	1/2
SCW540-1010	5/8	5/8



**S.A.E. 45°
Female Flare
(Swivel)**

PART No.	Nominal Hose I.D.	Tube
SCW528-66	3/8	3/8
SCW528-1212	3/4	3/4



**90° ELBOW
S.A.E. 37°
Female Flare
(Swivel)**

PART No.	Nominal Hose I.D.	Tube
SCW539-44	1/4	1/4
SCW539-55	5/16	5/16
SCW539-66	3/8	3/8
SCW539-88	1/2	1/2
SCW539-1010	5/8	5/8

All hose ends should be installed by Qualified Technicians, pressure tested and crimped O.D.s confirmed prior to use.

B

FOR USE WITH S.A.E. 100R5 HOSE (Page 100)

B

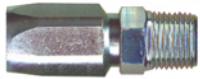

Male Pipe

PART No.	Nominal Hose I.D.	Pipe
SR525-4A	1/4	1/8
SR525-4B	1/4	1/4
SR525-5B	5/16	1/4
SR525-6B	3/8	1/4
SR525-6C	3/8	3/8
SR525-8C	1/2	3/8
SR525-8D	1/2	1/2
SR525-10D	5/8	1/2
SR525-10E	5/8	3/4
SR525-12E	3/4	3/4
SR525-16H	1	1
SR525-20J	1-1/4	1-1/4
SR525-24K	1-1/2	1-1/2
SR525-32M	2	2

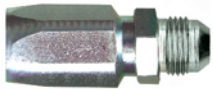

S.A.E. 45° Male Flare

PART No.	Nominal Hose I.D.	Tube
SR527-44	1/4	1/4
SR527-55	5/16	5/16
SR527-66	3/8	3/8
SR527-88	1/2	1/2
SR527-1010	5/8	5/8
SR527-1212	3/4	3/4

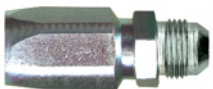

S.A.E. 37° MALE FLARE

PART No.	Nominal Hose I.D.	Tube
SR537-44	1/4	1/4
SR537-66	3/8	3/8
SR537-88	1/2	1/2
SR537-1010	5/8	5/8
SR537-1212	3/4	3/4
SR537-1616	1	1

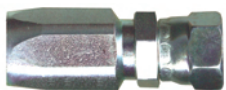

S.A.E. 45° Female Flare (Swivel)

PART No.	Nominal Hose I.D.	Tube
SR528-44	1/4	1/4
SR528-55	5/16	5/16
SR528-66	3/8	3/8
SR528-88	1/2	1/2
SR528-1010	5/8	5/8
SR528-1212	3/4	3/4

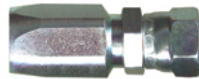

S.A.E. 37° Female Flare (Swivel) Two Piece Design

PART No.	Nominal Hose I.D.	Tube
SR538-44	1/4	1/4
SR538-55	5/16	5/16
SR538-66	3/8	3/8
SR538-88	1/2	1/2
SR538-1010	5/8	5/8
SR538-1212	3/4	3/4
SR538-1616	1	1
SR538-2020	1-1/4	1-1/4
SR538-2424	1-1/2	1-1/2
SR538-3232	2	2



S.A.E. 45° Inverted Flare (Swivel)

PART No.	Nominal Hose I.D.	Tube
SR535-44	1/4	1/4
SR535-66	3/8	3/8

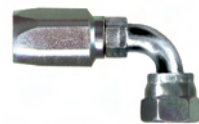

90° ELBOW S.A.E. 37° Female Flare (Swivel)

PART No.	Nominal Hose I.D.	Tube
SR539-44	1/4	1/4
SR539-55	5/16	5/16
SR539-66	3/8	3/8
SR539-88	1/2	1/2
SR539-1010	5/8	5/8
SR539-1212	3/4	3/4
SR539-1616	1	1
SR539-2020	1-1/4	1-1/4



90° ELBOW (LONG STYLE) S.A.E. 37° Female Flare (Swivel)

PART No.	Nominal Hose I.D.	Tube
SR539L-66	3/8	3/8
SR539L-88	1/2	1/2



90° ELBOW S.A.E. 45° Female Flare (Swivel)

PART No.	Nominal Hose I.D.	Tube
SR541-44	1/4	1/4
SR541-66	3/8	3/8
SR541-1212	3/4	3/4



90° ELBOW S.A.E. 45° Inverted Flare (Swivel)

PART No.	Nominal Hose I.D.	Tube
SR595-66	3/8	3/8



45° ELBOW S.A.E. 37° Female Flare (Swivel)

PART No.	Nominal Hose I.D.	Tube
SR540-44	1/4	1/4
SR540-66	3/8	3/8
SR540-88	1/2	1/2
SR540-1010	5/8	5/8
SR540-1212	3/4	3/4
SR540-1616	1	1

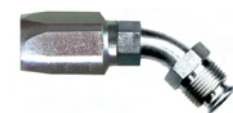

45° ELBOW S.A.E. 45° Inverted Flare (Swivel)

PART No.	Nominal Hose I.D.	Tube
SR545-55	5/16	5/16
SR545-66	3/8	3/8
SR545-88	1/2	1/2

STEEL REUSABLE HOSE ENDS



B

FOR USE WITH: S.A.E. 100R1-AT (NON SKIVE) HOSE

FOR USE WITH: S.A.E. 100R2-AT (NON SKIVE) HOSE



Male Pipe

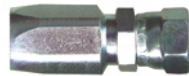

S.A.E. 37° Female Flare (Swivel)



Male Pipe



S.A.E. 37° Female Flare (Swivel)

PART No.	Hose I.D.	Pipe
SRT125-4B	1/4	1/4
SRT125-6C	3/8	3/8
SRT125-8D	1/2	1/2

PART No.	Hose I.D.	Tube
SRT138-44 *	1/4	1/4
SRT138-66 *	3/8	3/8
SRT138-88 *	1/2	1/2

PART No.	Hose I.D.	Pipe
SRT225-4B	1/4	1/4
SRT225-6C	3/8	3/8
SRT225-8D	1/2	1/2

PART No.	Hose I.D.	Tube
SRT238-44 *	1/4	1/4
SRT238-66 *	3/8	3/8
SRT238-88 *	1/2	1/2
SRT238-1212 *	3/4	3/4

* Item is available in stainless steel. Change prefix to "SS" (eg. SSRT238-44) *

ASSEMBLY INSTRUCTIONS FOR NON-SKIVE S.A.E. 100R1, 100R2 & 100R5 STEEL REUSABLE HOSE ENDS

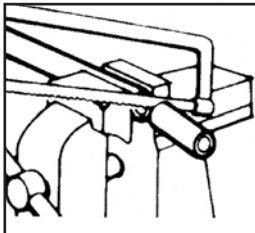

STEP 1

Using a fine-toothed saw or cut-off wheel, cut the hose square to the desired length. Clean hose with air pressure to remove dust particles.



STEP 2

Dip the end of the hose into a lubricant. Use a light viscosity oil (S.A.E. 10 or 20)

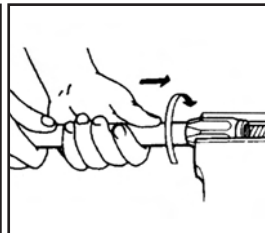

STEP 3

Turn the hose counterclockwise into the socket until the hose bottoms.

IMPORTANT: Back the hose off at least 1/2 turn, check to be sure that there is a gap of 1/32" to 1/16" between the hose end and the shoulder on the inside of the socket. Failure to provide this gap may cause cracking of the socket.

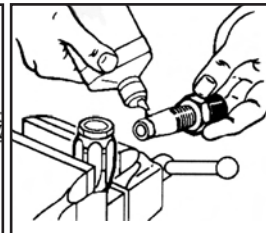

STEP 4

Dip the nipple end into a lubricant. Refer to step 2. (Light weight oil S.A.E. 10 or 20).



STEP 5

Turn the stem clockwise into the hose and socket until the stem hex shoulders against the ferrule.

CAUTION: Larger diameter hose is subject to "Neck Down" during cut-off operations. This condition does not allow the nipple to be pushed into the hose. When this happens, that portion of the hose I.D. must be chamfered with a sharp knife, just enough to allow the nipple to be pushed into the hose. Be sure to remove the cut-off rubber from the assembly.

ONE PIECE CRIMP ENDS FOR PTFE HOSE FOR USE WITH S.A.E. 100R14 SMOOTH BORE PTFE HOSE (Page 102) ALL WETTED PARTS ARE BRASS.



Male Pipe

PART No.	Nominal Hose I.D.	Pipe
SCT425-4A	1/4	1/8
SCT425-4B	1/4	1/4
SCT425-6C	3/8	3/8
SCT425-8D	1/2	1/2
SCT425-10D	5/8	1/2
SCT425-12E	3/4	3/4



S.A.E. 37° Female Flare (Swivel)

PART No.	Nominal Hose I.D.	Tube
SCT438-44	1/4	1/4
SCT438-66	1/4	1/4
SCT438-88	1/4	1/4
SCT438-1010	1/4	1/4
SCT438-1212	1/4	1/4

**FOR USE WITH S.A.E. 100R14 SMOOTH BORE PTFE HOSE (Page 102)
ALL WETTED PARTS ARE BRASS**

B



Male Pipe

PART No.	Nominal Hose I.D.	Pipe
SR425-4A	1/4	1/8
SR425-4B	1/4	1/4
SR425-5B	5/16	1/4
SR425-6B	3/8	1/4
SR425-6C	3/8	3/8
SR425-8C	1/2	3/8
SR425-8D	1/2	1/2
SR425-10D	5/8	1/2
SR425-12E	3/4	3/4
SR425-16H	1	1



**Female Swivel
37° J.I.C.
Flare**

PART No.	Nominal Hose I.D.	Tube
SR438-44	1/4	1/4
SR438-55	5/16	5/16
SR438-66	3/8	3/8
SR438-88	1/2	1/2
SR438-1010	5/8	5/8
SR438-1212	3/4	3/4
SR438-1616	1	1
SR438-2020	1-1/4	1-1/4

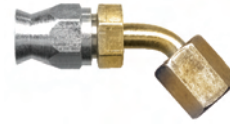

**45° ELBOW
S.A.E. 37°
Female Flare
(Swivel)**

PART No.	Nominal Hose I.D.	Tube
SR440-55	5/16	5/16
SR440-88	1/2	1/2



**Replacement
Sleeve**

PART No.	Nominal Hose I.D.
SR4S-4	1/4
SR4S-6	3/8
SR4S-8	1/2
SR4S-10	5/8
SR4S-12	3/4
SR4S-16	1



**Female Swivel
45° S.A.E.
Flare**

PART No.	Nominal Hose I.D.	Tube
SR428-44	1/4	1/4
SR428-55	5/16	5/16
SR428-66	3/8	3/8
SR428-88	1/2	1/2
SR428-1010	5/8	5/8
SR428-1212	3/4	3/4



**Straight
Tube**

Used in conjunction with an 1161 nut & 1160 sleeve.

PART No.	Nominal Hose I.D.	Tube
SR462-1010	5/8	5/8
SR462-1212	3/4	3/4



**D.O.T.
Air Brake
Compression**

PART No.	Nominal Hose I.D.	Tube
SR468-1010	5/8	5/8



**D.O.T.
Air Brake
Sleeve**

PART No.	Tube
1160-10	5/8
1160-12	3/4

For use with metal tube.

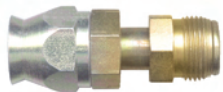

**S.A.E. Male
Inverted
Flare
Swivel**

PART No.	Nominal Hose I.D.	Tube
SR435-55	5/16	5/16
SR435-66	3/8	3/8

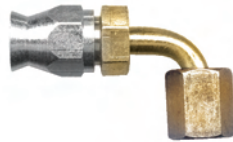

**90° ELBOW
S.A.E. 37°
Female Flare
(Swivel)**

PART No.	Nominal Hose I.D.	Tube
SR439-44	1/4	1/4
SR439-66	3/8	3/8
SR439-88	1/2	1/2



**D.O.T.
Air Brake
Nut**

PART No.	Tube
1161-10	5/8
1161-12	3/4

For use with metal tube.

STAINLESS STEEL AVAILABLE
UPON REQUEST (SSR4 Series •)

PTFE REUSABLE FITTINGS ASSEMBLY INSTRUCTIONS

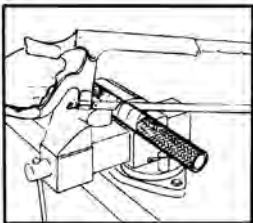

Step 1
Wrap masking tape around hose at desired length and cut square with fine-tooth hack saw. Trim any loose wires and slip two shells on back to back, placing them about 3" from each end of hose.

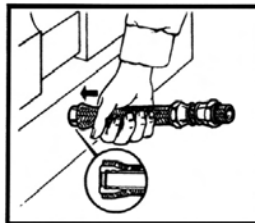

Step 2
Use a flat surface to push the sleeve over the tube underneath the wire until the tube stock butts against the inside shoulder of the sleeve.

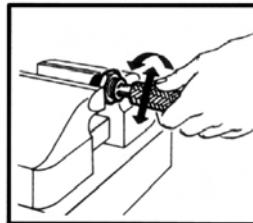

Step 3
Mount stem hex in vise. Work the hose bore over the stem to size tube.

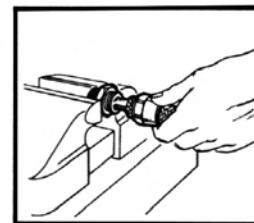

Step 4
Lubricate stem and shell threads. Push hose onto stem with twisting motion until hose seats against stem chamfer. Push shell forward and hand start threading.

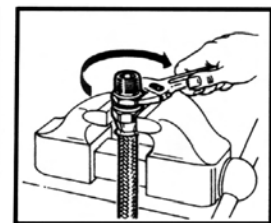







Step 5
Wrench tighten stem until clearance with shell is 1/32" or less. Clean, inspect and test.

STEEL CRIMP HOSE ENDS



FOR USE WITH S.A.E. 100R7 HOSE (Page 110)

 <p>Male Pipe</p>			 <p>Female NPSM Pipe (Swivel)</p>			<p>STEEL REUSABLE HOSE ENDS</p>		
<p>PART No.</p> <p>SC725-2A SC725-3A SC725-4B</p>	<p>Hose I.D.</p> <p>1/8 3/16 1/4</p>	<p>Pipe</p> <p>1/8 1/8 1/4</p>	<p>PART No.</p> <p>SC726SW-4B</p>	<p>Hose I.D.</p> <p>1/4</p>	<p>Pipe</p> <p>1/4</p>	 <p>S.A.E. Female Flare (Swivel)</p>		
 <p>Male Pipe (Swivel)</p>			 <p>S.A.E. Female Flare (Swivel)</p>			 <p>Male Pipe (Swivel)</p>		
<p>PART No.</p> <p>SC725SW-2A</p>	<p>Hose I.D.</p> <p>1/8</p>	<p>Pipe</p> <p>1/8</p>	<p>PART No.</p> <p>SC738-22 SC738-23 SC738-24 SC738-34 SC738-44 SC738-46</p>	<p>Hose I.D.</p> <p>1/8 1/8 1/8 3/16 1/4 1/4</p>	<p>Tube</p> <p>1/8 3/16 1/4 1/4 1/4 3/8</p>	<p>PART No.</p> <p>SR738-24</p>		
<p>Hose I.D.</p> <p>1/8</p>			<p>Tube</p> <p>1/8</p>			<p>Hose I.D.</p> <p>1/8</p>		
<p>Pipe</p> <p>1/8</p>			<p>Pipe</p> <p>1/8</p>			<p>Tube</p> <p>1/4</p>		

B

CRIMP SPECIFICATIONS FOR Accutek™ PERMANENTLY ATTACHED HOSE ENDS





All Hydraulic Assemblies should be pressure tested prior to use.

NOTE: Fairview's Accutek™ 100R7 hose ends are not to be swaged.

HOSE	DESCRIPTION	DASH SIZE	HOSE I.D.	Crimp DIA. SC700 Series
HR7	S.A.E. 100R7	-2	1/8	0.3650
		-3	3/16	0.5100
		-4	1/4	0.5550

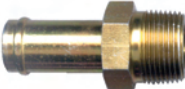
IMPORTANT: This reference chart is provided by Fairview Fittings & Manufacturing for convenience only. The information contained herein cannot be guaranteed because conditions of use are beyond our control, such as variances in hose outside diameters. This document should not be substituted for the judgement of a qualified professional. Assemblies should be tested prior to installation. The user of this information assumes all risk associated with its use.

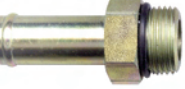
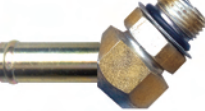
STEEL HOSE INSERTS FOR USE WITH 100R4 HOSE (Page 109)

 <p>CONNECTOR Hose Insert To Male Pipe</p>			 <p>90° ELBOW Hose Insert To Male Pipe</p>			 <p>45° ELBOW Hose Insert To Male Pipe</p>		
<p>PART No.</p> <p>S1125-10C S1125-10D S1125-12E S1125-16E</p>	<p>Hose I.D.</p> <p>5/8 5/8 3/4 1</p>	<p>Pipe</p> <p>3/8 1/2 3/4 3/4</p>	<p>PART No.</p> <p>S1139-10D S1139-12E S1139-16H</p>	<p>Hose I.D.</p> <p>5/8 3/4 1</p>	<p>Pipe</p> <p>1/2 3/4 1</p>	<p>PART No.</p> <p>S1140-10D S1140-12E</p>	<p>Hose I.D.</p> <p>5/8 3/4</p>	<p>Pipe</p> <p>1/2 3/4</p>
 <p>CONNECTOR Hose Insert To Male O-Ring</p>			 <p>45° ELBOW Hose Insert To Male O-Ring</p>			 <p>90° ELBOW Hose Insert To Male O-Ring</p>		
<p>PART No.</p> <p>SO1125-6 SO1125-1210 SO1125-1216 SO1125-16 SO1125-20 SO1125-24 SO1125-2420</p>	<p>Hose I.D.</p> <p>3/8 3/4 3/4 1 1-1/4 1-1/2 1-1/2</p>	<p>O-Ring</p> <p>9/16 - 18 7/8 - 14 1-5/16 - 12 1-5/16 - 12 1-5/8 - 12 7/16 - 20 1-5/8 - 12</p>	<p>PART No.</p> <p>SO1140-16</p>	<p>Hose I.D.</p> <p>1</p>	<p>O-Ring</p> <p>1-5/16 - 12</p>	<p>PART No.</p> <p>SO1139-4 SO1139-6 SO1139-8 SO1139-16 SO1139-1612</p>	<p>Hose I.D.</p> <p>1/4 3/8 1/2 1 1</p>	<p>O-Ring</p> <p>7/16 - 20 9/16 - 18 3/4 - 16 1-5/16 - 12 1-1/16 - 12</p>

STEEL CRIMP HOSE ENDS

FOR USE WITH SEWER CLEANING HOSE (Page 90)



Male Pipe



Splicer

PART No.	Hose I.D.	Pipe
SCH25-8D	1/2	1/2
SCH25-12E	3/4	3/4
SCH25-16H	1	1

PART No.	Hose I.D.
SCH29-88	1/2
SCH29-1212	3/4
SCH29-1616	1

HYDRAULIC CRIMP INSTRUCTIONS

1.

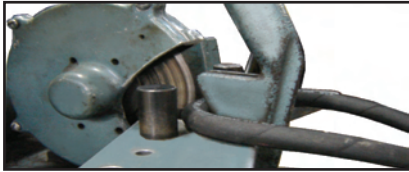

1. Cut hose to length.

Using a cut-off saw or cut-off wheel, cut the hose square to the desired length.

Clean hose with air pressure to remove dust particles.

2.



2. Mark insertion Depth.

Find the insertion depth by measuring the distance from the end of the ferrule to the shoulder of the ferrule.

Using a ruler or by holding the hose next to the ferrule, mark a line on the hose indicating the insertion depth.

3.

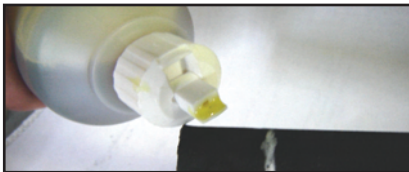

3. Lubricate hose with hose assembly lubricant.

Place a small amount of lubricant on the outer and inner tube portion of the hose. Only use approved hose assembly lubricant. Other non-approved lubricants or oil products may not be compatible with hose material.

4.



4. Insert fitting into hose.

Push the fitting into the hose until the insertion depth mark lines up with the end of the ferrule.

5.

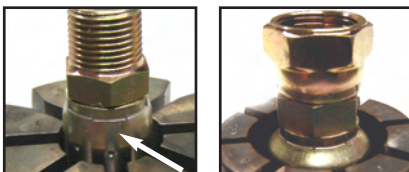

5. Insert Hose into crimping machine.

When crimping Fairview's SC600 and SCK600 Series, align the dots on the ferrule with the top of the dies. (figure 1)

When crimping Fairview's SC500, SC900, SCAJ00, SCT900MS and SCTGW600 Series, align the top shoulder of the ferrule with the top of the dies and crimp the entire ferrule. (figure 2)

6.



6. Check Crimp Diameter.

After crimping verify crimp diameter is within specifications using calipers. Place caliper on the lower or smooth portion of the ferrule. Do not place calipers on any raised ridges on the ferrule. Measure the top, middle and bottom of the ferrule to ensure crimp diameter is correct and uniform.

All Hydraulic Assemblies should be pressure tested prior to use.

FOR USE WITH SY-3R30, SY-3130, SY-37AL, SY-30CT, SY-3440 HOSE
(Pages 115 - 117, 120) (For Crimp Specifications See Page 76)

*** Note:**

For Stainless Steel change SY-3903 prefix to SY-390A. •
Monel couplings available upon request. •



Male Pipe

PART No.	Hose I.D.	Pipe
SY-3903-02102	1/8	1/8
SY-3903-02104	1/8	1/4
SY-3903-03102	3/16	1/8
SY-3903-03104	3/16	1/4
SY-3903-04102	1/4	1/8
SY-3903-04104 *	1/4	1/4
SY-3903-04106	1/4	3/8
SY-3903-05104	5/16	1/4
SY-3903-05106	5/16	3/8
SY-3903-06104	3/8	1/4
SY-3903-06106 *	3/8	3/8
SY-3903-06108	3/8	1/2
SY-3903-08108 *	1/2	1/2
SY-3903-12112	3/4	3/4



S.A.E. 37° Male Flare

PART No.	Hose I.D.	Tube
SY-3903-03504	3/16	1/4
SY-3903-04504	1/4	1/4
SY-3903-04506	1/4	3/8
SY-3903-06506	3/8	3/8
SY-3903-06508	3/8	1/2
SY-3903-08508	1/2	1/2



S.A.E. 37° Female Flare (Swivel)

PART No.	Hose I.D.	Tube
SY-3903-02543	1/8	3/16
SY-3903-02544	1/8	1/4
SY-3903-03544	3/16	1/4
SY-3903-04544 *	1/4	1/4
SY-3903-04545	1/4	5/16
SY-3903-04545-003	1/4	5/16
SY-3903-04546	1/4	3/8
SY-3903-05546	5/16	3/8
SY-3903-06546	3/8	3/8
SY-3903-06548	3/8	1/2
SY-3903-08548 *	1/2	1/2
SY-3903-08550	1/2	5/8
SY-3903-12552	3/4	3/4

* Available in Stainless Steel.

REUSABLE HOSE END

LUBE HOSE END (FIELD ATTACHABLE)



Male Pipe (Working Swivel)

PART No.	Hose I.D.	Pipe
SY-3901-02142	1/8	1/8



Male Pipe (Working Swivel)

PART No.	Hose I.D.	Pipe
SY-3903-02142	1/8	1/8
SY-3903-03144	3/16	1/4
SY-3903-04144	1/4	1/4
SY-3903-05144	5/16	1/4
SY-3903-06146	3/8	3/8
SY-3903-08148	1/2	1/2
SY-3903-12152	3/4	3/4



Female Pipe

PART No.	Hose I.D.	Pipe
SY-3903-04204	1/4	1/4



S.A.E. 45° Female Flare (Swivel)

PART No.	Hose I.D.	Tube
SY-3903-03544	3/16	1/4
SY-3903-04544	1/4	1/4
SY-3903-04545	1/4	5/16
SY-3903-05546	1/4	3/8
SY-3903-06546	3/8	3/8
SY-3903-06548	3/8	1/2
SY-3903-08548	1/2	1/2
SY-3903-08550	1/2	5/8



Female NPSM Pipe (Swivel)

PART No.	Hose I.D.	Pipe
SY-3903-03244	3/16	1/4
SY-3903-04244	1/4	1/4
SY-3903-06246	3/8	3/8
SY-3903-08248	1/2	1/2



Female O-Ring Face Seal (Swivel)

PART No.	Hose I.D.	ORFS
SY-3903-04404	1/4	9/16 - 18
SY-3903-05406	5/16	11/16 - 16
SY-3903-06406	3/8	11/16 - 16
SY-3903-08408	1/2	13/16 - 16



90° ELBOW S.A.E. 37° Female Flare (Swivel)

PART No.	Hose I.D.	Tube
SY-3903-02644	1/8	1/4
SY-3903-03644	3/16	1/4
SY-3903-04644	1/4	1/4
SY-3903-04645	1/4	5/16
SY-3903-06646	3/8	3/8
SY-3903-06648	3/8	1/2
SY-3903-08648	1/2	1/2



45° ELBOW S.A.E. 37° Female Flare (Swivel)

PART No.	Hose I.D.	Tube
SY-3903-06606	3/8	3/8

B



CRIMP SPECIFICATIONS FOR Synflex® PERMANENTLY ATTACHED HOSE ENDS

FOR USE WITH SY-3E80, SY-3R80 AND SY-3440 HOSE
(Pages 115, 118 - 119)

B



Male Pipe

PART No.	Hose I.D.	Pipe
SY-390H-04102	1/4	1/8
SY-390H-04104 *	1/4	1/4
SY-390H-06106 *	3/8	3/8
SY-390H-08108 *	1/2	1/2
SY-390H-12112 *	3/4	3/4

* Available in Stainless Steel.



Male Pipe
(Working
Swivel)

PART No.	Hose I.D.	Pipe
SY-390H-04144	1/4	1/4



S.A.E. 45°
Female Flare
(Swivel)

PART No.	Hose I.D.	Tube
SY-390H-03544	3/16	1/4
SY-390H-04544	1/4	1/4
SY-390H-06548	3/8	1/2
SY-390H-08548	1/2	1/2



S.A.E. 37°
Female Flare
(Swivel)

PART No.	Hose I.D.	Tube
SY-390H-03544 *	3/16	1/4
SY-390H-06546 *	3/8	3/8
SY-390H-06548 *	3/8	1/2
SY-390H-08548 *	1/2	1/2
SY-390H-12552 *	3/4	3/4
SY-390H-16556	1	1

* Available in Stainless Steel.



Female
NPSM Pipe
(Swivel)

PART No.	Hose I.D.	Pipe
SY-390H-04244	1/4	1/4

For Crimp Compatibility
Chart See Below

CRIMP SPECIFICATIONS FOR Synflex® PERMANENTLY ATTACHED HOSE ENDS

IMPORTANT: This reference chart is provided by Fairview Fittings & Manufacturing for convenience only. The information contained herein cannot be guaranteed because conditions of use are beyond our control, such as variances in hose outside diameters. This document should not be substituted for the judgement of a qualified professional. Assemblies should be tested prior to installation. The user of this information assumes all risk associated with its use.

HOSE DESCRIPTION	DASH SIZE	HOSE ID	CRIMP DIA. SY-3903 SERIES	HOSE DESCRIPTION	DASH SIZE	HOSE ID	CRIMP DIA. SY-390H SERIES
3R30 100R3	-03	3/16"	0.441	3E80 SAE100R8 Non-Conductive	-04	1/4"	0.522
	-04	1/4"	0.543		-05	5/16"	0.655
	-05	5/16"	0.630		-06	3/8"	0.770
	-06	3/8"	0.665		-08	1/2"	0.911
	-08	1/2"	0.825		-12	3/4"	1.125
3130 100R7	-02	1/8"	0.358	3R80 SAE100R8	-04	1/4"	0.516
	-03	3/16"	0.478		-05	5/16"	0.655
	-04	1/4"	0.555		-06	3/8"	0.770
	-05	5/16"	0.630		-08	1/2"	0.911
	-06	3/8"	0.694		-12	3/4"	1.125
	-08	1/2"	0.825				
	-12	3/4"	1.080				
	-16	1"	1.340				
3580 100R1/100R7	-04	1/4"	0.548	3440 Moisture Lok	-04	1/4"	0.555
	-06	3/8"	0.680		-06	3/8"	0.675
	-08	1/2"	0.825		-08	1/2"	0.825
	-12	3/4"	1.080		-12	3/4"	1.131
37AL SAE 100R7 Non-Conductive	-03	3/16"	0.478		-16	1"	1.452
	-04	1/4"	0.543				
	-05	5/16"	0.630				
	-06	3/8"	0.675				
	-08	1/2"	0.825				
30CT SAE 100R18	-03	3/16"	0.478				
	-04	1/2"	0.543				
	-05	5/16"	0.630				
	-06	3/8"	0.695				
	-08	1/2"	0.855				

SWAGE / PUSHER CHART FOR SYNFLX ENDS



3R30 PART No.	SWAGE DIE #	MALE PIPE RIGID PART No.	PUSHER FITTINGS	JIC 37 MALE RIGID PART No.	PUSHER FITTINGS	FEMAL NPT RIGID PART No.	PUSHER FITTINGS	90 SHORT BENT TUBE, F. SW JIC 37 PART No.	PUSHER FITTINGS
SY-3R30-30003	SY-4540-3W300	SY-3903-04102	SY-4599-MP002	SY-3903-06505	SY-4599-MP005	SY-3903-02202	SY-4599-FP012	SY-390H-04644	SY-4599-TP204
SY-3R30-04003	SY-4540-3W400	SY-3903-04104	SY-4599-MP004	SY-3903-06506	SY-4599-MP005	SY-3903-03202	SY-4599-FP026	SY-390H-04645	SY-4599-TP205
SY-3R30-06003	SY-4540-3W600	SY-3903-04106	SY-4599-MP005	SY-3903-06508	SY-4599-MP007	SY-3903-04204	SY-4599-FP002	SY-390H-04646	SY-4599-TP206
SY-3R30-08003	SY-4540-30800	SY-3903-04108	SY-4599-MP009	SY-3903-08508	SY-4599-MP008	SY-3903-04206	SY-4599-FP004	SY-390H-04646	SY-4599-TP206
3580		SY-3903-05104	SY-4599-MP004	SY-3903-08510	SY-4599-MP008	SY-3903-06204	SY-4599-FP002	SY-390H-05646	SY-4599-TP206
SY-3580-04004	SY-4540-3S400	SY-3903-05106	SY-4599-MP005	SY-3903-08512	SY-4599-MP011	SY-3903-06206	SY-4599-FP004	SY-390H-06644	SY-4599-TP204
SY-3580-06004	SY-4540-30600	SY-3903-06104	SY-4599-MP005	SY-3903-12512	SY-4599-MP011	SY-3903-06208	SY-4599-FP006	SY-390H-06646	SY-4599-TP206
SY-3580-08001	SY-4540-30800	SY-3903-06106	SY-4599-MP005	SY-3903-12514	SY-4599-MP014	SY-3903-08208	SY-4599-FP007	SY-390H-06648	SY-4599-TP208
SY-3580-12006	SY-4540-31200	SY-3903-06108	SY-4599-MP009	SY-3903-12516	SY-4599-MP013			SY-390H-06650	SY-4599-TP310
3130		SY-3903-08104	SY-4599-MP008	SY-3903-16516	SY-4599-MP013	SY-390H-03202	SY-4599-FP026	SY-390H-08648	SY-4599-TP308
SY-3130-02003	SY-4540-30300	SY-3903-08106	SY-4599-MP008	MALE PIPE SWIVEL		SY-390H-03204	SY-4599-FP002	SY-390H-08650	SY-4599-TP310
SY-3130-03003	SY-4540-30300	SY-3903-08108	SY-4599-MP008	SY-3903-02142	SY-4599-MP027	SY-390H-04204	SY-4599-FP002	SY-390H-10652	SY-4599-TP312
SY-3130-04003	SY-4540-30400	SY-3903-08112	SY-4599-MP011	SY-3903-02144	SY-4599-MP003	SY-390H-04206	SY-4599-FP004	SY-390H-12652	SY-4599-TP312
SY-3130-04005	SY-4540-30400	SY-3903-08114	SY-4599-MP011	SY-3903-03142	SY-4599-MP027	SY-390H-06206	SY-4599-FP004	SY-390H-12654	SY-4599-TP312
SY-3130-05003	SY-4540-30500	SY-3903-12108	SY-4599-MP011	SY-3903-03144	SY-4599-MP003	SY-390H-06208	SY-4599-FP006	SY-390H-12656	SY-4599-TP312
SY-3130-05005	SY-4540-30500	SY-3903-12112	SY-4599-MP011	SY-3903-04144	SY-4599-MP003	30 DEGREE FEMALE NPSM SWIVEL		SY-390H-12658	SY-4599-TP314
SY-3130-06003	SY-4540-30600	SY-3903-16116	SY-4599-MP013	SY-3903-05144	SY-4599-MP003	SY-3903-02244	SY-4599-FP024	SY-390H-12660	SY-4599-TP316
SY-3130-06005	SY-4540-30600			SY-3903-06146	SY-4599-MP006	SY-3903-03244	SY-4599-FP002	SY-390H-16652	SY-4599-TP316
SY-3130-08001	SY-4540-30800	SY-390H-03102	SY-4599-MP001	SY-3903-06148	SY-4599-FP025	SY-3903-04244	SY-4599-FP004	SY-390H-16654	SY-4599-TP316
SY-3130-08003	SY-4540-30800	SY-390H-03104	SY-4599-MP004	SY-3903-08148	SY-4599-MP010	SY-3903-04246	SY-4599-FP013	SAE FLARELESS MALE END	
SY-3130-12008	SY-4540-31200	SY-390H-03106	SY-4599-MP005	SY-3903-12152	SY-4599-MP012	SY-3903-05244	SY-4599-FP013	SY-3903-04K44	SY-4599-MP-002
SY-3130-16008	SY-4540-31600	SY-390H-04102	SY-4599-MP002	SY-3903-16156	SY-4599-MP016	SY-3903-06244	SY-4599-FP014	SY-3903-06K48	SY-4599-MP-005
3130		SY-390H-04104	SY-4599-MP004	JIC 37 FEMALE SWIVEL		SY-3903-06246	SY-4599-FP014	SY-3903-06K48	SY-4599-MP-008
SY-3770-21333	SY-4540-30400	SY-390H-04106	SY-4599-MP005	SY-3903-02543	SY-4599-FP017	SY-3903-06248	SY-4599-FP018	STRAIGHT WITH F. SWIVEL O,RING FACE SEAL	
SY-3770-21343	SY-4540-30500	SY-390H-04108	SY-4599-MP009	SY-3903-02544	SY-4599-FP010	SY-3903-12252	SY-4599-FP018	SY-3903-06K48	SY-4599-MP-008
SY-3770-21353	SY-4540-30600	SY-390H-05104	SY-4599-MP009	SY-3903-02545	SY-4599-FP029	SY-3903-16256	SY-4599-FP009	SY-3903-02404	SY-4599-MP045
SY-3770-21363	SY-4540-30800	SY-390H-06104	SY-4599-MP005	SY-3903-03543	SY-4599-FP017			SY-3903-04404	SY-4599-MP045
37AL NON-CONDUCTIVE		SY-390H-06106	SY-4599-MP005	SY-3903-03544	SY-4599-FP011	SY-390H-03244	SY-4599-FP002	SY-3903-05404	SY-4599-MP045
SY-37AL-03003	SY-4540-30300	SY-390H-06108	SY-4599-MP009	SY-3903-03545	SY-4599-FP001	SY-390H-04244	SY-4599-FP002	SY-3903-05406	SY-4599-MP037
SY-37AL-03005	SY-4540-30300	SY-390H-08106	SY-4599-MP008	SY-3903-04544	SY-4599-FP012	SY-390H-06244	SY-4599-FP013	SY-3903-06406	SY-4599-MP031
SY-37AL-04003	SY-4540-3W400	SY-390H-08108	SY-4599-MP009	SY-3903-04545	SY-4599-FP013	SY-390H-08248	SY-4599-FP018	SY-3903-06408	SY-4599-MP046
SY-37AL-04005	SY-4540-3W400	SY-390H-08112	SY-4599-MP011	SY-3903-04546	SY-4599-FP012	SY-390H-12252	SY-4599-FP008	SY-3903-08408	SY-4599-MP040
SY-37AL-05003	SY-4540-30500	SY-390H-10108	SY-4599-MP011	SY-3903-05544	SY-4599-FP012	SY-390H-16256	SY-4599-FP009	SY-3903-12412	SY-4599-MP039
SY-37AL-05005	SY-4540-30500	SY-390H-12108	SY-4599-MP011	SY-3903-05545	SY-4599-FP013	MALE PIPE SWIVEL 90 ELBOW		SY-3903-16416	SY-4599-MP042
SY-37AL-06003	SY-4540-30600	SY-390H-12112	SY-4599-MP011	SY-3903-05546	SY-4599-FP013	SY-3903-04274	SY-4599-SP008	STRAIGHT WITH F. SWIVEL O,RING FACE SEAL	
SY-37AL-06005	SY-4540-30600	SY-390H-16116	SY-4599-MP013	SY-3903-06544	SY-4599-FP007	SY-3903-06276	SY-4599-SP011	SY-390H-04404	SY-4599-MP045
SY-37AL-08003	SY-4540-30800	SY-390H-12112	SY-4599-MP011	SY-3903-06545	SY-4599-FP013	SY-3903-08278	SY-4599-SP009	SY-390H-06406	SY-4599-MP031
SY-37AL-08007	SY-4540-30800	SY-390H-16116	SY-4599-MP013	SY-3903-06546	SY-4599-FP015	SY-3903-06278	SY-4599-SP009	SY-390H-08408	SY-4599-MP040
37AL TWIN-LINE NON CONDUCTIVE				SY-3903-06548	SY-4599-FP005	SY-3903-08278	SY-4599-SP009	SY-390H-08410	SY-4599-MP059
SY-3770-27A33	SY-4540-3W400	45 DEG MALE RIGID		SY-3903-06550	SY-4599-FP006	45 BENT TUBE WITH 45 INV FL SWIVEL		SY-390H-10410	SY-4599-MP312
SY-3770-27A43	SY-4540-30500	SY-4599-MP001		SY-3903-08548	SY-4599-FP016	SY-3903-03604	SY-4599-TP204	SY-390H-10412	SY-4599-MP039
SY-3770-27A53	SY-4540-30600	SY-3903-03944	SY-4599-MP001	SY-3903-08549	SY-4599-FP006	SY-3903-04604	SY-4599-TP204	SY-390H-12412	SY-4599-MP039
SY-3770-27A63	SY-4540-30800	SY-3903-03944	SY-4599-MP002	SY-3903-08552	SY-4599-FP008	SY-3903-04605	SY-4599-TP205	SY-390H-16416	SY-4599-MP042
3R80 HIGH PRESSURE		SY-3903-05946	SY-4599-MP005	SY-3903-08552	SY-4599-FP008	SY-3903-04606	SY-4599-TP206	FEMALE SWIVEL 45 ELBOW ORING FACE SEAL	
SY-3R80-03003	SY-4540-H0300	SY-3903-06946	SY-4599-MP005	SY-3903-12550	SY-4599-FP021	SY-3903-05606	SY-4599-TP206	SY-3903-02444	TP204*
SY-3R80-04003	SY-4540-H0400	SY-3903-06946	SY-4599-MP005	SY-3903-12552	SY-4599-FP008	SY-3903-06606	SY-4599-TP206	SY-3903-04444	SY-4599-TP204
SY-3R80-06003	SY-4540-H0600	SY-3903-08946	SY-4599-MP008	SY-3903-12554	SY-4599-FP009	SY-3903-06608	SY-4599-TP208	SY-3903-05444	SY-4599-TP206
SY-3R80-08003	SY-4540-H0800	SY-3903-08948	SY-4599-MP008	SY-3903-12556	SY-4599-FP009	SY-3903-06608	SY-4599-TP208	SY-3903-05446	SY-4599-TP206
SY-3R80-12008	SY-4540-H1200	SY-3903-12950	SY-4599-MP011	SY-3903-16556	SY-4599-FP009	SY-3903-08608	SY-4599-TP308	SY-3903-06446	SY-4599-TP206
SY-3R80-16008	SY-4540-H1600	SY-3903-12952	SY-4599-MP011			SY-3903-08610	SY-4599-TP310	SY-3903-08448	SY-4599-TP308
3R80 TWIN-LINE		SY-3903-16956	SY-4599-FP023	SY-390H-03544	SY-4599-FP011	SY-3903-12612	SY-4599-TP312	SY-3903-12452	SY-4599-TP312
SY-3770-2R833	SY-4540-H0400			SY-390H-03545	SY-4599-FP001	SY-390H-16616	SY-4599-TP316	SY-390H-04444	SY-4599-TP204
SY-3770-2R853	SY-4540-H0600	SY-3903-03943	SY-4599-MP001	SY-390H-04544	SY-4599-FP012			SY-390H-06446	SY-4599-TP206
SY-3770-2R863	SY-4540-H0800	SY-3903-03944	SY-4599-MP001	SY-390H-04545	SY-4599-FP013	SY-390H-03604	SY-4599-TP204	SY-390H-08448	SY-4599-TP308
3E80 NON-CONDUCTIVE		SY-3903-04945	SY-4599-MP002	SY-390H-04546	SY-4599-FP013	SY-390H-04605	SY-4599-TP205	SY-390H-12452	SY-4599-TP312
SY-3E80-04003	SY-4540-H0400	SY-3903-06946	SY-4599-MP005	SY-390H-05546	SY-4599-FP013	SY-390H-06606	SY-4599-TP206	SY-390H-04444	SY-4599-TP204
SY-3E80-06003	SY-4540-H0600	SY-3903-08946	SY-4599-MP008	SY-3903-06548	SY-4599-FP013	SY-390H-06608	SY-4599-TP208	SY-390H-06446	SY-4599-TP206
SY-3E80-08003	SY-4540-H0800	SY-3903-08948	SY-4599-MP008	SY-390H-06549	SY-4599-FP017	SY-390H-08608	SY-4599-TP308	SY-390H-08448	SY-4599-TP308
3E80 TWIN-LINE NON-CONDUCTIVE		SY-3903-12950	SY-4599-MP011	SY-390H-06548	SY-4599-FP017	SY-390H-08610	SY-4599-TP310	SY-390H-12452	SY-4599-TP312
SY-3770-2E833	SY-4540-H0400	SY-3903-12952	SY-4599-MP011	SY-390H-06548	SY-4599-FP015	SY-390H-12612	SY-4599-TP312	F. SWIVEL 90 ELB O-RING FACE SEAL	
SY-3770-2E853	SY-4540-H0600	SY-3903-16956	SY-4599-FP023	SY-390H-06548	SY-4599-FP015	SY-390H-16616	SY-4599-TP316	SHORT DROP	
SY-3770-2E863	SY-4540-H0800	MALE ORING ST THREAD		SY-390H-06550	SY-4599-FP005			SY-3903-02474	SY-459-9-TP204*
SPECTRA 30CT CONSTANT PRESSURE		SY-3903-02D02	SY-4599-MP001	SY-390H-06552	SY-4599-FP006	90 LONG BENT TUBE FEMALE SW JIC 37		SY-3903-04474	SY-4599-TP204
SY-30CT-04003	SY-4540-3W400	SY-3903-03D04	SY-4599-MP001	SY-390H-06554	SY-4599-FP017	SY-3903-02843	SY-4599-TP204	SY-3903-05474	SY-4599-TP206
SY-30CT-05003	SY-4540-30500	SY-3903-03D04	SY-4599-MP002	SY-390H-06548	SY-4599-FP013	SY-3903-03844	SY-4599-TP204	SY-3903-05474	SY-4599-TP206
SY-30CT-06003	SY-4540-30600	SY-3903-04D06	SY-4599-MP004	SY-390H-06548	SY-4599-FP015	SY-3903-04844	SY-4599-TP204	SY-3903-05476	SY-4599-TP206
SY-30CT-08003	SY-4540-H0800	SY-3903-05D04	SY-4599-MP004	SY-390H-10550	SY-4599-FP008	SY-3903-04845	SY-4599-TP205	SY-3903-05478	SY-4599-TP206
SPECTRA 30CTTWIN-LINE		SY-3903-05D05	SY-4599-MP004	SY-390H-10552	SY-4599-FP021	SY-3903-04846	SY-4599-TP205	SY-3903-06476	SY-4599-TP206
SY-3770-20C33	SY-4540-3W400	SY-3903-05D06	SY-4599-MP004	SY-390H-12550	SY-4599-FP008	SY-3903-05846	SY-4599-TP206	SY-3903-08478	SY-4599-TP308

B

Standing Out in a Crowd! Our New Look Product Displays



Stand Alone Racks are available in a variety of configurations, in Fairview, Accutek™ & Gas-Flo® Product Categories. See pg. 257 - 261

HOSE & ASSEMBLIES



WHAT'S NEW IN THIS SECTION

- Breathing Air HosePg 101

CAUTION:

Some agents used in the curing of rubber hose may leach out over time. Trace amounts may be enough to cause problems for sensitive hands. Gloves should be worn and care taken in handling of rubber hose products.

ATTENTION:

Certains agents chimiques utilisés dans la vulcanisation des boyaux en caoutchouc peuvent filtrer avec le temps.

De simples traces de ces agents peuvent affecter les peaux sensibles. Il est recommandé de porter des gants et de manipuler les boyaux avec prudence.

ADVERTENCIA:

Algunos agentes utilizados en la cura de la manguera de caucho pueden filtrarse con el tiempo. Trazas pueden ser suficiente para causar problemas para manos sensibles.

Los guantes deben usarse y cuidado tomados en el manejo de los productos de la manguera de caucho.

AIR BRAKE HOSE (D.O.T.)	94
AIR BRAKE HOSE ASSEMBLIES (D.O.T.)	95 - 98
AIR HOSE ASSEMBLIES	80 - 87, 99
AIR HOSE ASSEMBLY REPAIR KITS	88
AIR SEAT GUN KIT	106
AIR SHIFT TRANSMISSION ASSEMBLIES	106
ARGON GAS HOSE ASSEMBLY	133
BRAKE LINE ASSEMBLIES -STEEL	140
BREATHING AIR HOSE	101
COOLANT HOSE - SILICONE	103
DISHWASHER HOSE	90
FIFTH WHEEL SLIDER ASSEMBLY	99
FIFTH WHEEL SLIDER KIT	106
FUEL LINE HOSE	101
GAS APPLIANCE CONNECTORS (N.S.F.)	134 - 137
GAS ASSEMBLIES (LPG-NATURAL) TYPE I, II, & III (C.S.A. U.L.) ..	123 - 133
GAS PIGTAILS AND HOGTAILS (COPPER)	139
GAS PURGE KITS	133
GENERAL PURPOSE HOSE - PVC	84 - 86
GENERAL PURPOSE HOSE - RUBBER	80 - 82
GREASE WHIP ASSEMBLIES	106
GRIP-TITE HOSE	105
HEATER HOSE	103 - 104
HYDRAULIC HOSE ASSEMBLIES	113 - 122
HYDRAULIC HOSE -S.A.E. 100R1	107 - 108
HYDRAULIC HOSE -S.A.E. 100R2	107 - 108
HYDRAULIC HOSE -S.A.E. 100R3	109, 115
HYDRAULIC HOSE -S.A.E. 100R4	109
HYDRAULIC HOSE -S.A.E. 100R5	100
HYDRAULIC HOSE -S.A.E. 100R7	110, 116 - 117
HYDRAULIC HOSE -S.A.E. 100R12	110
HYDRAULIC HOSE -S.A.E. 100R8	118
HYDRAULIC HOSE -S.A.E. 100R14	102
HYDRAULIC HOSE -S.A.E. 100R16	111
HYDRAULIC HOSE -S.A.E. 100R17	111
HYDRAULIC HOSE -S.A.E. 100R18	120
PRESSURE WASH HOSE	91
PRESSURE WASH HOSE ASSEMBLIES	92 -93
PTFE HOSE (S.A.E. 100R14)	102
PTFE HOSE ASSEMBLIES	102
SELFSTORING COILED AIR HOSE ASSEMBLIES	86 - 87
SEWER CLEANING HOSE ASSEMBLIES	90
STAINLESS STEEL C.S.A. METAL HOSE ASSEMBLIES	138
SUPERFLEX HOSE	83
SYNFLEX HOSE	115 - 122
TORCH ASSEMBLIES (PROPANE)	236
TURBO CHARGER CONNECTORS	103
VAPOR HOSE	138
WATER HOSE ASSEMBLIES	89
WETLINE KITS	112



This high quality rubber hose provides maximum oil resistance and great cold weather flexibility. It is found in demanding applications in factories, construction, agriculture, quarries, mines, railroads, the oil and gas industry and ship building. Non-conductive; minimum electrical resistance greater than one (1) megohm per inch of hose length at 1000 Volts DC.

- **CONSTRUCTION:**
- **TUBE:** Nitrile (RMA CLASS A)
- **COVER:** Nitrile (RMA CLASS A)
- **REINFORCEMENT:** Spiral Synthetic Yarn
- **COLOR:** RED
- **TEMPERATURE:** -20°F to +190°F, -29°C to +88°C
- **PACKAGING:** Reels
- **FITTINGS:** Page 30, 56 - 57
- **HOSE END GUARDS:** Page 248

C

PART No.	Actual I.D. (IN.)	Hose O.D. (IN.)	Working Pressure (P.S.I.)	Reel Length (FT.)
RPH-4-REEL	1/4	.531	250	500
RPH-6-REEL	3/8	.688	250	500
RPH-8-REEL	1/2	.844	250	500
RPH-10-REEL	5/8	1.012	300	500
RPH-12-REEL	3/4	1.140	250	500
RPH-16-REEL	1	1.500	300	450

NOTE: WORKING PRESSURE RATED AT +70°F, +21°C. ANY AMBIENT OR INTERNAL INCREASE IN TEMPERATURE WILL LOWER THE WORKING PRESSURE.

PREMIER RUBBER HOSE ASSEMBLIES

The **RP** Series of assemblies is constructed with **RPH** hose. All assemblies have factory crimped ends with either B - 1/4", C - 3/8" or D - 1/2" brass male pipe ends. Standard lengths are -25, 50, 75 or 100ft. Suitable for a multitude of applications.

- **COLOR:** Red
- **TEMPERATURE:** -20°F to +190°F, -29°C to +88°C
- **PACKAGING:** Individually shrink wrapped with bar coded label.
- **FITTINGS:** Machined Brass



NOTE

WORKING PRESSURE RATED AT +70°F +21°C. ANY AMBIENT OR INTERNAL INCREASE IN TEMPERATURE WILL LOWER THE WORKING PRESSURE.

Custom Lengths Available Upon Request.

1/4 I.D. HOSE 1/4 M.P.T. ENDS			3/8 I.D. HOSE 1/4 M.P.T. ENDS			3/8 I.D. HOSE 3/8 M.P.T. ENDS			1/2 I.D. HOSE 1/2 M.P.T. ENDS		
PART No.	Length (FT.)	Working Pressure (P.S.I.)	PART No.	Length (FT.)	Working Pressure (P.S.I.)	PART No.	Length (FT.)	Working Pressure (P.S.I.)	PART No.	Length (FT.)	Working Pressure (P.S.I.)
RP4RED-25B	25	250	RP6RED-25B	25	250	RP6RED-25C	25	250	RP8RED-25D	25	250
RP4RED-50B	50	250	RP6RED-50B	50	250	RP6RED-50C	50	250	RP8RED-50D	50	250

MULTI-PURPOSE RUBBER HOSE



A good quality, economical, general purpose hose ideal for air service, compressor lines, pneumatic tools, low pressure spray and many other applications. Wing Foot multi-purpose hose is specially designed to offer superior oil resistance in the most demanding environments.

- **CONSTRUCTION:**
- **TUBE:** Nitrile (RMA CLASS A)
- **COVER:** Buna-N-Vinyl (RMA CLASS B)
- **REINFORCEMENT:** Spiral Synthetic Yarn
- **COLOR:** Red
- **TEMPERATURE:** -20°F to +190°F, -29°C to +88°C
- **PACKAGING:** Reels
- **FITTINGS:** Page 30, 56 - 57
- **HOSE END GUARDS:** Page 248

PART No.	Actual I.D. (IN.)	Hose O.D. (IN.)	Working Pressure (P.S.I.)	Reel Length (FT.)
RWH-4-REEL	1/4	0.531	200	500
RWH-4/2-REEL	1/4	0.543	300	500
RWH-6-REEL	3/8	0.688	250	500
RWH-6/2-REEL	3/8	0.688	300	500
RWH-8/2-REEL	1/2	0.858	300	500

NOTE: WORKING PRESSURE RATED AT +70°F, +21°C. ANY AMBIENT OR INTERNAL INCREASE IN TEMPERATURE WILL LOWER THE WORKING PRESSURE.

MULTI-PURPOSE RUBBER HOSE ASSEMBLIES

The **RW** Series of assemblies is constructed with **RWH** hose. All assemblies have factory crimped ends with either B - 1/4", C - 3/8" or D - 1/2" brass male pipe ends. Standard lengths are -25, 50, 75 or 100ft.

- **COLOR:** RED
- **TEMPERATURE:** -20°F to +190°F, -29°C to +88°C
- **PACKAGING:** Individually shrink wrapped with bar coded label.
- **FITTINGS:** Machined Brass



NOTE
WORKING PRESSURE RATED AT +70°F +21°C. ANY AMBIENT OR INTERNAL INCREASE IN TEMPERATURE WILL LOWER THE WORKING PRESSURE.

Custom Lengths Available Upon Request.

1/4 I.D. HOSE 1/4 M.P.T. ENDS			3/8 I.D. HOSE 1/4 M.P.T. ENDS			1/2 I.D. HOSE 1/2 M.P.T. ENDS		
PART No.	Length (FT.)	Working Pressure (P.S.I.)	PART No.	Length (FT.)	Working Pressure (P.S.I.)	PART No.	Length (FT.)	Working Pressure (P.S.I.)
RW4RED-25B	25	250	RW6RED-25B	25	250	RW8/2RED-25D	25	300
RW4RED-50B	50	250	RW6RED-50B	50	250	RW8/2RED-50D	50	300
			RW6RED-100B	100	250	RW8/2RED-100D	100	300
RW4/2RED-25B	25	300	RW6/2RED-25B	25	300			
RW4/2RED-50B	50	300	RW6/2RED-50B	50	300			
			RW6/2RED-100B	100	300			





This quality rubber hose features EPDM cover and tube with high tensile spiral synthetic yarn reinforcement. It is best suited for applications requiring maximum flexibility or a lighter weight rubber hose.

- **CONSTRUCTION:**
- **TUBE:** EPDM (RMA CLASS C).
- **COVER:** EPDM (RMA CLASS C).
- **REINFORCEMENT:** Spiral Synthetic Yarn
- **COLORS:** Black, Green, Red, Yellow
- **TEMPERATURE:** -20°F to +200°F, -29°C to +93°C
- **PACKAGING:** Reels
- **FITTINGS:** Page 30, 56 - 57
- **HOSE END GUARDS:** Page 248

PART No.	Actual I.D. (IN.)	Hose O.D. (IN.)	Working Pressure (P.S.I.)	Reel Length (FT.)
RGP-4RED-REEL	1/4	.500	200	300
RGP-4YEL-REEL	1/4	.500	200	300
RGP-4/2RED-REEL	1/4	.527	250	300
RGP-6RED-REEL	3/8	.669	200	300
RGP-6YEL-REEL	3/8	.669	200	300
RGP-6/2RED-REEL	3/8	.700	250	300
RGP-8BLK-REEL	1/2	.810	200	300
RGP-8GRN-REEL	1/2	.810	200	300
RGP-8RED-REEL	1/2	.810	200	300
RGP-8/2RED-REEL	1/2	.838	250	300

PART No.	Actual I.D. (IN.)	Hose O.D. (IN.)	Working Pressure (P.S.I.)	Reel Length (FT.)
RGP-10BLK-REEL	5/8	.930	200	500
RGP-10RED-REEL	5/8	.968	200	500
RGP-10/2RED-REEL	5/8	.976	250	500
RGP-12BLK-REEL	3/4	1.080	200	200
RGP-12RED-REEL	3/4	1.118	200	500
RGP-12/2RED-REEL	3/4	1.141	250	500
RGP-16RED-REEL	1	1.440	200	300
RGP-20RED-REEL	1-1/4	1.750	200	300
RGP-24RED-REEL	1-1/2	2.000	200	300

NOTE: WORKING PRESSURE RATED AT +70°F, +21°C. ANY AMBIENT OR INTERNAL INCREASE IN TEMPERATURE WILL LOWER THE WORKING PRESSURE.

QUALITY RUBBER HOSE ASSEMBLIES

The **RG** Series of assemblies is constructed with **RGP** hose. All assemblies have factory crimped ends with either B - 1/4", C - 3/8" or D - 1/2" brass male pipe ends. Standard lengths are -25, 50, 75 or 100ft.

- **COLORS:** Black, Red, Yellow
- **TEMPERATURE:** -20°F to +200°F, -29°C to +93°C
- **PACKAGING:** Individually shrink wrapped with bar coded label.
- **FITTINGS:** Machined Brass



NOTE

WORKING PRESSURE RATED AT +70°F +21°C. ANY AMBIENT OR INTERNAL INCREASE IN TEMPERATURE WILL LOWER THE WORKING PRESSURE.

Custom Lengths Available Upon Request.

1/4 I.D. 1/4 M.P.T. ENDS			3/8 I.D. 1/4 M.P.T. ENDS			3/8 I.D. 3/8 M.P.T. ENDS			1/2 I.D. 3/8 M.P.T. ENDS			1/2 I.D. 1/2 M.P.T. ENDS		
PART No.	Length (FT.)	Working Pressure (P.S.I.)	PART No.	Length (FT.)	Working Pressure (P.S.I.)	PART No.	Length (FT.)	Working Pressure (P.S.I.)	PART No.	Length (FT.)	Working Pressure (P.S.I.)	PART No.	Length (FT.)	Working Pressure (P.S.I.)
RG4RED-25B	25	200	RG6RED-25B	25	200	RG6RED-25C	25	200	RG8RED-25C	25	200	RG8BLK-25D	25	200
RG4RED-50B	50	200	RG6RED-35B	35	200	RG6RED-50C	50	200	RG8RED-50C	50	200	RG8BLK-50D	50	200
RG4RED-100B	100	200	RG6RED-50B	50	200	RG6RED-100C	100	200	RG8RED-100C	100	200	RG8BLK-100D	100	200
RG4YEL-25B	25	200	RG6RED-100B	100	200	RG6/2RED-25C	25	250	RG8/2RED-50C	50	200	RG8RED-25D	25	200
RG4YEL-50B	50	200	RG6YEL-25B	25	200	RG6/2RED-50C	50	250	RG8RED-50D	50	200	RG8RED-50D	50	200
RG4/2RED-25B	25	250	RG6YEL-50B	50	200	RG6/2RED-100C	100	250	RG8RED-100D	100	200	RG8RED-100D	100	200
RG4/2RED-50B	50	250	RG6/2RED-25B	25	250							RG8/2RED-25D	25	250
RG4/2RED-100B	100	250	RG6/2RED-50B	50	250							RG8/2RED-50D	50	250
			RG6/2RED-100B	100	250							RG8/2RED-100D	100	250

SUPERFLEX HOSE



Fairview's new Superflex multi purpose hose is more flexible than most rubber hoses even at extremely low temperatures. It's light weight and relatively high pressure rating make it ideal for pneumatic hand tool and shop air applications. RMA Class B oil resistance.

- **REINFORCEMENT:** Spiral High Tensile Yarn
- **COLORS:** Green, Red, Yellow
- **TEMPERATURE:** -40°F to +150°F, -40°C to +65°C
- **WORKING PRESSURE:** 300 P.S.I.
- **PACKAGING:** Loose coils or plastic core reels
- **FITTINGS:** Page 30, 56 - 57
- **HOSE END GUARDS:** Page 248

PART No.	Actual I.D. (IN.)	Hose O.D. (IN.)	Working Pressure (P.S.I.)	Reel / Coil Length (FT.)
GLH-4RED-COIL	1/4	.500	300	500
GLH-4RED-REEL	1/4	.500	300	500
GLH-4YEL-COIL	1/4	.500	300	500
GLH-4YEL-REEL	1/4	.500	300	500
GLH-6RED-COIL	3/8	.625	300	500
GLH-6RED-REEL	3/8	.625	300	500
GLH-6YEL-COIL	3/8	.625	300	500
GLH-6YEL-REEL	3/8	.625	300	500
GLH-8GRN-COIL	1/2	.781	300	500

NOTE: WORKING PRESSURE RATED AT +70°F, +21°C. ANY AMBIENT OR INTERNAL INCREASE IN TEMPERATURE WILL LOWER THE WORKING PRESSURE.

SUPERFLEX AIR HOSE ASSEMBLIES

The **GL** Series of assemblies is constructed with GLH hose. All assemblies have factory crimped ends with either B - 1/4" or C - 3/8" brass male pipe ends. Bend protectors are standard on these assemblies.

- **COLORS:** Red, Yellow
- **TEMPERATURE:** -40°F to +150°F, -40°C to +65°C
- **WORKING PRESSURE:** 300 P.S.I.
- **PACKAGING:** Individually shrink wrapped with bar coded label.
- **FITTINGS:** Machined Brass



NOTE
WORKING PRESSURE RATED AT +70°F +21°C. ANY AMBIENT OR INTERNAL INCREASE IN TEMPERATURE WILL LOWER THE WORKING PRESSURE.

Custom Lengths Available Upon Request.

1/4 I.D. HOSE 1/4 M.P.T. ENDS				3/8 I.D. HOSE 1/4 M.P.T. ENDS				3/8 I.D. HOSE 3/8 M.P.T. ENDS			
PART No.	Length (FT.)	Actual I.D. (IN.)	Working Pressure (P.S.I.)	PART No.	Length (FT.)	Actual I.D. (IN.)	Working Pressure (P.S.I.)	PART No.	Length (FT.)	Actual I.D. (IN.)	Working Pressure (P.S.I.)
GL4RED-25B	25	1/4	300	GL6RED-25B	25	3/8	300	GL6RED-50C	50	3/8	300
GL4RED-50B	50	1/4	300	GL6RED-50B	50	3/8	300	GL6YEL-25C	25	3/8	300
GL4YEL-25B	25	1/4	300	GL6RED-100B	100	3/8	300	GL6YEL-50C	50	3/8	300
GL4YEL-50B	50	1/4	300	GL6YEL-25B	25	3/8	300	GL6YEL-100C	100	3/8	300
GL4YEL-100B	100	1/4	300	GL6YEL-50B	50	3/8	300				
				GL6YEL-100B	100	3/8	300				



HIGH QUALITY P.V.C. HOSE

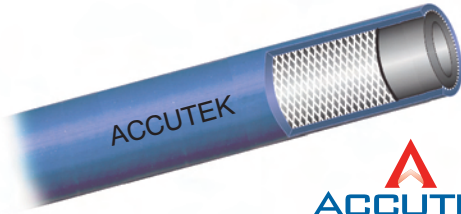

Uniquely blended P.V.C. compounds enhance cold weather flexibility and give this hose the look and feel of a comparable rubber hose. It's non-marking ozone and atmosphere resistant cover and the light weight of this hose make it ideal for water hose and shop air tool applications.

- **REINFORCEMENT:** Spiral High Tensile Yarn
- **TUBE:** PVC compound (RMA CLASS C).
- **COLORS:** Blue, Red, Yellow
- **TEMPERATURE:** -15°F to +150°F, -26°C to +66°C
- **PACKAGING:** Reels
- **FITTINGS:** Page 30, 56 - 57
- **HOSE END GUARDS:** Page 248

PART No.	Actual I.D. (IN.)	Hose O.D. (IN.)	Working Pressure (P.S.I.)	Reel Length (FT.)
HPA-4BLU-REEL	1/4	.500	300	500
HPA-4RED-REEL	1/4	.500	300	500
HPA-4YEL-REEL	1/4	.500	300	500
HPA-6BLU-REEL	3/8	.625	300	500
HPA-6RED-REEL	3/8	.625	300	500
HPA-6YEL-REEL	3/8	.625	300	500

PART No.	Actual I.D. (IN.)	Hose O.D. (IN.)	Working Pressure (P.S.I.)	Reel Length (FT.)
HPA-8BLU-REEL	1/2	.813	300	500
HPA-8RED-REEL	1/2	.813	300	500
HPA-8YEL-REEL	1/2	.813	300	500
HPA-10BLU-REEL	5/8	.906	250	300
HPA-12BLU-REEL	3/4	1.125	250	300

NOTE: WORKING PRESSURE RATED AT +70°F, +21°C. ANY AMBIENT OR INTERNAL INCREASE IN TEMPERATURE WILL LOWER THE WORKING PRESSURE.

HIGH QUALITY P.V.C. HOSE ASSEMBLIES

The PA Series of assemblies is constructed with HPA hose. All assemblies have factory crimped ends with either B - 1/4", C - 3/8" or D - 1/2" brass male pipe ends. Standard lengths are -25, 50, 75 or 100ft.

- **COLORS:** Blue, Red, Yellow
- **TEMPERATURE:** -15°F to +150°F, -26°C to +66°C
- **PACKAGING:** Individually shrink wrapped with bar coded label.
- **FITTINGS:** Machined Brass



NOTE

WORKING PRESSURE RATED AT +70°F +21°C. ANY AMBIENT OR INTERNAL INCREASE IN TEMPERATURE WILL LOWER THE WORKING PRESSURE.

Custom Lengths Available Upon Request.

1/4 I.D. HOSE 1/4 M.P.T. ENDS			3/8 I.D. HOSE 1/4 M.P.T. ENDS			3/8 I.D. HOSE 3/8 M.P.T. ENDS			1/2 I.D. HOSE 3/8 M.P.T. ENDS			1/2 I.D. HOSE 1/2 M.P.T. ENDS		
PART No.	Length (FT.)	Working Pressure (P.S.I.)	PART No.	Length (FT.)	Working Pressure (P.S.I.)	PART No.	Length (FT.)	Working Pressure (P.S.I.)	PART No.	Length (FT.)	Working Pressure (P.S.I.)	PART No.	Length (FT.)	Working Pressure (P.S.I.)
PA4RED-25B	25	300	PA6BLU-25B	25	300	PA6BLU-25C	25	300	PA8RED-50C	50	300	PA8BLU-50D	50	300
PA4RED-50B	50	300	PA6BLU-50B	50	300	PA6BLU-50C	50	300	PA8RED-100C	100	300	PA8BLU-100D	100	300
PA4RED-100B	100	300	PA6BLU-100B	100	300	PA6RED-50C	50	300				PA8RED-50D	50	300
			PA6RED-25B	25	300							PA8RED-100D	100	300
			PA6RED-50B	50	300									
			PA6RED-100B	100	300									
			PA6YEL-25B	25	300									
			PA6YEL-50B	50	300									
			PA6YEL-100B	100	300									

QUALITY P.V.C. HOSE



This quality hose features the same uniquely blended P.V.C. compounds as our HPA air hose. Its' reduced wall thickness provides an economical alternative without sacrificing working pressure or temperature range.

- **REINFORCEMENT:** Spiral High Tensile Yarn
- **COLORS:** Blue, Red, Yellow
- **TEMPERATURE:** -15°F to +150°F, -26°C to +66°C
- **WORKING PRESSURE:** 1/4 AND 3/8 I.D. 300 P.S.I. 1/2 150 P.S.I.
- **PACKAGING:** Reels
- **FITTINGS:** Page 30, 56 - 57
- **HOSE END GUARDS:** Page 248

PART No.	Actual I.D. (IN.)	Hose O.D. (IN.)	Working Pressure P.S.I.	Reel / Coil Length (FT.)
RVH-4RED-COIL	1/4	.438	300	500
RVH-4YEL-COIL	1/4	.438	300	500
RVH-6BLU-COIL	3/8	.594	300	500
RVH-6BLU-REEL	3/8	.594	300	500
RVH-6RED-COIL	3/8	.594	300	500
RVH-6RED-REEL	3/8	.594	300	500
RVH-8BLU-REEL	1/2	.720	150	500

NOTE: WORKING PRESSURE RATED AT +70°F, +21°C. ANY AMBIENT OR INTERNAL INCREASE IN TEMPERATURE WILL LOWER THE WORKING PRESSURE.

QUALITY P.V.C. HOSE ASSEMBLIES

The **RV** Series of assemblies is constructed with **RVH** hose. All assemblies have factory crimped ends with either B - 1/4", C - 3/8" or D - 1/2" brass male pipe ends. Standard lengths are -25, 50, 75 or 100ft.

- **COLORS:** Blue, Red, Yellow
- **TEMPERATURE:** -15°F to +150°F, -26°C to +66°C
- **PACKAGING:** Individually shrink wrapped with bar coded label.
- **FITTINGS:** Machined Brass



NOTE
WORKING PRESSURE RATED AT +70°F +21°C. ANY AMBIENT OR INTERNAL INCREASE IN TEMPERATURE WILL LOWER THE WORKING PRESSURE.

Custom Lengths Available Upon Request.

1/4 I.D. HOSE 1/4 M.P.T. ENDS			3/8 I.D. HOSE 1/4 M.P.T. ENDS			3/8 I.D. HOSE 3/8 M.P.T. ENDS		
PART No.	Length (FT.)	Working Pressure (P.S.I.)	PART No.	Length (FT.)	Working Pressure (P.S.I.)	PART No.	Length (FT.)	Working Pressure (P.S.I.)
RV4RED-25B	25	300	RV6BLU-25B	25	300	RV6RED-25C	25	300
RV4RED-50B	50	300	RV6BLU-50B	50	300	RV6RED-50C	50	300
RV4RED-100B	100	300	RV6BLU-100B	100	300			
RV4YEL-25B	25	300	RV6RED-25B	25	300			
RV4YEL-50B	50	300	RV6RED-50B	50	300			
RV4YEL-100B	50	300	RV6RED-100B	100	300			



AIR HOSE ASSEMBLIES

CONTRACTORS INDUSTRIAL P.V.C. AIR HOSE ASSEMBLIES

Heavy duty brass reusable ends and spring guard bend protectors make these light weight uniquely blended P.V.C hose assemblies ideal for pneumatic nail guns and air powered industrial tools at the job site.

- **COLOR:** Red, Blue and Yellow
- **TEMPERATURE:** -15°F to +150°F, -26°C to +66°C
- **PACKAGING:** Individually Shrink Wrapped With Bar Coded Label.
- **QUICK DISCONNECT:** QD-TFM Series (Optional) See Page 187
- **BULK HOSE:** See HPA Page 84



NOTE: WORKING PRESSURE RATED AT +70°F, +21°C. ANY AMBIENT OR INTERNAL INCREASE IN TEMPERATURE WILL LOWER THE WORKING PRESSURE.

3/8 I.D. HOSE 1/4 M.P.T. ENDS

PART No.	Length (FT.)	Working Pressure (P.S.I.)
PAR6RED-25B-SG	25	300
PAR6RED-50B-SG	50	300
PAR6RED-100B-SG	100	300
PAR6BLU-100B-SG	100	300
PAR6YEL-100B-SG	100	300

3/8 I.D. HOSE 3/8 M.P.T. ENDS

PART No.	Length (FT.)	Working Pressure (P.S.I.)
PAR6RED-50C-SG	50	300
PAR6RED-100C-SG	100	300
PAR6BLU-100C-SG	100	300

POLYURETHANE SELF-STORING AIR HOSE ASSEMBLIES

These polyurethane assemblies are produced using an ether based resin for better strength, flexibility and superior memory. This hose has excellent resistance to water, chemicals, oxidation, hydrolysis and ozone. It is kink resistant, light weight and mobile.

- **COLOR:** Blue
- **TEMPERATURE:** -40°F to +175°F, -40°C to +79°C
- **PACKAGING:** Individually Bagged With Header / Display Ready
- **FITTINGS:** 360° Brass Working Male Pipe Swivels Each End.

PART No.	Actual I.D. (IN.)	Swivel Pipe	Length (FT.)	Working Pressure (P.S.I.)
1936-4-12	1/4	1/4	12	125
1936-4-15	1/4	1/4	15	125
1936-4-25	1/4	1/4	25	125
1936-4-50	1/4	1/4	50	125
1936-6-12	3/8	3/8	12	125
1936-6-15	3/8	3/8	15	125
1936-6-20	3/8	3/8	20	125
1936-6-25	3/8	3/8	25	125
1936-6-50	3/8	3/8	50	125

NOTE: 1936 SERIES SUPPLIED IN ASSEMBLIES ONLY.

NOTE
WORKING PRESSURE RATED AT +70°F +21°C. ANY AMBIENT OR INTERNAL INCREASE IN TEMPERATURE WILL LOWER THE WORKING PRESSURE.



CO-POLYMER SELF-STORING AIR HOSE

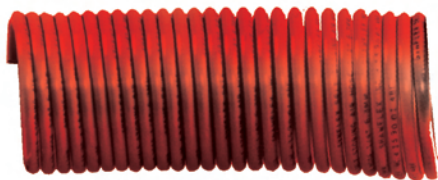

A light weight co-polymer self-storing air-hose, **SUPERIOR to Nylon 11 and/or Nylon 12** in flexibility and retractability. Excellent resistance to abrasion, impact, flex fatigue, many industrial chemicals, oils and solvents. Contains ultra-violet stabilizers to ensure a long life.

- **COLOR:** Red
- **TEMPERATURE:** -40°F to +180°F,
-40°C to +82°C
- **PACKAGING:** 100 FT. Lengths
- **FITTINGS:** 1978 Series see below.

PART No.	Actual I.D. (IN.)	Length (FT.)	Working Pressure (P.S.I.)
1985-4-100	1/4	100	250
1985-6-100	3/8	100	200

HOW TO MEASURE

1985-4 Each LOOP = APPROX. 10" (25 cm)
1985-6 Each LOOP = APPROX. 15" (37.5 cm)

NOTE: WORKING PRESSURE RATED AT +70°F, +21°C. ANY AMBIENT OR INTERNAL INCREASE IN TEMPERATURE WILL LOWER THE WORKING PRESSURE.

CO-POLYMER SELF-STORING AIR HOSE ASSEMBLIES

A light weight co-polymer self-storing air hose assembly, **SUPERIOR to Nylon 11 and/or Nylon 12** in flexibility and retractability. Excellent resistance to abrasion, impact, flex fatigue, many industrial chemicals, oils and solvents. Contains ultra-violet stabilizers to ensure a long life.

NOTE: SUFFIX PART No. WITH "P" FOR PACKAGED ASSEMBLY
EXAMPLE: 1935-6-12-1/2P

- **COLOR:** Red
- **TEMPERATURE:** -40°F to +180°F,
-40°C to +82°C
- **PACKAGING:** Bulk or Individually Bagged With Header / Display Ready.
- **FITTINGS:** 360° Brass Working Male Pipe Swivels Each End.
1978 Series see below.

NOTE
WORKING PRESSURE RATED AT +70°F +21°C. ANY AMBIENT OR INTERNAL INCREASE IN TEMPERATURE WILL LOWER THE WORKING PRESSURE.

PART No.	Actual I.D. (IN.)	Swivel Pipe	Length (FT.)	Working Pressure (P.S.I.)
1935-4-12-1/2	1/4	1/4	12.5	250
1935-4-25	1/4	1/4	25	250
1935-4-50	1/4	1/4	50	250
1935-6-12-1/2	3/8	3/8	12.5	200
1935-6-25	3/8	3/8	25	200
1935-6-50	3/8	3/8	50	200
1935-6-100	3/8	3/8	100	200
1935-8-12-1/2	1/2	1/2	12.5	150
1935-8-25	1/2	1/2	25	150
1935-8-50	1/2	1/2	50	150
1935-8-100	1/2	1/2	100	150



SELF-STORING AIR HOSE END FITTINGS



WORKING SWIVEL CONNECTOR
Tube To Swivel Male Pipe

PART No.	Hose I.D.	Pipe
1978-4B	1/4	1/4
1978-6C	3/8	3/8



BRASS SLEEVE

PART No.	Hose I.D.
60-5	1/4
1960-6	3/8

AIR HOSE REPAIR KIT

Repair Kit Selection: PART No. FKAR-1

Designed for use in the field or shop, this kit includes a selection of items to complete many air hose repairs.

Flip Top carry case.

Overall: Height 6-3/4 inches
Width 10-3/4 inches
Depth 1-3/4 inches

Kit Contains

PART No.	Qty	Description
HC9-8	10	.433 - .512(IN) 11.0 - 13.0(MM)
HC9-9	10	.512 - .591(IN) 13.0 - 15.0(MM)
HC9-9-1/2	10	.544 - .669(IN) 15.0 - 17.0(MM)
HC9-10	10	.591 - .708(IN) 15.0 - 18.0(MM)
HC9-12	10	.669 - .787(IN) 17.0 - 20.0(MM)
HC9E-R	1	Regular Pincers
125-4B	5	1/4 x 1/4 Hose Barbs
125-6B	5	3/8 x 1/4 Hose Barbs
129-4	5	1/4 Hose Splicers
129-6	5	3/8 Hose Splicers
240-B	3	1/4 Drain Cocks



**HC9 VERSION
(2 EAR CLAMP)**

AIR HOSE REPAIR KIT

Service Kit Selection: PART No. FKAR-2

Designed for use in the field or shop, this kit includes a larger selection of items to complete many air hose repairs.

Single sided carry case, with handle

Overall: Height 12 inches
Width 14-1/2 inches
Depth 4-3/4 inches

Kit Contains

PART No.	Qty	Description
HC9-8	10	.433 - .512(IN) 11.0 - 13.0(MM)
HC9-9	10	.512 - .591(IN) 13.0 - 15.0(MM)
HC9-9-1/2	10	.544 - .669(IN) 15.0 - 17.0(MM)
HC9-10	10	.591 - .708(IN) 15.0 - 18.0(MM)
HC9-12	10	.669 - .787(IN) 17.0 - 20.0(MM)
122-B	5	1/2 Hex Nipples
125-4B	5	1/4 x 1/4 Hose Barbs
125-6B	5	3/8 x 1/4 Hose Barbs
129-4	5	1/4 Hose Splicers
129-6	5	3/8 Hose Splicers
QD-ARON4-4F	5	1/4 x 1/4 FPT ARO Interchange Nipple
QD-ARON4-4M	5	1/4 x 1/4 MPT ARO Interchange Nipple
QD-INDN4-4F	5	1/4 x 1/4 FPT Industrial Interchange Nipple
QD-INDN4-4M	5	1/4 x 1/4 MPT Industrial Interchange Nipple
QD-UNIAC4-4F	2	1/4 x 1/4 FPT Universal Interchange Coupler



INDUSTRIAL WATER HOSE ASSEMBLIES



- HEAVY BRASS MACHINED ENDS, FOR ALL ASSEMBLIES: SEE PAGE: 30
- OTHER LENGTHS AND END COMBINATIONS AVAILABLE UPON REQUEST. •

Top-of-The-Line 'Blue Star' Brand

Heavy Hex Female End
By Male Water Thread
Working Pressures: 1/2" I.D. 300 P.S.I.,
5/8" and 3/4" I.D. 250 P.S.I.
Temp: -15°F to +150°F, -26°C to +66°C

PART No.	Length (FT.)	Actual I.D. (IN.)	Working Pressure (P.S.I.)
WH8BLU-25H	25	1/2	300
WH8BLU-50H	50	1/2	300
WH8BLU-75H	75	1/2	300
WH8BLU-100H	100	1/2	300
WH10BLU-25H	25	5/8	250
WH10BLU-50H	50	5/8	250
WH10BLU-75H	75	5/8	250
WH10BLU-100H	100	5/8	250
WH12BLU-25H	25	3/4	250
WH12BLU-50H	50	3/4	250
WH12BLU-75H	75	3/4	250
WH12BLU-100H	100	3/4	250



Quality PVC Assemblies

Heavy Hex Female End
By Male Water Thread
Working Pressures: 150 P.S.I.,
Temp: +25°F to +150°F, -4°C to +66°C

PART No.	Length (FT.)	Actual I.D. (IN.)	Working Pressure (P.S.I.)
WHRV8BLU-25H	25	1/2	150
WHRV8BLU-50H	50	1/2	150
WHRV8BLU-100H	100	1/2	150



High Quality 'Black Star' Rubber

Double or Heavy Hex Female End
By Male Water Thread
Working Pressure: 1/2", 5/8" 200 P.S.I.
and 3/4" I.D. 150 P.S.I.
Temp: -20°F to +200°F, -29°C to +93°C

PART No.	Length (FT.)	Actual I.D. (IN.)	Working Pressure (P.S.I.)
WH8BLK-25H	25	1/2	200
WH8BLK-50H	50	1/2	200
WH8BLK-75H	75	1/2	200
WH8BLK-100H	100	1/2	200
WH10BLK-25H	25	5/8	200
WH10BLK-50H	50	5/8	200
WH10BLK-75H	75	5/8	200
WH10BLK-100H	100	5/8	200
WH12BLK-25H	25	3/4	150
WH12BLK-50H	50	3/4	150
WH12BLK-75H	75	3/4	150
WH12BLK-100H	100	3/4	150



High Quality 'Green Star' Rubber

Heavy Hex Female End
By Male Water Thread
Working Pressure: 1/2" I.D. 200 P.S.I.
Temp: -20°F to +200°F, -29°C to +93°C

PART No.	Length (FT.)	Actual I.D. (IN.)	Working Pressure (P.S.I.)
WH8GRN-25H	25	1/2	200
WH8GRN-50H	50	1/2	200
WH8GRN-100H	100	1/2	200



Commercial 'Yellow Star' Brand

Heavy Hex Female End
By Male Water Thread
Working Pressure: 1/2" I.D. 125 P.S.I.
Temp: +25°F to +150°F, -4°C to +65°C

PART No.	Length (FT.)	Actual I.D. (IN.)	Working Pressure (P.S.I.)
WH8YEL-25H	25	1/2	125
WH8YEL-50H	50	1/2	125
WH8YEL-100H	100	1/2	125
WH12YEL-50H	50	3/4	125



Green Super Flex - Low Temp

Heavy Hex Female End
By Male Water Thread
Working Pressure: 1/2" I.D. 300 P.S.I.
Temp: -40°F to +150°F, -40°C to +65°C

PART No.	Length (FT.)	Actual I.D. (IN.)	Working Pressure (P.S.I.)
WHGL8GRN-25H	25	1/2	300
WHGL8GRN-50H	50	1/2	300
WHGL8GRN-75H	75	1/2	300
WHGL8GRN-100H	100	1/2	300

NOTE: WORKING PRESSURE RATED AT +70°F, +21°C. ANY AMBIENT OR INTERNAL INCREASE IN TEMPERATURE WILL LOWER THE WORKING PRESSURE.

C

P.V.C. COMMERCIAL WATER HOSE

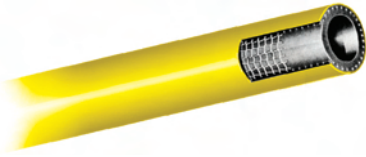

This bright yellow P.V.C. hose has been the choice of factories and municipalities where high visibility is a necessity.

- **COLOR:** Yellow
- **TEMPERATURE:** +25°F to +150°F, -4°C to +65°C
- **PACKAGING:** 300 FT Coils
- **FITTINGS:** Page 30
- **ASSEMBLIES:** Page 89

3/4 I.D. run to order.

PART No.	Actual I.D. (IN.)	Hose O.D. (IN.)	Working Pressure (P.S.I.)	Coil Length (FT.)
GH-8YEL-300	1/2	.690	125	300

NOTE: WORKING PRESSURE RATED AT +70°F, +21°C. ANY AMBIENT OR INTERNAL INCREASE IN TEMPERATURE WILL LOWER THE WORKING PRESSURE.

RUBBER (EPDM) DISHWASHER HOSE

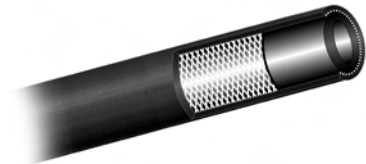

This flexible non-corrosive core, yarn reinforced black hose is designed for the discharge of water from automatic dishwashers, and other similar applications.

- **COLOR:** Black
- **TEMPERATURE:** -40°F to +190°F, -40°C to +88°C
- **CLAMPS:** HC5, HC6 Page 150

PART No.	Actual I.D. (IN.)	Hose O.D. (IN.)	Working Pressure P.S.I.	Packaging
DWH-10-50	5/8	.910	100	Carton
DWH-10-100	5/8	.910	100	Coil
DWH-10-REEL	5/8	.910	100	500' Reel

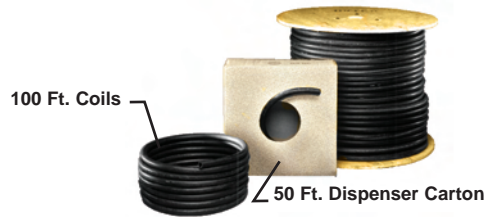

NOTE: WORKING PRESSURE RATED AT +70°F, +21°C. ANY AMBIENT OR INTERNAL INCREASE IN TEMPERATURE WILL LOWER THE WORKING PRESSURE.

SEWER CLEANING HOSE ASSEMBLIES



- OEM and Aftermarket High Pressure Sewer Cleaning Hose
- Abrasion, Cut and Water Resistant • Superior Kink Resistance
- Low Volumetric Expansion • Available in 1", 3/4" and 1/2" Hose I.D. and 500', and 600' Lengths
- **CONSTRUCTION:** Reinforcement - High Tensile Synthetic Fiber
- **TUBE:** Core - Polyolefin
- **COVER:** Polyurethane, Bonded to the Reinforcement
- **COLOR:** Available in Orange, Blue, Green and Black
- **TEMPERATURE:** -40°F to 122°F (-40°C to 50°C)
- **FITTINGS:** Page: 74

PART No.	Color	Actual I.D. (IN.)	Hose O.D. (IN.)	Working Pressure (P.S.I.)	Approx. Wgt./ Ft. (LBS.)	Permanent Coupling End	Assembly Length (FT.)
SCH-8BLK-600	Black	1/2	0.870	4,000	0.19	1/2 Male Pipe	600
SCH-8BLU-500	Blue	1/2	0.870	4,000	0.19	1/2 Male Pipe	500
SCH-8GRN-500	Green	1/2	0.834	4,000	0.16	1/2 Male Pipe	500
SCH-12BLU-600	Blue	3/4	1.180	3,000	0.29	3/4 Male Pipe	600
SCH-12ORA-500	Orange	3/4	1.180	2,500	0.28	3/4 Male Pipe	500
SCH-16BLU-600	Blue	1	1.475	3,000	0.41	1 Male Pipe	600
SCH-16ORA-500	Orange	1	1.460	2,500	0.40	1 Male Pipe	500
SCH-16ORA-600	Orange	1	1.460	2,500	0.40	1 Male Pipe	600

BULK PRESSURE WASH HOSE



(4000 P.S.I.)

Two Star (PW2) is a one wire construction, black covered hose. (also available in blue) Its' tube is specially formulated to handle high pressure water. Suitable for pressures up to 4000 P.S.I., at +70°F,(+21°C), or temperatures up to +250°F,(+121°C) at lower pressures.



NON-MARKING COVER (3000 P.S.I.)

Three Star (PW3) is a one wire construction hose with a special blue non-marking cover. Suitable for pressures up to 3000 P.S.I., at +70°F,(+21°C), or temperatures up to +250°F,(+121°C) at lower pressures.



GREY COVER (6000 P.S.I.)

Four Star (PW4) is a two wire construction, grey covered hose. Suitable for pressures up to 6000 P.S.I., at +70°F,(+21°C) or temperatures up to +250°F,(+121°C), at lower pressures.



RED NON-MARKING HIGH-TEMP. (3000 P.S.I.)

Heat-Star-Combo (PW5) is a one wire construction, red non-marking heat resistant covered, dual purpose hose. This hose will handle steam up to +325°F,(+163°C) at 350 P.S.I. with a 10:1 safety factor and hot water to +250°F,(+121°C) at 3000 P.S.I.

NOTE: The outer cover of PW5 hose must be skived (removed) before attaching over the wire crimp ends.



GAUNTLET YELLOW CARBRYN (ORS) COVER (3000 P.S.I.)

Six Star (PW6 Gauntlet) is a yellow carbryn (ORS-RMA CLASS A) covered hose providing superior strength, flexibility, abrasion resistance and long service life. Excellent resistance to oils and animal fats. Suitable for pressures up to 3000 P.S.I., at +70°F, (+21°C), or temperatures up to +250°F,(+121°C) at lower pressures.



PART No.	Color	Actual I.D. (IN.)	Working Pressure (P.S.I)	Approx. Wgt/Ft. (LBS.)	Reel Length (FT.)
PW2-6-REEL	Black	3/8	4000	.23	300
PW3-4-REEL	Blue	1/4	3000	.15	300
PW3-6-REEL	Blue	3/8	3000	.25	300
PW4-6-REEL	Grey	3/8	6000	.35	300
PW5-6-REEL	Red	3/8	3000	.21	300
PW6-6-REEL	Yellow	3/8	3000	.22	500

- CAN BE MADE TO ORDER • ALL ASSEMBLIES COME WITH THERMOPLASTIC BEND PROTECTORS • SYNTHETIC RUBBER BEND PROTECTORS ALSO AVAILABLE
- STANDARD HOSE ASSEMBLIES CONSIST OF SWIVEL MALE PIPE X SOLID MALE PIPE

NOTE: Any ambient or internal increase in temperature will lower the above listed working pressures.



STANDARD STYLE



Two Star (PW2) is a one wire construction, black, blue covered hose. (also available in blue) Its' tube is specially formulated to handle high pressure water. Suitable for pressures up to 4000 P.S.I., at +70°F,(+21°C), or temperatures up to +250°F,(+121°C) at lower pressures.

PART No.	Length (FT.)	Actual I.D (IN.)
PW2A-6-30	30	3/8
PW2A-6-50	50	3/8
PW2A-6-75	75	3/8
PW2A-6-100	100	3/8



C



Three Star (PW3) is a one wire construction hose with a special blue non-marking cover. Suitable for pressures up to 3000 P.S.I., at +70°F,(+21°C), or temperatures up to +250°F,(+121°C) at lower pressures.

PART No.	Length (FT.)	Actual I.D (IN.)
PW3A-4-30	30	1/4
PW3A-4-50	50	1/4
PW3A-4-75	75	1/4
PW3A-4-100	100	1/4
PW3A-6-25	25	3/8
PW3A-6-30	30	3/8
PW3A-6-35	35	3/8
PW3A-6-50	50	3/8
PW3A-6-75	75	3/8
PW3A-6-100	100	3/8
PW3A-6-50SW	50	3/8



Swivels on both ends available upon request. Suffix PART No. with SW. Example: PW3A-6-50SW



Four Star (PW4) is a two wire construction, grey covered hose. Suitable for pressures up to 6000 P.S.I., at +70°F,(+21°C) or temperatures up to +250°F,(+121°C), at lower pressures.

PART No.	Length (FT.)	Actual I.D (IN.)
PW4A-6-30	30	3/8
PW4A-6-50	50	3/8
PW4A-6-75	75	3/8
PW4A-6-100	100	3/8



Heat-Star-Combo (PW5) is a one wire construction, red non-marking heat resistant covered, dual purpose hose. This hose will handle steam up to +325°F,(+163°C) at 350 P.S.I. with a 10:1 safety factor and hot water to +250°F,(+121°C) at 3000 P.S.I.

PART No.	Length (FT.)	Actual I.D (IN.)
PW5A-6-30	30	3/8
PW5A-6-50	50	3/8
PW5A-6-75	75	3/8
PW5A-6-100	100	3/8



Six Star (PW6 Gauntlet) is a yellow carbryn (ORS-RMA CLASS A) covered hose providing superior strength, flexibility, abrasion resistance and long service life. Excellent resistance to oils and animal fats. Suitable for pressures up to 3000 P.S.I., at +70°F, (+21°C), or temperatures up to +250°F,(+121°C) at lower pressures.

PART No.	Length (FT.)	Actual I.D (IN.)
PW6A-6-30	30	3/8
PW6A-6-50	50	3/8
PW6A-6-100	100	3/8



- CAN BE MADE TO ORDER • ALL ASSEMBLIES COME WITH THERMOPLASTIC BEND PROTECTORS • SYNTHETIC RUBBER BEND PROTECTORS ALSO AVAILABLE
- STANDARD HOSE ASSEMBLIES CONSIST OF SWIVEL MALE PIPE X SOLID MALE PIPE

NOTE: Any ambient or internal increase in temperature will lower the above listed working pressures.

KARCHER STYLE



Two Star (PW2) is a one wire construction, black, blue covered hose. (also available in blue) Its' tube is specially formulated to handle high pressure water. Suitable for pressures up to 4000 P.S.I., at +70°F,(+21°C), or temperatures up to +250°F,(+121°C) at lower pressures.

PART No.	Length (FT.)	Actual I.D (IN.)
PW2K-6-20	20	3/8
PW2K-6-30	30	3/8
PW2K-6-50	50	3/8



Complete with KARCHER style M22 X 1.5 female swivel power washer machine attachments on both ends.



Three Star (PW3 Neptune) is a one wire construction hose with a special blue non-marking cover, (also available with Yellow non-marking cover in 3/8 size). Suitable for pressures up to 3000 P.S.I., at +70°F,(+21°C), or temperatures up to +250°F,(+121°C) at lower pressures.

PART No.	Length (FT.)	Actual I.D (IN.)
PW3K-6-30	30	3/8
PW3K-6-50	50	3/8



Complete with KARCHER style M22 X 1.5 female swivel power washer machine attachments on both ends.



Four Star (PW4) is a two wire construction, grey covered hose. Suitable for pressures up to 5800 P.S.I., at +70°F,(+21°C) or temperatures up to +250°F,(+121°C), at lower pressures.

PART No.	Length (FT.)	Actual I.D (IN.)
PW4K-6-50	50	3/8



Complete with KARCHER style M22 X 1.5 female swivel power washer machine attachments on both ends.

- CAN BE MADE TO ORDER • ALL ASSEMBLIES COME WITH THERMOPLASTIC BEND PROTECTORS • SYNTHETIC RUBBER BEND PROTECTORS ALSO AVAILABLE
- STANDARD HOSE ASSEMBLIES CONSIST OF SWIVEL POWER WASHER MACHINE ATTACHMENTS BOTH ENDS

NOTE: Any ambient or internal increase in temperature will lower the above listed working pressures.

C

RUBBER AIR BRAKE HOSE

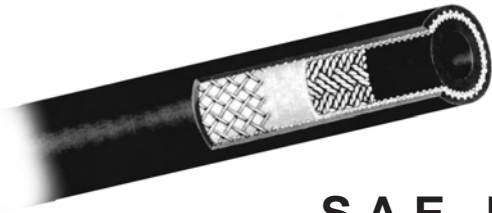

S.A.E. J1402

Rubber air brake hose is for use in truck and trailer air brake systems. It is certified to meet S.A.E. J1402 and D.O.T. F.M.V.S.S. 106 requirements. This air brake hose features a synthetic rubber oil-resistant tube and cover which is reinforced with synthetic cord for high performance strength.

MEETS – D.O.T. F.M.V.S.S. 106

HAB-6: MEETS TABLE AI AND TABLE AII
HAB-8: MEETS TABLE A

- **TEMPERATURE:** -40°F to +200°F, -40°C to +93°C
- **PACKAGING:** Reels
- **FITTINGS:** 1490 Series Page 28
- **FACTORY ASSEMBLIES:** Page 95 - 98

PART No.	Actual I.D. (IN.)	Hose O.D. (IN.)	Working Pressure (P.S.I.)	Reel Length (FT.)
HAB-6-REEL	3/8	.750	225	250
HAB-8-REEL	1/2	.875	225	250

ARCTIC AIR BRAKE HOSE

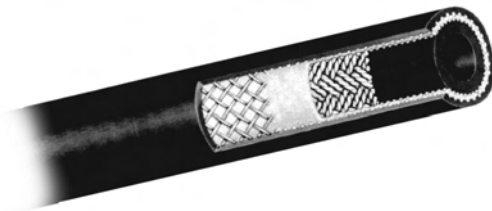

S.A.E. J1402

Rubber air brake hose is for use in truck and trailer air brake systems. It is certified to meet S.A.E. J1402 and D.O.T. F.M.V.S.S. 106 requirements. This air brake hose features a synthetic rubber tube and cover designed for low temperatures. It is oil-resistant and reinforced with spiral polyester cord for high performance strength.

MEETS – D.O.T. F.M.V.S.S. 106

HABA-6: MEETS TABLE AI AND TABLE AII
HABA-8: MEETS TABLE A

- **TEMPERATURE:** -65°F to +200°F, -54°C to +93°C
- **PACKAGING:** Reels
- **FITTINGS:** 1490 Series Page 28
- **FACTORY ASSEMBLIES:** Page 95 - 98

PART No.	Actual I.D. (IN.)	Hose O.D. (IN.)	Working Pressure (P.S.I.)	Reel Length (FT.)
HABA-6-REEL	3/8	.750	200	250
HABA-8-REEL	1/2	.875	200	250

CAUTION: Some agents used in the curing of rubber hose may leach out over time. Trace amounts may be enough to cause problems for sensitive hands. Gloves should be worn and care taken in handling of rubber hose products.



RUBBER AIR BRAKE HOSE ASSEMBLIES -40°F to +200°F, -40°C to +93°C TEMPERATURE RANGE

- D.O.T. Listed • 225 P.S.I. Working Pressure • -40°F to +200°F, -40°C to +93°C
- Many Other Common Lengths Available From Stock. Custom Lengths On Request.
- For Assemblies Requiring -65°F, -54°C Cold Weather Arctic Hose Simply Replace "HAB" Prefix With "HABA" (HABA-6-24B) • Bulk Hose See Page 94 • Display Rack Page 262

Length
From 0 up to and including 36"
For Lengths above 36"
length measured to the nearest 1/8 of an inch.

Tolerance
±1/4"
±1% of

SWIVEL MALE PIPE	RIGID MALE PIPE	PART No.	Pipe Size	Hose I.D. (IN.)	Length (IN.)
		HAB-6-18B	1/4	3/8	18
		HAB-6-20B	1/4	3/8	20
		HAB-6-22B	1/4	3/8	22
		HAB-6-24B	1/4	3/8	24
		HAB-6-26B	1/4	3/8	26
		HAB-6-28B	1/4	3/8	28
		HAB-6-30B	1/4	3/8	30
		HAB-6-32B	1/4	3/8	32
		HAB-6-36B	1/4	3/8	36
		HAB-6-40B	1/4	3/8	40
		HAB-6-42B	1/4	3/8	42
		HAB-6-48B	1/4	3/8	48
		HAB-6-60B	1/4	3/8	60

SWIVEL MALE PIPE	RIGID MALE PIPE	PART No.	Pipe Size	Hose I.D. (IN.)	Length (IN.)
		HAB-6-12C	3/8	3/8	12
		HAB-6-14C	3/8	3/8	14
		HAB-6-16C	3/8	3/8	16
		HAB-6-18C	3/8	3/8	18
		HAB-6-20C	3/8	3/8	20
		HAB-6-22C	3/8	3/8	22
		HAB-6-24C	3/8	3/8	24
		HAB-6-26C	3/8	3/8	26
		HAB-6-28C	3/8	3/8	28
		HAB-6-30C	3/8	3/8	30
		HAB-6-32C	3/8	3/8	32
		HAB-6-34C	3/8	3/8	32
		HAB-6-36C	3/8	3/8	36
		HAB-6-38C	3/8	3/8	38
		HAB-6-40C	3/8	3/8	40
		HAB-6-42C	3/8	3/8	42
		HAB-6-44C	3/8	3/8	44
		HAB-6-46C	3/8	3/8	46
		HAB-6-48C	3/8	3/8	48
		HAB-6-50C	3/8	3/8	50
		HAB-6-52C	3/8	3/8	52
		HAB-6-54C	3/8	3/8	54
		HAB-6-56C	3/8	3/8	56
		HAB-6-58C	3/8	3/8	58
HAB-6-60C	3/8	3/8	60		
HAB-6-72C	3/8	3/8	72		
HAB-6-76C	3/8	3/8	76		
HAB-6-84C	3/8	3/8	84		
HAB-6-96C	3/8	3/8	96		
HAB-6-108C	3/8	3/8	108		
HAB-6-120C	3/8	3/8	120		

CAUTION: Some agents used in the curing of rubber hose may leach out over time. Trace amounts may be enough to cause problems for sensitive hands. Gloves should be worn and care taken in handling of rubber hose products.



CRIMPED AIR BRAKE ASSEMBLIES D.O.T.

RUBBER AIR BRAKE HOSE ASSEMBLIES -40°F to +200°F, -40°C to +93°C TEMPERATURE RANGE

- D.O.T. Listed • 225 P.S.I. Working Pressure • -40°F to +200°F, -40°C to +93°C
- Many Other Common Lengths Available From Stock. Custom Lengths On Request.
- For Assemblies Requiring -65°F, -54°C Cold Weather Arctic Hose Simply Replace "HAB" Prefix With "HABA" (HABA-6-24B) • Bulk Hose See Page 94 • Display Rack Page 262

Length
From 0 up to and including 36"
For Lengths above 36"
length measured to the nearest 1/8 of an inch.

Tolerance
±1/4"
±1% of

SWIVEL MALE PIPE SWIVEL MALE PIPE



PART No.	SW Pipe Size	Hose I.D. (IN.)	Length (IN.)
HAB-6-18C-SW	3/8	3/8	18
HAB-6-20C-SW	3/8	3/8	20
HAB-6-22C-SW	3/8	3/8	22
HAB-6-24C-SW	3/8	3/8	24
HAB-6-26C-SW	3/8	3/8	26
HAB-6-28C-SW	3/8	3/8	28
HAB-6-30C-SW	3/8	3/8	30
HAB-6-32C-SW	3/8	3/8	32
HAB-6-34C-SW	3/8	3/8	34
HAB-6-36C-SW	3/8	3/8	36
HAB-6-38C-SW	3/8	3/8	38
HAB-6-40C-SW	3/8	3/8	40
HAB-6-42C-SW	3/8	3/8	42
HAB-6-44C-SW	3/8	3/8	44
HAB-6-46C-SW	3/8	3/8	46
HAB-6-48C-SW	3/8	3/8	48
HAB-6-50C-SW	3/8	3/8	50
HAB-6-52C-SW	3/8	3/8	52
HAB-6-54C-SW	3/8	3/8	54
HAB-6-56C-SW	3/8	3/8	56
HAB-6-60C-SW	3/8	3/8	60

SWIVEL FEMALE FLARE SWIVEL FEMALE FLARE



PART No.	Flare Size	Hose I.D. (IN.)	Length (IN.)
HAB-6-18FS	3/8	3/8	18
HAB-6-20FS	3/8	3/8	20
HAB-6-22FS	3/8	3/8	22
HAB-6-24FS	3/8	3/8	24
HAB-6-26FS	3/8	3/8	26
HAB-6-28FS	3/8	3/8	28
HAB-6-30FS	3/8	3/8	30
HAB-6-32FS	3/8	3/8	30
HAB-6-36FS	3/8	3/8	36
HAB-6-42FS	3/8	3/8	42
HAB-6-48FS	3/8	3/8	48
HAB-6-60FS	3/8	3/8	60

1/2 SWIVEL MALE PIPE 3/8 RIGID MALE PIPE



PART No.	Pipe Size	Hose I.D. (IN.)	Length (IN.)
HAB-8-18CD	1/2 TO 3/8	1/2	18
HAB-8-24CD	1/2 TO 3/8	1/2	24
HAB-8-28CD	1/2 TO 3/8	1/2	28
HAB-8-30CD	1/2 TO 3/8	1/2	30
HAB-8-34CD	1/2 TO 3/8	1/2	34
HAB-8-36CD	1/2 TO 3/8	1/2	36
HAB-8-42CD	1/2 TO 3/8	1/2	42

CAUTION: Some agents used in the curing of rubber hose may leach out over time. Trace amounts may be enough to cause problems for sensitive hands. Gloves should be worn and care taken in handling of rubber hose products.



RUBBER AIR BRAKE HOSE ASSEMBLIES -40°F to +200°F, -40°C to +93°C TEMPERATURE RANGE

- D.O.T. Listed • 225 P.S.I. Working Pressure • -40°F to +200°F, -40°C to +93°C
- Many Other Common Lengths Available From Stock. Custom Lengths On Request.
- For Assemblies Requiring -65°F, -54°C Cold Weather Arctic Hose Simply Replace "HAB" Prefix With "HABA" (HABA-6-24B) • Bulk Hose See Page 94 • Display Rack See Page 262

Length From 0 up to and including 36" For Lengths above 36" length measured to the nearest 1/8 of an inch.

Tolerance ±1/4" ±1% of

SWIVEL MALE PIPE	RIGID MALE PIPE	PART No.	Pipe Size	Hose I.D. (IN.)	Length (IN.)
		HAB-8-14C	3/8	1/2	14
		HAB-8-16C	3/8	1/2	16
		HAB-8-18C	3/8	1/2	18
		HAB-8-20C	3/8	1/2	20
		HAB-8-22C	3/8	1/2	22
		HAB-8-24C	3/8	1/2	24
		HAB-8-26C	3/8	1/2	26
		HAB-8-28C	3/8	1/2	28
		HAB-8-30C	3/8	1/2	30
		HAB-8-32C	3/8	1/2	32
		HAB-8-34C	3/8	1/2	34
		HAB-8-36C	3/8	1/2	36
		HAB-8-38C	3/8	1/2	38
		HAB-8-40C	3/8	1/2	40
		HAB-8-42C	3/8	1/2	42
		HAB-8-44C	3/8	1/2	44
		HAB-8-46C	3/8	1/2	46
		HAB-8-48C	3/8	1/2	48
		HAB-8-50C	3/8	1/2	50
		HAB-8-52C	3/8	1/2	52
		HAB-8-54C	3/8	1/2	54
		HAB-8-56C	3/8	1/2	56
		HAB-8-58C	3/8	1/2	58
		HAB-8-60C	3/8	1/2	60
HAB-8-66C	3/8	1/2	66		
HAB-8-72C	3/8	1/2	72		
HAB-8-80C	3/8	1/2	80		
HAB-8-84C	3/8	1/2	84		
HAB-8-96C	3/8	1/2	96		

SWIVEL MALE PIPE	SWIVEL MALE PIPE	PART No.	Pipe Size	Hose I.D. (IN.)	Length (IN.)
		HAB-8-16C-SW	3/8	1/2	16
		HAB-8-18C-SW	3/8	1/2	18
		HAB-8-20C-SW	3/8	1/2	20
		HAB-8-22C-SW	3/8	1/2	22
		HAB-8-24C-SW	3/8	1/2	24
		HAB-8-26C-SW	3/8	1/2	26
		HAB-8-28C-SW	3/8	1/2	28
		HAB-8-30C-SW	3/8	1/2	30
		HAB-8-32C-SW	3/8	1/2	32
		HAB-8-34C-SW	3/8	1/2	34
		HAB-8-36C-SW	3/8	1/2	36
		HAB-8-38C-SW	3/8	1/2	38
		HAB-8-40C-SW	3/8	1/2	40
		HAB-8-42C-SW	3/8	1/2	42
		HAB-8-44C-SW	3/8	1/2	44
		HAB-8-46C-SW	3/8	1/2	46
		HAB-8-48C-SW	3/8	1/2	48
		HAB-8-50C-SW	3/8	1/2	50
		HAB-8-52C-SW	3/8	1/2	52
		HAB-8-54C-SW	3/8	1/2	54
		HAB-8-56C-SW	3/8	1/2	56
		HAB-8-60C-SW	3/8	1/2	60
		HAB-8-66C-SW	3/8	1/2	66
		HAB-8-72C-SW	3/8	1/2	72
HAB-8-80C-SW	3/8	1/2	80		
HAB-8-84C-SW	3/8	1/2	84		
HAB-8-96C-SW	3/8	1/2	96		

CAUTION: Some agents used in the curing of rubber hose may leach out over time. Trace amounts may be enough to cause problems for sensitive hands. Gloves should be worn and care taken in handling of rubber hose products.

S.A.E. J844 RETRACTABLE AIR BRAKE COILS

- **MEETS:** S.A.E. J884D Type 3B D.O.T. F.M.V.S.S. 106
- **COLORS:** Red, Blue
- **TEMPERATURE:** -65°F to +200°F, -54°C to +93°C
- **PACKAGING:** As a Set of One Red and One Blue.
- **FITTINGS:** 1/2" Male Pipe Each End.

Pulling the coil inside out restores the spring set making the assembly like new.

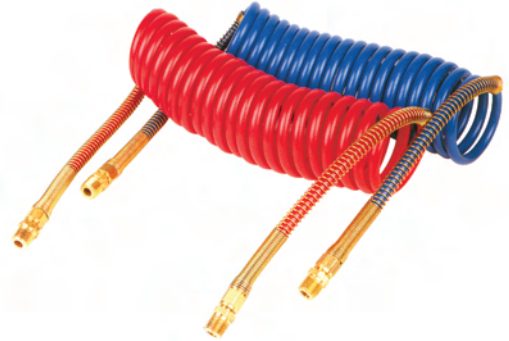

NOTE
WORKING PRESSURE RATED AT +70°F +21°C. ANY AMBIENT OR INTERNAL INCREASE IN TEMPERATURE WILL LOWER THE WORKING PRESSURE.

PART No.	Working Length (FT.)	Tube O.D. (IN.)	Pigtail Length (IN.)	Male Pipe Ends	Low Temp Range
1486L-8-15	15	1/2	12"	1/2	-65°F, -54°C
1486L-8-20	20	1/2	12"	1/2	-65°F, -54°C
1486L-8RED-15	15	1/2	12"	1/2	-65°F, -54°C
1486L-8BLU-15	15	1/2	12"	1/2	-65°F, -54°C

THESE PART NUMBERS REPRESENT A SET OF ONE RED AND ONE BLUE ASSEMBLY.

THESE PART NUMBERS REPRESENT INDIVIDUAL ASSEMBLIES RED OR BLUE. (15 FT. LENGTH ONLY)

FIFTH WHEEL SLIDER ASSEMBLY

- **MEETS:** S.A.E. J884D TYPE 3A D.O.T. F.M.V.S.S. 106
 - **COLOR:** Black
 - **TEMPERATURE:** -40°F to +200°F, -40°C to +93°C
 - **FITTINGS:** 360° Brass Working Male Pipe Swivel Each End.
- For Complete Kit See Page 106, 232
For Fifth Wheel Cylinder See Page 232



NOTE
WORKING PRESSURE RATED AT +70°F +21°C. ANY AMBIENT OR INTERNAL INCREASE IN TEMPERATURE WILL LOWER THE WORKING PRESSURE.

PART No.	Working Length (FT.)	Tube O.D. (IN.)	Pigtail Length (IN.)	Male Pipe Ends
1486S-4-10	10	1/4	4	1/4

AIR ASSEMBLY WITH GLADHAND

Connects directly to the Gladhand port on a truck cab. This assembly is complete with air chuck end which allows for the easy filling of tires.

BC-B-DF
Dual Foot Chuck



GHU
Universal Gladhand



PART No.	Desc.	Actual I.D. (IN.)	Length (FT.)	Working Pressure (P.S.I.)
GL6RED-50GHU-DF	Super-Flex	3/8	50	300
GL6YEL-50GHU-DF	Super-Flex	3/8	50	300

* Other lengths available. •



S.A.E. 100R5

ONE WIRE BRAID
TWO COTTON BRAIDS
(NON SKIVE)
COVER IS NOT REMOVED
MEETS D.O.T. F.M.V.S.S. - 106

For medium pressure hydraulic service in the handling of most hydraulic fluids, gasoline, diesel fuels, lubricating oils, air and water. Recommended for power steering and power steering return lines, fuel filters, turbo chargers, tilt lines, lube oil lines and machine tools. Not suitable for use with phosphate esters.

- **CONSTRUCTION:** Textile inner braid with single wire braid reinforcement.
- **TUBE:** Oil and heat-resistant synthetic rubber inner tube.
- **COVER:** Textile outer braid and a cotton braided black cover.
- **COLOR:** Black
- **TEMPERATURE:** -40°F to +250°F, -40°C to +121°C
- **PACKAGING:** For Reel Lengths and Carton Quantities see below. Sizes -4 to -16 available in 100 Ft. Coils.
- **FITTINGS:** SCW500 Crimp Page 69
SR500 Reusable Page 70

PART No.	Nominal I.D.	Actual I.D. (IN.)	Hose O.D. (IN.)	Working Pressure (P.S.I.)	Min. Burst Pressure (P.S.I.)	Min. Bend Radius (IN.)	Approx. Wgt. / Ft. (LBS.)	Reel Length (FT.)
HR5-4-REEL	1/4	3/16	0.52	3,000	12,000	3.00	.16	250
HR5-5-REEL	5/16	1/4	0.58	2,500	10,000	3.38	.18	250
HR5-6-REEL	3/8	5/16	0.68	2,250	9,000	4.00	.22	250
HR5-8-REEL	1/2	13/32	0.77	2,000	8,000	4.62	.27	250
HR5-10-REEL	5/8	1/2	0.92	1,750	7,000	5.50	.34	250
HR5-12-REEL	3/4	5/8	1.08	1,500	6,000	6.50	.42	250
HR5-16-REEL	1	7/8	1.24	800	3,200	7.38	.44	165
HR5-20-CTN	1-1/4	1-1/8	1.50	625	2,500	9.00	.52	100
HR5-24-CTN	1-1/2	1-3/8	1.75	500	2,000	10.50	.62	100
HR5-32-CTN	2	1-13/16	2.22	350	1,400	13.25	.93	100

BLUE HIGH TEMPERATURE S.A.E. 100R5 HOSE

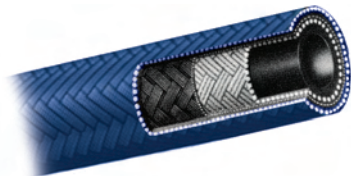

S.A.E. 100R5 HIGH TEMPERATURE

ONE WIRE BRAID
TWO COTTON BRAIDS
(NON-SKIVE)
COVER IS NOT REMOVED

For high temperature, medium to high pressure hydraulic service in the handling of most hydraulic fluids, gasoline, diesel fuels, lubricating oils and water. Recommended for power steering and power steering return lines, fuel filters, turbo chargers, tilt lines, lube oil lines, compressors and machine tools. Not suitable with phosphate esters.

- **CONSTRUCTION:** Textile inner braid with single wire braid reinforcement.
- **TUBE:** Oil and heat-resistant synthetic rubber inner tube.
- **COVER:** Textile outer braid and a cotton braided cover.
- **COLOR:** Blue
- **TEMPERATURE:** -49°F to +300°F, -55°C to +150°C
- **PACKAGING:** For Reel Lengths and Carton Quantities see below.
- **FITTINGS:** SCW500 Crimp Page 69
SR500 Reusable Page 70

PART No.	Nominal I.D.	Actual I.D. (IN.)	Hose O.D. (IN.)	Working Pressure (P.S.I.)	Min. Burst Pressure (P.S.I.)	Min. Bend Radius (IN.)	Approx. Wgt. / Ft. (LBS.)	Reel Length (FT.)
HR5HT-6-REEL	3/8	5/16	0.67	2,250	9,000	4.00	.23	300
HR5HT-8-REEL	1/2	13/32	0.76	2,000	8,000	4.62	.26	500
HR5HT-10-REEL	5/8	1/2	0.93	1,750	7,000	5.50	.37	300
HR5HT-12-REEL	3/4	5/8	1.08	1,500	6,000	6.50	.46	250
HR5HT-16-REEL	1	7/8	1.27	800	3,200	7.38	.44	190
HR5HT-20-CTN	1-1/4	1-1/8	1.50	625	2,500	9.00	.52	90
HR5HT-24-CTN	1-1/2	1-3/8	1.75	500	2,000	10.50	.67	60

FUEL LINE HOSE

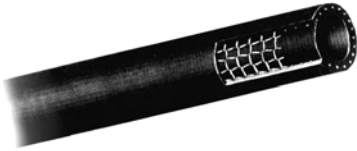

S.A.E. 30R7

Designed to convey most fuels in cars, trucks, buses etc. Durable cover resists deterioration from oil, grease, heat and ozone and gives long service life.

NOTE: FLH IS NOT DESIGNED FOR MARINE USE WITH ALCOHOL BLENDED FUELS.

- **MEETS:** S.A.E. 30R7
- **COLOR:** Black
- **TEMPERATURE:** -40°F to +257°F, -40°C to +125°C
- **PACKAGING:** 250 FT Reels, 50 and 100 FT Coils
- **FITTINGS:** Hose Barbs Page 58
- **CLAMPS:** HC5 & HC6 Page 150

PART No.	Actual I.D. (IN.)	Hose O.D. (IN.)	Length (FT.)	Working Pressure (P.S.I.)	Min. Burst Pressure (P.S.I.)
FLH-3-25	3/16	.406	25	50	250
FLH-3-50	3/16	.406	50	50	250
FLH-3-100	3/16	.406	100	50	250
FLH-3-250	3/16	.406	250	50	250
FLH-4-25	1/4	.500	25	50	250
FLH-4-50	1/4	.500	50	50	250
FLH-4-100	1/4	.500	100	50	250
FLH-4-250	1/4	.500	250	50	250
FLH-5-25	5/16	.563	25	50	250
FLH-5-50	5/16	.563	50	50	250
FLH-5-100	5/16	.563	100	50	250
FLH-5-250	5/16	.563	250	50	250
FLH-6-25	3/8	.625	25	50	250
FLH-6-50	3/8	.625	50	50	250
FLH-6-100	3/8	.625	100	50	250
FLH-6-250	3/8	.625	250	50	250

NOTE: WORKING PRESSURE RATED AT +70°F, +21°C. ANY AMBIENT OR INTERNAL INCREASE IN TEMPERATURE WILL LOWER THE WORKING PRESSURE.

BREATHING AIR HOSE



Specially designed non-toxic air breathing hose that provides low temperature flexibility and low odor.

- **CONSTRUCTION:** High tensile strength yarn reinforcement.
- **TUBE:** Clear PVC compound, formulated in compliance with FDA⁽⁰³⁾ and RoHS⁽¹⁵⁾ requirements.
- **COVER:** Cover Non-toxic, u.v. and weather resistant PVC compound.
- **COLOR:** Black
- **TEMPERATURE:** -15°F to +150°F, -26°C to +65°C
- **TEMPERATURE:(HBAL Low Temp)** -40°F to +150°F, -40°C to +65°C
- **PACKAGING:** For Reel Lengths and Coils see below.
- **FITTINGS:** Hose Barbs Page 58

PART No.	Actual I.D. (IN.)	Hose O.D. (IN.)	Working Pressure (P.S.I.)	Coil Length (FT.)
HBA-6-REEL	3/8	.688	250	300
HBAL-6-REEL	3/8	.720	300	300





STAINLESS STEEL BRAIDED PTFE HOSE

(MEDIUM PRESSURE SMOOTH BORE)



S.A.E. 100R14

• TYPICAL USES INCLUDE

Pneumatic, hot oil lines, steam lines, food processing, paint spray, compressor discharge, gases, chemical lines, steering lines, brake lines, high pressure hydraulic lines.

PTFE hose can solve almost all “problem” applications. It is suitable for use with steam, solvents, fuels, hydraulic fluids, most chemicals and acids. Vibration absorption, extra long shelf life, high temperature and pressure ranges, make PTFE hose the most versatile hose in the industry today.

- **CONSTRUCTION:** Braided Outer Cover
- **TUBE:** PTFE Inner Tube
- **COVER:** Stainless Steel (TYPE 304)
- **TEMPERATURE:** -65°F to + 450°F, -54°C to +232°C
- **PACKAGING:** Bulk Coils - Random Lengths
- **FITTINGS:** SCT400 One Piece Crimp Page 71
SR400 Reusable End Page 72

PART No.	Nominal I.D.	Actual I.D. (IN.)	Hose O.D. (IN.)	Working Pressure (P.S.I.)	Min. Burst Pressure (P.S.I.)	Min. Bend Radius (IN.)
HT-4	1/4	3/16	.30	3000	12000	1.50
HT-5	5/16	1/4	.38	3000	12000	2.00
HT-6	3/8	5/16	.44	2500	10000	3.50
HT-8	1/2	13/32	.54	2000	8000	4.50
HT-10	5/8	1/2	.63	1750	7000	5.00
HT-12	3/4	5/8	.76	1500	6000	6.00
HT-16	1	7/8	1.03	1000	4000	9.00
HT-20	1-1/4	1-1/8	1.29	750	3000	16.00

NOTE: WORKING PRESSURE RATED AT +70°F, +21°C. ANY AMBIENT OR INTERNAL INCREASE IN TEMPERATURE WILL LOWER THE WORKING PRESSURE.

HOW TO ORDER CUSTOM FACTORY CRIMPED PTFE HOSE ASSEMBLIES (STAINLESS STEEL BRAIDED COVER - BRASS ENDS)

AIR BRAKE
COMPRESSION



STRAIGHT
TUBE

SAMPLE HOSE ASSEMBLY PART NUMBER					HOSE END FITTING CODE		SIZE CODE INCHES	
HT	10	C	60	AC10 ST10	AC	AIRBRAKE COMPRESSION	2	1/8
Hose Series	Nominal I.D. Inches	Crimp Ends	Length Inches	Fitting Code and Size Code	FJ	FEMALE SWIVEL 37° (J.I.C.) FLARE	4	1/4
					FS	FEMALE SWIVEL 45° (S.A.E.) FLARE	5	5/16
					MI	MALE INVERTED FLARE SWIVEL	6	3/8
					MP	MALE PIPE	8	1/2
					ST	STRAIGHT TUBE	10	5/8
							12	3/4
							16	1
							20	1-1/4

WE CAN ALSO SUPPLY FACTORY MADE REUSABLE STYLE HOSE ASSEMBLIES. TO ORDER SIMPLY CHANGE C (CRIMP) TO R (REUSABLE).

EXAMPLE: HT10R60AC10ST10

NOTE: LIST END FITTING ALPHABETICALLY

SILICONE HEATER HOSE



S.A.E. 20R3 CLASS A

PART No.	Actual I.D. (IN.)	Hose O.D. (IN.)	Min. Burst Pressure (P.S.I.)
HHS-6-50	3/8	.707	310
HHS-8-50	1/2	.875	310
HHS-10-50	5/8	1.00	300
HHS-12-50	3/4	1.125	300
HHS-14-50	7/8	1.25	200
HHS-16-50	1	1.375	250

Recommended for extra high-temp heater connections, air-pump discharge and any similar uses.

- **MEETS:** S.A.E. 20R3 Class A (Tested To J20E PART VI)
- **COLOR:** Blue
- **TEMPERATURE:** -65°F to +350°F, -54°C to +177°C
- **PACKAGING:** 50 Foot Coils
- **FITTINGS:** Hose Barbs Page 56 - 57
- **CLAMPS:** Page 150

TRUCK SILICONE COOLANT HOSE

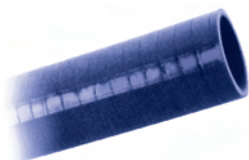

S.A.E. J20 R1 CLASS A

PART No.	Actual I.D. (IN.)	Hose O.D. (IN.)	Working Pressure (P.S.I.)
CHS-12-4	3/4	1.14	80
CHS-14-4	7/8	1.27	80
CHS-16-4	1	1.37	75
CHS-18-4	1-1/8	1.52	75
CHS-20-4	1-1/4	1.64	65
CHS-22-4	1-3/8	1.77	65
CHS-24-4	1-1/2	1.89	60
CHS-26-4	1-5/8	2.02	60
CHS-28-4	1-3/4	2.14	55
CHS-32-4	2	2.37	50

4 Ply silicone coolant hose reinforced with polyester fabric and coated with specially compounded silicone elastomer. Ideal for extreme temperatures and various pressure ranges.

- **MEETS OR EXCEEDS:** S.A.E. J20 R1 Class A
- **COLOR:** Blue
- **TEMPERATURES:** -65°F to +350°F, -54°C to +177°C
- **PACKAGING:** 4 Foot Lengths (Eg. FOR 8 FT. ORDER 2 PCS.)
- **CLAMPS:** Page 150

PART No.	Actual I.D. (IN.)	Hose O.D. (IN.)	Working Pressure (P.S.I.)
CHS-36-4	2-1/4	2.64	40
CHS-38-4	2-3/8	2.77	40
CHS-40-4	2-1/2	2.89	35
CHS-42-4	2-5/8	3.00	35
CHS-44-4	2-3/4	3.14	30
CHS-46-4	2-7/8	3.25	30
CHS-48-4	3	3.39	25
CHS-52-4	3-1/4	3.64	25
CHS-56-4	3-1/2	3.89	15
CHS-64-4	4	4.37	10

NOTE: WORKING PRESSURE RATED AT +70°F, +21°C. ANY AMBIENT OR INTERNAL INCREASE IN TEMPERATURE WILL LOWER THE WORKING PRESSURE.

TRUCK SILICONE TURBO CHARGER CONNECTOR

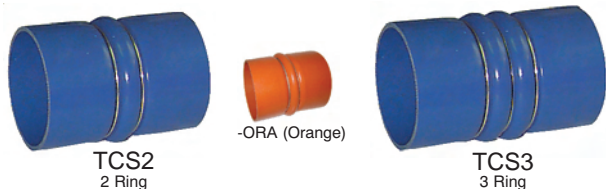

Recommended for extra high-temp turbo charger connections.

- **COLOR:** Blue (TCS2-64-6-ORA IS ORANGE)
- **TEMPERATURE:** -67°F TO +347°F, -55°C to +175°C
- **PACKAGING:** Per Piece
- **CLAMPS:** HC19 & HC20 Page 132

PART No.	Actual I.D. (IN.)	Length (IN.)
TCS2-48-6	3	6
TCS2-56-6	3-1/2	6
TCS2-64-6	4	6
TCS2-64-6-ORA	4	6
TCS2-72-6	4-1/2	6

PART No.	Actual I.D. (IN.)	Length (IN.)
TCS3-48-6	3	6
TCS3-56-6	3-1/2	6
TCS3-64-6	4	6
TCS3-64-8-ORA	4	8
TCS3-72-6	4-1/2	6

C

PREMIUM RED RUBBER HEATER HOSE

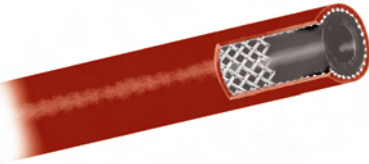

A replacement for OE on most cars and trucks. This high quality hose is for higher temperatures. Withstands the abuse of corrosive solutions and additives. Resists weathering to provide long and trouble-free service.

- **MEETS:** Similar to S.A.E. 20R3 Class D2, S.A.E. J2387
- **COLOR:** Red
- **TEMPERATURE:** -40°F to +257°F, -40C to +125°C
- **PACKAGING:** 50 FT. Coils, Reel
- **FITTINGS:** Hose Barbs Page 56 - 57
- **CLAMPS:** Page 150

PART No.	Actual I.D. (IN.)	Hose O.D. (IN.)	Min. Burst Pressure (P.S.I.)
HHR-8-50	1/2	.806	250
HHR-10-50	5/8	.932	250
HHR-10-REEL	5/8	.932	250
HHR-12-50	3/4	1.057	200

PREMIUM RED HEAVY DUTY THERMAL HEATER HOSE

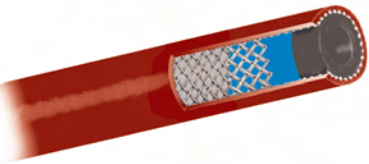

This heavy duty rubber hose with a blue insulating layer that helps to minimize heat loss. A replacement for OE on cars and trucks. Withstands the abuse of corrosive solutions and additives. Resists weathering to provide long and trouble-free service.

- **MEETS:** Similar to S.A.E. 20R3 Class D2, S.A.E. J2387
- **COLOR:** Red
- **TEMPERATURE:** -40°F to +257°F, -40C to +125°C
- **PACKAGING:** 50 FT. Coils
- **FITTINGS:** Hose Barbs Page 56 - 57
- **CLAMPS:** Page 150

PART No.	Actual I.D. (IN.)	Hose O.D. (IN.)	Min. Burst Pressure (P.S.I.)
HHP-8-50	1/2	.812	250
HHP-10-50	5/8	.937	250
HHP-12-50	3/4	1.062	200
HHP-16-50	1	1.375	175

RUBBER HEATER HOSE



This standard hose is for normal duty service. Withstands the abuse of corrosive solutions and additives. Resists weathering to provide long and trouble-free service.

- **MEETS:** Similar to S.A.E. 20R3 Class D2
- **COLOR:** Black
- **TEMPERATURE:** -40°F to +212°F, -40C to +100°C
- **PACKAGING:** 250 FT Reels, 50 FT. Coils
- **FITTINGS:** Hose Barbs Page 56 - 57
- **CLAMPS:** Page 150

PART No.	Actual I.D. (IN.)	Hose O.D. (IN.)	Min. Burst Pressure (P.S.I.)
HH-8-50	1/2	.806	200
HH-10-REEL	5/8	.932	140
HH-10-50	5/8	.932	140
HH-12-REEL	3/4	1.057	125
HH-12-50	3/4	1.057	125
HH-16-50	1	1.406	100

RUBBER COVER GRIP-TITE HOSE (PUSH-ON)



THE SPECIAL BRAIDING PROCESS USED IN THE MANUFACTURE OF THIS HOSE PERMITS THE USE OF GRIP-TITE FITTINGS, WHICH ELIMINATES THE NEED FOR CLAMPS.

A lightweight, flexible, low pressure, general purpose hose with one fiber braid reinforcement. Used for conveying hydraulic oils, mineral oils, antifreeze solutions, most agricultural sprays and other diluted chemical solutions.

- **COVER:** Rubber Covered.
- **COLORS:** Black (Standard), Blue, Green, Grey, Red
- **TEMPERATURE:** -40°F to +200°F, -40°C to +93°C
- **PACKAGING:** Bulk Reels
- **FITTINGS:** 700 Series Page 59

RANDOM REEL LENGTHS FOR COLOR HOSE:

Reel lengths Maximum 725 FT., Minimum 400 FT. (5 pieces maximum per reel with minimum 50 FT. length piece)

PART No.	Actual I.D. (IN.)	Hose O.D. (IN.)	Working Pressure (P.S.I.)	Reel Length (FT.)
761-4-REEL	1/4	1/2	300	500
761-4GRY-REEL	1/4	1/2	300	Random
761-5-REEL	5/16	5/8	300	500
761-6-REEL	3/8	5/8	300	500
761-6BLU-REEL	3/8	5/8	300	Random
761-6GRY-REEL	3/8	5/8	300	Random

PART No.	Actual I.D. (IN.)	Hose O.D. (IN.)	Working Pressure (P.S.I.)	Reel Length (FT.)
761-8-REEL	1/2	3/4	300	500
761-8BLU-REEL	1/2	3/4	300	Random
761-8GRY-REEL	1/2	3/4	300	Random
761-10-REEL	5/8	29/32	300	500
761-12-REEL	3/4	1	300	250
761-12BLU-REEL	3/4	1	300	Random

NOTE: WORKING PRESSURE RATED AT +70°F, +21°C. ANY AMBIENT OR INTERNAL INCREASE IN TEMPERATURE WILL LOWER THE WORKING PRESSURE.

FIBER COVER GRIP-TITE HOSE (PUSH-ON)



THE SPECIAL BRAIDING PROCESS USED IN THE MANUFACTURE OF THIS HOSE PERMITS THE USE OF GRIP-TITE FITTINGS, WHICH ELIMINATES THE NEED FOR CLAMPS.

A lightweight, flexible, low pressure, general purpose hose with one fiber braid reinforcement. Used for conveying hydraulic oils, mineral oils, antifreeze solutions, most agricultural sprays and other diluted chemical solutions.

- **COVER:** Fiber Covered.
- **COLOR:** Black
- **TEMPERATURE:** -40°F to +200°F, -40°C to +93°C
- **PACKAGING:** Bulk Reels.
- **FITTINGS:** 700 Series Page 59

PART No.	Actual I.D. (IN.)	Hose O.D. (IN.)	Working Pressure (P.S.I.)	Reel Length (FT.)
760-4-REEL	1/4	1/2	300	575
760-5-REEL	5/16	9/16	300	600
760-6-REEL	3/8	5/8	300	460
760-8-REEL	1/2	3/4	300	335
760-10-REEL	5/8	29/32	300	260
760-12-REEL	3/4	1	300	220

NOTE: WORKING PRESSURE RATED AT +70°F, +21°C. ANY AMBIENT OR INTERNAL INCREASE IN TEMPERATURE WILL LOWER THE WORKING PRESSURE.

C



SPECIALTY HOSE ASSEMBLIES

NYLON GREASE WHIPS



3/16" I.D. Thermoplastic, fiber reinforced hose with 1/8 steel male pipe couplings. This hose combines the best features of conventional rubber hose with the unique advantages of synthetic materials.

Recommended use: Hand held grease guns.

PART No.	Length (IN.)	Working Pressure (P.S.I.)	Burst Pressure (PSI)
GWN-3-12	12	3000	12,000
GWN-3-18	18	3000	12,000
GWN-3-24	24	3000	12,000
GWN-3-36	36	3000	12,000
GWN-3-48	48	3000	12,000
GWN-3-72	72	3000	12,000

Available packaged, Suffix PART No. with the letter "P"

RUBBER GREASE WHIPS



These assemblies are manufactured from 3/16" I.D. S.A.E. 100R1 rubber hose. The one braid hose is permanently crimped with 1/8 brass male pipe couplings on both ends.

Recommended use: Hand held grease guns.

PART No.	Length (IN.)	Working Pressure (P.S.I.)	Burst Pressure (PSI)
GWR-3-12	12	3000	12,000
GWR-3-18	18	3000	12,000
GWR-3-24	24	3000	12,000
GWR-3-36	36	3000	12,000
GWR-3-48	48	3000	12,000
GWR-3-54	54	3000	12,000
GWR-3-60	60	3000	12,000
GWR-3-72	72	3000	12,000



Available packaged, Suffix PART No. with the letter "P"

D.O.T. AIR SHIFT TRANSMISSION HOSE ASSEMBLIES

Male
Pipe
Swivel



Male
Pipe
Thread

PART No.	Swivel Pipe	Male Pipe	Hose I.D. (IN.)	Length (IN.)
2815-4-2	1/8	1/8	1/4	15
2817-4-2	1/8	1/8	1/4	17
2831-4-2	1/8	1/8	1/4	31
2832-4-2	1/8	1/8	1/4	32
2834-4-2	1/8	1/8	1/4	34
2836-4-2	1/8	1/8	1/4	36

OTHER LENGTHS AVAILABLE ON REQUEST

FIFTH WHEEL SLIDER KIT



PART No. FWSK-1

Designed for use on sliding fifth wheels, this kit includes most everything you need to complete the connections.

Kit Includes:

- (1) 120" Length of 1/4" O.D. S.A.E. - J844-A coiled air tube.
- (2) 360° Brass working male pipe swivels on each end.
- Spring guard hose end protectors.
- 90° Brass adapter elbow.
- Frame mounting terminal bolt.

PART No. FWSK-2

- With Push-To-Connect Fitting.



AIR SEAT GUN SPLICER KIT



PART No. ASGK-1

Simply splice the air seat line with the push-to-connect tee end of the assembly. This handy kit features an industrial air gun for cleaning out the cab on site.

Kit Includes:

- 120" Length of 1/4" O.D. S.A.E. J844-A coiled air tube.
- One 360° Brass working male pipe swivel.
- Two spring guard hose end protectors.
- Push-to-connect splicer tee. (No Tools required)
- Chrome plated, lever handle air gun.



MEDIUM PRESSURE HOSE



Meets or Exceeds
**S.A.E. 100R1 TYPE AT
EN853 1SN**

ONE WIRE BRAID (NON SKIVE)
COVER IS NOT REMOVED

For medium to high pressure hydraulic service in the handling of most hydraulic fluids, gasoline, diesel fuels, lubricating oils and water. Not suitable for use with phosphate esters.

- **CONSTRUCTION:**
One Ply of Steel Wire Braid.
- **TUBE:** Oil and Heat-Resistant Synthetic Rubber Inner Tube.
- **COVER:** Oil, Weather and Flame-Resistant M.S.H.A. Approved Synthetic Rubber Cover.
- **COLOR:** Black
- **TEMPERATURE:** -40°F to +250°F, -40°C to +121°C
- **PACKAGING:** For Reel Lengths and Carton Quantities see below.
- **FITTINGS:** SC600 Compression Page 64 - 65
SC900 Bite-To-The-Wire Page 66 - 68
SRT100 Reusable Page 71

PART No.	Actual I.D. (IN.)	Hose O.D. (IN.)	Working Pressure (P.S.I.)	Min. Burst Pressure (P.S.I.)	Min. Bend Radius (IN.)	Approx. Wgt. / Ft. (LBS.)	Reel Lengths (FT.)
T1SN-3-REEL	3/16	.480	3,625	14,500	3.54	.13	250
T1SN-4-REEL	1/4	.531	3,263	13,050	4.00	.17	328
T1SN-6-REEL	3/8	.687	2,610	10,440	5.00	.26	328
T1SN-8-REEL	1/2	.812	2,320	9,280	7.00	.31	328
T1SN-12-REEL	3/4	1.093	1,523	6,090	9.50	.47	164

HIGH PRESSURE HOSE



Meets or Exceeds
**S.A.E. 100R2 TYPE AT
EN853 2SN**

TWO WIRE BRAID (NON SKIVE)
COVER IS NOT REMOVED

For high pressure hydraulic service in the handling of most hydraulic fluids, gasoline, diesel fuels, lubricating oils and water. Not suitable for use with phosphate esters.

- **CONSTRUCTION:**
Two Plies of Steel Wire Braid.
- **TUBE:** Oil and Heat-Resistant Synthetic Rubber Inner Tube.
- **COVER:** Oil, Weather and Flame-Resistant Black Synthetic Rubber Cover
- **COLOR:** Black
- **TEMPERATURE:** -40°F to +250°F, -40°C to +121°C
- **PACKAGING:** For Reel Lengths and Carton Quantities see below.
- **FITTINGS:** SC600 Compression Page 64 - 65
SC900 Bite-To-The-Wire Page 66 - 68
SCTGW600 Bite-To-The-Wire Page 69
SRT200 Reusable Page 71

PART No.	Actual I.D. (IN.)	Hose O.D. (IN.)	Working Pressure (P.S.I.)	Min. Burst Pressure (P.S.I.)	Min. Bend Radius (IN.)	Approx. Wgt. / Ft. (LBS.)	Reel Lengths (FT.)
T2SN-4-REEL	1/4	.593	5,800	23,200	4.00	.26	328
T2SN-6-REEL	3/8	.750	4,785	19,140	5.00	.38	328
T2SN-8-REEL	1/2	.875	3,988	15,950	7.00	.48	328
T2SN-12-REEL	3/4	1.187	3,118	12,325	9.50	.61	164
T2SN-16-REEL	1	1.500	2,393	9,425	12.00	.95	164

MEDIUM PRESSURE HOSE



S.A.E. 100R1 TYPE AT EN853 1SN

ONE WIRE BRAID (NON SKIVE)
COVER IS NOT REMOVED

For medium to high pressure hydraulic service in the handling of most hydraulic fluids, gasoline, diesel fuels, lubricating oils and water. Not suitable for use with phosphate esters.

- **CONSTRUCTION:**
One Ply of Steel Wire Braid.
- **TUBE:** Oil and Heat-Resistant Synthetic Rubber Inner Tube.
- **COVER:** Oil, Weather and Flame-Resistant M.S.H.A. Approved Synthetic Rubber Cover.
- **COLOR:** Black
- **TEMPERATURE:** -40°F to +250°F, -40°C to +121°C
- **PACKAGING:** For Reel Lengths and Carton Quantities see below.
- **FITTINGS:** SC600 Compression Page 64 - 65
SC900 Bite-To-The-Wire Page 66 - 67
SRT100 Reusable Page 721

PART No.	Actual I.D. (IN.)	Hose O.D. (IN.)	Working Pressure (P.S.I.)	Min. Burst Pressure (P.S.I.)	Min. Bend Radius (IN.)	Approx. Wgt. / Ft. (LBS.)	Reel Lengths (FT.)
T1-4-REEL	1/4	.531	2,750	11,000	4.00	.17	300
T1-6-REEL	3/8	.687	2,250	9,000	5.00	.26	300
T1-8-REEL	1/2	.812	2,000	8,000	7.00	.31	300
T1-10-REEL	5/8	.930	1,500	6,000	8.00	.34	250
T1-12-REEL	3/4	1.093	1,250	5,000	9.50	.47	250
T1-16-REEL	1	1.437	1,000	4,000	12.00	.70	150

HIGH PRESSURE HOSE



S.A.E. 100R2 TYPE AT EN853 2SN

TWO WIRE BRAID (NON SKIVE)
COVER IS NOT REMOVED

For high pressure hydraulic service in the handling of most hydraulic fluids, gasoline, diesel fuels, lubricating oils and water. Not suitable for use with phosphate esters.

- **CONSTRUCTION:**
Two Plies of Steel Wire Braid.
- **TUBE:** Oil and Heat-Resistant Synthetic Rubber Inner Tube.
- **COVER:** Oil, Weather and Flame-Resistant Black Synthetic Rubber Cover
- **COLOR:** Black
- **TEMPERATURE:** -40°F to +250°F, -40°C to +121°C
- **PACKAGING:** For Reel Lengths and Carton Quantities see below.
- **FITTINGS:** SC600 Compression Page 64 - 65
SC900 Bite-To-The-Wire Page 66 - 67
SCTGW600 Bite-To-The-Wire Page 69
SRT200 Reusable Page 71

PART No.	Actual I.D. (IN.)	Hose O.D. (IN.)	Working Pressure (P.S.I.)	Min. Burst Pressure (P.S.I.)	Min. Bend Radius (IN.)	Approx. Wgt. / Ft. (LBS.)	Reel Lengths (FT.)
T2-4-REEL	1/4	.593	5,000	20,000	4.00	.26	300
T2-6-REEL	3/8	.750	4,000	16,000	5.00	.38	300
T2-8-REEL	1/2	.875	3,500	14,000	7.00	.48	300
T2-10-REEL	5/8	1.000	2,750	11,000	8.00	.50	250
T2-12-REEL	3/4	1.187	2,250	9,000	9.50	.61	250
T2-16-REEL	1	1.500	2,000	8,000	12.00	.95	150
T2-20-CTN	1-1/4	1.902	1,625	6,500	16.50	1.38	130
T2-24-CTN	1-1/2	2.150	1,300	5,250	20.00	1.69	130

MEDIUM PRESSURE HOSE



S.A.E. 100R3

TWO RAYON BRAIDS
(NON SKIVE)
COVER IS NOT REMOVED

For medium pressure hydraulic service in the handling of most hydraulic fluids, gasoline, diesel fuels, lubricating oils, air and water. Extensively used in high pressure car wash systems and recommended for applications where long lengths are required. Not suitable for use with phosphate esters.

- **CONSTRUCTION:**
Two Braids of Rayon Cord
- **TUBE:** Oil and Heat-Resistant Synthetic Rubber Inner Tube.
- **COVER:** Oil, Weather and Abrasion-Resistant Synthetic Rubber Cover.
- **COLOR:** Black
- **TEMPERATURE:** -40°F to +250°F, -40°C to +121°C
- **PACKAGING:** For Reel Lengths and Carton Quantities see below.
- **FITTINGS:** SC600 Compression Page 64 - 65

PART No.	Actual I.D. (IN.)	Hose O.D. (IN.)	Working Pressure (P.S.I.)	Min. Burst Pressure (P.S.I.)	Min. Bend Radius (IN.)	Approx. Wgt. / Ft. (LBS.)	Reel Lengths (FT.)
HR3-4-REEL	1/4	.562	1,250	5,000	3.00	.11	300
HR3-6-REEL	3/8	.750	1,125	4,500	4.00	.19	400

SUCTION HOSE



Meets or Exceeds
Performance Characteristics

S.A.E. 100R4

TWO TEXTILE SPIRAL PLIES
WITH WIRE HELIX
(NON SKIVE)
COVER IS NOT REMOVED

For hydraulic suction (29 Inch/hg) and low pressure hydraulic return lines. Will handle petroleum based hydraulic fluids, diesel fuels, water and lubricating oils. Wire helix prevents collapsing under vacuum service. Not suitable for use with phosphate esters.

- **CONSTRUCTION:**
Two Textile Spiral Plies With Wire Helix.
- **TUBE:** Oil and Heat-Resistant Synthetic Rubber Inner Tube.
- **COVER:** Oil, Weather and Abrasion-Resistant Synthetic Rubber Cover.
- **COLOR:** Black
- **TEMPERATURE:** -40°F to +250°F, -40°C to +121°C
- **PACKAGING:** 50 FT. and 100 FT. Coils
- **FITTINGS:** SC600 Compression Page 64 - 65
(Up to 1-1/4 Size)
S1100 and SO1100 Steel Hose Inserts Page 73
Steel Combination Nipples and Hose Menders

NEW

Coil	Actual I.D. (IN.)	Hose O.D. (IN.)	Working Pressure (P.S.I.)	Min. Burst Pressure (P.S.I.)	Min. Bend Radius (IN.)	Vacuum Service (IN./HG)	Approx. Wgt. / Ft. (LBS.)	PART No.	Actual I.D. (IN.)
Length									
PART No. (FT.)	(IN.)	(IN.)	(P.S.I.)	(P.S.I.)	(IN.)	(IN./HG)	(LBS.)		
HR4-12-100	3/4	1.250	300	1,200	3.00	29	.40	100	3
HR4-16-100	1	1.500	250	1,000	4.00	29	.60	100	1-
								HR4-20-100	1-
								HR4-24-100	1-
								HR4-32-100	2

MEDIUM PRESSURE HOSE

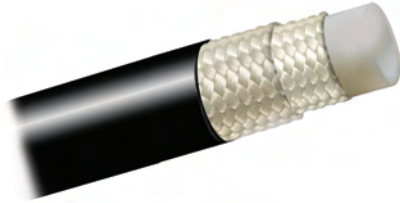

For medium pressure hydraulic service in the handling of most hydraulic fluids, diesel fuels, water and lubricating oils. Not suitable for use with phosphate esters. This hose combines the best features of conventional rubber hose with the unique advantages of synthetic materials.

Recommended use: Hand held grease guns.

- **CONSTRUCTION:**
Synthetic fiber.
- **TUBE:** Oil and Heat-Resistant Nylon Inner Tube.
- **COVER:** Oil, Weather and Flame-Resistant M.S.H.A. Approved Thermoplastic Cover.
- **TEMPERATURE:** -40°F to +200°F, -40°C to +93°C
- **PACKAGING:** Reels
- **FITTINGS:** SC700, SY-3903
- * **S.A.E. WORKING PRESSURES SHOWN**

S.A.E. 100R7

Meet or Exceeds SAE J517
Exceeds 100R7 Impulse
Requirements
Synthetic Fiber Reinforcement

PART No.	Actual I.D. (IN.)	Hose O.D. (IN.)	* Working Pressure (P.S.I.)	Min. Burst Pressure (P.S.I.)	Min. Bend Radius (IN.)	Weight / 100 Ft. (LBS.)	Reel Lengths (FT.)
HR7-2-REEL	1/8	0.322	3000	12,000	0.75	3	250
HR7-3-REEL	3/16	0.415	3000	12,000	0.75	5	250

VERY HIGH PRESSURE HOSE



For very high pressure hydraulic service in the handling of most hydraulic fluids, diesel fuels, water and lubricating oils. Not suitable for use with phosphate esters.

- **CONSTRUCTION:**
Four Spirals of High Tensile Steel Wire.
- **TUBE:** Oil and Heat-Resistant Synthetic Rubber Inner Tube.
- **COVER:** Oil, Weather and Flame-Resistant M.S.H.A. Approved Synthetic Rubber Cover.
- **TEMPERATURE:** -40°F to +200°F, -40°C to +93°C
- **PACKAGING:** Coils
- **FITTINGS:** SCT900MS (Non-Skive) Bite-To-The-Wire Page 68
SCTGW600 (Non-Skive) Bite-To-The-Wire Page 69
- * **S.A.E. WORKING PRESSURES SHOWN**

S.A.E. 100R12

EN856 4SN

FOUR SPIRAL WIRE
(NON SKIVE / SKIVE)

PART No.	Actual I.D. (IN.)	Hose O.D. (IN.)	* Working Pressure (P.S.I.)	Min. Burst Pressure (P.S.I.)	Min. Bend Radius (IN.)	Approx. Wgt. / Ft. (LBS.)	Coil Lengths (FT.)
HRA12-6	3/8	.787	4,000	16,000	5.00	.44	131
HRA12-8	1/2	.934	4,000	16,000	7.00	.56	131
HRA12-12	3/4	1.210	4,000	16,000	9.50	.89	131
HRA12-16	1	1.495	4,000	16,000	12.00	1.30	131
HRA12-20	1-1/4	1.850	3,000	12,000	16.50	1.79	131

HIGH PRESSURE HOSE



For hydraulic service in the handling of most hydraulic fluids, gasoline, diesel fuels lubricating oils and water. Not suitable with phosphate esters.

- **CONSTRUCTION:**
Two Plies of Steel Wire Braid.
- **TUBE:** Oil and Heat-Resistant Synthetic Rubber Inner Tube
- **COVER:** Oil, Weather and Flame-resistant Synthetic Rubber Cover.
- **COLOUR:** Black
- **TEMPERATURE:** -40°F to +250°F, -40°C to +121°C
- **PACKAGING:** For Reel Lengths see below.
- **FITTINGS:** SC600 Compression Page 64 - 65
SC900 Bite-To-The-Wire Page 66 - 67

S.A.E. 100R16

TWO WIRE BRAID
(NON SKIVE)
COVER IS NOT REMOVED

PART No.	Actual I.D. (IN.)	Hose O.D. (IN.)	Working Pressure (P.S.I.)	Min. Burst Pressure (P.S.I.)	Min. Bend Radius (IN.)	Approx. Wgt. / Ft. (LBS.)	Reel Lengths (FT.)
HR16-4-REEL	1/4	.570	5,000	20,000	2.00	.23	300
HR16-6-REEL	3/8	.720	4,000	16,000	2.50	.29	300
HR16-8-REEL	1/2	.840	3,500	14,000	3.50	.38	300

MEDIUM PRESSURE HOSE



For medium to high pressure hydraulic service in the handling of most hydraulic fluids, gasoline, diesel fuels lubricating oils and water. Not suitable with phosphate esters.

- **CONSTRUCTION:** One Braid of High Tensile Steel Wire Reinforcement for 1/4" ID Through to 1/2" ID hose. • Two Braids of High Tensile Steel Wire Reinforcement for 3/4" ID Through to 1" ID Hose.
- **TUBE:** Oil and Heat Resistant Synthetic Rubber Inner Tube
- **COVER:** Oil, Weather and Flame-Resistant Synthetic Rubber Cover.
- **COLOUR:** Black
- **TEMPERATURE:** -40°F to +250°F, -40°C to +121°C
- **PACKAGING:** For Reel Lengths see below.
- **FITTINGS:** SC600 Compression Page 64 - 65
SC900 Bite-To-The-Wire Page 66 - 67

S.A.E. 100R17

(NON-SKIVE)
COVER IS NOT REMOVED

PART No.	Actual I.D. (IN.)	Nominal Hose O.D. (IN.)	Maximum Hose O.D. (IN.)	Working Pressure (P.S.I.)	Min. Burst Pressure (P.S.I.)	Min. Bend Radius (IN.)	Approx. Wgt. / Ft. (LBS.)	Reel Lengths (FT.)
HR17-4-REEL	1/4	0.480	0.520	3,000	12,000	2.00	0.16	300
HR17-6-REEL	3/8	0.610	0.670	3,000	12,000	2.50	0.24	300
HR17-8-REEL	1/2	0.750	0.830	3,000	12,000	3.50	0.29	300
HR17-12-REEL	3/4	1.090	1.190	3,000	12,000	4.75	0.55	250
HR17-16-REEL	1	1.420	1.520	3,000	12,000	6.00	0.95	150

WETLINE KITS

Wet Kits (or wetline kits) installed on the PTO (Power Take Off) of trucks or semi-trucks. Many different accessories are installed on these trucks, like booms and cranes. The hydraulic pump is activated by the truck's Power Take Off. These accessories need the hydraulic pump to operate.

WET-KIT1 CONTENTS (12Ft Length Kit):

PART No.	DESCRIPTION	QTY.
BI-125-20J	1-1/4" STEEL COMBINATION NIPPLE	4
HC2-175	T-BOLT HOSE CLAMP (ALL STAINLESS)	4
HR4-20-CUT	1-1/4" SUCTION HOSE SAE 100R4	12 Ft.
QD-BTTWC16-16F	1" FD51 INTERCHANGE HYD. COUPLER	1
QD-BTTWN16-16F	1" FD51 INTERCHANGE HYD. NIPPLE	1
S1120-JH	1-1/4" PIPE TO 1" NPSM SWIVEL	1
HAT2XX16C144.0MPHMPH	100R2 HYD. ASSEMBLY - MALE PIPE 1"	12 Ft.

WET-KIT2 CONTENTS (16Ft Length Kit):

PART No.	DESCRIPTION	QTY.
BI-125-20J	1-1/4" STEEL COMBINATION NIPPLE	4
HC2-175	T-BOLT HOSE CLAMP (ALL STAINLESS)	4
HR4-20-CUT	1-1/4" SUCTION HOSE SAE 100R4	16 Ft.
QD-BTTWC16-16F	1" FD51 INTERCHANGE HYD. COUPLER	1
QD-BTTWN16-16F	1" FD51 INTERCHANGE HYD. NIPPLE	1
S1120-JH	1-1/4" PIPE TO 1" NPSM SWIVEL	1
HAT2XX16C192.0MPHMPH	100R2 HYD. ASSEMBLY - MALE PIPE 1"	16 Ft.

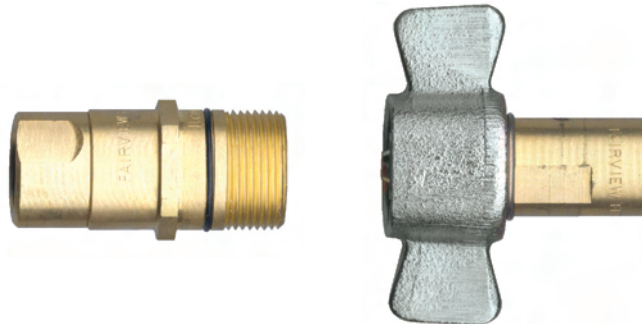

AEROQUIP FD51 SERIES INTERCHANGE Q.D.



- Interchangeable with Aeroquip 5100 series and Parker 6100 series.
- Heavy duty wing nut or hex nut for easy connection.
- Thread-To-Connect.
- Dry-Break feature minimizes air inclusion and contamination of systems.
- Up to 3,000 PSI connected and disconnected.
- Ideal for use on hydraulic dump trucks, coal trucks, sand and salt spreaders and oil well equipment.

CUSTOM KITS AVAILABLE

Operating Pressure Size	(PSI)	Air Inclusion CC. Max.	Spillage CC. Max.
3/4	3000	.34	.26
1	3000	.50	.35
1-1/4	2750	.68	.70
1-1/2	2750	.60	.94

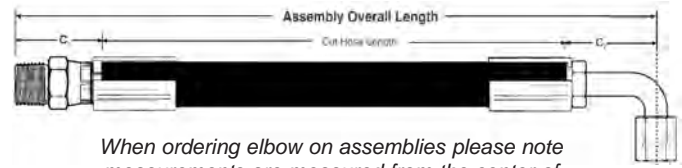
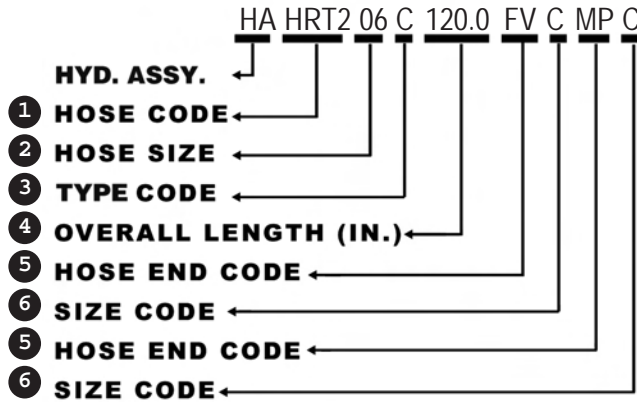
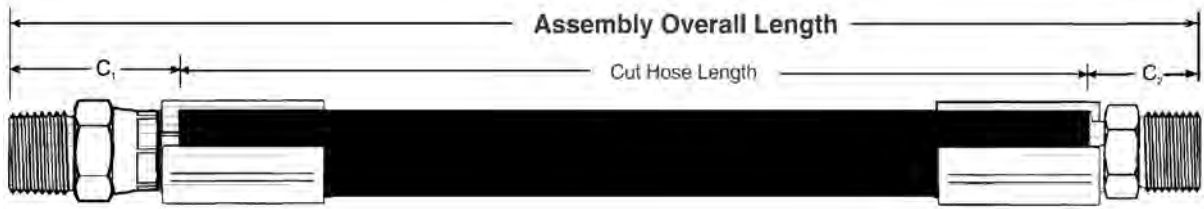

When ordering elbow on assemblies please note measurements are measured from the center of elbow to opposite end of assembly.

Length Tolerances for Hydraulic Hose Assemblies and Specified Hose Lengths.

Length	Tolerance
For Lengths from 0 to and including 36"	±1/4"
For Lengths above 36"	±1% of length measured to the nearest 1/8 of an inch.

**For Synflex Hose Assemblies Replace HA with SY

CODE LEGEND

1 HOSE CODES

Hydraulic = HA

CODE	HOSE
T1XX	S.A.E. 100R1
T2XX	S.A.E. 100R2
H4SH	DIN 20023 4SH
HR3X	S.A.E. 100R3
HR4X	S.A.E. 100R4
HR5X	S.A.E. 100R5
HR5H	S.A.E. 100R5HT
HR12	S.A.E. 100R12
HR13	S.A.E. 100R13
HTXX	S.A.E. 100R14 PTFE
HR16	S.A.E. 100R16
HR17	S.A.E. 100R17

Synflex = SY

CODE	HOSE
3R30	100R3 Hose
3580	100R7/100R1 Hose
3130	100R7 Hose
37AL	100R7 Non-Conductive
3R80	100R8 Hose
3E80	100R8 Non-Conductive
30CT	3000 P.S.I. Constant Pressure Hose
3360	3000 P.S.I. Constant Pressure Hose

2 SIZE CODES

HOSE SIZE

02
03
04
05
06
08
10
12
16
20
24
32

TUBE

1/8"
3/16"
1/4"
5/16"
3/8"
1/2"
5/8"
3/4"
1"
1-1/4"
1-1/2"
2"

SIZE CODE

A
F
B
G
C
D
I
E
H
J
K
M

3 ASSEMBLY TYPE CODES

Hydraulic

CODE	TYPE
C	Crimp Ends
R	Reusable Ends

Synflex

CODE	TYPE
S	Swage Hose
T	Twin-Line Hose

4 ASSEMBLY OVERALL LENGTH

The overall length of the Assembly is measured in Inches Including Hose Ends. (See above)

Example:
2' = 24.00
10' = 120.0
100' = 1200.

Must fill all 5 spaces in the Overall Length Code

HOSE END CODE

CODE

DESCRIPTION

FJ	Female Swivel 37° S.A.E.
FV	Female NPSM Swivel
FP	Female Pipe
FS	Female Swivel 45° S.A.E.
J5	Female Swivel 37° S.A.E. 45° Elbow
J9	Female Swivel 37° S.A.E. 90° Elbow
JL	Female Swivel 37° S.A.E. 90° Elbow (Long)
S5	Female Swivel 45° S.A.E. 45° Elbow
S9	Female Swivel 45° S.A.E. 90° Elbow
MJ	Male 37° S.A.E.
MS	Male 45° S.A.E.
MI	Male Inverted Flare
I5	Male Inverted Flare 45° Elbow
I9	Male Inverted Flare 90° Elbow
MO	Male O-Ring
SO	Male O-Ring Boss Swivel
O9	Male O-Ring Boss 90° Elbow
MP	Male Pipe
SP	Male Pipe Swivel
P9	Male Pipe Swivel 90° Elbow
RS	Female O-Ring Face Seal
R5	Female O-Ring Face Seal 45° Elbow
R9	Female O-Ring Face Seal 90° Elbow
ST	Stand Pipe



Synflex® PART NUMBER LEGEND

STANDARD HOSE

Example: 3130 100R7 HOSE, 1/4" I.D., 250FT Reel
PART No: SY-3130-04003



SY- 3130- 04- 003
 Synflex Hose Size Reel
 Series Length

MULTI-LINE HOSE

Example: 3130 TWIN-LINE 100R7 HOSE, 1/4" I.D.
PART No: SY-3770-21333



SY- 3770- 2 13 3 3
 Synflex Multi- No. of Hose Hose Reel
 Line Hoses Series Size Length

HOSE SERIES CODE

<u>STANDARD</u>	<u>MULTI-LINE</u>	
3R30	R3	100R3
3580	58	100R7/100R1
3130	13	100R7
37AL	7A	100R7 Non-Conductive
3R80	R8	100R8
3E80	E8	100R8 Non-Conductive
30CT	0C	3000 PSI Constant Pressure
3360	36	3000 PSI Constant Pressure

SIZE CODES

<u>STANDARD</u>	<u>HOSE</u>	<u>MULTI</u>
<u>CODE</u>	<u>I.D.</u>	<u>CODE</u>
02	1/8"	1
03	3/16"	2
04	1/4"	3
05	5/16"	4
06	3/8"	5
08	1/2"	6
10	5/8"	N/A
12	3/4"	7
16	1"	8

REEL LENGTHS

000 = Bulk
001 = 400 ft Random
002 = 100 ft Continuous
003 = 250 ft Random
004 = 500 ft Random
005 = 500 ft Continuous or Random (depends on hose series)
006 = 250 ft Continuous or Random (depends on hose series)
007 = 300 ft to 400 ft Continuous (depends on hose series)
008 = 200 ft Random

HOSE COUPLINGS

Example: Coupling for 1/4" I.D. 3130 Hose x 1/4" Male Pipe Rigid = PART No. SY-3903-04104

SY- 3903- 04 10 4
 Synflex Coupling Hose End End
 Series Size Series Size

COUPLING

<u>SERIES</u>		<u>MATERIAL</u>
3903	Small O.D. Hose	Steel
390A	Small O.D. Hose	Stainless Steel
390C	Small O.D. Hose	Brass
390P	Small O.D. Hose	Monel
390H	Large O.D. Hose	Steel
390L	Large O.D. Hose	Stainless Steel
3906	Large O.D. Hose	Brass
390S	Large O.D. Hose	Monel
390N	Extra Large O.D. Hose	Steel

END

<u>SERIES</u>	
10	Male Pipe
14	Male Pipe Swivel
20	Female Pipe
24	Female NPSM Swivel
27	Male Pipe Swivel 90° Elbow
40	O-Ring Face Seal
44	O-Ring Face Seal 45° Elbow
47	O-Ring Face Seal 90° Elbow
50	Male 37° JIC

END

<u>SERIES</u>	
54	Female JIC Swivel
60	Female Swivel 37° JIC 45° Elbow
64	Female Swivel 37° JIC 90° Elbow
94	Male 45° S.A.E.
A0	Female S.A.E. Swivel
C4	Male Inverted Flare 45° Elbow
C7	Male Inverted Flare 90° Elbow
D0	Male O-Ring
J0	Stand Pipe

3R30 LOW PRESSURE HOSE



Meets **S.A.E. 100R3**
Performance
Specifications

FEATURES: Low Volumetric Expansion • Rugged Design
TYPICAL APPLICATIONS: For use with Low Pressure Hydraulics (Eg. Hospital Beds) Hand Tools: Air Power Tools (Eg. Impact Tools, Nail Guns, Stapler Guns, Tire Inflation) • Lubrication Systems • High Pressure Pneumatic Systems • Pressure Wash Hose • Water Hand Cooling Systems

- **CONSTRUCTION:** Spiraled Synthetic Fiber Reinforcement (-03 thru -06, -08 is Braided)
- **TUBE:** Nylon-Lined Core Tube.
- **COVER:** Perforated Polyurethane Cover.
- **COLOR:** Black.
- **TEMPERATURE:** -40°F to +212°F, -40°C to +100°C or to +150°F, +66°C With Water-Based or Fire Resistant Fluids
- **FITTINGS:** SY-3903 Page 75
- **CRIMP SPECIFICATIONS:** Page 76

PART No.	Actual I.D. (IN.)	Hose O.D. (IN.)	Min. Bend Radius (IN.)	Working Pressure (P.S.I.)	Min. Burst Pressure (P.S.I.)	Approx. Wgt./Ft. (LBS.)	Reel Length (FT.)
SY-3R30-04003	1/4	.487	1-1/4	1,500	6,000	.053	250
SY-3R30-06003	3/8	.637	2	1,250	5,000	.081	250
SY-3R30-08003	1/2	.818	3	1,000	4,000	.141	250

3440 MOISTURE LOK HOSE



FEATURES: High Moisture Barrier Core Tube • No Plasticizers in the Core Tube • UV Resistant Cover
TYPICAL APPLICATIONS: Conveying Urethane Foam Components • Moisture Sensitive Chemicals

- **CONSTRUCTION:** Synthetic Fiber Reinforcement
- **TUBE:** Polyolefin Core Tube
- **COVER:** Perforated Polyurethane Cover
- **COLOR:** Blue, • Custom COLORS Available
- **TEMPERATURE:** -10°F to +150°F -23°C to +66°C
- **FITTINGS:** One Piece Steel Crimp
SY-3903 Series Page 75 (Up to 1/2")
SY-390H Series Page 76 (3/4" and 1")
- **CRIMP SPECIFICATIONS:** Page 76

PART No.	Actual I.D. (IN.)	Hose O.D. (IN.)	Min. Bend Radius (IN.)	Working Pressure (P.S.I.)	Min. Burst Pressure (P.S.I.)	Approx. Wgt./Ft. (LBS.)	Reel Length (FT.)
SY-3440-04003	1/4	.520	1-1/4	2,750	11,000	.064	250
SY-3440-06003	3/8	.655	2	2,250	9,000	.090	250
SY-3440-12003	3/4	1.140	5	1,500	6,000	.246	250

C

3130 MEDIUM PRESSURE HOSE



FEATURES: Long Continuous Lengths • Low Elongation • Best Value 100R7 Hose

TYPICAL APPLICATIONS: For use with General Hydraulics • Material Handling • Forklift • High Pressure Gas Transfer • Chemical Transfer

- **CONSTRUCTION:** Spiraled or Braided Synthetic Fiber Reinforcement
- **TUBE:** Nylon-Lined Core Tube
- **COVER:** Perforated Polyurethane Cover
- **COLOR:** Black
- **TEMPERATURE:** -40°F to +212°F, -40°C to +100°C
or to +150°F, +66°C With Water-Based or Fire Resistant Fluids
- **FITTINGS:** SY-3903 Page 75
- **CRIMP SPECIFICATIONS:** Page 76

Meets **S.A.E. 100R7**
Specifications

PART No.	Actual I.D. (IN.)	Hose O.D. (IN.)	Min. Bend Radius (IN.)	Working Pressure (P.S.I.)	Min. Burst Pressure (P.S.I.)	Approx. Wgt./Ft. (LBS.)	Reel Length (FT.)
SY-3130-03003	3/16	.427	3/4	3,000	12,000	.046	250
SY-3130-04003	1/4	.510	1-1/4	3,000	12,000	.057	250
SY-3130-04005	1/4	.510	1-1/4	3,000	12,000	.057	500
SY-3130-05003	5/16	.594	1-3/4	2,500	10,000	.069	250
SY-3130-05005	5/16	.594	1-3/4	2,500	10,000	.069	500
SY-3130-06003	3/8	.669	2	2,250	9,000	.095	250
SY-3130-06005	3/8	.669	2	2,250	9,000	.095	500
SY-3130-08003	1/2	.818	3	2,000	8,000	.141	250
SY-3130-12008	3/4	1.067	5	1,250	5,000	.193	200
SY-3130-16008	1	1.340	8	1,000	4,000	.264	200

** S.A.E. specifications 100R7 does not apply to 1/8" size: The nylon core tube is a single-wall design and is not bonded to the reinforcement.

3130 TWIN-LINE MEDIUM PRESSURE HOSE



FEATURES: Long Continuous Lengths • Low Elongation • Best Value 100R7 Hose

TYPICAL APPLICATIONS: For use with General Hydraulics • Material Handling • Forklift • High Pressure Gas Transfer • Chemical Transfer

- **CONSTRUCTION:** Spiraled or Braided Synthetic Fiber Reinforcement
- **TUBE:** Nylon-Lined Core Tube
- **COVER:** Perforated Polyurethane Cover
- **COLOR:** Black
- **TEMPERATURE:** -40°F to +212°F, -40°C to +100°C
or to +150°F, +66°C With Water-Based or Fire Resistant Fluids.
- **FITTINGS:** SY-3903 Page 75
- **CRIMP SPECIFICATIONS:** Page 76

Meets **S.A.E. 100R7**
Specifications

PART No.	Actual I.D. (IN.)	Hose O.D. (IN.)	Min. Bend Radius (IN.)	Working Pressure (P.S.I.)	Min. Burst Pressure (P.S.I.)	Approx. Wgt./Ft. (LBS.)	Reel Length (FT.)
SY-3770-21333	1/4	.510	1-1/4	3,000	12,000	.114	250
SY-3770-21353	3/8	.669	2	2,250	9,000	.190	250
SY-3770-21363	1/2	.816	3	2,000	8,000	.282	250

37AL Non-Conductive MEDIUM PRESSURE HOSE



FEATURES: S.A.E. J517 Non-Conductive Hose Construction • Less Than 50 Micro-Amperes Leakage When Subjected to 75,000 volts/ft for 5 Minutes • Abrasion Resistant Cover • UV Resistant Cover • Can Use Both Permanently Attached and Reusable Couplings • Long Continuous Lengths • Flexible in Low Temperatures
TYPICAL APPLICATIONS: Electric Utility Truck Hydraulic Systems • Mobile Equipment Picker • Utility Vehicles

Meets or Exceeds
S.A.E. 100R7
 Specifications

Complies With ANSI A92.2 for Vehicle Mounted Aerial Devices

- **CONSTRUCTION:** Braided Synthetic Fiber Reinforcement
- **TUBE:** Polyester Core Tube
- **COVER:** Non-perforated Non-Stick Polyurethane Cover
- **COLOR:** Orange
- **TEMPERATURE:** -65°F to +212°F, -54°C to +100°C or to +140°F, +60°C With Water-Based or Fire Resistant Fluids
- **FITTINGS:** SY-3903 Page 75
- **CRIMP SPECIFICATIONS:** Page 76

PART No.	Actual I.D. (IN.)	Hose O.D. (IN.)	Min. Bend Radius (IN.)	Working Pressure (P.S.I.)	Min. Burst Pressure (P.S.I.)	Approx. Wgt./Ft. (LBS.)	Reel Length (FT.)
SY-37AL-03003	3/16	.425	3/4	3,000	12,000	.048	250
SY-37AL-04003	1/4	.485	1-1/4	3,000	11,000	.060	250
SY-37AL-04005	1/4	.485	1-1/4	3,000	11,000	.060	500
SY-37AL-05003	5/16	.580	1-3/4	3,000	10,000	.075	250
SY-37AL-06003	3/8	.635	2	3,000	9,000	.095	250
SY-37AL-06005	3/8	.635	2	3,000	9,000	.095	500
SY-37AL-08003	1/2	.815	3	3,000	9,000	.143	250

37AL TWIN-LINE Non-Conductive MEDIUM PRESSURE HOSE



FEATURES: S.A.E. J517 Non-Conductive Hose Construction • Less Than 50 Micro-Amperes Leakage When Subjected to 75,000 volts/ft for 5 Minutes • Abrasion Resistant Cover • UV Resistant Cover • Can Use Both Permanently Attached and Reusable Couplings • Long Continuous Lengths • Flexible in Low Temperatures
TYPICAL APPLICATIONS: Electric Utility Truck Hydraulic Systems • Mobile Equipment Picker • Utility Vehicles

Meets or Exceeds
S.A.E. 100R7 Specifications

Complies With ANSI A92.2 for Vehicle Mounted Aerial Devices

- **CONSTRUCTION:** Braided Synthetic Fiber Reinforcement
- **TUBE:** Polyester Core Tube
- **COVER:** Non-perforated Non-Stick Polyurethane Cover
- **COLOR:** Orange
- **TEMPERATURE:** -65°F to +212°F, -54°C to +100°C or to +140°F, +60°C With Water-Based or Fire Resistant Fluids
- **FITTINGS:** SY-3903 Page 75
- **CRIMP SPECIFICATIONS:** Page 76

PART No.	Actual I.D. (IN.)	Hose O.D. (IN.)	Min. Bend Radius (IN.)	Working Pressure (P.S.I.)	Min. Burst Pressure (P.S.I.)	Approx. Wgt./Ft. (LBS.)	Reel Length (FT.)
SY-3770-27A53	3/8	.635	2	3,000	9,000	.190	250
SY-3770-27A63	1/2	.815	3	3,000	9,000	.286	250



3R80 HIGH PRESSURE HOSE



FEATURES: Long Life in Impulse Cycling and Flexing • Designed for Permanent or Reusable Couplings
TYPICAL APPLICATIONS: General Hydraulic Systems • Hydraulic Tools • Mobile Equipment • High Pressure Pneumatic Systems • High Pressure Chemical Transfer

- **CONSTRUCTION:** Braided Synthetic Fiber Reinforcement
- **TUBE:** Nylon Core Tube
- **COVER:** Perforated Polyurethane Cover
- **COLOR:** Black
- **TEMPERATURE:** -40°F to +212°F, -40°C to +100°C
or to +150°F, +66°C With Water-Based or Fire Resistant Fluids
- **FITTINGS:** SY-390H Page 76
- **CRIMP SPECIFICATIONS:** Page 76

Meets **S.A.E. 100R8**
Specifications

PART No.	Actual I.D. (IN.)	Hose O.D. (IN.)	Min. Bend Radius (IN.)	Working Pressure (P.S.I.)	Min. Burst Pressure (P.S.I.)	Approx. Wgt./Ft. (LBS.)	Reel Length (FT.)
SY-3R80-03003	3/16	.515	1-1/2	5,000	20,000	.077	250
SY-3R80-04003	1/4	.625	2	5,000	20,000	.118	250
SY-3R80-06003	3/8	.765	2-1/2	4,000	16,000	.148	250
SY-3R80-08003	1/2	.892	4	3,500	14,000	.190	250
SY-3R80-12008	3/4	1.138	6-1/2	2,250	9,000	.256	200
SY-3R80-16008	1	1.468	10	2,000	8,000	.385	200

3R80 TWIN-LINE HIGH PRESSURE HOSE



FEATURES: Long Life in Impulse Cycling and Flexing • Designed for Permanent or Reusable Couplings
TYPICAL APPLICATIONS: General Hydraulic Systems • Hydraulic Tools • Mobile Equipment • High Pressure Pneumatic Systems • High Pressure Chemical Transfer

- **CONSTRUCTION:** Braided Synthetic Fiber Reinforcement
- **TUBE:** Nylon Core Tube
- **COVER:** Perforated Polyurethane Cover
- **COLOR:** Black
- **TEMPERATURE:** -40°F to +212°F, -40°C to +100°C
or to +150°F, +66°C With Water-Based or Fire Resistant Fluids
- **FITTINGS:** SY-390H Page 76
- **CRIMP SPECIFICATIONS:** Page 76

Meets **S.A.E. 100R8**
Specifications

PART No.	Actual I.D. (IN.)	Hose O.D. (IN.)	Min. Bend Radius (IN.)	Working Pressure (P.S.I.)	Min. Burst Pressure (P.S.I.)	Approx. Wgt./Ft. (LBS.)	Reel Length (FT.)
SY-3770-2R853	3/8	.765	2-1/2	4,000	16,000	.296	250
SY-3770-2R863	1/2	.892	4	3,500	14,000	.380	250

3E80 Non-Conductive HIGH PRESSURE HOSE



Meets **S.A.E. 100R8**
Specifications

FEATURES: S.A.E. J517 Non-Conductive Hose Construction. Less Than 50 Micro-Amperes Leakage When Subjected to 75,000 volts/ft for 5 Minutes • Long Life for Impulse Cycling and Flexing • UV Resistant Cover • Designed for Permanent and Reusable Couplings
TYPICAL APPLICATIONS: General Hydraulic Systems That May Contact High Voltage Sources • Aerial Equipment • Mobile Machinery • Rescue Tools

- **CONSTRUCTION:** Braided Synthetic Fiber Reinforcement
- **TUBE:** Nylon Core Tube
- **COVER:** Polyurethane Non- Perforated Cover
- **COLOR:** Orange, NON-CONDUCTIVE Marking and Color Code
- **TEMPERATURE:** -40°F to +212°F, -40°C to +100°C or to +150°F, +66°C With Water-Based or Fire Resistant Fluids
- **FITTINGS:** SY-390H Page 76
- **CRIMP SPECIFICATIONS:** Page 76

PART No.	Actual I.D. (IN.)	Hose O.D. (IN.)	Min. Bend Radius (IN.)	Working Pressure (P.S.I)	Min. Burst Pressure (P.S.I.)	Approx. Wgt./Ft. (LBS.)	Reel Length (FT.)
SY-3E80-04003	1/4	.625	2	5,000	20,000	.118	250
SY-3E80-06003	3/8	.765	2-1/2	4,000	16,000	.148	250
SY-3E80-08003	1/2	.892	4	3,500	14,000	.190	250

3E80 TWIN-LINE Non-Conductive HIGH PRESSURE HOSE



Meets **S.A.E. 100R8**
Specifications

FEATURES: S.A.E. J517 Non-Conductive Hose Construction. Less Than 50 Micro-Amperes Leakage When Subjected to 75,000 volts/ft for 5 Minutes • Long Life for Impulse Cycling and Flexing • Designed for Permanent and Reusable Couplings
TYPICAL APPLICATIONS: General Hydraulic Systems That May Contact High Voltage Sources • Aerial Equipment • Mobile Machinery • Rescue Tools

- **CONSTRUCTION:** Braided Synthetic Fiber Reinforcement
- **TUBE:** Nylon Core Tube
- **COVER:** Polyurethane Non- Perforated UV Resistant Cover
- **COLOR:** Orange, NON-CONDUCTIVE Marking and Color Code
- **TEMPERATURE:** -40°F to +212°F, -40°C to +100°C or to +150°F, +66°C With Water-Based or Fire Resistant Fluids
- **FITTINGS:** SY-390H Page 76
- **CRIMP SPECIFICATIONS:** Page 76

PART No.	Actual I.D. (IN.)	Hose O.D. (IN.)	Min. Bend Radius (IN.)	Working Pressure (P.S.I)	Min. Burst Pressure (P.S.I.)	Approx. Wgt./Ft. (LBS.)	Reel Length (FT.)
SY-3770-2E853	3/8	.765	2-1/2	4,000	16,000	.296	250

C

Spectra 30CT CONSTANT PRESSURE HOSE



FEATURES: Highly Flexible, Even in Cold Temperatures • Small OD • Lightweight Yet Rugged Construction
TYPICAL APPLICATIONS: Forklift • Construction • General Hydraulics • Chemical and Gas Transfer • Agricultural Equipment • Material Handling • Freezer Applications • Machines Tools and Robotics • Lubrication Equipment • Portable Hydraulic Tools

- **CONSTRUCTION:** Braided Synthetic Fiber Reinforcement
- **TUBE:** Polymeric Core Tube
- **COVER:** Non-Stick Perforated Polymeric Cover
- **COLOR:** Black
- **TEMPERATURE:** -65°F to +200°F, -54°C to +94°C, With Water-Based or Fire Resistant Fluids
- **FITTINGS:** SY-390H Page 76
- **CRIMP SPECIFICATIONS:** Page 76

Meets or Exceeds
S.A.E. 100R18
 Specifications

PART No.	Actual I.D. (IN.)	Hose O.D. (IN.)	Min. Bend Radius (IN.)	Working Pressure (P.S.I.)	Min. Burst Pressure (P.S.I.)	Approx. Wgt./Ft. (LBS.)	Reel Length (FT.)
SY-30CT-04003	1/4	.478	1-1/4	3,000	12,000	.060	250
SY-30CT-06003	3/8	.660	2	3,000	12,000	.122	250
SY-30CT-08003	1/2	.850	3-1/2	3,000	12,000	.150	250

Spectra 30CT TWIN-LINE CONSTANT PRESSURE HOSE



FEATURES: Highly Flexible, Even in Cold Temperatures • Small OD • Lightweight Yet Rugged Construction
TYPICAL APPLICATIONS: Forklift • Construction • General Hydraulics • Chemical and Gas Transfer • Agricultural Equipment • Material Handling • Freezer Applications • Machines Tools and Robotics • Lubrication Equipment • Portable Hydraulic Tools

- **CONSTRUCTION:** Braided Synthetic Fiber Reinforcement
- **TUBE:** Polymeric Core Tube
- **COVER:** Non-Stick Perforated Polymeric Cover
- **COLOR:** Black
- **TEMPERATURE:** -65°F to +200°F, -54°C to +94°C, With Water-Based or Fire Resistant Fluids
- **FITTINGS:** SY-390H Page 76
- **CRIMP SPECIFICATIONS:** Page 76

Meets or Exceeds
S.A.E. 100R18
 Specifications

PART No.	Actual I.D. (IN.)	Hose O.D. (IN.)	Min. Bend Radius (IN.)	Working Pressure (P.S.I.)	Min. Burst Pressure (P.S.I.)	Approx. Wgt./Ft. (LBS.)	Reel Length (FT.)
SY-3770-20C33	1/4	.478	1-1/4	3,000	12,000	.120	250
SY-3770-20C53	3/8	.660	2	3,000	12,000	.244	250
SY-3770-20C63	1/2	.850	3-1/2	3,000	12,000	.300	250

3V10 VERY HIGH PRESSURE HOSE



Synflex 3V10 Hose is AVAILABLE ONLY as Completed Assemblies.

FEATURES: Compact Size • Low Elongation • Designed for Permanent High Pressure Couplings With Hose Guards • Lightweight
TYPICAL APPLICATIONS: High Pressure Hydraulic Tools • Rescue Equipment and Tools • High Pressure Test Equipment

- **CONSTRUCTION:** Spiraled High Tensile Aramid Fiber Reinforcement
- **TUBE:** Nylon Lined Core Tube
- **COVER:** Perforated Polyurethane Cover
- **COLOR:** Black
- **TEMPERATURE:** -40°F to +150°F, -40°C to +66°C
- **FACTORY ASSEMBLIES:** Below

PART No.	Actual I.D. (IN.)	Hose O.D. (IN.)	Min. Bend Radius (IN.)	Working Pressure (P.S.I.)	Min. Burst Pressure (P.S.I.)	Approx. Wgt./Ft. (LBS.)
SY-3V10-03	3/16	.520	1-1/2	10,000	40,000	.081
SY-3V10-04	1/4	.595	2-1/2	10,000	40,000	.106
SY-3V10-06	3/8	.780	3	8,000	32,000	.164

3V10 ASSEMBLY PART NUMBER CHART

Example:

SY-3V10-06, 600 Inches Overall Length, 3/8 Male Pipe Ends = SY3V1006S600.0MPCMPC

SY	3V10	06	S	600.0	MP	C	MP	C
SYNFLEX	HOSE CODE	SIZE	LINE CODE	OVERALL LENGTH	HOSE END	SIZE	HOSE END	SIZE

SIZE CODE	TUBE	SIZE CODE	HOSE END CODE
02	1/8	A	MP Male Pipe
03	3/16	F	FJ Female JIC Swivel
04	1/4	B	LINE CODE
05	5/16	G	S Single Line
06	3/8	C	T Twin Line
08	1/2	D	3V10 Hose Assembly Construction
10	5/8	I	• Synflex 3V10 Hose
12	3/4	E	• 390V Permanent Steel Couplings
16	1	H	• 45JO Hose Guard
			• Warning Tag



Other configurations are available upon request.
 See page 113 for other assembly configuration codes.





Synflex® HOSE

3VE0 Non-Conductive VERY HIGH PRESSURE HOSE



Synflex 3VE0 Hose is AVAILABLE ONLY as Completed Assemblies.

FEATURES: • S.A.E. J517 Non-Conductive Hose Construction. Less Than 50 Micro Amperes Leakage When Subjected to 75,000 volts/ft for 5 Minutes
 • Compact Size • Low Elongation • UV Resistant Cover • Designed for Permanent High Pressure Couplings With Hose Guards
TYPICAL APPLICATIONS: General Hydraulic Systems That May Contact High Voltage Sources • Rescue Equipment and Tools • Mobile Machinery
 • Aerial Equipment

- **CONSTRUCTION:** Spiraled High Tensile Aramid Fiber Reinforcement
- **TUBE:** Nylon Lined Core Tube
- **COVER:** Polyurethane Non-Perforated Cover, NON-CONDUCTIVE Marking and Color Code
- **COLOR:** Orange
- **TEMPERATURE:** -40°F to +150°F, -40°C to +66°C
- **FACTORY ASSEMBLIES:** Below

PART No.	Actual I.D. (IN.)	Hose O.D. (IN.)	Min. Bend Radius (IN.)	Working Pressure (P.S.I.)	Min. Burst Pressure (P.S.I.)	Approx. Wgt./Ft. (LBS.)
SY-3VE0-03	3/16	.520	1-1/2	10,000	40,000	.081
SY-3VE0-04	1/4	.595	2-1/2	10,000	40,000	.106
SY-3VE0-06	3/8	.780	3	8,000	32,000	.164

3VE0 ASSEMBLY PART NUMBER CHART

Example:

SY-3VE0-06, 600 Inches Overall Length, 3/8 Male Pipe Ends = SY3VE006S600.0MPCMP C

<u>SY</u>	<u>3VE0</u>	<u>06</u>	<u>S</u>	<u>600.0</u>	<u>MP</u>	<u>C</u>	<u>MP</u>	<u>C</u>
SYNFLEX	HOSE CODE	SIZE	LINE CODE	OVERALL LENGTH	HOSE END	SIZE	HOSE END	SIZE

<u>SIZE CODE</u>	<u>TUBE</u>	<u>SIZE CODE</u>	<u>HOSE END CODE</u>
02	1/8	A	MP Male Pipe
03	3/16	F	FJ Female JIC Swivel
04	1/4	B	<u>LINE CODE</u>
05	5/16	G	S Single Line
06	3/8	C	T Twin Line
08	1/2	D	3VE0 Hose Assembly Construction
10	5/8	I	• Synflex 3VE0 Hose
12	3/4	E	• 390V Permanent Steel Couplings
16	1	H	• 45JO Hose Guard
			• Warning Tag



Other configurations are available upon request.
 See page 113 for other assembly configuration codes.

U.L. / C.S.A. APPROVED TYPE I PROPANE / NATURAL GAS HOSE ASSEMBLIES



Used To Conduct Natural Gas In A Gaseous State And Propane In Either A Liquid Or Gaseous State Up To 350 P.S.I.

Factory Made Assemblies are available in a variety of configurations and hose lengths, enter overall length in inches where applicable. Length Tolerances for Propane Hose Assemblies and Specified Hose Lengths.

Length Range:
For Lengths from 0 up to and including 36"
For Lengths above 36"

Tolerance
±1/4"
±1% of length measured to the nearest 1/8 of an inch.

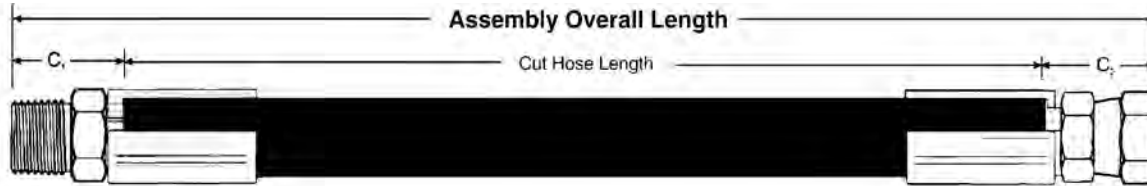

HOSE ASSEMBLY DESCRIPTIONS:

- I4C** Type I 1/4 I.D. Hose Crimp Ends
- I4LTC** Type I (Low Pressure Thermoplastic)
- I4TC** Type I (T = Thermoplastic)
- FC** Female Cylinder Thread
- FJ** Female JIC
- FP** Female Pipe
- FS** Female Swivel SAE Flare Ex: (6 = 3/8)



- FW** Female Welding End
- MC** Male Cylinder Thread
- MI** Male Inverted Flare
- MP** Male Pipe
- POL** POL End
- POLHW** POL End with Hand Wheel
- POLNE** POL End with No Excess Flow
- QDC** Quick Disconnect Coupler End



- QDN** Quick Disconnect Nipple End
- QCC** QCC1 ACME Connection



SPECIALTY CODES

- GR** Gas Regulator End
- P** Suffix for Packaged Product (Not All Items Available Packaged)

Rubber Temperature Range: -60°F To 212°F (-51°C To 100°C)
Thermoplastic Temperature Range: -40°F To 140°F (-40°C To 60°C)

		Hose				
		PART No.	MP	MP	I.D.	Hose
 <p>MP MALE PIPE THREAD</p> <p> 1/4 & 3/8 I.D. ONLY.</p> <p> US</p> <p>MP MALE PIPE THREAD</p> <p>NOTE: 1/2 & LARGER C/W STEEL ENDS</p>		I4C __ MP2MP2	1/8	1/8	1/4	Rubber
		I4C __ MP4MP4	1/4	1/4	1/4	Rubber
		I6C __ MP6MP6	3/8	3/8	3/8	Rubber
		I8C __ MP8MP8	1/2	1/2	1/2	Rubber
		I12C __ MP12MP12	3/4	3/4	3/4	Rubber
		I16C __ MP16MP16	1	1	1	Rubber
		* I20C __ MP20MP20	1-1/4	1-1/4	1-1/4	Rubber
<p>* 1-1/4" TEMPERATURE RANGE: -40°F To 180°F (-40°C To 82°C)</p> <p>• NOTE: __ ENTER OVERALL LENGTH IN INCHES WHERE APPLICABLE.</p>						

		PART No.	FS	MP	Hose I.D.	Hose
 <p>FS 45° S.A.E. FEMALE FLARE</p> <p> 1/4 & 3/8 I.D. ONLY.</p> <p> US</p> <p>MP MALE PIPE THREAD</p> <p>• NOTE: __ ENTER OVERALL LENGTH IN INCHES WHERE APPLICABLE.</p>		I4C __ FS6MP4	3/8	1/4	1/4	Rubber
		I4C __ FS6MP6	3/8	3/8	1/4	Rubber
		I6C __ FS6MP6	3/8	3/8	3/8	Rubber
		I8C __ FS8MP8	1/2	1/2	1/2	Rubber

		PART No.	FS	FS	Hose I.D.	Hose
 <p>FS 45° S.A.E. FEMALE FLARE</p> <p> 1/4 & 3/8 I.D. ONLY.</p> <p> US</p> <p>FS 45° S.A.E. FEMALE FLARE</p> <p>NOTE: 1/2 & LARGER C/W STEEL ENDS</p> <p>• NOTE: __ ENTER OVERALL LENGTH IN INCHES WHERE APPLICABLE.</p>		I4C __ FS6FS6	3/8	3/8	1/4	Rubber
		I4TC __ FS6FS6	3/8	3/8	1/4	Thermoplastic
		I6C __ FS6FS6	3/8	3/8	3/8	Rubber
		I8C __ FS8FS8	1/2	1/2	1/2	Rubber
		I12C __ FS12FS12	3/4	3/4	3/4	Rubber

TO BE INSTALLED BY LICENSED GAS FITTERS ONLY.



U.L. / C.S.A. APPROVED TYPE I PROPANE HOSE ASSEMBLIES

Used To Conduct Propane In Either A Liquid Or Gaseous State Up To 350 P.S.I.

Rubber Temperature Range: -60°F To 212°F (-51°C To 100°C)
Thermoplastic Temperature Range: -40°F To 140°F (-40°C To 60°C)



FJ
37° S.A.E.
FEMALE FLARE



MP
MALE PIPE
THREAD

PART No.	FJ	MP	Hose I.D.	Hose
I12C__FJ12MP12	3/4	3/4	3/4	Rubber
I16C__FJ16MP16	1	1	1	Rubber
I20C__FJ20MP20	1-1/4	1-1/4	1-1/4	Rubber

NOTE: C/W STEEL ENDS

• NOTE: __ ENTER OVERALL LENGTH IN INCHES WHERE APPLICABLE.



FJ
37° S.A.E.
FEMALE FLARE



FJ
37° S.A.E.
FEMALE FLARE

PART No.	FJ	FJ	Hose I.D.	Hose
I12C__FJ12FJ12	3/4	3/4	3/4	Rubber
I16C__FJ16FJ16	1	1	1	Rubber
I20C__FJ20FJ20	1-1/4	1-1/4	1-1/4	Rubber

NOTE: C/W STEEL ENDS

• NOTE: __ ENTER OVERALL LENGTH IN INCHES WHERE APPLICABLE.



FS
45° S.A.E.
FEMALE FLARE



FW
FEMALE WELDING
9/16-18 L.H.

PART No.	FS	FW	Hose I.D.	Hose
I4C__FS4FW	1/4	9/16-18 L.H.	1/4	Rubber

• NOTE: __ ENTER OVERALL LENGTH IN INCHES WHERE APPLICABLE.



FW
FEMALE WELDING
9/16-18 L.H.



FW
FEMALE WELDING
9/16-18 L.H.

PART No.	FW	FW	Hose I.D.	Hose
I4C__FWFW	9/16-18 L.H.	9/16-18 L.H.	1/4	Rubber
I6C__FWFW	9/16-18 L.H.	9/16-18 L.H.	3/8	Rubber

• NOTE: __ ENTER OVERALL LENGTH IN INCHES WHERE APPLICABLE.



FC
1"-20 SWIVEL FEMALE
CYLINDER THREAD



MC
1"-20 SWIVEL MALE
CYLINDER THREAD

PART No.	FC	MC	Hose I.D.	Hose
I4C__FCMC	1"-20	1"-20	1/4	Rubber
I4TC__FCMC	1"-20	1"-20	1/4	Thermoplastic

• NOTE: __ ENTER OVERALL LENGTH IN INCHES WHERE APPLICABLE.

• SUFFIX WITH "P" FOR PACKAGED ASSEMBLY.

TO BE INSTALLED BY LICENSED GAS FITTERS ONLY.

U.L. / C.S.A. APPROVED TYPE I PROPANE HOSE ASSEMBLIES



Used To Conduct Propane In Either A Liquid Or Gaseous State Up To 350 P.S.I.

Rubber Temperature Range: -60°F To 212°F (-51°C To 100°C)
Thermoplastic Temperature Range: -40°F To 140°F (-40°C To 60°C)



POLNE
NO EXCESS
FLOW

POLNE
NO EXCESS
FLOW

PART No.	POLNE	Hose	Hose
I4C__POLNEPOLNE	No Excess Flow	I.D. 1/4	Rubber

• NOTE: __ ENTER OVERALL LENGTH IN INCHES WHERE APPLICABLE.



MP
MALE PIPE THREAD

POL
O-RING P.O.L.
WITH EXCESS FLOW

PART No.	MP	POL	Hose	Hose
I4C__MP4POL	1/4	Excess Flow	I.D. 1/4	Rubber
I4C__MP6POL	3/8	Excess Flow	I.D. 1/4	Rubber

• NOTE: __ ENTER OVERALL LENGTH IN INCHES WHERE APPLICABLE.

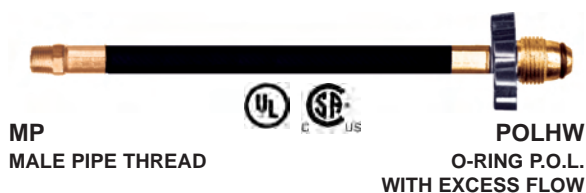

MP
MALE PIPE THREAD

POLHW
O-RING P.O.L.
WITH EXCESS FLOW

PART No.	MP	POL	Hose	Hose
I4C__MP4POLHW	1/4	Hand Wheel	I.D. 1/4	Rubber

• NOTE: __ ENTER OVERALL LENGTH IN INCHES WHERE APPLICABLE.



MI
INVERTED
FLARE

POL
O-RING P.O.L.
WITH EXCESS FLOW

PART No.	MI	POL	Hose	Hose
I4C__MI4POL	1/4	Excess Flow	I.D. 1/4	Rubber
I4TC__MI4POL	1/4	Excess Flow	I.D. 1/4	Thermoplastic

• NOTE: __ ENTER OVERALL LENGTH IN INCHES WHERE APPLICABLE.



MI
INVERTED
FLARE

POLHW
O-RING P.O.L.
WITH EXCESS FLOW

PART No.	MI	POL	Hose	Hose
I4C__MI4POLHW	1/4	Hand Wheel	I.D. 1/4	Rubber
I4TC__MI4POLHW	1/4	Hand Wheel	I.D. 1/4	Thermoplastic

• NOTE: __ ENTER OVERALL LENGTH IN INCHES WHERE APPLICABLE.



MC
1"-20 SWIVEL MALE
CYLINDER THREAD

POLHW
O-RING P.O.L. # 60
ORIFICE HOLE

PART No.	MC	POL	Hose	Hose
I4C__MCPOLHW	1"-20	Hand Wheel	I.D. 1/4	Rubber
I4TC__MCPOLHW	1"-20	Hand Wheel	I.D. 1/4	Thermoplastic

• NOTE: __ ENTER OVERALL LENGTH IN INCHES WHERE APPLICABLE.

• SUFFIX WITH "P" FOR PACKAGED ASSEMBLY.

• AVAILABLE WITHOUT HANDWHEEL - REMOVE (HW) FROM PART NUMBER.

TO BE INSTALLED BY LICENSED GAS FITTERS ONLY.

C

U.L. / C.S.A. APPROVED TYPE I PROPANE HOSE ASSEMBLIES

Used To Conduct Propane In Either A Liquid Or Gaseous State Up To 350 P.S.I.

Rubber Temperature Range: -60°F To 212°F (-51°C To 100°C)
Thermoplastic Temperature Range: -40°F To 140°F (-40°C To 60°C)



MC
1"-20 SWIVEL MALE
CYLINDER THREAD



QCC
1-5/16 FEMALE
ACME THREAD

PART No.	MC	QCC	Hose I.D.	Hose
I4C__MCQCC	1"-20	1-5/16" ACME	1/4	Rubber
I4TC__MCQCC	1"-20	1-5/16" ACME	1/4	Thermoplastic

- NOTE: __ ENTER OVERALL LENGTH IN INCHES WHERE APPLICABLE.
- SUFFIX WITH "P" FOR PACKAGED ASSEMBLY.
- WITH BACK CHECK VALVE.



MI
INVERTED FLARE



QCC
1-5/16 FEMALE
ACME THREAD

PART No.	MI	QCC	Hose I.D.	Hose
I4C__MI4QCC	1/4	1-5/16" ACME	1/4	Rubber
I4TC__MI4QCC	1/4	1-5/16" ACME	1/4	Thermoplastic
I6C__MI4QCC	1/4	1-5/16" ACME	3/8	Rubber
I6TC__MI4QCC	1/4	1-5/16" ACME	3/8	Thermoplastic

- NOTE: __ ENTER OVERALL LENGTH IN INCHES WHERE APPLICABLE.
- WITH BACK CHECK VALVE



MP
MALE PIPE



QCC
1-5/16 FEMALE
ACME THREAD

PART No.	MP	QCC	Hose I.D.	Hose
I4C__MP4QCC	1/4	1-5/16" ACME	1/4	Rubber
I4TC__MP4QCC	1/4	1-5/16" ACME	1/4	Thermoplastic

- NOTE: __ ENTER OVERALL LENGTH IN INCHES WHERE APPLICABLE.
- WITH BACK CHECK VALVE



FP4
FEMALE PIPE
1/4



FP4
FEMALE PIPE
1/4

PART No.	FP4	FP4	Hose I.D.	Hose
I4C__FP4FP4	1/4	1/4	1/4	Rubber

- NOTE: __ ENTER OVERALL LENGTH IN INCHES WHERE APPLICABLE.



FP4
FEMALE PIPE



MP4
MALE PIPE

PART No.	FP4	MP4	Hose I.D.	Hose
I4C__FP4MP4	1/4	1/4	1/4	Rubber

- NOTE: __ ENTER OVERALL LENGTH IN INCHES WHERE APPLICABLE.



FP4
FEMALE PIPE



FS6
45° S.A.E.
FEMALE FLARE

PART No.	FP4	FS6	Hose I.D.	Hose
I4C__FP4FS6	1/4	3/8	1/4	Rubber

- NOTE: __ ENTER OVERALL LENGTH IN INCHES WHERE APPLICABLE.



MI
INVERTED
FLARE

**HIGH
CAPACITY
GREEN
QCC1**

QCC1
1-5/16 FEMALE
ACME THREAD



PART No.	Inverted Flare	QCC1	Length (IN.)	Hose Type
I4TC18MI4QCCP2	1/4	1-5/16	18	Thermoplastic
I4C18MI4QCCP2	1/4	1-5/16	18	Rubber

Specifically designed for use in recreational vehicles, these assemblies are replacements for Propane Regulator to Cylinder connections.

**CONTAINS TWO
ASSEMBLIES**



TO BE INSTALLED BY LICENSED GAS FITTERS ONLY.

GAS~FLO® PROPANE GAS RECREATIONAL VEHICLE ASSEMBLY KITS



The kits below come in a hanger display box complete with instructions.

Rubber Temperature Range: -60°F To +212°F (-51°C To 100°C)
 Thermoplastic Temperature Range: -40°F To +140°F (-40°C To 60°C)



MI
INVERTED
FLARE

QCC1
1-5/16 FEMALE
ACME THREAD



HIGH
CAPACITY
GREEN
QCC1

PART No.	Inverted Flare	Length (IN.)	Hose Type
GR-RVKIT-TPOL-R	1/4	60	Rubber

Specifically designed for use in recreational vehicles, this kit allows for the hook-up of an auxiliary propane cylinder to your trailer's internal propane gas system. Comes complete in reusable carrying case.



Includes 2090 Tee Assembly



FC
1-20 FEMALE
CYLINDER

MC
1-20 MALE
CYLINDER



PART No.	Female Cylinder	Male Cylinder	Length (FT.)	Hose Type
GR-RVKIT-TQC-R	1-20	1-20	12	Rubber

Specifically designed for use in recreational vehicles, this kit allows the hook-up of a Table Top BBQ into your existing propane gas system. Comes complete in reusable carrying case.

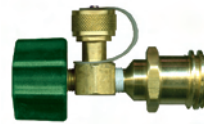

Includes 2499 Tee Assembly



QD
COUPLER

QDN
NIPPLE



PART No.	Valved Coupler	R.V. Q.D. Nipple	Length (FT.)	Hose Type
GR-RVKIT-QD-R	1/4	1/4	12	Rubber

Specifically Designed for use in recreational vehicles this kit allows for the hook-up of a BBQ into your existing vehicle propane gas Q.D. Coupler. Comes complete in reusable carrying case.



Includes BBQ Adapter



C

Hose Approved To Conduct Natural Gas In A Gaseous State And Propane In Either A Liquid Or Gaseous State Up To 350 P.S.I. 50,000 BTU/Hr. Capacity Natural Gas. Q.D. Rated to 1/2 PSIG.

MC
1-20 MALE
CYLINDER



1/4" QDN
QUICK DISCONNECT
NIPPLE

PART No.	R.V. Q.D.	Hose Length	Hose Type
I4C120MCQDN	1/4	120"	Rubber

SEE PAGE 127 FOR KITS.

GAS GRILL SIDE BURNER ASSEMBLIES "Pigtails and Flexible Hose Connectors for LP-Gas"



3/8" FS
S.A.E. FEMALE SWIVEL



1/4" QDN
QUICK DISCONNECT
NIPPLE

PART No.	Female Flare	Q.D. Nipple	Hose Length	Hose Type
I4C18FS6QD	3/8	1/4	18"	Rubber
I4TC18FS6QD	3/8	1/4	18"	Thermoplastic
I4C24FS6QD	3/8	1/4	24"	Rubber
I4TC24FS6QD	3/8	1/4	24"	Thermoplastic
I4C30FS6QD	3/8	1/4	30"	Rubber
I4TC30FS6QD	3/8	1/4	30"	Thermoplastic

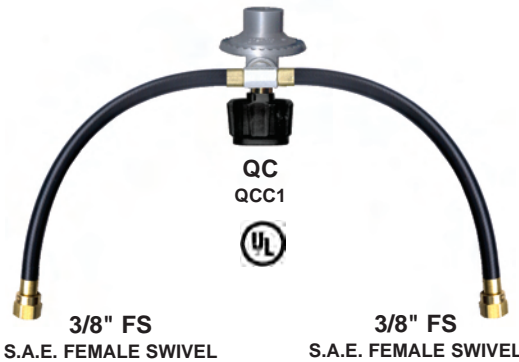

3/8" FS
S.A.E. FEMALE SWIVEL

3/8" FS
S.A.E. FEMALE SWIVEL

PART No.	Female Flare	Each Hose Length
I4LTC18FS6T18FS6GRQC	3/8	18"
I4LTC24FS6T24FS6GRQC	3/8	24"
I4LTC30FS6T30FS6GRQC	3/8	30"
I4LTC36FS6T36FS6GRQC	3/8	36"

Low Pressure Thermoplastic
For Regulator information see below.

- Regulator Specifications**
- Zinc Die Cast
 - Molded Rubber Diaphragms
 - Underwriters Laboratories Listed



GR-766
90° Body c/w QCC1

FLOW CHARACTERISTIC CHART FOR
MODEL GR-700B

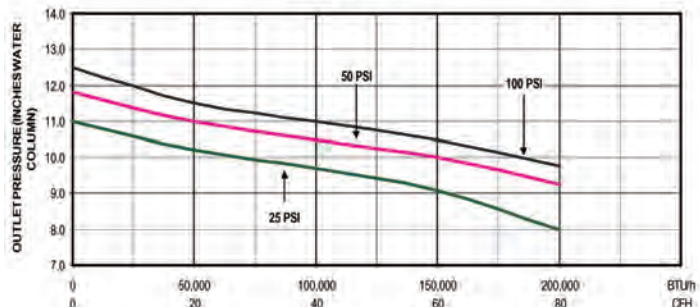

GAS~FLO® U.L. LISTED PROPANE GRILL / BARBECUE REGULATOR ASSEMBLIES



The assemblies below are available individually packaged and are suitable for display racks .
Please suffix PART No. with "P". example: I5LTC24GRQCP Only Available to a Maximum 60" Length.



45° S.A.E. FEMALE
FLARE SWIVEL

QC
QCC1

PART No.	Female		Hose
	Flare	Hose Length	
I5LTC24GRQC	3/8	24"	Thermoplastic
I5LTC30GRQC	3/8	30"	Thermoplastic
I5LTC36GRQC	3/8	36"	Thermoplastic
I5LTC48GRQC	3/8	48"	Thermoplastic
I5LTC60GRQC	3/8	60"	Thermoplastic



45° S.A.E. FEMALE
FLARE SWIVEL

POLHW
O-RING POL
AND HANDWHEEL
NO EXCESS FLOW

PART No.	Female		Hose
	Flare	Hose Length	
I5LTC24GRPOLHW	3/8	24"	Thermoplastic
I5LTC30GRPOLHW	3/8	30"	Thermoplastic
I5LTC36GRPOLHW	3/8	36"	Thermoplastic
I5LTC48GRPOLHW	3/8	48"	Thermoplastic
I5LTC60GRPOLHW	3/8	60"	Thermoplastic



45° S.A.E. FEMALE
FLARE SWIVEL

POL60HW
O-RING POL
WITH #60 ORIFICE HOLE
AND HANDWHEEL

PART No.	Female		Hose
	Flare	Hose Length	
I5LTC24GRPOL60HW	3/8	24"	Thermoplastic
I5LTC30GRPOL60HW	3/8	30"	Thermoplastic
I5LTC36GRPOL60HW	3/8	36"	Thermoplastic
I5LTC48GRPOL60HW	3/8	48"	Thermoplastic
I5LTC60GRPOL60HW	3/8	60"	Thermoplastic

100,000 BTU/HR. Capacity*

*Based on 25 PSIG inlet pressure and 9" W.C. outlet pressure at Manufacturer's set point.
Manufacturer's set point = 100 PSIG and 11" W.C. outlet at 30 SCFH propane.



FLOW CHARACTERISTIC CHART FOR
MODEL GR-700

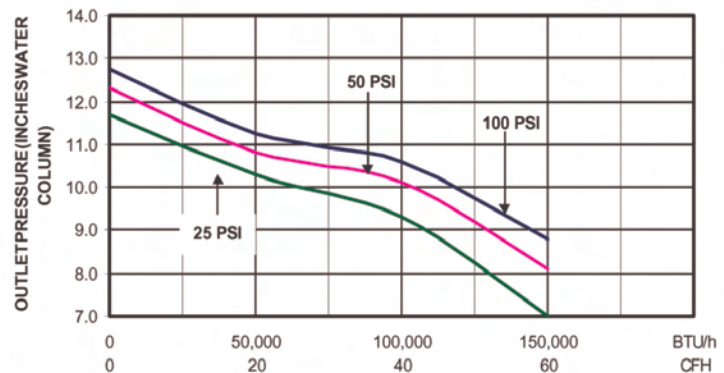

C

3/8" TYPE I HOSE WITH GAS~FLO® QUICK DISCONNECT

RUBBER - Hose Approved to C.G.A. Standard 8.1 Capacity Natural Gas. Q.D. Rated to 1/2 PSIG



Assemblies come complete with dust plug and cap. Remove "PC" if not required.

PART No.	Description	Length	BTU/Hr.
I6C120FS6QDPC	3/8" F. S.A.E. X 3/8" Quick Disconnect	120"	71,208
I6C144FS6QDPC	3/8" F. S.A.E. X 3/8" Quick Disconnect	144"	65,016
I6C180FS6QDPC	3/8" F. S.A.E. X 3/8" Quick Disconnect	180"	51,858
I8C120FS6QDPC	1/2" F. S.A.E. X 1/2" Quick Disconnect	120"	107,741
I8C144FS6QDPC	1/2" F. S.A.E. X 1/2" Quick Disconnect	144"	106,425
I8C180FS6QDPC	1/2" F. S.A.E. X 1/2" Quick Disconnect	180"	99,923
I8C120FS6QDN6	1/2" F. S.A.E. X 3/8" QD Nipple	120"	109,908

3/8" GREY HOSE WITH GAS~FLO® 3/8" QUICK DISCONNECT

CSA Certified to Standard ANSI Z21.54 C.G.A. 8.4 (Thermoplastic) Used To Conduct Natural Gas / Propane
In A Gaseous State Up To 1/2 P.S.I. 80,000 BTU/Hr. Capacity Natural Gas



Assemblies come complete with dust plug and cap. Remove "PC" if not required.

PART No.	Description	Length
I6NGTC120FS6QDPC	3/8" Female S.A.E. Swivel X 3/8" Quick Disconnect	120"
I6NGTC144FS6QDPC	3/8" Female S.A.E. Swivel X 3/8" Quick Disconnect	144"
I6NGTC180FS6QDPC	3/8" Female S.A.E. Swivel X 3/8" Quick Disconnect	180"

Above assemblies come with 3/8" **GAS~FLO®** Coupler and Nipple

LOW TEMPERATURE TYPE I PROPANE DELIVERY HOSE



Approved To Conduct Natural Gas In A Gaseous State
And Propane In Either A Liquid Or Gaseous State Up To 350 P.S.I.



MP
MALE PIPE THREAD

MP
MALE PIPE THREAD

Easy to handle Gas-Flo® Type I delivery hose offers a high-grade Neoprene cover that provides excellent ozone and abrasion resistance. The superior quality hose glides smoothly over any surface and conducts gas in temperatures as low as **-60°F to +212°F, (-51°C to +100°C).**

FOR L.P. DELIVERY TRUCKS.



PART No.	MP	MP	Hose I.D.	Length Feet	Hose
I16C1200MP16MP16	1	1	1	100	Rubber
I16C1500MP16MP16	1	1	1	125	Rubber
I16C1800MP16MP16	1	1	1	150	Rubber

CRYOFLEX LIQUID GAS SUCTION and DELIVERY HOSE

Code 0974 Butane / Propane



This hose is made up of layers of terylene Polyester fabric and Melinex Polyester film, a combination which gives it remarkable insulation. Crush resistance and reinforcement are achieved with a carbon steel inner spiral and mild steel outer spiral. The outer cover of terylene assists in providing protection against abrasion. Ideal for tank truck and rail car loading and unloading of Butane and Propane, sizes 1", 1-1/4", 1-1/2", and 2" are standard tested and tagged in accordance with the C.S.A.

Temperatures from **-60°F to +122°F, (-51°C to +50°C)**

Maximum working pressure: **150 PSI**



MP
MALE PIPE THREAD

MP
MALE PIPE THREAD

PART No.	MP	MP	Hose I.D.	Length Feet	Hose
ICR20C144MP20MP20	1-1/4	1-1/4	1-1/4	12	Terylene
ICR20C720MP20MP20	1-1/4	1-1/4	1-1/4	60	Terylene
ICR32C144MP32MP32	2	2	2	12	Terylene
ICR32C360MP32MP32	2	2	2	30	Terylene

TO BE INSTALLED BY LICENSED GAS FITTERS ONLY.

C



CSA APPROVED TYPE II PROPANE & NATURAL GAS HOSE ASSEMBLIES

Type II, Cotton Covered Stainless Steel Braided Hose. Used To Conduct Natural Gas In A Gaseous State And Propane In Either A Liquid Or Gaseous State Up To 350 P.S.I. Temperature Range: -40°F To +200°F (-40°C To 93°C)



MP **MP**
MALE PIPE THREAD **MALE PIPE THREAD**



PART No.	MP	MP	Hose I.D.
II8C__MP8MP8	1/2	1/2	13/32
II12C__MP12MP12	3/4	3/4	5/8
II16C__MP16MP16	1	1	7/8
II20C__MP20MP20	1-1/4	1-1/4	1-1/8
II32C__MP32MP32	2	2	1-13/16

NOTE: __ ENTER OVERALL LENGTH IN INCHES



FS **MP**
45° S.A.E. FEMALE FLARE **MALE PIPE THREAD**



PART No.	FS	MP	Hose I.D.
II8C__FS8MP8	1/2	1/2	13/32
II12C__FS12MP12	3/4	3/4	5/8

NOTE: __ ENTER OVERALL LENGTH IN INCHES



FS **FS**
45° S.A.E.. FEMALE FLARE **45° S.A.E.. FEMALE FLARE**



PART No.	FS	FS	Hose I.D.
II8C__FS8FS8	1/2	1/2	13/32
II12C__FS12FS12	3/4	3/4	5/8

NOTE: __ ENTER OVERALL LENGTH IN INCHES



FJ **MP**
37° J.I.C. FEMALE FLARE **MALE PIPE THREAD**



PART No.	FJ	MP	Hose I.D.
II8C__FJ8MP8	1/2	1/2	13/32
II12C__FJ12MP12	3/4	3/4	5/8
II16C__FJ16MP16	1	1	7/8
II20C__FJ20MP20	1-1/4	1-1/4	1-1/8
II32C__FJ32MP32	2	2	1-13/16

NOTE: __ ENTER OVERALL LENGTH IN INCHES



FJ **FJ**
37° J.I.C. FEMALE FLARE **37° J.I.C. FEMALE FLARE**



PART No.	FJ	FJ	Hose I.D.
II8C__FJ8FJ8	1/2	1/2	13/32
II12C__FJ12FJ12	3/4	3/4	5/8
II16C__FJ16FJ16	1	1	7/8
II20C__FJ20FJ20	1-1/4	1-1/4	1-1/8
II32C__FJ32FJ32	2	2	1-13/16

NOTE: __ ENTER OVERALL LENGTH IN INCHES

C.S.A. APPROVED TYPE III PROPANE GAS CARBURETION HOSE ASSEMBLIES

Rubber Covered Stainless Steel Braided Hose With Thermoplastic Liner. For Low Permeation Applications. C.S.A. Approved to C.G.A. Standard 8.1. Used To Conduct Propane In Either A Liquid Or Gaseous State Up To 350 P.S.I. Temperature Range: -40°F To +250°F (-40°C To 121°C)



FS **FS**
45° S.A.E. FEMALE FLARE **45° S.A.E. FEMALE FLARE**



PART No.	FS	FS	Hose I.D.
III4C__FS4FS4	1/4	1/4	3/16
III6C__FS6FS6	3/8	3/8	5/16
III8C__FS8FS8	1/2	1/2	13/32

NOTE: __ ENTER OVERALL LENGTH IN INCHES
 FACTORY CRIMP ENDS ONLY.

TO BE INSTALLED BY LICENSED GAS FITTERS ONLY.

NATURAL GAS PURGE KIT

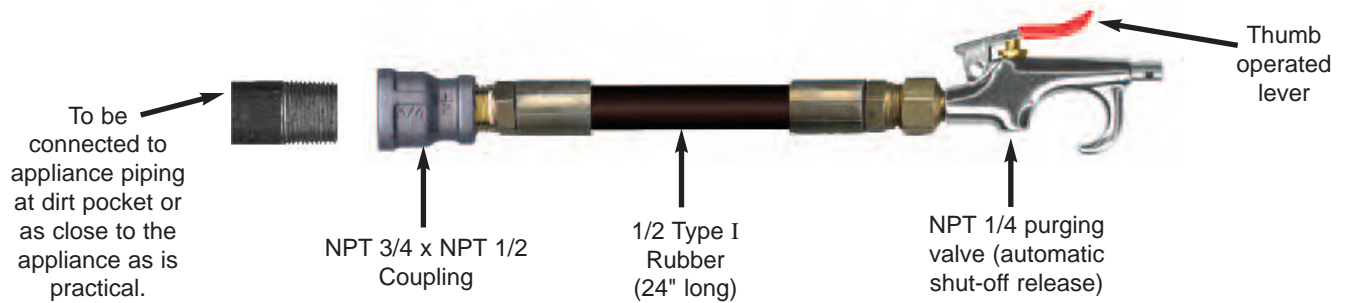

PART No.	Description
NG-PURGE-KIT	Natural Gas Purge Kit

PROPANE TANK PURGE KIT



Fairview's propane tank purge kit has been designed to provide fast, efficient tank purging. Each kit comes complete with a pre-set 15 P.S.I. regulator, three foot flexible Type I rubber hose assembly, forged brass adapters, and a C.G.A. approved 3.16 vapor ball valve.

PART No.	Description
LP-PURGE-1	Standard Propane Tank Purge Kit
LP-PURGE-1PG	Propane Tank Purge Kit with 0-30 PSI Dry Pressure Gauge

ARGON GAS HOSE ASSEMBLY



Argon Gas supply welding hose.

CONSTRUCTION: EPDM cover and tube with high tensile spiral synthetic yarn reinforcement.

TEMPERATURE: -20°F to +200°F, -29°C to + 193°C

COLOR: Black

PART No.	Male Welding	Length (FT.)	Actual I.D. (IN.)
ARG4BLK-6	5/8 - 18 RH	6	1/4
ARG4BLK-10	5/8 - 18 RH	10	1/4
ARG4BLK-25	5/8 - 18 RH	25	1/4
ARG4BLK-50	5/8 - 18 RH	50	1/4
ARG4BLK-100	5/8 - 18 RH	100	1/4

STAINLESS STEEL GAS CONNECTORS (Stationary) FOR DOMESTIC APPLIANCES

• ANSI Z21.24 - C.S.A. 6.10 "Connectors for Gas Appliances"

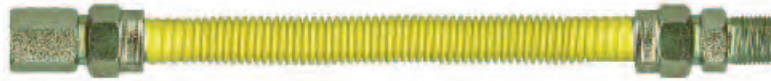

Yellow Coated

ACS Series Gas Appliance Connector BTU Capacity / Hr. (Flow capacities are based 0.64 specific gravity @ 0.5" w.c. pressure drop)									
I.D. (IN.)	Series	12"	18"	24"	30"	36"	48"	60"	72"
1/4"	ACS-250	48,000	43,600	40,000	36,400	33,400	28,300	24,900	23,100
3/8"	ACS-375	102,000	93,100	85,000	77,100	71,000	60,500	53,200	49,100
1/2"	ACS-50	180,000	164,200	150,000	136,000	125,000	106,000	93,200	86,000

**1/2 FPT X 1/2 FPT
5/8 O.D. (1/2" I.D.)**

PART No.	Length (IN.)
ACS-50FF-12	12
ACS-50FF-18	18
ACS-50FF-24	24
ACS-50FF-36	36
ACS-50FF-48	48
ACS-50FF-60	60
ACS-50FF-72	72

**1/2 MPT X 1/2 MPT
5/8 O.D. (1/2" I.D.)**

PART No.	Length (IN.)
ACS-50MM-12	12
ACS-50MM-18	18
ACS-50MM-24	24
ACS-50MM-36	36
ACS-50MM-48	48
ACS-50MM-60	60
ACS-50MM-72	72

**3/4 FPT X 3/4 FPT
5/8 O.D. (1/2" I.D.)**

PART No.	Length (IN.)
ACS-75FF-24	24
ACS-75FF-36	36
ACS-75FF-48	48
ACS-75FF-60	60
ACS-75FF-72	72

**3/4 MPT X 3/4 MPT
5/8 O.D. (1/2" I.D.)**

PART No.	Length (IN.)
ACS-75MM-12	12
ACS-75MM-18	18
ACS-75MM-24	24
ACS-75MM-36	36
ACS-75MM-48	48
ACS-75MM-60	60
ACS-75MM-72	72

**1/2 FPT X 1/2 MPT
5/8 O.D. (1/2" I.D.)**

PART No.	Length (IN.)
ACS-50FM-12	12
ACS-50FM-18	18
ACS-50FM-24	24
ACS-50FM-36	36
ACS-50FM-48	48
ACS-50FM-60	60
ACS-50FM-72	72

**3/4 FPT X 1/2 MPT
5/8 O.D. (1/2" I.D.)**

PART No.	Length (IN.)
ACS-60FM-24	24
ACS-60FM-36	36
ACS-60FM-48	48
ACS-60FM-60	60

**3/4 FPT X 3/4 MPT
5/8 O.D. (1/2" I.D.)**

PART No.	Length (IN.)
ACS-75FM-24	24
ACS-75FM-36	36
ACS-75FM-48	48
ACS-75FM-60	60
ACS-75FM-72	72

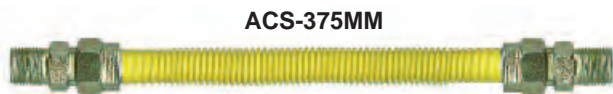

ACS-375MM

Yellow Coated

3/8 Male Pipe

3/8 Male Pipe



ACS-375MBV

Yellow Coated

1/2 Female Pipe
Ball Valve

3/8 Male Pipe



**3/8 MPT X 3/8 MPT
1/2 O.D. (3/8" I.D.)**

PART No.	Length (IN.)
ACS-375MM-10	12
ACS-375MM-16	18
ACS-375MM-22	24
ACS-375MM-28	30
ACS-375MM-34	36
ACS-375MM-46	48
ACS-375MM-58	60
ACS-375MM-70	72

**3/8 MPT X 1/2 FPT Valve
1/2 O.D. (3/8" I.D.)**

PART No.	Length (IN.)
ACS-375MBV-10	12
ACS-375MBV-16	18
ACS-375MBV-22	24
ACS-375MBV-28	30
ACS-375MBV-34	36
ACS-375MBV-46	48
ACS-375MBV-58	60
ACS-375MBV-70	72

**1/2 FPT X 3/8 MPT
1/2 O.D. (3/8" I.D.)**

PART No.	Length (IN.)
ACS-375FM-36	36
ACS-375FM-48	48
ACS-375FM-60	60

**3/8 FPT X 3/8 MPT
3/8 O.D. (1/4" I.D.)**

PART No.	Length (IN.)
ACS-250FM-36	36
ACS-250FM-48	48
ACS-250FM-60	60

**3/8 FPT X 3/8 MPT
3/8 O.D. 1/4" I.D.**

PART No.	Length (IN.)
ACS-250MM-36	36
ACS-250MM-48	48
ACS-250MM-60	60

The above stationary connectors may be used with: Natural, manufactured, mixed liquefied petroleum gases, and LP gas-air mixtures. The added protection of stainless steel is especially useful in areas where the natural gas has a high sulfur content.
Developed for use in: Household Kitchens • Utility Rooms • Laundry Rooms • Pulse Combustion Furnaces (AGAL)
• Forced Air Heating Units • Rooftop HVAC Units • Campfire Log Sets • Fireplaces.

TO BE INSTALLED BY LICENSED GAS FITTERS ONLY.

DORMONT STAINLESS STEEL GAS CONNECTORS (Stationary) FOR DOMESTIC APPLIANCES



Stationary Gas Connector Hose
ANSI Z21.24-C.S.A. 6.10 "Connectors
for Gas Appliances"



PART No.	Length (IN.)	Description	BTU
ACSD-1675NPFS24	24	3/4 MPT To FPT	291,000
ACSD-1675NPFS36	36	3/4 MPT To FPT	256,000
ACSD-1675NPFS48	48	3/4 MPT To FPT	225,000
ACSD-16100NPFS24	24	1 MPT To FPT	582,000

(Flow capacities are based 0.64 specific gravity @ 0.5" w.c. pressure drop)

Technical Drawing

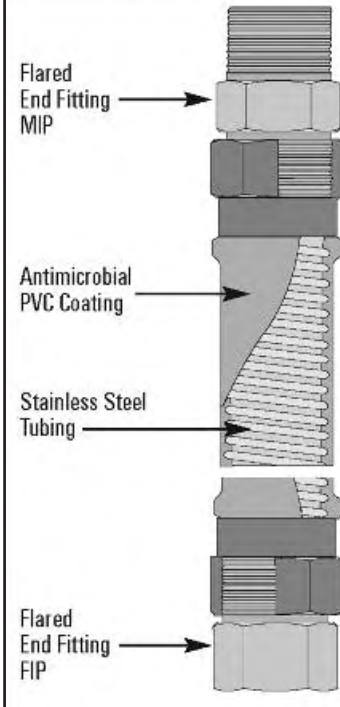

High BTU Stationary Gas Connector
ANSI Z21.75 - C.S.A. 6.27 "Connectors for
Outdoor Gas Appliances & Manufactured



PART No.	Length (IN.)	Description	BTU
ACSHF-75FM-24	24	3/4 MPT To FPT	290,900
ACSHF-100FM-24	24	1 MPT To FPT	581,800

(Flow capacities are based 0.64 specific gravity @ 0.5" w.c. pressure drop)

TUBE TYPE INFRARED HEATER ASSEMBLIES Certified For Canadian Use Only

• C.S.A. Certified to CSA Standard CAN/CGA-8.1

FEMALE PIPE
ADAPTER
46-8D



MALE PIPE
ADAPTER
48-8D



RHK Series BTU Capacity (Flow capacities are based 0.64 specific gravity @ 0.5" w.c. pressure drop)			
Series	30"	36"	42"
RHK-50	132,000	122,000	117,000
RHK-75	235,000	216,000	198,000
RHK-100	504,000	450,000	438,000

"Utilizing straight through fittings with no restrictions" Available in 1" and larger sizes.

1/2 FPT X 1/2 FPT 1/2" I.D. HOSE

PART No.	Length (IN.)
RHK-50FF-30	30
RHK-50FF-36	36
RHK-50FF-42	42

1/2 FPT X 1/2 MPT 1/2" I.D. HOSE

PART No.	Length (IN.)
RHK-50FM-30	30
RHK-50FM-36	36
RHK-50FM-42	42

1/2 MPT X 1/2 MPT 1/2" I.D. HOSE

PART No.	Length (IN.)
RHK-50MM-30	30
RHK-50MM-36	36
RHK-50MM-42	42

3/4 FPT X 3/4 FPT 3/4" I.D. HOSE

PART No.	Length (IN.)
RHK-75FF-30	30
RHK-75FF-36	36
RHK-75FF-42	42

3/4 FPT X 3/4 MPT 3/4" I.D. HOSE

PART No.	Length (IN.)
RHK-75FM-30	30
RHK-75FM-36	36
RHK-75FM-42	42

3/4 MPT X 3/4 MPT 3/4" I.D. HOSE

PART No.	Length (IN.)
RHK-75MM-30	30
RHK-75MM-36	36
RHK-75MM-42	42

TO BE INSTALLED BY LICENSED GAS FITTERS ONLY.



SAFE-T-LINK STAINLESS STEEL GAS CONNECTORS (Movable) FOR COMMERCIAL APPLIANCES

A.N.S.I. Z21.69 - C.S.A. 6.16 "Connectors for Movable Gas Appliances"



For Quick Disconnect Specifications
SEE PAGE: 192



• Comes complete with two
90° elbows for proper installation.

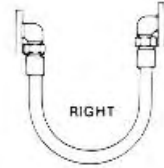

C

1/2 MPT X 1/2 MPT

PART No.	Length (IN.)	Q.D.
ACM-50-GAS-SP36	36	NO
ACM-50-GAS-SPQD36	36	YES
ACM-50-GAS-SP48	48	NO
ACM-50-GAS-SPQD48	48	YES
ACM-50-GAS-SP60	60	NO
ACM-50-GAS-SPQD60	60	YES
ACM-50-GAS-SP72	72	NO
ACM-50-GAS-SPQD72	72	YES

1 MPT X 1 MPT

PART No.	Length (IN.)	Q.D.
ACM-100-GAS-SP36	36	NO
ACM-100-GAS-SPQD36	36	YES
ACM-100-GAS-SP48	48	NO
ACM-100-GAS-SPQD48	48	YES
ACM-100-GAS-SP60	60	NO
ACM-100-GAS-SPQD60	60	YES
ACM-100-GAS-SP72	72	NO
ACM-100-GAS-SPQD72	72	YES

Gas Swivel Link



PART No.	Swivel Pipe
ACM-50-SL	1/2
ACM-75-SL	3/4
ACM-100-SL	1

Reduces hose stress without
restricting flow.

3/4 MPT X 3/4 MPT

PART No.	Length (IN.)	Q.D.
ACM-75-GAS-SP24	24	NO
ACM-75-GAS-SPQD24	24	YES
ACM-75-GAS-SP36	36	NO
ACM-75-GAS-SPQD36	36	YES
ACM-75-GAS-SP48	48	NO
ACM-75-GAS-SPQD48	48	YES
ACM-75-GAS-SP60	60	NO
ACM-75-GAS-SPQD60	60	YES
ACM-75-GAS-SP72	72	NO
ACM-75-GAS-SPQD72	72	YES

1-1/4 MPT X 1-1/4 MPT

PART No.	Length (IN.)	Q.D.
ACM-125-GAS-SP36	36	NO
ACM-125-GAS-SPQD36	36	YES
ACM-125-GAS-SP48	48	NO
ACM-125-GAS-SPQD48	48	YES
ACM-125-GAS-SP60	60	NO
ACM-125-GAS-SPQD60	60	YES
ACM-125-GAS-SP72	72	NO
ACM-125-GAS-SPQD72	72	YES

Safety Cables



PART No.	Length In (IN.)
ACM-GAS-RCP-22	22
ACM-GAS-RCP-34	34
ACM-GAS-RCP-36	36
ACM-GAS-RCP-46	46

PLASTIC COATED STAINLESS STEEL
SAFETY CABLES ARE RECOMMENDED FOR
USE ON CASTOR MOUNTED EQUIPMENT TO
LIMIT THEIR MOBILITY.

ACM Series Gas Appliance Connector BTU Capacity (Flow capacities are based on 0.64 specific gravity @ 0.5" w.c. pressure drop)

Series	36"	48"	60"	72"
ACM-50	125,000	106,000	95,000	86,000
ACM-75	250,000	215,000	200,000	174,000
ACM-100	515,000	443,000	395,000	348,000
ACM-125	945,000	818,000	735,000	634,000
ACM-50-QD	75,000	70,000	65,000	55,000
ACM-75-QD	220,000	180,000	160,000	140,000
ACM-100-QD	380,000	335,000	290,000	280,000
ACM-125-QD	620,000	540,000	475,000	420,000

TO BE INSTALLED BY LICENSED GAS FITTERS ONLY.

SAFE-T-LINK STAINLESS STEEL GAS CONNECTOR KITS (Movable) FOR COMMERCIAL APPLIANCES



A.N.S.I. Z21.69 - C.S.A. 6.16 "Connectors for Movable Gas Appliances"

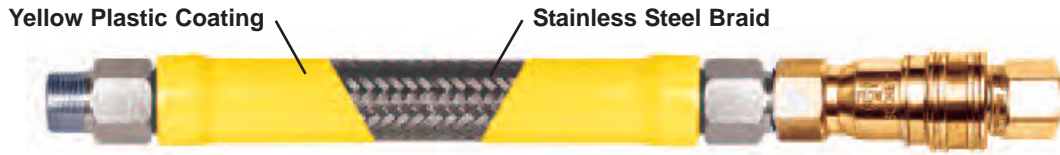

For Quick Disconnect Specifications
SEE PAGE: 192

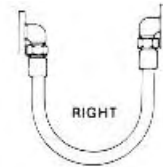

PART No.	Description	Length In (FT.)
ACM-50KIT-36	1/2" Appliance Connector Kit	3
ACM-50KIT-48	Kit Includes : Forged Gas Ball Valve, Restraining Cable,	4
ACM-50KIT-60	Quick Disconnect Coupler & Nipple, (2) 90° Black Iron Elbows,	5
ACM-50KIT-72	(2) Black Iron Nipples	6
ACM-75KIT-36	3/4" Appliance Connector Kit	3
ACM-75KIT-48	Kit Includes : Forged Gas Ball Valve, Restraining Cable,	4
ACM-75KIT-60	Quick Disconnect Coupler & Nipple, (2) 90° Black Iron Elbows,	5
ACM-75KIT-72	(2) Black Iron Nipples	6
ACM-100KIT-36	1" Appliance Connector Kit	3
ACM-100KIT-48	Kit Includes : Forged Gas Ball Valve, Restraining Cable,	4
ACM-100KIT-60	Quick Disconnect Coupler & Nipple, (2) 90° Black Iron Elbows,	5
ACM-100KIT-72	(2) Black Iron Nipples	6

TO BE INSTALLED BY LICENSED GAS FITTERS ONLY.

C



STAINLESS STEEL C.S.A. METAL HOSE ASSEMBLIES

C.S.A. Approved To Standard CR 96-001

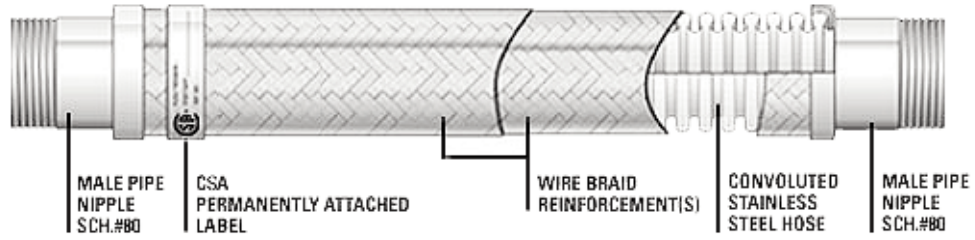

STANDARD ENDS ARE FIXED CARBON STEEL

C

HOW TO ORDER FACTORY MADE STAINLESS STEEL HOSE ASSEMBLIES	HOSE CODE DESCRIPTIONS	HOSE & FITTING SIZE CHART
EXAMPLE PART No.: SSH12C48FJ8MP8C BREAKDOWN: SSH 12 C 48 FJ 8 MP 8 ① ② ③ ④ ⑤ ⑥ ⑦ ⑧	SSH CONVOLUTED STAINLESS STEEL BRAIDED COVER ① SST AS ABOVE WITH PTFE CORE ① HOSE END FITTING CODES FJ FEMALE J.I.C. FLF FLOATING FLANGE FLX FIXED FLANGE FP FEMALE PIPE FS FEMALE S.A.E. MP MALE PIPE	② ⑥ ⑧ 4 = 1/4" 6 = 3/8" 8 = 1/2" 10 = 5/8" 12 = 3/4" 16 = 1" 20 = 1-1/4" 24 = 1-1/2" 32 = 2" 40 = 2-1/2" 48 = 3" 64 = 4" 96 = 6"

NOTE: *List the hose end fitting codes in alphabetical order.
(All assemblies, cleaned, capped, tested and tagged.)

Max. Rated Working Pressures (1/4" To 2") 350 PSIG (2-1/2" To 3") 250 PSIG (4" To 6") 200 PSIG

VAPOR HOSE

Neoprene LPG vapor hose construction combines a smooth high quality neoprene tube with a continuous wire helix, a high tensile synthetic fabric ply and smooth wrapped cover resulting in a superior constructed hose that provides flexibility, durability and performance.



PART No.	Inside Dia.	Outside Dia.	W.P. P.S.I.	Length Feet
VH-12-50	3/4	1-1/16	40	50
VH-16-50	1	1-1/4	40	50

- **COLOR:** Black
- **PACKAGING:** 10FT or 50FT Coils
- **TEMPERATURE:** -30°F to +260°F, -34°C to +127°C

NOTE: WORKING PRESSURE RATED AT +70°F, +21°C. ANY AMBIENT OR INTERNAL INCREASE IN TEMPERATURE WILL LOWER THE WORKING PRESSURE.

PIGTAILS AND HOGTAILS

Propane gas copper pigtails and hogtails provide a flexible connection between the container valve and the regulator.

COPPER TUBE FOR PIGTAILS IS 1/4" O.D. BY .049 WALL.



P.O.L. SHORT NOSE **P.O.L. SHORT NOSE**

PART No.	Length (IN.)
CP-2012	12
CP-2020	20
CP-2030	30
CP-2036	36
CP-2048	48



P.O.L. LONG NOSE (7/8" HEX NUT) **P.O.L. LONG NOSE (7/8" HEX NUT)**

PART No.	Length (IN.)
CP-2520	20
CP-2548	48



P.O.L. LONG NOSE (7/8" HEX NUT) **1/4" (7/16-24) SWIVEL MALE INVERTED FLARE**

PART No.	Length (IN.)
CP-2620	20
CP-2630	30



P.O.L. SHORT NOSE **1/4" SOLID MALE PIPE**

PART No.	Length (IN.)
CP-2412	12
CP-2420	20
CP-2430	30
CP-2436	36



P.O.L. LONG NOSE (1-1/8" HEX NUT) **1/4" (7/16-24) SWIVEL MALE INVERTED FLARE**

PART No.	Length (IN.)
CP-2320	20
CP-2336	36
CP-2348	48



P.O.L. LONG NOSE (1-1/8" HEX NUT) **P.O.L. LONG NOSE (1-1/8" HEX NUT)**

PART No.	Length (IN.)
CP-2120	20
CP-2136	36
CP-2148	48



P.O.L. LONG NOSE (7/8" HEX NUT) **1/4" SOLID MALE PIPE**

PART No.	Length (IN.)
CP-2820	20



P.O.L. SHORT NOSE **1/4" (7/16-24) SWIVEL MALE INVERTED FLARE**

PART No.	Length (IN.)
CP-2220	20
CP-2230	30
CP-2236	36

HOGTAILS

COPPER TUBE FOR HOGTAILS IS 3/8" O.D. BY .049 WALL.

OTHER LENGTHS AVAILABLE ON REQUEST



P.O.L. SHORT NOSE **P.O.L. SHORT NOSE**

PART No.	Length (IN.)
CP-2712	12
CP-2720	20
CP-2730	30
CP-2736	36
CP-2740	40
CP-2748	48



P.O.L. LONG NOSE (7/8" HEX NUT) **P.O.L. LONG NOSE (7/8" HEX NUT)**

PART No.	Length (IN.)
CP-2920	20



P.O.L. LONG NOSE (7/8" HEX NUT) **3/8" SOLID MALE PIPE**

PART No.	Length (IN.)
CP-3012	12

C

STANDARD

(Inverted Flare Thread)



PART No.	Tube O.D. (IN.)	Thread	Length (IN.)
BL-3-08	3/16	3/8 - 24	8
BL-3-12	3/16	3/8 - 24	12
BL-3-20	3/16	3/8 - 24	20
BL-3-30	3/16	3/8 - 24	30
BL-3-40	3/16	3/8 - 24	40
BL-3-51	3/16	3/8 - 24	51
BL-3-60	3/16	3/8 - 24	60
BL-3-72	3/16	3/8 - 24	72
BL-4-08	1/4	7/16 - 24	8
BL-4-12	1/4	7/16 - 24	12
BL-4-20	1/4	7/16 - 24	20
BL-4-30	1/4	7/16 - 24	30
BL-4-40	1/4	7/16 - 24	40
BL-4-51	1/4	7/16 - 24	51
BL-4-60	1/4	7/16 - 24	60
BL-4-72	1/4	7/16 - 24	72
BL-5-12	5/16	1/2 - 20	12
BL-5-20	5/16	1/2 - 20	20
BL-5-30	5/16	1/2 - 20	30
BL-5-40	5/16	1/2 - 20	40
BL-5-51	5/16	1/2 - 20	51
BL-5-60	5/16	1/2 - 20	60
BL-5-72	5/16	1/2 - 20	72
BL-6-12	3/8	5/8 - 18	12
BL-6-20	3/8	5/8 - 18	20
BL-6-30	3/8	5/8 - 18	30
BL-6-40	3/8	5/8 - 18	40
BL-6-51	3/8	5/8 - 18	51
BL-6-60	3/8	5/8 - 18	60

ANTI CORROSION POLY COATED

*The Poly Vinyl Fluorine coating provides 30 times more corrosion resistance than standard brake lines. These brake lines are designed with a copper-brazed, double-wall steel construction which allows for easy bending without kinking. The poly coating complies with



PART No.	Tube O.D. (IN.)	Thread	Length (IN.)
BLP-3-12	3/16	3/8 - 24	12
BLP-3-20	3/16	3/8 - 24	20
BLP-3-30	3/16	3/8 - 24	30
BLP-3-40	3/16	3/8 - 24	40
BLP-3-51	3/16	3/8 - 24	51
BLP-3-60	3/16	3/8 - 24	60
BLP-3-72	3/16	3/8 - 24	72
BLP-4-12	1/4	7/16 - 24	12
BLP-4-20	1/4	7/16 - 24	20
BLP-4-30	1/4	7/16 - 24	30
BLP-4-40	1/4	7/16 - 24	40
BLP-4-51	1/4	7/16 - 24	51
BLP-4-60	1/4	7/16 - 24	60
BLP-4-72	1/4	7/16 - 24	72

ARMORED STANDARD

(Inverted Flare Thread)



PART No.	Tube O.D. (IN.)	Thread	Length (IN.)
BLA-3-08	3/16	3/8 - 24	8
BLA-3-12	3/16	3/8 - 24	12
BLA-3-20	3/16	3/8 - 24	20
BLA-3-30	3/16	3/8 - 24	30
BLA-3-40	3/16	3/8 - 24	40
BLA-3-51	3/16	3/8 - 24	51
BLA-3-60	3/16	3/8 - 24	60
BLA-3-72	3/16	3/8 - 24	72
BLA-4-12	1/4	7/16 - 24	12
BLA-4-20	1/4	7/16 - 24	20
BLA-4-30	1/4	7/16 - 24	30
BLA-4-40	1/4	7/16 - 24	40
BLA-4-51	1/4	7/16 - 24	51
BLA-4-60	1/4	7/16 - 24	60
BLA-4-72	1/4	7/16 - 24	72
BLA-5-20	5/16	1/2 - 20	20
BLA-5-40	5/16	1/2 - 20	40
BLA-5-72	5/16	1/2 - 20	72

JAPANESE STANDARD

(10 x 1.0mm Thread)



PART No.	Tube O.D. (IN.)	Length (IN.)
BLJ-3-08	3/16	8
BLJ-3-12	3/16	12
BLJ-3-20	3/16	20
BLJ-3-30	3/16	30
BLJ-3-40	3/16	40
BLJ-3-51	3/16	51
BLJ-3-60	3/16	60
BLJ-3-72	3/16	72

EUROPEAN STANDARD

(Bubble Flare Thread 10 x 1.0mm)



PART No.	Tube O.D. (IN.)	Length (IN.)
BLE-3-08	3/16	8
BLE-3-12	3/16	12
BLE-3-20	3/16	20
BLE-3-30	3/16	30
BLE-3-40	3/16	40
BLE-3-51	3/16	51
BLE-3-60	3/16	60
BLE-3-72	3/16	72

ANTI CORROSION COATED EUROPEAN STD.

(Bubble Flare Thread 10 x 1.0mm)



PART No.	Tube O.D. (IN.)	Length (IN.)
BLPE-3-08	3/16	8
BLPE-3-12	3/16	12
BLPE-3-20	3/16	20
BLPE-3-30	3/16	30
BLPE-3-40	3/16	40
BLPE-3-51	3/16	51
BLPE-3-60	3/16	60

TUBE



AIR BRAKE TUBE D.O.T.142

ALUMINUM TUBE148

COPPER TUBE146 - 148

NYLON TUBE143

POLYETHYLENE TUBE145

POLYURETHANE (FUEL LINE) TUBE143

P.V.C. - CLEAR144

P.V.C. - CLEAR BRAIDED144

STEEL TUBE (S.A.E. 527)148

TAPE - PIPE LINE IDENTIFICATION147



D.O.T. AIR BRAKE TUBE



STANDARD
COLOR IS BLACK

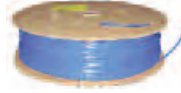

Air brake tube is designed for use with truck, trailer and other mobile air brake and auxiliary systems.

This lightweight, flexible and UV stabilized tube is highly resistant to abrasion, oil, grease and road salt.

- **COLORS:** Black, Blue, Green, Orange, Red, Yellow. Other colors quoted on request. Minimum runs may apply.
- **TEMPERATURE:** -40°F to +200°F, -40°C to +93°C
- **PACKAGING:** Reels, Coils -50, -100
- **FITTINGS:** 1400 or PC1400 Series Page 24 - 26
800 Series Page 9
- **MEETS OR EXCEEDS:** D.O.T. F.M.V.S.S. 106
S.A.E. J844 TEST REQUIREMENTS
- * **NOTE:** 1/8 does not comply with F.M.V.S.S. 106
- ****NOTE:** S.A.E. does not recognize 5/32 O.D. for airbrake systems.

TYPE 3B REINFORCED

PART No.	Tube O.D. (IN.)	Wall Thickness (IN.)	Working Pressure (P.S.I.)	Reel-Coil Length (FT.)
1485-6-100	3/8	0.062	350	100
1485-6-REEL	3/8	0.062	350	500
1485-6BLU-100	3/8	0.062	350	100
1485-6BLU-REEL	3/8	0.062	350	500
1485-6GRN-100	3/8	0.062	350	100
1485-6GRN-REEL	3/8	0.062	350	500
1485-6ORA-100	3/8	0.062	350	100
1485-6ORA-REEL	3/8	0.062	350	500
1485-6RED-100	3/8	0.062	350	100
1485-6RED-REEL	3/8	0.062	350	500
1485-6YEL-100	3/8	0.062	350	100
1485-6YEL-REEL	3/8	0.062	350	500
1485-8-100	1/2	0.062	240	100
1485-8-REEL	1/2	0.062	240	500
1485-8BLU-100	1/2	0.062	240	100
1485-8BLU-REEL	1/2	0.062	240	500
1485-8GRN-100	1/2	0.062	240	100
1485-8GRN-REEL	1/2	0.062	240	500
1485-8ORA-100	1/2	0.062	240	100
1485-8ORA-REEL	1/2	0.062	240	500
1485-8RED-100	1/2	0.062	240	100
1485-8RED-REEL	1/2	0.062	240	500
1485-8YEL-100	1/2	0.062	240	100
1485-8YEL-REEL	1/2	0.062	240	500
1485-10-100	5/8	0.092	225	100
1485-10-REEL	5/8	0.092	225	250
1485-10GRN-100	5/8	0.092	225	100
1485-10GRN-REEL	5/8	0.092	225	250
1485-10ORA-100	5/8	0.092	225	100
1485-10ORA-REEL	5/8	0.092	225	250
1485-10RED-100	5/8	0.092	225	100
1485-10RED-REEL	5/8	0.092	225	250
1485-10YEL-100	5/8	0.092	225	100
1485-10YEL-REEL	5/8	0.092	225	250
1485-12-100	3/4	0.092	200	100
1485-12-REEL	3/4	0.092	200	250
1485-12BLU-100	3/4	0.092	200	100
1485-12BLU-REEL	3/4	0.092	200	250
1485-12GRN-100	3/4	0.092	200	100
1485-12GRN-REEL	3/4	0.092	200	250
1485-12ORA-100	3/4	0.092	200	100
1485-12ORA-REEL	3/4	0.092	200	250
1485-12RED-REEL	3/4	0.092	200	250

TYPE 3A NON-REINFORCED

PART No.	Tube O.D. (IN.)	Wall Thickness (IN.)	Working Pressure (P.S.I.)	Reel-Coil Length (FT.)
* 1485-2-100	1/8	0.023	250	100
* 1485-2-REEL	1/8	0.023	250	2000
**1485-2-1/2-100	5/32	0.036	250	100
**1485-2-1/2-REEL	5/32	0.036	250	1000
1485-3-100	3/16	0.035	250	100
1485-3-REEL	3/16	0.035	250	1000
1485-4-100	1/4	0.040	300	100
1485-4-REEL	1/4	0.040	300	1000
1485-4BLU-100	1/4	0.040	300	100
1485-4BLU-REEL	1/4	0.040	300	1000
1485-4GRN-100	1/4	0.040	300	100
1485-4GRN-REEL	1/4	0.040	300	1000
1485-4ORA-100	1/4	0.040	300	100
1485-4ORA-REEL	1/4	0.040	300	1000
1485-4RED-100	1/4	0.040	300	100
1485-4RED-REEL	1/4	0.040	300	1000
1485-4YEL-100	1/4	0.040	300	100
1485-4YEL-REEL	1/4	0.040	300	1000
1485-5-100	5/16	0.040	250	100
1485-5-REEL	5/16	0.040	250	500

NOTE:

THE WORKING PRESSURES LISTED FOR THIS TUBE IS RATED AT +70°F, +21°C. ANY AMBIENT OR INTERNAL INCREASE IN TEMPERATURE WILL LOWER THE ABOVE LISTED WORKING PRESSURES.



NYLON TUBE



Nylon tube has high mechanical properties, extremely high pressure rating and a wide temperature range. The loss of mechanical strength at elevated temperatures is much less than with other types of plastic tube. It retains its flexibility at sub-zero temperatures.

Nylon tube is odorless, tasteless, non-toxic, fungus and corrosion resistant, readily sterilized in steam or boiling water.

This tube has excellent chemical resistance being unaffected by gasoline, oils, greases, and organic solvents.

Lighter than metal, nylon tube makes for ease in handling and installing. Used with nylon fittings, it provides a completely corrosion resistant tube system. This tube is not recommended for use with strong mineral acids, strong oxidizing agents such as hydrogen peroxide, bleach solutions, phenols and creosols.

Dark colors have a better U.V. resistance for outdoor applications



- **PACKAGING:** 100 FT COILS
NOTE: Reels are available (Minimum run quantities apply)
- **TEMPERATURE:** -20°F TO +230°F, -28°C TO +110°C
- **FITTINGS:** 260 SERIES PAGE 10
1500 SERIES PAGE 14
PC SERIES PAGE 15 - 16
- **COLORS QUOTED ON REQUEST**
- **STOCKED IN NATURAL COLORS (OPAQUE)**

TYPE 11 (FLEXIBLE)				
PART No.	Tube O.D. (IN.)	Actual I.D. (IN.)	Wall Thickness	Working Pressure (P.S.I.)
485-2-100	1/8	.093	.016	200
485-2-1/2-100	5/32	.106	.025	250
485-3-100	3/16	.137	.025	200
485-4-100	1/4	.180	.035	200
485-5-100	5/16	.232	.040	250
485-6-100	3/8	.275	.050	250
485-8-100	1/2	.375	.063	200

TYPE 11 (HEAVY WALL)				
PART No.	Tube O.D. (IN.)	Actual I.D. (IN.)	Wall Thickness	Working Pressure (P.S.I.)
487-2-100	1/8	.078	.024	350
487-4-100	1/4	.170	.040	250
487-6-100	3/8	.265	.055	300

TYPE 6 (SEMI-RIGID)				
PART No.	Tube O.D. (IN.)	Actual I.D. (IN.)	Wall Thickness	Working Pressure P.S.I.
486-2-100	1/8	.093	.016	200
486-2-1/2-100	5/32	.106	.025	250
486-3-100	3/16	.137	.025	200
486-4-100	1/4	.180	.035	200
486-5-100	5/16	.232	.031	200
486-6-100	3/8	.275	.050	250
486-8-100	1/2	.375	.063	200

NOTE:
WORKING PRESSURE RATED AT +70°F, +21°C. ANY AMBIENT OR INTERNAL INCREASE IN TEMPERATURE WILL LOWER THE WORKING PRESSURE.

POLYURETHANE (FUEL LINE) TUBE

This Ether based polyurethane tube has been specially formulated for use with gasoline and is also suitable for such applications as air transfer lines, granular transfer lines, lubrication lines and robotics control lines. It is clear with a blue tint to allow see-through convenience. Polyurethane tube features abrasion and cut resistance, good flex fatigue and resilience and excellent resistance to ozone, solvents and fuel. Items and colors not shown are subject to minimum runs.



- **PACKAGING:** 100 FT COILS
- **TEMPERATURE:** -40°F to +175°F, -40°C to +79°C
- **FITTINGS:** HOSE BARBS PAGE 56 - 57
- **FOR FUEL LINE HOSE SEE PAGE 101.**

NOTE:
WORKING PRESSURE RATED AT +70°F, +21°C. ANY AMBIENT OR INTERNAL INCREASE IN TEMPERATURE WILL LOWER THE WORKING PRESSURE.

PART No.	Tube O.D. (IN.)	Actual I.D. (IN.)	Wall Thickness	Working Pressure P.S.I.
FLT-42-100	1/4	1/8	1/16	100
FLT-53-100	5/16	3/16	1/16	75
FLT-64-100	3/8	1/4	1/16	60
FLT-75-100	7/16	5/16	1/16	50
FLT-86-100	1/2	3/8	1/16	45
FLT-128-100	3/4	1/2	1/8	60





P.V.C. BRAIDED HOSE



Polyvinyl-Chloride Braided Hose is manufactured from F.D.A. approved resins. It has an open mesh nylon braid to withstand higher pressures.

It is transparent (blockages can be easily detected), flexible, light, and non conductive.

It is suitable for use with air, mineral salts, plating solution, water, salt water, and hydrocarbons.



CERTIFIED UNDER STANDARD 51 and 61

NOTE

THE WORKING PRESSURES LISTED FOR THE PVC TUBE IS RATED AT +70°F, +21°C. ANY AMBIENT OR INTERNAL INCREASE IN TEMPERATURE WILL LOWER THE ABOVE LISTED WORKING PRESSURES. THIS TUBE IS NOT RECOMMENDED FOR MILK CONTACT, ALCOHOL (LIQUOR) OR MEDICAL APPLICATIONS.

- **PACKAGING:** 100 FT COILS ALL SIZES
500 FT REELS 1/8" TO 1/2" I.D.
300 FT REELS 5/8" TO 1" I.D.

NOTE: TO ORDER REEL LENGTHS CHANGE -100 TO -REEL ON SIZES 1/8" TO 1" I.D.

- **TEMPERATURE:** -5°F TO +160°F, -21°C TO +71°C
- **FITTINGS:** HOSE BARBS PAGE 56 - 57

PART No.	Hose O.D. (IN.)	Actual I.D. (IN.)	Working Pressure (P.S.I.)
PVC-52-100	.325	1/8	350
PVC-63-100	.375	3/16	250
PVC-84-100	.460	1/4	250
PVC-95-100	.525	5/16	250
PVC-106-100	.600	3/8	225
PVC-128-100	.750	1/2	200
PVC-1410-100	.875	5/8	200
PVC-1712-100	1.025	3/4	150
PVC-2116-100	1.312	1	125
PVC-2820-100	1.620	1-1/4	100
PVC-3224-100	2.000	1-1/2	100
PVC-4032-100	2.500	2	75

CLEAR VINYL TUBE



Clear polyvinyl-chloride tube is manufactured from F.D.A. approved resins.

It is clear, flexible, easy to clean, abrasion resistant and non-contaminating.

It is suitable for the conveyance of air, and water and is used extensively where food and beverages are conveyed.



CERTIFIED UNDER STANDARD 51 and 61

NOTE

THE WORKING PRESSURES LISTED FOR THE VINYL TUBE IS RATED AT +70°F, +21°C. ANY AMBIENT OR INTERNAL INCREASE IN TEMPERATURE WILL LOWER THE ABOVE LISTED WORKING PRESSURES. THIS TUBE IS NOT RECOMMENDED FOR MILK CONTACT, ALCOHOL (LIQUOR) OR MEDICAL APPLICATIONS.

- **PACKAGING:** 100 FT COILS 1/8" TO 1-1/4" I.D.
500 FT REELS 1/8" TO 1/2" I.D.
300 FT REELS 5/8" TO 1" I.D.
50 FT COIL 1-1/2" I.D.

NOTE: TO ORDER REEL LENGTHS CHANGE -100 TO -REEL

- **TEMPERATURE:** +25°F TO +149°F, -4°C TO +65°C
- **FITTINGS:** HOSE BARBS PAGE 56 - 57
- * **THESE ITEMS ARE ALSO AVAILABLE IN REELS. (CHANGE -100 TO -REEL)**

PART No.	Tube O.D. (IN.)	Actual I.D. (IN.)	Working Pressure (P.S.I.)
JFT-42-100	1/4	1/8	65
JFT-53-100	5/16	3/16	55
JFT-63-100 *	3/8	3/16	65
JFT-64-100	3/8	1/4	55
JFT-74-100 *	7/16	1/4	60
JFT-75-100 *	7/16	5/16	50
JFT-84-100 *	1/2	1/4	70
JFT-85-100	1/2	5/16	60
JFT-86-100	1/2	3/8	45
JFT-106-100 *	5/8	3/8	55
JFT-108-100	5/8	1/2	30
JFT-128-100	3/4	1/2	45
JFT-1210-100*	3/4	5/8	30
JFT-1310-100*	13/16	5/8	30
JFT-1410-100	7/8	5/8	40
JFT-1612-100	1	3/4	35
JFT-1812-100	1-1/8	3/4	50
JFT-2014-100 *	1-1/4	7/8	35
JFT-2016-100	1-1/4	1	25
JFT-2416-100 *	1-1/2	1	35
JFT-2420-100 *	1-1/2	1-1/4	20
JFT-3224-50	2	1-1/2	35

POLYETHYLENE TUBE

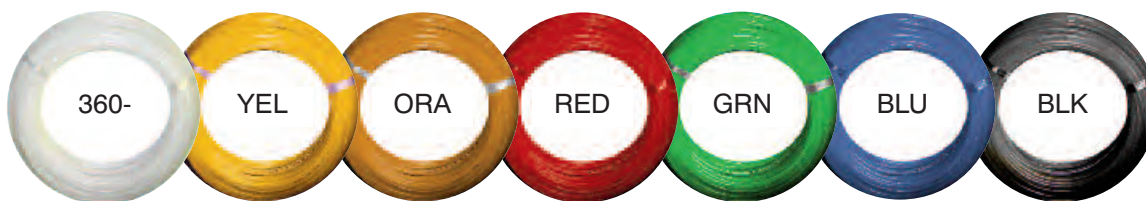

Polyethylene tube is manufactured from F.D.A. approved resins. It has very low moisture absorption. It is fungus resistant, non-corrosive, and highly resistant to stress cracking.

It is suitable for air and water applications and is used for beverage and soda transfer.

It is available in two types, low and high density. Low density provides flexibility and high density, while not as flexible, has a higher temperature and pressure rating.

NOTE
THE WORKING PRESSURES LISTED FOR THE POLY TUBES ARE RATED AT +70°F, +21°C. ANY AMBIENT OR INTERNAL INCREASE IN TEMPERATURE WILL LOWER THE ABOVE LISTED WORKING PRESSURES. THESE TUBES ARE NOT RECOMMENDED FOR MILK CONTACT.

ORDERING INFORMATION

- **PACKAGING:** 100 FT. COILS
 500 AND 1000 FT. REELS ON 360 TUBE
 TO ORDER REELS CHANGE -100 TO -500 OR -1000
- **TEMPERATURE:** LOW DENSITY -40°F to +160°F, -40°C to +71°C
 HIGH DENSITY -40°F to +250°F, -40°C to +121°C
- **FITTINGS:** 400 SERIES PAGE 12
 500 SERIES PAGE 14
 PC SERIES PAGE 15 - 16
 900 SERIES PAGE 63
- **COLOR CODES:** 360 series only: BLK (Black), BLU (Blue), GRN (Green), ORA (ORANGE), Red (Red), YEL (Yellow)
NOT ALL SIZES ARE AVAILABLE IN ALL COLORS. MINIMUM RUNS MAY APPLY.

NOTE: To order a color suffix the size code with a color code example: 360-RED-100, 360-6RED-1000. For natural color (opaque) omit the color code. Dark colors have better U.V. resistance for outdoor applications.

LOW DENSITY					HIGH DENSITY				
PART No.	Tube O.D. (IN.)	Actual I.D. (IN.)	Wall Thickness	Working Pressure (P.S.I.)	PART No.	Tube O.D. (IN.)	Actual I.D. (IN.)	Wall Thickness	Working Pressure (P.S.I.)
360-4-100	1/4	.170	.040	125	359-4-100	1/4	.170	.040	250
360-4H-100	1/4	.125	.062	170	359-4H-100	1/4	.125	.062	280
360-5-100	5/16	.187	.062	130	359-5-100	5/16	.187	.062	250
360-6-100	3/8	.250	.062	100	359-6-100	3/8	.250	.062	250
360-8-100	1/2	.375	.062	90	359-8-100	1/2	.375	.062	250
360-10-100	5/8	.500	.062	80	359-10-100	5/8	.500	.062	160
360-12-100	3/4	.625	.062	60	359-12-100	3/4	.600	.075	160

LINEAR LOW DENSITY POLYETHYLENE TUBE

LLDPE (Linear Low Density Polyethylene) tube features superior toughness, consistency and stronger environmental crack resistance than standard polyethylene tube.

Natural color LLDPE tube is food grade certified and ideal for transfer of air and liquids in the food industry. All LLDPE tube is chemically inert and suitable for applications such as water lines, water softener lines, pneumatic control lines, humidifier fill lines and air conditioner drain lines.

Items and colors not shown are subject to minimum runs.

COLOR CODES: BLK (BLACK)

DARK COLORS HAVE A BETTER U.V. RESISTANCE FOR OUTDOOR APPLICATIONS.

NOTE
THE WORKING PRESSURES LISTED FOR THE POLY TUBES ARE RATED AT +70°F, +21°C. ANY AMBIENT OR INTERNAL INCREASE IN TEMPERATURE WILL LOWER THE ABOVE LISTED WORKING PRESSURES. THESE TUBES ARE NOT RECOMMENDED FOR MILK CONTACT.

- **PACKAGING:** 500, 1000, 1500 & 2000 FT. COILS AS LISTED
- **TEMPERATURE RANGE:** -50°F to +140°F, -46°C TO 60°C
- **FITTINGS:** 400 SERIES PAGE 12
 500 SERIES PAGE 14
 PC SERIES PAGE 15 - 16
 900 SERIES PAGE 63

PART No.	Tube O.D. (IN.)	Actual I.D. (IN.)	Wall Thickness	Working Pressure (P.S.I.)
363-4-500	1/4	.170	.040	140
363-4BLK-500	1/4	.170	.040	140
363-6-500	3/8	.250	.062	125
363-6BLK-500	3/8	.250	.062	125
363-8-500	1/2	.375	.062	100
363-8BLK-500	1/2	.375	.062	100
363-10BLK-500	5/8	.500	.062	75





ANNEALED COPPER

GENERAL USE (ASTM B75)



CERTIFIED UNDER STANDARD 61

FAIRVIEW COPPER TUBE IS SOFT, SEAMLESS AND ANNEALED FOR FLEXIBILITY. CHECK LOCAL CODES TO ENSURE PROPER COPPER TUBE SELECTION TO MEET APPLICATION REQUIREMENTS.

PART No.	Tube O.D. (IN.)	Wall Thickness (IN.)	Working Pressure (P.S.I.)*	Coil Length (FT.)
CTG-4-25	1/4	.030	1406	25
CTG-5-25	5/16	.032	1197	25
CTG-6-25	3/8	.032	984	25
CTG-8-25	1/2	.032	727	25
CTG-10-25	5/8	.035	618	25
CTG-12-25	3/4	.035	511	25

* Working Pressure Rated at +100°F, (+38°C)

HEAVY WALL GENERAL USE



PART No.	Tube O.D. (IN.)	Wall Thickness (IN.)	Working Pressure (P.S.I.)*	Coil Length (FT.)
CTG-6.049-50	3/8	.049	1620	50

* Working Pressure Rated at +100°F, (+38°C)

REFRIGERATION (ASTM B280)



PART No.	Tube O.D. (IN.)	Wall Thickness (IN.)	Working Pressure (P.S.I.)*	Coil Length (FT.)
CTR-2-50	1/8	.030	3074	50
CTR-3-50	3/16	.030	1935	50
CTR-4-50	1/4	.030	1406	50
CTR-4-100	1/4	.030	1406	100
CTR-5-50	5/16	.032	1197	50
CTR-6-50	3/8	.032	984	50
CTR-6-100	3/8	.032	984	100
CTR-8-50	1/2	.032	727	50
CTR-8-100	1/2	.032	727	100
CTR-10-50	5/8	.035	618	50
CTR-10-100	5/8	.035	618	100
CTR-12-50	3/4	.035	511	50
CTR-14-50	7/8	.045	582	50

* Working Pressure Rated at +100°F, (+38°C)

TYPE L (ASTM B88)

THIRD PARTY CERTIFIED (TPC) TUBE



CTL-6-REEL

PART No.	L Size (Nominal)	Tube O.D. (IN.)	Wall Thickness (IN.)	Working Pressure (P.S.I.)*	Coil Length (FT.)
CTL-6-REEL	1/4	3/8	.030	912	**
CTL-6-60	1/4	3/8	.030	912	60

** Please contact us for current reel lengths.

* Working Pressure Rated at +100°F, (+38°C)

D

TYPE K (ASTM B88)

THIRD PARTY CERTIFIED (TPC) TUBE



CERTIFIED UNDER STANDARD 61

PART No.	K Size (Nominal)	Tube O.D. (IN.)	Wall Thickness (IN.)	Working Pressure (P.S.I.)*	Coil Length (FT.)
CTK-6-100	1/4	3/8	.035	1074	100
CTK-8-100	3/8	1/2	.049	1130	100
CTK-10-100	1/2	5/8	.049	891	100
CTK-12-66	5/8	3/4	.049	736	66
CTK-14-100	3/4	7/8	.065	852	100

* Working Pressure Rated at +100°F, (+38°C)

TYPE L (G / GAS) POLY-COATED (ASTM B88 / B837)



SUITABLE UNDER CAN/CGA - B149-00 FOR UNDER GROUND AND ABOVE GROUND USE IN NATURAL GAS AND PROPANE INSTALLATIONS. ALSO SUITABLE FOR USE ON RV'S AND OTHER GAS APPLICATIONS.

LONGER COIL LENGTHS AVAILABLE UPON REQUEST.

PART No.	L Size (Nominal)	Tube O.D. (IN.)	Wall Thickness (IN.)	Working Pressure (P.S.I.)*	Coil Length (FT.)
CTLG-6-60	1/4	3/8	.030	912	60
CTLG-6-100	1/4	3/8	.030	912	100
CTLG-6-250	1/4	3/8	.030	912	250
CTLG-8-60	3/8	1/2	.035	779	60
CTLG-8-100	3/8	1/2	.035	779	100
CTLG-8-250	3/8	1/2	.035	779	250
CTLG-10-60	1/2	5/8	.040	722	60
CTLG-10-100	1/2	5/8	.040	722	100
CTLG-10-250	1/2	5/8	.040	722	250
CTLG-12-60	5/8	3/4	.042	631	60
CTLG-12-100	5/8	3/4	.042	631	100
CTLG-14-100	3/4	7/8	.045	582	100

* Working Pressure Rated at +100°F, (+38°C)

TYPE G / GAS (ASTM B837) TUBE



SUITABLE UNDER CAN/CGA - B149.1-00 FOR ABOVE GROUND AND INDOOR NATURAL GAS AND PROPANE INSTALLATIONS.

PART No.	Tube O.D. (IN.)	Wall Thickness (IN.)	Coil Length (FT.)
CTGB-6-50	3/8	.030	50
CTGB-6-100	3/8	.030	100
CTGB-8-50	1/2	.035	50
CTGB-8-100	1/2	.035	100
CTGB-10-50	5/8	.040	50
CTGB-10-100	5/8	.040	100
CTGB-12-50	3/4	.042	50

PIPE LINE IDENTIFICATION TAPE



Black text on yellow adhesive tape for easy identification.

PART No.	Description	Roll Qty.
GASTAPE-NG	"NATURAL GAS"	216 FT. (66 M.)
GASTAPE-P	"PROPANE GAS"	216 FT. (66 M.)

ORANGE POLY-COATED FUEL-OIL COPPER TUBE



An internal groove in the orange polyethylene coat of the copper tube provides double wall containment and leak detection in fuel-oil installations.

- Meets Criteria of B139.00 and NFPA 31

PART No.	Tube O.D. (IN.)	Coil Length (FT.)
CTLO-6-50	3/8	50
CTLO-6-100	3/8	100
CTLO-8-50	1/2	50
CTLO-8-100	1/2	100
CTLO-10-100	5/8	100

S.A.E. - 527 STEEL TUBE



The green (GRN) anti-corrosion poly coating complies with GM123M-ASV and S.A.E. J527B.

PART No.	Tube O.D. (IN.)	Wall Thickness (IN.)	Working Pressure (P.S.I.)*	Coil Length (FT.)
BLT-3-25	3/16	.028	5000	25
BLT-4-25	1/4	.028	5000	25
BLT-5-25	5/16	.028	5000	25
BLT-6-25	3/8	.028	5000	25
BLT-3GRN-25	3/16	.028	5000	25
BLT-4GRN-25	1/4	.028	5000	25
BLT-5GRN-25	5/16	.028	5000	25
BLT-6GRN-25	3/8	.028	5000	25

FITTINGS: Threaded sleeve, PAGE 8

ASSEMBLIES: Ready-made brake lines, PAGE 140

*** NOTE**

THE WORKING PRESSURES LISTED FOR THIS TUBE IS RATED AT +70°F, +21°C. ANY AMBIENT OR INTERNAL INCREASE IN TEMPERATURE WILL LOWER THE ABOVE LISTED WORKING PRESSURES.

ALUMINUM TUBE (ASTM B-483)



PART No.	Tube O.D. (IN.)	Wall Thickness (IN.)	Working Pressure (P.S.I.)*	Coil Length (FT.)
ALT-2-50	1/8	.025	1333	50
ALT-3-50	3/16	.028	953	50
ALT-4-50	1/4	.032	799	50
ALT-5-50	5/16	.035	690	50
ALT-6-50	3/8	.035	565	50
ALT-7-50	7/16	.035	479	50
ALT-8-50	1/2	.035	415	50
ALT-10-50	5/8	.035	328	50

***NOTE**

THE WORKING PRESSURES LISTED FOR THIS TUBE IS RATED AT +70°F, +21°C. ANY AMBIENT OR INTERNAL INCREASE IN TEMPERATURE WILL LOWER THE ABOVE LISTED WORKING PRESSURES.

D

CLAMPS & TUBE STRAPS

AIR BRAKE HOSE SPACERS	156
AIR BRAKE HOSE SUPPORTS & SPRINGS	156
EXTENDED TONGUE GEAR CLAMPS	150
FLEX SEAL CLAMPS	152
FUEL INJECTION HOSE CLAMPS	153
GEAR CLAMPS	150
O-CLAMPS - (EAR CLAMPS)	153 - 156
OETIKER / TST CONVERSION CHART	155
PEX CLAMPS AND CRIMP RINGS	156
PEX TUBE SUPPORTS	156
PIPE STAY	158
PIPE SUPPORT BLOCK	158
QUICK RELEASE CLAMPS	153
SPRING LOADED GEAR CLAMPS	150
T-BOLT CLAMPS	151
TUBE STRAPS AND HANGERS	157



STANDARD GEAR CLAMPS

For Gear Clamp Display Rack See Page 264



- ALL STAINLESS STEEL
- S.A.E. 1/2 INCH WIDE STAINLESS STEEL BAND AND HOUSING
- S.A.E. STAINLESS STEEL SCREW
- **PACKAGING:** 10 Piece Cartons.
- Sizes 116 and up are Bulk.

PART No.	Range (IN.)	Range (MM)	PART No.
HC5-4TB *	.22 - .63	6 - 16	HC6-4TB *
HC5-5TB *	.44 - .69	11 - 18	HC6-5TB *
HC5-6TB *	.31 - .88	8 - 22	HC6-6TB *
HC5-8TB *	.44 - 1.00	11 - 25	HC6-8TB *
HC5-10TB *	.50 - 1.06	13 - 27	HC6-10TB *
HC5-12TB *	.56 - 1.25	14 - 32	HC6-12TB *
HC5-16TB *	.68 - 1.50	18 - 38	HC6-16TB *
HC5-20TB *	.87 - 1.75	22 - 44	HC6-20TB *
HC5-24TB *	1.31 - 2.00	33 - 51	HC6-24TB *
HC5-6	.37 - .88	10 - 22	HC6-6
HC5-8	.43 - 1.00	11 - 25	HC6-8
HC5-10	.56 - 1.06	14 - 27	HC6-10
HC5-12	.56 - 1.25	14 - 32	HC6-12
HC5-16	.68 - 1.50	17 - 38	HC6-16
HC5-20	.75 - 1.75	19 - 44	HC6-20
HC5-24	1.06 - 2.00	27 - 51	HC6-24
HC5-28	1.31 - 2.25	33 - 57	HC6-28
HC5-32	1.56 - 2.50	40 - 63	HC6-32
HC5-36	1.81 - 2.75	46 - 70	HC6-36
HC5-40	2.06 - 3.00	52 - 76	HC6-40
HC5-44	2.31 - 3.25	59 - 82	HC6-44
HC5-48	2.56 - 3.50	65 - 89	HC6-48
HC5-52	2.81 - 3.75	71 - 95	HC6-52
HC5-56	3.06 - 4.00	78 - 101	HC6-56
HC5-60	3.31 - 4.25	84 - 107	HC6-60
HC5-64	2.50 - 4.50	64 - 114	HC6-64
HC5-72	3.00 - 5.00	76 - 127	HC6-72
HC5-80	3.50 - 5.50	89 - 140	HC6-80
HC5-84	3.75 - 5.75	95 - 146	HC6-84
HC5-88	4.00 - 6.00	102 - 152	HC6-88
HC5-96	4.50 - 6.50	114 - 165	HC6-96
HC5-104	5.00 - 7.00	127 - 178	HC6-104
HC5-116	5.75 - 7.75	146 - 196	HC6-116
HC5-128	6.50 - 8.50	165 - 216	HC6-128
HC5-152	8.00 - 10.00	203 - 254	HC6-152
HC5-164	8.75 - 10.75	222 - 273	HC6-164
HC5-188	10.25 - 12.25	260 - 311	HC6-188
HC5-200	11.00 - 13.00	280 - 330	HC6-200
HC5-212	11.75 - 13.75	299 - 349	HC6-212
HC5-224	12.50 - 14.50	318 - 368	HC6-224
HC5-236	13.25 - 15.25	337 - 387	--
HC5-248	14.75 - 16.00	375 - 406	--
HC5-270	15.37 - 17.38	391 - 441	HC6-270
HC5-312	18.00 - 20.00	457 - 508	HC6-312
HC5-390	22.87 - 24.88	581 - 632	HC6-390

* DENOTES THIN BAND. TB SERIES HAS A 5/16 INCH WIDE BAND.

SPRING LOADED GEAR CLAMPS

FOR USE WITH SILICONE COOLANT HOSE & TURBO CHARGERS



- ALL STAINLESS STEEL
- S.A.E. 1/2 INCH WIDE BAND
- HIGH CORROSION RESISTANCE
- SPRING CONTRACTS AND EXPANDS TO PREVENT COLD FLOW LEAKS
- PROVIDES PERMANENT JOINT SEALING FROM -40°F to +450°F
-40°C to +232°C
- **PACKAGING:** 10 Piece Carton.
- Sizes 500 and up are Bulk.

PART No.	Range (IN.)	Range (MM)
HC4-175	1.00 - 1.75	25 - 44
HC4-200	1.25 - 2.13	32 - 54
HC4-250	1.75 - 2.63	44 - 67
HC4-300	2.25 - 3.13	57 - 80
HC4-350	2.75 - 3.63	70 - 92
HC4-400	3.25 - 4.13	83 - 105
HC4-450	3.75 - 4.63	95 - 118
HC4-500	4.25 - 5.13	108 - 130
HC4-550	4.75 - 5.63	121 - 143

EXTENDED TONGUE CLAMPS



- S.A.E. 1/2 INCH WIDE STAINLESS STEEL BAND HOUSING AND SHIELD
- S.A.E. STEEL CASE HARDENED PLATED SCREW
- EXTENDED TONGUE CLAMPS ARE INTENDED FOR USE WITH SOFT HOSE MATERIAL SUCH AS SILICONE HEATER HOSE AND COOLANT HOSE
- THE INNER SHIELD PROTECTS THE HOSE FROM DAMAGE BY PREVENTING IT FROM COMING IN DIRECT CONTACT WITH THE NOTCHED BAND
- **PACKAGING:** 10 Piece Cartons

PART No.	Range (IN.)	Range (MM)
ETM-4*	.31 - .56	8 - 14
ETM-6*	.56 - .88	14 - 22
ETM-12*	.81 - 1.31	21 - 33
ET-8	.62 - .81	16 - 21
ET-10	.56 - 1.06	14 - 27
ET-12	.68 - 1.51	17 - 33
ET-16	.75 - 1.50	19 - 38
ET-20	1.37 - 1.81	35 - 46
ET-24	1.50 - 2.00	38 - 51
ET-28	1.75 - 2.25	44 - 57
ET-32	2.00 - 2.50	50 - 64
ET-36	1.81 - 2.75	46 - 70
ET-40	2.06 - 3.06	52 - 78
ET-44	2.31 - 3.25	59 - 83
ET-48	2.56 - 3.56	65 - 91
ET-52	2.81 - 3.75	71 - 95
ET-56	3.12 - 4.06	79 - 103
ET-60	3.31 - 4.25	84 - 108
ET-64	3.56 - 4.50	91 - 114

* NOTE: ETM SERIES HAS A 5/16 INCH WIDE BAND

T-BOLT HOSE CLAMPS

For T-Bolt Clamp Display Rack See Page 264



STAINLESS STEEL

BAND: Stainless Steel
BRIDGE: Stainless Steel
SHOE: Stainless Steel
STAINLESS STEEL BOLT, TRUNNION AND NUT

APPLICATIONS:

- Heavy Duty hose connections.
- Used on filter bags, pipe, ducting and center joint irrigation equipment.

PACKAGING: 50 and 100 Piece Cartons.

PART No.	Range (IN.)	Range (MM)
HC2-150	1.31 - 1.56	33 - 40
HC2-175	1.56 - 1.81	40 - 46
HC2-188	1.69 - 1.94	43 - 49
HC2-200	1.81 - 2.06	46 - 52
HC2-225	2.06 - 2.31	52 - 59
HC2-238	2.19 - 2.50	58 - 64
HC2-250	2.31 - 2.62	59 - 67
HC2-256	2.38 - 2.69	60 - 68
HC2-263	2.44 - 2.75	62 - 70
HC2-275	2.56 - 2.87	65 - 73
HC2-288	2.69 - 3.00	68 - 76
HC2-300	2.81 - 3.12	71 - 79
HC2-312	2.94 - 3.25	75 - 83
HC2-325	3.06 - 3.37	78 - 86
HC2-350	3.31 - 3.62	84 - 92
HC2-375	3.56 - 3.87	90 - 98
HC2-382	3.63 - 3.94	92 - 100
HC2-400	3.81 - 4.12	97 - 105
HC2-425	4.06 - 4.37	103 - 111
HC2-450	4.31 - 4.62	110 - 117
HC2-475	4.56 - 4.87	116 - 124
HC2-500	4.81 - 5.12	122 - 130
HC2-525	5.06 - 5.37	129 - 137
HC2-550	5.31 - 5.62	135 - 143
HC2-575	5.56 - 5.87	141 - 149
HC2-600	5.81 - 6.12	148 - 156
HC2-625	6.06 - 6.37	154 - 162
HC2-650	6.31 - 6.62	160 - 168
HC2-675	6.56 - 6.87	167 - 175
HC2-700	6.81 - 7.12	173 - 181
HC2-750	7.31 - 7.62	186 - 194
HC2-825	8.06 - 8.37	205 - 213
HC2-900	8.63 - 8.94	219 - 227



STANDARD

BAND: Stainless Steel
BRIDGE: Stainless Steel
PLATED STEEL BOLT, TRUNNION AND NUT

APPLICATIONS:

- Heavy Duty hose connections.
- Used on filter bags, pipe, ducting and center joint irrigation equipment.

PACKAGING: 50 and 100 Piece Cartons.

PART No.	Range (IN.)	Range (MM)
HC3-150	1.31 - 1.56	33 - 40
HC3-175	1.56 - 1.81	40 - 46
HC3-188	1.69 - 1.94	43 - 49
HC3-200	1.81 - 2.06	46 - 52
HC3-225	2.06 - 2.31	52 - 59
HC3-238	2.19 - 2.50	58 - 64
HC3-250	2.31 - 2.62	59 - 67
HC3-256	2.38 - 2.69	60 - 68
HC3-263	2.44 - 2.75	62 - 70
HC3-275	2.56 - 2.87	65 - 73
HC3-288	2.69 - 3.00	68 - 76
HC3-300	2.81 - 3.12	71 - 79
HC3-312	2.94 - 3.25	75 - 83
HC3-325	3.06 - 3.37	78 - 86
HC3-350	3.31 - 3.62	84 - 92
HC3-375	3.56 - 3.87	90 - 98
HC3-382	3.63 - 3.94	92 - 100
HC3-400	3.81 - 4.12	97 - 105
HC3-425	4.06 - 4.37	103 - 111
HC3-450	4.31 - 4.62	110 - 117
HC3-475	4.56 - 4.87	116 - 124
HC3-500	4.81 - 5.12	122 - 130
HC3-525	5.06 - 5.37	129 - 137
HC3-550	5.31 - 5.62	135 - 143
HC3-575	5.56 - 5.87	141 - 149
HC3-600	5.81 - 6.12	148 - 156
HC3-625	6.06 - 6.37	154 - 162
HC3-650	6.31 - 6.62	160 - 168
HC3-675	6.56 - 6.87	167 - 175
HC3-700	6.81 - 7.12	173 - 181
HC3-750	7.31 - 7.62	186 - 194
HC3-800	7.81 - 8.12	198 - 206



FLEX SEAL CLAMPS

FLEX SEAL (HEAVY DUTY)

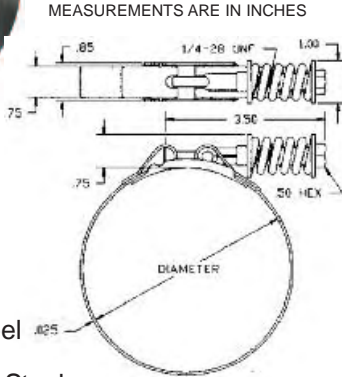

BAND: Stainless Steel
BRIDGE: Stainless Steel
T-BOLT: Carbon Steel
SPRING: High Carbon Steel
FINISH: (T-BOLT): Zinc Plated and Dichromate

APPLICATIONS:

- Designed specifically for silicone hose connections in turbocharged diesel engine air intake and air charge air systems.
- Solves hose "blow-off" failures resulting from cold flow or thermal expansions.

PACKAGING: 50 and 100 Piece Cartons.

PART No.	Range (IN.)	Range (MM)
HC19-225	2.06 - 2.31	52 - 59
HC19-238	2.19 - 2.50	58 - 64
HC19-250	2.31 - 2.62	59 - 67
HC19-263	2.38 - 2.69	60 - 68
HC19-270	2.44 - 2.75	62 - 70
HC19-275	2.56 - 2.87	65 - 73
HC19-288	2.69 - 3.00	68 - 76
HC19-300	2.81 - 3.12	71 - 79
HC19-312	2.94 - 3.25	75 - 83
HC19-325	3.06 - 3.37	78 - 86
HC19-350	3.31 - 3.62	84 - 92
HC19-375	3.56 - 3.87	90 - 98
HC19-382	3.63 - 3.94	92 - 100
HC19-412	3.81 - 4.12	97 - 105
HC19-425	4.06 - 4.37	103 - 111
HC19-450	4.31 - 4.62	110 - 117
HC19-475	4.56 - 4.87	116 - 124
HC19-500	4.81 - 5.12	122 - 130
HC19-525	5.06 - 5.37	129 - 137
HC19-550	5.31 - 5.61	135 - 143
HC19-575	5.56 - 5.87	141 - 149
HC19-600	5.81 - 6.12	148 - 156

MINI FLEX SEAL

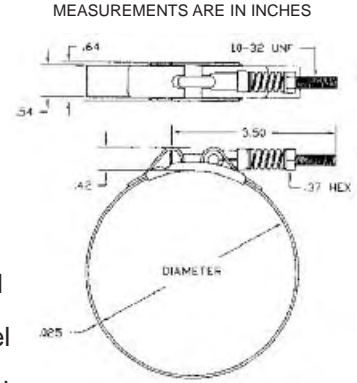

BAND: Stainless Steel
SLEEVE: Brass
BRIDGE: Carbon Steel
T-BOLT: Carbon Steel
SPRING: Carbon Steel
FINISH: (T-BOLT): Zinc Plated and Dichromate

APPLICATIONS:

- Wherever leakage caused by cold flow or thermal expansion is a problem.
- Designed specially for silicone and EPDM hose connections or on radiators and engine blocks / manifolds.
- Solves "blow-off" failures common on air intake /charge-air systems of turbocharged internal combustion engines.

PACKAGING: 50 and 100 Piece Cartons.

PART No.	Range (IN.)	Range (MM)
HC20-150	1.31 - 1.56	33 - 40
HC20-175	1.56 - 1.81	40 - 46
HC20-188	1.69 - 1.94	43 - 49
HC20-200	1.81 - 2.06	46 - 52
HC20-225	2.06 - 2.31	52 - 59
HC20-250	2.31 - 2.62	59 - 67
HC20-263	2.38 - 2.69	60 - 68
HC20-270	2.44 - 2.75	62 - 70
HC20-275	2.56 - 2.87	65 - 73
HC20-288	2.69 - 3.00	68 - 76
HC20-300	2.81 - 3.12	71 - 79
HC20-312	2.94 - 3.25	75 - 83
HC20-325	3.06 - 3.37	78 - 86
HC20-350	3.31 - 3.62	84 - 92
HC20-375	3.56 - 3.87	90 - 98
HC20-400	3.81 - 4.12	97 - 105
HC20-425	4.06 - 4.37	103 - 111
HC20-450	4.31 - 4.62	110 - 117
HC20-550	5.31 - 5.61	135 - 143

E

QUICK RELEASE CLAMPS



Constructed from Stainless Steel materials for corrosion resistance. These clamps feature a unique quick release design that allows for quick and easy installation in restricted or difficult areas. 5/16 Slotted Hexagon Head and 9/16 wide band.

APPLICATIONS:

For applications where clamp must be opened to be applied. Used extensively in the telecommunications industry on cable enclosures where open air applications demand durability.

PACKAGING: 10 Piece Carton.

PART No.	Range (IN.)	Range (MM)
LAS-36	1.00 - 2.39	25 - 70
LAS-48	1.50 - 3.50	38 - 89
LAS-56	1.00 - 4.00	25 - 101
LAS-72	2.00 - 5.00	51 - 127
LAS-88	2.06 - 6.00	52 - 152
LAS-96	3.50 - 6.56	89 - 166
LAS-104	1.75 - 7.00	44 - 178
LAS-128	1.75 - 8.56	44 - 218
LAS-152	2.00 - 10.00	51 - 254
LAS-188	2.06 - 12.31	52 - 313
LAS-248	1.75 - 16.00	44 - 406
LAS-312	1.88 - 20.00	48 - 508

ONE EAR CLAMPS

(With Mechanical Interlock)



Select Nominal Clamp Size nearest to but larger than O.D. on which clamp is to be used.

APPLICATIONS:

1-Ear clamps are intended for low pressure applications such as automotive (not fuel lines), appliances, industrial machinery, underground irrigation systems and beverage dispensing equipment.

SPECIFICATIONS:

The standard HC8 series is manufactured from 1008 carbon steel tube and then zinc plated. Stainless Steel clamps are manufactured from type 304 AISI stainless.

PACKAGING: 25 Piece Bags.

Steel PART No.	Range (IN.)	Range (MM)	Stainless Steel PART No.
HC8-6	.350 - .414	8.9 - 10.5	HC8-6SS
HC8-7	.381 - .444	9.7 - 11.3	HC8-7SS
HC8-8	.453 - .524	11.4 - 13.3	HC8-8SS
HC8-9	.496 - .571	12.6 - 14.5	HC8-9SS
HC8-10	.543 - .618	13.8 - 15.7	--
HC8-11	.549 - .669	15.1 - 17.0	HC8-11SS
HC8-12	.669 - .779	17.0 - 19.8	--
HC8-14	.779 - .890	19.8 - 22.6	--
HC8-15	.839 - .949	21.3 - 24.1	--
HC8-16	.896 - 1.008	22.8 - 25.6	--
HC8-17	.945 - 1.067	24.0 - 27.1	--
HC8-18	1.004 - 1.126	25.5 - 28.6	--
HC8-20	1.122 - 1.244	28.5 - 31.6	--
HC8-21	1.181 - 1.303	30.0 - 33.1	--
HC8-30	1.787 - 1.909	45.4 - 48.5	--

ONE EAR CLAMPS



APPLICATIONS:

One Ear Clamps are commonly used where a low profile protrusion and a small, snug clamping range is of the essence.

They are well suited for Original Equipment Manufacturer (OEM) or Maintenance, Repair and Overhaul (MRO). EPDM rubber hose, plastic tube, electrical cable, strain relief, insert molding, welding and heavily vibrating equipment hoses are readily clamped.

SPECIFICATIONS:

Type 304 AISI stainless steel.

PACKAGING: 25 Piece Bags.

PART No.	Range (IN.)	Range (MM)
HC14-4-1/2	.240 - .276	6.1 - 7.0
HC14-6	.311 - .374	7.9 - 9.5
HC14-8-1/2	.476 - .551	12.1 - 14.0

FUEL INJECTION HOSE CLAMPS



APPLICATIONS:

Clamps are intended for low pressure applications such as automotive fuel injection.

PART No.	Nominal Clamp Size (IN.)
HC21-4	1/4
HC21-5	5/16
HC21-6	3/8

TWO EAR CLAMPS



For Pincer Tools See Page: 243

GREAT HOLDING POWER: Closing the ears builds strength into the clamp which works against the pressure in the hose.

APPLICATIONS: Two Ear Clamps are ideally suited for maintenance and O.E.M. applications, rubber hose, plastic tube, plastic pipe, and coaxial cable are all readily clamped. Uses on air, fluid, gas and steam lines are unlimited.

SPECIFICATIONS: The standard HC9 series is made from 1008 steel tube. They are then zinc plated. Stainless Steel clamps are manufactured from type 304 AISI tube.

PACKAGING: 25 Piece Bags.

Select Nominal Clamp Size nearest to but larger than O.D. on which clamp is to be used.

Steel PART No.	Range (IN.)	Range (MM)	Stainless Steel PART No.
HC9-2	.122 - .161	3.1 - 4.1	--
HC9-3	.118 - .197	3.0 - 5.0	--
HC9-4	.197 - .276	5.0 - 7.0	HC9-4SS
HC9-5	.276 - .354	7.0 - 9.0	HC9-5SS
HC9-6	.315 - .433	8.0 - 11.0	HC9-6SS
HC9-8	.433 - .512	11.0 - 13.0	HC9-8SS
HC9-9	.512 - .591	13.0 - 15.0	HC9-9SS
HC9-9-1/2	.544 - .669	15.0 - 17.0	HC9-9-1/2SS
HC9-10	.591 - .708	15.0 - 18.0	HC9-10SS
HC9-12	.669 - .787	17.0 - 20.0	HC9-12SS
HC9-13	.748 - .866	19.0 - 22.0	HC9-13SS
HC9-14	.787 - .905	20.0 - 23.0	HC9-14SS
HC9-15	.866 - .984	22.0 - 25.0	HC9-15SS
HC9-16	.905 - 1.063	23.0 - 27.0	HC9-16SS
HC9-17	.984 - 1.102	25.0 - 28.0	HC9-17SS
HC9-18	1.063 - 1.220	27.0 - 31.0	HC9-18SS
HC9-21	1.220 - 1.339	31.0 - 34.0	HC9-21SS
HC9-23	1.339 - 1.457	34.0 - 37.0	--
HC9-24	1.457 - 1.575	37.0 - 40.0	HC9-24SS
HC9-26	1.575 - 1.693	40.0 - 43.0	HC9-26SS
HC9-28	1.693 - 1.811	43.0 - 46.0	--

TWO EAR CLAMP FIELD KIT



- PLASTIC BOX
- OETIKER PINCERS
- 2 EAR CLAMP ASSORTMENT

PART No. OE-SB80

CONTENTS					
15	HC9-5	15	HC9-10	12	HC9-16
15	HC9-6	12	HC9-12	1	HC9-R
15	HC9-8	12	HC9-14		
15	HC9-9	12	HC9-15		

STEPLESS® EAR CLAMPS



STEPLESS®:

The term "Stepless" relates to the absence of gaps or steps on the clamp's inner circumference. The unique tongue-in-groove design provides uniform compression and a 360° seal.

APPLICATIONS:

Standard Series Stepless Ear Clamps were perfected for demanding applications where lighter, thin-walled hose or tube is being used.

SPECIFICATIONS:

The standard HC10 series is made from type 304 AISI stainless steel.

PACKAGING: 25 Piece Bags.

Stainless Steel PART No.	Range (IN.)	Range (MM)
HC10-6	.307 - .374	7.8 - 9.5
HC10-7	.378 - .445	9.6 - 11.3
HC10-7-1/2	.398 - .465	10.1 - 11.8
HC10-8	.425 - .524	10.8 - 13.3
HC10-9	.472 - .571	12.0 - 14.5
HC10-10	.520 - .618	13.2 - 15.7
HC10-11-1/2	.602 - .728	15.3 - 18.5
HC10-12	.654 - .779	16.6 - 19.8
HC10-13	.701 - .827	17.8 - 21.0
HC10-14	.764 - .890	19.4 - 22.6
HC10-17	.945 - 1.067	23.9 - 27.1
HC10-21	1.181 - 1.303	29.9 - 33.1
HC10-25	1.378 - 1.500	34.9 - 38.1
HC10-36	2.142 - 2.264	54.3 - 57.5

OETIKER/TST TO FAIRVIEW CONVERSION CHART



OETIKER/TST	PART No.	OETIKER/TST	PART No.	OETIKER/TST	PART No.	OETIKER/TST	PART No.
10100000	HC9-2	10500339	HC8-10	16700061	HC10-33	18500056	OE-SB80
10100000	HC9-2-1/2	10500340	HC8-12	16700062	HC10-34	20500026	QD-SCINDMC6-6F
10100001	HC9-2-3/4	10500341	HC8-17	16700063	HC10-35	20500030	QD-SCINDMC6-6M
10100002	HC9-3	10500343	HC8-20	16700064	HC10-36	20500052	QD-SCINDMC6-4F
10100004	HC9-4	10500344	HC8-24	16700065	HC10-37	20500110	QD-SCINDMC8-8F
10100008	HC9-5	14100037	HC9-P	16700066	HC10-38	20500113	QD-SCINDMC8-8M
10100011	HC9-6	14100083	HC9-S	16700068	HC10-40	20500214	QD-SCINDMC6-4M
10100016	HC9-8	14100118	HC9-R	16700069	HC10-41	20500234	QD-SCCEJNC4-4F
10100019	HC9-9	15100001	HC9-2-3/4SS	16700071	HC10-43	20500240	QD-SCCEJNC4-4M
10100022	HC9-9-1/2	15100002	HC9-3SS	16700073	HC10-44	20500291	QD-SCAROMC4-4F
10100024	HC9-10	15100003	HC9-4SS	16700074	HC10-45	20500292	QD-SCAROMC4-6F
10100027	HC9-12	15100004	HC9-5SS	16700075	HC10-46	20500297	QD-SCAROMC4-4M
10100029	HC9-13	15100006	HC9-8SS	16700076	HC10-47	20500298	QD-SCAROMC4-6M
10100030	HC9-14	15100007	HC9-9SS	16700077	HC10-48	20500311	QD-SCINDMC4-4F
10100032	HC9-15	15100008	HC9-9-1/2SS	16700078	HC10-49	20500312	QD-SCINDMC4-6F
10100034	HC9-16	15100009	HC9-10SS	16700079	HC10-50	20500317	QD-SCINDMC4-4M
10100035	HC9-17	15100010	HC9-12SS	16700081	HC10-52	20500318	QD-SCINDMC4-6M
10100037	HC9-18	15100011	HC9-13SS	16700082	HC10-53	20500349	QD-SCCEJNC6-6F
10100039	HC9-19	15100012	HC9-14SS	16700084	HC10-55	20500354	QD-SCCEJNC6-6M
10100041	HC9-21	15100013	HC9-15SS	16700086	HC10-57	20500395	QD-SCAROMC4-4H
10100043	HC9-23	15100014	HC9-16SS	16700087	HC10-58	20500397	QD-SCAROMC4-6H
10100045	HC9-24	15100015	HC9-17SS	16700088	HC10-59	20500399	QD-SCINDMC4-4H
10100047	HC9-26	15100016	HC9-18SS	16700089	HC10-60	20500401	QD-SCINDMC4-6H
10100049	HC9-28	15100017	HC9-19SS	16700090	HC10-61	20500404	QD-SCCEJNC6-6H
10300008	HC14-4-1/2	15100018	HC9-21SS	16700091	HC10-61-1/2	20500406	QD-SCCEJNC4-4H
10300026	HC14-8-1/2	15100019	HC9-23SS	16700093	HC10-63	20500408	QD-SCCEJNC4-6H
10300061	HC14-6	15100020	HC9-24SS	16700094	HC10-64	20500417	QD-SCINDMC6-6H
10300073	HC14-11	15100021	HC9-26SS	16700095	HC10-65-1/2	25500003	QD-ARON4-4M
10500000	HC8-6	15100022	HC9-28SS	16700096	HC10-66	25500007	QD-ARON4-4F
10500003	HC8-8	15100023	HC9-6SS	16700097	HC10-67	25500014	QD-INDN4-4M
10500012	HC8-13	15500001	HC8-7SS	16700104	HC10-74	25500018	QD-INDN4-4F
10500013	HC8-14	15500003	HC8-8SS	16700216	HC11-22	25500044	QD-INDN6-6M
10500017	HC8-18	15500007	HC8-9SS	16700233	HC11-33	25500045	QD-INDN6-8M
10500018	HC8-19	15500008	HC8-10SS	16700241	HC11-41	25500046	QD-INDN6-4F
10500025	HC8-25	15500009	HC8-11SS	16700242	HC11-42	25500049	QD-INDN6-6F
10500028	HC8-27	15500010	HC8-11-1/2SS	16700251	HC11-50	25500050	QD-INDN6-8F
10500030	HC8-29	15500011	HC8-12SS	16700986	HC10-6	25500066	QD-ARON4-6M
10500031	HC8-30	15500012	HC8-13SS	16700989	HC10-7	25500068	QD-ARON4-6F
10500032	HC8-31	15500013	HC8-14SS	16700993	HC10-8	25500069	QD-INDN4-6M
10500033	HC8-32	15500014	HC8-15SS	16700999	HC10-9	25500177	QD-SCCEJNN6-6M
10500034	HC8-33	15500015	HC8-16SS	16701005	HC10-10	25500178	QD-SCCEJNN6-6F
10500035	HC8-34	15500016	HC8-17SS	16701015	HC10-11-1/2	25500236	QD-INDN6-4M
10500036	HC8-35	15500017	HC8-18SS	16702062	HC10-19	25500240	QD-ARON4-4H
10500037	HC8-36	15500018	HC8-19SS	17800131	HC13-41	25500243	QD-INDN4-4H
10500038	HC8-37	15500019	HC8-20SS	17800132	HC13-44	25500245	QD-INDN4-6H
10500039	HC8-38	15500020	HC8-21SS	17800133	HC13-48	25500247	QD-SCCEJNN4-4H
10500040	HC8-39	15500024	HC8-24SS	17800135	HC13-53	25500247	QD-SCCEJNN6-6H
10500041	HC8-40	15500033	HC8-32SS	17800139	HC13-66	25500253	QD-INDN6-6H
10500043	HC8-42	15500034	HC8-33SS	17800140	HC13-69	25500254	QD-INDN6-8H
10500046	HC8-44	16700022	HC10-12	17800174	HC12-20	25500257	QD-SCCEJNN4-6H
10500048	HC8-46	16700024	HC10-13	17800175	HC12-23	25500266	QD-INDN8-8H
10500050	HC8-48	16700026	HC10-14	17800176	HC12-25	25500274	QD-INDN4-6F
10500055	HC8-53	16700033	HC10-17	17800177	HC12-28	25500275	QD-SCCEJNN4-4F
10500059	HC8-57	16700035	HC10-18	17800178	HC12-32	25500276	QD-SCCEJNN4-4M
10500061	HC8-59	16700042	HC10-21	17800179	HC12-34	25500277	QD-INDN8-6M
10500323	HC8-22	16700044	HC10-22	17800180	HC12-38	25500278	QD-INDN8-8M
10500324	HC8-21	16700048	HC10-24	17800181	HC12-41	25500280	QD-INDN8-8F
10500326	HC8-23	16700050	HC10-25	17800182	HC12-44		
10500327	HC8-16	16700052	HC10-26	17800183	HC12-48		
10500328	HC8-11	16700054	HC10-27	17800184	HC12-50		
10500330	HC8-15	16700055	HC10-27-1/2	17800185	HC12-53		
10500332	HC8-26	16700056	HC10-28	17800186	HC12-56		
10500335	HC8-28	16700057	HC10-29	17800187	HC12-60		
10500337	HC8-7	16700058	HC10-30	17800188	HC12-63		
10500338	HC8-9	16700060	HC10-32	17800189	HC12-66		

E

PEX CLAMPS & CRIMP RINGS



ASTM F2098
**STAINLESS
STEEL
STEPLESS
CLAMPS**

PART No.	Pex
HCPEX-8	3/8
HCPEX-10	1/2
HCPEX-12	5/8
HCPEX-14	3/4
HCPEX-18	1



**BLACK
COPPER
CRIMP
RING**

PART No.	Pex
HCPEX-8-BCR	3/8
HCPEX-10-BCR	1/2
HCPEX-14-BCR	3/4
HCPEX-18-BCR	1

PEX TUBE SUPPORTS



**BEND
SUPPORT**

PART No.	Pex
PEX-BS-10	1/2
PEX-BS-14	3/4



**J-CLAMP
(WITH NAIL)**

PART No.	Pex
PEX-JC-10	1/2
PEX-JC-14	3/4
PEX-JC-18	1

AIR BRAKE HOSE SPACERS



PART No.	Hose I.D. (IN.)
HAB-HANGER-6	3/8
HAB-HANGER-8	1/2

HOSE SUPPORT SPRING



PART No.	Length (IN.)
HAB-SPRING-13	13
HAB-SPRING-16.4	16.4
HAB-SPRING-25	25

TIE STRAPS



MATERIAL: NYLON

NOTE: Black cable ties and other lengths available on request.

PART No.	Max Bundle Dia.	Tie Width	Tie Length	Min. Tensile Strength
TIE-50-7-1/2	1.88"	.190	7.5"	50 lbs.
TIE-50-14-1/2	4.00"	.190	14.5"	50 lbs.
TIE-50-20-4	4.00"	.190	20	50 lbs.

STEEL REINFORCED AIR BRAKE HOSE SUPPORTS



(1 BOLT) HOSE SUPPORT

Used in conjunction with hose support spring.

PART No.	Hose I.D. (IN.)
HAB-HCE-6	3/8
HAB-HCE-8	1/2



(2 BOLT) HOSE SUPPORT

Used in conjunction with hose support spring.

PART No.	Size
HAB-HC2E-6	3/8 Hose I.D.



"U" HOSE SUPPORT

Used in conjunction with hose support spring.

PART No.	Size
HAB-HCU-6	3/8 Hose I.D.
HAB-HCU-8	1/2 Tube O.D.

TUBE STRAPS AND HANGERS



**RUBBER
CUSHIONED
WRAP AROUND
TUBE STRAPS
(1/4 INCH HOLE)**

Steel – Zinc Plated

PART No.	Tube O.D.	Band Width
TS17R-4	1/4	1/2
TS17R-5	5/16	1/2
TS17R-6	3/8	1/2
TS17R-8	1/2	1/2
TS17R-10	5/8	1/2
TS17R-12	3/4	1/2
TS17R-14	7/8	1/2
TS17R-16	1	1/2
TS17R-18	1-1/8	1/2
TS17R-20	1-1/4	1/2
TS17R-24	1-1/2	1/2
TS17R-28	1-3/4	1/2
TS17R-32	2	1/2
TS17R-38	2-3/8	1/2
TS17R-40	2-1/2	1/2
TS17R-48	3	1/2
TS17R-56	3-1/2	1/2
TS17R-64	4	1/2



**RUBBER
CUSHIONED
WRAP AROUND
TUBE STRAPS
(1/4 INCH HOLE)**

Stainless Steel

PART No.	Tube O.D.	Band Width
TSS17R-4	1/4	1/2
TSS17R-6	3/8	1/2
TSS17R-8	1/2	1/2
TSS17R-10	5/8	1/2
TSS17R-12	3/4	1/2
TSS17R-16	1	1/2
TSS17R-20	1-1/4	1/2
TSS17R-24	1-1/2	1/2
TSS17R-32	2	1/2



**RUBBER
CUSHIONED
WRAP AROUND
TUBE STRAPS
(3/8 INCH HOLE)**

Steel – Zinc Plated

PART No.	Tube O.D.	Band Width
TS16R-4	1/4	5/8
TS16R-5	5/16	5/8
TS16R-6	3/8	5/8
TS16R-8	1/2	5/8
TS16R-10	5/8	5/8
TS16R-12	3/4	5/8
TS16R-14	7/8	5/8
TS16R-16	1	5/8
TS16R-18	1-1/8	5/8
TS16R-20	1-1/4	5/8
TS16R-24	1-1/2	5/8
TS16R-32	2	5/8
TS16R-38	2-3/8	5/8
TS16R-40	2-1/2	5/8



**ONE HOLE
TUBE
STRAPS**

Steel – Zinc Plated Heavy Type

PART No.	Tube O.D.	Band Width
TS20-2	1/8	1/2
TS20-3	3/16	1/2
TS20-4	1/4	1/2
TS20-5	5/16	1/2
TS20-6	3/8	5/8
TS20-8	1/2	5/8
TS20-10	5/8	3/4
TS20-12	3/4	3/4
TS20-16	1	7/8



**ONE HOLE
TUBE
STRAPS**

Everdur Copper Heavy Type

PART No.	Tube O.D.	Band Width
TS21-4	1/4	1/2
TS21-6	3/8	5/8
TS21-8	1/2	5/8
TS21-10	5/8	3/4



**“DUPLEX”
DOUBLE
TUBE STRAP**

Steel – Zinc Plated

PART No.	Tube O.D.	Tube O.D.
TS19-44	1/4	1/4
TS19-66	3/8	3/8



**TWO HOLE
STRADDLE
TUBE STRAPS**

Steel - Copper Coated

PART No.	Tube O.D.	Nominal I.D.
TS14-6	3/8	1/4
TS14-8	1/2	3/8
TS14-10	5/8	1/2
TS14-14	7/8	3/4



**TWO HOLE
STRADDLE
TUBE STRAPS**

Solid Copper

PART No.	Tube O.D.	Nominal I.D.
TS15-6	3/8	1/4
TS15-8	1/2	3/8



**TWO HOLE
STRADDLE
PIPE STRAPS**

Steel – Zinc Plated

PART No.	For Pipe Size
TS22-D	1/2
TS22-E	3/4
TS22-H	1
TS22-J	1-1/4
TS22-K	1-1/2
TS22-M	2
TS22-N	2-1/2



**HANGER STRAP
Steel - Copper Coated
3/4” Wide x 1/32” Thick**

PART No.	Length (FT.)
HS11-25	25
HS11-100	100

E

PIPE STAY - STANDARD



Size Range: 1/2" - 2" Copper / 3/8" - 2" Iron Pipe
Material: Carbon Steel
Finish: Black Epoxy Coated
Service: Vertical or Horizontal Offset Pipe Guide

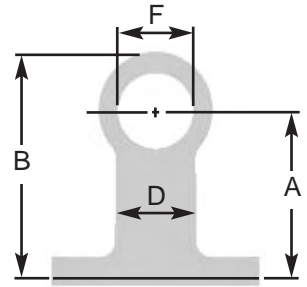

PART No.	Copper/Pipe Size	SPECIFICATION DATA					
		A	B	C	D	E	F
PS-8C	1/2" Copper / 3/8" Iron Pipe	1-1/8	1-13/18	2-1/2	1	1-3/4	11/16
PSL-8C		2-1/2	3-1/8				29/32
PS-12D	3/4" Copper / 1/2" Iron Pipe	1-3/16	1-7/8	3-1/4	1-1/4	2	1-5/32
PSL-12D		2-1/2	3-1/4				
PS-16E	1" Copper / 3/4" Iron Pipe	1-1/2	2-7/16	4	1-3/4	3	1-23/32
PSL-16E		2-11/16	3-9/16				
PS-20H	1-1/4" Copper / 1" Iron Pipe	1-1/2	2-9/16	4-1/2	2-3/16	3-1/4	2-3/16
PSL-20H		2-11/16	3-11/16				
PS-24J	1-1/2" Copper / 1-1/4" Iron Pipe	2-1/2	3-5/8	4	1-3/4	3	1-23/32
PS-K	1-1/2" Iron Pipe	2-5/8	4-3/16	4-1/2	2-3/16	3-1/4	1-31/32
PS-32	2" Copper	2-11/16					2-3/16
PS-M	2" Iron Pipe						2-7/16

ROOFTOP PIPE SUPPORT BLOCK

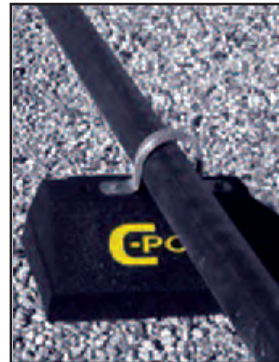
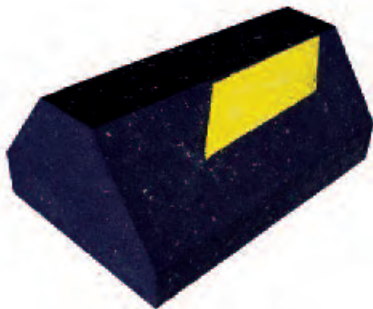

PART No. QB-1

Features:

- 100% Recycled Rubber.
- Compatible with most rooftop materials
- Dampens vibrations.
- No need for supplemental rubber pad.
- Will Not float.
- Will Not deteriorate.
- Extensive product line for all your needs.

Applications:

Air Conditioning, Cable tray, Electric Conduit, Ducts, HVAC, Pipes, Roof walks...

VALVES AND SHUT-OFF COCKS



WHAT'S NEW IN THIS SECTION

- Pressure Protection Valve . . .Pg 172

AIR CHUCKS	172
AIR TANK VALVES	172
ANGLE VALVES	167
BALL VALVES - COMPRESSION - BRASS	168
BALL VALVES - GAS (VAPOR) - BRASS	163 - 164
BALL VALVES - GENERAL PURPOSE - BRASS	160
BALL VALVES - MINIATURE - BRASS	161
BALL VALVES - PEX - BRASS	166
BALL VALVES - STEEL & STAINLESS STEEL	161 - 162
CHECK VALVES	173
DRAIN COCKS & VALVES	171
DRUM & BARREL FAUCETS	168
GATE VALVES - MOLASSES & OIL	167 - 168
GLADHANDS	174
METER VALVES	164
NEEDLE VALVES - BRASS	165 - 166
NEEDLE VALVES - GAS	165
OIL TANK VALVES	168
PEX WATER VALVES	166
PRESSURE PROTECTION VALVES	172
SELECTOR VALVES	167
SHUT-OFF COCKS	166, 169 - 170
SWING CHECK VALVES	173
WATER THREAD VALVES	168

BALL VALVES

FORGED BRASS BALL VALVE - FULL PORT

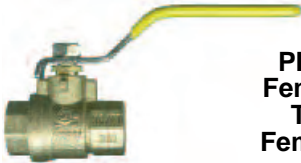

**PIPE
Female
To
Female**

PART No.	Pipe	W.O.G.	W.S.P.
BV2103-A	1/8	600	150
BV2103-B	1/4	600	150
BV2103-C	3/8	600	150
BV2103-D	1/2	600	150
BV2103-E	3/4	600	150
BV2103-H	1	600	150
BV2103-J	1-1/4	600	150
BV2103-K	1-1/2	600	150
BV2103-M	2	600	150
BV2103-N	2-1/2	400	150
BV2103-P	3	400	150

FORGED BRASS BALL VALVE - FULL PORT



**PIPE
Female
To
Female**

With Locking Handle

PART No.	Pipe	W.O.G.	W.S.P.
BV2103-B-LH	1/4	600	150
BV2103-C-LH	3/8	600	150
BV2103-D-LH	1/2	600	150
BV2103-E-LH	3/4	600	150
BV2103-H-LH	1	600	150
BV2103-J-LH	1-1/4	600	150
BV2103-K-LH	1-1/2	600	150
BV2103-M-LH	2	600	150

FORGED BRASS 3-WAY BALL VALVE



**PIPE
Female
Ends
3 - Way**

PART No.	Pipe	W.O.G.
BV2101-B	1/4	400
BV2101-C	3/8	400
BV2101-D	1/2	400
BV2101-E	3/4	400
BV2101-H	1	400
BV2101-J	1-1/4	400
BV2101-K	1-1/2	400
BV2101-M	2	400

BRASS BALL VALVE - FULL PORT



**PIPE
Female
To
Female**

PART No.	Pipe	W.O.G.
BV4103-B	1/4	600
BV4103-C	3/8	600
BV4103-D	1/2	600
BV4103-E	3/4	600
BV4103-H	1	600
BV4103-J	1-1/4	600
BV4103-K	1-1/2	600
BV4103-M	2	600
BV4103-N *	2-1/2	400
BV4103-P *	3	400
BV4103-S *	4	400

* Complete with Stainless Steel Handles.

BRASS BALL VALVE - FULL PORT STAINLESS STEEL HANDLE



**PIPE
Female
To
Female**

PART No.	Pipe	W.O.G.
BV4103-B-SSH	1/4	600
BV4103-C-SSH	3/8	600
BV4103-D-SSH	1/2	600
BV4103-E-SSH	3/4	600
BV4103-H-SSH	1	600
BV4103-J-SSH	1-1/4	600
BV4103-K-SSH	1-1/2	600
BV4103-M-SSH	2	600

FORGED BRASS 3-WAY BALL VALVE

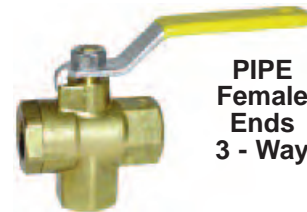

**PIPE
Female
Ends
3 - Way**

PRESSURE RATING:
Bottom Port as inlet 500 P.S.I.
Side Port as inlet 100 P.S.I.

PART No.	Pipe
BV2101T-B	1/4
BV2101T-C	3/8
BV2101T-D	1/2

BRASS BALL VALVE - FULL PORT



**SOLDER
Female
To
Female**



PART No.	Type K Size	W.O.G.
BVC4103-10 *	1/2	600
BVC4103-14 *	3/4	600
BVC4103-18 *	1	600
BVC4103-22	1-1/4	600
BVC4103-26	1-1/2	600
BVC4103-34	2	600

* C.S.A. Certified to 200 PSI for use with Fuel Oil
SOLDERING TEMPERATURES NOT

SAFETY EXHAUST BALL VALVE

**PIPE
Female
To
Female**

PART No.	Pipe
BVSE2103-B	1/4
BVSE2103-C	3/8
BVSE2103-D	1/2
BVSE2103-E	3/4

*THIS VALVE IS DESIGNED TO EXHAUST
DOWNSTREAM AIR IN THE CLOSED POSITION.*

SAFETY EXHAUST BALL VALVE



**PIPE
Female
To
Female**

With Locking Handle

PART No.	Pipe
BVSE2103-B-LH	1/4
BVSE2103-C-LH	3/8
BVSE2103-D-LH	1/2
BVSE2103-E-LH	3/4

*THIS VALVE IS DESIGNED TO EXHAUST
DOWNSTREAM AIR IN THE CLOSED POSITION.*

W.O.G. = WATER, OIL AND GAS W.S.P. = WORKING STEAM PRESSURE

MINIATURE BALL VALVES

- Up to 600 P.S.I. Working Pressure.
- Temperature: -40°F to +300°F -40°C to 149°C
- Non-adjusting O-Ring stem seal design never needs tightening.



**PIPE
Female
To
Female**

PART No.	Pipe	Pipe
BV3103-A	1/8	1/8
BV3103-B	1/4	1/4

- Long life nickel plated brass ball.
- Instantaneous on-off operation.
- Designed for use with water, oil and air pressure systems.



**PIPE
Female
To
Male**

PART No.	Pipe	Pipe
BV3120-A	1/8	1/8
BV3120-B	1/4	1/4

CARBON AND STAINLESS STEEL BALL VALVES

1 - PIECE DESIGN, STANDARD PORT 316 STAINLESS STEEL



PART No.	W.O.G.	Female Pipe
BVSS2003-B	1000	1/4
BVSS2003-C	1000	3/8
BVSS2003-D	1000	1/2
BVSS2003-E	1000	3/4
BVSS2003-H	1000	1
BVSS2003-J	1000	1-1/4
BVSS2003-K	1000	1-1/2
BVSS2003-M	1000	2

2 - PIECE DESIGN, FULL PORT 316 STAINLESS STEEL

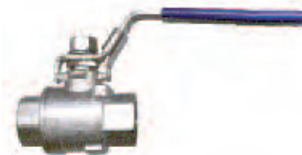

PART No.	W.O.G.	Female Pipe
BVSS2003-B-1000	1000	1/4
BVSS2003-C-1000	1000	3/8
BVSS2003-D-1000	1000	1/2
BVSS2003-E-1000	1000	3/4
BVSS2003-H-1000	1000	1
BVSS2003-J-1000	1000	1-1/4
BVSS2003-K-1000	1000	1-1/2
BVSS2003-M-1000	1000	2

1 - PIECE BAR STOCK DESIGN, STANDARD PORT CARBON STEEL



PART No.	W.O.G.	Female Pipe
BVCS2103-B	2000	1/4
BVCS2103-C	2000	3/8
BVCS2103-D	2000	1/2
BVCS2103-E	2000	3/4
BVCS2103-H	2000	1
BVCS2103-J	2000	1-1/4
BVCS2103-K	2000	1-1/2
BVCS2103-M	2000	2

1 - PIECE BAR STOCK DESIGN, STANDARD PORT 316 STAINLESS STEEL

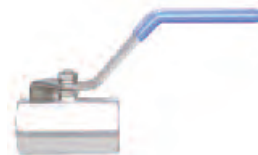

PART No.	W.O.G.	Female Pipe
BVSS2103-B	2000	1/4
BVSS2103-C	2000	3/8
BVSS2103-D	2000	1/2
BVSS2103-E	2000	3/4
BVSS2103-H	2000	1
BVSS2103-J	2000	1-1/4
BVSS2103-K	2000	1-1/2
BVSS2103-M	2000	2

F

BALL VALVES

2 - PIECE DESIGN, FULL PORT

CARBON STEEL



PART No.	W.O.G.	Female Pipe
BVCS2203-B	2000	1/4
BVCS2203-C	2000	3/8
BVCS2203-D	2000	1/2
BVCS2203-E	2000	3/4
BVCS2203-H	2000	1
BVCS2203-J	1500	1-1/4
BVCS2203-K	1500	1-1/2
BVCS2203-M	1500	2

316 STAINLESS STEEL



PART No.	W.O.G.	Female Pipe
BVSS2203-B	2000	1/4
BVSS2203-C	2000	3/8
BVSS2203-D	2000	1/2
BVSS2203-E	2000	3/4
BVSS2203-H	2000	1
BVSS2203-J	1500	1-1/4
BVSS2203-K	1500	1-1/2
BVSS2203-M	1500	2

2 - PIECE DESIGN, MEDIUM PRESSURE, FULL PORT

CARBON STEEL



PART No.	W.O.G.	Female Pipe
BVCS2303-B	3000	1/4
BVCS2303-C	3000	3/8
BVCS2303-D	3000	1/2
BVCS2303-E	3000	3/4
BVCS2303-H	3000	1

3 - PIECE DESIGN, HIGH PRESSURE, FULL PORT

316 STAINLESS STEEL



PART No.	W.O.G.	Female Pipe
-B		
BVSS2403-C	5880	3/8
BVSS2403-D	5880	1/2
BVSS2403-E	5880	3/4
-H		

3 - PIECE DESIGN, HIGH PRESSURE

CARBON STEEL - NPTF PORTS



PART No.	W.O.G.	Female Pipe	Port Style
BVCS2403-B	7250	1/4	Full
BVCS2403-C	7250	3/8	Full
BVCS2403-D	7250	1/2	Full
BVCS2403-E	5075	3/4	Full
BVCS2403-H	5075	1	Full
BVCS2403-J	5075	1-1/4	Standard

CARBON STEEL - ORB PORTS

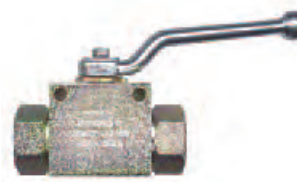

PART No.	W.O.G.	Female O-Ring	Port Style
BVCS2434-4	7250	7/16 - 20	Full
BVCS2434-6	7250	9/16 - 18	Full
BVCS2434-8	7250	3/4 - 16	Full
BVCS2434-12	5075	1-1/16 - 12	Full
BVCS2434-16	5075	1-5/16 - 12	Full

* OTHER CONFIGURATIONS AVAILABLE UPON REQUEST

* ALSO AVAILABLE IN S.A.E. THREADS

C.S.A. CERTIFIED FORGED BRASS BALL VALVES FOR NATURAL AND PROPANE GAS (vapor)



FOR INDOOR / OUTDOOR APPLICATIONS

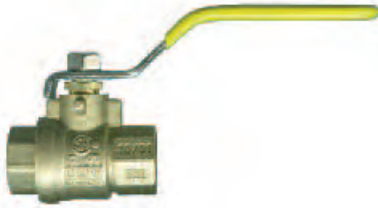

**PIPE
Female
To
Female**

PART No.	Pipe
BV2103-B	1/4
BV2103-C	3/8
BV2103-D	1/2
BV2103-E	3/4
BV2103-H	1
BV2103-J	1-1/4
BV2103-K	1-1/2
BV2103-M	2



C.S.A. certified to C.G.A. (3.16) rated for 125 P.S.I. for use with LPG / Natural Gas

C.S.A. certified to 200 P.S.I. for use with Fuel Oil
Temperature: -40°F to +150°F, -40°C to +65°C.



**PIPE
Female
To
Female**

PART No.	Pipe
BV5221-C	3/8
BV5221-D	1/2
BV5221-E	3/4



C.S.A. certified to 5 P.S.I.
Temperature: -40°F to +125°F, -40°C to +52°C.



**PIPE
Female
To
Female**

PART No.	Pipe
BV5223-D	1/2
BV5223-E	3/4



C.S.A. certified to 5 P.S.I.
Temperature: -40°F to +125°F, -40°C to +52°C.



**FLARE
Tube
To
Tube**

PART No.	Tube
BV5042-6	3/8
BV5042-8	1/2
BV5042-10	5/8



C.S.A. certified to 5 P.S.I. from the appliance to the meter.
Temperature: -40°F to +125°F, -40°C to +52°C.

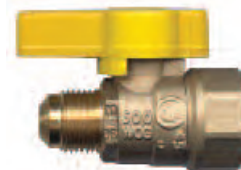

**FLARE
Tube
To
Female Pipe**

PART No.	Tube	Pipe
BV5046-6D	3/8	1/2
BV5046-8D	1/2	1/2



C.S.A. certified to 5 P.S.I. from the appliance to the meter.
Temperature: -40°F to +125°F, -40°C to +52°C.



**FLARE
Tube
To
Male Pipe**

PART No.	Tube	Pipe
BV5048-6D	3/8	1/2
BV5048-8D	1/2	1/2



C.S.A. certified to 5 P.S.I. from the appliance to the meter.
Temperature: -40°F to +125°F, -40°C to +52°C.



**PIPE
Female
To
Female**

PART No.	Pipe
BVT5103-B	1/4
BVT5103-C	3/8
BVT5103-D	1/2
BVT5103-E	3/4
BVT5103-H	1



C.S.A. certified to 1/2 P.S.I. from the appliance to the meter.
Temperature: -40°F to +230°F, -40°C to +110°C.

C.S.A. certified to 5 P.S.I.
Temperature: +32°F to +125°F, 0°C to +52°C.



NOTE: Style of handle varies with pipe size.

CERTIFICATIONS CAN EXPIRE. THEY SHOULD BE CONFIRMED WITH THE APPROVING AGENCIES.

F



C.S.A. CERTIFIED FORGED BRASS BALL VALVES FOR NATURAL AND PROPANE GAS (VAPOR)

LIQUID / VAPOR LP GAS SHUT-OFF VALVES	MANOMETER VALVES																																								
<p>Hot forged brass ball valve, blow out proof stem, double Viton O-ring stem seal. Maximum working pressure 600 PSI.</p>  <p style="text-align: center;">PIPE Female To Female</p> <table border="0"> <tr> <td>PART No.</td> <td>Pipe</td> <td></td> </tr> <tr> <td>BV9503-B</td> <td>1/4</td> <td rowspan="2">UL US</td> </tr> <tr> <td>BV9503-C</td> <td>3/8</td> </tr> <tr> <td>BV9503-D</td> <td>1/2</td> <td rowspan="2">SF US</td> </tr> <tr> <td>BV9503-E</td> <td>3/4</td> </tr> <tr> <td>BV9503-H</td> <td>1</td> <td rowspan="4">SF US</td> </tr> <tr> <td>BV9503-J</td> <td>1-1/4</td> </tr> <tr> <td>BV9503-K</td> <td>1-1/2</td> </tr> <tr> <td>BV9503-M</td> <td>2</td> </tr> </table> <p>UL Listed to 600 PSIG C.S.A. Certified to CGA 3.16 to 125 PSIG</p> <p>Temperature: -40°F to +350°F -40°C to +177°C</p>	PART No.	Pipe		BV9503-B	1/4	UL US	BV9503-C	3/8	BV9503-D	1/2	SF US	BV9503-E	3/4	BV9503-H	1	SF US	BV9503-J	1-1/4	BV9503-K	1-1/2	BV9503-M	2	 <p style="text-align: center;">PIPE Female To Female</p> <table border="0"> <tr> <td>PART No.</td> <td>Pipe</td> <td></td> </tr> <tr> <td>BVTM5103-C</td> <td>3/8</td> <td rowspan="2">SF US</td> </tr> <tr> <td>BVTM5103-D</td> <td>1/2</td> </tr> <tr> <td>BVTM5103-E</td> <td>3/4</td> <td></td> </tr> </table> <p>C.S.A. Certified to 1/2 P.S.I. from the appliance to the meter.</p> <p>Temperature: -40°F to +230°F -40°C to +110°C</p>	PART No.	Pipe		BVTM5103-C	3/8	SF US	BVTM5103-D	1/2	BVTM5103-E	3/4		 <p style="text-align: center;">FLARE Tube To Tube</p> <table border="0"> <tr> <td>PART No.</td> <td>Tube</td> <td></td> </tr> <tr> <td>BVTM5042-8</td> <td>1/2</td> <td>SF US</td> </tr> </table> <p>C.S.A. Certified to 1/2 P.S.I. from the appliance to the meter.</p> <p>Temperature: -40°F to +230°F -40°C to +110°C</p>	PART No.	Tube		BVTM5042-8	1/2	SF US
PART No.	Pipe																																								
BV9503-B	1/4	UL US																																							
BV9503-C	3/8																																								
BV9503-D	1/2	SF US																																							
BV9503-E	3/4																																								
BV9503-H	1	SF US																																							
BV9503-J	1-1/4																																								
BV9503-K	1-1/2																																								
BV9503-M	2																																								
PART No.	Pipe																																								
BVTM5103-C	3/8	SF US																																							
BVTM5103-D	1/2																																								
BVTM5103-E	3/4																																								
PART No.	Tube																																								
BVTM5042-8	1/2	SF US																																							

C.S.A. CERTIFIED NATURAL AND LP GAS METER VALVES

Features and Specifications:

- * Hot forged sand blasted, unplated brass body and cap sealed with Loctite.
- * Approved by Canadian standards Association (CSA formerly AGA and CGA) to ASME B16.33 & AGA Req't #3-88, Underwriters Laboratories (UL), Canadian Underwriters Laboratories (cUL).
- * Full port to DIN 3357 for maximum flow.
- * Pure PTFE self-lubricating seats with flexible-lip design.
- * Chrome plated brass ball for longer life.
- * No metal-to-metal moving parts.
- * Blowout-proof nickel plated brass stem.
- * No maintenance ever required.
- * Travel stops on body to avoid stresses at stem.
- * Hot forged brass tamper proof locking.
- * Cover clearly shows ball position.
- * NPT taper ANSI B1.20.1 Female by Female threads.
- * Silicone-free lubricant on all seals.
- * 600 PSI non-shock cold working pressure.



PAINTED

PIPE Female To Female



Temperature: -40°F to +350°F
-40°C to +177°C

PAINTED
PART No.
BV2203P-D **Pipe** 1/2
BV2203P-E 3/4

CERTIFICATIONS CAN EXPIRE. THEY SHOULD BE CONFIRMED WITH THE APPROVING AGENCIES.

BRASS PRECISION NEEDLE VALVES

C.S.A. CERTIFIED FOR LP GAS TO 350 P.S.I.



These instrumentation valves have knurled brass hand wheels, and are for use with air, LP gases (such as torch applications) and liquids. Each valve is pressure tested at the factory. The valve body's machined from brass bar stock. The stem is stainless steel with a fine thread for controlling flow. O-ring packing assures leak proof trouble free service.



**PIPE
Female
To
Male**



PART No.	Flow	Pipe
850-A	→	1/8
850-B	→	1/4
850-BRF (REVERSE FLOW)	←	1/4



**WELDING
STANDARD
To
Male Pipe**



PART No.	Pipe	Flow	Welding Thread
853-L	1/4	→	9/16-18 L.H.
854-L (REVERSE FLOW)	1/4	←	9/16-18 L.H.



**PIPE
Male
To
Male**



PART No.	Pipe
851-A	1/8
851-B	1/4



**PIPE
Female
To
Female**



PART No.	Pipe
852-A	1/8
852-B	1/4

CERTIFICATIONS CAN EXPIRE. THEY SHOULD RECONFIRMED WITH THE APPROVING AGENCIES.

BRASS PRECISION NEEDLE VALVES



**PIPE
Female
To
Male**

PART No.
850-BRF-SP
(REVERSE FLOW)

Flow ← **Pipe**
1/4

HUMIDIFIER WATER NEEDLE VALVE ASSEMBLIES



**NEEDLE
VALVE
ASSEMBLY**

**Complete With
Brass Forged Clamp**

PART No.	Description
S3069-4	For 1/4 O.D. Tube Assembly
S3069-WT	Brass Clamp Only



**NEEDLE VALVE
ASSEMBLY
Complete With Steel
Clamp (Zinc Plated)**

PART No.	Description
S3069-ST-4	Self Tapping Assembly
Packaged complete with insert, sleeve and instructions.	

F



NEEDLE VALVES

(FOR WORKING PRESSURE UP TO 150 P.S.I.)



FLARE
Tube
To
Tube

PART No.	Tube
3042-4	1/4
3042-6	3/8



COMPRESSION
ELBOW
Tube
To
Male Pipe

PART No.	Tube	Pipe
3069-4A	1/4	1/8
3069-4B	1/4	1/4
3069-6B	3/8	1/4



PIPE
Male
To
Male

PART No.	Pipe
3122-A	1/8
3122-B	1/4



FLARE
ELBOW
Tube
To
Male Pipe

PART No.	Tube	Pipe
3049-4A	1/4	1/8



PIPE
Female
To
Female

PART No.	Pipe
3103-A	1/8
3103-B	1/4



COMPRESSION
Poly Tube
To
Poly Tube

PART No.	Tube
3462-4	1/4
3462-6	3/8



COMPRESSION
Tube
To
Tube

PART No.	Tube
3062-4	1/4
3062-5	5/16
3062-6	3/8



PIPE
Female
To
Male

PART No.	Pipe
3120-A	1/8
3120-B	1/4



COMPRESSION
Poly Tube
To
Male Pipe

PART No.	Tube	Pipe
3469-4A	1/4	1/8

FORGED BRASS PEX WATER BALL VALVES



PEX
To Female
Sweat

PART No.	PEX	TUBE
BVPEX2126SW-10	1/2	1/2 K
BVPEX2126SW-14	3/4	3/4 K

Double Viton® O-ring blow-out proof stem design 400 WOG



PEX
To
PEX

PART No.	PEX	PEX
BVPEX2129-10	1/2	1/2
BVPEX2129-14	3/4	3/4
BVPEX2129-18	1	1

Double Viton® O-ring blow-out proof stem design 400 WOG

PEX WATER SHUT-OFF VALVES



PEX
To
Compression
Straight

PART No.	PEX	TUBE
WSPEX68-106	1/2	3/8



PEX
To
Compression
90° Elbow

PART No.	PEX	TUBE
WSPEX69-106	1/2	3/8

F

GATE VALVES



FEMALE PIPE

PART No.	Pipe	W.O.G.
217-B	1/4	200
217-C	3/8	200
217-D	1/2	200
217-E	3/4	200
217-H	1	200
217-J	1-1/4	200
217-K	1-1/2	200
217-M	2	200
217-N	2-1/2	200
217-P	3	200
217-S	4	200

ANGLE VALVES



FLARE TO MALE PIPE Forged Body

PART No.	Tube	Pipe	P.S.I.
1049-6B	3/8	1/4	200
1049-6C	3/8	3/8	200
1049-6D	3/8	1/2	200
1049-8C	1/2	3/8	200
1049-10D	5/8	1/2	200

SELECTOR VALVES WITH CLICK



**THREE WAY
SHUT-OFF**
With Mounting Bracket
Flow Either Of
Two Side Ports
To Center Port,
All Ports Female Pipe

PART No.	Pipe	Stem Length	P.S.I.
2101-B	1/4	1-3/8"	30
2101-C	3/8	1-3/8"	30

OPERATING TEMPERATURE: -40°F to +180°F, -40°C to +82°C



**FOUR WAY
SHUT-OFF**
With Mounting Bracket
Flow Either Of
Three Side Ports
To Bottom Port,
All Ports Female Pipe

PART No.	Pipe	Stem Length	P.S.I.
2102-B	1/4	1-3/8"	30
2102-C	3/8	1-3/8"	30

OPERATING TEMPERATURE: -40°F to +180°F, -40°C to +82°C



HOSE TO MALE PIPE Forged Body

PART No.	Hose I.D.	Pipe	P.S.I.
1139-6C	3/8	3/8	200
1139-8C	1/2	3/8	200
1139-10C	5/8	3/8	200
1139-10D	5/8	1/2	200
1139-12C	3/4	3/8	200
1139-12D	3/4	1/2	200



HOSE TO MALE PIPE Forged Body Heater Valve

PART No.	Hose I.D.	Pipe	P.S.I.
HV1139-10C	5/8	3/8	200



MALE PIPE TO FEMALE PIPE Forged Body

PART No.	Male Pipe	Female Pipe	P.S.I.
1115-CC	3/8	3/8	200
1115-DC	1/2	3/8	200



FLARE TO MALE PIPE Forged Body

PART No.	Tube	Pipe	P.S.I.
1054-6D	3/8	1/2	200
1054-6E	3/8	3/4	200

F

OIL TANK VALVES



**MALE PIPE
TO
MALE PIPE**

CSA Certified to 200 PSI for use with Fuel ,Oil.
Temperature: -40°F to +149°F
-40°C to +65°C

PART No.	Pipe	Pipe	W.O.G.
1122-DC	1/2	3/8	200



**MALE FLARE
TO
MALE PIPE**
(Complete with flare nut 40-6)

CSA Certified to 200 PSI for use with Fuel ,Oil.
Temperature: -40°F to +149°F
-40°C to +65°C

PART No.	Tube	Pipe	W.O.G.
1048-6D	3/8	1/2	200



**1/4 TURN
BALL VALVE
MALE PIPE TO
MALE PIPE**

CSA Certified to 200 PSI for use with Fuel ,Oil.
Temperature: -40°F to +149°F
-40°C to +65°C

PART No.	Pipe	Pipe	W.O.G.
BV1122-DC	1/2	3/8	200



**1/4 TURN
BALL VALVE
MALE FLARE TO
MALE PIPE**
(Complete with flare nut 40-6)

CSA Certified to 200 PSI for use with Fuel ,Oil.
Temperature: -40°F to +149°F
-40°C to +65°C

PART No.	Tube	Pipe	W.O.G.
BV1048-6D	3/8	1/2	200



**1/4 TURN
90° BALL VALVE
MALE PIPE
TO
MALE PIPE**

CSA Certified to 200 PSI for use with Fuel ,Oil.
Temperature: -40°F to +149°F
-40°C to +65°C

PART No.	Pipe	Pipe	W.O.G.
BV1199-DC	1/2	3/8	200



**1/4 TURN
90° BALL VALVE
MALE FLARE TO
MALE PIPE**
(Complete with flare nut 40-6)

CSA Certified to 200 PSI for use with Fuel ,Oil.
Temperature: -40°F to +149°F
-40°C to +65°C

PART No.	Tube	Pipe	W.O.G.
BV1049-6D	3/8	1/2	200
BV1049-8D	1/2	1/2	200

WATER THREAD VALVES



**WATER HOSE
TO
MALE PIPE**

* I.D. OF MALE PIPE WILL
ACCOMMODATE
1/2 TYPE K COPPER
TUBE FOR SOLDERING

CSA Certified to 200 PSI for use with Fuel ,Oil.
Temperature: -40°F to +149°F
-40°C to +65°C

PART No.	Pipe
224-D *	1/2
224-E	3/4



**WATER HOSE
TO
MALE PIPE**

* I.D. OF MALE PIPE WILL
ACCOMMODATE
1/2 TYPE K COPPER
TUBE FOR SOLDERING

CSA Certified to 200 PSI for use with Fuel ,Oil.
Temperature: -40°F to +149°F
-40°C to +65°C

PART No.	Pipe
225-D *	1/2

COMPRESSION BALL VALVE



**FORGED BODY
TUBE TO
TUBE**

PART No.	Copper L Size
BV2062-10	1/2
BV2062-14	3/4
BV2062-18	1



MALE PIPE

PART No.	Pipe
MGV-E	3/4
MGV-H	1
MGV-M	2

DRUM AND BARREL FAUCETS



SELF-CLOSING NYLON SEAT

PART No.	Pipe
G261	3/4

NOT AFFECTED BY WEATHER



HEAVY DUTY

PART No.	Pipe
262-E	3/4

(Complete with removable hose barb)

FOR USE WITH: • All Petroleum Products • Degreasing Hydrocarbon Liquids • Alcohol • Auto Anti-Freeze • Lacquers • Varnishes • Thinners
NOT FOR USE WITH: Trichlorethylene And Other Chlorinated Products Or Detergents And Water Solution Chemicals.

BRASS SPRING BOTTOM SHUT-OFF COCKS

(Not Recommended For Use With Liquids)



**FLARE
Tube
To
Tube**

PART No.	Tube	P.S.I.
2042-6	3/8	30

TEMPERATURE: -40°F to +250°F
-40°C to +121°C



**PIPE
Female
To
Female**

PART No.	Pipe	P.S.I.
2103-A	1/8	30
2103-B	1/4	30
2103-C	3/8	30

TEMPERATURE: -40°F to +250°F
-40°C to +121°C



**FLARE
Tube
To
Male Pipe**

PART No.	Tube	Pipe	P.S.I.
2048-4B	1/4	1/4	30
2048-5B	5/16	1/4	30
2048-6B	3/8	1/4	30

TEMPERATURE: -40°F to +250°F
-40°C to +121°C



**PIPE
Female
To
Male**

PART No.	Pipe	P.S.I.
2120-A	1/8	30
2120-B	1/4	30
2120-C	3/8	30

TEMPERATURE: -40°F to +250°F
-40°C to +121°C



**COMPRESSION
Tube
To
Male Pipe**

PART No.	Tube	Pipe	P.S.I.
2068-4B	1/4	1/4	30

TEMPERATURE: -40°F to +250°F
-40°C to +121°C



**PIPE
Male
To
Male**

PART No.	Pipe	P.S.I.
2122-B	1/4	30
2122-C	3/8	30

TEMPERATURE: -40°F to +250°F
-40°C to +121°C

BRASS CLOSED BOTTOM SHUT-OFF COCKS



**PIPE
Female
To
Female**

PART No.	Pipe	P.S.I.
5103-B	1/4	30
5103-C	3/8	30

TEMPERATURE: -40°F to +250°F
-40°C to +121°C



**PIPE
Female
To
Male**

PART No.	Pipe	P.S.I.
5120-A	1/8	30
5120-B	1/4	30
5120-C	3/8	30

TEMPERATURE: -40°F to +250°F
-40°C to +121°C



**PIPE
Male
To
Male**

PART No.	Pipe	P.S.I.
5122-A	1/8	30
5122-B	1/4	30
5122-C	3/8	30

TEMPERATURE: -40°F to +250°F
-40°C to +121°C

F



SHUT-OFF COCKS

HEX SHOULDER - TEE HANDLE



DOUBLE FEMALE
Hex Shoulder
Tee Handle

PART No.	Pipe	P.S.I.
6103-B	1/4	100

TEMPERATURE: 0°F to +180°F
-18°C to +82°C



DOUBLE MALE
Hex Shoulder
Tee Handle

PART No.	Pipe	P.S.I.
6122-B	1/4	100

TEMPERATURE: 0°F to +180°F
-18°C to +82°C



MALE AND FEMALE
Hex Shoulder
Tee Handle

PART No.	Pipe	P.S.I.
6120-A	1/8	100
6120-B	1/4	100
6120-C	3/8	100

TEMPERATURE: 0°F to +180°F
-18°C to +82°C



STRAIGHT DRAIN
Hex Shoulder
Tee Handle

PART No.	Pipe	P.S.I.
6125-A	1/8	100
6125-B	1/4	100

TEMPERATURE: 0°F to +180°F
-18°C to +82°C

ROUND SHOULDER - TEE HANDLE



DOUBLE FEMALE
Round Shoulder
Tee Handle

PART No.	Pipe	P.S.I.
7103-B	1/4	100

TEMPERATURE: 0°F to +180°F
-18°C to +82°C



MALE AND FEMALE
Round Shoulder
Tee Handle

PART No.	Pipe	P.S.I.
7120-A	1/8	100
7120-B	1/4	100
7120-C	3/8	100

TEMPERATURE: 0°F to +180°F
-18°C to +82°C

HEX SHOULDER - LEVER HANDLE



DOUBLE FEMALE
Hex Shoulder
Lever Handle

PART No.	Pipe	P.S.I.
8103-A	1/8	100
8103-B	1/4	100
8103-C	3/8	100

TEMPERATURE: 0°F to +180°F
-18°C to +82°C



STRAIGHT DRAIN
Hex Shoulder
Lever Handle

PART No.	Pipe	P.S.I.
8125-A	1/8	100
8125-B	1/4	100

TEMPERATURE: 0°F to +180°F
-18°C to +82°C



MALE AND FEMALE
Hex Shoulder
Lever Handle

PART No.	Pipe	P.S.I.
8120-A	1/8	100
8120-B	1/4	100
8120-C	3/8	100

TEMPERATURE: 0°F to +180°F
-18°C to +82°C

LIMITED STOCK OF SOME DISCONTINUED ITEMS IS STILL AVAILABLE; ASK AT YOUR LOCAL FAIRVIEW LOCATION.

FAIRVIEW AIR COCKS ARE NOT DESIGNED FOR USE WITH STEAM OR LIQUID.

BACK SEATING TYPE



BACK SEATING TYPE WITH EXTENSION OUTLET

PART No. 239-B	Pipe 1/4	Working Pressure (P.S.I.) Designed for Constant Pressure use between 20 and 150 PSI
--------------------------	--------------------	---



BACK SEATING TYPE

PART No. 240-A 240-B 240-C 240-D	Pipe 1/8 1/4 3/8 1/2	Working Pressure (P.S.I.) Designed for Constant Pressure use between 15 and 150 PSI
---	---	---

GROUND KEY PLUG TYPE



GROUND KEY PLUG TYPE LEVER HANDLE

PART No. 241-A 241-B 241-C 241-D	Pipe 1/8 1/4 3/8 1/2	Working Pressure (P.S.I.) 30 30 30 30
---	---	--



GROUND KEY PLUG TYPE LEVER HANDLE (Heavy Pattern)

PART No. 241HP-B	Pipe 1/4	Working Pressure (P.S.I.) 150
----------------------------	--------------------	---



HEAVY DUTY GROUND KEY PLUG TYPE TEE HANDLE

PART No. T241-B	Pipe 1/4	Working Pressure (P.S.I.) 150
---------------------------	--------------------	---

LIMITED STOCK OF SOME DISCONTINUED ITEMS IS STILL AVAILABLE; ASK AT YOUR LOCAL FAIRVIEW LOCATION.

NEEDLE SEAT TYPE



NEEDLE SEAT ONE PIECE PLUG AND HANDLE

PART No. 242-A 242-B 242-C	Pipe 1/8 1/4 3/8	Working Pressure (P.S.I.) 200 200 200
--	----------------------------------	---



90° ELBOW SHUT-OFF WITH SPOUT

PART No. 245-A 245-B	Hose I.D. 1/4 3/8	Pipe 1/8 1/4	Working Pressure (P.S.I.) 50 50
-----------------------------------	--------------------------------	---------------------------	--



NEEDLE SEAT

PART No. 243-A 243-B 243-C	Pipe 1/8 1/4 3/8	Working Pressure (P.S.I.) Designed for Constant Pressure use between 15 and 150 PSI
--	----------------------------------	---



AIR CHUCKS AND VALVES

AIR CHUCKS



Fairview's industrial grade brass ball chucks with 1/4" female NPT thread are ideally suited for use on live air lines supplying compressed air.

PART No. Description

- BC-B Ball Chuck
- BC-B-LH Ball Chuck (Locking handle) **



Fairview's industrial grade dual foot filler valve with 1/4" female NPT thread are ideally suited for use on live air lines supplying compressed air.

PART No. Description

- BC-B-DF Dual Foot (6" Overall Length)

BRASS TANK VALVE

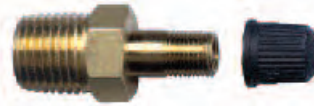

AIR TANK VALVE

Fairview's industrial grade brass air tank valve with Male NPT thread for use on compressed air systems.

PART No.

- BTV-A
- BTV-B

Pipe

- 1/8"
- 1/4"

Description

- Complete with Cap
- Complete with Cap

AIR TANK DRAIN VALVE



AIR TANK DRAIN VALVE WITH PULL CABLE

PART No.

- 14DV-60B

Pipe

- 1/4"

Description

- 60" Cable

PRESSURE PROTECTION VALVE

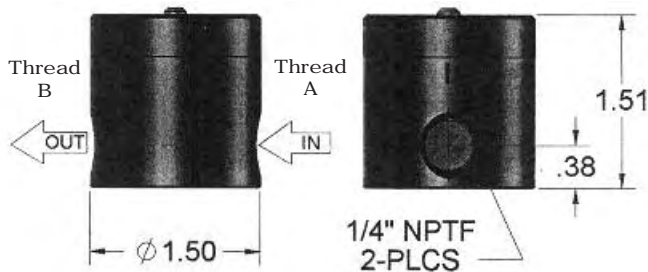

PPV Series

- **Material:** Black Anodized Aluminum
- **Diaphragm:** Low-Temp Buna
- **Temp Rating:** -40°F To +180°F (-40°C To 82°C)
- **Max Pressure:** 200 PSI max. supply
Pressure to open Adjustable 45-95 psi
Pressure to close Adjustable 40-90 psi
Downstream Check (Optional)
Stainless Steel Adjustment Screw

PART No.	Thread "A"	Thread "B"	Closing Pressure (P.S.I.)	Opening Pressure (P.S.I.)
PPV-90PC-60/65-6C	1/4 NPTF	1/4 NPTF	60	65

F

CHECK VALVES



This check valve design is safe, compact, suitable to any hydraulic application using non-corrosive liquids.

** Also available with SAE threads.

** Also available with 65 PSI crack pressure.

CARBON STEEL COUPLING STYLE CHECK VALVE

PART No.	Female Pipe	Working P.S.I.	CRACK P.S.I
SCV1003-A	1/8	5000	5 PSI
SCV1003-B	1/4	5000	5 PSI
SCV1003-C	3/8	5000	5 PSI
SCV1003-D	1/2	4000	5 PSI
SCV1003-E	3/4	4000	5 PSI
SCV1003-H	1	4000	5 PSI



3000 P.S.I. Positive check valve. Stainless steel poppet and spring, viton seal - Less than 1 P.S.I. cracking pressure.

BRASS HIGH PRESSURE COUPLING STYLE CHECK VALVE

PART No.	Female Pipe	W.O.G.
103CV-B-3000	1/4	3000
103CV-C-3000	3/8	3000

CHECK VALVES



COUPLING STYLE CHECK VALVE Female Pipe

200 P.S.I. non-shock cold water, oil, gas. Forged brass construction for greater strength. May be installed horizontally or vertically. Less than 1 P.S.I. cracking pressure.

PART No.	Pipe	W.O.G.
103CV-C	3/8	200
103CV-D	1/2	200
103CV-E	3/4	200
103CV-H	1	200
103CV-J	1-1/4	200
103CV-K	1-1/2	200



ONE-WAY CHECK

Precision engineered and manufactured to provide optimum performance for each specified application. Steel construction for years of dependable operation. Less than 1 P.S.I. cracking pressure.

PART No.	Pipe	MAX. PSI
CV1-B	1/4	135
CV1-C	3/8	135
CV1-D	1/2	135

SWING CHECK VALVES



FEMALE PIPE HEX HEAD

PART No.	Pipe	W.O.G.
293-C	3/8	200
293-D	1/2	200
293-E	3/4	200
293-H	1	200
293-J	1-1/4	200
293-K	1-1/2	200

ALLOWS FLOW IN ONE DIRECTION ONLY



"Y" VALVE FEMALE PIPE HEX HEAD 125 P.S.I. STEAM

PART No.	Pipe	W.O.G.
298-C	3/8	200
298-D	1/2	200
298-E	3/4	200
298-H	1	200
298-J	1-1/4	200
298-K	1-1/2	200
298-M	2	200

ALLOWS FLOW IN ONE DIRECTION ONLY

F

GH SERIES

Standard Style



PART No.	Pipe Size	Type	Color Code
GHU	1/2 FPT	Universal	Plain
GHE	1/2 FPT	Emergency	Red
GHS	1/2 FPT	Service	Blue

GH Series With Screen Seal

PART No.	Pipe Size	Type	Color Code
GHE-SC	1/2 FPT	Emergency	Red
GHS-SC	1/2 FPT	Service	Blue

GH Series With Umbrella Seal

PART No.	Pipe Size	Type	Color Code
GHU-2	1/2 FPT	Universal	Plain
GHE-2	1/2 FPT	Emergency	Red
GHS-2	1/2 FPT	Service	Blue

GHM SERIES

Mounting (Plug Included)



PART No.	Pipe Size	Type	Color Code
GHM-E	3/8 FPT	Emergency	Red
GHM-S	3/8 FPT	Service	Blue

GHM Series With Screen Seal

PART No.	Pipe Size	Type	Color Code
GHM-E-SC	3/8 FPT	Emergency	Red
GHM-S-SC	3/8 FPT	Service	Blue

GHV SERIES



PART No.	Bottom Pipe Size	Back Pipe Size	Type	Color Code
GHV-E	3/8 FPT	1/4 FPT	Emergency	Red
GHV-S	3/8 FPT	----	Service	Blue

GHV Series With Bulkhead

	Bulkhead Pipe Size	Back Pipe Size	Type	Color Code
GHV-E-BH	3/8 F - 3/4 M	1/4 MPT	Emergency	Red
GHV-S-BH	3/8 F - 3/4 M	1/4 MPT	Service	Blue

SWING AWAY GLADHAND

Rotates Full 180 Degrees

(Coupled With Pacifier)



PART No.	Pipe Size	Type	Color Code
GHU-SW	3/8 FPT	Swing Away	Plain
GHE-SW	3/8 FPT	Swing Away	Red
GHS-SW	3/8 FPT	Swing Away	Blue

GLADHAND DUMMY



PART No.	Description	Color Code
GH-DUMMY	C/W 26" SECURITY CABLE	Plain

REPLACEMENT SEALS



GH-SEAL STANDARD



WITH SCREEN



GH-SEAL-2 UMBRELLA

PART No.	Type	Color Code
GH-SEAL	Rubber	Black
GH-SEAL-2	Rubber Umbrella Seal	Black
GHE-SEAL	Polyurethane	Red
GHE-SEAL-SC	Polyurethane with Screen	Red
GHS-SEAL	Polyurethane	Blue
GHS-SEAL-SC	Polyurethane with Screen	Blue

GLADHAND GRIPS

PART No.
GH-GRIP



Description
Gladhand Grip Handles

Sold Only in sets.
(Red and Blue)

QUICK DISCONNECTS



AGRICULTURAL INTERCHANGE	178
ARO 210 / 310 INTERCHANGES	187
AUTOMOTIVE STANDARD INTERCHANGE (TRU-FLATE)	187
CEJN INTERCHANGE	190
CROSSOVER LISTING -HYDRAULIC	176
CROSSOVER LISTING -PNEUMATIC	184
HIGH PRESSURE FLUSH FACE	180
HTMA FLUSH FACE ISO 16028	180
INDUSTRIAL INTERCHANGES	185 - 186
ISO "A" INTERCHANGE	179
ISO "B" INTERCHANGE	177
LINCOLN INTERCHANGE	188
MINIATURE PNEUMATIC	188
PRESSURE WASH COUPLINGS	191
PROPANE / NATURAL GAS COUPLINGS	192
SNAPTITE VALVED & NON-VALVED SERIES	181
SNOW PLOW	178
SWING COUPLINGS	189 - 190
THREAD-TO-CONNECT HIGH PRESS. (PARKER 3000) INTERCHANGE ..	179
THREAD-TO-CONNECT (UNDER PRESSURE)	183
UNIVERSAL PNEUMATIC INTERCHANGE	188
WATER COUPLINGS	191
WING SERIES (HEAVY DUTY) INTERCHANGE	182



HYDRAULIC QUICK DISCONNECT CROSSOVER LISTING

BODY	FAIRVIEW PART No.	AEROQUIP	FOSTER	PARKER	SAFEGWAY	FASTER	PIONEER
1/2	QD-AGC8-8F				S45-4		
1/2	QD-AGN8-8F				S71-4		
1/4	QD-AGC4-4F	FD42-1001-4-4		4050-2P	S25A-2P		4050-2P
3/8	QD-AGC6-6F			4250-3P	S45-3P		4250-3P
3/4	QD-AGC12-12F			4150-5	S25F-6	NSP-34-NPT-F	4150-5
1	QD-AGC16-16F			4050-6P	S25-8P	NV-1-NPT-F	4050-6P
1/4	QD-AGN4-4F	FD42-1002-4-4		4010-2P	S41-2P		4010-2P
3/8	QD-AGN6-6F			4010-3	S41-3P		4010-3
1/2	QD-AGN8-8F			8010-4	S71-4	2NS-12-NPT-M	8010-4
3/4	QD-AGN12-12F			4110-5	S21F-6	NSP-34-NPT-M	4110-5
1	QD-AGN16-16F			4010-6P	S21-8P	NV-1-NPT-M	4010-6P
1/4	QD-ISOAC4-4F	5601-4-4S		6601-4-4	S565-2	ANV 14 NPT F	
3/8	QD-ISOAC6-6F	5601-6-6S		6601-6-6	S565-3	ANV 38 NPT F	4050-3
1/2	QD-ISOAC8-8F	5601-8-10S		6601-8-10	S565-4	ANV 12 NPT F	4050-4
3/4	QD-ISOAC12-12F	5601-12-12S		6601-12-12	S565-6	ANV 34 NPT F	
1	QD-ISOAC16-16F	5601-16-16S		6601-16-16	S565-8	ANV 1 NPT F	
1/4	QD-ISOAN4-4F	5602-4-4S		6602-4-4	S561-2	ANV 14 NPT M	
3/8	QD-ISOAN6-6F	5602-6-6S		6602-6-6	S561-3	ANV 38 NPT M	
1/2	QD-ISOAN8-8F	5602-8-10S		6602-8-10	S561-4	ANV 12 NPT M	8010-4
3/4	QD-ISOAN12-12F	5602-12-12S		6602-12-12	S561-6	ANV 34 NPT M	
1	QD-ISOAN16-16F	5602-16-16S		6602-16-16	S561-8	ANV 1 NPT M	
1/4	QD-ISOBC4-4F	FD45-1003-4-4	H2S	H2-62	S105-2	HNV-14-NPT-F	
3/8	QD-ISOBC6-6F	FD45-1003-6-6	H3S	H3-62	S105-3	HNV-38-NPT-F	
1/2	QD-ISOBC8-8F	FD45-1003-8-10	H4S	H4-62	S105-4	HNV-12-NPT-F	
3/4	QD-ISOBC12-12F	FD45-1003-12-12	H6S	H6-62	S105-6	HNV-34-NPT-F	
1	QD-ISOBC16-16F	FD45-1003-16-16	H8S	H8-62	S105-8	HNV-1-NPT-F	
1/4	QD-ISOBN4-4F	FD45-1002-4-4	K2S	H2-63 & HDH2-63	S101-2	HNV-14-NPT-M	
3/8	QD-ISOBN6-6F	FD45-1002-6-6	K3S	H3-63 & HDH3-63	S101-3	HNV-38-NPT-M	
1/2	QD-ISOBN8-8F	FD45-1002-8-10	K4S	H4-63 & HDH4-63	S101-4	HNV-12-NPT-M	
3/4	QD-ISOBN12-12F	FD45-1002-12-12	K6S	H6-63 & HDH6-63	S101-6	HNV-34-NPT-M	
1	QD-ISOBN16-16F	FD45-1002-16-16	K8S	H8-63 & HDH8-63	S101-8	HNV-1-NPT-M	
1/4	QD-TCC4-4M			3050-2	S35-2P	PVVM1/14-NPT-M	3050-2
3/8	QD-TCC6-6M			3050-3	S35-3P	PVVM1/38-NPT-M	3050-3
1/4	QD-TCN4-4F			3010-2	S31-2P	PVVM-14-NPT-F	3010-2
3/8	QD-TCN6-6F			3010-3	S31-3P	PVVM-38-NPT-F	3010-3
1/4	QD-BISOBC4-4F	FD45-1101-4-4	H2B	BH2-60	BS105-2	HNV-14-NPT-F5	
3/8	QD-BISOBC6-6F	FD45-1101-6-6	H3B	BH3-60	BS105-3	HNV-38-NPT-F5	
1/2	QD-BISOBC8-8F	FD45-1101-8-10	H4B	BH4-60	BS105-4	HNV-12-NPT-F5	
3/4	QD-BISOBC12-12F	FD45-1101-12-12	H6B	BH6-60	BS105-6	HNV-34-NPT-F5	
1	QD-BISOBC16-16F	FD45-1101-16-16	H8B	BH8-60	BS105-8	HNV-1-NPT-F5	
1/4	QD-BISOBN4-4F	FD45-1086-4-4	K2B	BH2-61	BS101-2	HNV-14-NPT-M5	
3/8	QD-BISOBN6-6F	FD45-1086-6-6	K3B	BH3-61	BS101-3	HNV-38-NPT-M5	
1/2	QD-BISOBN8-8F	FD45-1086-8-10	K4B	BH4-61	BS101-4	HNV-12-NPT-M5	
3/4	QD-BISOBN12-12F	FD45-1086-12-12	K6B	BH6-61	BS101-6	HNV-34-NPT-M5	
1	QD-BISOBN16-16F	FD45-1086-16-16	K8B	BH8-61	BS101-8	HNV-1-NPT-M5	
3/4	QD-BTTWC12-12F	5100-S5-12B		6125-12			
1	QD-BTTWC16-16F	5100-S5-16B		6125-16		FB16/1 NPT F5	
1-1/4	QD-BTTWC20-20F	5100-S5-20B		6125-20			
1-1/2	QD-BTTWC24-24F	5100-S5-24B		6125-24			
3/4	QD-BTTWN12-12F	5100-S2-12B		6105-12			
1	QD-BTTWN16-16F	5100-S2-16B		6105-16		FB16/1 NPT M5	
1-1/4	QD-BTTWN20-20F	5100-S2-20B		6105-20			
1-1/2	QD-BTTWN24-24F	5100-S2-24B		6105-24			
1/4	QD-HTMAC4-4F	FD89-1001-04-04			FFE495-2	2FFI14 NPT F	
3/8	QD-HTMAC6-6F	FD89-1001-06-06		FF-371-6FP	FFE495-3	2FFI38 NPT F	
3/8	QD-HTMAC6-8F	FD89-1001-08-06		FF-371-8FP	FFE495-3-8	2FFI38-1/2 NPT F	
1/2	QD-HTMAC8-8F	FD89-1001-08-08			FFE495-8	2FFI12 NPT F	
1/2	QD-HTMAC8-12F	FD89-1001-12-08			FFE495-8-3/4	2FFI12-34 NPT F	
3/4	QD-HTMAC12-12F	FD89-1001-12-12			FFE495-6	2FFI34 NPT F	
1	QD-HTMAC16-16F	FD89-1001-16-16			FFE495-8	2FFI1 NPT F	
1/4	QD-HTMAN4-4F	FD89-1002-04-04			FFE491-2	2FFI14 NPT M	
3/8	QD-HTMAN6-6F	FD89-1002-06-06		FF-372-6FP	FFE491-3	2FFI38 NPT M	
3/8	QD-HTMAN6-8F	FD89-1002-08-06		FF-372-8FP	FFE491-3-8	2FFI38-1/2 NPT M	
1/2	QD-HTMAN8-8F	FD89-1002-08-08			FFE491-8	2FFI12 NPT M	
1/2	QD-HTMAN8-12F	FD89-1002-12-08			FFE491-8-3/4	2FFI12-34 NPT M	
3/4	QD-HTMAN12-12F	FD89-1002-12-12			FFE491-6	2FFI34 NPT M	
1	QD-HTMAN16-16F	FD89-1002-16-16			FFE491-8	2FFI1 NPT M	

G

SERIES B ISO 7241-1 INDUSTRIAL INTERCHANGE



STEEL



BRASS

- High flow characteristics and pressure ratings superior to Parker 60 series.
- Industry interchangeability with other manufacturer's ISO "B" couplers and nipples.
- Poppet style double shut-off.
- Proven ball lock mechanism.
- 4 To 1 safety factor (Min. Burst = W.P. X 4)
- Ideal for use with hydraulic and other fluids in both stationary and mobile industrial applications.

COUPLER SET MAXIMUM WORKING PRESSURE (PSI)					
	1/4	3/8	1/2	3/4	1
STEEL	5000	4350	4000	2600	2175
BRASS	3500	3500	3500	2500	1500
STAINLESS	5500	3750	3750	3000	3000

VALVED COUPLER - STEEL

PART No.	Body Size	Female Pipe
QD-ISOBC4-4F	1/4	1/4
QD-ISOBC6-6F	3/8	3/8
QD-ISOBC8-8F	1/2	1/2
QD-ISOBC12-12F	3/4	3/4
QD-ISOBC16-16F	1	1

VALVED COUPLER - BRASS

PART No.	Body Size	Female Pipe
QD-BISOBC4-4F	1/4	1/4
QD-BISOBC6-6F	3/8	3/8
QD-BISOBC8-8F	1/2	1/2
QD-BISOBC12-12F	3/4	3/4
QD-BISOBC16-16F	1	1

VALVED COUPLER - STAINLESS (303)

PART No.	Body Size	Female Pipe
QD-SISOBC4-4F	1/4	1/4
QD-SISOBC6-6F	3/8	3/8
QD-SISOBC8-8F	1/2	1/2

VALVED NIPPLE - STEEL

PART No.	Body Size	Female Pipe
QD-ISOBN4-4F	1/4	1/4
QD-ISOBN6-6F	3/8	3/8
QD-ISOBN8-8F	1/2	1/2
QD-ISOBN12-12F	3/4	3/4
QD-ISOBN16-16F	1	1

VALVED NIPPLE - BRASS

PART No.	Body Size	Female Pipe
QD-BISOBN4-4F	1/4	1/4
QD-BISOBN6-6F	3/8	3/8
QD-BISOBN8-8F	1/2	1/2
QD-BISOBN12-12F	3/4	3/4
QD-BISOBN16-16F	1	1

VALVED NIPPLE - STAINLESS (303)

PART No.	Body Size	Female Pipe
QD-SISOBN4-4F	1/4	1/4
QD-SISOBN6-6F	3/8	3/8
QD-SISOBN8-8F	1/2	1/2



DUST PLUG

ACCESSORIES	Size	Dust Plug	Dust Cap
	1/4	QD-PDP-9	QD-PDC-11
	3/8	QD-PDP-12	QD-PDC-14
	1/2	QD-PDP-16	QD-PDC-17
	3/4	QD-PDP-20	QD-PDC-21
	1	QD-PDP-24	QD-PDC-26



DUST CAP

G

AGRICULTURAL (PIONEER 4000) INTERCHANGE

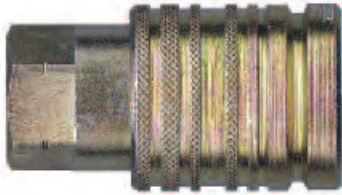

- Interchangeable with Pioneer 4000 series, Safeway S20 and S40 series
- High Strength Steel Construction
- Superior "Poppet" style valves
- Nitrile NBR seals with PTFE back-up ring
- Typical applications include agricultural equipment, gravel trucks and dump trucks.

COUPLER SET					
MAXIMUM WORKING PRESSURE (PSI)					
	1/4	3/8	1/2	3/4	1
STEEL	5000	4350	3600	3600	3300

VALVED COUPLER - STEEL

PART No.	Body Size	Female Pipe	Sleeve Style
QD-AGC4-4F	1/4 Coupler	1/4	One Way
QD-AGC6-6F	3/8 Coupler	3/8	One Way
QD-AGC8-8F	1/2 Coupler	1/2	Two Way
QD-AGC12-12F	3/4 Coupler	3/4	One Way
QD-AGC16-16F	1 Coupler	1	One Way

VALVED NIPPLE - STEEL

PART No.	Body Size	Female Pipe
QD-AGN4-4F	1/4 Nipple	1/4
QD-AGN6-6F	3/8 Nipple	3/8
QD-AGN8-8F	1/2 Nipple	1/2
QD-AGN12-12F	3/4 Nipple	3/4
QD-AGN16-16F	1 Nipple	1



ACCESSORIES	Size	Dust Plug	Dust Cap
	1/4	QD-PDP-10	QD-PDC-11
3/8	QD-PDP-13	QD-PDC-14	
1/2	QD-PDP-14	QD-PDC-15	
3/4	QD-PDP-19	QD-PDC-20	
1	QD-PDP-23	QD-PDC-24	



SNOW PLOW QUICK DISCONNECT

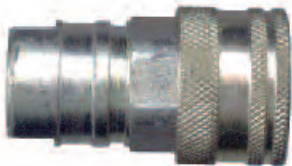

This high quality economical coupler is at the center of every snow plow replacement parts package.

- High strength steel construction.
- Coupler set maximum working pressure is 4000 P.S.I.

Also ask us about...

- 1/4" S.A.E. 100R7 Synflex® Hose Assemblies in various lengths and configurations.
- Steel Hydraulic Adapters and Brass Adapters to meet all your fitting needs.

PART No.	Description	Body Size	Female Pipe
QD-SP90	Snow Plow Set	1/4	1/4



SERIES A ISO 7241-1 INTERCHANGE



- Interchangeable with Parker 6600 series, Aeroquip 5600 Series, Safeway S56 Series and other manufacturer's couplers and nipples built in accordance to I.S.O. 7241-1 Series "A".
- 4 to 1 Safety factor (Min. Burst = W.P. X 4)
- High Strength Steel Construction.
- Proven ball lock mechanism.
- For use with hydraulic fluids in mobile and stationary applications.

COUPLER SET					
MAXIMUM WORKING PRESSURE (PSI)					
	1/4	3/8	1/2	3/4	1
STEEL	4600	4600	4000	4000	3000

VALVED COUPLER - STEEL

PART No.	Body Size	Female Pipe
QD-ISOAC4-4F	1/4	1/4
QD-ISOAC6-6F	3/8	3/8
QD-ISOAC8-8F	1/2	1/2
QD-ISOAC12-12F	3/4	3/4
QD-ISOAC16-16F	1	1

VALVED NIPPLE - STEEL

PART No.	Body Size	Female Pipe
QD-ISOAN4-4F	1/4	1/4
QD-ISOAN6-6F	3/8	3/8
QD-ISOAN8-8F	1/2	1/2
QD-ISOAN12-12F	3/4	3/4
QD-ISOAN16-16F	1	1



DUST PLUG

ACCESSORIES

Size	Dust Plug	Dust Cap
1/4	QD-PDP-7	QD-PDC-9
3/8	QD-PDP-11	QD-PDC-13
1/2	QD-PDP-14	QD-PDC-15
3/4	QD-PDP-19	QD-PDC-20
1	QD-PDP-23	QD-PDC-24



DUST CAP

HIGH PRESSURE / THREAD TO CONNECT (PARKER 3000) INTERCHANGE



- Interconnect with Parker 3000 series, Faster PVV series and other screw to connect couplings used in the hydraulic tool and rescue equipment markets.
- Zero leakage and higher flow rates than commonly used metal to metal sealing.
- High strength steel construction with heavy duty clear zinc plating for excellent corrosion resistance

VALVED COUPLER - STEEL

PART No.	Body Size	Pipe	Working Pressure (PSI)
QD-TCC4-4M	1/4 Coupler	1/4 MPT	10,000
QD-TCC6-6F	3/8 Coupler	3/8 FPT	10,000
QD-TCC6-6M	3/8 Coupler	3/8 MPT	10,000

VALVED NIPPLE - STEEL

PART No.	Body Size	Pipe	Working Pressure (PSI)
QD-TCN4-4F	1/4 Nipple	1/4 FPT	10,000
QD-TCN6-6F	3/8 Nipple	3/8 FPT	10,000

ACCESSORIES

Size	Dust Plug	Dust Cap
3/8	QD-TCMDP-6	QD-TCMDC-6

G

ISO 16028 HTMA FLUSH FACE



- Interchange with Aeroquip FD89/FD49 and Parker FE, FF size 3/8.
- Up to 4,000 PSI operation pressures.
- Superior flow and low pressure drop.
- Sleeve lock feature.
- Exceeds ANSI/NFPA T3.20.15-1991

COUPLER SET					
MAXIMUM IMPULSE WORKING PRESSURE (PSI) *					
	1/4	3/8	1/2	3/4	1
STEEL	4285	4285	3571	3571	3571

* Note: For Maximum Static W.P. Multiply By 1.67

VALVED COUPLER - STEEL

PART No.	Body Size	Female Pipe
QD-HTMAC4-4F	1/4	1/4
QD-HTMAC6-6F	3/8	3/8
QD-HTMAC6-8F	3/8	1/2
QD-HTMAC8-8F	1/2	1/2
QD-HTMAC8-12F	1/2	3/4
QD-HTMAC10-12F	5/8	3/4
QD-HTMAC12-12F	3/4	3/4
QD-HTMAC12-16F	3/4	1
QD-HTMAC16-16F	1	1

Note: Available with Female S.A.E. thread suffix with -EF

VALVED NIPPLE - STEEL

PART No.	Body Size	Female Pipe
QD-HTMAN4-4F	1/4	1/4
QD-HTMAN6-6F	3/8	3/8
QD-HTMAN6-8F	3/8	1/2
QD-HTMAN8-8F	1/2	1/2
QD-HTMAN8-12F	1/2	3/4
QD-HTMAN10-12F	5/8	3/4
QD-HTMAN12-12F	3/4	3/4
QD-HTMAN12-16F	3/4	1
QD-HTMAN16-16F	1	1

Note: Available with Female S.A.E. thread suffix with -EF

HIGH PRESSURE FLUSH FACE



- Air inclusion and fluid loss minimized to prevent spillage and contamination of systems.
- Push-To-Connect one hand operation.
- Up to 10,000 PSI operation pressures.
- Superior flow and low pressure drop.
- Sleeve lock to provide protection against accidental disconnection.
- (316) Stainless available upon request.

COUPLER SET					
MAXIMUM STATIC WORKING PRESSURE (PSI)					
	3/8	1/2	3/4	1	2
STEEL	10000	10000	7500	7500	5000

Note: Pressure ratings established under static pressure conditions. Multiply by 0.6 for high impulse applications.

VALVED COUPLER - STEEL

PART No.	Body Size	Female Pipe
QD-71-3C8-8F	1/2	1/2
QD-71-3C12-12F	3/4	3/4
QD-71-3C16-16F	1	1
QD-71-3C16-20F	1	1-1/4

VALVED NIPPLE - STEEL

PART No.	Body Size	Female Pipe
QD-71-3N8-8F	1/2	1/2
QD-71-3N12-12F	3/4	3/4
QD-71-3N16-16F	1	1
QD-71-3N16-20F	1	1-1/4



SNAPTITE "VH" (VALVED) AND "PH" (NON-VALVED) SERIES



- Fully engineered design meets or exceeds MIL-C-51234
- "Jet Stream" valve design for superior, smoother flow.
- Much more compact than standard hydraulic coupler sets.
- Wide variety of sizes and configurations.
- "VH" valved and "PH" non-valved are completely interchangeable for double, single or no shut-off.
- For non-valved couplers replace "V" in part number with "P"
Example: QD-PHN6-6F
- For Brass prefix "V" in part number with "B" Example: BVHN6-6F
- For Stainless prefix "V" in part number with "S" Example: SVHN6-6F
- Proven by years of use in hydraulic-pneumatic applications handling a variety of gases and fluids.

WORKING PRESSURES (PSI)						
Valve and Valve (Double Shut-Off) Valve and Plain (Single Shut-Off)				Plain and Plain (No Shut-Off)		
Q.D. Size	Steel	Brass	Stainless Steel	Steel	Brass	Stainless Steel
1/4	6500	2250	5000	11000	4000	10000
3/8	4500	2250	4000	11000	4000	8000
1/2	4000	2000	3750	11000	4000	8000
3/4	3500	2000	2000	9000	3500	7000
1	2000	1750	2000	6000	3000	4000
1-1/4	1750	350	1500	5000	1000	3000
1-1/2	1500	350	1500	5000	1000	3000
2	1500	400	500	4000	750	1000
2-1/2	1000	400	400	1000	400	400
3	750	200	400	750	200	400

VALVED COUPLER - STEEL

PART No.	Body Size	Female Pipe
QD-VHC4-4F	1/4	1/4
QD-VHC6-6F	3/8	3/8
QD-VHC8-8F	1/2	1/2
QD-VHC12-12F	3/4	3/4
QD-VHC16-16F	1	1
QD-VHC20-20F	1-1/4	1-1/4

PLAIN COUPLER - STEEL

PART No.	Body Size	Female Pipe
QD-PHC4-4F	1/4	1/4
QD-PHC6-6F	3/8	3/8
QD-PHC8-8F	1/2	1/2
QD-PHC12-12F	3/4	3/4
QD-PHC16-16F	1	1
QD-PHC24-24F	1-1/2	1-1/2

VALVED NIPPLE - STEEL

PART No.	Body Size	Female Pipe
QD-VHN4-4F	1/4	1/4
QD-VHN6-6F	3/8	3/8
QD-VHN8-8F	1/2	1/2
QD-VHN12-12F	3/4	3/4
QD-VHN16-16F	1	1
QD-VHN20-20F	1-1/4	1-1/4

PLAIN NIPPLE - STEEL

PART No.	Body Size	Female Pipe
QD-PHN4-4F	1/4	1/4
QD-PHN6-6F	3/8	3/8
QD-PHN8-8F	1/2	3/8
QD-PHN12-12F	3/4	3/4
QD-PHN16-16F	1	1
QD-PHN24-24F	1-1/2	1-1/2

"VH" AND "PH" DUST CAPS AND PLUGS

Size	Plastic Dust Cap	Plastic Dust Plug
1/4	QD-PDC-4	QD-PDP-4
3/8	QD-PDC-6	QD-PDP-6
1/2	QD-PDC-13	QD-PDP-11
3/4	QD-PDC-15	QD-PDP-14
1	QD-PDC-16	QD-PDP-16

G

HEAVY DUTY WING SERIES INTERCHANGE



Styles May Vary
Depending on Size.

- Interchangeable with Aeroquip 5100 series and Parker 6100 series.
- Heavy duty wing nut or hex nut for easy connection.
- Thread-To-Connect.
- Dry-Break feature minimizes air inclusion and contamination of systems.
- Up to 3,000 PSI connected and disconnected.
- Ideal for use on hydraulic dump trucks, coal trucks, sand and salt spreaders and oil well equipment.

Operating Pressure		Air Inclusion	Spillage
Size	(PSI)	CC. Max.	CC. Max.
3/4	3000	.34	.26
1	3000	.50	.35
1-1/4	2750	.68	.70
1-1/2	2750	.60	.94

VALVED COUPLER - BRASS

PART No.	Body Size	Female Pipe
QD-BTTWC12-12F	3/4	3/4
QD-BTTWC16-16F	1	1
QD-BTTWC20-20F	1-1/4	1-1/4
QD-BTTWC24-24F	1-1/2	1-1/2

VALVED NIPPLE - BRASS

PART No.	Body Size	Female Pipe
QD-BTTWN12-12F	3/4	3/4
QD-BTTWN16-16F	1	1
QD-BTTWN20-20F	1-1/4	1-1/4
QD-BTTWN24-24F	1-1/2	1-1/2

HEAVY DUTY WING INTERCHANGE ACCESSORIES



**BRASS
DUST
CAP**

PART No.	Size
QD-BTTWDC-12	3/4
QD-BTTWDC-16	1
QD-BTTWDC-20	1-1/4
QD-BTTWDC-24	1-1/2



**BRASS
DUST
PLUG**

PART No.	Size
QD-BTTWDP-12	3/4
QD-BTTWDP-16	1
QD-BTTWDP-20	1-1/4
QD-BTTWDP-24	1-1/2



THREAD-TO-CONNECT (CONNECT UNDER PRESSURE)



- Connect under pressure - designed for up to 5,000 PSI operating pressures.
- Thread-To-Connect valves shut off automatically during connection under normal circumstances.
- Superior flow and low pressure drop.
- Large capacity.

COUPLER SET							
MAXIMUM WORKING PRESSURE (PSI)							
	3/4	1	1-1/4	1-1/2	2	2-1/2	4
STEEL	5000	5000	5000	5000	5000	3000	400

VALVED COUPLER - STEEL

PART No.	Body Size	Female Pipe
QD-75C12-12F	3/4	3/4
QD-75C16-16F	1	1
QD-75C20-20F	1-1/4	1-1/4
QD-75C24-24F	1-1/2	1-1/2

VALVED NIPPLE - STEEL

PART No.	Body Size	Female Pipe
QD-75N12-12F	3/4	3/4
QD-75N16-16F	1	1
QD-75N20-20F	1-1/4	1-1/4
QD-75N24-24F	1-1/2	1-1/2

THREAD-TO-CONNECT ACCESSORIES

DUST PLUGS AND CAPS		
Size	Dust Plug	Dust Cap
3/4	QD-75MDP-12	QD-75MDC-12
1	QD-75MDP-16	QD-75MDC-16
1-1/4	--	QD-75MDC-20

SPARE PARTS KITS		
Size	Coupler Kit	Nipple Kit
3/4	--	--
1	QD-75C16-SPK	QD-75N16-SPK
1-1/4	QD-75C20-SPK	QD-75N20-SPK

Other items may be available as special order.



PNEUMATIC QUICK DISCONNECT CROSSOVER

INDUSTRIAL INTERCHANGE

SIZE	THREAD	FAIRVIEW PART No.	AMFLO	PARKER	DIXON	FOSTER	TOP-RING	MILTON	SCHRADER BRIDGEPORT	TRUFLATE
1/4	1/4 FPT	QD-INDMC4-4F	C20	B23	DC20	3003	20.842	715	5142-12	13-234
1/4	3/8 FPT	QD-INDMC4-6F	C20-23	B23E	DC2023	3203	20.862	718	5263-12	13-254
3/8	1/4 FPT	QD-INDMC6-4F	C26-22	25C	DC2622	4004	21.842	1833		
3/8	3/8 FPT	QD-INDMC6-6F	C26	25	DC26	4204	21.862	1835	3541	13-536
3/8	1/2 FPT	QD-INDMC6-8F	C26-24	25F	DC2624	4404	21.882			13-556
1/2	1/2 FPT	QD-INDMC8-8F	C10	17	DC10	5205	22.882	1815		
1/4	1/4 MPT	QD-INDMC4-4M	C21	B22	DC21	3103	20.942	716	5141-12	13-224
1/4	3/8 MPT	QD-INDMC4-6M	C21-03	B22E	DC-2103	3303	20.962	719	5140-12	13-244
3/8	1/4 MPT	QD-INDMC6-4M	C25-02	24C	DC2502	4104	21.942			
3/8	3/8 MPT	QD-INDMC6-6M	C25	24	DC25	4304	21.962	1836		13-526
3/8	1/2 MPT	QD-INDMC6-8M	C25-04	24F	DC2504	4504	21.982			13-546
1/2	1/2 MPT	QD-INDMC8-8M	C9	16	DC9	5305	22.982	1816		
1/4	1/4 Hbarb	QD-INDMC4-4H	C20-42	B20-3B	DC2042	3603	20.542	717	171	
1/4	3/8 Hbarb	QD-INDMC4-6H	C20-44	B20-5B	DC2044	3703	20.562	717-6		
3/8	3/8 Hbarb	QD-INDMC6-6H	C26-44	24-5B	DC2644	4804	21.562	1836-6		
3/8	1/2 Hbarb	QD-INDMC6-8H	C26-45	24-6B	DC2645	4904	21.582			
1/4	1/4 FPT	QD-INDN4-4F	CP20	H3C	DCP20	11-3	20.142	728	5139-11	12-234
1/4	3/8 FPT	QD-INDN4-6F	CP20-23	H3C-E	DCP2023	15-3	20.162	732	5263-11	12-236
3/8	1/4 FPT	QD-INDN6-4F	CP26-22	H1E	DCP2622	41-4	21.142	1840		
3/8	3/8 FPT	QD-INDN6-6F	CP26	H3E	DCP26	43-4	21.162	1838	3543	12-536
3/8	1/2 FPT	QD-INDN6-8F	CP26-24	H3E-F	DCP2624	45-4	21.182			
1/2	1/2 FPT	QD-INDN8-8F	CP18	H3F	DCP18	55-5	22.182	1858		12-762
1/4	1/4 MPT	QD-INDN4-4M	CP21	H2C	DCP21	10-3	20.242	727	5138-11	12-224
1/4	3/8 MPT	QD-INDN4-6M	CP21-03	H2C-E	DCP2103	14-3	20.262	733	5263-11	12-226
3/8	1/4 MPT	QD-INDN6-4M	CP25-02	H0E	DCP2502	40-4	21.242	1839		
3/8	3/8 MPT	QD-INDN6-6M	CP25	H2E	DCP25	42-4	21.262	1837	3542	12-526
3/8	1/2 MPT	QD-INDN6-8M	CP25-04	H2E-F	DCP2504	44-4	21.282			
1/2	1/2 MPT	QD-INDN8-8M	CP17	H2F	DCP9	54-5	22.282	1857		12-752
1/4	1/4 Hbarb	QD-INDN4-4H	CP21-42	H8C	DCP2142	16-3	20.342	736	5223-11	
1/4	3/8 Hbarb	QD-INDN4-6H	CP21-44	H9C	DCP2144	17-3	20.362	736-6		
3/8	3/8 Hbarb	QD-INDN6-6H	CP25-44	H5E	DCP2544	48-4	21.362	1837-6		
3/8	1/2 Hbarb	QD-INDN6-8H	CP25-45	H6E	DCP2545	49-4	21.382			

ARO 210 INTERCHANGE

SIZE	THREAD	FAIRVIEW PART No.	AMFLO	PARKER	DIXON	FOSTER	TOP-RING	MILTON	SCHRADER BRIDGEPORT	TRUFLATE
1/4	1/4 FPT	QD-AROAC4-4F	C38	B53	DC38	210-3003	23.442	775	3526	13-334
1/4	3/8 FPT	QD-AROAC4-6F	C38-23	B53E	DC3823	210-3203	23.462			
1/4	1/4 MPT	QD-AROAC4-4M	C37	B52	DC37	210-3103	23.642	776-4	3525	13-324
1/4	3/8 MPT	QD-AROAC4-6M	C37-03	B52E	DC3703	210-3303	23.662	776-6		
1/4	1/4 Hbarb	QD-AROAC4-4H	C38-42	B50-3B	DC3842	210-3603	23.742			
1/4	1/4 FPT	QD-ARON4-4F	CP38	A3C	DCP38	210-11	23.142	778	3530	12-334
1/4	1/4 MPT	QD-ARON4-4M	CP37	A2C	DCP37	210-10	23.242	777	3529	12-324
1/4	1/4 Hbarb	QD-ARON4-4H	C37-42	A8C	DCP3742	210-16	23.342	777-4		

TRU-FLATE (AUTOMOTIVE) INTERCHANGE

SIZE	THREAD	FAIRVIEW PART No.	AMFLO	PARKER	DIXON	FOSTER	TOP-RING	MILTON	SCHRADER BRIDGEPORT	TRUFLATE
1/4	1/4 FPT	QD-TFMC4-4F	C2	B13	DC2	TF3003	24.842	785	3504	13-134
3/8	3/8 FPT	QD-TFMC6-6F	C6	B15	DC6	TF4204	25.862	1805	3516	13-612
1/4	1/4 MPT	QD-TFMC4-4M	C1	B12	DC1	TF3103	24.942	786	3503	13-124
3/8	1/4 MPT	QD-TFMC6-4M	C7	14C	DC7	TF4104	25.842			13-602
3/8	3/8 MPT	QD-TFMC6-6M	C5	14	DC5	TF4304	25.962	1806	3515	13-604
1/4	1/4 FPT	QD-TFN4-4F	CP2	3C	DCP2	TF11	24.142	784	3507	12-134
3/8	3/8 FPT	QD-TFN6-6F	CP6	3E	DCP6	TF43	25.162	1808	3518	12-612
1/4	1/4 MPT	QD-TFN4-4M	CP1	2C	DCP1	TF10	24.242	783	3506	12-124
3/8	1/4 MPT	QD-TFN6-4M	CP7	0E	DCP7	TF40	25.242	1809	3519	12-602
3/8	3/8 MPT	QD-TFN6-6M	CP5	2E	DCP5	TF42	25.262	1807	3517	12-604

LINCOLN INTERCHANGE

SIZE	THREAD	FAIRVIEW PART No.	AMFLO	PARKER	DIXON	FOSTER	TOP-RING	MILTON	SCHRADER BRIDGEPORT	TRUFLATE
1/4	1/4 FPT	QD-LINMC4-4F	C28	B73	DC28	LN3003		790	3528	13-434
1/4	1/4 MPT	QD-LINMC4-4M	C27	B72	DC27	LN3103				
1/4	1/4 FPT	QD-LINN4-4F	CP28	L3C	DCP28	LN10		792	3532	12-434
1/4	1/4 MPT	QD-LINN4-4M	CP27	L2C	DCP27	LN11		791	3531	12-424

INDUSTRIAL INTERCHANGE - MANUAL

1/4" Size



3/8" Size



Industrial Interchange -- Standard nose length. NOTE: NOT ACTUAL SIZE

The industrial interchange design is considered the industry standard. The nipple can be easily identified by its' short pilot and flat bottomed ball groove.

See **Pneumatic Quick Disconnect Crossover - Page 184**

Operating pressure: 300 P.S.I. (21 BAR)

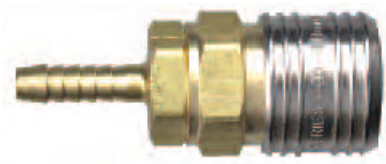
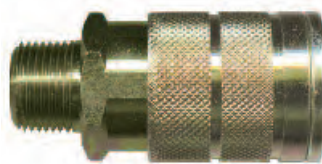
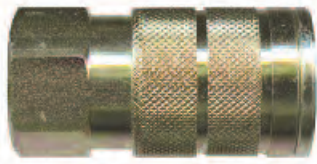

Styles May Vary
Depending on Size.



COUPLERS		
PART No.	Body Size	Pipe
QD-INDMC4-4F	1/4	1/4 FPT
QD-INDMC4-6F	1/4	3/8 FPT
QD-INDMC6-4F	3/8	1/4 FPT
QD-INDMC6-6F	3/8	3/8 FPT
QD-INDMC6-8F	3/8	1/2 FPT
QD-INDMC8-8F	1/2	1/2 FPT
QD-INDMC4-4M	1/4	1/4 MPT
QD-INDMC4-6M	1/4	3/8 MPT
QD-INDMC6-4M	3/8	1/4 MPT
QD-INDMC6-6M	3/8	3/8 MPT
QD-INDMC6-8M	3/8	1/2 MPT
QD-INDMC8-6M	1/2	3/8 MPT
QD-INDMC8-8M	1/2	1/2 MPT
PART No.	Body Size	Hose
QD-INDMC4-4H	1/4	1/4
QD-INDMC4-6H	1/4	3/8
QD-INDMC6-4H	3/8	1/4
QD-INDMC6-6H	3/8	3/8
QD-INDMC6-8H	3/8	1/2
QD-INDMC8-8H	1/2	1/2

NIPPLES		
PART No.	Body Size	Pipe
QD-INDN4-4F	1/4	1/4 FPT
QD-INDN4-6F	1/4	3/8 FPT
QD-INDN6-4F	3/8	1/4 FPT
QD-INDN6-6F	3/8	3/8 FPT
QD-INDN6-8F	3/8	1/2 FPT
QD-INDN8-8F	1/2	1/2 FPT
QD-INDN4-4M	1/4	1/4 MPT
QD-INDN4-6M	1/4	3/8 MPT
QD-INDN6-4M	3/8	1/4 MPT
QD-INDN6-6M	3/8	3/8 MPT
QD-INDN6-8M	3/8	1/2 MPT
QD-INDN8-6M	1/2	3/8 MPT
QD-INDN8-8M	1/2	1/2 MPT
PART No.	Body Size	Hose
QD-INDN4-4H	1/4	1/4
QD-INDN4-6H	1/4	3/8
QD-INDN6-4H	3/8	1/4
QD-INDN6-6H	3/8	3/8
QD-INDN6-8H	3/8	1/2
QD-INDN8-8H	1/2	1/2

INDUSTRIAL INTERCHANGE - AUTOMATIC

1/4" Size

3/8" Size



Industrial Interchange -- Standard nose length. NOTE: NOT ACTUAL SIZE

Interchangeable with QD-INDM series featured on previous page, Fairview's QD-INDA series industrial interchange features a push-to-connect style **Automatic Coupler** for easy one handed installations.

Operating pressure: 300 P.S.I. (21 BAR)

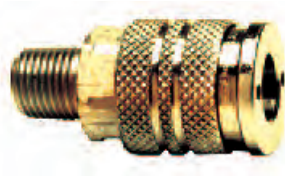

Styles May Vary Depending on Size.



G

COUPLERS

PART No.	Body Size	Pipe
QD-INDAC4-4F	1/4	1/4 FPT
QD-INDAC4-6F	1/4	3/8 FPT
QD-INDAC6-4F	3/8	1/4 FPT
QD-INDAC6-6F	3/8	3/8 FPT
QD-INDAC6-8F	3/8	1/2 FPT
QD-INDAC8-8F	1/2	1/2 FPT
QD-INDAC4-4M	1/4	1/4 MPT
QD-INDAC4-6M	1/4	3/8 MPT
QD-INDAC6-4M	3/8	1/4 MPT
QD-INDAC6-6M	3/8	3/8 MPT
QD-INDAC6-8M	3/8	1/2 MPT

PART No.	Body Size	Hose
QD-INDAC4-4H	1/4	1/4
QD-INDAC4-6H	1/4	3/8
QD-INDAC6-6H	3/8	3/8
QD-INDAC6-8H	3/8	1/2

NIPPLES

PART No.	Body Size	Pipe
QD-INDN4-4F	1/4	1/4 FPT
QD-INDN4-6F	1/4	3/8 FPT
QD-INDN6-4F	3/8	1/4 FPT
QD-INDN6-6F	3/8	3/8 FPT
QD-INDN6-8F	3/8	1/2 FPT
QD-INDN8-8F	1/2	1/2 FPT
QD-INDN4-4M	1/4	1/4 MPT
QD-INDN4-6M	1/4	3/8 MPT
QD-INDN6-4M	3/8	1/4 MPT
QD-INDN6-6M	3/8	3/8 MPT
QD-INDN6-8M	3/8	1/2 MPT
QD-INDN8-6M	1/2	3/8 MPT
QD-INDN8-8M	1/2	1/2 MPT

PART No.	Body Size	Hose
QD-INDN4-4H	1/4	1/4
QD-INDN4-6H	1/4	3/8
QD-INDN6-4H	3/8	1/4
QD-INDN6-6H	3/8	3/8
QD-INDN6-8H	3/8	1/2
QD-INDN8-8H	1/2	1/2

ARO210 / ARO310 INTERCHANGE SERIES - AUTOMATIC

1/4" Size



Slightly longer nose length.
NOTE: NOT ACTUAL SIZE

Fairview's QD-ARO series is a pin-type push-to-connect coupler designed for one way shut-off operation. It is interchangeable with ARO-210 / ARO-310 style couplers available from various manufacturers.

See Pneumatic Quick Disconnect Crossover - Page 184

Operating pressure: 250 P.S.I. (17 BAR)



COUPLERS

PART No.	Body Size	Pipe
QD-AROAC4-4F	1/4	1/4 FPT
QD-AROAC4-6F	1/4	3/8 FPT
QD-AROAC6-6F	3/8	3/8 FPT
QD-AROAC4-4M	1/4	1/4 MPT
QD-AROAC4-6M	1/4	3/8 MPT
QD-AROAC6-6M	3/8	3/8 MPT
QD-AROAC4-4H	1/4	1/4 HOSE
QD-AROAC4-6H	1/4	3/8 HOSE

NIPPLES

PART No.	Body Size	Pipe
QD-ARON4-4F	1/4	1/4 FPT
QD-ARON4-6F	1/4	3/8 FPT
QD-ARON6-6F	3/8	3/8 FPT
QD-ARON4-4M	1/4	1/4 MPT
QD-ARON4-6M	1/4	3/8 MPT
QD-ARON6-6M	3/8	3/8 MPT
QD-ARON4-4H	1/4	1/4 HOSE

TRU-FLATE INTERCHANGE (AUTOMOTIVE STANDARD)

1/4" Size

3/8" Size



Very short nose
NOTE: NOT ACTUAL SIZE

Fairview's automotive standard series interchanges with Tru-Flate design as well as automotive standards produced by most manufacturers. The nipple can be easily identified by its' extremely short pilot.

See Pneumatic Quick Disconnect Crossover - Page 184

Operating pressure: 300 P.S.I. (21 BAR)



COUPLERS

PART No.	Body Size	Material	Pipe
QD-TFMC4-4F	1/4	Steel	1/4 FPT
QD-TFMC4-6F	1/4		3/8 FPT
QD-TFMC6-4F	3/8		1/4 FPT
QD-TFMC6-6F	3/8		3/8 FPT
QD-TFMC8-8F	1/2		1/2 FPT
QD-TFMC4-4M	1/4		1/4 MPT
QD-TFMC6-4M	3/8		1/4 MPT
QD-TFMC6-6M	3/8		3/8 MPT
QD-TFMC4-4H	1/4		1/4
QD-TFMC4-4GT	1/4		1/4 (Grip-Tite)

NIPPLES

PART No.	Body Size	Material	Pipe
QD-TFN4-4F	1/4	Brass	1/4 FPT
QD-TFN6-4F	3/8	Steel	1/4 FPT
QD-TFN6-6F	3/8	Steel	3/8 FPT
QD-TFN8-8F	1/2	Steel	1/2 FPT
QD-TFN4-4M	1/4	Brass	1/4 MPT
QD-TFN6-4M	3/8	Steel	1/4 MPT
QD-TFN6-6M	3/8	Steel	3/8 MPT
QD-TFN4-4GT	1/4	Steel	1/4 (Grip Tite)
QD-TFN4-4H	1/4	Steel	1/4 HBARB
QD-STFN4-4F	1/4	Steel	1/4 FPT
QD-STFN4-4M	1/4	Steel	1/4 MPT

LINCOLN INTERCHANGE COUPLING - MANUAL

1/4" Size



Very long nose length.
NOTE: NOT ACTUAL SIZE

Fairview's Lincoln series interchange is a manual style connection easily identified by its' long pilot and short ball groove. It interchanges with Lincoln style couplings available from other manufacturers.

See Pneumatic Quick Disconnect Crossover - Page 184

Operating pressure: 300 P.S.I. (21 BAR)

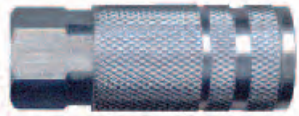

COUPLERS

PART No.	Body Size	Pipe
QD-LINMC4-4F	1/4	1/4 FPT
QD-LINMC4-4M	1/4	1/4 MPT

NIPPLES

PART No.	Body Size	Pipe
QD-LINN4-4F	1/4	1/4 FPT
QD-LINN4-4M	1/4	1/4 MPT

MINIATURE HIGH CAPACITY SERIES - AUTOMATIC

- One-handed operation
- High flow-low pressure drop
- Large range of connections
- Chrome Plated Brass construction

Ideally suited for medical, dental equipment, small air tools, robotics, laboratories, air conditioning systems, plant feeding, training aids, auto emission testing, cooling lines, photo processing and breathing apparatus.

Maximum pressure rating: 1000 psi

Working pressure: 0-230 psi

Vacuum: Over 12" Mercury

Temperature range: -40°F to +250°F
-40°C to +121°C



COUPLERS

PART No.	Body Size	Pipe
QD-MINIAC2-2F	1/8	1/8 FPT
QD-MINIAC2-4F	1/8	1/4 FPT
QD-MINIAC2-2M	1/8	1/8 MPT
QD-MINIAC2-4M	1/8	1/4 MPT

NIPPLES

PART No.	Body Size	Pipe
QD-MININ2-2F	1/8	1/8 FPT
QD-MININ2-4F	1/8	1/4 FPT
QD-MININ2-2M	1/8	1/8 MPT
QD-MININ2-4M	1/8	1/4 MPT

UNIVERSAL INTERCHANGE COUPLING - AUTOMATIC



Fairview's Universal series is a push-to-connect style coupler capable of accepting ARO 210, Industrial and Tru-Flate Interchanges.
Operating pressure: 300 P.S.I. (21 BAR)

COUPLERS



PART No.	Body Size	Pipe
QD-UNIAC4-4F	1/4	1/4 FPT
QD-UNIAC4-6F	1/4	3/8 FPT
QD-UNIAC4-4M	1/4	1/4 MPT
QD-UNIAC4-6M	1/4	3/8 MPT

PART No.	Body Size	Hose
QD-UNIAC4-4H	1/4	1/4
QD-UNIAC4-6H	1/4	3/8

INDUSTRIAL INTERCHANGE SWING COUPLINGS

1/4" Size

3/8" Size



NOTE: NOT ACTUAL SIZE



Industrial interchange swing coupling offers full flow, safety exhaust, locking feature, and connect and disconnect under pressure. Operating pressure 360 P.S.I. (25 BAR)

SWING COUPLERS

PART No.	Body Size	Pipe
QD-SCINDMC4-4F	1/4	1/4 FPT
QD-SCINDMC4-6F	1/4	3/8 FPT
QD-SCINDMC6-4F	3/8	1/4 FPT
QD-SCINDMC6-6F	3/8	3/8 FPT
QD-SCINDMC6-8F	3/8	1/2 FPT
QD-SCINDMC8-8F	1/2	1/2 FPT
QD-SCINDMC4-4M	1/4	1/4 MPT
QD-SCINDMC4-6M	1/4	3/8 MPT
QD-SCINDMC6-4M	3/8	1/4 MPT

PART No.	Body Size	Hose
QD-SCINDMC4-4H	1/4	1/4
QD-SCINDMC4-6H	1/4	3/8
QD-SCINDMC6-6H	3/8	3/8

Note: Use with QD-INDN Series Nipples Page 186

ARO210 INTERCHANGE SWING COUPLINGS

1/4" Size



Slightly longer nose length.
NOTE: NOT ACTUAL SIZE



ARO210 Swing couplings offers full flow, safety exhaust, locking feature, and connect and disconnect under pressure. It is interchangeable with ARO210 style available from various manufacturers. Operating Pressure: 360 P.S.I. (25 BAR)

SWING COUPLERS

PART No.	Body Size	Pipe
QD-SCAROMC4-4F	1/4	1/4 FPT
QD-SCAROMC4-6F	1/4	3/8 FPT
QD-SCAROMC4-4M	1/4	1/4 MPT
QD-SCAROMC4-6M	1/4	3/8 MPT

PART No.	Body Size	Hose
QD-SCAROMC4-4H	1/4	1/4
QD-SCAROMC4-6H	1/4	3/8

Note: Use with QD-ARON Series Nipples Page 187

G

CEJN INTERCHANGE SWING COUPLINGS

1/4" Size

3/8" Size



CEJN Interchange -- Short wide nose.
NOTE: NOT ACTUAL SIZE

CEJN interchange Swing couplings offer full flow, safety exhaust, locking feature, and connect and disconnect under pressure.

Operating Pressure: 360 P.S.I. (25 BAR)



SWING COUPLERS

PART No.	Body Size	Pipe
QD-SCCEJNC6-6F	3/8	3/8 FPT
QD-SCCEJNC6-6M	3/8	3/8 MPT

NIPPLES

PART No.	Body Size	Pipe
QD-SCCEJNN6-6M	3/8	3/8 MPT

CEJN INTERCHANGE COUPLINGS - MANUAL

1/4" Size

3/8" Size



CEJN Interchange -- Short wide nose.
NOTE: NOT ACTUAL SIZE

CEJN interchange couplings offer full flow, safety exhaust, locking feature, and connect and disconnect under pressure. Operating Pressure: 360 P.S.I. (25 BAR)

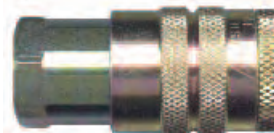

COUPLERS

PART No.	Body Size	Pipe
QD-CEJNMC4-4F	1/4	1/4 FPT
QD-CEJNMC6-6F	3/8	3/8 FPT

NIPPLES

PART No.	Body Size	Pipe
QD-CEJNN4-4F	1/4	1/4 FPT
QD-CEJNN6-6F	3/8	3/8 FPT
QD-CEJNN4-4M	1/4	1/4 MPT
QD-CEJNN6-6M	3/8	3/8 MPT

STRAIGHT THROUGH PRESSURE WASH Q.D.'S



- Smooth bore permits free flow.
- Ideal for high pressure water applications (Pressure Washers)

STRAIGHT THROUGH COUPLER - BRASS

PART No.	Body Size	Female Pipe
QD-BSTC4-4F	1/4	1/4
QD-BSTC6-6F	3/8	3/8
QD-BSTC8-8F	1/2	1/2

PART No.	Body Size	Male Pipe
QD-BSTC4-4M	1/4	1/4
QD-BSTC6-6M	3/8	3/8
QD-BSTC8-8M	1/2	1/2

STRAIGHT THROUGH COUPLER - STAINLESS STEEL

PART No.	Body Size	Female Pipe
QD-SSTC4-4F	1/4	1/4
QD-SSTC6-6F	3/8	3/8
QD-SSTC8-8F	1/2	1/2

PART No.	Body Size	Male Pipe
QD-SSTC4-4M	1/4	1/4
QD-SSTC6-6M	3/8	3/8

• Temperature: Hot Water +200°F, +93°C With EPR O-Ring

COUPLER SET PRESSURE RATINGS (P.S.I.)

	1/4	3/8	1/2
BRASS	4000	4000	2200
STEEL	4000	4000	2700
STAINLESS STEEL	4000	4000	3000

STRAIGHT THROUGH NIPPLE - BRASS

PART No.	Body Size	Female Pipe
QD-BSTN4-4F	1/4	1/4
QD-BSTN6-6F	3/8	3/8
QD-BSTN8-8F	1/2	1/2

PART No.	Body Size	Male Pipe
QD-BSTN4-4M	1/4	1/4
QD-BSTN6-6M	3/8	3/8
QD-BSTN8-8M	1/2	1/2

STRAIGHT THROUGH NIPPLE - STEEL

PART No.	Body Size	Female Pipe
QD-STN4-4F	1/4	1/4
QD-STN6-6F	3/8	3/8
QD-STN8-8F	1/2	1/2

PART No.	Body Size	Male Pipe
QD-STN4-4M	1/4	1/4
QD-STN6-6M	3/8	3/8
QD-STN8-8M	1/2	1/2

STRAIGHT THROUGH NIPPLE - STAINLESS STEEL

PART No.	Body Size	Female Pipe
QD-SSTN4-4F	1/4	1/4
QD-SSTN6-6F	3/8	3/8
QD-SSTN8-8F	1/2	1/2

PART No.	Body Size	Male Pipe
QD-SSTN4-4M	1/4	1/4
QD-SSTN6-6M	3/8	3/8
QD-SSTN8-8M	1/2	1/2

KARCHER STYLE PRESSURE WASH HOSE ADAPTERS



PART No.
QD-KARCHER-6F
QD-KARCHER-6M



Pipe Size
3/8 FPT X M22 X 1.5
3/8 MPT X M22 X 1.5



PART No.
QD-KARN-6F
QD-KARN-6M



Pipe Size
3/8 FPT X M22 X 1.5
3/8 MPT X M22 X 1.5

• USED TO ADAPT STANDARD PRESSURE WASH HOSES TO KARCHER STYLE EQUIPMENT • ABOVE PRESSURE WASH COUPLINGS COME WITH EPR O-RING GOOD FOR HOT WATER UP TO 200°F • PRESSURE RATING: 4000 PSI

BRASS WATER HOSE (GARDEN HOSE) QUICK DISCONNECTS



PART No.
QD-WHCF

DESCRIPTION
Quick Disconnect
Coupler X
Water Hose Thread

QD-WHVCF

Valved QD Coupler X
Water Hose Thread



PART No.
QD-WHNM

DESCRIPTION
Quick Disconnect
Nipple X
Water Hose Thread

• TO BE USED WITH DOMESTIC (CITY) WATER SUPPLY • WATER NOZZLES SEE PAGE 241

PROPANE / NATURAL GAS QUICK DISCONNECT COUPLINGS

GAS-FLO C.S.A. GAS INTERCHANGE QUICK DISCONNECTS

- C.S.A. certified for natural gas and L.P. gas - air mixtures.
- Quick Disconnect Rated To 1/2 P.S.I.



Blister Box Packaging



Quick Disconnect BTU Capacity (Flow capacities are based on 0.64 specific gravity @ 0.3" w.c. pressure drop)					
1/4	3/8	1/2	3/4	1	1-1/4
50,000	85,000	120,000	260,000	310,000	500,000

VALVED COUPLER - BRASS

PART No.	Body Size	Female Pipe
QD-GMC4-4F	1/4	1/4
QD-GMC6-6F	3/8	3/8
BB-QD-GMC6-6F (Blister Box Packaging)	3/8	3/8
QD-GMC8-8F	1/2	1/2
QD-GMC12-12F	3/4	3/4
QD-GMC16-16F	1	1
QD-GMC20-20F	1-1/4	1-1/4

NIPPLE - BRASS

PART No.	Body Size	Pipe
QD-GMRVN4-4M	1/4	1/4 MPT
QD-GMN6-6F	3/8	3/8 FPT
QD-GMN8-8F	1/2	1/2 FPT
QD-GMN12-12F	3/4	3/4 FPT
QD-GMN16-16F	1	1 FPT
QD-GMN20-20F	1-1/4	1-1/4 FPT

SIZE	COUPLER PLUG	NIPPLE CAP
1/4	QD-RVSDC-4	--
3/8	QD-GMDP-6	QD-GMDC-6
1/2	QD-GMDP-8	QD-GMDC-8
3/4	QD-GMDP-12	QD-GMDC-12

GAS-FLO RECREATIONAL VEHICLE VALVED QUICK DISCONNECT

- C.S.A. (C.G.A. / A.G.A.) design certified for natural gas and L.P. gas - air mixtures.



BRASS PLUG 1/4 Male Pipe

PART No. QD-GMRVN4-4M
Body Size 1/4 Male Pipe
Full flow plug for quick connect and disconnect of R.V. style coupler.

R.V. Q.D. SET COUPLER & PLUG

PART No. BB-QD-GMRV-SET
Description With Retail Blister Box

COUPLER WITH BALL VALVE 1/4 Female Pipe

PART No. QD-GMRC4-4F
Body Size 1/4"
For quick connect and disconnect of LP gas hose to camper/RV cooking stoves.

COUPLER DUST PLUG

PART No. QD-RVSDC-4



HANSEN GAS-MATE™ II C.S.A. GAS Q.D.'S

- C.S.A. certified for natural gas and L.P. gas - air mixtures.
- Thermal protection shut-off valve stops gas flow if temperature around connection reaches +240°F to +300°F (+116°C to +149°C).



FILL PLUG Female POL

PART No. QD-GM2N4-FPOL
Body Size 1/4"

Designed to adapt filling hose to quick disconnect cylinder valve for filling of propane cylinder.

COUPLER ADAPTER Male POL X CGA 790

PART No. QD-GM2C4-POL
Body Size 1/4"

Adapter for conversion of POL cylinder valve connections into (CGA 790) quick closing coupling

60,000 BTU/Hr. Capacity
(Flow capacities are based on 0.64 specific gravity @ 0.3" w.c. pressure drop)

PRESSURE GAUGES



WHAT'S NEW IN THIS SECTION

- Air Pressure GaugePg 195

AIR PRESSURE GAUGE	195
DRY	194 - 196
GAUGE PROTECTOR COVERS	198
LIQUID FILLED	197 - 198
MOUNTING BRACKETS	198
SNUBBERS	198
TEST GAUGE	194
TRIDICATORS	196
VACUUM SERVICE	195
WATER TIGHT	194

DRY PRESSURE GAUGES

- Dry Gauge • Steel Case • Accuracy: 3% -2% -3% • Connection: Brass • Bourdon Tube
- Operating Temperature: -40°F To +140°F, -40°C To +60°C • Meets ASME B40.100 Standards



1/8 M.P.T. STEM MOUNT

PART No.	Dial Dia	Range	
	(IN.)	(P.S.I.)	(kPa)
PG-100SD15	1.5	0-100	N/A
PG-160SD15	1.5	0-160	N/A

1/4 M.P.T. STEM MOUNT

PART No.	Dial Dia	Range	
	(IN.)	(P.S.I.)	(kPa)
PG-15SD2	2	0-15	N/A
PG-30SD2	2	0-30	N/A
PG-60SD2	2	0-60	N/A
PG-100SD2	2	0-100	N/A
PG-160SD2	2	0-160	N/A
PG-200SD2	2	0-200	N/A
PG-300SD2	2	0-300	N/A
PG-15SD25	2.5	0-15	0-100
PG-30SD25	2.5	0-30	0-200
PG-60SD25	2.5	0-60	0-400
PG-100SD25	2.5	0-100	0-700
PG-160SD25	2.5	0-160	0-1100
PG-200SD25	2.5	0-200	0-1400
PG-300SD25	2.5	0-300	0-2100

1/4 M.P.T. STEM MOUNT TEST GAUGE

PART No.	Dial Dia	Range	
	(IN.)	W.C.	(OZ/in ²)
PG-35WCS25	2.5	0-35	0-20

1/8 M.P.T. CENTER BACK MOUNT

PART No.	Dial Dia.	Range	
	(IN.)	(P.S.I.)	(kPa)
PG-30CD15	1.5	0-30	N/A
PG-60CD15	1.5	0-60	N/A
PG-100CD15	1.5	0-100	N/A
PG-160CD15	1.5	0-160	N/A

1/4 M.P.T. CENTER BACK MOUNT

PART No.	Dial Dia.	Range	
	(IN.)	(P.S.I.)	(kPa)
PG-30CD2	2	0-30	N/A
PG-60CD2	2	0-60	N/A
PG-100CD2	2	0-100	N/A
PG-160CD2	2	0-160	N/A
PG-200CD2	2	0-200	N/A

* 1/4 M.P.T. CENTER BACK MOUNT WATER TIGHT STAINLESS STEEL CASE

PART No.	Dial Dia.	Range	
	(IN.)	(P.S.I.)	(kPa)
PG-300CD125	1.25	0-300	N/A

• Suitable for use in Marine applications.

- * Dry Gauge • #304 Stainless Steel Case • Accuracy: 3% -2% -3% ANSI / ASME Grade B
- Connection: Brass • Spiral Tube • Lens Plexiglass, Watertight
- Operating Temperature: -40°F To +150°F, -40°C To +65°C

DRY PRESSURE GAUGES

- Dry Gauge • Steel Case • Accuracy: 3% -2% -3% • Connection: Brass • Bourdon Tube
- Operating Temperature: -40°F To +140°F, -40°C To +60°C

VACUUM SERVICE 1/4 M.P.T. STEM MOUNT



PART No.	Dial Diameter	Vacuum	Range (P.S.I.)
PG-30SDV2	2"	30-0 hg	
PG-30V30SD2	2"	30-0 hg	0-30

AIR PRESSURE GAUGES

TRUCK PRESSURE GAUGE (2" DIAL)



6" Wand allows for extended reach.

PART No. TPG-1
Designed for Truck Applications

FEATURES

- 0 - 160 psi
- Dual Foot filler valve.
- Exceeds Standard ANSI-ASME B-40.1 Grade B requirements for 2% accuracy.
- Highly shock resistant.
- Employs Award-winning gearless diaphragm design; No Bourdon Tube!
- Features Bleeder Valve, which holds pressure until released.

Maintaining proper tire pressure improves mileage, reduces tire wear and increase driving safety.



TRIDICATOR GAUGES

- Dry Gauge • Steel Case • Accuracy: 3% -2% -3%
- Connection: Brass • Bourdon Tube • Screw-on Plastic Face

TRIDICATOR (2.5" DIAL) 1/4 M.P.T. CENTER BACK MOUNT



PART No.	Dial	Probe Length			Range (P.S.I.)	(kPa)
	Diameter	"A"	"B"	"C"		
PG-75/320TR25	2.5"	0.37"	1.62"	0.50"	0-75	0-500
PG-75/320TR25-1	2.5"	1.43"	1.00"	0.50"	0-75	0-500
PG-75/320TR25-1.6	2.5"	1.43"	1.62"	0.50"	0-75	0-500

Operating Temperature: +60°F to +320°F, +16°C to +160°C

TRIDICATOR (3.5" DIAL) 1/2 M.P.T.

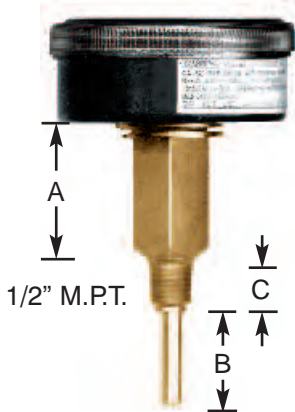

• CENTER BACK MOUNT

PART No.	Dial	Probe Length			Range (P.S.I.)	Ft. H ₂ O
	Diameter	"A"	"B"	"C"		
PG-55/250CTR35-D	3.5"	1.14"	2.95"	0.91"	0-55	0-130

Operating Temperature: +70°F to +250°F, +21°C to +121°C
Steel Rimmed ABS • Other Temperature Ranges Available.

• STEM MOUNT

PART No.	Dial	Probe Length			Range (P.S.I.)	Ft. H ₂ O
	Diameter	"A"	"B"	"C"		
PG-75/320STR25-1.6D	2.5"	1.43"	1.62"	0.50"	0-75	0-500

Operating Temperature: +60°F to +320°F, +16°C to +160°C

LIQUID FILLED PRESSURE GAUGES



- Liquid Gauge • #304 Stainless Steel Case • 1.5% Full Scale Accuracy
- Operating Temperature: - 4°F To + 150°F, -20°C To +65°C • Meets ASME B40.100 Standards

1/4 M.P.T. STEM MOUNT (2.5" DIAL)

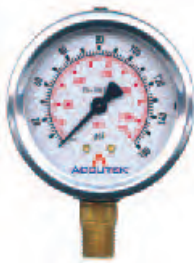

PART No.	Dial Diameter		Range		PART No.	Dial Diameter		Range	
	(IN.)	(P.S.I.)	(kPa)			(IN.)	(P.S.I.)	(kPa)	
PG-15SG25	2.5	0-15	0-100		PG-400SG25	2.5	0-400	0-2800	
PG-30SG25	2.5	0-30	0-200		PG-600SG25	2.5	0-600	0-4000	
PG-60SG25	2.5	0-60	0-400		PG-1000SG25	2.5	0-1000	0-7000	
PG-100SG25	2.5	0-100	0-700		PG-1500SG25	2.5	0-1500	0-10000	
PG-100SG25LT	2.5	0-100	0-700		PG-2000SG25	2.5	0-2000	0-14000	
PG-160SG25	2.5	0-160	0-1100		PG-3000SG25	2.5	0-3000	0-21000	
PG-160SG25LT	2.5	0-160	0-1100		PG-5000SG25	2.5	0-5000	0-35000	
PG-200SG25	2.5	0-200	0-1400		PG-10000SG25	2.5	0-10000	0-70000	
PG-300SG25	2.5	0-300	0-2100		PG-15000SG25	2.5	0-15000	0-100000	

("LT" -76°F To + 140°F, -60°C To +60°C Low Temp)

1/4 M.P.T. STEM MOUNT (4" DIAL)



PART No.	Dial Diameter		Range		PART No.	Dial Diameter		Range	
	(IN.)	(P.S.I.)	(kPa)			(IN.)	(P.S.I.)	(kPa)	
PG-30SG4	4	0-30	0-200		PG-1000SG4	4	0-1000	0-7000	
PG-60SG4	4	0-60	0-400		PG-1500SG4	4	0-1500	0-10000	
PG-100SG4	4	0-100	0-700		PG-3000SG4	4	0-3000	0-21000	
PG-160SG4	4	0-160	0-1100		PG-5000SG4	4	0-5000	0-35000	
PG-160SG4LT	4	0-160	0-1100		PG-10000SG4	4	0-10000	0-70000	
PG-200SG4	4	0-160	0-1400						
PG-300SG4	4	0-300	0-2100						

("LT" -76°F To + 140°F, -60°C To +60°C Low Temp)

1/4 M.P.T. STEM MOUNT (4" DIAL) ALL STAINLESS STEEL (316)



PART No.	Dial Diameter		Range	
	(IN.)	(P.S.I.)	(kPa)	
PG-60SG4SS	4	0-60	0-400	

1/4 M.P.T. CENTER BACK MOUNT

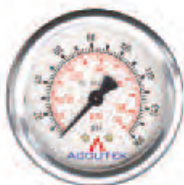

PART No.	Dial Diameter		Range		PART No.	Dial Diameter		Range	
	(IN.)	(P.S.I.)	(kPa)			(IN.)	(P.S.I.)	(kPa)	
PG-15CG25	2.5	0-15	0-100		PG-400CG25	2.5	0-400	0-2800	
PG-30CG25	2.5	0-30	0-200		PG-600CG25	2.5	0-600	0-4000	
PG-60CG25	2.5	0-60	0-400		PG-1000CG25	2.5	0-1000	0-7000	
PG-100CG25	2.5	0-100	0-700		PG-1500CG25	2.5	0-1500	0-10000	
PG-100CG25LT	2.5	0-100	0-700		PG-2000CG25	2.5	0-2000	0-14000	
PG-160CG25	2.5	0-160	0-1100		PG-3000CG25	2.5	0-3000	0-21000	
PG-160CG25LT	2.5	0-160	0-1100		PG-5000CG25	2.5	0-5000	0-35000	
PG-200CG25	2.5	0-200	0-1400		PG-10000CG25	2.5	0-10000	0-70000	
PG-300CG25	2.5	0-300	0-2100						

("LT" -76°F To + 140°F, -60°C To +60°C Low Temp)

H

LIQUID FILLED PRESSURE GAUGES

- Liquid Gauge • #304 Stainless Steel Case • 1.5% Full Scale Accuracy
- Operating Temperature: - 4°F To + 150°F, -20°C To + 65°C • Meets ASME B40.100 Standards



("LT" -76°F To + 140°F, -60°C To +60°C Low Temp)



PG-MB25

2 SCREW U-CLAMP

(For Use With Center Back Or Stem Mount Gauges.)

PG-PM25

3 HOLE PANEL MOUNT

(Only For Use With Center Back Mount Gauges.)



PG-SNUBBER

- Brass 1/4" Female x 1/4" Male
- Protects gauges from shock.
- Operating Temperature: - 65°F To + 650°F
- 54°C To + 343°C



PG-RC25



1/4 M.P.T. STEM MOUNT WITH FACTORY FLANGE

PART No.	Dial	Range	
	Diameter (IN.)	(P.S.I.)	(kPa)
PG-30SGRF	4	0-30	0-200
PG-100SGRF	4	0-100	0-700
PG-100SGRFLT	4	0-100	0-700
PG-160SGRF	4	0-160	0-1100

VACUUM SERVICE 1/4 M.P.T. STEM MOUNT

PART No.	Dial	Range	
	Diameter (IN.)	Vacuum (P.S.I.)	(P.S.I.)
PG-30SGV25	2.5	30-0 hg	
PG-30V30SG25	2.5	30-0 hg	0-30

VACUUM SERVICE 1/4 M.P.T. CENTER BACK MOUNT

PART No.	Dial	Range	
	Diameter (IN.)	Vacuum (P.S.I.)	(P.S.I.)
PG-30CGV25	2.5	30-0 hg	
PG-30V30CG25	2.5	30-0 hg	0-30

MOUNTING BRACKETS

PART No.	For Dial	Description
	Diameter (IN.)	
PG-MB25	2.5	2 Screw U-Clamp
PG-MB25-ALL	2.5	2 Screw U-Clamp
PG-MB25-WK	2.5	Wika 2 Screw U-Clamp
PG-PM25	2.5	3 Hole Panel Mount
PG-RF4	4	3 Hole Panel Mount

SNUBBER

PART No.	Range	Service
	(P.S.I.)	
PG-SNUBBER *	0-10000	Heavy Oils
PG-SNUBBER-G	0-10000	Air and other Gases
PG-SNUBBER-W *	0-10000	Gasoline, Water, Light Oils

*Conforms to requirements of MIL-D-2940A

GAUGE PROTECTOR COVER

PART No.	For Dial	Material	Color
	Diameter (IN.)		
PG-RC25	2.5	Rubber	Blue
PG-RC4	4.0	Rubber	Blue



WHAT'S NEW IN THIS SECTION

- Gas-Flo® Gas Appliance RegulatorPg 208

GAS CONTROL COMPONENTS

CSST AND FITTINGS 213 - 216

GAS CONTROL VALVE (ELECTRIC) 212

GAS DETECTOR / ALARMS 212

GAS VENT FITTINGS & PIPE 226

LIFT TRUCK CHECK CONNECTORS 227 228

LP-GAS CYLINDERS AND TANK EQUIPMENT 227 - 230

LP-GAS REGULATORS

DOMESTIC APPLICATIONS 200 - 201

GAS GRILL (BARBECUE) 204 - 205

HIGH PRESSURE - INDUSTRIAL 206 - 207

LOW PRESSURE - R. V. 202 - 203

NATURAL OR LP GAS APPLIANCE - LINE 208

NATURAL GAS / PROPANE GAS OUTLETS 209 - 211

POLYETHYLENE GAS PIPE AND MECHANICAL FITTINGS 217 - 225

HIGH PRESSURE LP GAS FIRST STAGE REGULATORS

First-Stage regulators are designed for use as the first regulator of a Two-Stage regulation system on domestic applications. This large capacity adjustable First-Stage regulator is factory set at 10 psig. Equipped with integral relief valve and built-in 1/8" FNPT gauge tap.

PART No.	Inlet Connection	Outlet Connection	Delivery Pressure	Adjustment Range	Bonnet Vent	Capacity * (BTU/HR) Propane
GR-918	F.POL	1/2 FPT	10 psig	5-10 psig	Over Outlet	2,500,000
GR-9188	1/2 FPT	1/2 FPT	10 psig	5-10 psig	Over Outlet	2,500,000
GR-905	Regulator Mounting Bracket					

* Flow Capacity based on Inlet Pressure 20 psi higher than the Regulator setting and delivery Pressure 20% lower than the setting.



FLOW CHARACTERISTIC CHART FOR MODEL GR-918, GR-9188 AND GR-9112

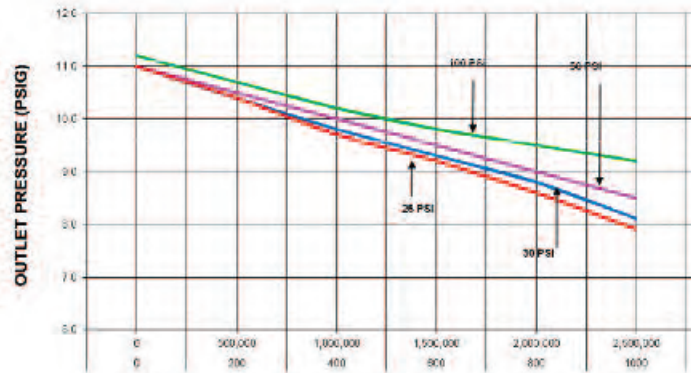

LOW PRESSURE LP GAS SECOND STAGE REGULATORS

Second Stage regulators are designed to reduce the pressure from a First-Stage regulator in domestic applications. These adjustable regulators are factory set at 11" w.c. with first stage inlet pressure of 10 psig. Equipped with integral relief valve and built-in 1/8" FNPT gauge tap.

PART No.	Inlet Connection	Outlet Connection	Delivery Pressure	Adjustment Range	Bonnet Vent	Capacity * (BTU/HR) Propane
GR-928	1/2 FPT	1/2 FPT	11" wc @ 10 psi	9"-13" wc	Over Inlet	950,000
GR-9212	1/2 FPT	3/4 FPT	11" wc @ 10 psi	9"-13" wc	Over Inlet	950,000
GR-905	Regulator Mounting Bracket					

* Flow Capacity based on 10 psi Inlet Pressure and 9" wc delivery Pressure

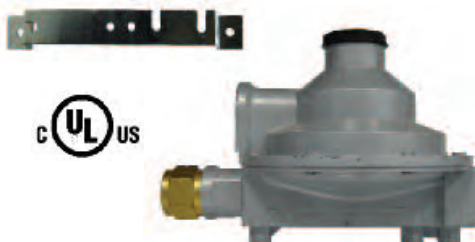

FLOW CHARACTERISTIC CHART FOR MODEL GR-928, GR-9212 AND GR-921212

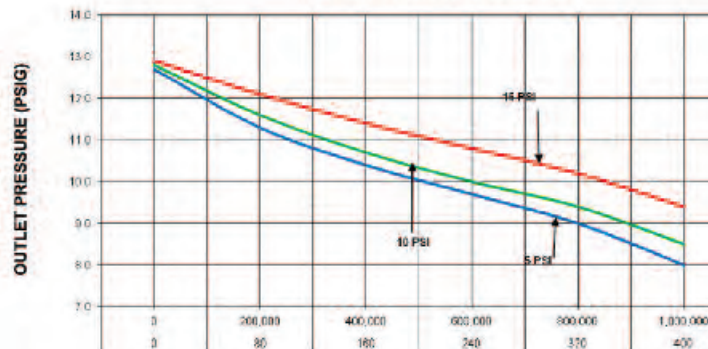

LP GAS TWIN STAGE REGULATORS

Twin Stage regulators combine first and second stage regulators into a single unit. Designed to reduce container pressure down to 11" w.c. delivery pressure. Equipped with 1/8" FNPT gauge taps on inlet and outlet for easy system pressure checks.

PART No.	Inlet Connection	Outlet Connection	Delivery Pressure	Adjustment Range	Bonnet Vent 1st Stage	Bonnet Vent 2nd Stage	Capacity* (BTU/hr) Propane
GR-948	1/4 FPT	1/2 FPT	11" wc @ 100 psi	9"-13" wc	Down	Over Outlet	525,000
GR-9412	1/4 FPT	3/4 FPT	11" wc @ 100 psi	9"-13" wc	Down	Over Outlet	525,000
GR-905	Regulator Mounting Bracket						

* Flow Capacity based on 25 psi Inlet Pressure and 9" wc delivery Pressure

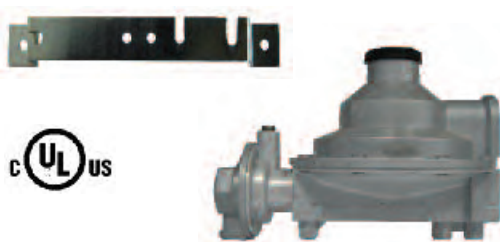

FLOW CHARACTERISTIC CHART FOR MODEL GR-948 AND GR-9412

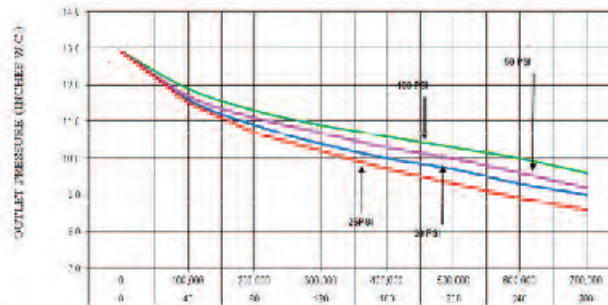

COMPACT LP GAS TWIN STAGE REGULATORS

This Compact regulator combines first and second stage regulators into a single unit. Designed to reduce container pressure down to 11" w.c. delivery pressure. Its' compact design makes it the ideal choice for small domestic applications. Equipped with 1/8" FNPT gauge taps on inlet and outlet for easy system pressure checks.

PART No.	Inlet Connection	Outlet Connection	Delivery Pressure	Adjustment Range	Bonnet Vent 1st Stage	Bonnet Vent 2nd Stage	Capacity* (BTU/hr) Propane
GR-9448	1/4 FPT	1/2 FPT	11" wc @ 100 psi	9"-13" wc	Left	9 O'Clock	200,000
GR-905	Regulator Mounting Bracket						

* Flow Capacity based on 25 psi Inlet Pressure and 9" wc delivery Pressure

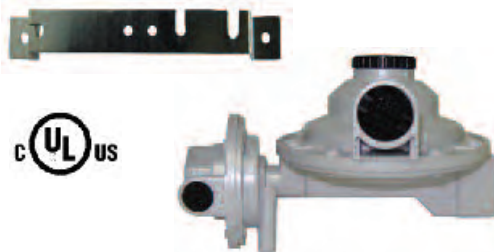

FLOW CHARACTERISTIC CHART FOR MODEL GR-9448

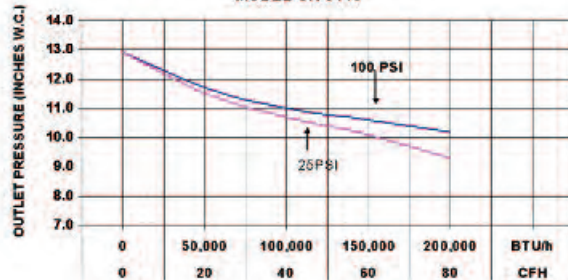

LP GAS TWIN STAGE REGULATOR KITS



These kits contain regulator and pigtail in one convenient package.

PART No.	Regulator Included	Inlet Connection	Outlet Connection	Vent Positions	Pigtail Included	Capacity* BTU/HR
GR-948-KIT	GR-948	1/4 FPT	1/2 FPT	See Above	CP-2412	525,000
GR-9448-KIT	GR-9448	1/4 FPT	1/2 FPT	See Above	CP-2412	200,000

* Capacity based on inlet pressure 25 PSIG and delivery pressure 9" w.c.

LOW PRESSURE TWO-STAGE AUTOMATIC CHANGEOVER REGULATORS

The Fairview Automatic Changeover Regulator redirects LP gas vapor flow from an empty designated service cylinder to a reserve cylinder, without interruption of service. It features a green indicator dome which changes to red when the service cylinder needs to be refilled.

Specifications

- Zinc Die Cast
- Molded Rubber Diaphragms
- UL Listed
- 2nd Stage Relief Mechanism Per U.L. 144
- Powder Coated

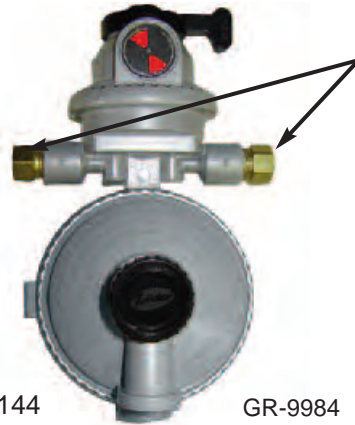

**INVERTED
FLARE INLET
CONNECTIONS
WITH BACK
CHECK VALVE**



UL Listed to UL144

GR-9984

PART No.	Inlets (Back Check Included)	Outlet	Capacity BTU/Hr Propane
GR-9984	1/4" F. Inv. Flare	3/8 FPT	Service: 340,000 BTU/Hr*
GR-9984P	GR-9984 Retail Packaged		
GR-9984-U	GR-9984 with GR-RVB Mounting Bracket		
GR-9984-2Z	GR-9984 with GR-900 Mounting Bracket (x2)		
GR-900	Z Mounting Bracket		
GR-RVB	RV Style Mounting Bracket		
GR-5984	Protective Cover		

*Based on 25 PSIG inlet pressure and 9" W.C. outlet pressure at Manufacturer's set point.
Manufacturer's set point = 100 PSIG and 11" W.C. outlet at 40 SCFH propane.

COMPLETE KITS AVAILABLE

PART No.
GR-9984-KIT-1

Description
R.V. Reg. & 12" Pigtail Kit



Other Lengths Available

Contains:

- 2 Type I Assemblies 12"
- 1 Regulator (GR-9984-U)
- 1 3/8 Flare Adapter (48-6C)

FLOW CHARACTERISTIC CHART FOR
MODEL GR-9984-A

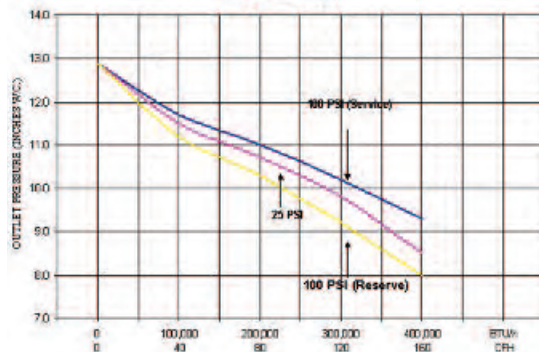

GR-9984-2Z



GR-9984-U



GR-900



GR-RVB

LOW PRESSURE TWO-STAGE LP GAS REGULATORS

The model GR-9950 and GR-9959 regulator combines both a high pressure first stage and a low pressure second stage regulator into a single unit. Ideally designed for RV applications, these regulators ensure a smooth and continuous flow of gas to all appliances.

Specifications

- Zinc Die Cast
- Molded Rubber Diaphragms
- UL Listed
- 2nd Stage Relief Mechanism Per U.L. 144
- Adjusting Screw and Dust Cap Design
- Powder Coated



GR-9959



GR-9950

PART No.	Inlet	Outlet	Vent Position	Capacity BTU/Hr* Propane
GR-9950	1/4 FPT	3/8 FPT	Above Outlet	195,000 BTU/Hr*
GR-9959			9:00 Vent	
GR-9950P	GR-9950 complete with retail Hanger Box Packaging			
GR-9952	GR-9950 regulator with Manifold Tee			
GR-9954	GR-9959 regulator with Excess Flow P.O.L.			
GR-9956	GR-9950 regulator with Excess Flow P.O.L.			
GR-9958	GR-9950 regulator with QCC1 (1-5/16 F. Acme)			
GR-9959P	GR-9959 complete with retail Hanger Box Packaging			
GR-900	Z Mounting Bracket			
GR-RVB	RV Mounting Bracket			
GR-5950	Protective Cover for GR-9950			
GR-5959	Protective Cover for GR-9959			

*Based on 25 PSIG inlet pressure and 9" W.C. outlet pressure at Manufacturer's set point. Manufacturer's set point = 100 PSIG and 11" W.C. outlet at 40 SCFH propane.

FLOW CHART CHARACTERISTICS

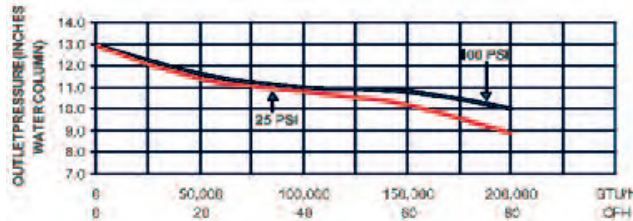

GR-9956



GR-900



GR-RVB



GR-5959



GR-5950



GR-9954

LOW PRESSURE SINGLE STAGE LP GAS REGULATORS

The model GR-800 regulator incorporates a drip lip vent and is ideally suited for use with portable appliances.

Specifications

- Zinc Die Cast
- Molded Rubber Diaphragms
- Underwriters Laboratories Listed
- Integral Pressure Relief



GR-800

PART No.	Inlet	Outlet	Vent Position	Capacity BTU/Hr* Propane
GR-800	1/4 FPT	3/8 FPT	Drip Lip Vent Above Outlet	175,000 BTU/Hr*
GR-856	GR-800 regulator with Hard nose P.O.L.			
GR-866	GR-800 regulator with QCC1 (1-5/16 F. Acme)			
GR-876	GR-800 regulator with Soft nose P.O.L.			

*Based on 25 PSIG inlet pressure and 9" W.C. outlet pressure at Manufacturer's set point. Manufacturer's set point = 100 PSIG and 11" W.C. outlet at 50 SCFH propane.

NOTE:
FOR INFORMATION ON ORDERING
COMPLETE HOSE ASSEMBLY
I6C**FS6MP6 SEE PAGE 123

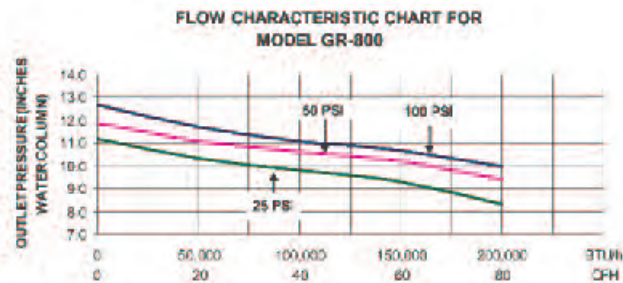

GR-856



GR-866

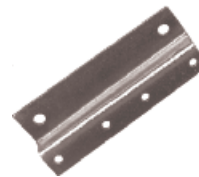

GR-900

LOW PRESSURE SINGLE STAGE LP GAS REGULATORS

The model GR-700B compact 90° regulator is ideally suited for outdoor gas grills. The size, shape and flow characteristics of these regulators make them the ideal choice for small portable appliances.

Specifications

- Zinc Die Cast
- Molded Rubber Diaphragms
- Underwriters Laboratories Listed



GR-700B

PART No.	Inlet	Body	Outlet	Capacity BTU/Hr* Propane
GR-700B	1/4 FPT	90 Degree	3/8 FPT	150,000
BB-GR-700B	GR-700B complete with retail Blister Box Packaging			
GR-756	GR-700B regulator with Hard Nose P.O.L.			
GR-766	GR-700B regulator with QCC1 (1-5/16 F. Acme)			
GR-776	GR-700B regulator with Soft nose P.O.L.			

*Based on 25 PSIG inlet pressure and 9" W.C. outlet pressure at Manufacturer's set point.
Manufacturer's set point = 100 PSIG and 11" W.C. outlet at 40 SCFH propane.

FLOW CHARACTERISTIC CHART FOR MODEL GR-700B

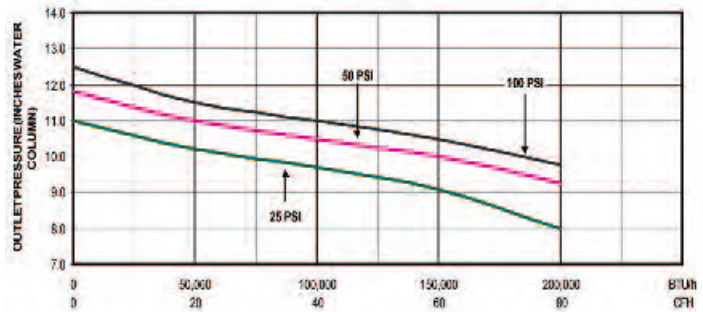

GR-766
90° Body c/w QCC1



GR-756
90° Body c/w HN POL

NOTE
FOR ORDERING COMPLETE BARBECUE REGULATOR HOSE ASSEMBLY SEE PAGE 128, 129



HIGH PRESSURE LP GAS REGULATORS

Ideally suited for applications where pounds instead of inches of w.c. are required. Factory Pre-set from 1 - 30 PSIG. Available from stock at 15 PSIG.

- Gas Grills • Smokers • Fish Cookers

Specifications:

- **Inlet:** 1/4 Female Pipe Thread
- **Outlet:** 1/4 Female Pipe Thread
- **UL Listed Outlet Pressures from 1 PSIG to 30 PSIG Available**



GR-615B

PART No.	Inlet Connection	Outlet Connection	Outlet Pressure (Set Point) (PSIG)	Inlet Pressure (PSIG)	Capacity At 10% Droop From Set Point BTU/HR
GR-610B	1/4	1/4	10	100	500,000
GR-615B	FPT	FPT	15	100	500,000
GR-630B			30	100	500,000
BB-GR-610B	GR-610B complete with retail Blister Box Packaging				

FLOW CHARACTERISTIC CHART FOR MODEL GR-601

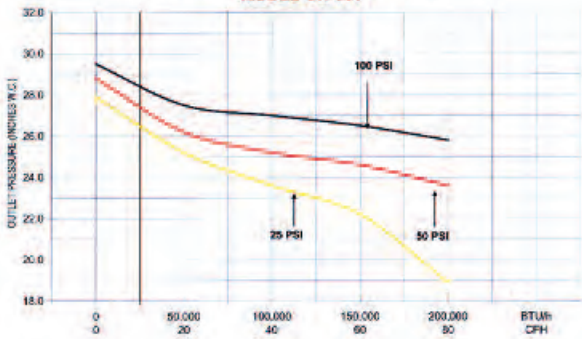

FLOW CHARACTERISTIC CHART FOR MODEL GR-610

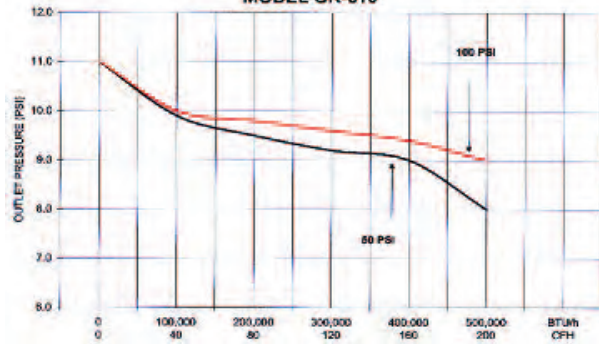

FLOW CHARACTERISTIC CHART FOR MODEL GR-615

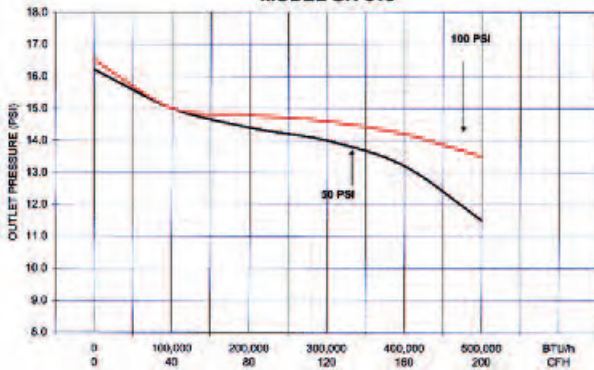

FLOW CHARACTERISTICS CHART FOR MODEL GR-630

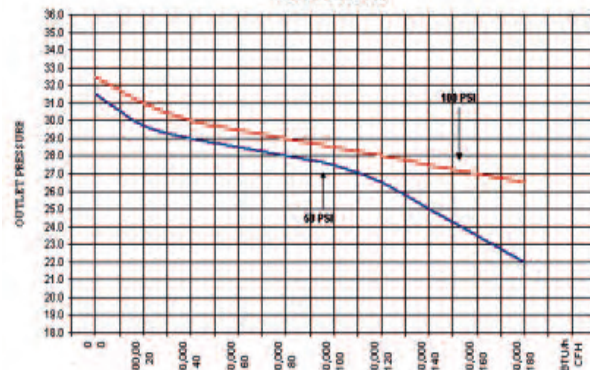

HIGH PRESSURE POUNDS-TO-POUNDS REGULATORS

Designed for cylinder systems in liquid or vapor service. Delivery pressures are adjustable from 0-30, 0-60 PSI. Ideally suited for a variety of industrial applications.

- Torches
- Construction Heaters
- Fish Cookers
- Tar Pot Heaters
- Flame Cultivators

PART No.	Delivery Pressure Range (PSIG)	Inlet / Outlet Connection	Outlet Pressure (Set Point) (PSIG)	Capacity BTU/Hr Propane
GR-320	0-20	1/4 FPT	20	1,500,000*
GR-330	0-30		30	1,500,000*
GR-340	0-40		40	1,500,000*
GR-360	0-60		60	2,000,000**
GR-334	GR-330 regulator with Excess Flow P.O.L.			
GR-338	GR-330 regulator with Hard Nose P.O.L.			
GR-364	GR-360 regulator with Excess Flow P.O.L.			
GR-365	GR-360 with Hard Nose P.O.L. and 135-LB Adapter			
GR-368	GR-360 regulator with Hard Nose P.O.L.			

*Based on 100 PSIG inlet pressure with 25 PSIG outlet pressure.
 **Based on 100 PSIG inlet pressure with 54 PSIG outlet pressure.

GR-330



Specifications:

- Inlet: 1/4 Female Pipe Thread
- Outlet: 1/4 Female Pipe Thread
- Maximum Inlet Pressure: 250 PSIG
- Gauge Port: 1/4 FPT (Plugged)

FLOW CHARACTERISTIC CHART FOR H.P. ADJUSTABLE REGULATOR (0-30 PSI)

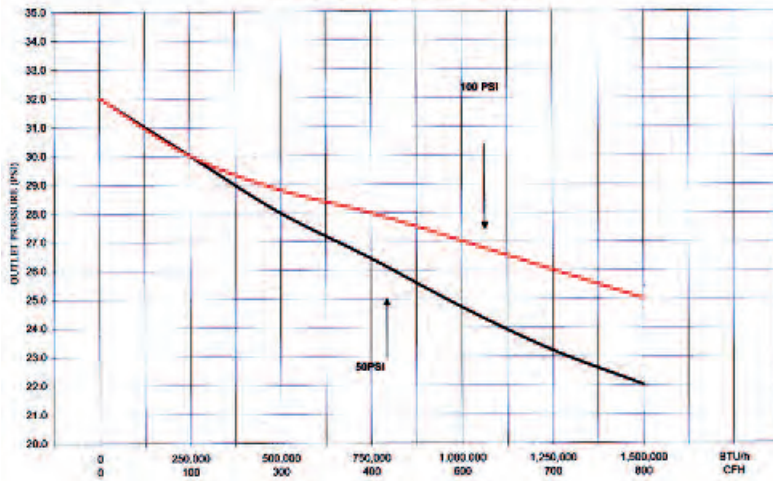

FLOW CHARACTERISTIC CHART FOR H.P. ADJUSTABLE REGULATOR (0- 60 PSI)

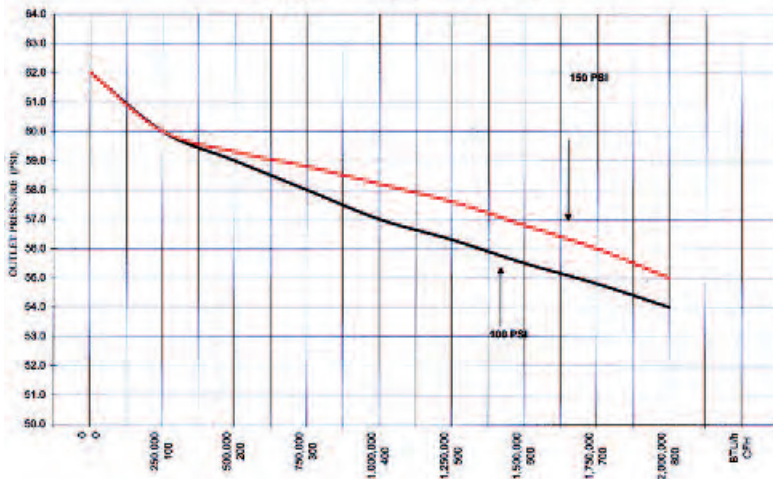

GR-365 Hard Nose P.O.L. and Welding 135-LB Adapter (Torch Applications)

NOTE FOR ORDERING COMPLETE REGULATOR HOSE ASSEMBLY SEE PAGE 236



2003-T Excess Flow POL See Page 33



GAS APPLIANCE AND LINE PRESSURE REGULATORS

POPPET DESIGN GAS APPLIANCE REGULATOR

CSA DESIGN CERTIFIED Z21.18 - CSA 6.3

The GR-200 series regulators are intended for main burner and pilot applications. Features precise regulating control.

Maximum Load Capacity: For main burner and pilot applications:

GR-207	65,000 Btu/hr	Natural Gas
GR-211	100,000 Btu/hr	LP Gas

Ambient Temp. Limits
-40°F To +205°F
-40°C To +96°C



Gases: Natural Gas or LP Gas

PART No.	Inlet Connection	Outlet Connection	Inlet Pressure	Outlet Pressure	Venting
GR-207	3/8 FPT	3/8 FPT	2 P.S.I.	7" w.c.	FIXED ORIFICE
GR-211	3/8 FPT	3/8 FPT	2 P.S.I.	11" w.c.	FIXED ORIFICE

LEVER ACTING DESIGN GAS APPLIANCE REGULATOR

CSA DESIGN CERTIFIED Z21.18 - CSA 6.3

The MX-325 Series is a pounds to inches regulator for use on residential, commercial and industrial applications. They are a high performance type and can be used as a single stage regulator - reducing pounds pressure to normal burner pressure.

Maximum Individual Load: Largest single appliance served by the regulator.

MX-325-3-1/2	140,000 Btu/hr
MX-325-5A-3/4	300,000 Btu/hr

Gases: Natural or LP Gas

Maximum Load Capacity: Total load of all appliances combined.

MX-325-3-1/2	250,000 Btu/hr
MX-325-5A-3/4	425,000 Btu/hr

Gases: Natural or LP Gas

Ambient Temp. Limits
-40°F To +205°F
-40°C To +96°C



MX-325-3-1/2

PART No.	Inlet Connection	Outlet Connection	Inlet Pressure	Outlet Range	Set Pressure	Vent Limiting Device
MX-325-3-1/2	1/2 FPT	1/2 FPT	2 P.S.I.	7" - 11" w.c.	7" w.c.	MX-12A09 (Included)
MX-325-5A-3/4	3/4 FPT	3/4 FPT	2 P.S.I.	7" - 11" w.c.	7" w.c.	MX-12A39 (Included)

Canadian Specifications Listed Below:

PART No.	Inlet Connection	Outlet Connection	Inlet Pressure	Outlet Range	Set Pressure	Vent Limiting Device
MX-325-3-1/2	1/2 FPT	1/2 FPT	10 P.S.I.	4" - 12" w.c.	7" w.c.	MX-12A09 (Included)
MX-325-5A-3/4	3/4 FPT	3/4 FPT	10 P.S.I.	4" - 12" w.c.	7" w.c.	MX-12A39 (Included)

2 PSIG LINE PRESSURE REGULATORS

CSA DESIGN CERTIFIED Z21.80 - CSA 6.22

The MX-325 (L) Series regulators are of a high performance type - reducing pounds pressure to a level within the appliance's operating supply range. The line regulator is located upstream of equipment already fitted with an appliance regulator.

Maximum Individual Load: Largest single appliance served by the regulator.

MX-325-3L-1/2	140,000 Btu/hr
MX-325-5AL-3/4	300,000 Btu/hr
MX-325-5AL-1	300,000 Btu/hr

Gases: Natural or LP Gas

Maximum Load Capacity: Total load of all appliances combined.

MX-325-3L-1/2	250,000 Btu/hr
MX-325-5AL-3/4	425,000 Btu/hr
MX-325-5AL-1	425,000 Btu/hr (USA)
MX-325-5AL-1	550,000 Btu/hr (CDN)

Gases: Natural or LP Gas

Ambient Temp. Limits
-40°F To +205°F
-40°C To +96°C



MX-325-5AL

PART No.	Inlet Connection	Outlet Connection	Inlet Pressure	Outlet Range	Set Pressure	Vent Limiting Device
MX-325-3L-1/2	1/2 FPT	1/2 FPT	2 P.S.I.	7" - 11" w.c.	7" w.c.	MX-12A09 (Included)
MX-325-5AL-3/4	3/4 FPT	3/4 FPT	2 P.S.I.	7" - 11" w.c.	7" w.c.	MX-12A39 (Included)

GAS~FLO 3/8" NATURAL GAS / PROPANE GAS OUTLETS



NGO-3HT
With Hanger
Tab

Overall
Dimensions of NGO-3
OUTLET COVER
measures:
6-1/4" H x 3-1/2" W x 2-1/2" D

PART No.: NGO-3 (Stainless Steel Cover)

- STAINLESS STEEL OUTLET COVER.
- 3/8 C.S.A. CONVENIENCE OUTLET (VALVE WITH COUPLER).
- APPLIANCE ATTACHMENT (NIPPLE).
- OUTLET DUST PLUG.

**THERMAL PROTECTION DEVICE
SHUTS OFF FLOW OF GAS AT +250°F, +121°C**

Natural Gas CSA Rated 75,000 BTU/H @ .6" wc Pressure Drop.
Propane Gas CSA Rated 100,000 BTU/H @ .6" wc Pressure Drop.



NGO-3

NGO-2

Overall Dimensions of NGO-2
OUTLET COVER measures:
5-3/4" H x 3-1/2" W x 2-1/2" D

PART No.: NGO-2 (ABS Cover)

- U.V. / SHOCK RESISTANT ABS OUTLET COVER.
- 3/8 C.S.A. CONVENIENCE OUTLET (VALVE WITH COUPLER).
- APPLIANCE ATTACHMENT (NIPPLE).
- OUTLET DUST PLUG.
- STANDOFF SPACERS.
- MOUNTING BRACKET.

**THERMAL PROTECTION
DEVICE SHUTS OFF FLOW
OF GAS AT +250°F, +121°C**

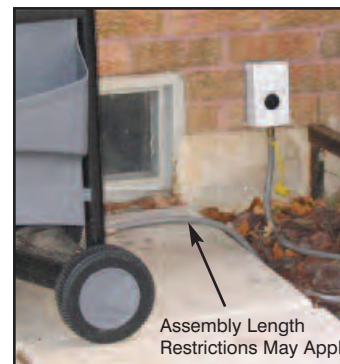

Natural Gas CSA Rated 75,000 BTU/H @ .6" wc Pressure Drop.
Propane Gas CSA Rated 100,000 BTU/H @ .6" wc Pressure Drop.



PART No.	Description
NGO-2	Gas Outlet with White ABS Housing
NGO-2HT	White - With Hanger Tab Rack Package

Barbecue Assemblies Sold Separately See Page 130

CAUTION: Gas Outlets are to be installed by Licensed Gas fitters only.

GAS-FLO 1/2" NATURAL GAS / PROPANE GAS OUTLETS



Lockable Cover

PART No.: NGO-4 (Stainless Steel Flip Front Cover)

- HEAVY DUTY 20 GAUGE STAINLESS STEEL OUTLET COVER.
- 1/2" C.S.A. CERTIFIED BRASS BALL VALVES.
- **GAS-FLO** BRAND 1/2" QUICK DISCONNECT COUPLERS.
- BRASS ADAPTERS. (Includes Q.D. Nipple for Assembly)
- OUTLET DUST PLUGS.
- STANDOFF SPACERS.
- LOCKABLE.
- WEATHER RESISTANT CAUTION LABEL.



Natural Gas CSA Rated 120,000 BTU/H @ .3" w.c. Pressure Drop.
Propane Gas CSA Rated 187,500 BTU/H @ .3" w.c. Pressure Drop.

PART No.: NGO-4

Overall Dimensions of EASY ACCESS OUTLET COVER measures: 6" H x 5-1/4" W x 3" D

PART No.	Description
NGO-4	Gas Outlet 1/2" with Stainless Cover
NGO-4NB	Gas Outlet 1/2" Only - No Cover

2 LB. System Gas Outlets



PART No.: NGO-2LB (Stainless Steel Flip Top Cover) 2LB GAS OUTLET

- HEAVY DUTY 20 GAUGE STAINLESS STEEL OUTLET COVER.
- BRASS ADAPTERS.
- 3/8 C.S.A. CONVENIENCE OUTLET (VALVE WITH COUPLER).
- APPLIANCE ATTACHMENT (NIPPLE) AND DUST PLUG.
- WEATHER RESISTANT CAUTION LABEL.
- 2 LB. TO 7" WATER COLUMN GAS REGULATOR.

Overall Dimensions of EASY ACCESS OUTLET COVER measures: 6" H x 5-1/4" W x 3" D

PART No.: NGO-2LB-ABS (ABS Plastic Flip Up Cover)

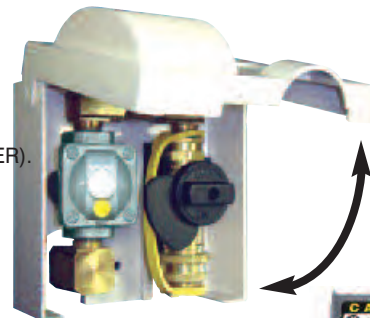

Overall Dimensions of EASY ACCESS OUTLET COVER measures: 5-1/2" H x 5-1/2" W x 3-3/4" D



BALL VALVE STYLE
Overall Dimensions of OUTLET COVER measures: 7-1/4" H x 4" W x 3-1/8" D

PART No.	Description
NGO-2LB	2lb SS Flip Top Cover 3/8" Q.D. Connection
NGO-2LB-ABS	2lb ABS Plastic Flip Up Cover 3/8" Q.D. Connection
NG-OUTLET-2LB	2lb SS Cover Ball Valve Style - 3/8 Q.D. Connection
NG-OUTLET-2LBW	2lb SS White Painted Cover Ball Valve Style - 3/8 Q.D.
NGO-4-2LB	2lb SS Gas Outlet with 1/2" Q.D. Connection

PART No.: NG-OUTLET-2LBW

- C.S.A. APPROVED BRASS BALL VALVE.
- **GAS-FLO** BRAND 3/8" Q.D. COUPLER.

The 2 Lb. Gas System is Governed by the Authorities having Jurisdiction. Users of the 2 Lb. Gas Outlet should consult Applicable Provincial / State and Municipal Laws and Regulations

GAS~FLO DUAL NATURAL GAS / PROPANE GAS OUTLETS WITH 3/8" and 1/2" QUICK DISCONNECT COUPLERS

2 LB. System Gas Box



PART No.: NGO-5-2LB

Overall Dimensions of OUTLET COVER measures: 8-1/4" H x 9" W x 2-3/4" D

- HEAVY DUTY 20 GAUGE STAINLESS STEEL OUTLET COVER.
- C.S.A. CERTIFIED BRASS BALL VALVES.
- **GAS~FLO** BRAND 3/8 & 1/2 QUICK DISCONNECT COUPLERS.
- BRASS ADAPTERS.
- BACK MOUNT ONLY.
- OUTLET DUST PLUGS.
- STANDOFF SPACERS.
- LOCKABLE.
- WEATHER RESISTANT CAUTION LABEL.



PART No.: NGO-5

Overall Dimensions of OUTLET COVER measures: 8-1/4" H x 9" W x 2-3/4" D

Part No.	Description
NGO-5	Dual Outlet (3/8 & 1/2 Quick Disconnect Connector)
NGO-5-2LB	Dual Outlet 2LB. System (3/8 & 1/2 Q D Connector)

GAS~FLO DUAL NATURAL GAS / PROPANE GAS OUTLETS WITH 3/8" QUICK DISCONNECT COUPLERS

2 LB. System Gas Box



PART No.: NG-OUTLET-2LB-DUAL-L

Overall Dimensions of OUTLET COVER measures: 8-1/4" H x 9" W x 2-3/4" D

- HEAVY DUTY 20 GAUGE STAINLESS STEEL OUTLET COVER.
- C.S.A. CERTIFIED BRASS BALL VALVES.
- **GAS~FLO** BRAND 3/8 QUICK DISCONNECT COUPLERS.
- BRASS ADAPTERS.
- BACK MOUNT ONLY.
- OUTLET DUST PLUGS.
- STANDOFF SPACERS.
- LOCKABLE.
- WEATHER RESISTANT CAUTION LABEL.



Right sided mount available

PART No.: NG-OUTLET-DUAL

Overall Dimensions of OUTLET COVER measures: 7-1/4" H x 4" W x 3-1/8" D



* Uses NG-BOX



PART No.	Description
NG-OUTLET-DUAL	Dual Outlet with Stainless cover.
NG-OUTLET-2LB-DUAL-L	Dual Outlet 2LB. system. (Left Mount) 3/8 QD
NG-OUTLET-2LB-DUAL-R	Dual Outlet 2LB. system. (Right Mount) 3/8 QD

*** The 2 Lb. Gas System is Governed by the Authorities having Jurisdiction. Users of the 2 Lb. Gas Outlet should consult Applicable Provincial / State and Municipal Laws and Regulations**

GAS ALARM SYSTEM FOR BOATS, RVs AND MOTORHOMES

PART No.	12 VOLT SYSTEMS	STYLE
PGD-4F*	Gas Alarm System (COMES WITH ONE REMOTE SENSOR)	Flush Mount Style
PGD-4S*	Gas Alarm System (COMES WITH ONE REMOTE SENSOR)	Surface Mount Style
PGD-GS	Optional Gas Sensor With Cable	For PGD-4 & PGD-5 series
PGD-NS-NC	Gas Sensor No Sensor No Cable	For PGD-4 & PGD-5 series
PGD-6	Gas Alarm	Self contained unit
SV-S121	Electronically Activated Solenoid (see below)	Must be used in conjunction with PGD-4 series

* PGD-4 Series warn audibly, visually and shut down the source of gas supply until the problem vapor leakage is found and fixed. They are ideal for use on boats, RVs, motor homes and anywhere gas leaks pose a threat to public safety.

PART No.	Designed For Use With
PGD-4F	Solenoid & one or two sensors.
PGD-4S	Solenoid & one or two sensors.
PGD-6	Self contained unit.



PGD-4S



PGD-6



PGD-GS Optional second sensor.

PROPANE / NATURAL GAS CONTROL



An electric control valve for use with LP-gas or natural gas at working pressure up to 250 P.S.I. A large orifice allows adequate flow of both liquid and vapor LP-gas. 1.1 amp nominal draw on 12 volts D.C. Inlet and outlet are female pipe threads. U.L. Listed.



1/4" inlet and outlet..... Wt. 0.7 Lbs.

PART No.	Description
SV-S121	12 Volt D.C. Solenoid Valve Normally Closed

HOUSEHOLD C/O DETECTOR / ALARM



CO Detectors monitor and detect carbon monoxide gas. They measure the concentration and sound an alarm when a potentially harmful level is reached.

PART No.	Description	Type
CMD-9CO5	Carbon Monoxide Detector	Batteries (Included)

The TracPipe® fuel gas piping system consists of corrugated, semi-rigid stainless steel tube with brass mechanical attachment fittings, terminating in male pipe fittings for easy attachment to traditional black iron pipe systems and direct connections to gas appliances.

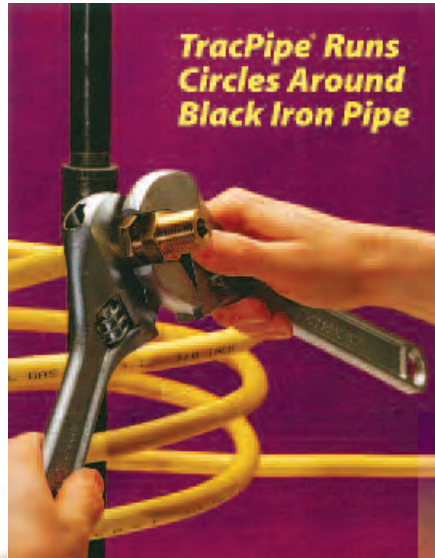

Autoflare links all the benefits of TracPipe® to traditional gas fittings and appliances and does it with no special tools - none to buy, none to lose, none to size. Pull two wrenches, a utility knife and a standard tube cutter out of your tool box, and you have all you need to connect Autoflare fittings to TracPipe®.



TracPipe® is a flexible stainless steel piping material used for natural gas and propane installations. It's superior corrugated tube plus a polyethylene non-chlorinated jacket combine to make an unbeatable product. It's available up to 2" sizes and is packaged on reels for easy use and less waste. TracPipe® along with Autoflare brass fittings, multi-port manifolds, pressure regulators, shut-off valves and striker plates provide everything you need for a complete installation. Cost - effective and reliable - TracPipe® is the ideal system for new construction, and retrofit projects.

PART No.	Description	Pipe Size	Nominal I.D.	Jacket O.D.	EHD* Size	Pkg. Qty.
CSST-6-250	Flexible Piping CSST	3/8"	.440	.668	15	250 ft /Reel
CSST-8-100	Flexible Piping CSST	1/2"	.597	.868	19	100 ft /Coil
CSST-8-250	Flexible Piping CSST	1/2"	.597	.868	19	250 ft /Reel
CSST-12-100	Flexible Piping CSST	3/4"	.820	1.108	25	100 ft /Coil
CSST-12-250	Flexible Piping CSST	3/4"	.820	1.108	25	250 ft /Reel
CSST-16-100	Flexible Piping CSST	1"	1.040	1.380	31	100 ft /Reel
CSST-16-180	Flexible Piping CSST	1"	1.040	1.380	31	180 ft /Reel
CSST-20-150	Flexible Piping CSST	1-1/4"	1.290	1.665	37	150 ft /Reel

Larger Sizes Available on Request.



UNDER GROUND PIPING

Polyethylene Sleeve

PART No.	Description	Pipe Size	Nominal I.D.	Jacket O.D.	EHD* Size	Pkg. Qty.
CSST-UGP-8-250	Flexible Piping CSST	1/2"	.597	.868	19	250 ft /Reel
CSST-UGP-12-250	Flexible Piping CSST	3/4"	.820	1.108	25	250 ft /Reel
CSST-UGP-16-100	Flexible Piping CSST	1"	1.040	1.380	31	100 ft /Reel

*EHD (Effective Hydraulic Diameter) A relative measure of Flow Capacity. This number is used to compare individual sizes between different manufacturers. The higher the EHD the greater the flow capacity of the piping. TracPipe® is AGA/CGA certified to 5 PSIG, 10 PSIG, and 125 PSIG, where provincial codes apply.

AUTOFLARE FITTINGS

Autoflare links all the benefits of TracPipe® to traditional gas fittings and appliances. Autoflare is self-flaring and easy to use. It is self-piloting and the joint seals with normal wrenching pressure for safe, gas-tight connections. AutoFlare fittings assemble without special tools offering faster installations with lighter, easier to handle materials.

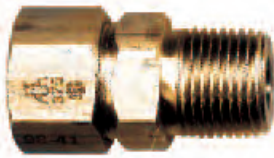

STRAIGHT MECHANICAL FITTINGS			
PART No.	Description	NPT Size	Pkg. Qty.
AF48-6C	AutoFlare M Straight 3/8"	3/8"	24/Box
AF48-6D	AutoFlare M Straight 3/8"	1/2"	24/Box
AF48-8D	AutoFlare M Straight 1/2"	1/2"	24/Box
AF48-12D	AutoFlare M Straight 3/4"	1/2"	16/Box
AF48-12E	AutoFlare M Straight 3/4"	3/4"	16/Box
AF48-16E	AutoFlare M Straight 1"	3/4"	16/Box
AF48-16H	AutoFlare M Straight 1"	1"	16/Box
AF48-20J	Auto Flare M Straight 1-1/4"	1-1/4"	16/Box
AF48-24K	AutoFlare M Straight 1-1/2"	1-1/2"	16/Box

SPARE SPLIT RINGS			
PART No.	Description	TracPipe® Size	Pkg. Qty.
AF60-6-10	Spare Split Rings	3/8"	10
AF60-8-10	Spare Split Rings	1/2"	10
AF60-12-10	Spare Split Rings	3/4"	10
AF60-16-10	Spare Split Rings	1"	10
AF60-20-4	Spare Split Rings	1-1/4"	4

Larger Sizes Available on Request.

Underground AutoFlare fitting with a plastic containment coupling and a 1/4" MPT vent port. Assembles without special tools.



STRAIGHT MECHANICAL UNDER GROUND FITTINGS			
PART No.	Description	NPT Size	Pkg. Qty.
AF48-UGF-6C	AutoFlare M Straight 3/8"	3/8"	24/Box
AF48-UGF-8D	AutoFlare M Straight 1/2"	1/2"	24/Box
AF48-UGF-12E	AutoFlare M Straight 3/4"	3/4"	16/Box
AF48-UGF-16H	Auto Flare M Straight 1"	1"	16/Box
AF48-UGF-20J	AutoFlare M Straight 1-1/4"	1-1/4"	16/Box
AF48-UGF-24K	AutoFlare M Straight 1-1/2"	1-1/2"	16/Box
AF48-UGF-32M	AutoFlare M Straight 2"	2"	16/Box



COATED MULTI-PORT MANIFOLDS					
PART No.	Description	Inlet	Ports	Outlets	Pkg. Qty.
AF679-ED4	4 Port Manifold	3/4"	1/2"	1/2"	1
AF679-JHE4	4 Port Manifold	1-1/4"	1"	3/4"	1

AUTOFLARE FITTINGS

Flange mount straight and 90° elbows are ideally suited for termination of gas lines near movable appliances and at utility meters on building exteriors.



FLANGE MOUNT FITTINGS			
PART No.	Description	NPT Size	Pkg. Qty.
AFFKB-6D	Flange Fitting 3/8"	1/2"	12/Box
AFFKB-8D	Flange Fitting 1/2"	1/2"	12/Box
AFFKB-12E	Flange Fitting 3/4"	3/4"	8/Box
AFFKB-16H	Flange Fitting 1"	1"	8/Box
AFFKB-20J	Flange Fitting 1-1/4"	1-1/4"	4/Box
AF-LMB	"L" Mounting Bracket	1/2" TO 1"	1/Box

90° FLANGE MOUNT FITTINGS			
PART No.	Description	NPT Size	Pkg. Qty.
AFFK90-6D	90° Flange Fitting 3/8"	1/2"	1
AFFK90-8D	90° Flange Fitting 1/2"	1/2"	1



BRASS UNION TEE FITTINGS			
PART No.	Description	Size	Pkg. Qty.
AF44-8	Tee Fitting 1/2"	1/2"	1
AF44-12	Tee Fitting 3/4"	3/4"	1
AF44R-128	Tee Reducing	3/4" To 1/2"	1
AF44-16	Tee Fitting 1"	1"	1



BRASS COUPLINGS			
PART No.	Description	Size	Pkg. Qty.
AF42-6	Union Coupling	3/8"	1
AF42-8	Union Coupling	1/2"	1
AF42-12	Union Coupling	3/4"	1
AF42-16	Union Coupling	1"	1
AF42-20	Union Coupling	1-1/4"	1

Larger Sizes Available on Request.

AUTOFLARE ACCESSORIES

TRACPIPE® ACCESSORIES Striker plates provide protection where flexible piping passes through studs, joists and other building materials.

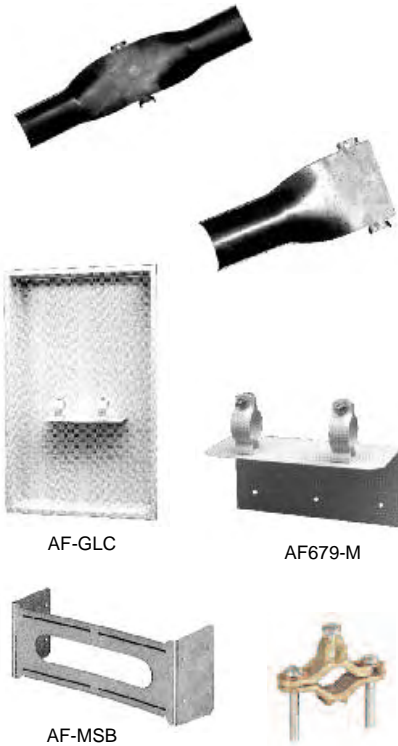

CARBON STEEL STRIKER PLATES			
PART No.	Description	Size	Pkg. Qty.
AFSP-1	Full Striker Plate	3" x 12"	1
AFSP-2	Half Striker Plate	3" x 7"	1
AFSP-4	Quarter Striker Plate	3" x 2"	1

ACCESSORIES		
PART No.	Description	Qty.
AF-GLC	Gas Load Center	1
AF-MSB	Meter Stud Bracket	1
AF679-MB	Manifold Mounting Bracket	1

CLAMPS				
PART No.	Description	TP	Iron Pipe	Qty.
AFGC-1	Ground Clamp	3/8", 1/2", 3/4"	1/2", 3/4"	1
AFGC-2	Ground Clamp	1", 1-1/4"	1-1/4", 1-1/2", 2"	1
AFGC-3	Ground Clamp	1-1/2", 2"	2-1/2" - 4"	1

TYPICAL APPLICATION

- | | | | | | | | |
|---------------------------|------------------------------------|---|--|---|------------------------------------|--|---------------------------------|
| 1. | 2. | 3. | 4. | 5. | 6. | 7. | 8. |
| CSST
Tube
PAGE: 213 | AF679-ED4
Manifold
PAGE: 214 | Black Iron
Fittings
PAGE: 21 - 23 | BV5221 Series
Ball Valve
PAGE: 163 | AF48 Series
Autoflare
Fittings
PAGE: 214 | 2 P.S.I.
Regulator
PAGE: 208 | BV2103 Series
Ball Valve
PAGE: 163 | Gas Load
Center
PAGE: 216 |

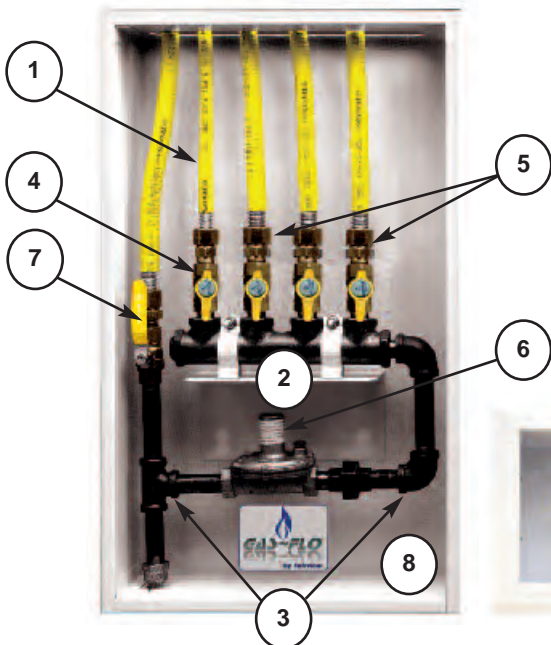

The Fairview Manifold offers easy installation for gas supply lines. Used in conjunction with copper tube, poly-coated tube, or TracPipe® flexible gas piping, it provides the homeowner with a top quality gas supply system. This sample display shown below has one ball valve which can be used to shut off the main gas supply to the whole system. The individual supply lines can be installed with ball valves so the homeowner can shut off the gas supply to each appliance with ease. Ideally suited for new housing, renovations and retrofits.

METAL WALL BOXES		
PART No.	DESCRIPTION	QTY.
AF-WALLBOX-D	1/2" OUTLET BOX	1
AFWALLBOX-E	3/4 OUTLET BOX	1

POLYETHYLENE PIPING AND TUBE



Constructed from PE 2406 (yellow) Polyethylene which meets ASTM D 1248 and D 3350 for PE 2406 material. They are C.S.A certified for use with vapor propane and natural gas.

The coils are held together by plastic straps which are of different lengths to enable short lengths to be released as required. The pipe or tube is marked every two feet showing the amount of footage remaining on the coil.

S.D.R. (STANDARD DIMENSIONAL RATIO)

S.D.R. represents the pipe O.D. divided by the wall thickness.

NOTE: Pipe is always referenced to its SDR number while tube is always referenced to its wall thickness.

Example: 2" IPS has a 2.375" pipe O.D.
 2" IPS has a 0.216" wall
 $2.375 / 0.216 \text{ wall} = \text{SDR11}$

PART No.	Nominal PIPE SIZE	SDR	WALL	FEET PER COIL	PIPE O.D.	AVG. PIPE I.D.	POUNDS PER FOOT
PF-361-10-.090	1/2" CTS (NTS)	7.0	0.090 (2.29 mm)	984	0.625	0.439	0.06
PF-361-18-.099	1" CTS (NTS)	11.5	0.099 (2.50 mm)	492	1.125	0.919	0.14
PF-361-18-.099-98	1" CTS (NTS)	11.5	0.099 (2.50 mm)	98	1.125	0.919	0.14
PF-362-E-SDR11	3/4" IPS (NPS)	11.0	0.095 (2.41 mm)	492	1.050	0.848	0.12
PF-362-E-SDR11-98	3/4" IPS (NPS)	11.0	0.095 (2.41 mm)	98	1.050	0.848	0.12
PF-362-H-SDR11	1" IPS (NPS)	11.0	0.119 (3.04 mm)	492	1.315	1.061	0.19
PF-362-H-SDR11-98	1" IPS (NPS)	11.0	0.119 (3.04 mm)	98	1.315	1.061	0.19
PF-362-J-SDR10	1-1/4" IPS (NPS)	9.3	0.166 (4.22 mm)	492	1.660	1.308	0.34
PF-362-J-SDR10-98	1-1/4" IPS (NPS)	9.3	0.166 (4.22 mm)	98	1.660	1.308	0.34
PF-362-M-SDR11	2" IPS (NPS)	11.0	0.216 (5.48 mm)	492	2.375	1.917	0.63
PF-362-S-SDR11-40	4" IPS (NPS)	11.0	0.216 (5.48 mm)	40	2.375	1.917	0.63

Larger Sizes Available on Request.



TRACER TAPE:

The message "CAUTION GAS LINE BURIED BELOW" has been boldly labeled on this yellow and silver metallic warning tape. We recommend you bury it 6 to 10 inches below ground level and above the PE gas line. You will find this warning tape, with its 2 inch width, easier to locate than wire with most standard metal detectors.

*For best results bury as Close to Surface as Possible.
 Put maximum distance between tape and line being detected.*

PART No.	DESCRIPTION
PF-MTYG-21	METALLIC WARNING TRACER TAPE (1000 FT. ROLL X 2")
PF-TW-REEL	METALLIC TRACER WIRE (984 FT. REEL)



From Main To Meter only Elster Perfection has developed a complete mechanical polyethylene gas distribution system for installing a main-to-meter gas service. This family of easy-to-install products incorporates our Permasert couplings and allows you to make fast and safe piping connections without the use of special tools or expensive equipment. Complementing the wide variety of couplings, we offer anodeless service line risers, PermaLock® Mechanical Tapping Tees, PSV™ polyethylene shut-off valves, and Perfection excess flow valve. Each of these products features Permasert coupling outlets and are available in a broad range of sizes.

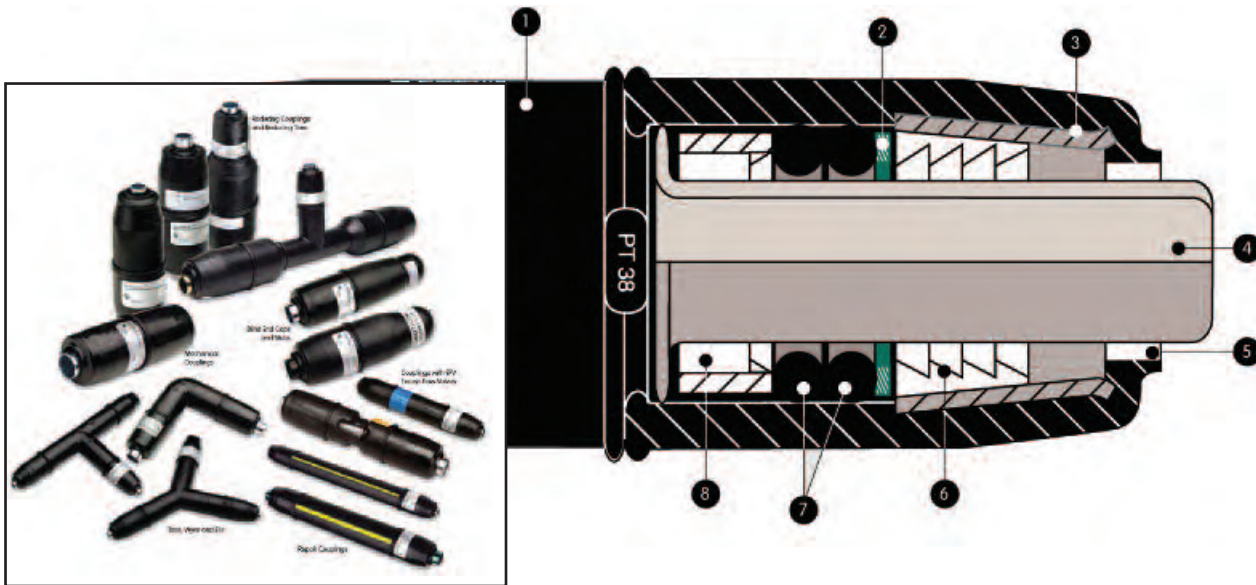



COUPLINGS: For joining two same diameters tube or pipe sizes.

PART No.	SIZE	SDR / Wall	Material
PF-50100	1/2" CTS	.090"	PE4710 / PE3408
PF-50030	3/4" IPS	SDR11	PE4710 / PE3408
PF-50103	1" CTS	.099" / .103"	PE4710 / PE3408
PF-50601	1" IPS	SDR11	PE4710 / PE3408
PF-50035010	1-1/4" IPS	SDR 9.3/10	PE4710 / PE3408
PF-50361	1-1/2" IPS	SDR11	PE4710 / PE3408
PF-50314	2" IPS	SDR11	PE4710 / PE3408



REDUCING COUPLINGS: For joining two different diameter tube or pipe sizes.

PART No.	SIZE	SDR / Wall	SIZE	SDR / Wall	Material
PF-50969	1/2" CTS	.090"	3/4" IPS	SDR11	PE4710 / PE3408
PF-51432	1" IPS	SDR11	3/4" IPS	SDR11	PE4710 / PE3408
PF-50343	1-1/4" IPS	SDR 9.3	1" IPS	SDR11	PE4710 / PE3408
PF-50333010	1-1/4" IPS	SDR 9.3	2" IPS	SDR11	PE4710 / PE3408

REPAIR COUPLINGS:

In the event the tube or pipe has been damaged you can save 50 to 75% repair time compared to using old fashion methods. Simply snip out the damaged area, clean and chamfer the tube or pipe, stab the repair coupling on both ends, test for leaks - the job is complete.



PART No.	SIZE	SDR / Wall	OVERALL LENGTH	Material
PF-50640	1" IPS	SDR11	12" LONG	PE4710 / PE3408

BLIND END CAPS: (CUT OFF END)

This Blind End Cap is for closing the end of a service line with the ability to open the service line at a later time. When service is to be extended, simply cut along the clearly marked dotted line on the capped end and stab the new gas line into the mechanical coupling.



PART No.	SIZE	SDR / Wall	Material
PF-50033	1-1/4" IPS	SDR 9.3	PE4710 / PE3408
PF-50317	2" IPS	SDR11	PE4710 / PE3408



COPPERSERT™ COPPER to PE TRANSITION COUPLING

PART No.	SIZE	SDR / Wall	Copper Size	Material
PF-41013	1/2" CTS	.090"	1/2" O.D.	PE4710 / PE3408

TRANSITION FITTINGS:

Provide a quick solution for transition from iron pipe to polyethylene pipe or tube.



PART No.	DESCRIPTION	SIZE	SDR/ Wall	Material
PF-700205	Transition, Threaded	3/4" IPS x 1/2" CTS	.090"	2306 / 2406
PF-700802	Transition, Threaded	3/4" IPS	SDR 11	2306 / 2406

ELBOWS: To be use where tight 90 degree turns are required.



PART No.	SIZE	SDR / Wall	Material
PF-50636	1" IPS	SDR11	PE4710 / PE3408
PF-50325010	1-1/4" IPS	SDR 9.3	PE4710 / PE3408

THREE WAY TEES: To branch off to same size tube or pipe.



PART No.	SIZE	SDR / Wall	Material
PF-50199	1/2" CTS	.090"	PE4710 / PE3408
PF-50929	3/4" IPS	SDR11	PE4710 / PE3408
PF-50292	1" CTS	.099" / .103"	PE4710 / PE3408
PF-50634	1" IPS	SDR11	PE4710 / PE3408
PF-50327010	1-1/4" IPS	SDR 9.3	PE4710 / PE3408
PF-50316	2" IPS	SDR11	PE4710 / PE3408

REDUCING TEES: To branch off to a reduced tube or pipe size.



PART No.	SIZE	SDR/ Wall	SIZE	SDR/ Wall	SIZE	SDR/ Wall	Material
PF-50461	3/4" IPS	SDR11	3/4" IPS	SDR11	1/2" CTS	.090"	PE4710 / PE3408
PF-50451	1" CTS	.099"/.103"	1" CTS	.099"/.103"	1/2" CTS	.090"	PE4710 / PE3408
PF-50328100	1-1/4" IPS	SDR 9.3	1-1/4" IPS	SDR10	1" CTS	.099"/.103"	PE4710 / PE3408
PF-51323100	2" IPS	SDR11	2" IPS	SDR11	1-1/4" IPS	SDR9.3	PE4710 / PE3408



MECHANICAL TAPPING TEES:

The exclusive Perfection PermaLock Mechanical Tapping Tee provides a simple gas-tight, non-heat fusion polyethylene service line connection on new and existing polyethylene mains. It actually uses the inside diameter of the main itself to create a permanent gas-tight seal. The tee can be installed in as little as five minutes using only a socket set and two Allen wrenches regardless of weather conditions. There are no special tools, heating or auxiliary power requirements. There is no need to shut down the main during installation. Here's how the Perfection PermaLock Mechanical Tapping Tee uses the inside diameter of the main to achieve a permanent gas-tight seal: as the valve assembly is threaded into the tee tower it punches the main and drives the locking flange of the valve assembly through the punched hole; when the valve is threaded upward the tee is securely locked and sealed onto the main by the retaining flange on the valve assembly; the Perfection PermaLock Mechanical Tapping Tee is now permanently locked onto the main.

MECHANICAL TAPPING TEES:

PART No.	MAIN SIZE	PERMASERT OUTLET	SDR / Wall	CUTTER	Material
PF-55951	2" IPS	1" IPS	SDR11	.80 CUT	PE4710 / PE3408



ANODELESS RISERS:

(PERMASERT MECHANICAL END)

Perfection risers provide extra safety due to the strong schedule 40 steel pipe used as the outside casing. Because of the factory installed epoxy coating the risers do not require cathodic protection devices to ward off underground corrosion.

Each riser is tested to withstand a minimum of 150 P.S.I. and meet D.O.T. regulation 192 for residential and commercial L.P. or natural gas service.

The above ground portion has an N.P.T. end for convenient connections to a fitting, meter or regulator. There is a unique pressure seal which locks the PE tube / pipe on the inside of the riser giving the strength to allow a pull to destruction test.

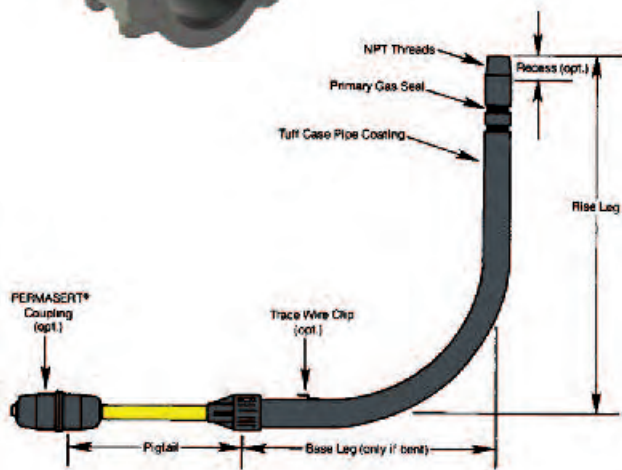

The underground portion comes with a threaded moisture seal for protection along with the factory installed PERMASERT coupling.

* Special lengths, shapes, seals and fusion connections are available upon request.

ANODELESS RISERS: (PERMASERT MECHANICAL END)

PART No.	STEEL PIPE CONNECTION	PERMASERT COUPLING	SDR / Wall	VERTICAL	HORIZONTAL
PF-77205	1/2" IPS	1/2" CTS	.090"	18"	18"
PF-77253	1/2" IPS	1/2" CTS	.090"	30"	24"
PF-77181	3/4" IPS	1/2" CTS	.090"	30"	24"
PF-79354	3/4" IPS	3/4" IPS	SDR11	30"	24"
PF-77120	3/4" IPS	1" CTS	.099" / .103"	30"	24"
PF-79350	1" IPS	1" IPS	SDR11	30"	24"
PF-75901	1-1/4" IPS	1-1/4" IPS	SDR 9.3	30"	24"
PF-79784	1-1/2" IPS	1-1/2" IPS	SDR 11	32"	29"
PF-75906	2" IPS	2" IPS	SDR11	30"	15"



SERVI-SERT (ALL-FLEX LP GAS RISER)

Our fully approved Servi-Sert All-Flex riser kits are available in 84" lengths for first-stage regulator tank side and 36" lengths for second-stage regulator house side. Sold in kit form, as required by NFPA-58, these risers feature pull-out proof, third-party design certified Servi-Sert service heads, and PVC sunlight resistant coated steel flex that meets crush strength requirements. They are lined with a plastic centering device that provides an annular insulation air space, and a moisture seal permanently affixed to the end of the riser provides moisture, corrosion and shear control.

FLEXIBLE ANODELESS Servi-Sert® - Field Assembled All-Fle
(With liners and swivel connector/union)

PART No.	OUTLET	INLET	SDR / Wall	OVERALL LENGTH
PF-71353	1/2" IPS	1/2" CTS	.090"	84"
PF-71354	1/2" IPS	1/2" CTS	.090"	36"
PF-71410	3/4" IPS	3/4" IPS	SDR 11	36"
PF-71411	3/4" IPS	3/4" IPS	SDR 11	60"
PF-71412	3/4" IPS	3/4" IPS	SDR 11	84"



ANODELESS SERVI-SERT FIELD-ASSEMBLED RISERS (with liners)*

The Perfection Servi-Sert Riser gives permanent security in a top connected anodeless riser suitable for both new construction and insertion renewals. The one-piece Servi-Sert Fitting contains components which grip permanently and seal independently of each other. The Servi-Sert Riser is available in flexible and pre-bent styles to meet any application requirements. All it takes for permanent leakproof connection is insertion of the PE gas tube to the proper stab depth, according to our printed instructions, and a simple turn of a wrench. No more worries about proper torque requirements for temperature and plastic pipe density variations. Our unique metal-flex joint protects against separations. Simply chamfer, mark and stab in the pipe, turn the wrench, and forget it.

No ordinary top-connected riser can match Servi-Sert for safety and ease of installation. Meets or exceeds all applicable ASTM, ANSI, and D.O.T. requirements (ASTM D 2513, ANSI B1.20, ANSI B31.8, and D.O.T. 192.)

STUB-FLEX W/ LINERS (Centering Sleeves)

PART No.	OUTLET	INLET	SDR/Wall	NIPPLE	FLEX
PF-71731	1" IPS	1" IPS	SDR 11	18"	36"

* Comply with NFPA-58, (Check Local Jurisdictions) and CAN/CGA-B149.2-10



GALVANIZED RISER with SERVICE HEAD ADAPTER

Fast and easy installation with no special tools. **Used in after meter applications (pool heaters and auxiliary buildings).** Meet or exceed the requirements of ASTM D-2513 category 1, ANSI B 1.20, ANSI B 31.8, US DOT part 192 and CSA B137.4

PART No.	OUTLET	INLET	SDR/WALL	Vertical / Horizontal	GALVANIZED CASING (Included)	SERVICE HEAD ADAPTER (Included)
PF-74059-KIT	1" NPT	1" CTS	.099"/.103"	24" V X 31" H	PF-74059	PF-71151
PF-74059			.099"/.103"	24" V X 31" H	Casing Only	
PF-71151	1" NPT	1-1/4" FPT				Adapter Only



BRACKETS:

The Remote Meter Support Systems, Wall Brackets and Universal Brackets are constructed of 11 - gauge hot rolled commercial quality steel for corrosion-proof above and below ground use. They are coated in a thin film of gray epoxy. Even the washers, bolts and nuts are cadmium plated. All parts are packaged for easy storage and handling.



PART No.	SIZE	DESCRIPTION	Nominal BUILDING OFFSET
PF-74506 PF-74500	3/4" - 2" IPS	Wall Brackets	4" 6" 9"
PF-74440	3/4" - 2" IPS	Universal Mount Bracket Kit	Adjustable

CHAMFERING TOOLS:

Used for cutting a bevel on the end of the PE tube for easier insertion of permasert fittings. They work with the same principal as the old fashion pencil sharpener. You will note the chamfering tools for the 1/2" size have dual ends so one tool fits two different sizes of tube.

PLASTIC CUTTERS:(SNIPPERS)

There are two types, the simple scissor type for tube sizes 1/2" to 1". The super snippers ratchet type for tube up to 2" IPS. Both cutters can be used for various pipe or tube, they make clean cuts producing no particles which may clog orifices.



PART No.	DESCRIPTION	SIZE
PF-51005	CHAMFERING TOOL	1/2" CTS X 1" CTS
PF-51016	CHAMFERING TOOL	1/2" CTS X 3/4" IPS
PF-51009	CHAMFERING TOOL	1" IPS X 3/4" IPS
PF-51028	CHAMFERING TOOL	1-1/4" IPS X 1-1/4" CTS
PF-51040	CHAMFERING TOOL	2" IPS
PF-55225	PLASTIC CUTTER (Replaces PF-55190)	1/8" TO 1-1/4" CTS PE
PF-55227	PLASTIC CUTTER (Replaces PF-55291)	1/8" TO 2" IPS PE

DIELECTRIC UNIONS:

Dielectric Unions are used in commercial and residential applications to prevent accelerated corrosion and deterioration in the piping system due to galvanic and stray current. It is installed between pipes made from dissimilar metals, and features a female iron pipe thread to female brass pipe thread connection. It consists of a union nut, two tailpieces, and a gasket that separates the tailpieces to prevent an electric current from occurring. Ideal in applications such as hot water storage tanks, water and air conditioners, processing tanks, steam, gas, and water piping. Maximum Pressure: 250psi.



PART No.	DESCRIPTION	SIZE
PF-DU-104-E	DIELECTRIC UNION FPT X FPT	3/4
PF-DU-104-H	DIELECTRIC UNION FPT X FPT	1

Cut the tube so that the end is square.



Use a soft felt-tip pen, crayon or grease pencil to mark the stab depth as indicated on your Permasert package instructions. The stab depth is the approximate distance from the edge of the fusionbead to the end of the fitting body.



Wipe with a clean dry cloth. Inspect for scratches or gouges. If any, cut again so that the last 2 to 6 inch section, depending on size, has no surface defects.

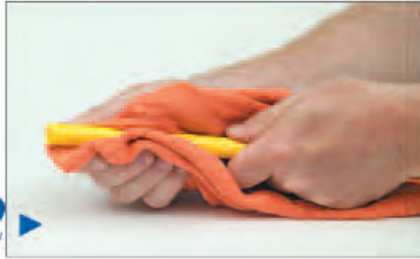

Stab the tube into the Permasert fitting so that the stab depth mark is visible within 1/8" of the end of the fitting on 1/2" and 1" CTS sizes, within 1/4" on all other sizes through 1-1/4" CTS, and approximately 3/8" on the 1-1/4" and 2" IPS sizes. The tube must bottom out in the fitting. Pressure test the joint in accordance with your standard procedures. The reference mark can move outward up to an additional 3/8" during pressure testing.



Use the Perfection chamfering tool for a proper O.D. chamfer. This chamfer permits the tube to be completely stabbed without affecting the internal seals.



Polyethylene Pipe and Tube (PE 2406/Yellow) Line Sizing Chart for LP Gas vapor

Line sizing for LP gas vapor between 1st and 2nd stage regulators allowing a pressure drop of 1 psi at 10 psi setting.

Tube Length (ft)'	1/2" CTS SDR 7 (.090")	3/4" IPS SDR11(.095")	1" CTS SDR 11.5(.099")	1" IPS SDR 11(.119")	1-1/4" IPS SDR 10 (.166")	2" IPS SDR 11(.216")
Maximum LP Gas vapor Capacity (thousands of Btu/hr)						
10	1406	8940	10803	16486	28912	82488
20	944	6001	7252	11067	19409	55373
30	747	4753	5744	8766	15372	43858
40	634	4029	4868	7429	13029	37171
50	557	3544	4282	6535	11460	32695
60	502	3191	3856	5884	10319	29441
70	459	2920	3529	5385	9444	26944
80	425	2704	3268	4987	8746	24953
90	397	2527	3054	4661	8173	23319
100	374	2379	2874	4387	7693	21948
125	329	2092	2528	3858	6766	19305
150	296	1884	2277	3474	6093	17384
175	271	1724	2084	3180	5576	15909
200	251	1597	1930	2945	5164	14733
225	235	1492	1803	2752	4826	13768
250	221	1405	1697	2590	4542	12959
275	209	1330	1607	2452	4300	12268
300	199	1265	1528	2332	4090	11669
350	182	1157	1399	2134	3743	10680
400	169	1072	1295	1976	3467	9890

*Total length of piping from outlet of first stage regulator to inlet of farthest second stage regulator.

Note: Polyethylene pipe/tube shall be limited to vapor service not exceeding 30 psig, and must be installed outdoors and underground.

The above numbers were calculated by using the Mueller formula for high pressure installations of smooth pipe such as plastic, copper, brass, etc. carrying gas at pressures greater than 1 psig.

NATURAL GAS SIZING TABLES FOR PE PIPE



Maximum Capacity in Cubic Feet per Hour Natural Gas For Schedule 40 Pipe and Plastic Pipe, including Fittings.
Gas Pressure: 7 in. w.c. Pressure Drop: 0.5 in w.c.

Pipe Length, ft	Pipe Size								
	1/2"	3/4"	1"	1-1/4"	1-1/2"	2"	2-1/2"	3"	4"
10	156	326	614	1,261	1,890	3,639	5,800	10,253	20,914
20	107	224	422	867	1,299	2,501	3,986	7,047	14,374
30	86	180	339	696	1,043	2,008	3,201	5,659	11,543
40	74	154	290	596	893	1,719	2,740	4,843	9,879
50	65	137	257	528	791	1,524	2,428	4,293	8,756
60	59	124	233	478	717	1,380	2,200	3,889	7,933
70	54	114	214	440	659	1,270	2,024	3,578	7,299
80	51	106	199	409	613	1,181	1,883	3,329	6,790
90	48	99	187	384	576	1,109	1,767	3,123	6,371
100	45	94	177	363	544	1,047	1,669	2,950	6,018
125	40	83	157	322	482	928	1,479	2,615	5,333
150	36	75	142	291	437	841	1,340	2,369	4,832
175	33	69	131	268	402	774	1,233	2,180	4,446
200	31	64	121	249	374	720	1,147	2,028	4,136
250	27	57	108	221	331	638	1,017	1,797	3,666
300	25	52	98	200	300	578	921	1,628	3,321
350	23	48	90	184	276	532	847	1,498	3,056
400	21	44	83	171	257	495	788	1,394	2,843
450	20	42	78	161	241	464	740	1,308	2,667
500	19	39	74	152	228	438	699	1,235	2,519
600	17	36	67	138	206	397	633	1,119	2,283
700	16	33	62	127	190	365	582	1,030	2,100
800	15	30	57	118	177	340	542	958	1,954
900	14	29	54	111	166	319	508	899	1,833
1000	13	27	51	104	156	301	480	849	1,732
1200	12	24	46	95	142	273	435	769	1,569
1400	11	23	42	87	130	251	400	708	1,443
1600	10	21	39	81	121	234	372	658	1,343
1800	9	20	37	76	114	219	349	618	1,260
2000	9	19	35	72	108	207	330	583	1,190

This information is provided by Fairview Fittings & Manufacturing for reference only. Gas systems are governed by authorities having local jurisdiction and are subject to applicable Provincial \ State and Municipal Laws and Regulations. This document should not be substituted for the judgement of a professional engineer. The user of this information assumes all risk associated with its use.

Gas Pressure: 7-14 in. w.c. Pressure Drop: 1.0 in w.c.

Pipe Length, ft	Pipe Size								
	1/2"	3/4"	1"	1-1/4"	1-1/2"	2"	2-1/2"	3"	4"
10	227	474	894	1,835	2,749	5,295	8,439	14,919	30,429
20	156	326	614	1,261	1,890	3,639	5,800	10,253	20,914
30	125	262	493	1,013	1,517	2,922	4,658	8,234	16,795
40	107	224	422	867	1,299	2,501	3,986	7,047	14,374
50	95	199	374	768	1,151	2,217	3,533	6,246	12,739
60	86	180	339	696	1,043	2,008	3,201	5,659	11,543
70	79	166	312	640	959	1,848	2,945	5,206	10,619
80	74	154	290	596	893	1,719	2,740	4,843	9,879
90	69	145	272	559	837	1,613	2,571	4,544	9,269
100	65	137	257	528	791	1,524	2,428	4,293	8,756
125	58	121	228	468	701	1,350	2,152	3,805	7,760
150	52	110	207	424	635	1,223	1,950	3,447	7,031
175	48	101	190	390	584	1,126	1,794	3,171	6,469
200	45	94	177	363	544	1,047	1,669	2,950	6,018
250	40	83	157	322	482	928	1,479	2,615	5,333
300	36	75	142	291	437	841	1,340	2,369	4,832
350	33	69	131	268	402	774	1,233	2,180	4,446
400	31	64	121	249	374	720	1,147	2,028	4,136
450	29	61	114	234	351	675	1,076	1,903	3,881
500	27	57	108	221	331	638	1,017	1,797	3,666
600	25	52	98	200	300	578	921	1,628	3,321
700	23	48	90	184	276	532	847	1,498	3,056
800	21	44	83	171	257	495	788	1,394	2,843
900	20	42	78	161	241	464	740	1,308	2,667
1000	19	39	74	152	228	438	699	1,235	2,519
1200	17	36	67	138	206	397	633	1,119	2,283
1400	16	33	62	127	190	365	582	1,030	2,100
1600	15	30	57	118	177	340	542	958	1,954
1800	14	29	54	111	166	319	508	899	1,833
2000	13	27	51	104	156	301	480	849	1,732

This information is provided by Fairview Fittings & Manufacturing for reference only. Gas systems are governed by authorities having local jurisdiction and are subject to applicable Provincial \ State and Municipal Laws and Regulations. This document should not be substituted for the judgement of a professional engineer. The user of this information assumes all risk associated with its use.



GAS VENT FITTINGS AND PIPE

Rated for Flue Gas Temps. Up To and Including +65°C (+149°F)



Installation shall comply with the latest edition of CAN/CSA-B149.1 including supplements, the gas appliance manufacturer's installation instructions and local building codes, and shall be undertaken by qualified personnel.

GVF65 Gas venting system is classified as a Type BH Class A Venting System and is appropriate for use on appliances with flue Gas Temperatures up to and including +65°C (+149°F). The pipe is made to SCHEDULE 40 pipe dimensions. GVF90 to +95°C (+203°F)



* GVF65 Pipe and Fittings are white in color. GVF90 are grey.



PART No.	DESCRIPTION
90° ELBOW (white)	
GVF65-100-M	2" PVC -Fgv 90° Elbow
GVF65-100-P	3" PVC -Fgv 90° Elbow
GVF65-100-S	4" PVC -Fgv 90° Elbow
90° ELBOW LONG	
GVF65-100L-M	2" PVC - Fgv 90° Long Sweep Elbow
GVF65-100L-P	3" PVC - Fgv 90° Long Sweep Elbow
COUPLING	
GVF65-103-M	2" PVC - Fgv Coupling
GVF65-103-P	3" PVC - Fgv Coupling
GVF65-103-S	4" PVC - Fgv Coupling

PART No.	DESCRIPTION
45° ELBOW	
GVF65-105-M	2" PVC - Fgv 45° Elbow
GVF65-105-P	3" PVC - Fgv 45° Elbow
GVF65-105-S	4" PVC - Fgv 45° Elbow
REDUCER BUSHING	
GVF65-110-PM	2" X 3" PVC - Reducer Bushing
STREET ELBOW	
GVF65-116-P	3" PVC -Fgv 90° Elbow
INCREASER COUPLING	
GVF65-119-PM	3" X 2" PVC-Fgv Increaser Coupling



GAS VENT PIPE	
GVP65-S636-M	2" PVC Gas Vent Pipe
GVP65-S636-P	3" PVC Gas Vent Pipe
GVP65-S636-S	4" PVC Gas Vent Pipe



TERMINATION VENT SCREEN	
GV6590-TVS-M	2" Termination Vent Screens
GV6590-TVS-P	3" Termination Vent Screens



CEMENTS & PRIMERS	
GV65-CEMENT-500ML	PVC One Step Cement, Pint
GV-PRIMMER-500ML	PVC / CPVC Primer, Pint

TE-PRV-E
INTERNAL
PRESSURE RELIEF
VALVE
(OLD RX-A14500004)

RX-A16010008
SERVICE VALVE

2088
2089
CHECK CONNECTORS

RX-A17000000
FIXED LIQUID
LEVEL GAUGE

RX-A12000004
DOUBLE BACK
CHECK FILLER
VALVE

For our complete line of Cylinder Valves, ACME L.P.G. Adapters and Connectors see our Propane and Natural Gas Products Catalog or www.fairviewfittings.com

DOUBLE BACK CHECK FILLER VALVES



Series RX-A120 is designed to furnish fast filling of forklift, motor fuel and recreational vehicle tanks. Large hex lower body allows a socket to be used for easy installation. Quick filling capacity. One piece body minimizes leak potential. Cap and strap provided with each valve.



PART No.	Inlet Connection (IN.)	Outlet Connection (IN.)	Wrench Flats (IN.)
RX-A12000004	3/4"-14 NPT	1-3/4" ACME	1-3/4"

LIFT TRUCK CYLINDER RELIEF VALVE



Designed specifically for use as a primary relief valve on DOT forklift cylinders. All containers used in industrial truck service, including forklift truck cylinders, should have the relief valve replaced with a new or unused valve within 12 years of the manufacture date of the container and each 10 years thereafter. Can be used on cylinders up to 100 lbs. LP-Gas capacity.

PART No.	Inlet Connection (IN.)	Pressure Setting (PSIG)
TE-PRV-E	3/4" - 14 NPT	375

LIFT TRUCK AND ENGINE FUEL VALVE



DOT Forklift Service Valve

Designed to allow either vapor or liquid withdrawal. Integral excess flow valve helps prevent excess product loss in the event of fuel line rupture. Must be used in a cylinder with an independent pressure relief valve sufficient for cylinder's capacity. Stem design features a double O-Ring seal to provide extra protection from leakage. Extra low profile reduces potential for valve and handwheel damage when cylinders are stacked on each other.

PART No.	Inlet Connection (IN.)	Outlet Connection (IN.)	Excess Flow Valve	For Service Marked
RX-A16010008	3/4"-14 NPT	3/8-18" NPT	2.2 GPM	Liquid

FIXED LIQUID LEVEL GAUGES



Large knurled knob for easy gripping when wearing gloves. Knurled knob is retained to prevent dropping or lost plugs during fillings. Designed to provide a visible warning when containers are filled to the maximum permitted filling level.

PART No.	Inlet Connection (IN.)	Diptube Length (IN.)	Service
RX-A17000000	1/4" NPT	None	Cylinder

LIFT TRUCK BACK CHECK CONNECTORS



2088



2089



These quick closing couplings are designed to join the carburetion fuel line to the service valve on motor fuel type applications.

ACME thread allows quick hand-tight assembly. Back checks automatically close when disconnected. UL Listed

PART No.	Inlet Connection	Outlet Connection	Application
2089	3/8" FNPT	1-1/4" M ACME	Service Valve
2088	1-1/4" F ACME	1/4" FNPT	Fuel Line
2089-GASKET	Secondary Gasket Seal		
2089-OR	Primary Gasket Seal		

LIFT TRUCK TANKS DESIGNED FOR MOTOR FUEL USES ONLY

Features:



FOUR PORT (-4)	FIVE PORT (-5)
SERVICE VALVE COMPLETE WITH QUICK DISCONNECT SAFETY COUPLER.	SERVICE VALVE COMPLETE WITH QUICK DISCONNECT SAFETY COUPLER.
SAFETY RELIEF VALVE.	SAFETY RELIEF VALVE.
10% OUTAGE.	10% OUTAGE.
FILLER VALVE.	FILLER VALVE.
	PLUGGED VAPOR SERVICE OPENING.

ALUMINUM (STACKABLE)



PART No.	Propane Capacity Lbs.	Water Capacity Lbs.	Liquid or vapor	Full Empty Gauge	Approx. Height (IN.)	Approx. Dia. (IN.)	Tare Weight Lbs.
PTALT33-5	33-1/2	80	L	Universal	28-1/4	12-1/2	23.5

SAFETY CONNECTOR AND FAST FILL VALVE INCLUDED

TO ORDER WITHOUT FAST-FILL VALVE SUFFIX PART NUMBER WITH "B". EXAMPLE: PTALT33-5B

STEEL (STACKABLE)



PART No.	Propane Capacity Lbs.	Water Capacity Lbs.	Liquid or vapor	Full Empty Gauge	Approx. Height (IN.)	Approx. Dia. (IN.)	Tare Weight Lbs.
PTSLT33-4	33-1/2	80	L	Universal	28-1/4	12-1/2	34.5
PTSLT43-4	43-1/2	103.6	L	Universal	34-1/8	12-1/2	40

SAFETY CONNECTOR AND FAST FILL VALVE INCLUDED

TO ORDER WITHOUT FAST-FILL VALVE SUFFIX PART NUMBER WITH "B". EXAMPLE: PTSLT33-4B

PORTABLE L.P. TANKS (STEEL)

- CAMPING
- COOKING
- GAS GRILLS
- RECREATION VEHICLES
- HEATING AND COMMERCIAL-INDUSTRIAL APPLICATIONS

PART No.	Propane Capacity Lbs.	Water Capacity Lbs.	Liquid or vapor	Service Connection	Approx Height (IN.)	Approx Dia. (IN.)	Tare Weight Lbs.
PTS5-1OPD	4-1/4	10.2	V	1-5/16 M Acme & F.POL	10-7/8	9-1/4	10-1/2
PTS10-1OPD	11	26.2	V	1-5/16 M Acme & F.POL	16-3/4	9-1/4	13-1/4
PTS20-1OPD	20	47.7	V	1-5/16 M Acme & F.POL	17-5/8	12-3/8	18
PTS30-1OPD	30	71.5	V	1-5/16 M Acme & F.POL	23-3/4	12-3/8	25-1/2
PTS40-1OPD	40	95.3	V	1-5/16 M Acme & F.POL	29-7/16	12-3/8	29-1/4



PART No.
PLUG-POL

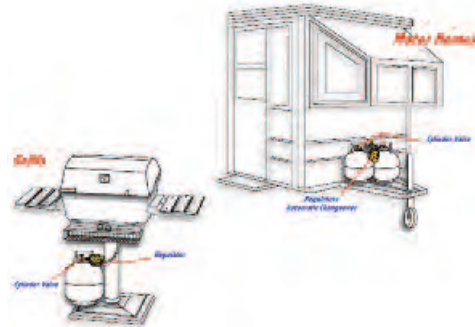

PART No.
2081

HEATING - COOKING - INDUSTRIAL L.P. TANKS (STEEL)

PART No.	Propane Capacity Lbs.	Water Capacity Lbs.	Liquid or vapor	Service Connection	Approx Height (IN.)	Approx Dia. (IN.)	Tare Weight Lbs.
PTS60-1	60	142.8	V	Female POL	41-13/16	12-3/16	48
PTS100-1	100	240	V	Female POL	50-3/8	14-3/4	77
PTS420-1FG	420	1000	V	Female POL	58-1/4	30	315



SUFFIX	DESCRIPTION
-1	With Fixed Liquid Level Gauge
FG	Float Gauge
M	Multi-Purpose Valve

RECREATIONAL VEHICLE TANK PANS

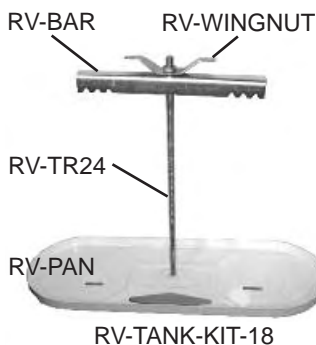

PART No.	DESCRIPTION
RV-TANK-KIT-18	Kit for 20 LB. Tanks
RV-TANK-KIT-24	Kit for 30 LB. Tanks
RV-TR24	Threaded Bar for 30 LB.
RV-BAR	Top Hold Down Bar
RV-PAN	Double Tank Pan
RV-WINGNUT	Galvanized Wingnut



PART No.
GR-9984-U

PART No.
I4C18MI4QCCP2

For Complete Packages with Hose Assemblies and R.V. Regulators. See Page: 202

TOOLS & ACCESSORIES



**WHAT'S NEW
IN THIS SECTION**

- Brass Air VentPg 238

AIR CONTROL PRESSURE REGULATOR232

AIR GUNS AND WANDS239

AIR VENTS AND MUFFLERS238

BEND PROTECTORS248

FIFTH WHEEL SLIDER CYLINDER232

FLARING TOOLS244

GAUGING DRILLS237

GREASE PRODUCTS240

HOSE CUT-OFF BLADES248

HOSE CRIMPER AND DIES - HYDRAULIC246

HOSE CRIMPER - MANUAL FERRULE246

HOSE SWAGING MACHINES AND DIES - SYNIFLEX247

HOSE SWAGE TOOLS - SEWER HOSE ENDS247

HYDRONIC PRESSURE TEST KIT242

NOZZLES (WATER)241

NYLON SLEEVE HOSE PROTECTOR248

PEX TOOLS & ACCESSORIES242

PINCERS243

ROTO REEL243

SOLENOID VALVES232

SPRING GUARDS248

THREAD GAUGES243

THREAD SEALANTS245

TORCHES (PROPANE)233 - 236

TUBE AND HOSE CUTTERS243 - 244

TUBE BENDERS244

TUBE REAMER244

UNIVERSAL JOINT SWIVELS243

AIR SHIFT SOLENOIDS

Note: Must Be Mounted In Upright Position.

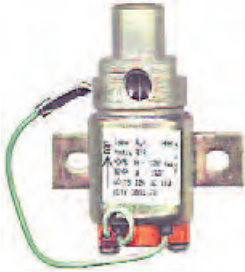

- 2 Ports - 1/4 Female NPT
- 1 Vent
- 0 - 120 P.S.I.
- 12 Volt D.C.
- Electrically Actuated

PART No.
SV-120B12V

Description
NORMALLY CLOSED

3 WAY DIRECTIONAL CONTROL



- 3 Ports - 1/4 Female NPT
- 0 - 100 P.S.I.
- 12 Volt D.C.
- Electrically Actuated

PART No.
SV-100B12V3C
SV-100B12V3O

Description
NORMALLY CLOSED
NORMALLY OPEN

AIR CONTROL PRESSURE REGULATORS



- 2 Ports - 1/4 NPT
- Gauge Ports 1/8 NPT
- Regulating Pressure 5-125 PSIG
- 13 SCFM Flow
- Max. Inlet Pressure 250 PSIG
- Relieving Type
- Standard Knob

PART No.
R16-02-000

Description
Pressure Regulator



- 2 Ports - 3/8 NPT
- Gauge Ports 1/4 NPT
- Regulating Pressure 5-125 PSIG
- 130 SCFM Flow
- Max. Inlet Pressure 200 PSIG
- Relieving Type
- Standard Knob

PART No.
R16-03-000

Description
Pressure Regulator

FIFTH WHEEL SLIDER KIT



PART No. FWSK-1

Designed for use on sliding fifth wheels, this kit includes most everything you need to complete the connections.

Kit Includes:

- 120" Length of 1/4" O.D. S.A.E. - J844-A coiled air tube.
- 360° Brass working male pipe swivels each end.
- Spring guard hose end protectors.
- 90° Brass adapter elbow.
- Frame mounting terminal bolt.

PART No. FWSK-2

Same as above with Push-To-Connect style connections.

AIR SEAT GUN SPLICER KIT



PART No. ASGK-1

Simply splice the air seat line with the push-to-connect tee end of the assembly. This handy kit features an industrial air gun for cleaning out the cab on site.

Kit Includes:

- 120" Length of 1/4" O.D. S.A.E. J844-A coiled air tube.
- One 360° Brass working male pipe swivel.
- Two spring guard hose end protectors.
- Push-to-connect splicer tee. (No Tools required)
- Chrome plated, lever handle air gun.

For assembly only see page 99

FIFTH WHEEL SLIDER CYLINDER



PART No. FW-CYLINDER-1

- Port Size: 1/4" NPT
- Shaft Size: 5/8" Diameter
- Clevis Hole: 17/32"
- Retracted Length: 12.75"
- Extended Length: 19.25"
- Operating Pressure: 100 PSI
- Max. Operating Pressure: 125 PSI
- Stroke: 6.5"

PROPANE TORCHES



PART No.: T95-B

CONSTRUCTION:

Cast Iron Head, Single Barber Jet with Flash Protection, Steel Stem. Neoprene Hand Grip and Needle Valve

BTU RATING: 208,000 BTU @ 30lbs. P.S.I

LENGTH: 28 inches



PART No.: T445

CONSTRUCTION:

Copper Bronze Head, Single Barber Jet with Flash Protection, Steel Stem. Neoprene Hand Grip and Needle Valve.

BTU RATING: 208,000 BTU @ 30lbs. P.S.I

LENGTH: 16 inches



PART No.: W80

CONSTRUCTION:

Cast Iron Head, Brass Valve, Orifice and Bushings. 1/2" Std. Pipe Manifold with Comfort Hand Grip

BTU RATING: 220,000 BTU @ 30lbs. P.S.I

LENGTH: 26 inches



PART No.: ST3

CONSTRUCTION:

Welded Steel Heads, Brass Orifice, Needle Valve with Steel Stem and Non Slip Steel Handle

BTU RATING: 375,000 BTU @ 40lbs. P.S.I

LENGTH: 32 inches

FOR COMPLETE TORCH KITS AND OR TORCH ASSEMBLIES SEE PAGES 235 - 236 , 124

Safety Tips for Hand-held Torches.

Hand-held torches fuelled by 9.1-kg (20-lb) propane cylinders are used for many operations in the roofing industry, such as melting snow and ice, drying roof decks, and heat sealing.

- 1) Never leave torches ignited and unattended.
- 2) Make sure the cylinder is securely braced or tied so that it can't fall or be knocked over.
- 3) Use only approved high-pressure hoses to connect torches to regulators.
- 4) Operate the torch at the manufacturer's recommended pressure.
- 5) Never direct the flame at, near, or toward the cylinder.
- 6) Never use hand-held torches inside a building.



ROOFING TORCHES



PART No.: SE-PRT01

CONSTRUCTION:

Chromed Steel Head with Reinforced Lip, Chromed Stem with 40° Bend, E-Z Grip Handle with Pilot and Needle Valve with Trigger.

BTU RATING: 180,000 BTU @ 30 P.S.I.

LENGTH: 35 inches



PART No.: SE-PRT02

CONSTRUCTION:

Chromed Steel Anti-wind burner head with Reinforced Lip and Chromed Stem with 40° Bend. E-Z Grip Handle with Pilot and Needle Valve with Trigger.

BTU RATING: 200,000 BTU @ 60 P.S.I.

LENGTH: 21 inches

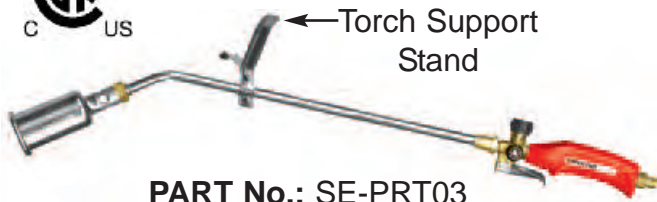

PART No.: SE-PRT03

CONSTRUCTION:

Chromed Steel Anti-wind burner head with Reinforced Lip and Chromed Stem with 40° Bend. E-Z Grip Handle with Pilot and Needle Valve with Trigger.

BTU RATING: 260,000 BTU @ 60 P.S.I.

LENGTH: 27 inches

ROOFING TORCH REPLACEMENT COMPONENTS

PART No.	Description
SE-BH03	Burner Head 2"
SE-EW24	Extension Wand 24"
SE-EW8	Extension Wand 8"
SE-THP01	Torch Handle w/Pilot
SE-TSS01	Torch Support Stand

The components listed above are for the SE-PRT series of torches.

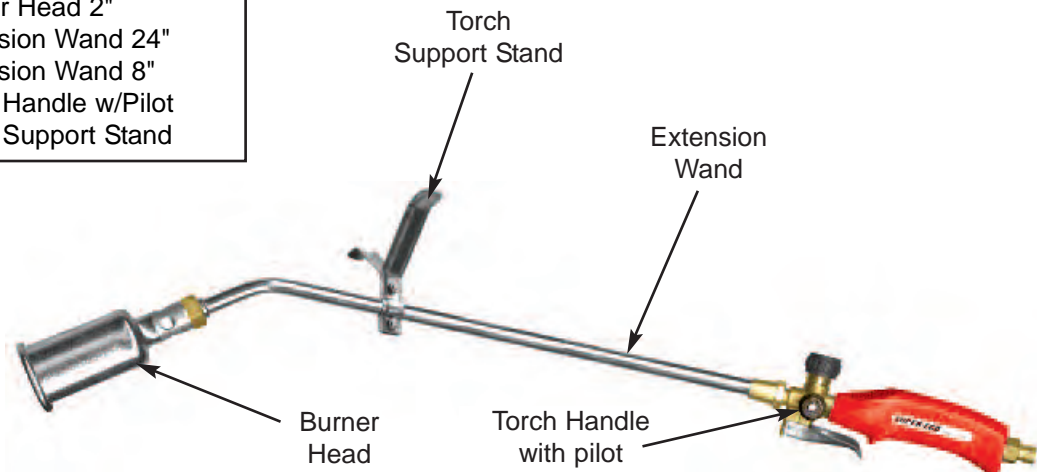

PROPANE TORCH KITS



PART No.
T95-B 28" OAL Torch

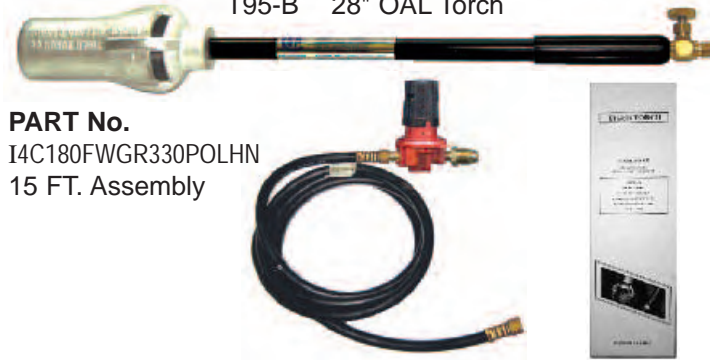

PART No.
I4C180FWGR330POLHN
15 FT. Assembly

PART No.: T95-B KIT

KIT CONTAINS:

QTY.	Item
1	Burner Torch (PART No. T95-B)
1	15 Ft. Type I Hose Assembly (PART No. I4C180FWFW)
1	Regulator & P.O.L. 0-30 PSI (PART No. GR-338)
1	Brass welding adapter (PART No. 135-LB)

• *Hose, Adapter & Regulator Fully Assembled and Ready for Service.*

• *Custom Configurations Available.*

PART No.
W80 26" OAL Torch



PART No.
I4C180FWGR330POLHN
15 FT. Assembly

PART No.: W80-KIT

KIT CONTAINS:

QTY.	Item
1	Burner Torch (PART No. W80)
1	5 Ft. Type I Hose Assembly (PART No. I4C180FWFW)
1	Regulator & P.O.L. 0-30 PSI (PART No. GR-338)
1	Brass welding adapter (PART No. 135-LB)

• *Hose, Adapter & Regulator Fully Assembled and Ready for Service.*

• *Custom Configurations Available.*

PART No.
*SE-PRT03 27" OAL Torch



PART No.: SE-PRT03 KIT

KIT CONTAINS:

QTY.	Item
1	Field Torch (PART No. SE-PRT03)*
1	25 Ft. Type I Hose Assembly (PART No. I4C300FWFW)
1	Regulator & P.O.L. 0-60 PSI (PART No. GR-368)
1	Brass welding adapter. (PART No. 135-LB)
1	Torch Stand
1	Flint Lighter

• *Hose, Adapter & Regulator Fully Assembled and Ready for Service.*

PART No.
*SE-PRT03 27" OAL Torch



PART No.
**SEPR02 21" OAL Torch

PART No.: SE-PRT04 KIT

KIT CONTAINS:

QTY.	Item
1	Field Torch (PART No. SE-PRT03)*
1	Detail Torch (PART No. SE-PRT02)**
1	25 Ft. Type I Hose Assembly (PART No. I4C300FWFW)
1	Regulator & P.O.L. 0-60 PSI (PART No. GR-368)
1	Brass welding adapter. (PART No. 135-LB)
1	Torch Stand
1	Flint Lighter

• *Hose, Adapter & Regulator Fully Assembled and Ready for Service.*



PROPANE TORCH KITS

PROPANE TORCH ASSEMBLIES COMPLETE WITH REGULATOR



PART No.	Actual I.D. (IN.)	Hose Length (FT)	Inlet Connection	Reg. Delivery Pressure Range (PSI)
I4C120FWGR330POLHN	1/4	10	Hard Nose POL	0-30 PSIG
I4C180FWGR330POLHN	1/4	15	Hard Nose POL	0-30 PSIG
I4C240FWGR330POLHN	1/4	20	Hard Nose POL	0-30 PSIG
I4C300FWGR330POLHN	1/4	25	Hard Nose POL	0-30 PSIG
I4C120FWGR360POLHN	1/4	10	Hard Nose POL	0-60 PSIG
I4C180FWGR360POLHN	1/4	15	Hard Nose POL	0-60 PSIG
I4C240FWGR360POLHN	1/4	20	Hard Nose POL	0-60 PSIG
I4C300FWGR360POLHN	1/4	25	Hard Nose POL	0-60 PSIG

Comes Assembled and Ready for Service.

Complete Kits Available on Page 235

PART No.	Assembly Components
135-LB	Outlet Bushing 9/16-18 L.H. x 1/4 MPT
2002-H-HN	Tailpiece Hard Nose P.O.L. To 1/4 MPT
I4C**FWFW	Type I Propane Hose (Specify Length)
GR-338	0-30 P.S.I. Regulator With HN P.O.L.
GR-368	0-60 P.S.I. Regulator With HN P.O.L.

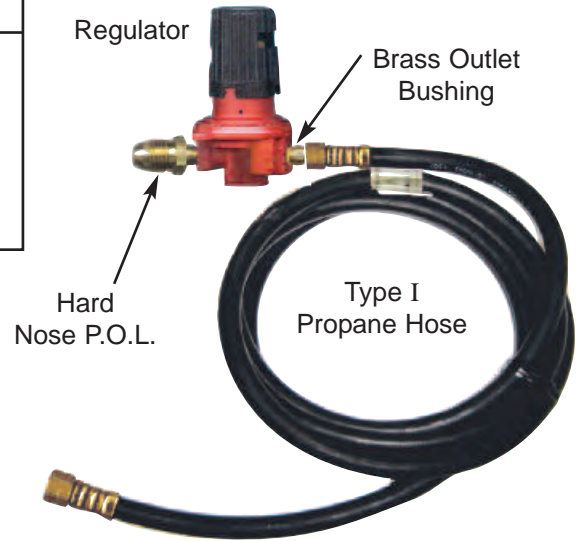

GR-330
0-30 P.S.I.
REGULATOR ONLY



GR-338

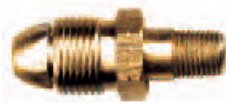

2002-H-HN
Hard Nose POL
Tailpiece Assembly



135-LB
Brass
Outlet Bushing



Female Welding
Connection
(9-16-18 LH Thread)

Type I Propane Hose
I4C120FWFW
(10 Feet Long)

Female Welding
Connection
(9-16-18 LH Thread)

For Torches: See Pages 233 - 234

DIFFERENT CONFIGURATIONS AVAILABLE.

GAS ORIFICE GAUGING DRILLS



DRILL AND HANDLE ARE PERMANENTLY BONDED
DRILL NUMBER IS STAMPED ON HANDLE



PART No.	DRILL SIZE	B.T.U. / HR. NATURAL (3.5)	B.T.U. / HR. NATURAL (7.0)	B.T.U. / HR. LP (11.0)
D40	0.0980	24384	34485	67087
D41	0.0960	23399	33092	64377
D43	0.0890	20111	28442	55331
D44	0.0860	18778	26557	51663
D47	0.0785	15646	22127	43045
D49	0.0730	13530	19135	37225
D50	0.0700	12441	17594	34228
D51	0.0670	11398	16119	31357
D52	0.0635	10238	14479	28167
D53	0.0595	8989	12712	24730
D54	0.0550	7680	10862	21131
D55	0.0520	6865	9709	18888
D56	0.0465	5490	7764	15104
D57	0.0430	4695	6639	12916
D58	0.0420	4479	6334	12322
D59	0.0410	4268	6036	11742
D60	0.0400	4062	5745	11176

PART No.	DRILL SIZE	B.T.U. / HR. NATURAL (3.5)	B.T.U. / HR. NATURAL (7.0)	B.T.U. / HR. LP (11.0)
D61	0.0390	3862	5461	10625
D62	0.0380	3666	5185	10087
D66	0.0330	2765	3910	7607
D67	0.0320	2600	3677	7153
D69	0.0292	2165	3062	5956
D70	0.0280	1991	2815	5476
D71	0.0260	1716	2427	4722
D72	0.0250	1587	2244	4366
D73	0.0240	1462	2068	4024
D74	0.0225	1285	1818	3536
D75	0.0210	1120	1583	3081
D76	0.0200	1016	1436	2794
D77	0.0180	823	1163	2263
D78	0.0160	650	919	1788
D79	0.0145	534	755	1469
D80	0.0135	463	654	1273

GAUGING DRILLS SETS

PART No.	Description
DS2	DRILL SET IN PLASTIC CASE Case With 42 Drills No's D40 Through D80
DS3	DRILL SET IN PLASTIC CASE Case With 42 Drills No's D19 Through D60
DS4	DRILL SET IN PLASTIC CASE Case With 21 Drills No's D19 Through D39
DS5	DRILL SET IN PLASTIC CASE Case With 21 Drills No's D60 Through D80
DS6	PLASTIC CASE Holds 42 Drills

DS2

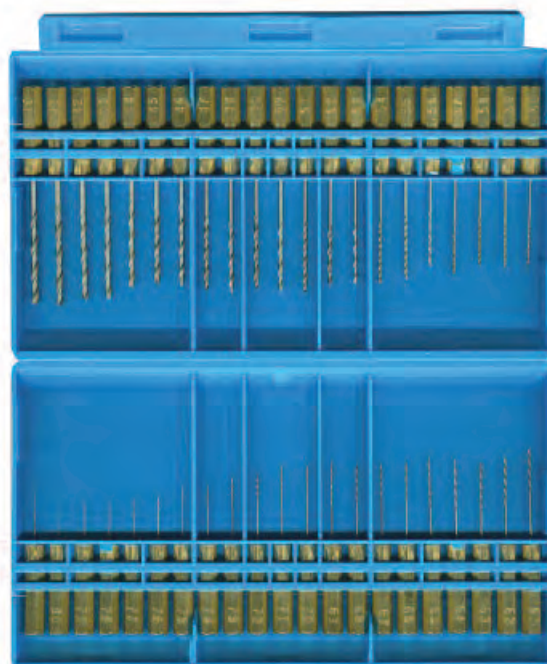

J

AIR VENTS AND MUFFLERS

Low profile breather vents used on single acting cylinders or valves to prevent dirt and foreign particles from entering ports open to the atmosphere. Also used for vacuum relief in pressure equalization of gear boxes, crank cases, storage tanks or reservoirs.



PART No.	Pipe
BBV-A	1/8
BBV-B	1/4
BBV-C	3/8
BBV-D	1/2

Maximum Operating Pressure: 300 P.S.I.
 Operating Temperature: +35°F to +300°F, +2°C to +149°C
 Sintered Bronze (40 micron)



PART No.	ORB
BBV-ORB-6	9/16 - 18
BBV-ORB-8	3/4 - 16

O-Ring Boss Thread
 Maximum Operating Pressure: 300 P.S.I.
 Operating Temperature: +35°F to +300°F, +2°C to +149°C
 Sintered Bronze (40 micron)

Exhaust mufflers utilize porous sintered bronze filter element secured to nickel plated pipe fittings. Used to diffuse air and muffle noise from the exhaust ports of air valves, air cylinders and air tools to an acceptable level within OSHA noise requirement. Also used as filters for gasoline, oil and air exhaust and intake.



PART No.	Pipe
BEM-A	1/8
BEM-B	1/4
BEM-C	3/8
BEM-D	1/2
BEM-E	3/4
BEM-10/32	10/32

Maximum Operating Pressure: 300 P.S.I.
 Operating Temperature: +35°F to +300°F, +2°C to +149°C
 Sintered bronze (40 micron)

Speed control mufflers provide an infinite variation of control of air flow at an acceptable sound level on exhaust ports of air valves with complete safety. The speed of an operating cylinder or air tool may be increased or decreased by adjusting the screw. Final position is then locked in place by the lock nut. Objectionable exhaust air noise is eliminated by the surrounding sleeve of sintered bronze.



PART No.	Pipe
BSCM-A	1/8
BSCM-B	1/4
BSCM-C	3/8
BSCM-D	1/2

Maximum Operating Pressure: 300 P.S.I.
 Operating Temperature: +35°F to +300°F, +2°C to +149°C
 Sintered Bronze (40 micron)

Brass Air Vent. Set screw has 10/32 national fine thread.



PART No.	Pipe
WH-705	1/8

Maximum Operating Pressure: 150 P.S.I.
 Operating Temperature: +35°F to +300°F, +2°C to +149°C

LEVER HANDLE TYPE WITH HOOK (O.S.H.A.)



PART No. **Female Pipe**
AG411E 1/4

- Meets O.S.H.A. Standards.
- Plastic Thumb Grip.
- Die Cast Construction.
- Individually Carded.

MAXIMUM PRESSURE IS 145 P.S.I.

TWO IN ONE AIR GUN



METAL TIP

PART No. **Female Pipe** **Wand Length**
AG411EW 1/4 6"

- Meets O.S.H.A. Standards.
- Removable Copper Wand for Optional Metal Tip Replacement.
- Die Cast Construction.
- Individually Bagged With Instructions.

MAXIMUM PRESSURE IS 145 P.S.I.

LEVER HANDLE TYPE WITH HOOK (RUBBER TIPPED)



PART No. **Female Pipe**
AG410R 1/4

- Heavy Duty Construction.
- Provides A Leak Proof Seal Between Gun and Air Line.
- Excellent For Blowing Out Cavities or Surfaces That Could Be Damaged or Scratched By Metal Tips.
- Die Cast Construction.
- Individually Carded.

MAXIMUM PRESSURE IS 145 P.S.I.

PISTOL GRIP TYPE WITH LOOP (ALL METAL CONSTRUCTION)



PART No. **Female Pipe**
AG164 1/4

- Aluminum Construction For Heavy Duty Services - Garages, Machine Shops and General Industry.
- Venturi Type Nozzle Increases Air Output By 10 Times.
- Cone Shaped Air Jet Minimizes Chip Blow Back.
- Brass Nozzle and Valve.
- Flow: 11CFM

HOSTAFORM MOLDED AIR GUNS

PISTOL GRIP TYPE WITH HOOK



PART No. **Female Pipe**
AG165 1/4

- Engineered to Remove Large Amounts of Chips; Also for Cooling and Drying.
- Venturi Type Nozzle Increases Air (Output) Volume by 10 Times.
- Cone Shaped Air Jet, Minimizes Chip Blow Back.
- Meets O.S.H.A. and WALSH-HEALEY Standards for Safety and Noise.
- Brass Nozzle, inlet and Valve.
- Flow: 11 CFM
- 150 P.S.I. Inlet

PISTOL GRIP TYPE WITH HOOK



PART No. **Female Pipe** **Wand Length**
AG166 1/4 4-1/4"

- Provides Narrow, High Velocity Jet of Air Into Blind Holes as Small as .200 and Hard to Reach Areas.
- Slender 4 1/4" Long Aluminum Nozzle.
- Infinitely Variable Output.
- Spark Proof.
- Meets O.S.H.A.
- Sound Level: 86
- Brass Inlet and Valve.
- Flow: 11 CFM
- 150 P.S.I. Inlet

SOFT NOSE AIR WANDS

PART No. **Female Pipe**
FA154SN 1/4

- This Soft Nose is Especially Designed for Use In Both Light and Medium Bench Work.
- It Is Super Sensitive, Easily Flexed, Quick To Respond To Finger Pressure and Has a Soft Cushion Tip Which Prevents Damaging of Delicate Surfaces; Also Avoiding Static Sparks.
- Full Impact of Air, If Needed For Production, Can Change Immediately to a Breath of Air For Close Up Work Depending Upon Finger Pressure Applied by Operator.
- Packaged Individually.



LEVER ACTION GREASE GUNS



GG-PROL

PART No.	Description	Maximum Pressure (PSI)	Loading	Delivery
GG-SDL	Standard Duty	6,000	14 oz. cartridge	1.0 oz / 40 strokes
GG-INDL	Industrial	10,000	14 oz. cart., bulk or suction	1.8 oz / 40 strokes
GG-PROL	Professional	10,000	14 oz. cart., bulk or suction	1.8 oz / 40 strokes

PISTOL GRIP GREASE GUNS



GG-PROPG

PART No.	Description	Maximum Pressure (PSI)	Loading	Delivery
GG-SDPG	Standard Duty (with 5' Pipe)	5,000	14 oz. cartridge or bulk	1 oz / 40 strokes
GG-PROPG	Professional (with 18" Flex Hose)	7,000	14 oz. cart., bulk or suction	1 oz / 40 strokes

GREASE WHIP COUPLER

4-Jaw steel coupler for use with rubber or nylon grease whip hose assemblies. Page: 106

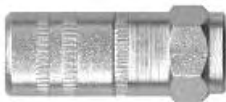

PART No.	Size
GWC-A	1/8"
C-GWC-A	Carded



For grease fittings and kits see page: 39



Removable Thread Protector

PART No. GHN
Zinc Pistol Grip Nozzle with metal lever, Zinc body. Threaded front for accessory attachment. Brass pull rod and nut. Sprays from a fine mist to heavy stream. Steel handle: Chrome plated. Tie on card / 10 pcs. per inner box. 100pcs. per outer carton.



PART No. GHNE
Zinc Pistol Grip Nozzle. Zinc body. Threaded front for accessory attachment. Chrome plated. Plastic outer case. Brass pull rod and nut. Tie on card / 10pcs. per inner box. 100pcs. per outer carton.

ADJUSTABLE WATER NOZZLES



PART No. GHN6
7 Pattern Zinc Turret Pistol Nozzle. Zinc body. Seven pattern spray turret. Brass pull rod and nut. Chrome plated. Tie on card / 12pcs. per inner box. 48pcs. per outer carton.



PART No. GHN10
Heavy Duty 10-Pattern Spray Gun. Zinc body. Aluminum spray head. Anodized. Built-in water shut-off and flow control. Ten pattern spray turret. Large handle controls spray. 6 1/2" W X 7" H. Tie on card / 6 pcs. per inner box. 12pcs. per outer carton.



PART No. GHN-BN
Zinc body. Adjustable brass plated aluminum tip. Insulated soft pistol grip steel handle. Brass pull rod and nut. Tie on card / 12pcs. per inner box. 48pcs. per outer carton.



PART No. GHFN
3 1/2" Mini Fireman's Nozzle. Metal construction Spray adjusts from extra-wide to blasting flow Small rubberized spray head. Anodized. Tie on card / 12pcs. per carton.



PART No. GHTN-RG
6" Adjustable Spray Nozzle with Brass Tip. Zinc body *Brass spray nozzle. Natural brasscolor. Tie on card / 10pcs. per inner box. 100pcs. per outer carton.

Water Hose Fittings and Accessories
See Pages: 30, 31

BRASS INDUSTRIAL WATER NOZZLES



PART No. GHTN
4" Brass Adjustable Twist Nozzle. Adjustable from mist to jet stream. Solid brass construction. Natural brasscolor. Tie on card / 12pcs. per inner box. 48pcs. per outer carton.



PART No. GHPS
2" Brass Hose Power Sprayer. Solid brass construction. Natural brass color. Tie on card, 12pcs. per inner box. 48pcs. per outer carton.

* Water Nozzle Models Change From Time To Time. May Not Be Exactly As Shown.

HYDRONIC PRESSURE TEST KIT

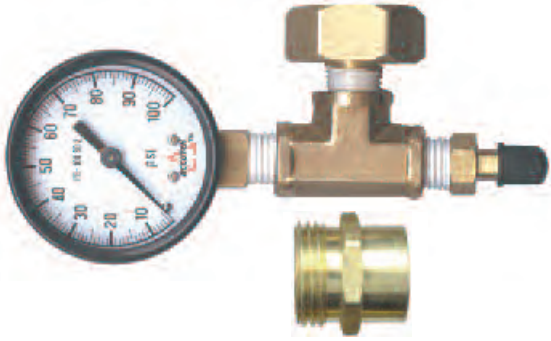

Fairview's Hydronic Pressure Test Kit is ideal for leak testing of radiant / hydronic heating systems. HPT-KIT-1 comes complete with a Male Water Thread x 3/4 Female NPT adapter for applications where this thread is required.

PART No.	Inlet	Outlet	Pressure Gauge
HPT-KIT-1	Schrader Valve	Female Swivel Boiler Drain Connection	0 - 100 (P.S.I.)

PEX CRIMP TOOL KIT



PART No.
HCPEX-RTC-KIT

14" Hand Crimp Tool Kit for Crimping Black Copper crimp Rings on 3/8, 1/2, 5/8 and 3/4 Pex. Includes replaceable jaws for all sizes and Go-No-Go gauge

PEX TOOLS



GO-NO-GO GAUGE

PART No.	Pex 3/8	Pex 1/2	Pex 3/4
HCPEX-GNG			



CRIMP RING REMOVING CUTTER

PART No.
HCPEX-CRC

For Removing Black Copper Rings

Pex Tip:
Always check your crimps.



ECONOMIC CLAMP TOOL

PART No.
HCPEX-RTE

Clamp Tool for Stainless Stepless Clamps



OETIKER CLAMP TOOL

PART No.
HCPEX-RT

Original OETIKER Tool for Stainless Stepless Clamps



PEX ANGLE CRIMP TOOL

PART No.
HCPEX-RTAC-10
HCPEX-RTAC-14

PEX Size
1/2
3/4

Compact & Angled for crimping Black Rings in tight spaces.

HAND-HELD HOSE CUTTER



PART No. SY-4523-04006 **O.D. Capacity** 1/2

SY-4523-04005 Replacement Blade

A handy tool for cutting hose 1/8 inch to 1/2 inch in diameter hose. Blades are replaceable. Vinyl cushioned grips.

SEPARATION TOOL



HOSE SEPARATION TOOL

PART No: SY-4574-01000

Designed for separating Twin-Line hose

MULTI-CUTTER



ALL METAL CONSTRUCTION

PART No. MC-1 **O.D. Capacity** 1-1/8
MCB-1 Replacement Blade

P.V.C. Coated Handles

WILL CUT: • RUBBER HOSE & PLASTIC TUBE

PEX MULTI-CUTTER



TUBE & PEX PIPE CUTTER

PART No. MCE-1

Spring Loaded & Lockable

ROTO REEL

PART No. RR12

Features:

- The easy way to reel off hose.
- Nominal load capacity is 1,000 LBS.
- Rotates on precision ground ball bearings.
- Made of metal for durability.
- Plated for rust resistance.
- Shipped preassembled.



PINCERS



PART No. HC9-R (Regular)
HC9-S (Side Jaw)

One of these handy tools is all that is needed to apply or remove O-Clamps. Side jaw pincer is recommended for work in confined areas, since it allows O-Clamp to be closed while holding pincer parallel to hose. See page 153 - 156 for O-Clamps.

360° UNIVERSAL SWIVEL



The universal swivel connects portable air tools to an air line. It improves maneuverability, minimizes operator fatigue and extends hose life.

- Swivels 360° at two pivot points allowing the air hose to drop directly to the floor while providing superb tool handling.

- New Lightweight, non-marking composite construction, industrial quality.

NOTE: DO NOT EXCEED 150 P.S.I. (10.3 Bar)



PART No. DS-B

Pipe 1/4

Air Flow Range Up to 33 C.F.M.

THREAD GAUGES



DELUXE THREAD GAUGE

PART No. TGI **Range** 4 TO 42 T.P.I.
(Threads Per Inch)

TGM .25 TO 2.50 MM
(Millimeters)



TUBE CUTTERS

TELESCOPIC TUBE CUTTER



PART No.	Capacity In.
TC-218	1/4 TO 1-3/8 O.D.
TCW-218	CUTTER WHEEL

- Professional quick-adjusting tube cutter and deburring tool for copper, brass, aluminum, and stainless steel tube.
- Easily retracting deburring tool stored in frame.
- Grooved rollers for close-to-flare cuts.
- Contoured knob stores spare cutter wheel.

STANDARD TUBE CUTTER



PART No.	Capacity In.
TC-412	1/4 TO 1-1/8 O.D.

- For accurate cutting of copper, brass, aluminum tube and thin wall conduit.
- Aluminum alloy body and sliding block.
- Groove rollers for close-to-flare cuts.
- Fold away reamer.
- Contoured knob stores spare cutter wheel.

MINI TUBE CUTTER



PART No.	Capacity In.
TC-413	1/8 TO 5/8 O.D.

- For accurate cutting of copper, brass, aluminum tube and thin wall conduit.
- Aluminum alloy body.
- Groove rollers for close-to-flare cuts.
- Fold away reamer.
- Contoured knob stores spare cutter wheel.

MECHANICAL TUBE BENDER



PART No.	Tube O.D.
T9-456 *	1/4, 5/16, 3/8
T9-8	1/2
T9-10	5/8

- * Will bend a combination of 3 sizes.
- Styles may vary depending on size.

Special design to bend soft copper, brass, aluminum and thin wall steel tube. A light and easy to handle bending tool which will permit bends on all planes.

NOTE: Tube must be in annealed state:
Will not bend hard-drawn material.

SPRING TYPE TUBE BENDER



PART No.	Capacity In.
T10-8	1/2
T10-10	5/8

This spring bender is used to bend soft copper tube by hand to avoid collapsing the tube.

TUBE REAMER

INTERNAL - EXTERNAL TUBE REAMER

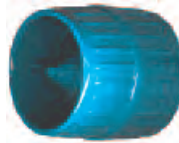

PART No.	Range
TR-1	1/4 I.D. TO 1-3/8 O.D.

Designed for use with metallic and non-metallic tube.

FLARING TOOLS

MANUAL ROTARY FLARING TOOL

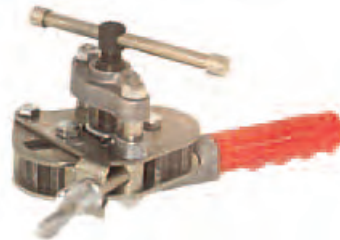

PART No.	Flare	Capacity In.
FT-645	45° S.A.E	1/8 O.D. TO 3/4 O.D.

- For aluminum and soft copper tube.
- Precision burnished 45° Flare with an easy turn of the handle.
- Depth gauge allows proper positioning of tube for correct flaring.

QUICK-OPENING FLARING TOOL



PART No.	Flare	Capacity In.
FT-411	45° S.A.E.	3/16 O.D. TO 5/8 O.D.
FT-412	45° S.A.E.	3/16 O.D. TO 3/4 O.D.

- For aluminum and soft copper tube.
- Bar has Quick-Opening feature with large wing nuts.
- Self Centering Yoke.
- Long bar for gripping in vise.

U.L. & U.L.C. LISTED PTFE THREAD SEALANT TAPE



The ideal sealant for pipe thread connections. It is non-toxic and will not contaminate fluids or gases. Chemically inert, it resists corrosive action of acids, alkalis and solvents. U.L. and U.L.C. listed for Natural Gas (TO 1000 P.S.I.) and Propane installations.

- **TEMPERATURE RANGE:** -450°F to +500°F, -268°C to +260°C

PART No.

121-M8UL
121-M12UL
121-M16UL

Tape Width

1/2"
3/4"
1"

Length/Roll (IN.)

236
236
236

PTFE THREAD SEALANT TAPE



The ideal sealant for pipe thread connections. It is non-toxic and will not contaminate fluids or gases. Chemically inert, it resists corrosive action of acids, alkalis and solvents.

- **TEMPERATURE RANGE:** -450°F to +500°F, -268°C to +260°C

INDUSTRIAL SEALANT TAPE

PART No.

121-M8
121-M12
121-M16

Tape Width

1/2"
3/4"
1"

Tape Thickness

.003
.003
.003

Length/Roll (IN.)

480
480
480

HIGH DENSITY INDUSTRIAL SEALANT TAPE

PART No.

121-M8PINK
121-M12PINK
121-M16PINK

Tape Width

1/2"
3/4"
1"

Tape Thickness

.004
.004
.004

Length/Roll (IN.)

540
540
540

METALLIC PTFE THREAD SEALANT



BRUSH TOP TIN



Masters Metallic Compound is a heavy duty pipe thread sealant of proven quality for use on both metal and plastic thread connections. This all-weather product: Lubricates during assembly - Never sets up hard - Can be easily disassembled even after years of service. Masters Metallic Compound is non-corrosive and prevents galling and seizing. It will not dry out or harden in the container. Available in plain and brush-top. Masters Metallic Compound effectively seals most liquids and gases against leakage up to 6000 p.s.i. and +700°F, +371°C.

PART No.

TTSM-8
TTSM-32

Size

8 oz. Tin
32 oz. Tin

Carton Qty.

25
6

PTFE THREAD SEALANT COMPOUND



BRUSH TOP TIN

- **TEMPERATURE RANGES:** -100°F to +500°F, -73°C to +260°C
- **BRUSHABLE TO:** -50°F, -46°C
- **PRESSURE RANGES:** GASES TO 2000 P.S.I. LIQUIDS TO 8000 P.S.I.
- **MATERIAL USE:** Copper, Brass, All Steel, Aluminum, ABS, PVC, and Fiberglass Piping
- **NOTE:** NOT SUITABLE FOR OXYGEN

TUBE



PART No.

TTS-2
TTS-4
TTS-8
TTS-16

Size

2 oz. Tube
4 oz. Tin
8 oz. Tin
16 oz. Tin

Carton Qty.

72
24
24
12

CSA CERTIFIED THREAD SEALANT COMPOUND



BRUSH TOP TIN

- **TEMPERATURE RANGES:** -50°F to +400°F, -45°C to +204°C
- **BRUSHABLE TO:** -50°F, -46°C
- **PRESSURE RANGES:** GASES TO 3000 P.S.I. LIQUIDS TO 6000 P.S.I.
- **MATERIAL USE:** all metal, plastic, PVC or Fiberglass, CPVC, and NYLON threads.
- **NOTE:** NOT SUITABLE FOR OXYGEN OR ABS THREADS. CERTIFIED TO CSA NO. 4-90 US AND CAN/ULC-S642-M87 METAL THREADS ONLY FOR USE WITH NATURAL, PROPANE & BUTANE GASES ONLY.

TUBE



PART No.

TTSG-2
TTSG-4
TTSG-8

Size

2 oz. Tube
4 oz. Tin
8 oz. Tin

Carton Qty.

72
24
24



HYDRAULIC HOSE CRIMPER



PART No. FF105

- **Capacity:** 1" for 2 spiral hose to 3/4" for 4 spiral hose.
- **Dimensions:** 12.5" W, 20" D and 19" H.
- **Weight:** 125 pounds.
- 1 HP 110V-15A pump for fast crimps.
- 35 Ton Hydraulic Cylinder.
- Fully adjustable to accommodate a wide range of different hose and fittings without the need for special shims or spacers
- Automatic shut off assures precise crimps time after time.
- Easily removable pusher and split dies make bent tube and special fittings easy to get into the crimper.
- The pneumatic remote switch can be operated anywhere with no electrical wires.

Comes complete with 8 Standard Numbered Die Sets



* Die Stand
Sold Separately
PART No.
P100D-DIE RACK

Die Set PART No.	Die Closed		Crimp Face	
	Dia. IN.	Dia. MM	Length IN.	Length MM
P100D-14	0.551	14	1.73	44
P100D-16	0.669	16	1.73	44
P100D-20	0.787	20	1.73	44
P100D-24	0.945	24	1.73	44
P100D-27	1.060	27	2.24	57
P100D-31	1.270	31	2.24	57
P100D-38	1.496	38	2.52	64

J660 FERRULE CRIMPER (FBL, FBS FERRULES)



PART No. J660 Crimper

DIE SETS SOLD SEPARATELY
TO ORDER STANDARD OR RIBBED
DIES PREFIX THE REQUIRED CRIMP
SIZE WITH:

"D" FOR STANDARD DIE OR
"R" FOR RIBBED DIE.

EXAMPLE: R-400, .400 RIBBED DIE SET

FERRULES ARE LISTED ON PAGE 58

THIS MANUALLY OPERATED CRIMPING
TOOL CRIMPS FBS AND FBL
FERRULES.

CRIMPS UP TO 1-1/2 INCH OUTSIDE
DIAMETER HOSE.

- BASE – 8"
- BODY – 7-3/8"
- HEIGHT – 27"
- WEIGHT – 29 LBS

Synflex® HOSE COUPLING SWAGING MACHINES AND TOOLS

Designed to Attach Synflex Permanent Couplings to Synflex Hose

- Synflex swaging equipment produces smooth, uniform coupling surfaces, without raised edges or ridges common in other coupling methods.
- Complete range of coupling swaging pushers and dies, up to -16 size are ordered separately.



**Portable Hand Swager
SST**

PART No. SY-4530-01002

- Portable hand operated machine for field assembly
- Frame can be attached to bench vise or directly to a table with separate mounting bracket
- Weight: 8 lbs (3.6kg)



**Carrying Case for
Portable Hand Swager SST**

PART No. SY-45J0-04300



Mark IX

- Fully automatic; opens dies to release completed coupling assembly
- Fast actuation; capable of 5-second cycle time
- Three power supply options for a broad range of production needs
- Weight: 131 lbs (59.4kg). (option 1&2)

Option 1

PART No. SY-4530-009S0

1HP, 60Hz, 115/208/230V Single Phase Motor; Medium Duty;

Option 2

PART No. SY-4530-009S1

1HP, 60 Hz, 230/460 V Three Phase Motor; Medium Duty;

Option 3

For Heavy Duty, continuous high speed production assembly, the Mark IX (a) can be equipped with a high capacity power unit (b)

(a) PART No. SY-4530-009S4

Mark IX swaging machine without standard power supply.

(b) PART No. SY-453C-00020

Commercial duty hydraulic power unit with 5HP three phase 230/460 volt motor, 5 gallon reservoir; 4.1 GPM displacement.

PUSHER AND DIE TOOLS FOR SYNFLX SWAGING MACHINE



Pushers

- Pusher selection is based on coupling end design chosen from assembly.

Example: To attach a 3/8 inch I.D. hose to a JIC 37° Female Swivel coupling with a -6 thread size

PART No. SY-3903-06546, use pusher

PART No. SY-4599-FP015

Dies

- Swaging dies are applied in paired sets. Die selection is based on hose series and size. Die part numbers are listed in hose specification charts.

Example: To attach coupling PART No. SY-3903-06546 to a series 3130 3/8 inch I.D. hose,

use die **PART No. SY-4540-306**.

Die Pusher Storage Rack **PART No. SY-45J0-03401**

- Rack holds 12 pushers and 8 dies. Welded 16 gauge steel frame can be wall mounted or used on bench top. Rack is 19 inches wide; 22-1/2 inches high; extends 3 inches from mounting surface.

HOSE CUT-OFF BLADES FOR CUT-OFF MACHINES

BEVELED EDGE BLADE



PART No.	Arbor Hole Diameter	Blade Diameter
HCB-7	5/8"	7"
HCB-8	5/8"	8"
HCB-10	3/4"	10"

SCALLOPED EDGE BLADE



PART No.	Arbor Hole Diameter	Blade Diameter
HCBS-7	5/8"	7"
HCBS-8	5/8"	8"
HCBS-10	3/4"	10"

NYLON SLEEVE



- Reduces abrasions, increases hose life.

PART No.	Sleeve I.D. (IN.)
NS-14	.91
NS-16	1.06
NS-20	1.22
NS-24	1.42
NS-28	1.85
NS-32	2.17

BEND PROTECTORS



MATERIAL: POLYVINYLCHLORIDE
TEMPERATURE: -40°F to +200°F
 -40°C to +93°C

Smooth finish, friction fit, bend protector reduces bending stress near hose end for longer, trouble free hose life.

PART No.	I.D.	Length (IN.)
MP-BP-4	.625	5.50
MP-BP-6	.735	6.38
MP-BP-8	.835	7.00

STEEL
 MP-SBP-6 .672 5.00

Note: Other sizes available upon request.

SPRING GUARD



- Prevents kinking.
- Reduces abrasions, increases hose life.
- Covers entire length of hose.

PART No.	Spring I.D. (IN.)
SY-4521-91005	.627
SY-4521-57000	.666
SY-4521-58000	.791
SY-4521-59000	.935
SY-4521-60000	1.182
SY-4521-56000	1.380

CABINETS & DISPLAY UNITS



WHAT'S NEW IN THIS SECTION

- Fitting Centre Drawer Cabinet
.....Pg 251

AIR HOSE ASSEMBLY RACK263

BIN STORAGE - WALL253

CABINETS - DRAWER251 - 253

CABINET - SLIDER STYLE (Up To 336 Bin)250

DISPLAY RACK - AIR BRAKE ASSEMBLY262

DISPLAY RACK - GANG HOOK STYLE257

DISPLAY RACK - GEAR CLAMP264

DISPLAY RACK - T-BOLT CLAMP264

DISPLAY RACK - WATER HOSE ASSEMBLY262

FITTING PACKAGES255 - 256

LABEL SETS254

PRODUCT SELECTION PACKAGE - GAS-FLO® PRODUCTS ...260 - 261

PRODUCT SELECTION PACKAGE - GREASE PRODUCTS259

PRODUCT SELECTION PACKAGE - PNEUMATIC PRODUCTS258

REFERENCE CHARTS & INFORMATION265 - 267

STOCK BOXES264



FITTING CABINETS

UP TO 336 BIN SLIDER CABINET

Stand Alone Slider Cabinet

PART No.

QS-305306-52 (Unassembled)

QS-305306-52A (Assembled)

QS-305-40 (Unassembled)

QS-306-56 (Unassembled)

QS-000 (Slider Frame only No bins)

See below for bin configurations.

This system features four individual panels filled with tip out bins of which two are fixed to the back side and two slide easily from left to right allowing free access to all four panels. Manufactured of tough 14 gauge steel with putty powder coat finish.

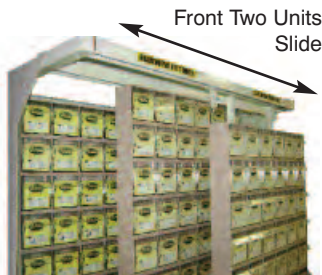
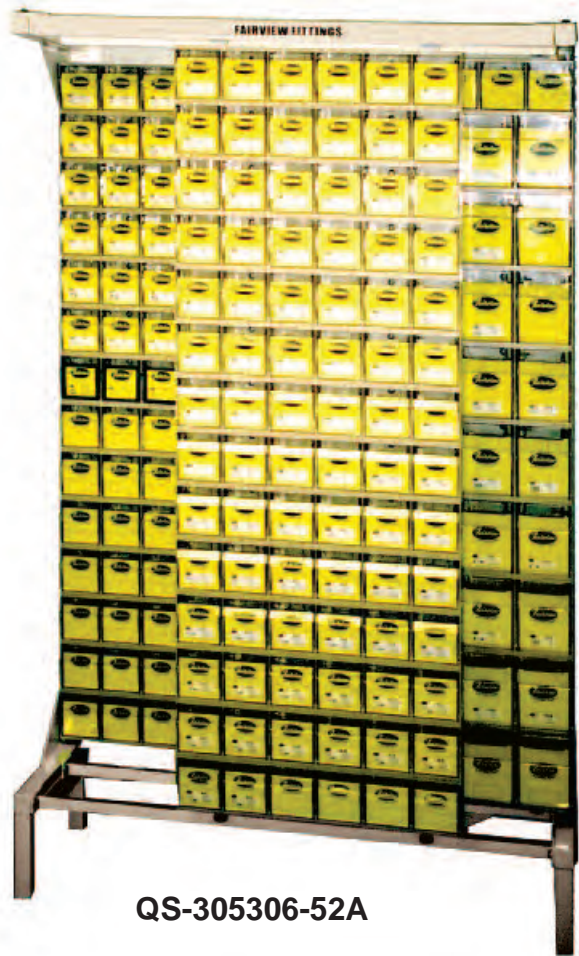

Overall:

Height 66-1/4 inches
 Width 48 inches
 Depth 16 inches

Supplied as shown with customizable Fairview bin front cards.

QS-305306-52A

Bin Units Available:



QTB-309
 9 Bin - 2-1/2"L x 23-5/8"W x 3-1/8"H



QTB-305
 5 Bin - 5-1/4"L x 23-5/8"W x 6-1/2"H



QTB-303
 3 Bin - 7-3/4"L x 23-5/8"W x 9-1/2"H



QTB-306
 6 Bin - 3-5/8"L x 23-5/8"W x 4-1/2"H



QTB-304
 4 Bin - 6-5/8"L x 23-5/8"W x 8-1/8"H



QTB-302
 2 Bin - 11-3/4"L x 23-5/8"W x 13-7/8"H

Slider Cabinet Bin Configuration Chart

(How many of each bin is preconfigured set ups)

PART No.	Bin Unit QTB-305	Bin Unit QTB-306	Total BINS
QS-305306-52	9	43	303
QS-305-40	40	0	200
QS-306-56	0	56	336

70 DRAWER - 10 BIN CABINET

Fairview Fitting Center

PART No. XC80-CA

This all new steel fitting center is the best of both worlds, with 50 single and 20 double size clear plastic sliding drawers. It also has 10 bin compartments for larger items. It is featured in Fairview's red, black and yellow colors.

It's equipped with steel tubular legs that can safely hold this Industrial cabinet. Large open bottom shelf for overstock is also supplied.

Note: Cards, Dividers and Label sets are not included in the price of the cabinet. For suggested product fitting packages contact your local Fairview branch.

Overall: Height 61 inches
Width 33 inches
Depth 6 inches



Double size cabinet drawers (PD-55)



Standard cabinet drawers (PD-110)



<p>Standard Drawer Dimensions: PART No. PD-110 Size: Width 2-3/4 inches Length 5-3/4 inches Depth 2-1/2 inches</p> <p>Double Drawer Dimensions:(Optional) PART No. PD-55 Size: Width 5-3/4 inches Length 5-3/4 inches Depth 2-1/2 inches</p> <p>• State PD-55 quantity requirements when ordering.</p>
--



UP TO 110 DRAWER CABINET

Stand Alone Storage Cabinet

PART No. XC110-CA

This steel cabinet has 110 clear plastic sliding drawers, each with the option of dividing into 4 compartments. It is featured in Fairview's red, black and yellow colors.

It's equipped with steel tubular legs that can safely hold this Industrial cabinet. Large open bottom shelf for overstock is also supplied.

Note: Cards, Dividers and Label sets are not included in the price of the cabinet. See Page 255 - 256 for suggested cabinet fitting packages.

Overall: Height 61 inches
Width 33 inches
Depth 6 inches



PD-110 Standard cabinet drawer is the PD-110.

Double size cabinet drawers (PD-55) are available.



Standard Drawer Dimensions:	
PART No. PD-110	
Size:	Width 2-3/4 inches
	Length 5-3/4 inches
	Depth 2-1/2 inches
Double Drawer Dimensions:(Optional)	
PART No. PD-55	
Size:	Width 5-3/4 inches
	Length 5-3/4 inches
	Depth 2-1/2 inches
• State PD-55 quantity requirements when ordering.	

UP TO 20 DRAWER CABINET

Counter / Wall Mounting Drawer Cabinet

PART No. XB20-CA

This cabinet has 20 drawers, each one with the capability of dividing into 4 separate compartments. It is featured in Fairview's red, black and yellow colors.

Overall: Height 14 inches
Width 16 inches
Depth 6 inches

Note: Cards, Dividers and Label sets are not included in the price of the cabinet. See Page 255 - 256 for suggested product fitting packages.
For drawer dimensions see Page 252.



BIN STORAGE CABINETS

Floor / Wall
Mounting
Storage
Cabinet for
Fittings or
Large Items



PART No. 42-CA

This heavy gauge metal cabinet can be used for floor or wall mounting. It has 42 large compartments for easy access. Modular in design for easy addition.

Label sets available.

This cabinet is available in the color grey.

	Overall:	Bin Size:
Height	42 inches	5-1/2 inches
Width	33-3/4 inches	5-3/8 inches
Depth	12 inches	11-7/8 inches

Floor / Wall
Mounting
Storage
Cabinet for
Fittings or
Large Items

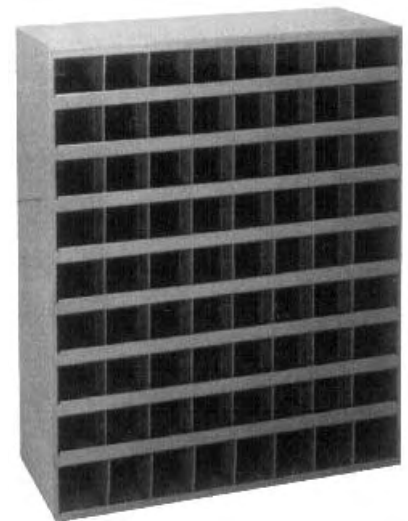

PART No. 72-CA

This heavy gauge metal cabinet can be used for floor or wall mounting. It has 72 large compartments for easy access. Modular in design for easy addition. Label sets available.

This cabinet is available in the color grey.

	Overall:	Bin Size:
Height	42 inches	4-1/2 inches
Width	33-3/4 inches	4 inches
Depth	12 inches	11-7/8 inches

Label kits for our 20 and 110 Drawer Cabinets

LAB-INDUST-110

Industrial Fittings For The 110 Drawer Cabinet

- 110- Yellow Cardboard Blanks (PM-LABEL-BLANK-YEL)
- 80-Plastic Drawer Dividers (PM-PLASTIC INSERT)
- 1-Industrial Fittings Sticker Assortment (PM-STICK-INDUST-110)

• See page 255 for Industrial Fitting selection and suggested drawer quantities.

LAB-TRUCK-110

Trucking Fittings For The 110 Drawer Cabinet

- 70- Yellow Cardboard Blanks (PM-LABEL-BLANK-YEL)
- 40-Plastic Drawer Dividers (PM-PLASTIC INSERT)
- 20- Yellow Labels for Drawers (GS-ASSEMB PKG LAB)
- 1-Trucking Fittings Sticker Assortment (PM-STICK-TRUCK-110)

• See page 255 for Trucking Fitting selection and suggested drawer quantities.

Please Note: The standard drawer configuration for the Truck Cabinet is:

- 70-Standard Plastic Drawers (PD-110)
- 20-Double Plastic Drawers (PD-55)

LAB-AUTO-20

Automotive Fittings For The 20 Drawer Cabinet

- 20- Yellow Cardboard Blanks (PM-LABEL-BLANK-YEL)
- 20-Plastic Drawer Dividers (PM-PLASTIC INSERT)
- 1-Automotive Series Sticker Assortment . . . (PM-STICK-AUTO-20)

• See page 255 for Auto-20 Fitting selection and suggested drawer quantities.

LAB-AUTO-110

Automotive Fittings For The 110 Drawer Cabinet

- 110- Yellow Cardboard Blanks (PM-LABEL-BLANK-YEL)
- 110-Plastic Drawer Dividers (PM-PLASTIC INSERT)
- 1-Automotive Fittings Sticker Assortment . . . (PM-STICK-AUTO-110)

• See page 256 for Auto-110 Fitting selection and suggested drawer quantities.

LAB-1400-20

1400 Series Air Brake Fittings For The 20 Drawer Cabinet

- 20- Yellow Cardboard Blanks (PM-LABEL-BLANK-YEL)
- 15-Plastic Drawer Dividers (PM-PLASTIC INSERT)
- 1-1400 Series Sticker Assortment (PM-STICK-1400-20)

• See page 256 for 1400 Series Fitting selection and suggested drawer quantities.

LAB-PC1400-20

Push-To-Connect Air Brake Fittings For The 20 Drawer Cabinet

- 20- Yellow Cardboard Blanks (PM-LABEL-BLANK-YEL)
- 12-Plastic Drawer Dividers (PM-PLASTIC INSERT)
- 1-Push-to-Connect D.O.T. Series Sticker Assortment (PM-STICK-PC1400-20)

• See page 256 for PC1400 Series Fitting selection and suggested drawer quantities.

LAB-PLUMB-20

Plumbing Fittings For The 20 Drawer Cabinet

- 20- Yellow Cardboard Blanks (PM-LABEL-BLANK-YEL)
- 43-Plastic Drawer Dividers (PM-PLASTIC INSERT)
- 1-Plumbing Series Sticker Assortment (PM-STICK-PLUMB-20)

• See page 256 for Plumbing Fitting selection and suggested drawer quantities.



PART No.

PM-LABEL-BLANK-YEL

Blank yellow drawer cards are supplied. Printed on heavy duty card stock, just affix the stickers and slide into place.



PART No.

PM-PLASTIC INSERT

Durable plastic inserts for dividing drawers into sections allow you to totally customize your cabinet. Remove the protective blue film, affix the stickers and slide into place.

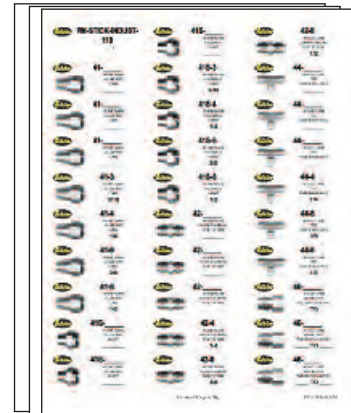

PART No.

PM-STICK-INDUST-110

Peel and stick standard or custom ordered label sets. These sets are self adhesive and printed 30 per sheet. Measuring 1" x 2-5/8" just peel and attach to the yellow drawer cards, plastic dividers or stockboxes.

CABINET FITTING PACKAGES



Note: Product selection and quantities suggested are based on specified industry or product group and cabinet space availability. Cabinets must be purchased separately.

Industrial Assortment for 110 Drawer Cabinet (PART No. KIT-INDUST-110)

Fairview PART No.	Drawer Qty	Fairview PART No.	Drawer Qty	Fairview PART No.	Drawer Qty	Fairview PART No.	Drawer Qty	Fairview PART No.	Drawer Qty	Fairview PART No.	Drawer Qty
41-3	15	60-5	25	68-6A	10	110-CA	10	120-BB	5	129-8	5
41-4	15	60-6	50	68-6B	15	110-CB	10	120-CB	10	135-LB	5
41-6	15	60-8	25	68-6C	15	110-DA	5	120-DC	5	135-RB	5
41-8	15	60-10	10	68-8C	10	110-DB	10	121-A	10	136-L	5
41S-3	15	60-12	10	68-8D	10	110-DC	20	121-B	10	136-R	5
41S-4	15	61-2	25	68-10D	10	110-EC	5	121-C	5	137-L	5
41S-6	15	61-3	25	69-2A	5	110-ED	5	121-D	5	137-R	5
41S-8	15	61-4	50	69-3A	25	112-A	10	122-A	5	161-6	10
42-4	10	61-5	25	69-4A	25	112-B	15	122-B	10	193-8	5
42-6	20	61-6	50	69-4B	10	112-C	10	122-C	5	195-8	5
42-8	5	61-8	25	69-5B	10	112-D	5	122-D	5	480-4	25
44-4	5	61-10	10	69-6A	5	113-A1-1/2	5	122-BA	5	480-6	25
44-6	5	61-12	10	69-6B	15	113-A2	5	122-CB	5	480-8	25
44-8	5	62-3	5	69-6C	10	113-B1-1/2	5	X124-A	5	481-4	25
46-4A	5	62-4	10	69-6D	5	113-B2	5	X124-B	5	481-6	25
46-6B	5	62-5	5	69-8C	10	113-C1-1/2	5	X124-C	5	481-8	25
46-8D	5	62-6	10	69-8D	5	113-C2	5	X124-D	5	1161-4	10
48-4A	15	62-8	5	69-10D	5	113-D2	5	125-4A	10	1161-8	10
48-4B	15	62-10	5	103-A	5	X115-A	15	125-4B	10	HC9-4	15
48-6B	10	64-4	5	103-B	5	X115-B	15	125-5B	5	HC9-5	15
48-6C	10	64-6	5	103-C	5	X115-C	15	125-6A	5	HC9-6	15
48-8C	5	64-8	5	103-D	5	X115-D	5	125-6B	20	HC9-8	15
48-8D	5	66-2A	5	106-B	5	118-A	10	125-6C	10	HC9-9	15
49-4A	10	66-3A	5	106-C	5	118-B	20	125-6D	5	HC9-10	15
49-4B	10	66-4B	5	107-A	5	118-C	10	125-8C	5	HC9-12	15
49-6B	10	66-6C	5	107-B	5	118-D	10	125-8D	10	HC9-14	15
49-6C	5	66-8D	5	107-C	5	119-BA	5	125-10C	5	HC9-15	5
49-8C	5	68-2A	15	109-A	10	119-CB	5	125-10D	5	HC9-16	5
49-8D	5	68-3A	5	109-B	10	119-DB	5	125-12D	5		
60-2	25	68-4A	25	109-C	10	119-DC	5	125-12E	5		
60-3	25	68-4B	25	109-D	5	120-AA	10	129-4	10		
60-4	50	68-5B	10	110-BA	20	120-BA	10	129-6	10		

Truck & Trailer Assortment for 110 Drawer Cabinet (PART No. KIT-TRUCK-110)

Fairview PART No.	Drawer Qty	Fairview PART No.	Drawer Qty	Fairview PART No.	Drawer Qty	Fairview PART No.	Drawer Qty	Fairview PART No.	Drawer Qty	Fairview PART No.	Drawer Qty
X101-A	5	122-B	10	1460-8	25	1471-6B	5	1491-6	10	BV4103-C	2
X101-B	5	122-C	5	1460-10	5	1471-6C	5	1491-8	5	BV4103-D	2
X101-C	2	122-D	5	1461-4	25	1472-6B	5	1492-6B	10	BV4103-E	1
X101-D	2	122-BA	10	1461-6	50	1472-6C	5	1492-6C	10	GHE	2
103-A	5	122-CB	10	1461-8	25	1474-6B	5	1492-6D	2	GHS	2
103-B	5	X124-A	5	1461-10	5	1474-6C	5	1492-6S	2	GHU	1
103-C	5	X124-B	5	1462-4	10	PC1462-4	5	1492-8C	5	GH-SEAL	5
103-D	5	X124-C	5	1462-6	15	PC1462-6	5	1492-8D	2	GH-SEAL-2	5
X107-A	5	240-B	5	1462-8	10	PC1462-8	5	1492-8S	2	HAB-HANGER-6	10
X107-B	5	241-B	5	1466-6B	5	PC1466-4B	2	1493-6B	5	HAB-HANGER-8	10
X107-C	2	T241-B	5	1468-4A	10	PC1466-6B	2	1493-6C	5	HAB-HCU-6	2
X107-D	2	860-2	25	1468-4B	10	PC1468-4A	2	1493-6D	2	HAB-HCU-8	2
110-BA	20	860-2-1/2	25	1468-6A	5	PC1468-4B	5	1493-8C	2	TS16R-4	10
110-CB	10	861-2	25	1468-6B	25	PC1468-6B	5	1493-8D	2	TS16R-5	10
110-DB	10	861-2-1/2	25	1468-6C	25	PC1468-6C	5	1494-6	2	TS16R-6	10
110-DC	10	862-2	5	1468-8C	10	PC1468-8C	2	1494-8	2	TS16R-8	10
110-ED	10	862-2-1/2	5	1468-8D	5	PC1468-8D	2	1495-C	5	TS16R-10	5
X115-A	15	868-2-1	5	1469-4A	10	PC1469-4A	2	1495-L	5	TS16R-12	5
X115-B	10	868-2A	5	1469-4B	25	PC1469-4B	5	1495-S	10	TS17R-4	25
X115-C	5	868-2-1/2-1	5	1469-6A	5	PC1469-6B	5	1496-DC	5	TS17R-5	25
X115-D	5	868-2-1/2A	5	1469-6B	25	PC1469-6C	5	1497-DB	2	TS17R-6	25
121-B	10	869-2A	5	1469-6C	25	PC1469-8C	2	1498N-6D	2	TS17R-8	25
121-C	10	869-2-1/2A	5	1469-6D	5	PC1469-8D	2	4134-6B	10	TS17R-10	15
121-D	10	1460-4	50	1469-8C	5	1490-6	25	4134-6C	10	TS17R-12	15
122-A	10	1460-6	50	1469-8D	5	1490-8	15	14DV-60B	2		

Automotive Assortment for 20 Drawer Cabinet (PART No. KIT-AUTO-20)

PART No.	Drawer	PART No.	Drawer	PART No.	Drawer	PART No.	Drawer	PART No.	Drawer	PART No.	Drawer
60-3	25	61-6	10	142-3	10	148-4A	10	SB141-3	2	WH-7818	5
60-4	25	62-3	10	142EU-3	10	PL141-3	10	SE141-3	5	WH-7828	5
60-5	25	62-4	10	142JA-3	10	PL141-4	5	SJ141-3	5	WH-7829	5
60-6	25	62-5	10	142-4	10	S141-3	25	SE143-3	3	WH-7908	5
61-3	25	62-6	10	142-5	5	S141-4	25	SJ143-3	2		
61-4	25	141-3	15	142-6	5	S141-5	10	SL141-3	10		
61-5	10	141-4	15	148-3A	10	S141-6	10	SL141-4	15		

K



CABINET FITTING PACKAGES

Note: Product selection and quantities suggested are based on specified industry or product group and cabinet space availability. Cabinets must be purchased separately

Automotive Assortment for 110 Drawer Cabinet (PART No. KIT-AUTO-110)

Fairview PART No.	Drawer Qty	Fairview PART No.	Drawer Qty	Fairview PART No.	Drawer Qty	Fairview PART No.	Drawer Qty	Fairview PART No.	Drawer Qty	Fairview PART No.	Drawer Qty
41-3	10	62-3	10	103-B	10	119-DC	5	149-3A	10	481-4H	10
41-4	10	62-4	10	103-C	5	120-AA	10	149-4A	10	481-5	10
41-5	10	62-5	10	103-D	5	120-BA	10	149-4B	5	481-6	10
41-6	10	62-6	10	X106-A	5	120-BB	5	149-5A	10	481-8	5
41-8	5	62-8	5	X106-B	5	120-CB	5	149-5B	10	PL141-3	10
42-4	5	64-4	5	X107-A	5	120-DC	5	149-6B	10	PL141-4	10
42-5	5	64-6	5	X107-B	5	121-A	10	181-2	10	PL141-5	10
42-6	5	66-2A	10	109-A	10	121-B	10	181-3	10	PL141-6	10
48-3A	10	66-3A	10	109-B	10	121-C	10	181-4	10	S141-2	10
48-4A	10	66-4A	10	109-C	10	121-D	5	188-2A	10	S141-3	20
48-4B	10	66-6B	5	109-D	5	121-E	2	188-3A	10	S141-4	20
48-5A	10	68-2A	10	110-BA	20	122-A	10	188-4A	10	S141-5	20
48-5B	10	68-3A	10	110-CA	10	122-B	10	240-A	10	S141-6	10
48-6A	5	68-4A	10	110-CB	10	122-BA	5	240-B	10	SB141-3	10
48-6B	10	68-4B	10	110-DA	5	122-C	5	240-C	5	SE141-3	10
48-6C	5	68-5A	10	110-DB	10	122-CB	5	241-B	5	SJ141-3	10
48-8C	5	68-5B	10	110-DC	5	X124-A	5	243-B	5	SL141-3	5
49-4A	10	68-6A	10	110-EC	2	X124-B	5	245-B	5	SL141-4	5
49-4B	5	68-6B	10	110-ED	2	X124-C	5	325-3A	5	SLJ141-3	10
49-5A	10	68-6C	5	112-A	10	142-3	10	325-4A	10	WH-1442	5
49-5B	5	68-8C	5	112-B	10	142-4	10	325-4B	5	WH-1443	5
49-6B	10	69-2A	10	112-C	10	142-5	10	325-5A	10	WH-1514	5
49-8C	5	69-3A	10	112-D	5	142-6	5	325-5B	5	WH-1538	10
60-2	50	69-4A	10	113-A1-1/2	10	142BR-3	5	325-6A	10	WH-1548	10
60-3	50	69-4B	10	113-A2	10	142EU-3	5	325-6B	10	WH-7818	5
60-4	50	69-5A	10	113-B1-1/2	5	142JA-3	5	325-6C	5	WH-7828	5
60-5	50	69-5B	10	113-B2	5	142MM-3	5	335-55	10	WH-7829	5
60-6	50	69-6A	5	113-C2	5	146-3A	10	335-56	10	WH-7904	5
60-8	20	69-6B	10	X115-A	10	146-4A	10	335-65	5	WH-7906	5
61-2	10	69-6C	5	X115-B	10	148-3A	10	335-66	5	WH-7908	2
61-3	20	69-8C	5	X115-C	5	148-4A	10	339-4A	5	WH-7914	2
61-4	20	X100-A	10	X115-D	5	148-4B	10	339-5A	10	WH-7935	5
61-5	20	X100-B	10	117-A	10	148-5A	10	339-5B	10	WH-7936	5
61-6	10	X101-A	10	117-B	10	148-5B	10	339-6A	5	WH-7937	5
61-8	10	X101-B	5	119-BA	10	148-6A	5	339-6B	5	WH-7940	5
62-2	10	103-A	10	119-CB	5	148-6B	10	481-4	10		

1400 Series (Air Brake) Assortment for 20 Drawer Cabinet (PART No. KIT-1400-20)

Fairview PART No.	Drawer Qty	Fairview PART No.	Drawer Qty	Fairview PART No.	Drawer Qty	Fairview PART No.	Drawer Qty	Fairview PART No.	Drawer Qty	Fairview PART No.	Drawer Qty
1460-4	100	1461-8	25	1464-6	5	1468-6C	30	1469-6B	30	1471-6C	5
1460-6	100	1461-10	5	1466-6B	5	1468-8C	10	1469-6C	25	1472-6B	5
1460-8	75	1462-4	10	1468-4A	20	1468-8D	10	1469-6D	5	1472-6C	10
1460-10	25	1462-6	25	1468-4B	10	1469-4A	25	1469-8C	5	1474-6B	10
1461-4	25	1462-8	10	1468-6A	5	1469-4B	25	1469-8D	5	1474-6C	10
1461-6	50	1464-4	10	1468-6B	35	1469-6A	40	1471-6B	5		

PC1400 Series (Air Brake Push-To-Connect) Assortment for 20 Drawer Cabinet (PART No. KIT-PC1400-20)

Fairview PART No.	Drawer Qty	Fairview PART No.	Drawer Qty	Fairview PART No.	Drawer Qty	Fairview PART No.	Drawer Qty	Fairview PART No.	Drawer Qty	Fairview PART No.	Drawer Qty
PC1462-4	10	PC1466-6B	5	PC1468-6C	10	PC1469-6B	10	PC1470-4B	5	PC1474-6C	5
PC1462-6	10	PC1466-6C	5	PC1468-8C	10	PC1469-6C	10	PC1471-6B	5	PC1474-8C	5
PC1462-8	10	PC1468-4A	10	PC1468-8D	5	PC1469-6D	5	PC1471-6C	5		
PC1464-4	5	PC1468-4B	10	PC1469-4A	10	PC1469-8C	5	PC1472-6B	5		
PC1464-6	5	PC1468-6A	10	PC1469-4B	10	PC1469-8D	5	PC1472-6C	5		
PC1466-4B	5	PC1468-6B	10	PC1469-6A	10	PC1470-4A	5	PC1474-6B	5		

Plumbing Assortment for 20 Drawer Cabinet (PART No. KIT-PLUMB-20)

Fairview PART No.	Drawer Qty	Fairview PART No.	Drawer Qty	Fairview PART No.	Drawer Qty	Fairview PART No.	Drawer Qty	Fairview PART No.	Drawer Qty	Fairview PART No.	Drawer Qty
60-4	10	62-10	3	68-6B	5	69-6D	5	100-C	3	110-DA	5
60-6	10	64-4	3	68-6C	5	69-8C	3	100-D	3	110-DB	5
60-8	10	64-6	3	68-6D	5	69-8D	3	103-B	5	110-DC	5
60-10	5	64-8	3	68-8C	3	69-10C	3	103-C	5	122-A	5
61-4	10	64-10	3	68-8D	3	69-10D	3	103-D	5	122-B	5
61-6	10	65-4	3	68-10C	3	72-4B	3	109-B	5	122-C	5
61-8	10	65-6	3	68-10D	3	72-6B	3	109-C	5	122-D	5
61-10	5	65-8	3	69-4A	5	72-6C	3	109-D	5		
62-4	5	65-10	3	69-4B	5	72-8C	3	110-BA	5		
62-6	5	68-4A	5	69-6B	5	72-8D	3	110-CA	5		
62-8	5	68-4B	5	69-6C	5	100-B	3	110-CB	5		



OVERALL DIMENSIONS:

Height 67 inches
 Depth 24 inches
 Width 18 inches

FEATURES:

Fairview display racks stand on their own and have the ability to present products in a variety of configurations. Featured in one of three Fairview color schemes. The display racks come complete with frame, legs, back-board panel and shelf for displaying up to 42 individually bubble-packed, bar-coded products. Easy to assemble. (Gang Hooks Selection Below)

Stand Alone Display Racks

BASIC UNIT: Frame, Legs, Shelf & (Back-Board see below)

PART No.	Description
25-DR	Standing Display Rack

BACK-BOARDS (select - 1 per unit)

PART No.	Description
25-DR-PANEL-A	Accutek™ Backboard (English)
25-DR-PANEL-AF	Accutek™ Backboard (French)
25-DR-PANEL-G	Fairview Backboard (General Use)
25-DR-PANEL-GAS	Gas-Flo® Backboard (English)
25-DR-PANEL-GAS-F	Gas-Flo® Backboard (French)

GANG HOOKS (See gang hook requirements below)

PART No.	Description
DR-3GH	Gang Hook - for 3 Product
DR-4GH	Gang Hook - for 4 Product
DR-5GH	Gang Hook - for 5 Product
DR-6GH	Gang Hook - for 6 Product

LEGS AND SHELF

PART No.	Description
25-DR-LEGS	Set of Rack Legs, complete with leveling screw feet.
25-DR-SHELF	Shelf

Shelf Dimensions: Width 24 inches, Length 18 inches

Our newly designed Fairview displays feature our Fairview, Accutek™ and Gas-Flo® product lines.



KIT	3 Hook	4 Hook	5 Hook	6 Hook
AIR-1	1	0	4	0
AIR-2	1	0	4	0
AIR-3	0	2	1	0
GAS-GG	0	2	1	1
GAS-RV	0	2	0	2
GAS-RVGG	2	0	0	2
GREASE-1	0	0	5	0



FEATURES:

All product assortments are bubble packaged and UPC bar coded. Pneumatic recoiling hose assemblies are supplied bagged with one hole punched header cards. Each package includes a full set of product identification stickers for panel mounting. When ordering replacement packaged product, minimum carton quantities apply. Display rack is included in these selections: Includes frame panel legs and shelf.

Not exactly as shown.



1936-4-25



PART No. AIR-1 Contains: Pneumatic General Selection 1

PART No.	Qty	Description	PART No.	Qty	Description
1936-4-25	2	Polyurethane self store air assy,1/4 X 25'	AG411EP	1	Safety tip blow gun
1936-4-50	1	Polyurethane self store air assy,1/4 X 50'	C-BV2103-B	2	Ball valve,1/4 FPT,full port
1936-6-25	1	Polyurethane self store air assy,3/8 X 25'	C-PG-30SD2	3	2"- 0-30 PSI,dry gauge,1/4" bottom mount
C-125-4B	5	Hose Barb , 1/4 Hbarb X 1/4 MPT	C-PG-100SD2	3	2"- 0-100 PSI,dry gauge,1/4" bottom mount
C-125-6B	5	Hose Barb , 3/8 Hbarb X 1/4 MPT	C-PG-160SD2	3	2"- 0-160 PSI,dry gauge,1/4" bottom mount
C-125-6C	5	Hose Barb , 3/8 Hbarb X 3/8 MPT	C-PG-60CD15	3	1-1/2"- 0-60 PSI,dry gauge,1/8" Center.back mount
C-129R-4KIT	5	Splicer ,1/4 HBarb , c/w 2 gear clamps	C-PG-160CD15	3	1-1/2"- 0-160 PSI,dry gauge,1/8"Center back mount
C-129R-6KIT	5	Splicer ,3/8 HBarb , c/w 2 gear clamps	C-PG-60CD2	3	2"- 0-60 PSI,dry gauge,1/4" Center back mount
C-QD-AROAC4-4F	3	Aro 210 automatic coupler 1/4"FPT	C-PG-160CD2	3	2"- 0-160 PSI,dry gauge,1/4" Center back mount
C-QD-ARON4-4M	5	Aro 210 nipple 1/4"MPT	C-BC-B	3	Ball chuck 1/4"
C-QD-INDMC4-4F	3	Industrial interchange manual coupler 1/4" FPT	C-122-B	5	Brass hex nipple 1/4"
C2-QD-INDN4-4M	5	Industrial interchange nipple 1/4" MPT x2	DR-A	1	Accutek™ Display Rack (Specify English or French)
			C-AIR-1	1	Air-1 OUT OF STOCK Display Cards

PART No. AIR-2 Contains: Pneumatic General Selection 2

PART No.	Qty	Description	PART No.	Qty	Description
1936-4-25	2	Polyurethane self store air assy,1/4 X 25'	C-PG-160CD2	3	2"- 0-160 PSI,dry gauge,1/4" Center back mount
AG166P	3	Air gun,hostaform,long aluminum tip	C-PG-160SD2	3	2"- 0-160 PSI,dry gauge,1/4" bottom mount
AG410RP	2	Air gun, C/W rubber tip	C-QD-ARO-4	3	Aro 210 coupler FPT & nipple 1/4" MPT
C-125-4B	5	Hose barb , 1/4 Hbarb X 1/4 MPT	C-QD-AROAC4-4F	3	Aro 210 coupler 1/4"FPT
C-125-6B	5	Hose barb , 3/8 Hbarb X 1/4 MPT	C-QD-ARON4-4F	5	Aro 210 nipple 1/4"FPT
C-125-6C	5	Hose barb , 3/8 Hbarb X 3/8 MPT	C-QD-ARON4-4M	5	Aro 210 nipple 1/4"MPT
C-129R-4KIT	5	Splicer ,1/4 Hbarb, c/w 2 gear clamps	C-QD-INDM-4	3	Ind'l interchange manual coupler FPT & nipple 1/4" MPT
C-129R-6KIT	5	Splicer ,3/8 Hbarb, c/w 2 gear clamps	C-QD-INDMC4-4F	3	Industrial interchange manual coupler 1/4" FPT
C2-240-B	3	Back seating drain valve,1/4 MPT x2	C2-QD-INDN4-4F	5	Industrial interchange nipple 1/4" FPT x2
C-BC-B	3	Brass Ball chuck 1/4" FPT,	C2-QD-INDN4-4M	5	Industrial interchange nipple 1/4" MPT x2
C-BC-B-LH	3	Brass Locking Ball chuck 1/4" FPT,	C-X101-B	5	Tee,1/4 FPT
C-PG-160CD15	3	1-1/2"- 0-160 PSI,dry gauge,1/8"Center back mount	DR-A	1	Accutek™ Display Rack (Specify English or French)
			C-AIR-2	1	Air-2 OUT OF STOCK Display Cards

PART No. AIR-3 Contains: Self Storing Hoses and Air Guns

PART No.	Qty	Description	PART No.	Qty	Description
AG165P	5	Air gun,hostaform,cone tip	1936-4-12	2	Polyurethane self store air assembly,1/4 X 12'
AG166P	5	Air gun,hostaform,long aluminum tip	1936-4-25	3	Polyurethane self store air assembly,1/4 X 25'
AG411EP	5	Safety tip blow gun	1936-4-50	2	Polyurethane self store air assembly,1/4 X 50'
AG410RP	5	Air gun, C/W rubber tip	1936-6-25	2	Polyurethane self store air assembly,3/8 X 25'
AG411EWP	5	Extended wand safety tip air gun	DR-A	1	Accutek™ Display Rack
			C-AIR-3	1	Air-3 OUT OF STOCK Display Cards

NOTE: Selection and quantities suggested are based on specified product groups and rack space availability on a single panel.



FEATURES:

All product assortments are bubble packaged and UPC bar coded. Grease whip hose assemblies are supplied bagged with one hole punched header cards. Each package includes a full set of product identification stickers for panel mounting. When ordering replacement packaged product, minimum carton quantities apply. Display rack is included with this package: Includes frame panel legs and shelf.



For Packaged Stock and Kits: See page 39

GWR-3-24P



Grease Guns: See page 240

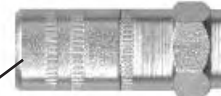

**Grease Couplers
GWC-A: See page 39**

PART No. GREASE-1 Contains: Grease Products Start-Up Package 1

PART No.	Pkgs.	Total Pcs.	Description	Total PART No.	Pkgs.	Pcs.	Description
C10-GN-608	3	30	5/16 Drive Fit Grease Fitting	C10-GNM-045	3	30	M6 x 1 45° Angle Metric Grease Fitting
C10-GN-610	3	30	1/8 x 27 Straight Grease Fitting	C10-GNM-090	3	30	M6 x 1 90° Angle Metric Grease Fitting
C10-GN-612	3	30	1/8 x 27 65° Angle Grease Fitting	C10-GNM-301	3	30	M10 x 1 Straight Metric Grease Fitting
C10-GN-613	3	30	1/8 x 27 90° Angle Grease Fitting	C10-GNM-601	3	30	M6 x 1 Straight Metric Grease Fitting
C10-GN-627	3	30	1/4 x 18 Straight Grease Fitting	C10-GNM-901	3	30	M8 x 1 Straight Metric Grease Fitting
C10-GN-629	3	30	1/4 x 18 65° Angle Grease Fitting	C-GWC-A	3	3	1/8 NPT 4 - Jaw Grease Coupler
C10-GN-637	3	30	1/4 x 28 45° Angle Grease Fitting	GG-SDL	1	1	Standard Duty Lever Grease Gun
C10-GN-641	3	30	1/4 x 28 Straight Grease Fitting	GG-SDPG	1	1	Standard Duty Pistol Grip Grease Gun
C10-GN-652	3	30	1/4 x 28 Straight 11/16 O/L Grease Fitting	GWR-3-12P	2	2	Grease Whip Assy, 12 OAL
C10-GN-680	3	30	1/4 x 28 Straight 15/16 O/L Grease Fitting	GWR-3-18P	2	2	Grease Whip Assy, 18 OAL
C10-GN-688	3	30	1/8 x 27 45° Angle Grease Fitting	GWR-3-24P	2	2	Grease Whip Assy, 24 OAL
C10-GN-728	3	30	3/16 Drive Fit Grease Fitting	DR-G	1	1	General Display Rack
C10-GN-743	3	30	1/4 Drive Fit Grease Fitting	C-GREASE-1	1	1	Grease-1 OUT OF STOCK Display Cards
C10-GN-911	3	30	1/4 x 28 90° Angle Grease Fitting				

NOTE: Selection and quantities suggested are based on specified product groups and rack space availability on a single panel.

GAS PRODUCT SELECTIONS WITH DISPLAY RACK



FEATURES:

All smaller sized product are supplied blister boxed and UPC bar coded. Propane Assemblies, Kits and Regulators are supplied hanger boxed with one hole punched header. Each package includes a full set of product identification cards for panel mounting on our rack. When ordering replacement packaged product, minimum carton quantities may apply. Each kit is designed for a particular application. Three different categories to choose from. Display rack is included in these selections: Includes frame panel legs and shelf.

OVERALL DIMENSIONS:

Height 67 inches
Depth 24 inches
Width 18 inches



BB-148CV-4B



BB-2499

RECREATION VEHICLE PRODUCT SELECTION PART No. GAS-RV

PART No.	Description	Qty.	Row
BB-2012	Propane Brance Tee with Handwheel P.O.L.	2	Row 1
BB-2013	Propane Branch Tee with QCC1	2	Row 1
BB-2015	Propane Branch Tee with QCC1	2	Row 1
BB-2094	Propane Cylinder Tee	2	Row 1
BB-2099	Propane Branch Tee With Handwheel	2	Row 1
BB-2499	Propane Branch Tee with QCC1	2	Row 1
BB-2000	Dual Propane Tank Manifold Tee	5	Row 2
BB-GR-1B-500	QCC1 Tailpiece (High Flow)	3	Row 2
BB-QD-GMRV-SET	Recreational Vehicle Quick Disconnect Set	3	Row 2
BB-2095	Propane Tank Adapter	3	Row 2
BB-2097	Reserve Cylinder Adapter	3	Row 2
BB-2491	Last Chance Cylinder Adapter	3	Row 2
GR-9950P	Two-Stage Propane Gas Regulator	1	Row 3
GR-9959P	Two-Stage Propane Gas Regulator	1	Row 3
GR-9984P	Two-Stage Propane Gas Automatic Changeover Regulator	2	Row 3
I4C18MI4QCCP2	Propane Gas Automatic Changeover Regulator Connection x 2	2	Row 3
I4C18MP4QCCP	Propane Gas Regulator Connection	2	Row 3
I4C48FCMCP	Propane Gas Cylinder Thread Extension Hose	2	Row 4
I4C60MCPOLHWP	Propane Gas POL Extension Hose	2	Row 4
I4C72MCQCCP	Propane Gas QCC1 Extension Hose	2	Row 4
I4C120MCQCCP	Propane Gas QCC1 Extension Hose	2	Row 4
DR-RV	Gas-Flo® Display Rack (Specify English or French)	1	
ZZCOS-LAB-GAS-RV	Identification Stickers	1	



When ordering replacement packaged product, minimum carton quantities may apply.

Hose Assemblies Approved to Canadian and U.S. Standards. Used To Conduct Natural Gas In A Gaseous State And Propane In Either A Liquid Or Gaseous State Up To 350 P.S.I.

NOTE: Selection and quantities suggested are based on specified product groups and rack space availability.

GAS PRODUCT SELECTIONS WITH DISPLAY RACK



PROPANE PRODUCT SELECTION PART No. GAS-RVGG

PART No.	Description	Qty.	Row
BB-2491	Last Chance Cylinder Adapter	3	Row 1
BB-2087	Propane Gas Tank Adapter	3	Row 1
BB-2097	Reserve Cylinder Adapter	3	Row 1
BB-2015	Propane Branch Tee with QCC1	2	Row 1
BB-2094	Propane Cylinder Tee	2	Row 1
BB-2499	Propane Branch Tee with QCC1	2	Row 1
BB-2000	Dual Propane Tank Manifold Tee	5	Row 2
BB-148CV-4B	Propane Changeover Regulator Check Valve	5	Row 2
BB-QD-GMC6-6F	Quick Disconnect Coupler	3	Row 2
C5-OR-POL	POL Replacement O-rings (5 per pack)	5	Row 2
C-PLUG-POL	Plastic POL Plug with Strap	3	Row 2
C-2081	Plastic QCC1 Cap and Lanyard	3	Row 2
I4C18MI4QCCP2	Propane Gas Automatic Changeover Regulator Connection x 2	2	Row 3
I5LTC24GRQCP	QCC1 Propane Gas Grill Hose and Regulator Replacement Kit	2	Row 3
NGO-2-HT	Natural Gas / Propane Outlet (Stainless)	1	Row 3 A
NGO-3-HT	Natural Gas / Propane Outlet (ABS Plastic)	1	Row 3 B
I4C48MCQCCP	Propane Gas QCC1 Extension Hose	2	Row 4
I4C48MCPOLHWP	Propane Gas POL Extension Hose	2	Row 4
I4C60MCPOLHWP	Propane Gas POL Extension Hose	2	Row 4
DR-RVGG	Gas-Flo® Display Rack (Specify English or French)	1	
ZZCOS-LAB-GAS-RVGG	Identification Stickers	1	



When ordering replacement packaged product, minimum carton quantities may apply.

BARBECUE PRODUCT SELECTION PART No. GAS-GG

Item No.	Description	QTY	Row
BB-QD-GMC6-6F	Quick Disconnect Coupler	5	Row 1
BB-2491	Last Chance Cylinder Adapter	3	Row 1
BB-GR-1B	QCC1 Excess Flow Tailpiece	3	Row 1
BB-2087	Propane Gas Tank Adapter	3	Row 1
BB-2095	Propane Tank Adapter	3	Row 1
BB-2097	Reserve Cylinder Adapter	3	Row 1
C5-OR-POL	POL Replacement O-rings (5 per pack)	5	Row 2
C-PLUG-POL	Plastic POL Plug with Strap	3	Row 2
C-2081	Plastic QCC1 Cap and Lanyard	3	Row 2
NGO-3-HT	Natural Gas / Propane Outlet	2	Row 2
NGO-2-HT	Natural Gas / Propane Outlet	2	Row 2
I5LTC24GRQCP	QCC1 Propane Gas Grill Hose and Reg. Kit	2	Row 3
I5LTC24GRPOL60HWP	POL Propane Gas Grill Hose & Reg. Kit	2	Row 3
I4LTC24FS6FS6GRQCP	QCC1 Propane Grill Hose + Reg. Kit with Sideburner Assembly	2	Row 3
I4C48FCMCP	Propane Gas Cylinder Thread Extension Hose	2	Row 3
I4C60MCPOLHWP	Propane Gas POL Extension Hose	2	Row 4
I4C48MCQCCP	Propane Gas QCC1 Extension Hose	2	Row 4
I4C72MCQCCP	Propane Gas QCC1 Extension Hose	2	Row 4
I4C120MCQCCP	Propane Gas QCC1 Extension Hose	2	Row 4
DR-GG	Gas-Flo® Display Rack (Specify English or French)	1	
ZZCOS-LAB-GAS-GG	Identification Stickers	1	



When ordering replacement packaged product, minimum carton quantities may apply.

AIR BRAKE ASSEMBLY DISPLAY RACK

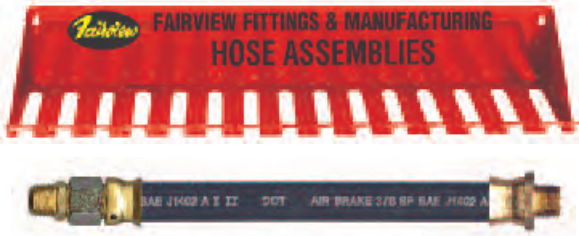

AIR BRAKE ASSEMBLY DISPLAY RACK
(For Assemblies See Pages 95 - 98)

PART No. HAR-15

- 15 fixed slots 27/32" wide to display hoses.
- Specifically designed for Fairview HAB Air Brake assemblies.
- Keeps assemblies organized, handy and ready to use.
- Mounts to the wall.
- Capable of displaying up to 75 hoses, 3/8 O.D. or 1/2 O.D. (Sold Separately)

Color
RED

Dimensions
4-3/4" H X 24-3/4" W X 6-1/2" D

AIR HOSE DISPLAY RACKS



AIR HOSE DISPLAY RACK
(For Assemblies See Page 80 - 86)

PART No. AHR-RACK

Stack-Em-Up to save space. This stand alone rack is constructed from 1/4" steel wire. Accommodates a variety of assemblies. Comes boxed complete with signage. Holds approximately 15 assemblies. (Sold Separately)
For Start-Up Packages see page 263

Color
BLACK

Dimensions
14.5" in Dia.
With detachable base
(18" Dia.) 52" High,
36" High (less sign).

WATER HOSE DISPLAY RACKS



WATER HOSE DISPLAY RACK
(For Assemblies See Page 89)

PART No. WHDR

Rack-Em-Up to save space. This rack is similar in construction to the AHR above. (Without Base)
Accommodates larger diameter water assemblies. Comes boxed complete with signage, Holds approximately 8 water hose assemblies. (Sold Separately)
For Start-Up Packages see page 263

Color
BLACK

Dimensions
17" in Dia. 52" High,
36" High (less sign).



PNEUMATIC (AIR) HOSE KITS

Each kit comes boxed complete with Assemblies, Rack & Signage.

EPDM Quality Brand, PVC Quality Brands or Ultra-Flexible 'Superflex' Brand Assemblies.



RED EPDM RUBBER AIR HOSE KITS

PART No.	Quantity	Description
AHDR-RG4RED-25B-KIT	15	1/4" I.D. X 25 Ft. Red Assemblies
AHDR-RG4RED-50B-KIT	10	1/4" I.D. X 50 Ft. Red Assemblies
AHDR-RG6RED-25B-KIT	12	3/8" I.D. X 25 Ft. Red Assemblies
AHDR-RG6RED-50B-KIT	9	3/8" I.D. X 50 Ft. Red Assemblies

SUPERFLEX YELLOW AIR HOSE KITS

PART No.	Quantity	Description
AHDR-GL4YEL-25B-KIT	15	1/4" I.D. X 25 Ft. Yellow Assemblies
AHDR-GL4YEL-50B-KIT	10	1/4" I.D. X 50 Ft. Yellow Assemblies
AHDR-GL6YEL-25B-KIT	12	3/8" I.D. X 25 Ft. Yellow Assemblies
AHDR-GL6YEL-50B-KIT	9	3/8" I.D. X 50 Ft. Yellow Assemblies

RED P.V.C. AIR HOSE KITS

PART No.	Quantity	Description
AHDR-RV4RED-25B-KIT	15	1/4" I.D. X 25 Ft. Red Assemblies
AHDR-RV4RED-50B-KIT	10	1/4" I.D. X 50 Ft. Red Assemblies
AHDR-RV6RED-25B-KIT	12	3/8" I.D. X 25 Ft. Red Assemblies
AHDR-RV6RED-50B-KIT	9	3/8" I.D. X 50 Ft. Red Assemblies

• See page 80 - 86 for Hose Assembly Specifications.

INDUSTRIAL WATER HOSE KITS

Each kit comes boxed complete with Assemblies, Sample Hose, Rack & Signage.

Choose from Fairview's heavy-duty Rubber '*Contractor's Choice*' brand, Non-Marking '*Blue Star*' brand or Ultra-Flexible '*Superflex*' brand.

Rack Measures: 17" in Dia. (Minimal Floor Space Required)



PART No.	Quantity	BLUE STAR WATER HOSE KITS
WHDR-BLU-KIT	8	1/2" I.D. X 50 Ft. Non-Marking Blue Star Assemblies. (PART No. WHRV8BLU-50H) 1 16" Hose Assembly Sample. 1 Hose Display Rack. 1 Display Sign.

PART No.	Quantity	BLACK STAR WATER HOSE KITS
WHDR-BLK-KIT	7	5/8" I.D. X 50 Ft. Black Rubber Contractors Choice Assemblies. (PART No. WH10BLK-50H) 1 16" Hose Assembly Sample. 1 Hose Display Rack. 1 Display Sign.

PART No.	Quantity	SUPERFLEX GREEN WATER HOSE KITS
WHDR-GRN-KIT	8	1/2" I.D. X 50 Ft. Low Temperature Superflex Assemblies. (PART No. WHGL8GRN-50H) 1 16" Hose Assembly Sample. 1 Hose Display Rack. 1 Display Sign.

• See page 89 for Hose Assembly Specifications.



PART No. HCR-10-RACK
(Rack & sign only)
Rack Size H: 13.375" W: 20" D: 7"

Accutek™ Auto Clamp Kit. Containing a selection of Common Size Clamps together with a Storage Rack.

PART No. HC6-AUTO-KIT-1

*Thin Band Gear Clamps

PART No.	Quantity in Kit	Range (IN.)	Range (MM)
HC6-4TB *	50	.22 - .63	6 - 16
HC6-6TB *	30	.31 - .88	8 - 22
HC6-8	20	.43 - 1.00	11 - 25
HC6-10	40	.56 - 1.06	14 - 27
HC6-12	20	.56 - 1.25	14 - 32
HC6-16	10	.68 - 1.50	17 - 38
HC6-20	20	.75 - 1.75	19 - 44
HC6-24	20	1.06 - 2.00	27 - 51
HC6-28	20	1.31 - 2.25	33 - 57
HCR-10-RACK	1	Storage Rack	

(Heavy Gauge Steel Wire Rack for Wall / Counter Top)



PART No. HCR-18-RACK
(Rack & sign only)
Rack Size H: 24" W: 24" D: 7"

Accutek™ T-Bolt Clamp Kit. Containing a selection of Common Size Clamps together with a Storage Rack.

PART No. HC3-KIT-1

Contains: T-Bolt Style Clamps

PART No.	Quantity in Kit	Range (IN.)	Range (MM)
HC3-150	5	1.31 - 1.56	33 - 40
HC3-175	5	1.56 - 1.81	40 - 46
HC3-188	5	1.69 - 1.94	43 - 49
HC3-200	5	1.81 - 2.06	46 - 52
HC3-225	5	2.06 - 2.31	52 - 59
HC3-238	5	2.19 - 2.50	58 - 64
HC3-250	4	2.31 - 2.62	59 - 67
HC3-275	4	2.56 - 2.87	65 - 73
HC3-288	4	2.69 - 3.00	68 - 76
HC3-300	4	2.81 - 3.12	71 - 79
HC3-325	4	3.06 - 3.37	78 - 86
HC3-350	3	3.31 - 3.62	84 - 92
HC3-375	3	3.56 - 3.87	90 - 98
HC3-400	3	3.81 - 4.12	97 - 105
HC3-425	3	4.06 - 4.37	103 - 111
HC3-450	2	4.31 - 4.62	110 - 117
HC3-475	2	4.56 - 4.87	116 - 124
HC3-500	2	4.81 - 5.12	122 - 130
HCR-18-RACK	1	Storage Rack	

(Heavy Gauge Steel Wire Rack for Wall / Counter Top)

CARDBOARD STOCK BOXES

Sectional for multi-product storage...



PART No. GS-STOCK BOX
Description STANDARD

- Dimensions:** 5" W X 11" L X 4" D
- Supplied Flat For Easy Storage (Folding required)
 - Label sets available.

For bulk or large item storage...



PART No. GS-STOCK BOX-2
Description DOUBLE

- Dimensions:** 10" W X 11" L X 4" D
- Supplied Flat For Easy Storage (Folding required)
 - Label sets available.

Non-sectional for one product storage...



PART No. GS-STOCK BOX-1
Description SMALL

- Dimensions:** 2 3/4" W X 11" L X 4" D
- Supplied Flat For Easy Storage (Folding required)
 - Label sets available.

CRIMPER COMPATIBILITY CHART

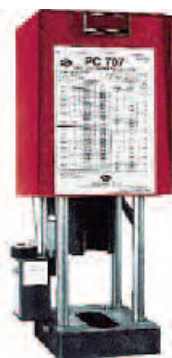

Fairview PART No.	WeatherHead	Parker	Dayco	Imperial	Gates	OmniCrimp	Aeroquip
SC600	T-400 T-407 T-410 T-420 T-440 T-450 T-460 T-462		NP-30 NP-60	K-201 K-202 K-401 K-501 K-601 K-24 K-16 K-20	PC707	3000B	FT1380
SCTGW600	T-400 T-407 T-410 T-420 T-440 T-450 T-460 T-462		NP-30 NP-60	K-201 K-202 K-401 K-501 K-601 K-24 K-16 K-20	PC707	3000B	FT1380
SC900		Minicrimp Karrykrimp 1 & 2 Parkrimp 1 & 2 PHastkrimp	NP-30 NP-60	K-201 K-202 K-401 K-501 K-601 K-24 K-16 K-20	PC707	3000B	FT1380
SCT900MS		Karrykrimp 2 Parkrimp 2 PHastkrimp	NP-30 NP-60	K-201 K-202 K-401 K-501 K-601 K-24 K-16 K-20	PC707	3000B	FT1380
SCTBW00			NP-30 NP-60 K-401	K-201 K-202 K-501 K-601 K-24 K-16 K-20	PC707	3000B	FT1380

Any other adjustable crimper not shown.

K



CONVERSION CHARTS

PROPANE CYLINDER CAPACITIES

Cylinder Size	Gallon Capacity	Total BTU Capacity
20#	4.8	441,600
30#	7.1	653,200
40#	9.5	874,000
60#	14.3	1,315,600
100#	23.8	2,189,600
200#	47.2	4,342,400
420#	99.1	9,117,200

VAPOR PRESSURES OF LP-GAS

Temp. (°F)	Temp. (°C)	Press. PSIG	Temp. (°F)	Temp. (°C)	Press. PSIG
-40	-40	1.3	40	4.4	63.3
-30	-34	5.5	50	10	77.1
-20	-29	10.7	60	15.6	92.5
-10	-23	16.7	70	21.1	109.3
0	-17.8	23.5	80	26.7	128.1
10	-12.2	31.3	90	32.2	149.3
20	-6.7	40.8	100	37.8	172.3
30	-1.1	51.6	110	43	197.3

CONVERTING VOLUMES OF GAS (CFH to CFH or CFM to CFM)

Multiply Flow of:	By	To Obtain Flow of:
Air	0.707	Butane
	1.290	Natural Gas
	0.808	Propane
Butane	1.414	Air
	1.826	Natural Gas
	1.140	Propane
Natural Gas	0.775	Air
	0.547	Butane
	0.625	Propane
Propane	1.237	Air
	0.874	Butane
	1.598	Natural Gas

BASIC FACTS OF PROPANE

Boiling Point	-44°F
Specific Gravity of Gas (Air = 1.00)	1.53
Specific Gravity of Liquid (Water = 1.00)	0.51
Lbs per Gallon of Liquid at 60 °F	4.24
BTU per Gallon of Gas at 60 °F	91,660
BTU per Lb. Of Gas	21,591
BTU per Cubic Ft of Gas at 60 °F	2500

PRESSURE CONVERSION CHART

Multiply	By	To Obtain
Atmospheres	1.03332	Kilograms per sq. centimeter
Atmospheres	14.70	Pounds per square inch
Atmospheres	407.14	Inches water
Grams per sq centimeter	0.0142	Pounds per square inch
Inches of mercury	0.4912	Pounds per square inch
Inches of mercury	1.133	Feet of water
Inches of water	0.0361	Pounds per square inch
Inches of water	0.0735	Inches of mercury
Inches of water	0.5781	Ounces per square inch
Inches of water	5.204	Pounds per square foot
KPA	100	Bar
Kilograms per sq. centimeter	14.22	Pounds per square inch
Kilograms per sq. meter	0.2048	Pounds per square foot
Pounds per square inch	0.06804	Atmospheres
Pounds per square inch	0.07031	Kilograms per sq. centimeter
Pounds per square inch	0.145	KPA
Pounds per square inch	2.036	inches of mercury
Pounds per square inch	2.307	Feet of water
Pounds per square inch	14.5	BAR
Pounds per square inch	27.67	Inches of water

LENGTH CONVERSION CHART

Multiply	By	To Obtain
Centimeters	0.3937	Inches
Feet	0.3048	Meters
Feet	30.48	Centimeters
Feet	304.8	Millimeters
Inches	2.54	Centimeters
Inches	25.4	Millimeters
Kilometer	0.6214	Miles
Meters	1.094	Yards
Meters	3.281	Feet
Meters	39.37	Inches
Yards	0.9144	Meters
Yards	91.44	Centimeters

VOLUME CONVERSION CHART

Multiply	By	To Obtain
Cubic Feet	7.4805	Gallons (US)
Cubic Feet	28.316	Liters
Cubic Feet	1728	Cubic Inches
Gallons (Imperial)	1.20095	Gallons (US)
Gallons (Imperial)	0.1337	Cubic Feet
Gallons (US)	0.83267	Gallons (Imperial)
Gallons (US)	231	Cubic Inches

SIZE CHARTS



ACTUAL OUTSIDE DIAMETERS OF PIPE THREADS

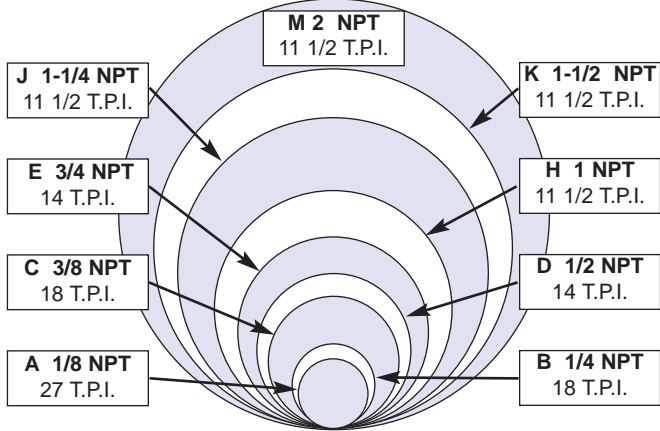

ACTUAL OUTSIDE DIAMETERS OF TUBING

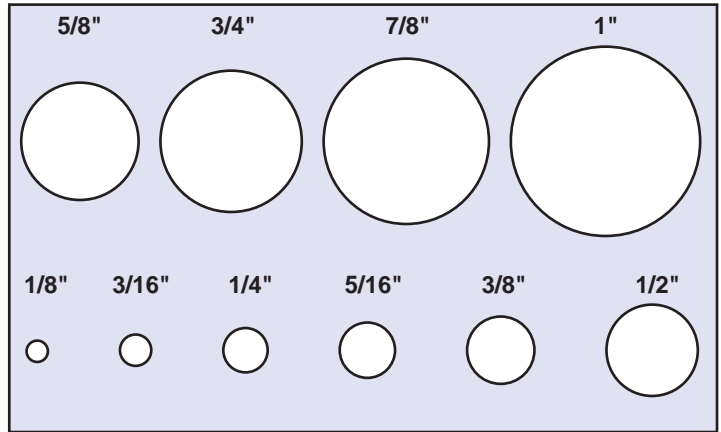

FRACTIONAL SIZE CODES

Used with all Part Numbers to designate Tube and Pipe Fractional Sizes.

Tube Size Code -- 1/16ths

1/8	3/16	1/4	5/16	3/8	7/16	1/2	5/8	3/4	7/8	1	1-1/4	1-1/2	2	2-1/2	3	4
2	3	4	5	6	7	8	10	12	14	16	20	24	32	40	48	64

Pipe Size Code

1/16	1/8	1/4	3/8	1/2	3/4	1	1 1/4	1 1/2	2	2-1/2	3	4
1	A	B	C	D	E	H	J	K	M	N	P	S

METRIC THREAD STANDARDS

TUBE SIZE MM	DIN METRIC (LIGHT)	DIN METRIC (HEAVY)
6	M12x1.5	M14x1.5
8	M14x1.5	M16x1.5
10	M16x1.5	M18x1.5
12	M18x1.5	M20x1.5
14	--	M22x1.5
15	M22x1.5	--
16	--	M24x1.5
18	M26x1.5	--
20	--	M30x2.0
22	M30x2.0	--
25	--	M36x2.0
28	M36x2.0	--
30	--	M42x2.0
35	M45x2.0	--
38	--	M52x2.0
42	M52x2.0	--

TUBE FITTING SIZE AND THREAD STANDARDS

DASH SIZE	O.D. TUBE SIZE	45° S.A.E. FLARE THREAD		37° J.I.C. FLARE THREAD		COMPRESSION THREAD		45° INVERTED FLARE THREAD		THREADED SLEEVE THREAD	
		O.D.	THREAD	O.D.	THREAD	O.D.	THREAD	O.D.	THREAD	O.D.	THREAD
-2	1/8	5/16	24	5/16	24	5/16	24	5/16	28	5/16	24
-3	3/16	3/8	24	3/8	24	3/8	24	3/8	24	3/8	24
-4	1/4	7/16	20	7/16	20	7/16	24	7/16	24	7/16	24
-5	5/16	1/2	20	1/2	20	1/2	24	1/2	20	1/2	20
-6	3/8	5/8	18	9/16	18	9/16	24	5/8	18	9/16	20
-8	1/2	3/4	16	3/4	16	5/8	24	11/16	18	5/8	18
-10	5/8	7/8	14	7/8	14	11/16	20	3/4	18	11/16	16
-12	3/4	1-1/16	14	1-1/16	12	13/16	18	7/8	18	--	--
-14	7/8	1-1/4	12	1-3/16	12	1	18	1-1/16	16	--	--
-16	1	1-3/8	12	1-5/16	12	1-1/8	18	1-3/16	16	--	--
-20	1-1/4	--	--	1-5/8	12	1-1/4	16	--	--	--	--
-24	1-1/2	--	--	1-7/8	12	--	--	--	--	--	--
-32	2	--	--	2-1/2	12	--	--	--	--	--	--

TUBE FITTING SIZE AND THREAD STANDARDS

DASH SIZE	O.D. TUBE SIZE	O-RING BOSS		FLARELESS		O-RING FACE SEAL		BRITISH PIPE TAPER		BRITISH PIPE PARALLEL	
		O.D.	THREAD	O.D.	THREAD	O.D.	THREAD	O.D.	THREAD	O.D.	THREAD
-2	1/8	5/16	24	5/16	24	--	--	--	--	--	--
-3	3/16	3/8	24	3/8	24	--	--	--	--	--	--
-4	1/4	7/16	20	7/16	20	9/16	18	1/4	19	1/4	19
-5	5/16	1/2	20	1/2	20	--	--	--	--	--	--
-6	3/8	9/16	18	9/16	18	11/16	16	3/8	19	3/8	19
-8	1/2	3/4	16	3/4	16	13/16	16	1/2	14	1/2	14
-10	5/8	7/8	14	7/8	14	1	14	5/8	14	5/8	14
-12	3/4	1-1/16	12	1-1/16	12	1-3/16	12	3/4	14	3/4	14
-14	7/8	1-3/16	12	1-3/16	12	--	--	--	--	--	--
-16	1	1-5/16	12	1-5/16	12	1-7/16	12	1	11	1	11
-20	1-1/4	1-5/8	12	1-5/8	12	1-11/16	12	--	--	--	--
-24	1-1/2	1-7/8	12	1-7/8	12	2	12	--	--	--	--
-32	2	2-1/2	12	2-1/2	12	--	--	--	--	--	--

K



INDEX

SERIES	PAGE	SERIES	PAGE	SERIES	PAGE	SERIES	PAGE	SERIES	PAGE	SERIES	PAGE
14DV	172	108CA	19	262	168	977	63	2090	34	AG411EW	239
25-DR	257	109	18	293	173	1048	168	2091	32	AHDR	262, 263
25-DR-PANEL-A	257	110	18	298	173	1049	167	2092	32	AIR-1	258
25-DR-PANEL-AF	257	110CA	18	325	58	1054	167	2093	32	AIR-2	258
25-DR-PANEL-G	257	111	18	335	58	1115	167	2094	34	AIR-3	258
25-DR-PANEL-GAS	257	112	17	339	58	1122	168	2095	32	ALT	148
25-DR-PANEL-GAS-F	257	112RED	17	359	145	1139	167	2096	32	ARG4BLK	133
25-DR-SHELF	257	113	17	360	145	1160	23, 72	2097	32	ASGK	106, 232
30	2	113RED	17	363	145	1161	23, 72	2098	32	ASTM-KIT	8
31	2	114	20	462	12	1162	23	2099	34	B1492	28
32	2	116	19	462R	12	1164	23	2101	167	BB-148CV	32, 261
33	2	116CA	19	464	12	1168	23	2102	167	BB-2000	34, 260 - 261
34	2	116H	19	464R	12	1169	23	2103	169	BB-2003	32, 260 - 261
34R	2	117	18	465	12	1170	23	2120	169	BB-2012	34, 261
35	2	118	18	466	12	1171	23	2122	169	BB-2015	34, 260 - 261
36	3	119	18	467	12	1172	23	2309	35	BB-2081	33
39	2	120	18	468	12	1174	23	2320	35	BB-2087	32, 261
40	2	121	19, 245, 255	469	12	1460	24	2329	35	BB-2094	34, 260 - 261
40R	2	121-M8	245	470	12	1461	24	2341	35	BB-2095	32, 260
41	2	121S	19	471	12	1462	24	2360	35	BB-2098	32
41S	2	122	17, 255	472	12	1464	24	2368	35	BB-2097	32, 260 - 261
42	2	122L	17	474	12	1464R	24	2370	35	BB-2099	34, 260
42-CA	253	123	57	477	12	1465	24	2372	35	BB-2491	32, 260 - 261
42R	2	124	19	478	12	1466	24	2410	35	BB-2499	34, 260 - 261
42SW	9	125	56	480	12	1468	24	2380	35	BB-GR-1B	33, 261
44	4	125CA	56	481	12	1469	24	2491	32	BB-GR-610B	206
44R	4	126	56	485	143	1470	24	2499	34	BB-GR-700B	205
45	4	127	56	486	143	1471	24	2815-2836	106	BB-OR-POLP5	33, 261
46	2	128	56	487	143	1472	24	3042	166	BB-PLUG-POL	33, 261
46SW	9	129	57	525	57	1474	24	3049	166	BB-OD	192, 261
47	3	130	56	526	57	1476	24	3062	166	BBV	238
48	3	131	56	529	57	1477	24	3069	166	BC	172
48SW	9	132	38	539	57	1479	24	3103	166	BC-B	172
49	3	133	38	539F	57	1481	24	3120	166	BEM	238
50	3	134	56	544	57	1485	142	3122	166	BI-100	22
51	3	135	38, 236	555	57	1486L	99	3462	166	BI-101	22
52	4	136	38	560	14	1486S	99	3469	166	BI-102	22
53	3	137	38	561	14	1490	28	3720	5	BI-103	21
54	3	138	38	562	14	1491	28	3721	5	BI-103HMC	23
55	3	139	56	562R	14	1492	28	3742	5	BI-103MC	23
55R	3	140	56	564	14	1492SW	28	3744	5	BI-104	21
56	4	141	6	565	14	1493	28	3746	5	BI-105	22
58	4	142	6, 7	566	14	1493SW	28	3748	5	BI-108	22
59	4	142BR	6	568	14	1494	28	3749	5	BI-109	22
60	10, 87	142EU	6, 7	568BLK	14	1495	28	3754	5	BI-109MC	23
61	9, 12	142JA	6, 7	569	14	1495B	28	4120R-6C-RK	29	BI-110	21
61CAP	10	142MM	6	570	14	1496	28	4120R-6D-RK	29	BI-110MC	23
61CS	10	144	7	572	14	1497	28	4120R-8C-RK	29	BI-111	22
62	10	145	7	577	14	1498	28	4134	28	BI-112	21
62GR	10	146	7	678-YB	20	1498N	28	5103	169	BI-113	21 - 22
62R	10	148	7, 32	725	59	1499	28	5120	169	BI-116	22
64	11	148CV	32	725SW	59	1499N	28	5122	169	BI-119	21
64R	11	149	7	726	59	1561	14	6103	170	BI-124	22
65	11	150	7	727	59	1925	56	6120	170	BI-125	58
65R	11	151	7	728	59	1935	87	6122	170	BI-129	58
66	10	154	7	729	59	1936	86	6125	170	BL	140
67	10	161	10	730	59	1960	87	7103	170	BLA	140
68	10	181	8, 37	731	59	1978	87	7120	170	BLE	140
69	11	188	8	732	59	1985	32	8103	170	BLJ	140
70	11	189	8	735	59	1985--100	87	8120	170	BLN-KIT-1	7
71	11	193	30	736	59	2000	34	8125	170	BLP	140
72	11	194	30	737	59	2001	34	8815	33	BLPE	140
72-CA	253	195	30	738	59	2002	32, 33, 236	ABFR-KIT	27, 29	BLT	148
74	11	196	30	739	59	2003	32, 33, 207	ACM	136 - 137	BSCM	238
77	10	197	30	750	63	2004	33	ACS	134	BTV	172
78	11	198	30	751	63	2005	33	ACSD	135	BV1048	168
79	11	199	30, 31	752	63	2008	33	ACSHF	135	BV1049	168
81	37	199S	30	760	105	2010	33	AF42	215	BV1122	168
99	19	200	30	761	105	2011	33	AF44	215	BV1199	168
99HB	57	201	30	850	165	2012	34	AF48	214	BV2062	168
100	19	202	31	851	165	2013	34	AF60	214	BV2101	160
100CA	19	203	30	852	165	2014	32	AF679	214, 216	BV2101T	160
101	20	204	31	853	165	2015	34	AFFKB	215	BV2103	160, 163
101CA	20	206	30	854	165	2016	33	AFFK90	215	BV2203P	164
101M	20	217	167	860	9	2017	32	AFGC	216	BV3103	161
102	20	224	168	861	9	2018	33	AF-GLC	216	BV3120	161
102HB	57	225	168	862	8, 9	2019	33	AF-LMB	215	BV4103	160
103	17, 18	239	171	868	8, 9	2042	169	AF-MSB	216	BV5042	163
103CA	18	240	171	869	8, 9	2048	169	AFSP	216	BV5046	163
103CV	173	241	171	962	63	2068	169	AF-WALLBOX	216	BV5048	163
104	18	241HP	171	964	63	2081	33	AG164	239	BV5221	163
105	20	242	171	965	63	2082	33	AG165	239	BV5223	163
106	20	243	171	966	63	2087	32	AG166	239	BV9503	164
107	20	245	171	968	63	2088	227, 228	AG410R	239	BVC4103	160
108	19	260	10	969	63	2089	227, 228	AG411E	239	BVCS2103	161

INDEX



SERIES	PAGE	SERIES	PAGE	SERIES	PAGE	SERIES	PAGE	SERIES	PAGE	SERIES	PAGE
BVCS2203	162	GNM-100-KIT	39	HC9-S	243	PC62	15	PG-* V30CG25	198	QD-RVSDC	192
BVCS2303	162	GO	37	HC10	154	PC64	15	PG-* V30SD2	195	QD-SCAROMC	189
BVCS2403	162	GR-1B	33	HC14	153	PC65	15	PG-* V30SG25	198	QD-SCCEJNC	190
BVCS2434	162	GR-207	208	HC19	152	PC66	15	PG-*WCSD25	194	QD-SCINDMC	189
BVPEX21	166	GR-320	207	HC20	152	PC67	16	PG-55/250	196	QD-SISOBC	177
BVSE2103	160	GR-330	207, 236	HC21	153	PC68	15	PG-75/320	196	QD-SISOBN	177
BVSS2003	161	GR-334	207	HCB	248	PC69	15	PGD	212	QD-SP90	178
BVSS2103	161	GR-338	207, 236	HCBS	248	PC69SW	15	PG-MB	198	QD-SSTC	191
BVSS2203	162	GR-340	207	HCPEX	156, 242	PC70	15	PG-PM	198	QD-SSTN	191
BVSS2403	162	GR-360	207	HCR-10	264	PC70SW	15	PG-RC4	198	QD-STN	191
BVT5103	163	GR-364	207	HCR-18	264	PC71	15	PG-RC25	198	QD-TCC	179
BVTM5042	164	GR-365	207	HH	104	PC71SW	15	PG-RF4	198	QD-TCMDC	179
BVTM5103	164	GR-368	207	HHP	104	PC72	15	PG-SNUBBER	198	QD-TCMDP	179
C-GWC	39, 240, 259	GR-555	38	HHR	104	PC72SW	16	PL141	6	QD-TCN	179
C10-GN	39, 259	GR-610B	206	HHS	103	PC77	15	PLUG-POL	33	QD-TFMC	187
CHS	103	GR-615B	206	HPA	84	PC78	16	PM-LABEL	254	QD-TFN	187
CMD	213	GR-630B	206	HPT-KIT	242	PC86	15	PM-PLASTIC	254	QD-UNIAC	188
CP	139	GR-700B	205	HR3	109	PC1400	26	PPV-90PC	172	QD-VHC	181
CSST	213	GR-756	205	HR4	109	PC1462	25, 27	PS	158	QD-VHN	181
CTG	146	GR-766	205	HR5	100	PC1464	25	PSL	158	QD-WHCF	31, 191
CTGB	147	GR-776	205	HR5HT	100	PC1465	25	PTALT33	229	QD-WHNM	31, 191
CTK	147	GR-800	204	HR7	110	PC1466	25	PTS	230	QD-WHVCF	31, 191
CTL	146	GR-856	204	HR16	111	PC1468	25, 27	PTSLT33	229	QS	250
CTLG	147	GR-866	204	HR17	111	PC1469	25, 27	PVC	144	QTB	250
CTLO	148	GR-876	204	HRA12	110	PC1469SW	25	PW2	91	R16	232
CTR	146	GR-900	202, 203	HS11	157	PC1470	25	PW2A	92	RG4	82, 263
CV1	173	GR-905	200, 201	HT	102	PC1471	26	PW2K	93	RG4/2	82
D19 - D80	237	GR-918	200	HV1139	167	PC1471SW	26	PW3	91	RG6	82
DR-3GH	257	GR-928	200	HW	33	PC1472	26	PW3A	92	RG6/2	82
DR-4GH	257	GR-948	201	I4C	123 - 126, 128, 236	PC1472SW	26	PW3K	93	RG8	82
DR-5GH	257	GR-5950	203	I4LTC	123	PC1474	25	PW4	91	RG8/2	82
DR-6GH	257	GR-5959	203	I4TC	123 - 126 128	PC1474SW	25	PW4A	92	RGP	82
DS2	237	GR-5984	202	I5LTC	129	PC1477	25	PW4K	93	RHK	135
DS3	237	GR-9188	200	I6C	123 - 124, 130	PC1478	26	PW5	91	RP4	80
DS4	237	GR-9212	200	I6NGTC	130	PC1478SW	26	PW5A	92	RP6	80
DS5	237	GR-9412	201	I6TC	126	PC1483	25	PW6	91	RP8	80
DS6	237	GR-9448	201	I8C	123, 130	PC1486	25	PW6A	92	RPH	80
DS-B	243	GR-9950	203	I12C	123 - 124	PD-110	251 - 252	QB-1	158	RR12	243
DWF-6	31	GR-9950P	203	I16C	123 - 124, 131	PD-55	251 - 252	QD-71	180	RV-BAR	230
DWH	90	GR-9952	203	I20C	123 - 124	PEX-	156	QD-75C	183	RV-PAN	230
ET	150	GR-9954	203	ICR20C	131	PEX-99HB	60	QD-75MDC	183	RV-TANK	230
ETM	150	GR-9956	203	ICR32C	131	PEX-121HB	60	QD-75MDP	183	RV-TR	230
FA154SN	239	GR-9958	203	I18C	132	PEX-123	60	QD-75N	183	RV-WINGNUT	230
FBL	58	GR-9959	203	I112C	132	PEX-125	60	QD-ADCH	183	RV4	85, 263
FBS	58	GR-9959P	203	I116C	132	PEX-125SW	60	QD-AGC	178	RV6	85
FF105	246	GR-9984	202	I120C	132	PEX-126	60	QD-AGN	178	RVH	85
FKAR	88	GR-9984P	202	I132C	132	PEX-126SPN	60	QD-AROAC	187	RW4	81
FKGF-KIT-1	4	GREASE-1	259	I114C	132	PEX-126SW	60	QD-ARON	187	RW4/2	81
FKRV-KIT-1	4	GR-RVB	202 - 203	I116C	132	PEX-129	60	QD-BISOBC	177	RW6	81
FKGO	37	GR-RVKIT	127	I118C	132	PEX-139	60	QD-BISOBN	177	RW6/2	81
FKPL	37	GS21	37	J660	246	PEX-139FSPN	60	QD-BSTC	191	RW8/2	81
FKTM	8	GS22	37	JFT	144	PEX-139FSW	60	QD-BSTN	191	RWH	81
FLH	101	GS-STOCK BOX	264	KIT-1400	256	PEX-139SW	60	QD-BTTWC	182	RX	227, 228
FLT	143	GWC	39, 240, 259	KIT-AUTO	256	PEX-KIT	62	QD-BTTWDC	182	S50	3
FO41S	2	GWN	106	KIT-INDUS	255	PEX-S139F	66	QD-BTTWDP	182	S141	6, 7
FT	244	GWR	106	KIT-PC1400	256	PEXPL-99HB	61	QD-BTTWN	182	S1000	51
FW-CYLINDER-1	232	GV	226	KIT-PLUMB	256	PEXPL-123	61	QD-CEJNMC	190	S1001	51
FWSK	106, 232	GV65	226	KIT-TRUCK	255	PEXPL-125	61	QD-CEJNN	190	S1001M	51
G1008	37	GVF65	226	LAB	254	PEXPL-126	61	QD-GM2C	192	S1002	52
G261	168	GVP65	226	LAS	153	PEXPL-129	61	QD-GM2N	192	S1003	50
G3015	37	GV6590	226	LP-PURGE	133	PEXPL-121HB	61	QD-GMC	192	S1004	51
G3020	37	HA	113	MC	16, 243	PEXPL-139	61	QD-GMDC	192	S1005	51
GASTAPE	147	HAB-6	94 - 96, 98	MCB	16, 243	PF-361	217	QD-GMDP	192	S1005M	51
GG	240	HAB-8	94, 96, 98	MCE	243	PF-362	217	QD-GMN	192	S1006	51
GH	174	HABA-6	94	MGV	168	PF-4 - 7	218 - 224	QD-GMRVC	192	S1006M	51
GH-8YEL	90	HABA-8	94	MP-BP	248	PF-MTYG	217	QD-GMRVN	192	S1007	52
GHE	174	HAB-HANGER	156	MP-SBP	248	PF-TW	217	QD-HTMAC	180	S1008	52
GHFN	241	HAB-HC2E	156	MX-325	208	PG-* CD125	194	QD-HTMAN	180	S1009	50
GHM	174	HAB-HCE	156	NGO	209 - 211	PG-* CD15	194	QD-INDAC	186	S1010	50
GHN	241	HAB-HCU	156	NGO-2	209	PG-* CD2	194	QD-INDMC	185	S1012	50
GHN6	241	HAB-NOSE	98	NGO-3	209	PG-* CG25	197	QD-INDN	185, 186	S1013	50
GHN10	241	HAB-SPRING	156	NGO-4	210	PG-* CG25LT	197	QD-ISOAC	179	S1016	50
GHNE	241	HAR	262	NGO-5	211	PG-* CGV25	198	QD-ISOAN	179	S1016SW	51
GHPS	241	HBA	101	NGO*2LB	210	PG-* SD15	194	QD-ISOBC	177	S1018	51
GHS	174	HBAL	101	NGO-*DUAL	211	PG-* SD2	194	QD-ISOBN	177	S1020	50
GHTN	241	HC2	151	NG-OUTLET	209, 211	PG-* SD25	194	QD-KARCHER	31, 191	S1021	50
GHU	112, 174	HC3	151	NG-PURGE	133	PG-* SDV2	195	QD-KARN	31, 191	S1022	50
GHV	174	HC3-KIT-1	264	NS	248	PG-* SG25	197	QD-LINMC	188	S1024	51
GHW	30	HC4	150	OE-SB80	154	PG-* SG25LT	197	QD-LINN	188	S1099	51
GL4	83	HC5	150	OR-POL	33	PG-* SG4	197	QD-MINIAC	188	S1099SW	51
GL6	83, 99, 263	HC6	150	P100D	246	PG-* SG4LT	197	QD-MININ	188	S1100	53
GLH	83	HC6-AUTO-KIT-1	264	PA4	84	PG-* SG4SS	197	QD-PDC	177-179, 181	S1101	53
GN	39	HC8	153	PA6	84	PG-* SGRF	198	QD-PDP	177-179, 181	S1103	53
GN-100-KIT	39	HC9	154	PA8	84	PG-* SGRFLT	198	QD-PHC	181	S1105	53
GNM	39	HC9-R	243	PAR6	86	PG-* SGV25	198	QD-PHN	181	S1106	53



INDEX

SERIES	PAGE	SERIES	PAGE	SERIES	PAGE	SERIES	PAGE	SERIES	PAGE	SERIES	PAGE
S1111	53	S3947	48	SCK639BSP	65	SY-3130	114, 116				
S1116	53	S3948	48	SCT425	71	SY-3440	115				
S1116L	53	S3951F	48	SCT438	71	SY-3770	114, 116, 120				
S1120	53	S3955	48	SCT900MS	68	SY-37AL	117				
S1124	53	S3956	48	SCT900MS62	68	SY-3901	75				
S1125	73	S3958	48	SCT925MS	68	SY-3903	75, 77				
S1139	73	S3968	48	SCT931BSPMS	68	SY-390H	76, 77				
S1140	73	S3969	48	SCT937MS	68	SY-390N	77				
S3069	165	S3969F	48	SCT938MS	68	SY-3E80	119				
S3516	41	S3971	48	SCT939MS	68	SY-3R30	115				
S3520	41	S3974	48	SCT940MS	68	SY-3R80	118				
S3522	41	S6760	49	SCT950MS	68	SY-3V10	121				
S3526	41	S6761	49	SCT958MS	68	SY-3VE0	122				
S3542	41	S6762	49	SCT959MS	68	SY-4521	248				
S3545	41	S6764	49	SCT990MS	68	SY-4523	243				
S3549	41	S6765	49	SCT990MS62	68	SY-4530	247				
S3549BT	41	S6766	49	SCTBW00	74, 265	SY-453C	247				
S3549LBT	41	S6768	49	SCTGW638	69	SY-4540	247				
S3551	41	S6769	49	SCTGW639	69	SY-4574	243				
S3554	41	SB141	6	SCTGW658	69	SY-4599	247				
S3599	41	SC600	265	SCV1003	173	SY-45J0	247				
S3616	47	SC616SW	65	SCW525	69	T1	108				
S3618	46	SC625	64	SCW528	69	T10	244				
S3620	46	SC625SW	64	SCW538	69	T1SN	107				
S3621	46	SC626	64	SCW539	69	T2	108				
S3622	46	SC626GT	64	SCW540	69	T241	171				
S3622F	46	SC626SW	64	SE141	6, 7	T2SN	107				
S3623	46	SC628	64	SE143	6	T445	233				
S3631R	47	SC629	65	SE-BH	234	T68	10				
S3642	46	SC631	65	SE-EW	234	T9	244				
S3645	47	SC632	65	SE-PRT	234 - 235	T95	233				
S3648	46	SC635	64	SE-THP	234	T95-* KIT	235				
S3648L	46	SC636	65	SE-TSS	234	TC	244				
S3649	47	SC637	64	SFK61	45	TCS2	103				
S3649EL	47	SC638	64	SFK62	45	TCS3	103				
S3651	47	SC639	65	SFL	6, 7	TCW	244				
S3654	47	SC639L	65	SFO	45	TE-PRV-E	227, 228				
S3655	47	SC640	65	SFPK2661	45	TGI	243				
S3699	47	SC641	65	SFPK2662	45	TGM	243				
S3700BT	45	SC642	65	SFPK3461	45	TIE	156				
S3700BT62	45	SC643	64	SFPK3462	45	TPG-1	195				
S3705	44	SC643SW	64	SJ141	6, 7	TR-1	244				
S3720	42	SC650	65	SJ143	6, 7	TS14	157				
S3721	42	SC653	64	SL141	6, 7	TS15	157				
S3735	42	SC658	64	SLE141	6	TS16R	157				
S3736	44	SC659	65	SLJ141	6, 7	TS17R	157				
S3740BT	45	SC667	65	SO1116	52	TS19	157				
S3742	42	SC725	73	SO1120	52	TS20	157				
S3742H	42	SC725SW	73	SO1124	52	TS21	157				
S3744	44	SC726SW	73	SO1125	73	TS22	157				
S3745	44	SC738	73	SO1139	73	TSS17R	157				
S3746	42	SC900	265	SO1140	73	TTS	245				
S3748	42	SC916SW	67	SR425	72	TTSG	245				
S3748BSPP	42	SC925	66	SR428	72	TTSM	245				
S3749	43	SC925SW	66	SR435	72	TTSP	245				
S3749BSPP	43	SC926	66	SR438	72	VH	138				
S3749EEL	43	SC926GT	66	SR439	72	W80	233				
S3749EL	43	SC926SW	66	SR440	72	W80-KIT	235				
S3749L	43	SC928	66	SR462	72	WET-KIT1	112				
S3750	43	SC929	67	SR468	72	WET-KIT2	112				
S3751	44	SC931	67	SR4S	72	WH-	6 - 8				
S3752	44	SC931BSP	67	SR525	70	WH-705	238				
S3754	43	SC931JIS	67	SR527	70	WH8	89				
S3755	43	SC931LM	67	SR528	70	WH10	89				
S3756	43	SC935	66	SR535	70	WH12	89				
S3758	43	SC936	67	SR537	70	WHDR	262, 263				
S3790BT	45	SC937	66	SR538	70	WHGL	89				
S3790BT62	45	SC938	66	SR539	70	WHRV	89				
S3831N	44	SC939	67	SR539L	70	WSPEX68	166				
S3842	44	SC939BSP	67	SR541	70	WSPEX69	166				
S3845	44	SC939L	67	SR540	70	X100	19				
S3846	44	SC940	67	SR545	70	X101	20				
S3848	44	SC940BSP	67	SR595	70	X102	20				
S3851	44	SC941	67	SR725SW	73	X105	20				
S3854	44	SC943	66	SR738	73	X106	20				
S3855	44	SC943SW	66	SRT125	71	X107	20				
S3931N	48	SC950	67	SRT138	71	X115	19				
S3931R	48	SC953	66	SRT225	71	X124	19				
S3935	48	SC958	66	SRT238	71	XB20	253				
S3937	48	SC959	67	SSH	138	XC80	251				
S3937F	48	SC967	66	ST3	233	XC110	252				
S3942	48	SCH	90	SV	212						
S3942BH	48	SCH25	74	SV-100B	232						
S3944	48	SCH29	74	SV-120B	232						
S3945F	48	SCK631BSP	65	SY-30CT	120						

Fractions - Decimals - Millimeters

FRACTION	DECIMAL	mm	FRACTION	DECIMAL	mm
	$\frac{1}{64}$ — .0156	0.396	$\frac{33}{64}$ — .5156		13.096
$\frac{1}{32}$	$\frac{3}{64}$ — .0468	1.190	$\frac{17}{32}$	$\frac{35}{64}$ — .5468	13.890
$\frac{1}{16}$	$\frac{5}{64}$ — .0781	1.587	$\frac{9}{16}$	$\frac{37}{64}$ — .5781	14.684
	$\frac{7}{64}$ — .1093	2.278	$\frac{19}{32}$	$\frac{39}{64}$ — .6093	15.478
	$\frac{9}{64}$ — .1406	3.175	$\frac{5}{8}$	$\frac{41}{64}$ — .6406	15.875
	$\frac{11}{64}$ — .1718	3.571	$\frac{21}{32}$	$\frac{43}{64}$ — .6718	16.271
	$\frac{13}{64}$ — .2031	3.968	$\frac{11}{16}$	$\frac{45}{64}$ — .7031	16.668
	$\frac{15}{64}$ — .2343	4.365	$\frac{23}{32}$	$\frac{47}{64}$ — .7343	17.065
	$\frac{17}{64}$ — .2656	4.762	$\frac{3}{4}$	$\frac{49}{64}$ — .7656	17.462
	$\frac{19}{64}$ — .2968	5.159	$\frac{25}{32}$	$\frac{51}{64}$ — .7968	17.859
	$\frac{21}{64}$ — .3281	5.556	$\frac{13}{16}$	$\frac{53}{64}$ — .8281	18.256
	$\frac{23}{64}$ — .3593	5.953	$\frac{27}{32}$	$\frac{55}{64}$ — .8593	18.653
	$\frac{25}{64}$ — .3906	6.350	$\frac{7}{8}$	$\frac{57}{64}$ — .8906	19.050
	$\frac{27}{64}$ — .4218	6.746	$\frac{29}{32}$	$\frac{59}{64}$ — .9218	19.446
	$\frac{29}{64}$ — .4531	7.143	$\frac{15}{16}$	$\frac{61}{64}$ — .9531	19.843
	$\frac{31}{64}$ — .4843	7.540	$\frac{31}{32}$	$\frac{63}{64}$ — .9843	20.240
		7.937	$\frac{1}{2}$		20.637
		8.334			20.637
		8.731			21.034
		9.128			21.034
		9.525			21.431
		9.921			21.431
		10.318			21.828
		10.715			21.828
		11.112			22.225
		11.509			22.225
		11.906			22.621
		12.303			22.621
		12.700			23.018
					23.018
					23.415
					23.415
					23.812
					23.812
					24.209
					24.209
					24.606
					24.606
					25.003
					25.003
					25.400
					25.400



FAIRVIEW FITTINGS

& Manufacturing Limited

- Head Office: 449 Attwell Drive,
Toronto, Ontario M9W 5C4
Telephone: (416) 675-4233
Fax: (416) 675-9416
E-Mail: service@fairviewfittings.com
www.fairviewfittings.com

Since
69



www.fairviewfittings.com



FAIRVIEW FITTINGS

& Manufacturing Incorporated

- Corporate HQ: 3777 Commerce Court,
Wheatfield, New York 14120 U.S.A.
Telephone: (716) 614-0320
CONTINENTAL USA: (800) 688-4088
Sales Fax: (716) 614-0329 Admin. Fax: (716) 614-0327
E-Mail: ussales@fairviewfittings.com

WAREHOUSE / SALES LOCATIONS

Canadian

- 206-3765 E. 1st AVENUE
BURNABY, B.C. V5C 3V6
PHONE: (604) 294-4427 FAX: (604) 294-9922
TOLL FREE: (888) 294-7104 FAX: (888) 294-7105
EMAIL: sales@vancouver.fairviewfittings.com
- UNIT 13 - 4069 112th AVENUE S.E.
CALGARY, ALBERTA T2C 0J4
PHONE: (403) 255-1524 FAX: (403) 259-6994
TOLL FREE (888) 832-0550 FAX: (888) 832-0551
EMAIL: sales@calgary.fairviewfittings.com
- 9811 - 12th AVENUE S.W.
EDMONTON, ALBERTA T6X 0E3
PHONE: (780) 438-2177 FAX: (780) 437-0691
TOLL FREE: (888) 441-9883 FAX: (888) 441-9884
EMAIL: sales@edmonton.fairviewfittings.com

- 3327 LAMBERT CRESCENT, UNIT 1
SASKATOON, SASKATCHEWAN S7K 1K4
PHONE: (306) 978-1800 FAX: (306) 978-1898
TOLL FREE: (866) 866-9198 FAX: (866) 978-1898
EMAIL: sales@saskatoon.fairviewfittings.com

- 310 KEEWATIN STREET
WINNIPEG, MANITOBA R2X 2R9
PHONE: (204) 633-9304 FAX: (204) 632-9656
TOLL FREE: (888) 290-3821 FAX: (888) 373-0913
EMAIL: sales@winnipeg.fairviewfittings.com

- 441 ATTWELL DRIVE
TORONTO, ONTARIO M9W 5C4
PHONE: (416) 675-3525 FAX: (416) 675-5678
TOLL FREE: (800) 800-4018 FAX: (888) 419-3965
EMAIL: torontosales@fairviewfittings.com

- 2955 RUE LUCIEN-L'ALLIER
LAVAL, QUEBEC H7P 0A1
PHONE: (450) 978-3341 FAX: (450) 686-9533
TOLL FREE: (800) 663-3341 FAX: (800) 499-3035
EMAIL: sales@montreal.fairviewfittings.com
- 683 MALENFANT BLVD.
DIEPPE (MONCTON), NEW BRUNSWICK E1A 5T8
PHONE: (506) 857-1115 FAX: (506) 857-9206
TOLL FREE: (800) 561-8551 FAX: (800) 862-4374
EMAIL: sales@moncton.fairviewfittings.com

U.S.A.

- 3777 COMMERCE COURT
WHEATFIELD, NEW YORK 14120
PHONE: (716) 614-0320
FAX: (716) 614-0329
CONTINENTAL U.S.A.: (800) 688-4088

- 22 PROSPECT STREET, UNITS 3 & 4
WOBURN, MASSACHUSETTS 01801
PHONE: (781) 932-1392
FAX: (781) 932-8148
CONTINENTAL U.S.A.: (800) 695-3101

- 3412 COUNTY RD. 6 E, UNIT 3
ELKHART, IN 46514
PHONE: (574) 206-8884
FAX: (574) 206-8444
CONTINENTAL U.S.A.: (877) 459-0700

Gas-Flo® & Accutek™ Are trademarks of
Fairview Fittings & Manufacturing Ltd.

Printed in Canada

