



DRUMS, HUBS AND WHEEL ATTACHING PARTS



TABLE OF CONTENTS

DRUMS AND HUBS	1
WHEEL ATTACHING PARTS	2
CROSS REFERENCE	3
NUMERICAL PARTS LISTING	4

Please e-mail any comments/suggestions/corrections to us at:
catalogfeedback@meritor.com

or mail to:
Meritor, Inc.
Attn: Catalog Department
7975 Dixie Highway
Florence, KY 41042

Visit us today at
XpresswayPlus.com



- 🖱 Place your order
- 🖱 Check Price and Availability
- 🖱 Retrieve Invoices
- 🖱 and more!

INDEX

Drums and Hubs	Page
Common Problems With Brake Drums.....	1-8
How To Measure Brake Drums.....	1-11
How to Use This Catalog	1-4
SteelLite X30™ Brake Drum.....	1-2
What Makes A Good Brake Drum	1-5
Drum Numerical Listing.....	1-12
Drums By Brake Size	1-18
Lite Weight TN Trailer Hubs.....	1-30
Lite Weight TP Trailer Hubs.....	1-27
Trailer Hubs.....	1-23

STEELLITE X30™ BRAKE DRUMS



PREMIUM LIGHTWEIGHT PACKAGE

**Saves over 300 pounds per tractor/trailer combination.
Offers optimum payload and fuel efficiency.**

STELLITE X30™ BRAKE DRUMS

A PREMIUM LIGHTWEIGHT DRUM and braking system for increased payload capacity and improved fuel economy.

FEATURES AND BENEFITS

ENGINEERED FOR EXCELLENCE

- Patented machine-to-balance process:
 - No balance weights to lose – a condition that can lead to vibration and component wear issues
 - No need to increase drum weight during the balance process
- Compatible with brake systems for revised FMVSS-121 regulations

ROBUST, LIGHTWEIGHT STEEL CONSTRUCTION

- Lightweight design can reduce vehicle weight by 300 pounds on a tractor-trailer combination*
- One-piece roll-formed shell design delivers superior concentricity (with no weld seams or balance weights) which combines exceptional strength and durability and reduces risk of disintegration
- As a member of the Meritor MPG SERIES family of components, X30 provides a clear weight-savings advantage compared to cast drums for optimum payload, performance and operational efficiency

AVAILABLE WHERE YOU NEED IT

- Compatible with most popular wheel-end configurations and axle ratings, fitting most vehicle specs in your fleet
- Seamless interchangeability with comparable cast drums and linings
- Broad availability as original equipment and aftermarket replacement

Lightweight with unsurpassed strength, **STELLITE X30 DRUMS CAN REDUCE VEHICLE WEIGHT BY OVER 300 POUNDS** for a tandem axle tractor/trailer combination*, increasing miles-per-gallon while allowing for increased payloads.**



Centrifugally-cast iron braking surface for optimal friction coupling

One-piece steel shell eliminates weld seams and provides superior strength

MPG  SERIES™

*As compared to the use of full-cast drums with 16-1/2" x 5" front brakes and 16-1/2" x 8-5/8" tandem rear and trailer brakes.

**The fuel savings described throughout this brochure are estimates only. Actual fuel savings may vary, and will depend on a variety of factors beyond Meritor, Inc.'s control, including load, vehicle type, driver performance, distances traveled, vehicle speed, road conditions, etc.

HOW TO USE THIS CATALOG

The part numbering system divides as such:

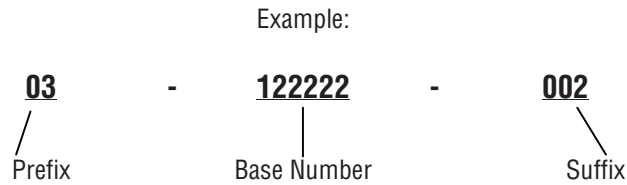

- The prefix indicates the part type. The 03 in the example indicates a cast non-balanced brake drum. The 23 different prefix numbers are used to categorize and describe the part. At present not all of the prefix codes are currently being used, but all are listed for your reference. (See Prefix Code Chart below)
This catalog covers prefix codes 03, 04, 13, 14, 53, 85.
- 122222 base number, when coupled with the prefix, gives the part type and the part dimensional specifications through the numerical part number listing. The base numbers are not all available with all the prefix combinations.
- The suffix, a three digit number, indicates the phase of manufacturing the part is in.

PREFIX CODE	DESCRIPTION
03	Brake Drums, Cast Non-Balanced
04	Hub Only - Rear Drive and Trailer
05	Hub Only - Front
08	Rim, Studs, Misc., etc.
09	Hub / Wheel Parts
13	Brake Drums, Cast Weld-to-Balance
14	Hub and Drum Assembly - Rear Drive and Trailer
15	Hub and Drum Assembly Front
16	Hub and Rotor Assembly Rear
17	Hub and Rotor Assembly Front
23	Rotor
47	Nodular Iron Wheel Rear / Trailer (No Longer Available)
48	Wheel Drum Assembly Rear / Trailer Nodular Iron Wheel (Spoke) (No Longer Available)
53	X-30 Brake Drum
55	Nodular Iron Wheel Front (No Longer Available)
56	Wheel Drum Assembly Front Nodular Iron Wheel (Spoke) (No Longer Available)
57	Wheel Rotor Assembly Front Nodular Iron Wheel (Spoke) (No Longer Available)
60	Calipers and Kits
69	Brake Supports, etc.
83	X-10 Series Brake Drums / Non-Balanced (No Longer Available)
85	Brake Drums / Machined to Balance (MTB)
93	X-10 Series Brake Drums / Weld to Balance (WTB) (No Longer Available)
95	X-10 Series Brake Drums / Machined to Balance (MTB) (No Longer Available)

WHAT MAKES A GOOD BRAKE DRUM

There are a number of attributes that differentiate between mediocre and a good brake drum. The following highlights these and what they mean to the end user.

1. A HEAT ABSORPTION DEVICE (HEAT SINK)

The braking system in a vehicle converts the vehicle energy of motion into heat energy by means of friction between the brake lining and the brake surface of the brake drum when the vehicle's brakes are applied.

- a). The surrounding parts, such as brake lining, rim, tire, hub, bearings, and drum absorb heat by conduction and radiation.
- b). The surrounding air is heated by convection.

Radiated heat to surrounding parts is small and heat dissipated by convection to the surrounding air is slow relative to the actual time of braking. For these reasons nearly all the braking energy must be stored in the form of heat in the brake drum. This energy is stored by heating the drum material to a higher temperature than the drum temperature prior to the brake application. A heavier drum will store more energy than a light one will. A heavier drum is stronger and more fade resistant.

2. A CYLINDRICAL BRAKE LINING INTERFACE

The brake drum moves past a stationary brake lining. When (if) the brake surface does not move past the lining uniformly, the brake drum has run out. This will overstress the brake drum, linings, and attaching hardware, causing variable heating of the brake drum braking surface which results in heat checking, excessive wear of both the drum and lining, pulsing of the brake, and shortened life of both the drum and lining. Also to keep the drum dimensionally stable under these conditions, it must be a relatively heavy brake drum.

A heavy precise brake drum does not reduce the need for linings to fit the drum correctly. If the linings are not contoured to fit properly, the brake will not produce proper braking torque. Poorly contoured linings cause additional mechanical stress in the drum, shoes and lining, and brake hardware. This additional stress hastens failure and greater wear.

Before linings are "burnished" or seated into the brake drum, they may rub on only a few high spots. These superheat the brake drum braking surface in very small areas and can be seen on the brake dynamometer as fire bands. A light brake application will cause this to occur whereas a snub brake application will force the lining against more of the braking surface of the brake drum thus limiting or even eliminating these types of hot spots. If these hot spots are allowed to continue, martensite hot spots will occur, and in turn drum distortion, and very early cracking can happen.

Lining that takes longer to burnish will be more likely to cause hot spotting. Many of the non-asbestos organic linings fall into this category. Since martensite hot spotted brake drums cannot usually be successfully rebored, they usually must be scrapped.

3. HIGH STRENGTH, HEAT, AND WEAR RESISTANT BRAKE DRUM MATERIAL

A brake drum must be strong enough to resist the maximum mechanical stress caused by the expanding and self-energized brake shoes at high temperatures. The brake drum's stiffness or resistance to deflection is derived from the thick shell structure and the stiffness of the gray cast iron. Higher tensile strength gray iron does not change the deflection of the brake drum significantly.

Although higher strength iron is more resistance to thermal stress caused by temperature gradients, as a "hot" brake surface and a "cold" outside brake drum diameter. The occurring problem here is the "cold" outside diameter of the brake drum does not want to expand to a bigger diameter, but the "hot" inside diameter of the brake drum does want to expand. The "hot" inner surface is caused to compress or compresses plastically so that it fits within the "cold" outer surface. But as the "hot" inner surface cools, cracks form because the metal was too compressed to return to its original position thus resulting in hairline surface cracks known as heat checks.

4. HEAVY ROTATING PARTS THAT IF IMBALANCED CAN SIGNIFICANTLY AFFECT THE VEHICLES RIDE

The mass of a 16.5" x 7" brake drum is concentrated about 9 inches radially from the hub bearing centerline. Unless the brake drum is balanced, it helps excite vibration in trucks and trailers. That is why it is important to use balanced brake drums on all front and rear applications. Most brake drum balancing is done by welding weights to the outside of the drum, but ArvinMeritor pioneered and patented a technique to balance brake drums without welding on balance weights. This is called Machine to Balance (MTB). The industry typically requires front hub/drum or hub/rotor assemblies balanced to 20-in. oz. maximum and rear hub/drum or hub/rotor assemblies balanced to 50-in. oz. maximum.

WHAT MAKES A GOOD BRAKE DRUM (Cont.)

6. SUMMARY: THE BEST BRAKE DRUM FOR OVERALL PERFORMANCE

- Is a relatively heavy brake drum
- Is made from temperature and wear resistant high tensile iron
- Is precisely machined
- Is balanced by machining rather than adding weights

MAXIMUM BRAKE FACE DIAMETERS

Maximum brake face diameters are indicated on ArvinMeritor Brake drums, i.e., the word “Max. Dia. 15.120 inches 384.05mm” will be found on brake drums with a 15 inch, 381mm nominal brake face diameter. This means that for safe operation the brake face diameter should never exceed 15.120 inches, 384.05mm from machining or wear.

Because we have no way of knowing the number of heat cycles or the severity of the cycles to which the drum has been subjected in actual usage, we do not recommend reboring the brake face diameter. The user is best able to judge whether the drum has sufficient life remaining to justify reboring. The maximum diameters are shown in the chart.

ArvinMeritor has engineered their brake drums to provide safe operation At the maximum brake face diameters, however, ArvinMeritor does not machine these drums to maximum diameters and cannot control the methods that others use to re-machine them after they are put into use.

Do not confuse maximum brake face with maximum rebore diameters. When the drum reaches the maximum brake face diameter, it must be removed from service. There may be some instances where it is a good economic decision to rebore a brake drum but after rebore, there must be some wear life left (at least .040 inches) prior to reaching discard diameter. ArvinMeritor does not recommend reboring brake drums for the following reasons:

1. It usually is not a good economic solution.
2. Reboring does not remove fatigue damage even though it may remove the heat checks.
3. It is very difficult to avoid running brake drums over the maximum brake face diameter.
4. Martensite (hot spots) and distortion caused by it are virtually impossible to remove.
5. Severe corrosion is frequently on the outside of the drum which weakens the drum.

NOMINAL DIAMETER		MAXIMUM BRAKE FACE DIAMETER	
Inches	mm	Inches	mm
7.25	185	7.340	186.44
8.00	204	8.090	205.49
9.50	242	9.590	243.59
9.75	248	9.840	249.94
10.00	254	10.090	256.29
11.00	280	11.090	281.69
11.06	281	11.120	282.45
12.00	305	12.090	307.09
12.25	312	12.340	313.44
14.00	356	14.090	357.89
14.50	369	14.620	371.35
15.00	381	15.120	384.05
16.00	407	16.120	409.45
16.25	413	16.370	415.80
16.50	420	16.620	442.15
16.50	420	16.585	421.25
17.00	432	17.120	434.85
17.25	439	17.370	441.20
18.00	458	18.120	462.25
20.00	508	20.120	511.05
20.25	515	20.370	517.40

WHAT MAKES A GOOD BRAKE DRUM (Cont.)

WHEN SHOULD A BRAKE DRUM BE REPLACED?

The ability of a brake drum to perform safely is affected by a variety of factors. Conditions, which affect the life of brake drums, are listed, although this list is not intended to be all-inclusive it should serve as a useful guide. The brake drum should be replaced when any of these conditions appear.

1. Brake face diameter reaches maximum limit
2. Excessive heat checks
3. Cracks
4. Martensite spotted drums – “hot spots”
5. Worn or elongated bolt holes
6. Galling of brake surface
7. Brake drum known to have been overheated as occurs with dragging brakes
8. Brake drum warped...out of round
9. It may be necessary to replace brake drums in pairs in order to maintain proper brake balance and efficiency.

RECOMMENDATIONS FOR LONGER BRAKE DRUM AND ROTOR LIFE

When drums are forced to fit onto a hub, there is improper match of parts for installation. The cause must be determined and corrected.

Wheel bearings should be properly adjusted to prevent the drum from picking up the load created by the braking action.

Drums and linings should be checked at periodic intervals to detect operational patterns. The use of non-asbestos organic linings can cause linings to swell and drag resulting in hot spots and lower fuel economy.

Clearance between non-applied brake linings and the drum varies slightly. See the brake system manufacturer's recommendations for this adjustment. Proper clearance prevents excessively hot linings and drums and improves fuel economy.

Parking brakes should not be set while the drums are hot. Allow them to cool, otherwise, drum cracking and failure can result.

DRUM FAILURE ANALYSIS

Regular and thorough inspection of your brake system is the best investment you can make for low cost per mile brake operation. Be sure you have a standard inspection timetable and follow it. The following pages list common problems you should be alert for.

COMMON PROBLEMS WITH BRAKE DRUMS

Grease Stained Drums

Brake drums with discolored spots on the braking surface, and oil or grease splattered on the brake assembly indicates over-lubrication of the cam or camshaft, or by an oil seal failure. Correct this problem. By repairing the source of the oil or grease leak, clean the drum and replace soaked linings.

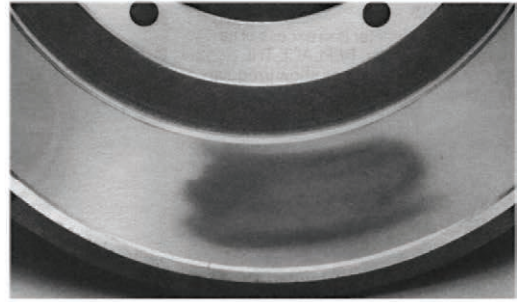

Cracked Drums

A drum which has cracked completely through a section of the braking surface **must be replaced immediately. A cracked drum is not repairable!** Cracked drums are caused by one or more of the following:

1. Excessive heating and cooling
2. Excessive shoe pressure

Repeated cracking of this type may indicate one or more of the following:

1. Dragging brakes
2. Inadequately designed drums for the application
3. Inadequately designed braking system for the application
4. Incorrect brake balance of the vehicle
5. Driver abuse



The total braking system of the vehicle should be checked thoroughly, paying attention to the following:

1. Proper friction ratings
2. Proper valving and plumbing
3. Proper brake balance
4. Missing linings and/or brake system components.

Heat Checking

A broken network of fine hairline cracks on the braking surface of the drum, is a normal phenomenon of braking surfaces. It is caused by regular heating and cooling of the surface. Heat checking does not impair brake performance; but you should examine heat checks frequently to make sure they have not grown deep enough to weaken the drum.



Oversized Drums

If the brake surface diameter is in excess of it's specified maximum diameter, **replace the drum immediately.** It may be necessary to replace drums in pairs to assure proper brake drum balance and braking efficiency. If the linings show irregular wear replace them.



COMMON PROBLEMS WITH BRAKE DRUMS (Cont.)

Scored Drums

Scored drums are signified by circumferential grooves on the braking surface and excessive lining wear. If the scoring is not deeper than the maximum rebores diameter, the drum may be rebored and returned to service. The linings should be replaced and the braking system should be checked to make sure excessive amounts of abrasive material are not entering into the lining-drum contact area. If the scoring is deeper than the maximum rebores diameter, **replace the drum immediately.**

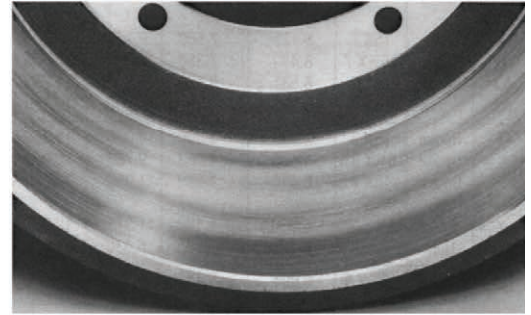

Out-Of-Round Drums

Variations in drum diameter at different points on the braking surface indicate out-of-round drums. The drum should be machined within allowable rebores limits to restore concentricity. Do not exceed the maximum rebores limit of turned drums, and replace drums which are worn beyond their specified maximum diameter. If you are unable to restore concentricity by reboring the drum, **replace it with a new one.** It may be necessary to replace drums in pairs to assure proper brake drum balance and braking efficiency.

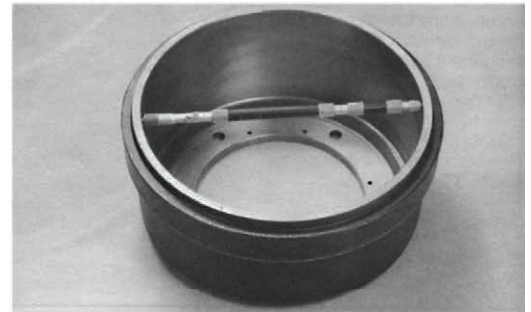

Excessive Wear and Galling

Excessive wear along the edges of the lining contact area, or in areas coinciding with the rivet holes of the lining, is usually caused by abrasive material collecting between the lining and the drum/rotor. Remove the abrasive material from the system and check the drum for scoring. If the brake drum is scored beyond the maximum limit, **replace the drum immediately.** Install dust shields to restrict the amount of abrasive material which can enter the braking system.

Excessive wear can also be caused by misaligned brake shoes. If the shoes are not “square” to the braking surface, uneven forces are applied. This can result in deep grooves in the braking surface. If the brake drum is scored beyond the maximum limit, **replace the drum immediately.** Correct the brake shoe alignment to alleviate further grooving. Brake drum galling in an abnormal wear pattern is due to initial incompatibility between the brake drum lining and the brake surface. This condition may correct itself due to brake drum and lining wear. If severe, consider replacing the lining and/or the brake drum.

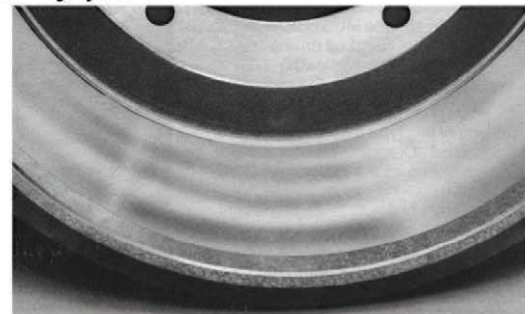

COMMON PROBLEMS WITH BRAKE DRUMS (Cont.)

Blue Drums

A bluish discoloration on the brake parts (shoes, drums/rotors or bolts) indicates excessive heat.

This is usually caused by an oversized brake surface diameter/undersized rotor width or by weak or broken return springs.

For drums, check the braking surface diameter. If it is oversized, **replace the drum immediately**. If the return springs are weak or broken, replace them.

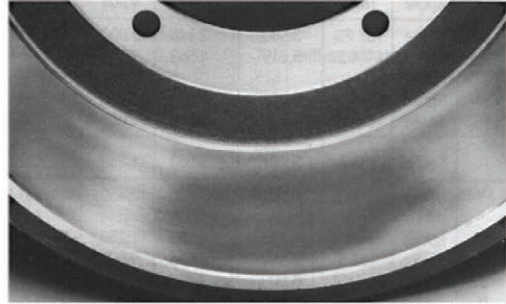

Martensite Spotted Drums

Martensite spotted drums have extremely hard, slightly raised, dark colored spots on the braking surface, shown uneven wear and the surface is out-of-round. This condition may cause excessive noise or shudder during brake applications. Unless this is detected very early, the brake drum should be scrapped.

The spots are caused by very light brake applications with non-asbestos organic linings that are contacting the drum at a few lining high spots. To avoid this problem, change braking technique to snubs rather than light dragging stops or ensure the lining fits the drum contour uniformly when it is new.

Attempts to rebores a drum to remove the spots will usually aggravate an already bad situation, and if the drum is allowed to stay in service, cracks will connect between the martensite spots leading to brake drum failure. If the brake lining and drum are replaced and the same brake application techniques are used, the results will likely be the same. If only the drum is replaced, it may not develop these spots (as the high points are worn down).



Polished Drums

A polished brake drum/rotor is characterized by a mirror-like finish on its braking surface. Correct this problem by removing the gloss with 80 grit emery cloth. If the problem recurs, check the linings to make sure they are the proper friction rating. If the linings are glazed, consult the vehicle manufacturer for the proper lining material.

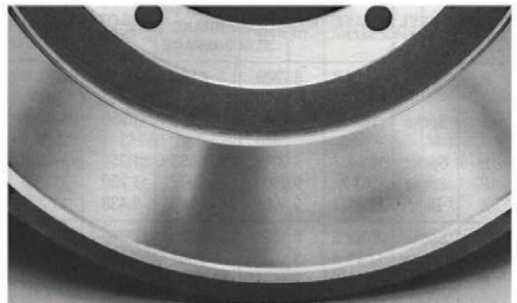

HOW TO MEASURE BRAKE DRUMS

IDENTIFY REQUIRED DRUM BY MEASURING:

1. Brake Surface Diameter



4. Bolt Circle Diameter



2. Brake Surface Width



5. Size of Bolt Holes



3. Overall Depth



6. Pilot Diameter



CHECK THIS INFORMATION:

A. Number of bolt holes

Slots in the back of the drum for wheel spoke clearance



B. Drilled and tapped holes for skid control exci

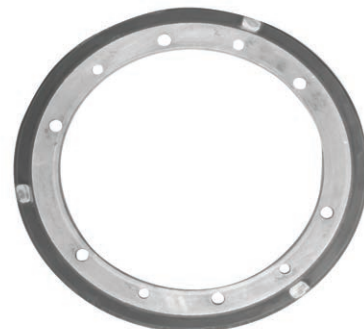

DRUM NUMERICAL LISTING

CAST BRAKE DRUMS - NON-BALANCED

PART NUMBER	WEIGHT	WHEEL TYPE	BRAKE SIZE	OVER-ALL DEPTH	BRAKE SURFACE WIDTH	PILOT DIA.	BOLT CIRCLE DIA.	BOLT HOLES		COMMENTS
								NO.	SIZE	
03-012480-002	112	Spoke	16.50" x 7.00"	9.00"	7.60"	11.25"	12.75"	6	.66"	
03-012488-002	135	Spoke	18.00" x 7.00"	9.25"	8.00"	11.25"	12.75"	6	.66"	
03-012582-002	118	Disc	16.50" x 7.00"	9.50"	7.56"	9.44"	11.25"	10	.84"	
03-120376-002	131	Spoke/Disc	16.50" x 8.63"	10.25"	9.22"	9.50"	11.25"	10	.84"	
03-120442-002	106	Spoke	16.50" x 7.00"	8.65"	7.50"	11.00"	12.50"	5	.66"	
03-120516-002	83	Spoke	15.00" x 6.00"	7.09"	6.50"	9.44"	11.00"	5	.66"	
03-120517-002	76	Spoke	15.00" x 5.00"	6.59"	5.56"	9.44"	11.00"	5	.66"	
03-120566-002	57	Disc	15.00" x 4.00"	6.41"	4.66"	6.25"	8.75"	6	.84"	
03-120574-002	103	Spoke	16.50" x 7.00"	8.72"	7.56"	11.25"	12.75"	5	.78"	
03-120586-002	116	Spoke	16.50" x 7.00"	8.75"	7.50"	9.50"	11.25"	5/6	.78/.66"	
03-120705-002	37	Spoke	15.00" x 3.00"	4.13"	3.56"	10.00"	11.00"	5	.53"	
03-120743-002	99	Spoke	16.50" x 7.00"	7.94"	7.31"	11.00"	12.75"	6	.66"	
03-120754-002	103	Spoke	16.50" x 7.00"	8.44"	7.38"	11.00"	12.50"	5/6	.66/.66"	
03-120822-002	62	Spoke	12.25" x 7.50"	8.81"	8.00"	8.50"	10.00"	6	.66"	
03-120855-002	92	Spoke	16.50" x 5.00"	6.12"	5.37"	9.25"	11.25"	6	.78"	
03-120877-002	115	Disc	16.50" x 7.00"	10.69"	7.53"	9.44"	11.25"	10	.84"	
03-120882-002	127	Disc	16.50" x 8.63"	11.16"	9.06"	9.44"	11.25"	10	.81"	
03-120936-002	132	Spoke	18.00" x 7.00"	8.25"	7.44"	11.00"	12.75"	6	.66"	
03-120981-002	76	Disc	15.00" x 4.00"	7.84"	4.44"	8.66"	11.25"	10	1.27"	Outboard mount
03-120988-002	86	Disc	16.50" x 5.00"	8.58"	5.48"	8.66"	11.25"	10	1.27"	Outboard mount
03-122009-002	105	Spoke	16.50" x 7.00"	8.65"	7.65"	10.50"	12.75"	5	.78"	
03-122011-002	89	Spoke	15.00" x 7.00"	8.51"	7.36"	10.50"	12.75"	5	.78"	
03-122027-002	120	Spoke	16.50" x 7.00"	8.94"	7.63"	9.50"	11.25"	5	.78"	
03-122078-002	66	Spoke	15.00" x 4.00"	5.26"	4.31"	9.50"	11.25"	6	.78"	
03-122104-002	64	Spoke	15.00" x 4.00"	5.84"	4.54"	9.25"	11.25"	6	.78"	
03-122126-002	117	Spoke/Disc	16.50" x 7.00"	8.75"	7.50"	9.50"	11.25"	10	.84"	
03-122222-002	108	Spoke	16.50" x 7.00"	8.41"	7.63"	9.44"	11.00"	5/6	.78/.66"	
03-122239-002	119	Disc	16.50" x 7.00"	8.94"	7.63"	9.50"	11.25"	10	.84"	Notched for ABS
03-122290-002	119	Spoke	16.50" x 7.00"	8.94"	7.63"	9.50"	11.25"	6	.78"	Notched for ABS
03-122314-002	45	Spoke	15.00" x 3.00"	4.69"	3.50"	6.45"	8.00"	5	.66"	
03-122453-002	112	Disc	16.50" x 7.00"	10.38"	7.44"	8.53"	11.25"	10	.81"	
03-122455-002	109	Spoke	16.50" x 7.00"	8.03"	7.44"	14.25"	12.75"	5/6	.66/.66"	
03-122488-002	54	Spoke	12.25" x 5.50"	7.44"	6.53"	8.50"	10.00"	6/6	.66/.66"	
03-122513-002	127	Disc	16.50" x 8.63"	12.27"	9.33"	9.44"	11.25"	10	.84"	Outboard mount
03-122518-002	102	Disc	16.50" x 7.00"	8.75"	7.50"	9.50"	11.25"	10	.81"	Std weight - 03-122126
03-122529-002	88	Disc	15.00" x 4.00"	8.86"	4.53"	8.75"	11.25"	10	1.28"	Outboard mount
03-122550-002	106	Disc	16.50" x 7.00"	10.59"	7.75"	9.00"	11.25"	10	.81"	
03-122561-002	73	Disc	15.00" x 5.00"	7.99"	5.72"	6.44"	8.75"	10	.78"	
03-122562-002	72	Disc	15.00" x 5.00"	7.99"	5.72"	6.44"	8.75"	6	.84"	
03-122575-002	60	Spoke	15.00" x 4.00"	5.54"	4.44"	9.19"	11.25"	5/6	.66/.66"	
03-122600-002	106	Spoke	16.50" x 7.00"	7.94"	7.31"	11.00"	12.75"	5/6	.66"	
03-122603-002	103	Spoke	16.50" x 7.00"	8.75"	7.50"	9.44"	11.00"	5	.78"	
03-122607-002	117	Disc	16.50" x 7.00"	10.63"	7.82"	8.53"	11.25"	10	.81"	
03-122683-002	106	Spoke	16.50" x 7.00"	8.45"	7.39"	11.25"	12.75"	5/6	.78/.78"	

DRUM NUMERICAL LISTING

STEELLITE X-30 BRAKE DRUMS

PART NUMBER	WEIGHT	WHEEL TYPE	BRAKE SIZE	OVER-ALL DEPTH	BRAKE SURFACE WIDTH	PILOT DIA.	BOLT HOLES		AXLE CAPACITY
							BOLT CIRCLE DIA.	NO. SIZE	
53-123512-002	62	Disc	15.00" x 4.00"	8.60"	4.86"	8.78"	285.75mm	10 1.25"	13,200 lbs.
53-123535-002	95	Disc	16.50" x 8.00"	10.96"	8.62"	8.78"	285.75mm	10 .94"	23,000 lbs.
53-123537-002	94	Disc	16.50" x 7.00"	10.38"	7.87"	8.78"	285.75mm	10 .94"	23,000 lbs.
53-123542-002	63	Disc	15.00" x 4.00"	8.89"	7.76"	8.78"	285.75mm	10 1.25"	13,200 lbs.
53-123544-002	102	Disc	16.50" x 8.63"	11.04"	9.15"	8.78"	11.25"	10 .93"	23,000 lbs.
53-123564-002	94	Disc	16.50" x 7.00"	10.38"	7.86"	8.53"	11.25"	10 .81"	23,000 lbs.
53-123565-002	93	Disc	16.50" x 7.00"	10.38"	7.86"	9.00"	11.25"	10 .81"	23,000 lbs.
53-123566-002	93	Disc	16.50" x 7.00"	10.38"	7.86"	9.00"	275mm	8 .92"	23,000 lbs.
53-123567-002	63	Disc	15.00" x 4.00"	8.64"	5.11"	8.78"	285.75mm	10 .96"	13,200 lbs.
53-123568-002	64	Disc	15.00" x 4.00"	8.89"	4.76"	8.78"	285.75mm	10 .96"	13,200 lbs.
53-123575-002	64	Disc	15.00" x 4.00"	8.89"	4.76"	8.99"	275mm	8 .94"	13,200 lbs.
53-123579-002	106	Disc	16.50" x 8.63"	12.15"	9.38"	9.00"	275mm	8 .94"	23,000 lbs.
53-123580-002	106	Disc	16.50" x 8.63"	12.15"	9.38"	8.53"	11.25"	10 .81"	23,000 lbs.
53-123581-002	106	Disc	16.50" x 8.63"	12.15"	9.38"	8.78"	285.75mm	10 .94"	23,000 lbs.
53-123582-002	91	Disc	16.50" x 7.00"	10.04"	7.27"	8.53"	11.25"	10 .81"	23,000 lbs.
53-123583-002	89	Disc	16.50" x 7.00"	10.04"	7.27"	8.78"	285.75mm	10 .94"	23,000 lbs.
53-123588-002	79	Disc	16.50" x 5.00"	9.22"	5.82"	9.00"	275mm	8 .94"	14,600 lbs.
53-123589-002	79	Disc	16.50" x 5.00"	9.22"	5.82"	8.78"	11.25"	10 1.28"	14,600 lbs.
53-123590-002	79	Disc	16.50" x 5.00"	9.22"	5.82"	8.53"	11.25"	10 1.28"	14,600 lbs.
53-123592-002	80	Disc	15.00" x 7.00"	10.22"	7.42"	8.53"	11.25"	10 .81"	20,000 lbs.
53-123598-002	70	Disc	15.00" x 5.00"	9.53"	5.81"	8.78"	11.25"	10 1.28"	14,000 lbs.
53-123600-002	70	Disc	15.00" x 5.00"	9.53"	5.81"	8.78"	285.75mm	10 .94"	14,000 lbs.
53-123601-002	91	Disc	15.00" x 8.63"	11.44"	9.11"	8.78"	285.75mm	10 .94"	20,000 lbs.
53-123602-002	91	Disc	15.00" x 8.63"	11.44"	9.11"	9.00"	275mm	8 .94"	20,000 lbs.
53-123605-002	77	Disc	16.50" x 5.00"	8.59"	5.87"	8.53"	11.25"	10 1.28"	14,600 lbs.
53-123606-002	77	Disc	16.50" x 5.00"	8.59"	5.87"	8.78"	11.25"	10 1.28"	14,600 lbs.
53-123607-002	87	Disc	16.50" x 6.00"	9.62"	6.68"	8.78"	285.75mm	10 .94"	20,000 lbs.
53-123608-002	87	Disc	16.50" x 6.00"	9.62"	6.68"	8.78"	11.25"	10 1.28"	20,000 lbs.

CAST BRAKE DRUMS - BALANCED -- MACHINE-TO-BALANCE (MTB)

PART NUMBER	WEIGHT	WHEEL TYPE	BRAKE SIZE	OVER-ALL DEPTH	BRAKE SURFACE WIDTH	PILOT DIA.	BOLT HOLES		COMMENTS
							BOLT CIRCLE DIA.	NO. SIZE	
03-012480-002	112	Spoke	16.50" x 7.00"	9.00"	7.60"	11.25"	12.75"	6 .66"	
03-012488-002	135	Spoke	18.00" x 7.00"	9.25"	8.00"	11.25"	12.75"	6 .66"	
03-012582-002	118	Disc	16.50" x 7.00"	9.50"	7.56"	9.44"	11.25"	10 .84"	
03-120376-002	131	Spoke/Disc	16.50" x 8.63"	10.25"	9.22"	9.50"	11.25"	10 .84"	
03-120442-002	106	Spoke	16.50" x 7.00"	8.65"	7.50"	11.00"	12.50"	5 .66"	
03-120516-002	83	Spoke	15.00" x 6.00"	7.09"	6.50"	9.44"	11.00"	5 .66"	
03-120517-002	76	Spoke	15.00" x 5.00"	6.59"	5.56"	9.44"	11.00"	5 .66"	
03-120566-002	57	Disc	15.00" x 4.00"	6.41"	4.66"	6.25"	8.75"	6 .84"	
03-120574-002	103	Spoke	16.50" x 7.00"	8.72"	7.56"	11.25"	12.75"	5 .78"	
03-120586-002	116	Spoke	16.50" x 7.00"	8.75"	7.50"	9.50"	11.25"	5/6 .78/.66"	
03-120705-002	37	Spoke	15.00" x 3.00"	4.13"	3.56"	10.00"	11.00"	5 .53"	
03-120743-002	99	Spoke	16.50" x 7.00"	7.94"	7.31"	11.00"	12.75"	6 .66"	
03-120754-002	103	Spoke	16.50" x 7.00"	8.44"	7.38"	11.00"	12.50"	5/6 .66/.66"	
03-120822-002	62	Spoke	12.25" x 7.50"	8.81"	8.00"	8.50"	10.00"	6 .66"	
03-120855-002	92	Spoke	16.50" x 5.00"	6.12"	5.37"	9.25"	11.25"	6 .78"	
03-120877-002	115	Disc	16.50" x 7.00"	10.69"	7.53"	9.44"	11.25"	10 .84"	
03-120882-002	127	Disc	16.50" x 8.63"	11.16"	9.06"	9.44"	11.25"	10 .81"	
03-120936-002	132	Spoke	18.00" x 7.00"	8.25"	7.44"	11.00"	12.75"	6 .66"	

DRUM NUMERICAL LISTING

CAST BRAKE DRUMS - BALANCED -- MACHINE-TO-BALANCE (MTB)

PART NUMBER	WEIGHT	WHEEL TYPE	BRAKE SIZE	OVER-ALL DEPTH	BRAKE SURFACE WIDTH	PILOT DIA.	BOLT CIRCLE DIA.	BOLT HOLES		COMMENTS
								NO.	SIZE	
03-120981-002	76	Disc	15.00" x 4.00"	7.84"	4.44"	8.66"	11.25"	10	1.27"	Outboard mount
03-120988-002	86	Disc	16.50" x 5.00"	8.58"	5.48"	8.66"	11.25"	10	1.27"	Outboard mount
03-122009-002	105	Spoke	16.50" x 7.00"	8.65"	7.65"	10.50"	12.75"	5	.78"	
03-122011-002	89	Spoke	15.00" x 7.00"	8.51"	7.36"	10.50"	12.75"	5	.78"	
03-122027-002	120	Spoke	16.50" x 7.00"	8.94"	7.63"	9.50"	11.25"	5	.78"	
03-122078-002	66	Spoke	15.00" x 4.00"	5.26"	4.31"	9.50"	11.25"	6	.78"	
03-122104-002	64	Spoke	15.00" x 4.00"	5.84"	4.54"	9.25"	11.25"	6	.78"	
03-122126-002	117	Spoke/Disc	16.50" x 7.00"	8.75"	7.50"	9.50"	11.25"	10	.84"	
03-122222-002	108	Spoke	16.50" x 7.00"	8.41"	7.63"	9.44"	11.00"	5/6	.78/.66"	
03-122239-002	119	Disc	16.50" x 7.00"	8.94"	7.63"	9.50"	11.25"	10	.84"	Notched for ABS
03-122290-002	119	Spoke	16.50" x 7.00"	8.94"	7.63"	9.50"	11.25"	6	.78"	Notched for ABS
03-122314-002	45	Spoke	15.00" x 3.00"	4.69"	3.50"	6.45"	8.00"	5	.66"	
03-122453-002	112	Disc	16.50" x 7.00"	10.38"	7.44"	8.53"	11.25"	10	.81"	
03-122455-002	109	Spoke	16.50" x 7.00"	8.03"	7.44"	14.25"	12.75"	5/6	.66/.66"	
03-122488-002	54	Spoke	12.25" x 5.50"	7.44"	6.53"	8.50"	10.00"	6/6	.66/.66"	
03-122513-002	127	Disc	16.50" x 8.63"	12.27"	9.33"	9.44"	11.25"	10	.84"	Outboard mount
03-122518-002	102	Disc	16.50" x 7.00"	8.75"	7.50"	9.50"	11.25"	10	.81"	Std weight - 03-122126
03-122529-002	88	Disc	15.00" x 4.00"	8.86"	4.53"	8.75"	11.25"	10	1.28"	Outboard mount
03-122550-002	106	Disc	16.50" x 7.00"	10.59"	7.75"	9.00"	11.25"	10	.81"	
03-122561-002	73	Disc	15.00" x 5.00"	7.99"	5.72"	6.44"	8.75"	10	.78"	
03-122562-002	72	Disc	15.00" x 5.00"	7.99"	5.72"	6.44"	8.75"	6	.84"	
03-122575-002	60	Spoke	15.00" x 4.00"	5.54"	4.44"	9.19"	11.25"	5/6	.66/.66"	
03-122600-002	106	Spoke	16.50" x 7.00"	7.94"	7.31"	11.00"	12.75"	5/6	.66"	
03-122603-002	103	Spoke	16.50" x 7.00"	8.75"	7.50"	9.44"	11.00"	5	.78"	
03-122607-002	117	Disc	16.50" x 7.00"	10.63"	7.82"	8.53"	11.25"	10	.81"	
03-122683-002	106	Spoke	16.50" x 7.00"	8.45"	7.39"	11.25"	12.75"	5/6	.78/.78"	
03-122921-002	84	Disc	15.00" x 4.00"	8.98"	5.09"	8.75"	11.25"	10	.81"	
03-122925-002	109	Spoke	16.50" x 7.00"	8.03"	7.44"	14.25"	12.75"	5	.78"	
03-122947-002	61	Spoke	15.00" x 4.00"	5.60"	4.68"	11.00"	12.75"	6	.78"	
03-122948-002	116	Disc	16.50" x 7.00"	10.31"	7.64"	9.00"	11.25"	10	.81"	
03-122963-002	66	Spoke	12.25" x 7.50"	8.81"	8.00"	8.50"	10.00"	6/6	.66/.66"	
03-122964-002	61	Spoke	15.00" x 4.00"	5.56"	4.69"	11.00"	12.75"	5	.78"	
03-122966-002	96	Disc	16.50" x 5.00"	9.63"	5.74"	8.75"	11.25"	10	.81"	
03-122971-002	82	Spoke	12.25" x 7.50"	9.00"	7.88"	7.00"	8.25"	6/6	.53/.66"	
03-122978-002	112	Disc	16.50" x 7.00"	10.63"	7.82"	8.53"	11.25"	10	.81"	Outboard mount; hub requires a .25" x 450 chamfer - do not substitute 03-122607
03-123020-002	69	Disc	15.00" x 4.00"	7.84"	4.44"	8.78"	11.25"	10	1.27"	Uni-mount version of 03-120981
03-123024-002	82	Disc	15.00" x 4.00"	8.87"	4.53"	11.25"	13.19"	10	.94"	335mm Bolt Circle for use with hub piloted systems only
03-123025-002	122	Disc	16.50" x 7.00"	10.59"	7.75"	11.25"	13.19"	10	.94"	335mm Bolt Circle for use with hub piloted systems only
03-123200-002	109	Spoke	16.50" x 7.00"	8.65"	7.65"	10.50"	12.75"	6	.78"	
03-123207-002	112	Disc	16.50" x 7.00"	10.54"	7.46"	8.78"	11.25"	10	1.02"	Outboard mount
03-123219-002	90	Disc	16.50" x 5.00"	9.16"	5.54"	11.25"	13.19"	10	.94"	335mm Bolt Circle for use with hub piloted systems only
03-123254-002	79	Disc	15.00" x 4.00"	8.79"	4.65"	8.78"	11.25"	10	1.25"	
03-123276-002	96	Disc	15.00" x 7.00"	10.92"	7.50"	8.99"	10.83"	8	.84"	275mm Bolt Circle
03-123297-002	123	Disc	16.50" x 7.00"	10.31"	7.63"	9.00"	11.25"	10	.84"	
03-123302-002	109	Disc	16.50" x 6.00"	9.75"	6.63"	11.25"	13.19"	10	.94"	335mm Bolt Circle for use with hub piloted svstems only

DRUM NUMERICAL LISTING

CAST BRAKE DRUMS - BALANCED -- MACHINE-TO-BALANCE (MTB)

PART NUMBER	WEIGHT	WHEEL TYPE	BRAKE SIZE	OVER-ALL DEPTH	BRAKE SURFACE WIDTH	PILOT DIA.	BOLT HOLES			COMMENTS
							BOLT CIRCLE DIA.	NO.	SIZE	
03-123331-002	84	Disc	15.00" x 6.00"	8.79"	6.75"	8.99"	10.83"	8	.84"	275mm Bolt Circle
03-123332-002	73	Disc	15.00" x 7.00"	8.02"	5.47"	8.99"	10.82"	8	.84"	
03-123365-002	122	Disc	16.50" x 7.00"	10.59"	7.75"	8.78"	11.25"	10	.94"	285.75mm Bolt Circle. Heavy duty version of 03-123207.
03-123366-002	70	Disc	15.00" x 4.00"	8.85"	4.56"	8.78"	11.25"	10	.94"	285.75mm Bolt Circle
03-123382-002	69	Disc	15.00" x 4.00"	8.85"	4.75"	8.78"	11.25"	10	1.28"	Heavy duty version of 03-123420
03-123383-002	63	Disc	16.50" x 5.00"	9.14"	5.50"	8.78"	11.25"	10	1.28"	
03-123396-002	84	Disc	15.00" x 4.00"	8.97"	5.09"	8.78"	11.25"	10	.94"	
03-123397-002	123	Disc	16.50" x 7.00"	10.31"	7.64"	8.78"	11.25"	10	.94"	
03-123398-002	111	Disc	16.50" x 7.00"	9.50"	7.56"	8.44"	11.25"	10	.84"	
03-123399-002	107	Disc	16.50" x 6.00"	9.81"	6.69"	8.78"	11.25"	10	1.28"	
03-123406-002	142	Disc	16.50" x 8.63"	11.98"	9.13"	8.78"	11.25"	10	.94"	Outboard mount; 285.75mm Bolt Circle
03-123409-002	123	Disc	16.50" x 7.00"	10.59"	7.75"	9.00"	10.83"	8	.94"	
03-123420-002	75	Disc	15.00" x 4.00"	8.85"	4.66"	8.78"	11.25"	10	1.28"	
03-123421-002	76	Disc	15.00" x 4.00"	8.85"	4.66"	8.78"	11.25"	10	.94"	Heavy Duty 03-123366-002
03-123427-002	142	Disc	16.50" x 6.00"	7.49"	6.69"	11.25"	12.75"	6	.78"	
03-123428-002	142	Disc	16.50" x 8.63"	12.33"	9.48"	8.78"	11.25"	10	.94"	
03-123430-002	105	Spoke	16.50" x 7.00"	8.65"	7.65"	10.50"	12.75"	5/6	.78/.78"	Double-drilled 03-122009 and 03-123200
03-123431-002	65	Spoke	15.00" x 4.00"	5.84"	4.75"	9.25"	11.25"	6	.78"	Similar to 03-122104 except .25" deeper
03-123448-002	74	Disc	15.00" x 4.00"	9.10"	4.65"	8.78"	11.25"	10	1.28"	
03-123466-002	121	Disc	15.00" x 8.63"	12.20"	8.83"	8.78"	11.25"	10	.94"	
03-123493-002	90	Disc	15.00" x 6.00"	8.81"	6.75"	8.78"	11.25"	10	.94"	285.75mm Bolt Circle. Axle capacity 15,000 lbs.
03-123500-002	89	Spoke / Disc	16.50" x 5.00"	6.41"	5.44"	10.00"	12.75"	5/6/7	.78"	Double-drilled 03-122266 and 03-122267
03-123520-002	128	Disc	16.50" x 8.00"	11.09"	8.90"	8.78"	11.25"	10	.94"	Axle capacity 23,000 lbs.
03-123538-002	100	Disc	16.50" x 5.00"	8.58"	5.48"	8.78"	11.25"	10	.94"	
13-123219-002	90	Disc	16.50" x 5.00"	9.16"	5.54"	11.25"	13.19"	10	.94"	335mm Bolt Circle for use with hub piloted systems only
13-123302-002	113	Disc	16.50" x 6.00"	9.75"	6.63"	11.25"	13.19"	10	.94"	
53-123512-002	62	Disc	15.00" x 4.00"	8.60"	4.86"	8.78"	285.75mm	10	1.25"	Drum / X30 Rated Axle Capacity 13,200 lbs.
53-123535-002	95	Disc	16.50" x 8.00"	10.96"	8.62"	8.78"	285.75mm	10	.94"	Drum/X30 Rated Axle Capacity 23,000 lbs.
53-123537-002	94	Disc	16.50" x 7.00"	10.38"	7.87"	8.78"	285.75mm	10	.94"	Drum / X30 Rated Axle Capacity 23,000 lbs.
53-123542-002	63	Disc	15.00" x 4.00"	8.89"	7.76"	8.78"	285.75mm	10	1.25"	Drum / X30 Rated Axle Capacity 13,200 lbs.
53-123544-002	102	Disc	16.50" x 8.63"	11.04"	9.15"	8.78"	11.25"	10	.93"	Rated Axle Capacity 23,000 lbs.
53-123564-002	94	Disc	16.50" x 7.00"	10.38"	7.86"	8.53"	11.25"	10	.81"	Drum / X30 Rated Axle Capacity 23,000 lbs.
53-123565-002	93	Disc	16.50" x 7.00"	10.38"	7.86"	9.00"	11.25"	10	.81"	Drum / X30 Rated Axle Capacity 23,000 lbs.
53-123566-002	93	Disc	16.50" x 7.00"	10.38"	7.86"	9.00"	275mm	8	.92"	Drum / X30 Rated Axle Capacity 23,000 lbs.
53-123567-002	63	Disc	15.00" x 4.00"	8.64"	5.11"	8.78"	285.75mm	10	.96"	Drum / X30 Rated Axle Capacity 13,200 lbs.

DRUM NUMERICAL LISTING

CAST BRAKE DRUMS - BALANCED -- MACHINE-TO-BALANCE (MTB)

PART NUMBER	WEIGHT	WHEEL TYPE	BRAKE SIZE	OVER-ALL DEPTH	BRAKE SURFACE WIDTH	PILOT DIA.	BOLT CIRCLE DIA.	BOLT HOLES		COMMENTS
								NO.	SIZE	
53-123568-002	64	Disc	15.00" x 4.00"	8.89"	4.76"	8.78"	285.75mm	10	.96"	Drum / X30 Rated Axle Capacity 13,200 lbs.
53-123575-002	64	Disc	15.00" x 4.00"	8.89"	4.76"	8.99"	275mm	8	.94"	Drum / X30 Rated Axle Capacity 13,200 lbs.
53-123579-002	106	Disc	16.50" x 8.63"	12.15"	9.38"	9.00"	275mm	8	.94"	
53-123580-002	106	Disc	16.50" x 8.63"	12.15"	9.38"	8.53"	11.25"	10	.81"	
53-123581-002	106	Disc	16.50" x 8.63"	12.15"	9.38"	8.78"	285.75mm	10	.94"	
53-123582-002	91	Disc	16.50" x 7.00"	10.04"	7.27"	8.53"	11.25"	10	.81"	
53-123583-002	89	Disc	16.50" x 7.00"	10.04"	7.27"	8.78"	285.75mm	10	.94"	
53-123588-002	79	Disc	16.50" x 5.00"	9.22"	5.82"	9.00"	275mm	8	.94"	
53-123589-002	79	Disc	16.50" x 5.00"	9.22"	5.82"	8.78"	11.25"	10	1.28"	
53-123590-002	79	Disc	16.50" x 5.00"	9.22"	5.82"	8.53"	11.25"	10	1.28"	
53-123592-002	80	Disc	15.00" x 7.00"	10.22"	7.42"	8.53"	11.25"	10	.81"	
53-123598-002	70	Disc	15.00" x 5.00"	9.53"	5.81"	8.78"	11.25"	10	1.28"	
53-123600-002	70	Disc	15.00" x 5.00"	9.53"	5.81"	8.78"	285.75mm	10	.94"	
53-123601-002	91	Disc	15.00" x 8.63"	11.44"	9.11"	8.78"	285.75mm	10	.94"	
53-123602-002	91	Disc	15.00" x 8.63"	11.44"	9.11"	9.00"	275mm	8	.94"	
53-123605-002	77	Disc	16.50" x 5.00"	8.59"	5.87"	8.53"	11.25"	10	1.28"	
53-123606-002	77	Disc	16.50" x 5.00"	8.59"	5.87"	8.78"	11.25"	10	1.28"	
53-123607-002	87	Disc	16.50" x 6.00"	9.62"	6.68"	8.78"	285.75mm	10	.94"	
53-123608-002	87	Disc	16.50" x 6.00"	9.62"	6.68"	8.78"	11.25"	10	1.28"	
53-123609-002	93	Disc	15.00" x 4.00"	8.89"	4.57"	8.53"	11.25"	10	1.28"	
53-123627-002	86	Disc	16.50" x 5.00"	8.79"	5.11"	8.78"	11.25"	10	1.28"	
85-120516-002	78	Spoke	15.00" x 6.00"	7.09"	6.50"	9.44"	11.00"	5	.66"	
85-120517-002	76	Spoke	15.00" x 5.00"	6.59"	5.56"	9.44"	11.00"	5	.66"	
85-120586-002	115	Spoke	16.50" x 7.00"	8.75"	7.50"	9.50"	11.25"	6	.66"	
85-120855-002	92	Spoke	16.50" x 5.00"	6.12"	5.37"	9.25"	11.25"	6	.78"	
85-120877-002	115	Disc	16.50" x 7.00"	10.69"	7.53"	9.44"	11.25"	10	.84"	
85-122009-002	104	Spoke	16.50" x 7.00"	8.65"	7.65"	10.50"	12.75"	5	.78"	
85-122011-002	89	Spoke	15.00" x 7.00"	8.51"	7.36"	10.50"	12.75"	5	.78"	
85-122103-002	118	Spoke	16.50" x 7.00"	8.75"	7.50"	9.50"	11.25"	5	.78"	
85-122266-002	89	Spoke	16.50" x 5.00"	6.41"	5.44"	10.00"	12.75"	6	.78"	
85-122505-002	73	Spoke	15.00" x 4.00"	7.90"	4.50"	9.44"	11.25"	10	.81"	
85-122518-002	102	Disc	16.50" x 7.00"	8.75"	7.50"	9.50"	11.25"	10	.81"	
85-122550-002	106	Disc	16.50" x 7.00"	10.59"	7.75"	9.00"	11.25"	10	.81"	
85-122600-002	107	Spoke	16.50" x 7.00"	7.94"	7.31"	11.00"	12.75"	5/6	.66/.66"	
85-122683-002	106	Spoke	16.50" x 7.00"	8.45"	7.39"	11.25"	12.75"	5/6	.78/.78"	
85-122921-002	84	Disc	15.00" x 4.00"	8.98"	5.09"	8.75"	11.25"	10	.81"	
85-122947-002	61	Spoke	15.00" x 4.00"	5.60"	4.68"	11.00"	12.75"	6	.78"	
85-122948-002	116	Disc	16.50" x 7.00"	10.31"	7.64"	9.00"	11.25"	10	.81"	
85-122954-002	79	Spoke	16.50" x 5.00"	6.57"	6.01"	11.00"	12.75"	6	.78"	
85-122964-002	61	Spoke	15.00" x 4.00"	5.56"	4.69"	11.00"	12.75"	5	.78"	
85-122966-002	96	Disc	16.50" x 5.00"	9.63"	5.74"	8.75"	11.25"	10	.81"	
85-123200-002	109	Spoke	16.50" x 7.00"	8.65"	7.65"	10.50"	12.75"	6	.78"	
85-123203-002	90	Spoke	15.00" x 7.00"	8.51"	7.36"	10.50"	12.75"	6	.78"	
85-123207-002	111	Disc	16.50" x 7.00"	10.54"	7.46"	8.78"	11.25"	10	1.02"	

DRUM NUMERICAL LISTING

CAST BRAKE DRUMS - BALANCED -- MACHINE-TO-BALANCE (MTB)

PART NUMBER	WEIGHT	WHEEL TYPE	BRAKE SIZE	OVER-ALL DEPTH	BRAKE SURFACE WIDTH	PILOT DIA.	BOLT HOLES			COMMENTS
							BOLT DIA.	NO.	SIZE	
85-123254-002	69	Disc	15.00" x 4.00"	8.85"	4.46"	8.78"	11.25"	10	1.28"	
85-123276-002	96	Disc	15.00" x 7.00"	10.92"	7.50"	8.99"	11.25"	8	.84"	275MM Bolt Circle
85-123297-002	119	Disc	16.50" x 7.00"	10.31"	7.64"	9.00"	11.25"	10	.85"	
85-123331-002	85	Disc	15.00" x 6.00"	8.79"	6.75"	8.99"	10.83"	8	.84"	275mm Bolt Circle
85-123332-002	71	Disc	15.00" x 5.00"	8.02"	5.47"	8.99"	10.83"	8	.84"	275mm Bolt Circle
85-123345-002	68	Disc	15.00" x 4.00"	8.76"	4.64"	8.99"	10.83"	8	.84"	Ford application
85-123348-002	104	Spoke	16.50" x 7.00"	10.92"	7.75"	8.99"	10.83"	8	.84"	
85-123365-002	122	Disc	16.50" x 7.00"	10.59"	7.75"	8.78"	11.25"	10	.94"	285.75mm Bolt Circle. Heavy duty version of 85-123207
85-123366-002	70	Disc	15.00" x 4.00"	8.85"	4.56"	8.78"	11.25"	10	.94"	285.75mm Bolt Circle
85-123370-002	114	Disc	16.50" x 5.00"	9.14"	5.50"	8.78"	11.25"	10	.94"	
85-123382-002	67	Disc	15.00" x 4.00"	8.85"	4.75"	8.78"	11.25"	10	1.28"	
85-123383-002	96	Disc	16.50" x 5.00"	9.14"	5.50"	8.78"	11.25"	10	1.28"	
85-123396-002	84	Disc	15.00" x 4.00"	8.97"	5.09"	8.78"	11.25"	10	.94"	
85-123397-002	116	Disc	16.50" x 7.00"	10.31"	7.63"	8.78"	11.25"	10	.94"	
85-123399-002		Disc	16.50" x 6.00"	9.81"	6.69"	8.78"	11.25"	10	1.28"	
85-123400-002	105	Disc	16.50" x 6.00"	9.81"	6.69"	8.78"	11.25"	10	.94"	285.75mm Bolt Circle
85-123406-002	142	Disc	16.50" x 8.63"	11.98"	9.13"	8.78"	11.25"	10	.94"	Outboard mount; 285.75mm Bolt Circle; heavy duty 03-122513
85-123409-002	123	Disc	16.50" x 7.00"	10.59"	7.75"	9.00"	10.83"	8	.94"	275mm Bolt Circle
85-123420-002	98	Disc	15.00" x 4.00"	8.85"	4.66"	8.78"	11.25"	10	1.28"	
85-123421-002	76	Disc	15.00" x 4.00"	8.85"	4.66"	8.78"	11.25"	10	.94"	Heavy Duty 03-123366-002
85-123427-002	93	Spoke	16.50" x 6.00"	7.49"	6.69"	11.25"	12.75"	6	.78"	
85-123428-002	142	Disc	16.50" x 8.63"	12.33"	9.48"	8.78"	11.25"	10	.94"	
85-123431-002	65	Spoke	15.00" x 4.00"	5.84"	4.75"	9.25"	11.25"	6	.78"	
85-123444-002	85	Disc	15.00" x 4.00"	9.10"	4.65"	9.00"	10.83"	8	.94"	
85-123448-002	107	Disc	15.00" x 4.00"	9.10"	4.65"	8.78"	11.25"	10	1.28"	
85-123463-002	97	Disc	16.50" x 5.00"	9.63"	5.74"	8.78"	11.25"	10	.94"	GMC application
85-123465-002	90	Disc	15.00" x 5.00"	10.08"	6.34"	8.78"	11.25"	10	.94"	
85-123466-002	121	Disc	15.00" x 8.63"	12.20"	9.58"	8.78"	11.25"	10	.94"	
85-123520-002	124	Disc	16.50" x 8.00"	11.09"	8.91"	8.78"	11.25"	10	.94"	Axle capacity 23,000 lbs.
85-123548-002	110	Disc	15.00" x 7.00"	10.18"	7.56"	8.70"	10.83"	8	.85"	275mm Bolt Circle
85-123553-002	90	Disc	15.00" x 4.00"	9.07"	4.72"	11.06"	13.19"	10	1.02"	335mm Bolt Circle
85-123556-002	123	Disc	16.50" x 6.00"	9.51"	6.61"	8.78"	11.25"	10	.94"	
85-123561-002	115	Disc	16.50" x 6.00"	9.83"	6.82"	11.71"	13.73"	10	.98"	
85-123569-002	85	Disc	16.50" x 6.00"	9.91"	6.88"	9.14"	11.25"	10	1.33"	
85-123570-002	138	Disc	16.50" x 8.63"	11.25"	9.11"	8.78"	11.25"	10	.94"	
85-123651-002		Disc	16.50" x 6.00"	9.73"	6.61"	8.78"	11.25"	10	1.28"	
85-123652-002	123	Disc	16.50" x 7.00"	10.54"	7.60"	8.78"	11.25"	10	1.00"	

DRUMS BY BRAKE SIZE

12.25" X 5.50"

BOLT HOLES

OVERALL DEPTH	BRAKE SURFACE WIDTH	PILOT DIA.	BOLT CIRCLE DIA.	NO.	SIZE	WEIGHT	PART NUMBER	WHEEL TYPE
7.44"	6.53"	8.50"	10.00"	6/6	.66/.66"	54	03-122488-002	Spoke

12.25" X 7.50"

BOLT HOLES

OVERALL DEPTH	BRAKE SURFACE WIDTH	PILOT DIA.	BOLT CIRCLE DIA.	NO.	SIZE	WEIGHT	PART NUMBER	WHEEL TYPE
8.81"	8.00"	8.50"	10.00"	6/6	.66/.66"	66	03-122963-002	Spoke
8.81"	8.00"	8.50"	10.00"	6	.66"	62	03-120822-002	Spoke
9.00"	7.88"	7.00"	8.25"	6/6	.53/.66"	82	03-122971-002	Spoke

15.00" X 3.00"

BOLT HOLES

OVERALL DEPTH	BRAKE SURFACE WIDTH	PILOT DIA.	BOLT CIRCLE DIA.	NO.	SIZE	WEIGHT	PART NUMBER	WHEEL TYPE
4.13"	3.56"	10.00"	11.00"	5	.53"	37	03-120705-002	Spoke
4.69"	3.50"	6.45"	8.00"	5	.66"	45	03-122314-002	Spoke

15.00" X 4.00"

BOLT HOLES

OVERALL DEPTH	BRAKE SURFACE WIDTH	PILOT DIA.	BOLT CIRCLE DIA.	NO.	SIZE	WEIGHT	PART NUMBER	WHEEL TYPE
5.26"	4.31"	9.50"	11.25"	6	.78"	66	03-122078-002	Spoke
5.54"	4.44"	9.19"	11.25"	5/6	.66/.66"	60	03-122575-002	Spoke
5.56"	4.69"	11.00"	12.75"	5	.78"	61	85-122964-002	Spoke
5.56"	4.69"	11.00"	12.75"	5	.78"	61	03-122964-002	Spoke
5.60"	4.68"	11.00"	12.75"	6	.78"	61	03-122947-002	Spoke
5.60"	4.68"	11.00"	12.75"	6	.78"	61	85-122947-002	Spoke
5.84"	4.54"	9.25"	11.25"	6	.78"	64	03-122104-002	Spoke
5.84"	4.75"	9.25"	11.25"	6	.78"	65	85-123431-002	Spoke
5.84"	4.75"	9.25"	11.25"	6	.78"	65	03-123431-002	Spoke
6.41"	4.66"	6.25"	8.75"	6	.84"	57	03-120566-002	Disc
7.84"	4.44"	8.66"	11.25"	10	1.27"	76	03-120981-002	Disc
7.84"	4.44"	8.78"	11.25"	10	1.27"	69	03-123020-002	Disc
7.90"	4.50"	9.44"	11.25"	10	.81"	73	85-122505-002	Spoke
8.60"	4.86"	8.78"	285.75mm	10	1.25"	62	53-123512-002	Disc
8.64"	5.11"	8.78"	285.75mm	10	.96"	63	53-123567-002	Disc
8.76"	4.64"	8.99"	10.83"	8	.84"	68	85-123345-002	Disc
8.79"	4.65"	8.78"	11.25"	10	1.25"	79	03-123254-002	Disc
8.85"	4.46"	8.78"	11.25"	10	1.28"	69	85-123254-002	Disc
8.85"	4.56"	8.78"	11.25"	10	.94"	70	03-123366-002	Disc
8.85"	4.56"	8.78"	11.25"	10	.94"	70	85-123366-002	Disc
8.85"	4.66"	8.78"	11.25"	10	1.28"	98	85-123420-002	Disc
8.85"	4.66"	8.78"	11.25"	10	.94"	76	85-123421-002	Disc
8.85"	4.66"	8.78"	11.25"	10	1.28"	75	03-123420-002	Disc
8.85"	4.66"	8.78"	11.25"	10	.94"	76	03-123421-002	Disc
8.85"	4.75"	8.78"	11.25"	10	1.28"	69	03-123382-002	Disc
8.85"	4.75"	8.78"	11.25"	10	1.28"	67	85-123382-002	Disc
8.86"	4.53"	8.75"	11.25"	10	1.28"	88	03-122529-002	Disc
8.87"	4.53"	11.25"	13.19"	10	.94"	82	03-123024-002	Disc
8.89"	4.57"	8.53"	11.25"	10	1.28"	93	53-123609-002	Disc

DRUMS BY BRAKE SIZE

15.00" X 4.00" (cont)

OVERALL DEPTH	BRAKE SURFACE WIDTH	PILOT DIA.	BOLT CIRCLE DIA.	BOLT HOLES		WEIGHT	PART NUMBER	WHEEL TYPE
				NO.	SIZE			
8.89"	4.76"	8.78"	285.75mm	10	.96"	64	53-123568-002	Disc
8.89"	4.76"	8.99"	275mm	8	.94"	64	53-123575-002	Disc
8.89"	7.76"	8.78"	285.75mm	10	1.25"	63	53-123542-002	Disc
8.97"	5.09"	8.78"	11.25"	10	.94"	84	03-123396-002	Disc
8.97"	5.09"	8.78"	11.25"	10	.94"	84	85-123396-002	Disc
8.98"	5.09"	8.75"	11.25"	10	.81"	84	85-122921-002	Disc
8.98"	5.09"	8.75"	11.25"	10	.81"	84	03-122921-002	Disc
9.07"	4.72"	11.06"	13.19"	10	1.02"	90	85-123553-002	Disc
9.10"	4.65"	8.78"	11.25"	10	1.28"	107	85-123448-002	Disc
9.10"	4.65"	8.78"	11.25"	10	1.28"	74	03-123448-002	Disc
9.10"	4.65"	9.00"	10.83"	8	.94"	85	85-123444-002	Disc

15.00" X 5.00"

OVERALL DEPTH	BRAKE SURFACE WIDTH	PILOT DIA.	BOLT CIRCLE DIA.	BOLT HOLES		WEIGHT	PART NUMBER	WHEEL TYPE
				NO.	SIZE			
6.59"	5.56"	9.44"	11.00"	5	.66"	76	85-120517-002	Spoke
6.59"	5.56"	9.44"	11.00"	5	.66"	76	03-120517-002	Spoke
7.99"	5.72"	6.44"	8.75"	10	.78"	73	03-122561-002	Disc
7.99"	5.72"	6.44"	8.75"	6	.84"	72	03-122562-002	Disc
8.02"	5.47"	8.99"	10.83"	8	.84"	71	85-123332-002	Disc
9.53"	5.81"	8.78"	11.25"	10	1.28"	70	53-123598-002	Disc
9.53"	5.81"	8.78"	285.75mm	10	.94"	70	53-123600-002	Disc
10.08"	6.34"	8.78"	11.25"	10	.94"	90	85-123465-002	Disc

15.00" X 6.00"

OVERALL DEPTH	BRAKE SURFACE WIDTH	PILOT DIA.	BOLT CIRCLE DIA.	BOLT HOLES		WEIGHT	PART NUMBER	WHEEL TYPE
				NO.	SIZE			
7.09"	6.50"	9.44"	11.00"	5	.66"	78	85-120516-002	Spoke
7.09"	6.50"	9.44"	11.00"	5	.66"	83	03-120516-002	Spoke
8.79"	6.75"	8.99"	10.83"	8	.84"	85	85-123331-002	Disc
8.79"	6.75"	8.99"	10.83"	8	.84"	84	03-123331-002	Disc
8.81"	6.75"	8.78"	11.25"	10	.94"	90	03-123493-002	Disc

15.00" X 7.00"

OVERALL DEPTH	BRAKE SURFACE WIDTH	PILOT DIA.	BOLT CIRCLE DIA.	BOLT HOLES		WEIGHT	PART NUMBER	WHEEL TYPE
				NO.	SIZE			
8.02"	5.47"	8.99"	10.82"	8	.84"	73	03-123332-002	Disc
8.51"	7.36"	10.50"	12.75"	5	.78"	89	03-122011-002	Spoke
8.51"	7.36"	10.50"	12.75"	6	.78"	90	85-123203-002	Spoke
8.51"	7.36"	10.50"	12.75"	5	.78"	89	85-122011-002	Spoke
10.18"	7.56"	8.70"	10.83"	8	.85"	110	85-123548-002	Disc
10.22"	7.42"	8.53"	11.25"	10	.81"	80	53-123592-002	Disc
10.92"	7.50"	8.99"	10.83"	8	.84"	96	03-123276-002	Disc
10.92"	7.50"	8.99"	11.25"	8	.84"	96	85-123276-002	Disc

DRUMS BY BRAKE SIZE

15.00" X 8.63"

OVERALL DEPTH	BRAKE SURFACE WIDTH	PILOT DIA.	BOLT CIRCLE DIA.	BOLT HOLES		WEIGHT	PART NUMBER	WHEEL TYPE
				NO.	SIZE			
11.44"	9.11"	8.78"	285.75mm	10	.94"	91	53-123601-002	Disc
11.44"	9.11"	9.00"	275mm	8	.94"	91	53-123602-002	Disc
12.20"	8.83"	8.78"	11.25"	10	.94"	121	03-123466-002	Disc
12.20"	9.58"	8.78"	11.25"	10	.94"	121	85-123466-002	Disc

16.50" X 5.00"

OVERALL DEPTH	BRAKE SURFACE WIDTH	PILOT DIA.	BOLT CIRCLE DIA.	BOLT HOLES		WEIGHT	PART NUMBER	WHEEL TYPE
				NO.	SIZE			
6.12"	5.37"	9.25"	11.25"	6	.78"	92	03-120855-002	Spoke
6.12"	5.37"	9.25"	11.25"	6	.78"	92	85-120855-002	Spoke
6.41"	5.44"	10.00"	12.75"	6	.78"	89	85-122266-002	Spoke
6.41"	5.44"	10.00"	12.75"	5/6/7	.78"	89	03-123500-002	Spoke /Disc
6.57"	6.01"	11.00"	12.75"	6	.78"	79	85-122954-002	Spoke
8.58"	5.48"	8.66"	11.25"	10	1.27"	86	03-120988-002	Disc
8.58"	5.48"	8.78"	11.25"	10	.94"	100	03-123538-002	Disc
8.59"	5.87"	8.53"	11.25"	10	1.28"	77	53-123605-002	Disc
8.59"	5.87"	8.78"	11.25"	10	1.28"	77	53-123606-002	Disc
8.79"	5.11"	8.78"	11.25"	10	1.28"	86	53-123627-002	Disc
9.14"	5.50"	8.78"	11.25"	10	1.28"	63	03-123383-002	Disc
9.14"	5.50"	8.78"	11.25"	10	1.28"	96	85-123383-002	Disc
9.14"	5.50"	8.78"	11.25"	10	.94"	114	85-123370-002	Disc
9.16"	5.54"	11.25"	13.19"	10	.94"	90	13-123219-002	Disc
9.16"	5.54"	11.25"	13.19"	10	.94"	90	03-123219-002	Disc
9.22"	5.82"	8.53"	11.25"	10	1.28"	79	53-123590-002	Disc
9.22"	5.82"	8.78"	11.25"	10	1.28"	79	53-123589-002	Disc
9.22"	5.82"	9.00"	275mm	8	.94"	79	53-123588-002	Disc
9.63"	5.74"	8.75"	11.25"	10	.81"	96	03-122966-002	Disc
9.63"	5.74"	8.75"	11.25"	10	.81"	96	85-122966-002	Disc
9.63"	5.74"	8.78"	11.25"	10	.94"	97	85-123463-002	Disc

16.50" X 6.00"

OVERALL DEPTH	BRAKE SURFACE WIDTH	PILOT DIA.	BOLT CIRCLE DIA.	BOLT HOLES		WEIGHT	PART NUMBER	WHEEL TYPE
				NO.	SIZE			
7.49"	6.69"	11.25"	12.75"	6	.78"	93	85-123427-002	Spoke
7.49"	6.69"	11.25"	12.75"	6	.78"	142	03-123427-002	Disc
9.51"	6.61"	8.78"	11.25"	10	.94"	123	85-123556-002	Disc
9.62"	6.68"	8.78"	285.75mm	10	.94"	87	53-123607-002	Disc
9.62"	6.68"	8.78"	11.25"	10	1.28"	87	53-123608-002	Disc
9.73"	6.61"	8.78"	11.25"	10	1.28"		85-123651-002	Disc
9.75"	6.63"	11.25"	13.19"	10	.94"	113	13-123302-002	Disc
9.75"	6.63"	11.25"	13.19"	10	.94"	109	03-123302-002	Disc
9.81"	6.69"	8.78"	11.25"	10	1.28"	107	03-123399-002	Disc
9.81"	6.69"	8.78"	11.25"	10	1.28"		85-123399-002	Disc
9.81"	6.69"	8.78"	11.25"	10	.94"	105	85-123400-002	Disc
9.83"	6.82"	11.71"	13.73"	10	.98"	115	85-123561-002	Disc
9.91"	6.88"	9.14"	11.25"	10	1.33"	85	85-123569-002	Disc

DRUMS BY BRAKE SIZE

16.50" X 7.00"

OVERALL DEPTH	BRAKE SURFACE WIDTH	PILOT DIA.	BOLT CIRCLE DIA.	BOLT HOLES		WEIGHT	PART NUMBER	WHEEL TYPE
				NO.	SIZE			
7.94"	7.31"	11.00"	12.75"	6	.66"	99	03-120743-002	Spoke
7.94"	7.31"	11.00"	12.75"	5/6	.66/.66"	107	85-122600-002	Spoke
7.94"	7.31"	11.00"	12.75"	5/6	.66"	106	03-122600-002	Spoke
8.03"	7.44"	14.25"	12.75"	5	.78"	109	03-122925-002	Spoke
8.03"	7.44"	14.25"	12.75"	5/6	.66/.66"	109	03-122455-002	Spoke
8.41"	7.63"	9.44"	11.00"	5/6	.78/.66"	108	03-122222-002	Spoke
8.44"	7.38"	11.00"	12.50"	5/6	.66/.66"	103	03-120754-002	Spoke
8.45"	7.39"	11.25"	12.75"	5/6	.78/.78"	106	85-122683-002	Spoke
8.45"	7.39"	11.25"	12.75"	5/6	.78/.78"	106	03-122683-002	Spoke
8.65"	7.50"	11.00"	12.50"	5	.66"	106	03-120442-002	Spoke
8.65"	7.65"	10.50"	12.75"	6	.78"	109	03-123200-002	Spoke
8.65"	7.65"	10.50"	12.75"	6	.78"	109	85-123200-002	Spoke
8.65"	7.65"	10.50"	12.75"	5/6	.78/.78"	105	03-123430-002	Spoke
8.65"	7.65"	10.50"	12.75"	5	.78"	104	85-122009-002	Spoke
8.65"	7.65"	10.50"	12.75"	5	.78"	105	03-122009-002	Spoke
8.72"	7.56"	11.25"	12.75"	5	.78"	103	03-120574-002	Spoke
8.75"	7.50"	9.44"	11.00"	5	.78"	103	03-122603-002	Spoke
8.75"	7.50"	9.50"	11.25"	5/6	.78/.66"	116	03-120586-002	Spoke
8.75"	7.50"	9.50"	11.25"	5	.78"	118	85-122103-002	Spoke
8.75"	7.50"	9.50"	11.25"	10	.84"	117	03-122126-002	Spoke/Disc
8.75"	7.50"	9.50"	11.25"	6	.66"	115	85-120586-002	Spoke
8.75"	7.50"	9.50"	11.25"	10	.81"	102	03-122518-002	Disc
8.75"	7.50"	9.50"	11.25"	10	.81"	102	85-122518-002	Disc
8.94"	7.63"	9.50"	11.25"	10	.84"	119	03-122239-002	Disc
8.94"	7.63"	9.50"	11.25"	6	.78"	119	03-122290-002	Spoke
8.94"	7.63"	9.50"	11.25"	5	.78"	120	03-122027-002	Spoke
9.00"	7.60"	11.25"	12.75"	6	.66"	112	03-012480-002	Spoke
9.50"	7.56"	8.44"	11.25"	10	.84"	111	03-123398-002	Disc
9.50"	7.56"	9.44"	11.25"	10	.84"	118	03-012582-002	Disc
10.04"	7.27"	8.53"	11.25"	10	.81"	91	53-123582-002	Disc
10.04"	7.27"	8.78"	285.75mm	10	.94"	89	53-123583-002	Disc
10.31"	7.63"	8.78"	11.25"	10	.94"	116	85-123397-002	Disc
10.31"	7.63"	9.00"	11.25"	10	.84"	123	03-123297-002	Disc
10.31"	7.64"	8.78"	11.25"	10	.94"	123	03-123397-002	Disc
10.31"	7.64"	9.00"	11.25"	10	.81"	116	85-122948-002	Disc
10.31"	7.64"	9.00"	11.25"	10	.85"	119	85-123297-002	Disc
10.31"	7.64"	9.00"	11.25"	10	.81"	116	03-122948-002	Disc
10.38"	7.44"	8.53"	11.25"	10	.81"	112	03-122453-002	Disc
10.38"	7.86"	8.53"	11.25"	10	.81"	94	53-123564-002	Disc
10.38"	7.86"	9.00"	11.25"	10	.81"	93	53-123565-002	Disc
10.38"	7.86"	9.00"	275mm	8	.92"	93	53-123566-002	Disc
10.38"	7.87"	8.78"	285.75mm	10	.94"	94	53-123537-002	Disc
10.54"	7.46"	8.78"	11.25"	10	1.02"	112	03-123207-002	Disc
10.54"	7.46"	8.78"	11.25"	10	1.02"	111	85-123207-002	Disc
10.54"	7.60"	8.78"	11.25"	10	1.00"	123	85-123652-002	Disc
10.59"	7.75"	8.78"	11.25"	10	.94"	122	85-123365-002	Disc
10.59"	7.75"	8.78"	11.25"	10	.94"	122	03-123365-002	Disc
10.59"	7.75"	9.00"	11.25"	10	.81"	106	03-122550-002	Disc
10.59"	7.75"	9.00"	10.83"	8	.94"	123	85-123409-002	Disc
10.59"	7.75"	9.00"	11.25"	10	.81"	106	85-122550-002	Disc
10.59"	7.75"	9.00"	10.83"	8	.94"	123	03-123409-002	Disc
10.59"	7.75"	11.25"	13.19"	10	.94"	122	03-123025-002	Disc

DRUMS BY BRAKE SIZE

16.50" X 7.00" (cont)

OVERALL DEPTH	BRAKE SURFACE WIDTH	PILOT DIA.	BOLT CIRCLE DIA.	BOLT HOLES		WEIGHT	PART NUMBER	WHEEL TYPE
				NO.	SIZE			
10.63"	7.82"	8.53"	11.25"	10	.81"	112	03-122978-002	Disc
10.63"	7.82"	8.53"	11.25"	10	.81"	117	03-122607-002	Disc
10.69"	7.53"	9.44"	11.25"	10	.84"	115	85-120877-002	Disc
10.69"	7.53"	9.44"	11.25"	10	.84"	115	03-120877-002	Disc
10.92"	7.75"	8.99"	10.83"	8	.84"	104	85-123348-002	Spoke

16.50" X 8.00"

OVERALL DEPTH	BRAKE SURFACE WIDTH	PILOT DIA.	BOLT CIRCLE DIA.	BOLT HOLES		WEIGHT	PART NUMBER	WHEEL TYPE
				NO.	SIZE			
10.96"	8.62"	8.78"	285.75mm	10	.94"	95	53-123535-002	Disc
11.09"	8.90"	8.78"	11.25"	10	.94"	128	03-123520-002	Disc
11.09"	8.91"	8.78"	11.25"	10	.94"	124	85-123520-002	Disc

16.50" X 8.63"

OVERALL DEPTH	BRAKE SURFACE WIDTH	PILOT DIA.	BOLT CIRCLE DIA.	BOLT HOLES		WEIGHT	PART NUMBER	WHEEL TYPE
				NO.	SIZE			
10.25"	9.22"	9.50"	11.25"	10	.84"	131	03-120376-002	Spoke/Disc
11.04"	9.15"	8.78"	11.25"	10	.93"	102	53-123544-002	Disc
11.16"	9.06"	9.44"	11.25"	10	.81"	127	03-120882-002	Disc
11.25"	9.11"	8.78"	11.25"	10	.94"	138	85-123570-002	Disc
11.98"	9.13"	8.78"	11.25"	10	.94"	142	85-123406-002	Disc
11.98"	9.13"	8.78"	11.25"	10	.94"	142	03-123406-002	Disc
12.15"	9.38"	8.53"	11.25"	10	.81"	106	53-123580-002	Disc
12.15"	9.38"	8.78"	285.75mm	10	.94"	106	53-123581-002	Disc
12.15"	9.38"	9.00"	275mm	8	.94"	106	53-123579-002	Disc
12.27"	9.33"	9.44"	11.25"	10	.84"	127	03-122513-002	Disc
12.33"	9.48"	8.78"	11.25"	10	.94"	142	85-123428-002	Disc
12.33"	9.48"	8.78"	11.25"	10	.94"	142	03-123428-002	Disc

18.00" X 7.00"

OVERALL DEPTH	BRAKE SURFACE WIDTH	PILOT DIA.	BOLT CIRCLE DIA.	BOLT HOLES		WEIGHT	PART NUMBER	WHEEL TYPE
				NO.	SIZE			
8.25"	7.44"	11.00"	12.75"	6	.66"	132	03-120936-002	Spoke
9.25"	8.00"	11.25"	12.75"	6	.66"	135	03-012488-002	Spoke

TRAILER HUBS

FOR AXLE MODELS: Dana Spicer D-21, K-21
 Eaton C, C2, CB, CD, CD2, HC, HCE, E, ED, EH, 20L, 22L, 22R, 230C
 Ingersoll A19H, A19S, DC19H
 Meritor RL, TK, TL, TKLD, TKL
 Standard Forge A-19H, A-19S

HUB NO.	DESCRIPTION	TYPE
04-15413-XXX	Trailer Axle Hub Outboard Drum	10 Hole Serrated Studs
INNER BEARING		
CUP	CONE	BOLT CIRCLE
HM218210	HM218248	13.189"
OUTER BEARING		
CUP	CONE	
HM212011	HM212049	

DRAWING REFERENCE	ITEM	DIMENSION
A	Overall Length	6.93"
B	Outer Hub Cap Face To Inner Bearing Cup Seat	4.74"
C	Distance Between Cups	3.35"
D	Bolt Circle Diameter	13.189"
E	Wheel Stud Quantity	10
F	Pilot Diameter	11.25"
G	Hub Cap Hole Pattern	6, 5/16"-18; 5.50" B.C.

HUB PILOTED - Hub and Drum Assemblies

HUB PART NUMBER	WHEEL TYPE	DRUM TYPE	WHEEL STUD NUMBER	ABS RING NUMBER	DRUM SIZE	DRUM NUMBER	DRUM POSITION
14-15413-1032	Steel	Cast	E-9837		16.5 x 7	03-123025-002	Outboard

WHEEL STUDS USED WITH HUB IN ASSEMBLIES

WHEEL STUD NO.	THREAD TYPE SIZE	STYLE	WHEEL TYPE	USE WITH DRUM TYPE
E-11715	Serrated M22 x 1.5	Hub Piloted	Aluminum Wheel	Cast
E-9837	Serrated M22 x 1.5	Hub Piloted	Steel Wheel	Cast

DRUMS USED WITH HUB IN ASSEMBLIES

DRUM NO.	DRUM TYPE	BRAKE SIZE	OVERALL DEPTH	PILOT DIAMETER
03-123025-002	Cast Non-Balanced	16.50" x 7.00"	10.59"	11.25"

Note: Other combinations are available. For information please call the specifications department at 1-888-725-9355. Not all of the numbers listed above are stocked items; some may have lead times involved.

TRAILER HUBS

FOR AXLE MODELS:

HUB NO.	DESCRIPTION	TYPE
04-15479-XXX	Trailer Axle Hub Outboard Drum	10 Hole Serrated Studs
INNER BEARING		
CUP	CONE	BOLT CIRCLE
HM218210	HM218248	13.189"
OUTER BEARING		
CUP	CONE	
HM212011	HM212049	

DRAWING REFERENCE	ITEM	DIMENSION
A	Overall Length	6.93"
B	Outer Hub Cap Face To Inner Bearing Cup Seat	4.74"
C	Distance Between Cups	3.34"
D	Bolt Circle Diameter	13.189"
E	Wheel Stud Quantity	10
F	Pilot Diameter	11.25"
G	Hub Cap Hole Pattern	6, 5/16"-18; 5.50" B.C.

HUB PILOTED - Hub and Drum Assemblies

HUB PART NUMBER	WHEEL TYPE	DRUM TYPE	WHEEL STUD NUMBER	ABS RING NUMBER	DRUM SIZE	DRUM NUMBER	DRUM POSITION
14-15479-1000	Steel	Cast	E-9837	09-001867	16.5 x 7	03-123025-002	Outboard

STUDS USED WITH HUB IN ASSEMBLIES

STUD NO.	THREAD TYPE SIZE	STYLE	WHEEL TYPE	USE WITH DRUM TYPE
E-9837	Serrated M22 x 1.5	Hub Piloted	Steel Wheel	Cast

DRUMS USED WITH HUB IN ASSEMBLIES

DRUM NO.	DRUM TYPE	BRAKE SIZE	OVERALL DEPTH	PILOT DIAMETER
03-123025-002	Cast Non-Balanced	16.50" x 7.00"	10.59"	11.25"

Note: Other combinations are available. For information please call the specifications department at 1-888-725-9355. Not all of the numbers listed above are stocked items; some may have lead times involved.

TRAILER HUBS

FOR AXLE MODELS: Dana Spicer Eaton 225P, 230P, P22
Hendrickson HP
Meritor TP

Fruehauf Pro-Par
Ingersoll A24H, A24S, F24

HUB NO.	DESCRIPTION	TYPE
04-15502-XXX	Trailer Axle Hub Outboard Drum	10 Hole Serrated Studs
INNER BEARING		
CUP	CONE	BOLT CIRCLE
HM518410	HM518445	11.250"
OUTER BEARING		
CUP	CONE	
HM518410	HM518445	

DRAWING REFERENCE	ITEM	DIMENSION
A	Overall Length	9.06"
B	Outer Hub Cap Face To Inner Bearing Cup Seat	6.94"
C	Distance Between Cups	4.50"
D	Bolt Circle Diameter	11.25"
E	Wheel Stud Quantity	10
F	Pilot Diameter	8.78"
G	Hub Cap Hole Pattern	6.25"-8 TPI

HUB PART NUMBER	ABS RING NUMBER	COMMENTS
04-15502-022 ²	09-001867	
04-15968-045 ¹		Wheel studs not included

STUD PILOTED - Hub Assemblies without Drum

HUB PART NUMBER	HAND	WHEEL TYPE	DRUM TYPE	WHEEL STUD NUMBER	ABS RING NUMBER
04-15502-029	RH	Aluminum, Steel	Cast	E-111672R	
04-15502-030	LH	Aluminum, Steel	Cast	E-111672L	
04-15502-031	RH	Aluminum, Steel	Cast	E-111672R	09-001867
04-15502-032	LH	Aluminum, Steel	Cast	E-111672L	09-001867

HUB PILOTED - Hub Assemblies without Drum

HUB PART NUMBER	WHEEL TYPE	DRUM TYPE	WHEEL STUD NUMBER	ABS RING NUMBER
04-15502-004	Steel	Cast	E-9837	09-001867
04-15502-006	Aluminum	Cast, X30	E-11715	
04-15502-007	Aluminum	Cast, X30	E-11715	09-001867
04-15502-041			E-9837	09-001867
04-15968-002	Steel	Cast	E-9837	

STUD PILOTED - Hub and Drum Assemblies

HUB PART NUMBER	HAND	WHEEL TYPE	DRUM TYPE	WHEEL STUD NUMBER	ABS RING NUMBER	DRUM SIZE	DRUM NUMBER	DRUM POSITION
14-15502-087	RH	Aluminum, Steel	Cast	E-111672R		16.5 x 7	03-123365-002	Outboard
14-15502-088	LH	Aluminum, Steel	Cast	E-111672L		16.5 x 7	03-123365-002	Outboard

Note: Other combinations are available. For information please call the specifications department at 1-888-725-9355. Not all of the numbers listed above are stocked items; some may have lead times involved.

¹ Non-ABS

² ABS

TRAILER HUBS

HUB PILOTED - Hub and Drum Assemblies

HUB PART NUMBER	WHEEL TYPE	DRUM TYPE	WHEEL STUD NUMBER	ABS RING NUMBER	DRUM SIZE	DRUM NUMBER	DRUM POSITION
14-15502-050	Steel	Cast	E-9837		16.5 x 7	03-123365-002	Outboard
14-15502-051	Aluminum	Cast	E-11715		16.5 x 7	03-123365-002	Outboard
14-15502-064	Steel	Cast	E-9837		16.5 x 7	03-123365-002	Outboard
14-15502-503	Steel	Cast	E-9837	09-001867	16.5 x 7	03-123207-002	Outboard
14-15502-504	Aluminum	Cast	E-11715	09-001867	16.5 x 7	03-123207-002	Outboard

STUDS USED WITH HUB IN ASSEMBLIES

STUD NO.	THREAD TYPE SIZE	STYLE	WHEEL TYPE	USE WITH DRUM TYPE
E-11672-L	Serrated 3/4"-16 R	Stud Piloted	Steel Wheel	Cast
E-11672-R	Serrated 3/4"-16 R	Stud Piloted	Steel Wheel	Cast
E-11715	Serrated M22 x 1.5	Hub Piloted	Aluminum Wheel	Cast
E-9837	Serrated M22 x 1.5	Hub Piloted	Steel Wheel	Cast

DRUMS USED WITH HUB IN ASSEMBLIES

DRUM NO.	DRUM TYPE	BRAKE SIZE	OVERALL DEPTH	PILOT DIAMETER
03-123207-002	Cast Non-Balanced	16.50" x 7.00"	10.54"	8.78"
03-123365-002	Cast Non-Balanced	16.50" x 7.00"	10.59"	8.78"

Note: Other combinations are available. For information please call the specifications department at 1-888-725-9355. Not all of the numbers listed above are stocked items; some may have lead times involved.

LITE WEIGHT TP TRAILER HUBS

FOR AXLE MODELS: Dana Spicer Eaton 225P, 230P, P22
Fruehauf Pro-Par
Hendrickson HP
Ingersoll A24H, A24S, F24
Meritor TP

HUB NO.	DESCRIPTION	TYPE
04-15968-XXX	Trailer Axle Hub Outboard Drum	10 Hole Serrated Studs
INNER BEARING		
CUP	CONE	BOLT CIRCLE
HM518410	HM518445	11.250"
OUTER BEARING		
CUP	CONE	
HM518410	HM518445	

DRAWING REFERENCE	ITEM	DIMENSION
A	Overall Length	8.08"
B	Outer Hub Cap Face To Inner Bearing Cup Seat	5.96"
C	Distance Between Cups	4.50"
D	Bolt Circle Diameter	11.25"
E	Wheel Stud Quantity	10
F	Pilot Diameter	8.78"
G	Hub Cap Hole Pattern	6, 5/16"-18; 6.75" B.C.

HUB PART NUMBER	ABS RING NUMBER	COMMENTS
04-15968-045		Wheel studs not included

HUB PILOTED - Hub Assemblies without Drum

HUB PART NUMBER	WHEEL TYPE	DRUM TYPE	WHEEL STUD NUMBER	ABS RING NUMBER
04-15968-002	Steel	Cast	E-9837	
04-15968-007	Steel	Cast	E-9837	09-001867
04-15968-009	Aluminum	Cast	E-11715	09-001867
04-15968-037			E-9837	
04-15968-038			E-9837	09-001867
04-15968-043			E-11715	
04-15968-044			E-11715	09-001867

STUD PILOTED - Hub and Drum Assemblies

HUB PART NUMBER	HAND	WHEEL TYPE	DRUM TYPE	WHEEL STUD NUMBER	ABS RING NUMBER	DRUM SIZE	DRUM NUMBER	DRUM POSITION
14-15968-129	RH	Aluminum, Steel	Cast	E-111672R		16.5 x 7	03-123207-002	Outboard
14-15968-130	LH	Aluminum, Steel	Cast	E-111672L		16.5 x 7	03-123207-002	Outboard

Note: Other combinations are available. For information please call the specifications department at 1-888-725-9355. Not all of the numbers listed above are stocked items; some may have lead times involved.

LITE WEIGHT TP TRAILER HUBS

HUB PILOTED - Hub and Drum Assemblies

HUB PART NUMBER	WHEEL TYPE	DRUM TYPE	WHEEL STUD NUMBER	ABS RING NUMBER	DRUM SIZE	DRUM NUMBER	DRUM POSITION
14-15968-1033	Steel	Cast	E-9837	09-001867	16.5 x 7	03-123207-002	Outboard
14-15968-1082	Steel	Cast	E-9837	09-001867	16.5 x 7	03-123207-002	Outboard
14-15968-1083	Steel	Cast	E-9837		16.5 x 7	03-123207-002	Outboard
14-15968-1107X30	Steel	X30	E-11714	09-001867	16.5 x 7	53-123537-002	Outboard
14-15968-111	Steel	Cast	E-9837		16.5 x 7	03-123207-002	Outboard
14-15968-112	Aluminum	Cast	E-11715		16.5 x 7	03-123207-002	Outboard
14-15968-114	Aluminum	Cast	E-11715	09-001867	16.5 x 7	03-123207-002	Outboard
14-15968-1230	Steel	Cast	E-9837		16.5 x 7	03-123365-002	Outboard
14-15968-1234	Steel	Cast	E-9837	09-001867	16.5 x 7	03-123365-002	Outboard
14-15968-1235	Aluminum	Cast	E-11715	09-001867	16.5 x 7	03-123365-002	Outboard
14-15968-350X30	Steel	X30	E-11714		16.5 x 7	53-123537-002	Outboard
14-15968-351X30	Aluminum	X30	E-11715		16.5 x 7	53-123537-002	Outboard
14-15968-352X30	Steel	X30	E-11714	09-001867	16.5 x 7	53-123537-002	Outboard
14-15968-353X30	Aluminum	X30	E-11715	09-001867	16.5 x 7	53-123537-002	Outboard
14-15968-1293MTB	Steel	Cast	E-9837	09-001867	16.5 x 8.63	85-123570-002	Outboard

WHEEL STUDS USED WITH HUB IN ASSEMBLIES

WHEEL STUD NO.	THREAD TYPE SIZE	STYLE	WHEEL TYPE	USE WITH DRUM TYPE
E-11672-L	Serrated 3/4"-16 R	Stud Piloted	Steel Wheel	Cast
E-11672-R	Serrated 3/4"-16 R	Stud Piloted	Steel Wheel	Cast
E-11714	Serrated M22 x 1.5	Hub Piloted	Steel Wheel	X30
E-11715	Serrated M22 x 1.5	Hub Piloted	Aluminum Wheel	Cast
E-9837	Serrated M22 x 1.5	Hub Piloted	Steel Wheel	Cast

DRUMS USED WITH HUB IN ASSEMBLIES

DRUM NO.	DRUM TYPE	BRAKE SIZE	OVERALL DEPTH	PILOT DIAMETER
53-123537-002	X30	16.50" x 7.00"	10.38"	8.78"
03-123207-002	Cast Non-Balanced	16.50" x 7.00"	10.54"	8.78"
03-123365-002	Cast Non-Balanced	16.50" x 7.00"	10.59"	8.78"
85-123570-002	Cast MTB	16.50" x 8.63"	11.25"	8.78"

Note: Other combinations are available. For information please call the specifications department at 1-888-725-9355. Not all of the numbers listed above are stocked items; some may have lead times involved.

TRAILER HUBS

FOR AXLE MODELS: Meritor TL

HUB NO.	DESCRIPTION	TYPE
04-15981-XXX	Trailer Axle Hub Outboard Drum	10 Hole Serrated Studs
INNER BEARING		
CUP	CONE	BOLT CIRCLE
		11.25"
OUTER BEARING		
CUP	CONE	

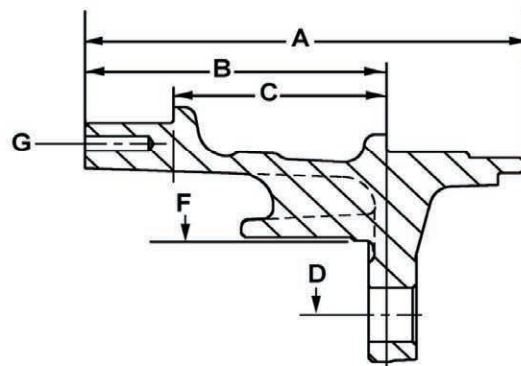

DRAWING REFERENCE	ITEM	DIMENSION
A	Overall Length	6.220"
B	Outer Hub Cap Face To Inner Bearing Cup Seat	5.12"
C	Distance Between Cups	4.33"
D	Bolt Circle Diameter	11.25"
E	Wheel Stud Quantity	10
F	Pilot Diameter	8.777"
G	Hub Cap Hole Pattern	6, 5/16"-18; 6.375" B.C.

HUB PILOTED - Hub Assemblies without Drum

HUB PART NUMBER	WHEEL TYPE	DRUM TYPE	WHEEL STUD NUMBER	ABS RING NUMBER
04-15981-016			E-9837	
04-15981-017			E-9837	09-001867
04-15981-018			E-11715	
04-15981-019			E-11715	09-001867

WHEEL STUDS USED WITH HUB IN ASSEMBLIES

WHEEL STUD NO.	THREAD TYPE SIZE	STYLE	WHEEL TYPE	USE WITH DRUM TYPE
E-11715	Serrated M22 x 1.5	Hub Piloted	Aluminum Wheel	Cast
E-9837	Serrated M22 x 1.5	Hub Piloted	Steel Wheel	Cast

Note: Other combinations are available. For information please call the specifications department at 1-888-725-9355. Not all of the numbers listed above are stocked items; some may have lead times involved.

LITE WEIGHT TN TRAILER HUBS

FOR AXLE MODELS: Dana Spicer Eaton 23L, 23R, D22, J, JE, JH, K22
 Dexter D200K, D2225K
 Hendrickson HN
 Ingersoll A22H, A22S, A22T, DC22H, F22
 K-B KBS, KBW
 Meritor RN, RQ, TKN, TN, TQ, TQC, TQD
 Std Forge A22H, A22S, A22T
 Westport F3W-1600, F3W-1800, F3W-1800D, F3W-2000, F3W-2000D

HUB NO.	DESCRIPTION	TYPE
04-15984-XXX	Trailer Axle Hub Outboard Drum	10 Hole Serrated Studs
INNER BEARING		
CUP	CONE	BOLT CIRCLE
HM218210	HM218248	11.250"
OUTER BEARING		
CUP	CONE	
HM212011	HM212049	

DRAWING REFERENCE	ITEM	DIMENSION
A	Overall Length	6.93"
B	Outer Hub Cap Face To Inner Bearing Cup Seat	4.73"
C	Distance Between Cups	3.34"
D	Bolt Circle Diameter	11.25"
E	Wheel Stud Quantity	10
F	Pilot Diameter	8.78"
G	Hub Cap Hole Pattern	6, 5/16"-18; 5.50" B.C.

HUB PART NUMBER	ABS RING NUMBER	COMMENTS
04-15984-001		Wheel studs not included

STUD PILOTED - Hub Assemblies without Drum

HUB PART NUMBER	HAND	WHEEL TYPE	DRUM TYPE	WHEEL STUD NUMBER	ABS RING NUMBER
04-15984-006	RH	Aluminum, Steel	Cast	E-111672R	09-001867
04-15984-007	RH	Aluminum, Steel	Cast	E-111672R	
04-15984-041	RH			E-111672R	09-001867
04-15984-042	LH			E-111672L	09-001867
04-15984-052	RH			E-111672R	
04-15984-053	LH			E-111672L	

Note: Other combinations are available. For information please call the specifications department at 1-888-725-9355. Not all of the numbers listed above are stocked items; some may have lead times involved.

LITE WEIGHT TN TRAILER HUBS

HUB PILOTED - Hub Assemblies without Drum

HUB PART NUMBER	WHEEL TYPE	DRUM TYPE	WHEEL STUD NUMBER	ABS RING NUMBER
04-15984-002	Steel	Cast	E-9837	09-001867
04-15984-003	Steel	Cast	E-9837	
04-15984-004	Aluminum, Steel	Cast	E-11715	09-001867
04-15984-005	Aluminum, Steel	Cast	E-11715	
04-15984-010			E-9837	
04-15984-012			E-9837	09-001867
04-15984-013			E-11715	09-001867
04-15984-036			E-11716	09-001867

STUD PILOTED - Hub and Drum Assemblies

HUB PART NUMBER	HAND	WHEEL TYPE	DRUM TYPE	WHEEL STUD NUMBER	ABS RING NUMBER	DRUM SIZE	DRUM NUMBER	DRUM POSITION
14-15984-1184	RH	Aluminum, Steel	Cast	E-111672R		16.5 x 7	03-123207-002	Outboard
14-15984-1185	LH	Aluminum, Steel	Cast	E-111672L		16.5 x 7	03-123207-002	Outboard
14-15984-1186	RH	Aluminum, Steel	Cast	E-111672R	09-001867	16.5 x 7	03-123207-002	Outboard
14-15984-1187	LH	Aluminum, Steel	Cast	E-111672L	09-001867	16.5 x 7	03-123207-002	Outboard
14-15984-1537X30	RH	Steel	X30	E-11661R	09-001867	16.5 x 7	53-123537-002	Outboard
14-15984-1540X30	LH	Steel	X30	E-11661L		16.5 x 7	53-123537-002	Outboard

HUB PILOTED - Hub and Drum Assemblies

HUB PART NUMBER	WHEEL TYPE	DRUM TYPE	WHEEL STUD NUMBER	ABS RING NUMBER	DRUM SIZE	DRUM NUMBER	DRUM POSITION
14-15984-1016	Steel	Cast	E-9837		16.5 x 7	03-123207-002	Outboard
14-15984-1017	Steel	Cast	E-9837	09-001867	16.5 x 7	03-123207-002	Outboard
14-15984-1038X30	Aluminum	X30	E-11715		16.5 x 7	53-123537-002	Outboard
14-15984-1039X30	Aluminum	X30	E-11715	09-001867	16.5 x 7	53-123537-002	Outboard
14-15984-1067	Steel	Cast	E-9837		16.5 x 7	03-123207-002	Outboard
14-15984-1068	Aluminum	Cast	E-11715		16.5 x 7	03-123207-002	Outboard
14-15984-1069	Steel	Cast	E-9837	09-001867	16.5 x 7	03-123207-002	Outboard
14-15984-1070	Aluminum	Cast	E-11715	09-001867	16.5 x 7	03-123207-002	Outboard
14-15984-1072	Aluminum	Cast	E-11715	09-001867	16.5 x 7	03-123207-002	Outboard
14-15984-1081	Aluminum	Cast	E-11715		16.5 x 7	03-123207-002	Outboard
14-15984-1085X30	Steel	X30	E-11714		16.5 x 7	53-123537-002	Outboard
14-15984-1089X30	Steel	X30	E-11714	09-001867	16.5 x 7	53-123537-002	Outboard

WHEEL STUDS USED WITH HUB IN ASSEMBLIES

WHEEL STUD NO.	THREAD TYPE SIZE	STYLE	WHEEL TYPE	USE WITH DRUM TYPE
E-11661-L	Serrated 3/4"-16 R	Stud Piloted	Steel Wheel	X30
E-11661-R	Serrated 3/4"-16 R	Stud Piloted	Steel Wheel	X30
E-11672-L	Serrated 3/4"-16 R	Stud Piloted	Steel Wheel	Cast
E-11672-R	Serrated 3/4"-16 R	Stud Piloted	Steel Wheel	Cast
E-11714	Serrated M22 x 1.5	Hub Piloted	Steel Wheel	X30
E-11715	Serrated M22 x 1.5	Hub Piloted	Aluminum Wheel	Cast
E-11716	Serrated M22 x 1.5	Hub Piloted	Aluminum, Steel	Cast
E-9837	Serrated M22 x 1.5	Hub Piloted	Steel Wheel	Cast

DRUMS USED WITH HUB IN ASSEMBLIES

DRUM NO.	DRUM TYPE	BRAKE SIZE	OVERALL DEPTH	PILOT DIAMETER
53-123537-002	X30	16.50" x 7.00"	10.38"	8.78"
03-123207-002	Cast Non-Balanced	16.50" x 7.00"	10.54"	8.78"

Note: Other combinations are available. For information please call the specifications department at 1-888-725-9355. Not all of the numbers listed above are stocked items; some may have lead times involved.

NOTES

INDEX

Wheel Attaching Parts	Page
Assortments and Display Boards	2-85
Brake Drum Attaching Screw	2-50
Bus and Heavy Duty Studs	2-17
Disc Wheel Nuts	2-3
Disc Wheel Service Information	2-62
Drive Flange Nuts	2-50
Drive Flange Studs	2-47
Drive Flange Studs - Metric	2-49
Drive Flange Wedges.....	2-49
Drum Bolt Assemblies.....	2-50
Gaskets	2-88
Gasket Assortment with Display Board	2-88
Hub Cap O-Ring	2-87
Hub Cap Plugs	2-87
Hub Caps.....	2-87
Inner Cap Nuts	2-1
Rim Clamps.....	2-53
Shoulder Studs	2-10
Spindle Hardware - Steer Axle.....	2-70
Spindle Hardware - Trailer Axle	2-63
Spindle Nut Assortment with Display Board.....	2-85
Spindle Nuts - Drive Axle	2-75
Spindle Washer Assortment with Display Board	2-85
Spoke Wheel and Rim Bolts	2-52
Spoke Wheel and Rim Studs	2-51
Spoke Wheel Service Information	2-61
Truck Wheel Bearing Lock-Nut Wrench Assortments with Display Board	2-86
Wheel Nuts.....	2-9
Wheel Studs	2-19
Wheel Studs - Metric.....	2-42

S.O.S. Special Order Service

Can't find it? Trouble sourcing parts? Need assistance?

Let Euclid's Special Order Service (S.O.S.) help.

Euclid's position as the market leader provides you access to the products and manufacturers listed below. These entire product lines are available to you by just placing a phone call to Euclid's S.O.S. Department at 866-238-2543 (option 2) in the U.S. or 800-387-3889 in Canada.

AIR BRAKE PARTS

Anchorlok
Bendix (Allied Signal)
Brake Shoes
Camshafts
Dana
Fruehauf
Haldex

HYDRAULIC BRAKE PARTS

Calipers - New & Remanufactured
Clutch Master Cylinders
Clutch Slave Cylinders
Dayton
EIS
Lucas
Master Cylinders
Rotors
Wagner Brake
Wheel Cylinders

FRICTION MATERIAL

Performance Friction
Tenneco HD Brake/CM

WHEEL & HUB PARTS

ConMet
Gunite
Webb Wheel

SHOCK ABSORBERS & AIR SPRINGS

Gabriel
Firestone
Neway
Monroe
Others

SUSPENSION PARTS

Binkley
Cambria
Chalmers
Fruehauf
Hendrickson
Hendrickson Turner
Hutchens
Kwik-Loc (Jifflox)
Neway
Page
Reyco/Transpro
Ridewell
Suspensions Incorporated
Torque Arms
Trailmobile
Full Suspensions Are Available

FRONT END PARTS

King Pin Kits
Tie Rod Ends
Drag Link Ends
Drag Links

AIR CONDITIONING & HEATING PARTS

Air Source
Robinair

TOOLS & SHOP EQUIPMENT

Fraser Gauge Company
Kent Moore
Ken Tool
OTC (Owatonna Tool Company)
Tiger Tool

Don't miss the sale! Call Euclid's Special Order Service.

INNER CAP NUTS

FOR DUAL MOUNTED STEEL AND STEEL/ALUMINUM WHEELS

EUCLID NO.	REPLACES	OUTER THREAD SIZE	INNER THREAD SIZE	INNER THREAD MIN. DEPTH	OUTER OVERALL LENGTH	APPLICATION & GENERAL INFORMATION
E-7895-L	Webb 107083	1.13"-16	.75"-16	1.25"	2.22"	Through Hardened. Zinc Yellow Dichromate Plating
	Budd 10709					
	Webb 107091					
	Meritor 1199K115					
	Reyco 30007					
	Std. Forge 303101					
	Budd 3203404					
	Navistar 41420V					
	Trailmobile 5034B2					
	Fruehauf 534767					
	Haldex 67210					
	Motor Wheel 84526					
	Paccar E7895L					
	Fruehauf MWCX01829					
	Leland W12					
	Leland W695					
	NWRA X1829					
E-7895-R	Budd 10708	1.13"-16	.75"-16	1.25"	2.22"	Through Hardened. Zinc Yellow Dichromate Plating
	Webb 107080					
	Webb 107082					
	Meritor 1199J114					
	Reyco 30006					
	Std. Forge 303100					
	Budd 3203403					
	Navistar 41419V					
	Trailmobile 5034B1					
	Trailmobile 5034B12					
	Fruehauf 534766					
	Haldex 67209					
	Motor Wheel 84525					
	Budd L107089					
	Fruehauf MWCX01828					
	Leland W11					
	Leland W694					
NWRA X1828						
E-7896-L	Budd 3203402	1.13"-16	.75"-16	1.25"	2.56"	Through Hardened
	Budd 320402					
	Budd 35337					
	Haldex 67288					
	Fruehauf MWCX01836					
	Leland W159					
	Leland W621					
NWRA X1836						
E-7896-R	Budd 3203401	1.13"-16	.75"-16	1.25"	2.56"	Through Hardened
	Budd 320401					
	HDA 337LB336RB					
	Budd 35336					
	Haldex 67287					
	Fruehauf MWCX01835					
	Leland W158					
Leland W620						
NWRA X1835						

O.E. STANDARD FOR DUAL STEEL WHEELS









O.E. STANDARD FOR STEEL INNER AND ALUMINUM OUTER WHEELS



INNER CAP NUTS

FOR DUAL MOUNTED STEEL AND STEEL/ALUMINUM WHEELS

	EUCLID NO.	REPLACES	OUTER THREAD SIZE	INNER THREAD SIZE	INNER THREAD MIN. DEPTH	OUTER OVERALL LENGTH	APPLICATION & GENERAL INFORMATION							
O.E. STANDARD FOR STEEL INNER AND ALUMINUM OUTER WHEELS 	E-7897-L	Meritor 1199G969	1.13"-16	.75"-16	1.88"	3.06"	Through Hardened							
		Navistar 129302R1												
		Budd 22622												
		Budd 3203002												
		Trailmobile 387897L												
		Trailmobile 700780												
		Budd 88014												
		Navistar 898376R1												
		Wagner 916105												
		Paccar E7897L												
		Leland W108												
		Leland W617												
		NWRA X1408												
O.E. STANDARD FOR OFF-HIGHWAY APPLICATIONS 	E-7897-R	Meritor 1199F968	1.13"-16	.75"-16	1.88"	3.06"	Through Hardened							
		Navistar 129303R1												
		Budd 22621												
		Trailmobile 700778												
		Budd 88013												
		Navistar 898375R1												
		Leland W107												
		Leland W616												
		NWRA X1407												
		NWRA X2122												
		IMPORT VEHICLES 						E-7898-L	Meritor 1199W1349	1.31"-12	.94"-12	1.88"	3"	Through Hardened. Zinc Yellow Dichromate Plating
									Fruehauf 226604					
									Budd 3204504					
Budd 49415														
Trailmobile 5034B12														
Navistar 698166R1														
Leland W161														
NWRA X1412														
IMPORT VEHICLES 	E-7898-R		Meritor 1199V1348	1.31"-12	.94"-12	1.88"	3"		Through Hardened. Zinc Yellow Dichromate Plating					
			Fruehauf 226605											
			Budd 3204503											
			Budd 49414											
			Trailmobile 5034B11											
		Haldex 67266												
		Navistar 698165R1												
		Leland W160												
		NWRA X1411												
		IMPORT VEHICLES 	E-10253-L					Isuzu 1423360050		M30x1.5	M20x1.5	1.19"	2.44"	Through Hardened. Zinc Yellow Dichromate Plating
								Hino 900424101						
								Leland W721						
								IMPORT VEHICLES 						
Hino 900423101														
Leland W720														

Zinc Clear Chromate plating unless otherwise stated.

INNER CAP NUTS

FOR DUAL MOUNTED ALUMINUM WHEELS

O.E. STANDARD WITH FULL INNER THREADS FOR APPLICATIONS REQUIRING MAXIMUM THREAD ENGAGEMENT



EUCLID NO.	REPLACES	OUTER THREAD SIZE	INNER THREAD SIZE	INNER THREAD MIN. DEPTH	OUTER OVERALL LENGTH	APPLICATION & GENERAL INFORMATION
E-5978-L	Dana/Spicer 511010L	1.13"-16	.75"-16	1.94"	3.06"	Through Hardened
	Dana/Spicer 511011L					
	Fruehauf MWCX01874					
	Leland W161					
	Leland W297					
	Leland W487					
	Leland W767					
NWRA X1874						
E-5978-R	Dana/Spicer 511010R	1.13"-16	.75"-16	1.94"	3.06"	Through Hardened
	Dana/Spicer 511011R					
	HDA 956LB/956RB					
	Fruehauf MWCX01873					
	Leland W160					
	Leland W296					
	Leland W486					
Leland W766						
NWRA X1873						

O.E. STANDARD FOR DUAL ALUMINUM WHEEL APPLICATION



E-5988-L	Webb 105989	1.13"-16	.75"-16	1.94"	3.06"	Through Hardened. Zinc Yellow Dichromate Plating
	Meritor 3280S7871					
	Trailmobile 5034B6					
	Haldex 67267					
	Budd 70612					
	Navistar 753612C1					
	Fruehauf MWCX02139					
Leland W106						
Leland W487						
Leland W625						
NWRA X1802						
NWRA X2139						
E-5988-R	Webb 105988	1.13"-16	.75"-16	1.94"	3.06"	Through Hardened. Zinc Yellow Dichromate Plating
	Trailmobile 36105988					
	Dana/Spicer 511009R					
	Budd 70611					
	HDA 988LB988RB					
	Fruehauf MWCX02138					
	Leland W486					
NWRA X2138						

DISC WHEEL NUTS

CAP NUTS FOR SINGLE & DUAL MOUNTED WHEELS

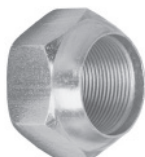



EUCLID NO.	REPLACES	THREAD	HEX	HIGH	APPLICATION & GENERAL INFORMATION
E-10254-L	Isuzu 1423340230	M30 x 1.5	41mm	1"	For use with E-10253-L Metric inner cap nuts.
	Hino 900422104				
	Meritor R0010254L				
	Leland W723				
E-10254-R	Isuzu 1423330230	M30 x 1.5	41mm	1"	For use with E-10253-R Metric inner cap nuts.
	Hino 900421112				
	Meritor R0010254R				
	Leland W722				

Zinc Clear Chromate plating unless otherwise stated.



DISC WHEEL NUTS

CAP NUTS FOR SINGLE & DUAL MOUNTED WHEELS

	EUCLID NO.	REPLACES	THREAD	HEX	HIGH	APPLICATION & GENERAL INFORMATION							
	E-4976-R	Budd 41233 Motor Wheel 81124 Leland W586 Nwra X1146	.56"-18	1"	.69"								
		E-9012-L					Ford C7TZ1121A Leland W585						
		E-9012-R					Ford C7TZ1120A Ford E7TZ1120A Leland W584						
	E-4975-R	Budd 67147 Leland W230 Nwra X1148	.63"-18	1"	.68"								
	E-4979-R	Budd 47147 Leland W588	.63"-18	1.06"	.63"								
		E-5652-L	Meritor 1199G111 Webb 178737 Std. Forge 303107 Budd 3205102 Budd 37889 Trailmobile 5034A2 Haldex 67214 Motor Wheel 84524 Navistar 84712H Ford BB1121 Fruehauf MWCX01804 Leland W16 Nwra X1804	.75"-16	1.50"		.88"	Single Mounting, Front or Rear					
			E-5652-R						Meritor 1199H112 Webb 178736 Std. Forge 303106 Budd 3205101 Budd 37888 Trailmobile 5034A1 Haldex 67213 Motor Wheel 84523 Navistar 84711H HDA 889LB888RB Ford BB1120 Fruehauf MWCX01803 Leland W15 Nwra X1803				
E-5554-L						Navistar 129300R1 Budd 3205302 Haldex 67274 Budd 70614 Fruehauf MWCX01808 Leland W123 Nwra X1808			.75"-16	1.50"	1"	For Single Mounting of Alcoa Forged Aluminum Disc Wheels	
						E-5554-R							Navistar 129301R1 Budd 3205301 Trailmobile 38554R Haldex 67273 Budd 70613 Fruehauf MWCX01807 Leland W122 Nwra X1807

DISC WHEEL NUTS

CAP NUTS FOR SINGLE & DUAL MOUNTED WHEELS

	EUCLID NO.	REPLACES	THREAD	HEX	HIGH	APPLICATION & GENERAL INFORMATION
	E-5995-L	Fruehauf MWC05995L Leland W507	.75"-16	1.50"	1.38"	For Alcoa Wide Base Aluminum Wheels. "Long Grip" Cap Nut. Larger height provides greater lug wrench contact into wheel.
	E-5995-R	Fruehauf MWC05995R Leland W506	.75"-16	1.50"	1.38"	For Alcoa Wide Base Aluminum Wheels. "Long Grip" Cap Nut. Larger height provides greater lug wrench contact into wheel.
	E-5977-L	Meritor 1199M117 Webb 178921 Std. Forge 303105 Budd 3203802 Gunite 34272 Budd 37892 Trailmobile 5034C2 Haldex 67212 Navistar 83156H Motor Wheel 84528 Ford BB1135 Fruehauf MWCX01832 Firestone NTL25 Leland W14 Leland W747 NWRA X1832	1.13"-16	1.50"	.88"	Forged Steel - Thru-Hardened. Zinc Yellow Dichromate Plating. Outer Dual or Large Stud Single Mounting. For Severe Service Application use E-5579-L. For Clear Zinc coating use E-5977LC.
	E-5977-R	Meritor 1199N118 World Truck 133909RC Webb 178910 Std. Forge 303104 Budd 3203801 Trailmobile 385552RC Trailmobile 5034C1 Haldex 67211 Navistar 83155H Motor Wheel 84527 Ford BB1134 Fruehauf MWCX01831 Firestone NTR25 Leland W13 Leland W746 NWRA X1831	1.13"-16	1.50"	.88"	Forged Steel - Thru-Hardened. Zinc Yellow Dichromate Plating. Outer Dual or Large Stud Single Mounting. For Severe Service Application use E-5579-R. For Clear Zinc coating use E-5977RC.
	E-5996-L	Leland W509	1.13"-16	1.50"	1"	For Alcoa Wide Base Aluminum Wheels. "Long Grip" Cap Nut. Larger height provides greater lug wrench contact into wheel.
	E-5996-R	Leland W508	1.13"-16	1.50"	1"	For Alcoa Wide Base Aluminum Wheels. "Long Grip" Cap Nut. Larger height provides greater lug wrench contact into wheel.

DISC WHEEL NUTS

FLANGED CAP NUTS FOR SINGLE & DUAL MOUNTED WHEELS



EUCLID NO.	REPLACES	THREAD	HEX	HIGH	APPLICATION & GENERAL INFORMATION
E-5578-L	Trailmobile 50-34C-10	.75"-16	1.50"	1.09"	Single Mounting Front or Rear. Provides Extra Mounting Strength for Vehicles in Severe Service.
	Budd 71737				
	NWRA X-1419				
E-5578-R	Trailmobile 5034C9	.75"-16	1.50"	1.09"	Single Mounting Front or Rear. Provides Extra Mounting Strength for Vehicles in Severe Service.
	Budd 71736				
	NWRA X1418				
E-5579-L	Meritor 1199Q1811	1.13"-16	1.50"	1.09"	Outer Dual or Large Stud Single Mounting. Provides Extra Mounting Strength for Vehicles in Severe Service.
	Std. Forge 303111				
	Budd 3205202				
	Navistar 425282R1				
	Trailmobile 5034C6				
	Haldex 67269				
	Budd 69913				
Trailmobile 700782					
E-5579-R	Leland W116	1.13"-16	1.50"	1.09"	Outer Dual or Large Stud Single Mounting. Provides Extra Mounting Strength for Vehicles in Severe Service.
	NWRA X1421				
	Meritor 1199R1812				
	Std. Forge 303110				
	Budd 3205201				
	Navistar 425283R1				
	Trailmobile 5034C5				
	Haldex 67268				
	Budd 69912				
	Trailmobile 700781				
Leland W115					
NWRA X1420					

FOR HEAVY-DUTY "OFF-HIGHWAY" SERVICE



EUCLID NO.	REPLACES	THREAD	HEX	HIGH	APPLICATION & GENERAL INFORMATION
E-6060-L	Meritor 1199C1433	1.13"-16	1.75"	1"	Special nut for adapting heavy-duty off highway wheels to standard 1-1/8" thread studs.
	Budd 67012				
	Navistar 974745R1				
	Leland W427				
	NWRA X1363				
E-6060-R	Meritor 1199B1432	1.13"-16	1.75"	1"	Special nut for adapting heavy-duty off highway wheels to standard 1-1/8" thread studs.
	Budd 67011				
	Navistar 974746R1				
	Leland W426				
NWRA X1362					

DISC WHEEL NUTS

FOR HEAVY-DUTY "OFF-HIGHWAY" SERVICE



EUCLID NO.	REPLACES	THREAD	HEX	HIGH	APPLICATION & GENERAL INFORMATION
E-5576-L	Meritor 1199-Y-1351	1.31"-12	1.75"	1.38"	Single or Outer Cap Nuts May Be Used With Accuride "Duplex" Wheels.
	Std. Forge 303109				
	Budd 3204502				
	Budd 49417				
	Trailmobile 5034C14				
	Navistar 698168R1				
	Leland W155				
NWRA X1417					
E-5576-R	Std. Forge 303108	1.31"-12	1.75"	1.38"	Single or Outer Cap Nuts May Be Used With Accuride "Duplex" Wheels.
	Budd 3204501				
	Budd 49416				
	Budd 494167				
	Trailmobile 5034C13				
	Navistar 698167R1				
	Leland W154				
NWRA X1416					



FLANGED CAP NUTS



EUCLID NO.	REPLACES	THREAD	HEX	HIGH	APPLICATION & GENERAL INFORMATION
E-10234	Leland W618	.56"-18	1.06"	1.97"	2 piece flanged nut.
E-5892	World Truck 1338003	.56"-18	.88"	.63"	1 piece flanged nut.
	Trailmobile 385892				
	GMC 3988631				
	Dana/Spicer 511029				
	Dorman 611054				
Leland W458					
E-9022-R	World Truck 1339005R	.63"-18	1.13"	1.06"	Dodge and Navistar. 1 piece flanged nut.
	Chrysler 3637720				
	Navistar 437858C1				
	Budd 95188				
	Meritor R009022R				
	Leland W590				
NWRA X1837					
E-5734	World Truck 1338002	.69"-16	1.13"	1.06"	Use E-5683 stud on rear and E-5682 stud on front. 1 piece flanged nut.
	Trailmobile 21W182				
	Std. Forge 303119				
	GMC 3771410				
	Trailmobile 385734				
	Gunite 45681				
	Dana/Spicer 511030				
	Dorman 611043				
	Budd 81269				
	Gunite K45681				
Firestone NT30					
NWRA X1110					
E-5704	Budd 84608	.75"-16	1.13"	1.06"	1 piece flanged nut.
	Ford C3TZ1120A				
	Leland W183				
	NWRA X1342				

DISC WHEEL NUTS

FLANGED CAP NUTS

	EUCLID NO.	REPLACES	THREAD	HEX	HIGH	APPLICATION & GENERAL INFORMATION
	E-9021	Meritor A1227Z1404 Leland W623	.88"-14	1.31"	.88"	General Motors Bus. 2 piece flanged nut.
	E-10235	GMC 15642921 Webb 179920 Volvo White GMC 947971-8 Volvo 9479718 Ford E6HZ1120B Ford F0HZ1012A Leland W619 NWRA X2081	M20x1.5	30mm	1.06" 27mm	Teflon Coated. 2 piece flanged nut.
	E-5991	Navistar 1610751C1 Webb 179955 Trailmobile 5034C19 Motor Wheel 88881 Fruehauf MWCX02143 Leland W492 NWRA X2143	M22x1.5	1.50"	1.38"	For Motor Wheel WHD-8 (8 Stud) Hub Piloted Wheel System. 2 piece flanged nut.
	E-6000A	Budd 106333 World Truck 1336001 World Truck 1339007 Navistar 1617829C1 Webb 179933 Budd 3208401 Trailmobile 36179933 Trailmobile 386000 Mack 5000471861 Dana/Spicer 511033 Erie 5326RH Trailmobile 7007226 Kenworth K169187 Fruehauf MWCX02156 Gunite W1338 Leland W498 Leland W538 NWRA X2156	M22x1.5	33mm	1.22" 31mm	Teflon Coated For Budd Uni-Mount-10 (10 Stud) Hub Piloted Wheel. 2 piece flanged nut.
	E-9020	World Truck 1339008 Navistar 1649492C1 GMC 2071619 Ford E6HZ1120A Leland W525 NWRA X2159	M22x1.5	33mm	1.03" 26mm	Alcoa Hub Piloted Wheels. 2 piece flanged nut.

CONE LOCK NUTS (2 Piece Flanged Nut)

	EUCLID NO.	REPLACES	THREAD	HEX	HIGH	APPLICATION & GENERAL INFORMATION
	E-5708	Motor Wheel 06605 Motor Wheel 08434 GMC 2019459 Leland W234 NWRA X1164	.75"-16	1.19"	1.12"	Motor Wheel Cone Lock Nut.
	E-5710	Motor Wheel 07652A Meritor 1199B2160 Leland W474 NWRA X1687	.88"-14	1.50"	.94"	Motor Wheel Cone Lock Nut.

DISC WHEEL NUTS

CONE LOCK NUTS (2 Piece Flanged Nut)



EUCLID NO.	REPLACES	THREAD	HEX	HIGH	APPLICATION & GENERAL INFORMATION
E-5711	Motor Wheel 07669	.88"-14	1.50"	1.38"	Motor Wheel Cone Lock Nut.
	Meritor 1199R616				
	Leland W235				
	NWRA X1818				
	NWRA X1870				

WHEEL NUTS

BACK NUTS

GRADE C



EUCLID NO.	REPLACES	THREAD	HEX	HIGH	APPLICATION & GENERAL INFORMATION
E-4961A	Dana/Spicer 341551	.75"-16	1.13"	.63"	Heat Treated Locknut
	Budd 410737				
	Budd 476937				
	Haldex 66888				
	Haldex 67265				
	Webb 75716				
	Motor Wheel 82700				
	Leland L1752				
	Leland L2121				
	Leland L2946				
	Fruehauf MWCX01068				
	Meritor N1121				
	Meritor NL1121				
	Leland SA1162				
	Leland W110				
	Leland W451				
	Leland W99				

GRADE C



E-1835	Mack 21AX480	.88"-14	1.25"	.77"	Heat Treated
	GMC 2236581				
	Freightliner 2309598014				
	Freightliner 230959814				
	Hendrickson 29248				
	Navistar 349510C1				
	Budd 476938				
	Hendrickson 4842				
	Fruehauf FSP00402013				
	Leland L1109				
	Leland L1120				
	Leland SA1288				
Leland SA1336					
Leland SA1534					
Leland W232					

WHEEL NUTS

BACK NUTS

GRADE C



EUCLID NO.	REPLACES	THREAD	HEX	HIGH	APPLICATION & GENERAL INFORMATION
E-1828	Hendrickson 08017000	1"-14	1.50"	.88"	Heat Treated
	GMC 2320989				
	Freightliner 239901216				
	Ford 3538353				
	Navistar 422821R1				
	Budd 446729				
	Volvo 828325				
	Leland L1226				
	Fruehauf MNW93400502D				
	Fruehauf MNW93400502S				
	Leland SA1201				
	Leland SA1286				
	Leland SA1579				
NWRA X1445					

FLAT WHEEL NUTS



EUCLID NO.	REPLACES	THREAD	HEX	HIGH	APPLICATION & GENERAL INFORMATION
E-5032	Trailmobile 22T1704	.50"-20	.75"	.44"	Plain. Grade 5
	Dana/Spicer 54-1641-90				
	Motor Wheel 86897				
	Fruehauf MRM0T1704				
	Fruehauf MRMT1704D				
	Meritor N181				
	Leland W24				
Leland W555					
NWRA X1122					

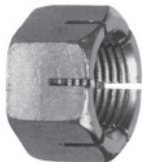

E-5007	GMC 3726212	.50"-20	.88"	.50"	Slotted
	Leland W111				
	NWRA X1124				



E-5008	GMC 373912	.63"-18	.94"	.72"	Plain. Grade 8
	Leland W109				
	NWRA X1429				

SPOKE WHEEL RIM NUTS



EUCLID NO.	GRADE	DAYTON	ERIE	GUNITE	WEBB	NWRA	THREAD	HEX	APPLICATION & GENERAL INFORMATION
E-4962	Grade 5	08-005149	5270	WP2	74611	N-26	.63"-11	1.06"	Flat face 2 sides.
E-4963	Grade 5	08-005716	5260	WP148	74710	N-40	.75"-10	1.25"	Flat face 2 sides.
E-7775	Grade 8	08-005716	5260	WP148	74710	N-40	.75"-10	1.25"	Flat face 2 sides.

WHEEL STUDS

ROUND COLLAR SHOULDER STUDS - Stud Body Diameter .781

GRADE 8

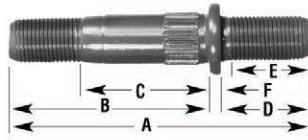

3/4"-16 THDS. BOTH ENDS

EUCLID NO.	REPLACES	A	B	C	D	E	F
E-11722-L	Meritor 09001828	4.34"	3.00"	1.78"	1.25"	1.09"	.09"
E-11722-R	Meritor 09001827						
E-11723-L	Meritor 09002083						
E-11723-R	Meritor 09002082	4.44"	2.89"	1.43"	1.45"	1.25"	.09"

ROUND COLLAR SHOULDER STUDS - Stud Body Diameter .784

GRADE 8

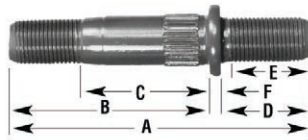

3/4"-16 THDS. BOTH ENDS

EUCLID NO.	REPLACES	A	B	C	D	E	F
E-5713-L	Budd 75932 Leland W206 NWRA X1607 Meritor 20X606	3.41"	2.06"	.88"	1.25"	1.06"	.09"
E-5713-R	Budd 75931 Leland W205 NWRA X1606 Meritor 20X603 Meritor 20X605						
E-5714-L	Haldex 67296 Budd 82582 Leland W208 NWRA X1609 Meritor 20X604 Haldex 67295	3.63"	2.28"	1.06"	1.25"	1.13"	.09"
E-5714-R	Budd 82581 Leland W207 NWRA X1608 Dana/Spicer 50-1067L-90 Budd 63385						
E-5715-L	Budd 63386 Leland W210 NWRA X1613 Dana/Spicer 50-1067R-90 Budd 63385	4.03"	2.50"	1.28"	1.34"	1.16"	.09"
E-5715-R	Leland W209 NWRA X1612 Budd 80697 Budd 80698						
E-5716-L	Fruehauf MWCX01615 Leland W212 NWRA X1615 Budd 80697	4.34"	3.00"	1.94"	1.25"	1.06"	.09"
E-5716-R	Fruehauf MWCX01614 Leland W211 NWRA X1614 Budd 69206						
E-5717-L	Leland W455 NWRA X2108 Budd 69205	4.53"	3.00"	1.94"	1.34"	1.16"	.09"
E-5717-R	Leland W454 NWRA X2107						

WHEEL STUDS

ROUND COLLAR SHOULDER STUDS - Stud Body Diameter .784

GRADE 8

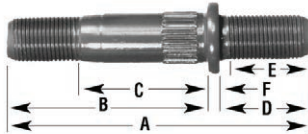

3/4"-16 THDS. BOTH ENDS

EUCLID NO.	REPLACES	A	B	C	D	E	F
E-5589-L	Webb 101301	4.63"	3.28"	2.00"	1.25"	1.13"	.09"
	Meritor 20X601						
	Fruehauf 582885						
	Haldex 67297						
	Haldex 67298						
	Budd 83813						
	Fruehauf ACD7629PK2						
	Fruehauf MWCX01617						
	Paccar SNNK017L						
	Leland W216						
	NWRA X1617						
	Webb 101302						
Meritor 20X602							
Fruehauf 582884							
Haldex 67297							
Budd 83812							
Fruehauf ACD7629PK1							
Fruehauf MWCX01616							
Paccar SNNK017R							
Leland W215							
NWRA X1616							
Budd 101322							
E-8948-L	Paccar SNNK023L	4.91"	3.53"	2.16"	1.25"	.97"	.09"
Leland W519							
Budd 101321							
E-8948-R	Paccar SNNK023R						
	Leland W518						

CLIPPED COLLAR SHOULDER STUDS - Stud Body Diameter .784

GRADE 8

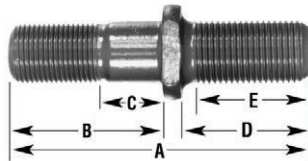

3/4"-16 THDS. BOTH ENDS

EUCLID NO.	REPLACES	A	B	C	D	E
E-5558-L	Budd 12247	3.13"	1.59"	.63"	1.34"	1.16"
	Budd 12248					
	Meritor 20X1041					
	Std. Forge 3011101L					
	Fruehauf 534771					
	Haldex 67225					
	Leland W37					
	NWRA X1555					
	Budd 12247					
	Budd 122478					
	Meritor 20X1040					
	Std. Forge 3011101R					
E-5558-R	Dana/Spicer 5011101R					
	Fruehauf 534770					
	Haldex 67224					
	Leland W36					
	NWRA X1554					

WHEEL STUDS

CLIPPED COLLAR SHOULDER STUDS - Stud Body Diameter .784

2

GRADE 8

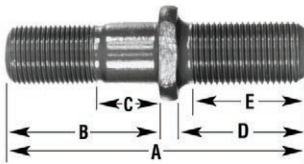

$\frac{3}{4}$ "-16 THDS. BOTH ENDS

EUCLID NO.	REPLACES	A	B	C	D	E
E-5556-L	Budd 13097					
	Meritor 20X55					
	Std. Forge 3011102L					
	Dana/Spicer 50-1003L-90					
	Trailmobile 5033A10					
	Haldex 67227					
	Gunite K25261					
	Fruehauf MXCX01559					
	Leland W39					
	NWRA X1559	3.59"	2.06"	.88"	1.34"	1.16"
Budd 13096						
Budd 130967						
Meritor 20X54						
Std. Forge 3011102R						
Trailmobile 5033A9						
Haldex 67226						
Gunite K25260						
Fruehauf MWCX01558						
Leland W38						
NWRA X1558						
E-5559-L	Budd 13989					
	Meritor 20X37					
	Budd 3025202					
	Dana/Spicer 50-1004L-90					
	Fruehauf 534783					
	Haldex 67228					
	Navistar 698795R1					
	Fruehauf MWCX01563					
	Leland W41					
	NWRA X1563	3.72"	2.19"	1.06"	1.34"	1.16"
Budd 13988						
Meritor 20X38						
Budd 3025201						
Dana/Spicer 50-1004R-90						
E-5559-R	Fruehauf 534782					
	Haldex 67310					
	Navistar 698794R1					
	Fruehauf MWCX01562					
	Leland W40					
NWRA X1562						
E-5561-L	Budd 13991					
	Webb 139913					
	Meritor 20X53					
	Fruehauf 534773	3.97"	2.44"	1.16"	1.34"	1.16"
	Haldex 67230					
	Leland W43					
NWRA X1569						
E-5561-R	Budd 13990					
	Webb 139902					
	Meritor 20X52					
	Fruehauf 534772	3.97"	2.44"	1.16"	1.34"	1.16"
	Haldex 67229					
Leland W42						
NWRA X1568						

WHEEL STUDS

CLIPPED COLLAR SHOULDER STUDS - Stud Body Diameter .784

GRADE 8

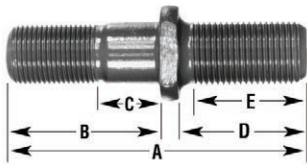

3/4"-16 THDS. BOTH ENDS

EUCLID NO.	REPLACES	A	B	C	D	E
E-5560-L	Budd 19005					
	Meritor 20X85					
	Meritor 20X86					
	Std. Forge 3011105L					
	Fruehauf 509360					
	Haldex 67232					
	Fruehauf MWCX01573					
	Leland W45					
	NWRA X1573	4.03"	2.50"	1.28"		
	Budd 19004					
E-5560-R	Meritor 20X85					
	Meritor 20X86					
	Std. Forge 3011105R					
	Fruehauf 508865					
	Haldex 67231					
	Fruehauf MWCX01572					
	Leland W44					
	NWRA X1572					
	Budd 17124					
	Mack 18AX424					
E-5551-L	Meritor 20X59					
	Navistar 44669H					
	Navistar 48796H					
	Dana/Spicer 50-1008L-90					
	Fruehauf 502786					
	Haldex 67234					
	Leland W47					
	NWRA X1575					
	Budd 17123	4.22"	2.69"	1.44"		
	Mack 18AX423					
E-5551-R	Meritor 20X58					
	Navistar 44668H					
	Navistar 48797H					
	Dana/Spicer 50-1008R-90					
	Fruehauf 502787					
	Haldex 67233					
Leland W46						
NWRA X1574						

WHEEL STUDS

CLIPPED COLLAR SHOULDER STUDS - Stud Body Diameter .784

2

GRADE 8

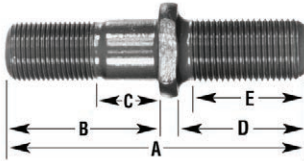

3/4"-16 THDS. BOTH ENDS

EUCLID NO.	REPLACES	A	B	C	D	E
E-5585-L	Meritor 20X71	4.34"	2.81"	1.78"	1.34"	1.16"
	Budd 22006					
	Std. Forge 3011106L					
	Trailmobile 5033A38					
	Haldex 67236					
	Leland W49					
	NWRA X1579					
E-5585-R	Meritor 20X70	4.34"	2.81"	1.78"	1.34"	1.16"
	Budd 22005					
	Std. Forge 3011106R					
	Trailmobile 5033A37					
	Haldex 67235					
E-5553-L	Leland W48	4.53"	3.00"	1.45"	1.34"	1.16"
	NWRA X1578					
	Budd 16272					
	Meritor 20X67					
	Trailmobile 5033A16					
	Fruehauf 535921					
	Navistar 59864H					
	Haldex 67238					
	Fruehauf MWCX01581					
	Leland W51					
E-5553-R	NWRA X1581	4.53"	3.00"	1.45"	1.34"	1.16"
	Budd 16271					
	Meritor 20X66					
	Trailmobile 5033A15					
	Fruehauf 535920					
	Navistar 59863H					
	Haldex 67237					
Fruehauf MWCX01580						
E-10200-L	Leland W50	4.53"	3.00"	1.56"	1.34"	1.16"
	NWRA X1580					
	Conmet 100330					
	Freightliner 119714006					
E-10200-R	Leland W503	4.53"	3.00"	1.56"	1.34"	1.16"
	Conmet 100329					
E-6023-L	Freightliner 119714007	4.84"	3.31"	1.66"	1.34"	1.16"
	Leland W502					
	Conmet 100118					
	Meritor 20X143					
	Budd 21943					
E-6023-R	Leland W580	4.84"	3.31"	1.66"	1.34"	1.16"
	NWRA X1587					
	Conmet 100117					
	Meritor 20X142					
E-6023-R	Leland W579	4.84"	3.31"	1.66"	1.34"	1.16"
	NWRA X1586					
	Conmet 100117					

WHEEL STUDS

CLIPPED COLLAR SHOULDER STUDS - Stud Body Diameter .784

GRADE 8

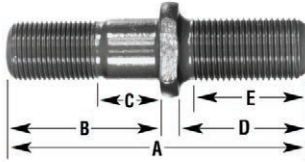

3/4"-16 THDS. BOTH ENDS

EUCLID NO.	REPLACES	A	B	C	D	E
E-5557-L	Budd 16004	5.03"	3.50"	2.47"	1.34"	1.16"
	Mack 18AX990					
	Meritor 20X41					
	Fruehauf 534785					
	Haldex 67240					
	Navistar 698797R1					
	Leland W53					
	NWRA X1589					
	Budd 16003					
	Budd 160034					
E-5557-R	Mack 18AX989	5.25"	3.31"	1.66"	1.75"	1.16"
	Meritor 20X42					
	Fruehauf 534784					
	Haldex 67239					
	Navistar 698796R1					
	Leland W52					
E-6024-L	Conmet 100257	5.25"	3.31"	1.66"	1.75"	1.16"
	Leland W582					
E-6024-R	Conmet 100256	5.25"	3.31"	1.66"	1.75"	1.16"
	Leland W581					

CLIPPED COLLAR SHOULDER STUDS - Stud Body Diameter .784 EXTRA LONG CAP NUT END

GRADE 8

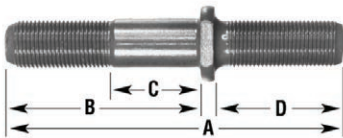

3/4"-16 THDS. BOTH ENDS

EUCLID NO.	REPLACES	A	B	C	D	CAUTION
E-5932-L	Freightliner 1197142	4.25"	2.38"	1.06"	1.63"	Caution: Do not use with Steel wheel. Cap nut will bottom out before tightening against wheel.
	Freightliner 1197143					
	Webb 195694					
	Leland W337					
E-5932-R	NWRA X1577	4.25"	2.38"	1.06"	1.63"	Caution: Do not use with Steel wheel. Cap nut will bottom out before tightening against wheel.
	Freightliner 1197142					
	Freightliner 1197143					
	Webb 195693					
E-5931-L	Leland W336	4.50"	2.38"	1.03"	1.94"	Caution: Do not use with Steel wheel. Cap nut will bottom out before tightening against wheel.
	NWRA X1576					
	Freightliner 11971411					
	Freightliner 11971412					
E-5931-R	Freightliner 11971412	4.50"	2.38"	1.03"	1.94"	Caution: Do not use with Steel wheel. Cap nut will bottom out before tightening against wheel.
	Leland W464					
	NWRA X2054					
	Freightliner 11971411					
E-5989-L	Freightliner 11971412	4.91"	3.38"	1.86"	1.36"	Caution: Do not use with Steel wheel. Cap nut will bottom out before tightening against wheel.
	Leland W463					
	NWRA X2053					
	Conmet 100524					
E-5989-R	Freightliner 1197145	4.91"	3.38"	1.86"	1.36"	Caution: Do not use with Steel wheel. Cap nut will bottom out before tightening against wheel.
	Webb 18301					
	Webb 183101					
	Leland W501					
E-5989-R	Conmet 100525	4.91"	3.38"	1.86"	1.36"	Caution: Do not use with Steel wheel. Cap nut will bottom out before tightening against wheel.
	Freightliner 1197144					
	Webb 183102					
	Leland W500					

WHEEL STUDS

CLIPPED COLLAR SHOULDER STUDS - Stud Body Diameter .784 EXTRA LONG CAP NUT END

GRADE 8

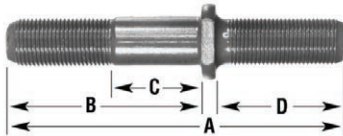

3/4"-16 THDS. BOTH ENDS

EUCLID NO.	REPLACES	A	B	C	D	CAUTION
E-5933-L	Freightliner 1197140	5.13"	2.75"	1.69"	2.25"	Caution: Do not use with Steel wheel. Cap nut will bottom out before tightening against wheel.
	Freightliner 1197141					
	Budd 95692					
	Leland W339					
	NWRA X1583					
E-5933-R	NWRA X1593	5.13"	2.75"	1.69"	2.25"	Caution: Do not use with Steel wheel. Cap nut will bottom out before tightening against wheel.
	Freightliner 1197140					
	Freightliner 1197141					
E-5929-L	Budd 95691	5.19"	3.00"	1.31"	2.00"	Caution: Do not use with Steel wheel. Cap nut will bottom out before tightening against wheel.
	Leland W338					
	NWRA X1592					
E-5929-R	Freightliner 11971415	5.19"	3.00"	1.31"	2.00"	Caution: Do not use with Steel wheel. Cap nut will bottom out before tightening against wheel.
	Freightliner 11971416					
	Leland W460					
E-5930-L	NWRA X2056	5.56"	3.38"	1.75"	2.00"	Caution: Do not use with Steel wheel. Cap nut will bottom out before tightening against wheel.
	Conmet 100524/5					
	Freightliner 11971416					
E-5930-R	Leland W459	5.56"	3.38"	1.75"	2.00"	Caution: Do not use with Steel wheel. Cap nut will bottom out before tightening against wheel.
	NWRA X2055					
	Freightliner 11971413					
E-5930-L	Freightliner 11971414	5.56"	3.38"	1.75"	2.00"	Caution: Do not use with Steel wheel. Cap nut will bottom out before tightening against wheel.
	Leland W462					
	NWRA X2058					
E-5930-R	Conmet 100526	5.56"	3.38"	1.75"	2.00"	Caution: Do not use with Steel wheel. Cap nut will bottom out before tightening against wheel.
	Freightliner 11971414					
	Freightliner 11971415					
E-5930-R	Leland W461	5.56"	3.38"	1.75"	2.00"	Caution: Do not use with Steel wheel. Cap nut will bottom out before tightening against wheel.
	NWRA X2057					

BUS AND HEAVY-DUTY STUDS

CLIPPED COLLAR SHOULDER STUDS - Stud Body Diameter 1.012 For Heavy-Duty "Off Highway" Application

GRADE 8

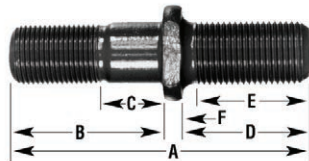

1"-14 THD. HUB END
15/16"-12 THD WHEEL END

EUCLID NO.	REPLACES	A	B	C	D	E	F
E-5876-L	Budd 63342	5.63"	3.50"	1.88"	1.88"	1.56"	.25"
	Meritor R005876L						
	Leland W301						
	NWRA X1637						
E-5876-R	Budd 63341	5.63"	3.50"	1.88"	1.88"	1.56"	.25"
	Meritor R005876R						
	Leland W300						
	NWRA X1636						

BUS AND HEAVY-DUTY STUDS

DOUBLED-ENDED ROUND COLLAR STUDS - Stud Body Diameter .973

GRADE 8

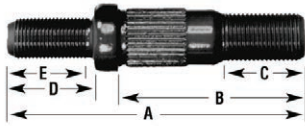

3/4"-16 THD. WHEEL END
7/8"-14 THD. HUB END

GRADE 8

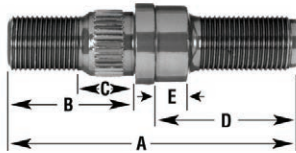

7/8"-14 THD. BOTH ENDS

EUCLID NO.	REPLACES	A	B	C	D	E
E-5920-L	Meritor 20X1227	4.00"	2.09"	1.25"	1.44"	1.19"
	Leland W321					
	NWRA X1942					
E-5920-R	Meritor 20X1228	4.94"	3.09"	1.28"	1.44"	1.19"
	Leland W320					
	NWRA X1941					
E-5918-L	Meritor 20X1233	4.25"	1.88"	.94"	2.06"	.44"
	Leland W317					
	NWRA X1946					
E-5918-R	Meritor 20X1234	5.63"	1.88"	.94"	3.44"	1.25"
	Leland W316					
	NWRA X1945					
E-9006	Meritor 20X2128 Leland W631					
E-9007	Meritor 20X2144 Leland W630					

DOUBLE-ENDED STUDS WITH FLATS - Stud Body Diameter .784 - For Steel Wheels

GRADE 8

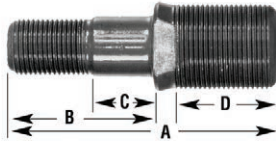

1 1/8"-16 THD. WHEEL END
3/4"-16 THD. HUB END

EUCLID NO.	REPLACES	A	B	C	D
E-3723-L	Meritor 20X90	3.19"	1.59"	.53"	1.41"
	Budd 32310				
	Leland W323				
	Leland W607				
	NWRA X1513				
E-3723-R	Meritor 20X89	4.03"	2.44"	1.22"	1.41"
	Budd 32309				
	Leland W322				
	Leland W606				
	NWRA X1512				
E-3727-L	Budd 45632	4.34"	2.75"	1.81"	1.41"
	Leland W347				
	Budd 45631				
E-3727-R	Leland W346				
	Budd 35090				
E-3728-L	Leland W329	4.34"	2.75"	1.81"	1.41"
	Leland W517				
	NWRA X1525				
	Budd 35089				
E-3728-R	Leland W328				
	Leland W516				
	NWRA X1524				

DOUBLE-ENDED STUDS WITH FLATS - Stud Body Diameter .784 - For Aluminum Wheels

GRADE 8

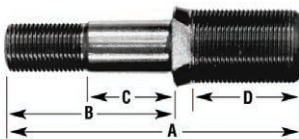

1 1/8"-16 THD. WHEEL END
3/4"-16 THD. HUB END

EUCLID NO.	REPLACES	A	B	C	D
E-5935-L	Budd 95712	3.75"	1.88"	.72"	1.69"
	Leland W343				
	NWRA X1517				
E-5935-R	Budd 95711				
	Leland W342				
	NWRA X1516				

BUS AND HEAVY-DUTY STUDS

DOUBLE-ENDED STUDS WITH FLATS - Stud Body Diameter .784 - For Aluminum Wheels

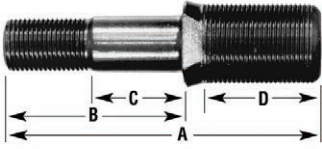
GRADE 8	EUCLID NO.	REPLACES	A	B	C	D
 <p>1 1/8"-16 THD. WHEEL END 3/4"-16 THD. HUB END</p>	E-5936-L	Budd 31704	3.94"	2.06"	.97"	1.69"
		Budd 95708				
		Leland W345				
		NWRA X1521				
	E-5936-R	Budd 31703	4.25"	2.44"	1.22"	1.63"
		Budd 95707				
		Leland W344				
	E-5937-L	NWRA X1523	4.56"	2.75"	1.58"	1.50"
		Budd 90217				
		Leland W346				
E-5937-R	NWRA X1522	5.31"	3.63"	2.09"	1.69"	
	Budd 90218					
E-5990-L	Freightliner 109607001	4.56"	2.75"	1.58"	1.50"	
	Leland W517					
E-5990-R	Freightliner 109607000	4.56"	2.75"	1.58"	1.50"	
	Leland W516					

DOUBLE-ENDED STUDS WITH FLATS - Stud Body Diameter .784

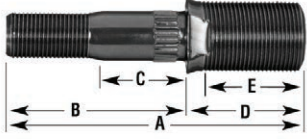
GRADE 8	EUCLID NO.	REPLACES	A	B	C	D	E
 <p>1 1/8"-16 THD. WHEEL END 3/4"-16 THD. HUB END</p>	E-8951-L	Conmet 100343	4.56"	2.75"	1.53"	1.81"	1.25"
		Leland W513					
	E-8951-R	Conmet 100344	4.56"	2.75"	1.53"	1.81"	1.25"
		Leland W512					

DOUBLE-ENDED STUDS WITHOUT FLATS - Stud Body Diameter .973

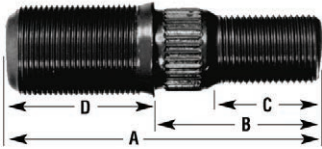
GRADE 8	EUCLID NO.	REPLACES	A	B	C	D
 <p>1 1/8"-16 THD. WHEEL END 7/8"-14 THD. HUB END</p>	E-5922-L	Meritor 20X1241	4.00"	2.00"	1.19"	1.75"
		Meritor 20X1867				
		Navistar 549807C1				
		Leland W315				
	E-5922-R	NWRA X1948	5.31"	3.63"	2.09"	1.69"
		Meritor 20X1242				
		Meritor 20X1868				
		Leland W314				
E-5922-R	NWRA X1947	5.31"	3.63"	2.09"	1.69"	
	Leland W314					

DOUBLE-ENDED STUDS WITHOUT FLATS - Stud Body Diameter 1.220

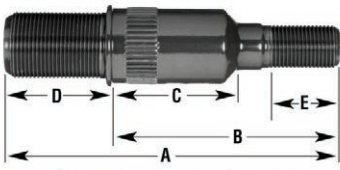
GRADE 8	EUCLID NO.	REPLACES	A	B	C	D	E
 <p>1 1/8"-16 THD. WHEEL END 3/4"-16 THD. HUB END</p>	E-8976-L	Meritor 20X1761	5.31"	3.63"	2.09"	1.69"	1"
		Meritor 20X2233					
		Gunite W1060L					
		Leland W641					
	E-8976-R	Meritor 20X1760	5.31"	3.63"	2.09"	1.69"	1"
		Meritor 20X2234					
		Gunite W1060R					
		Leland W640					

WHEEL STUDS

WEDGE HEAD TYPE STUDS - Stud Body Diameter .788

GRADE 8

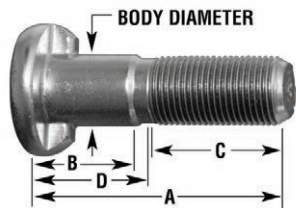

3/4"-16 THD.

EUCLID NO.	REPLACES	A	B	C	D
E-9005-L	Meritor 20X2089	2.63"	1.00"	1.25"	1.25"
	Leland W613				
E-9005-R	Meritor 20X2088	3.11"	1.41"	1.36"	1.75"
	Leland W612				
E-9004-L	Meritor 20X1979	3.11"	1.41"	1.36"	1.75"
	Leland W667				
E-9004-R	Meritor 20X1980	3.11"	1.41"	1.36"	1.75"
	Leland W666				

WEDGE HEAD TYPE STUDS - Stud Body Diameter .792 - For Aluminum Hubs

GRADE 8

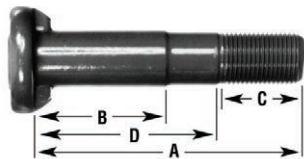

3/4"-16 THD.

EUCLID NO.	REPLACES	A	B	C	D
E-5924-L	Meritor 20X1334	3.41"	1.44"	1.63"	2.25"
	Meritor 20X1463				
	Meritor 20X1978				
	Mack 823520X1463				
	Leland W265				
	NWRA X1914				
E-5924-R	Meritor 20X1335	3.55"	1.81"	1.06"	2.48"
	Meritor 20X1464				
	Meritor 20X1977				
	Mack 823520X1464				
	Leland W264				
	NWRA X1913				
E-5916-L	Meritor 20X1311	3.75"	1.50"	1.75"	1.75"
	Meritor 20X1459				
	Leland W263				
	NWRA X1916				
E-5916-R	Meritor 20X1312	3.80"	1.81"	1.13"	2.63"
	Meritor 20X1460				
	Dana/Spicer 50-1251R-90				
	Leland W262				
E-9002-L	Meritor 20X1471	3.97"	1.31"	2.00"	1.75"
	Meritor 20X1472				
	Meritor 20X1309				
	Meritor 20X1457				
E-5923-L	Navistar 469025C1	3.97"	1.31"	2.00"	1.75"
	Leland W261				
	NWRA X1918				
	Meritor 20X1310				
E-5923-R	Meritor 20X1458	3.97"	1.31"	2.00"	1.75"
	Navistar 469026C1				
	Leland W260				
	NWRA X1917				
E-9000-L	Meritor 20X1307	3.97"	1.31"	2.00"	1.75"
	Navistar 549809C1				
	Leland W639				
	NWRA X2044				
E-9000-R	Meritor 20X1308	3.97"	1.31"	2.00"	1.75"
	Navistar 549810C1				
	Leland W638				
	NWRA X2043				

WHEEL STUDS

FRONT WHEEL STUDS - Stud Body Diameter 1.216

2

GRADE 8

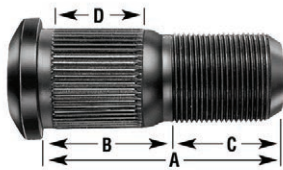

1 1/8"-16 THD.

EUCLID NO.	REPLACES	A	B	C	D
E-5897-L	Meritor 20X1563	2.63"	.88"	1.75"	.44"
	Meritor 20X1564				
	Meritor 20X378				
	Budd 83819				
	Navistar 894786R1				
	Paccar SWAX005L				
	Leland W293				
	NWRA X1724				
E-5897-R	Meritor 20X1563	2.63"	.88"	1.75"	.44"
	Meritor 20X1564				
	Meritor 20X377				
	Budd 83818				
	Navistar 894787R1				
	Paccar SWAX005R				
	Leland W292				
	NWRA X1723				
E-5986-L	Webb 188109	2.95"	1.75"	1.95"	.56"
	Navistar 472008R1				
	Motor Wheel 89086				
	Leland W521				
	NWRA X1984				
	NWRA X1983				
E-5986-R	Webb 188108	2.95"	1.75"	1.95"	.56"
	Navistar 472007R1				
	Motor Wheel 89085				
	Leland W520				
	NWRA X1983				
	NWRA X1983				
E-11697-L	Meritor 09001926	2.97"	1.19"	1.78"	.45"
E-11697-R	Meritor 09001925				
E-11699-L	Meritor 09002000	3.13"	1.19"	2.06"	.45"
E-11699-R	Meritor 09001999				
E-11695-L	Meritor 09001218	3.19"	1.31"	1.59"	.75"
Paccar SWAX039L					
Paccar SWAX039R					
E-5898-L	Meritor 20X589	3.19"	1.38"	1.81"	1.00"
	Navistar 438061R1				
	Navistar 581674C1				
	Gunite W1148L				
	Leland W295				
	NWRA X1932				
	NWRA X1931				
	NWRA X1931				
E-8996-L	Motor Wheel 88292	3.25"	.75"	2.25"	.63"
	Leland W365				
	NWRA X1992				
	NWRA X1991				
E-8996-R	Motor Wheel 88291	3.25"	.75"	2.25"	.63"
	Leland W364				
	NWRA X1991				
	NWRA X1991				
E-11696-L	Meritor 09001669	3.41"	1.31"	1.81"	.50"
E-11696-R	Meritor 09001668				

WHEEL STUDS

FRONT WHEEL STUDS - Stud Body Diameter 1.216

EUCLID NO.	REPLACES	A	B	C	D
E-9001-L	Meritor 20X1357	3.47"	.88"	1.45"	.44"
	Meritor 20X1477				
	Meritor 20X1478				
	Dana/Spicer 501093L				
	Dana/Spicer 501093R				
	Leland W331				
	NWRA X2038				
E-9001-R	Meritor 20X1356	3.50"	1.19"	2.03"	.75"
	Meritor 20X1477				
	Meritor 20X1478				
	Dana/Spicer 501093L				
	Dana/Spicer 501093R				
	Leland W330				
	NWRA X2037				
E-8972-L	GMC 15552787	3.50"	1.19"	2.03"	.75"
	Navistar 292963C1				
	Navistar 593096C1				
	Ford E4HZ1108E				
	Ford E8HZ1107B				
	Gunite W1118L				
	Leland W511				
	Gunite W720L				
	Gunite W788L				
	Gunite W988L				
	GMC 15552788				
	Navistar 292964C1				
	Navistar 593097C1				
E-8972-R	Ford E4HZ1107E	3.56"	1.44"	1.75"	1.00"
	Ford E8HZ1107A				
	Gunite W1118R				
	Leland W510				
	Gunite W720R				
	Gunite W788R				
	Gunite W988R				
E-8995-L	Motor Wheel 87143	3.63"	1.75"	1.88"	.50"
	Leland W363				
	NWRA X1767				
E-8995-R	Motor Wheel 87142	3.63"	1.75"	1.88"	.50"
	Leland W362				
E-6033-L	NWRA X1766	3.63"	1.75"	1.88"	.50"
	Budd 100018				
	Webb 100181				
	Eaton 100858006				
E-6033-R	Leland W725	3.63"	1.75"	1.88"	.50"
	Budd 100017				
	Webb 100170				
	Eaton 100858010				
	Leland W724				

GRADE 8

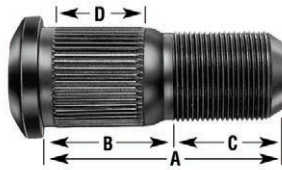

1 1/8"-16 THD.

WHEEL STUDS

FRONT WHEEL STUDS - Stud Body Diameter 1.220

EUCLID NO.	REPLACES	A	B	C	D
E-5748-L	Navistar 110001R1	2.41"	.88"	1.22"	.38"
	Meritor 20X369				
	Budd 82574				
	Leland W240				
	NWRA X1719				
E-5748-R	Navistar 110002R1	2.41"	.88"	1.22"	.38"
	Meritor 20X370				
	Budd 82573				
	Leland W241				
	NWRA X1718				
E-5749-L	Meritor 20X371	2.81"	.88"	1.22"	.44"
	Meritor 20X379				
	Navistar 224957R1				
	Haldex 67306				
	Budd 82576				
	Paccar PAC5L				
	Leland W242				
	NWRA X1726				
	Meritor 20X372				
	Meritor 20X380				
E-5749-R	Navistar 224958R1	2.81"	.88"	1.22"	.44"
	Dana/Spicer 50-1081R-90				
	Haldex 67305				
	Budd 82575				
	Paccar PAC5R				
	Leland W243				
	NWRA X1725				
	Meritor 20X585				
	Navistar 447556R1				
	Haldex 67308				
E-5750-L	Budd 83854	3.00"	1.38"	1.63"	1.00"
	Leland W245				
	NWRA X1728				
	Meritor 20X584				
	Navistar 447557R1				
E-5750-R	Haldex 67307	3.00"	1.38"	1.63"	1.00"
	Budd 82853				
	Leland W244				
	NWRA X1727				
	Meritor 20X747				
E-5899-L	Paccar SWAX035L	3.13"	1.59"	1.53"	.38"
	Leland W291				
	NWRA X1928				
	Meritor 20X746				
E-5899-R	Navistar 753613C1	3.13"	1.59"	1.53"	.38"
	Paccar SWAX035R				
	Leland W290				
	NWRA X1927				

GRADE 8

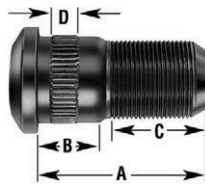

1 1/8"-16 THD.

WHEEL STUDS

FRONT WHEEL STUDS - Stud Body Diameter 1.220

EUCLID NO.	REPLACES	A	B	C	D
E-8966-L	GMC 15543998				
	Mack 18AX1159				
	GMC 2075453				
	Meritor 20X1755				
	Ford D5HZ1108A				
	Gunite W1104L				
	Leland W713				
	Gunite W826L				
	Gunite W890L				
	Gunite W932L				
		3.56"	1.56"	1.72"	.50"
E-8966-R	GMC 15514399				
	Mack 18AX1158				
	GMC 2075454				
	Meritor 20X1754				
	Ford D5HZ1107A				
	Gunite W1104R				
	Leland W712				
	Gunite W826R				
	Gunite W890R				
	Gunite W932R				
E-5868-L	Webb 133609				
	Navistar 469610C1				
	Navistar 469610C7				
	Navistar 773434C1				
	Budd 85382				
	Budd 99617				
	Eaton F18479				
	Leland W289				
	NWRA X1732				
	Webb 133610				
		3.63"	1.81"	1.81"	.75"
E-5868-R	Navistar 469609C1				
	Navistar 469609C7				
	Navistar 773433C1				
	Budd 85381				
	Budd 99616				
	Eaton F184710				
	Leland W288				
	NWRA X1731				
	Gunite W1203L				
	Leland W711				
		3.81"	1.19"	2.50"	.75"
E-8985-R	Gunite W1203R				
	Leland W710				
E-8990-L	Kenworth K233C372L				
	Leland W551				
	NWRA X2172				
	Kenworth K233C372L				
		4.00"	1.31"	1.81"	.75"
E-8990-R	Leland W550				
	NWRA X2171				

GRADE 8

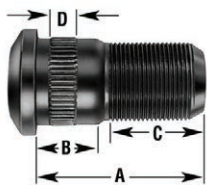

1 1/8"-16 THD.

WHEEL STUDS

FRONT WHEEL STUDS - Stud Body Diameter 1.220 - For Aluminum Disc Wheels

EUCLID NO.	REPLACES	A	B	C	D	E
E-10224-L	Meritor 20X469	2.91"	1.38"	1.22"	.25"	1.00"
	Meritor 20X583					
	Leland W313					
	Leland W357					
	NWRA X2034					
E-10224-R	Meritor 20X460	2.91"	1.38"	1.22"	.25"	1.00"
	Meritor 20X582					
	Leland W356					
E-5982-L	NWRA X2033	3.75"	1.22"	2.25"	.13"	.56"
	Peterbilt 0200771					
	Kenworth K233B359L					
E-5982-R	Leland W478	3.75"	1.22"	2.25"	.13"	.56"
	NWRA X2134					
	Peterbilt 0200772					
E-10249-L	Kenworth K233B359R	3.75"	1.38"	2.50"	.63"	.50"
	Leland W477					
	NWRA X2133					
E-10249-R	Meritor 20X1475	3.75"	1.38"	2.50"	.63"	.50"
	Leland W333					
	NWRA X2112					
E-5985-L	Meritor 20X1476	3.78"	1.38"	1.44"	.22"	1.00"
	Leland W332					
	NWRA X2111					
E-5985-R	Meritor 20X587	3.78"	1.38"	1.44"	.22"	1.00"
	Leland W359					
	NWRA X2114					
E-5985-R	Meritor 20X586	3.78"	1.38"	1.44"	.22"	1.00"
	Leland W358					
	NWRA X2113					

GRADE 8

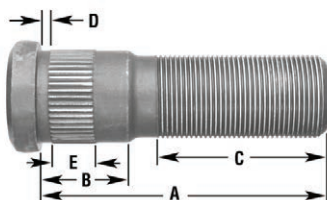

1 1/8"-16 THD.

FRONT WHEEL STUDS - Stud Body Diameter 1.220 - For Aluminum Disc Wheels

EUCLID NO.	REPLACES	A	B	C
E-10227-L	Conmet 103189	3.09"	1.16"	1.47"
E-10227-R	Conmet 103190			
E-10226-L	Conmet 102084	3.41"	1.53"	1.47"
E-10226-R	Conmet 102085			
E-10228-L	Conmet 103191	3.56"	1.16"	1.94"
	Paccar SWAZ004L			
E-10228-R	Conmet 103192			
	Paccar SWAZ004R			
E-10225-L	Conmet 101873	3.88"	1.53"	1.91"
	Leland W663			
E-10225-R	Conmet 101874			
	Leland W662			

GRADE 8

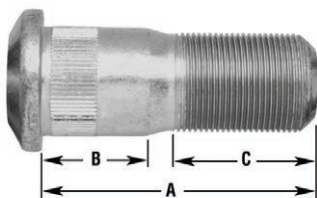

1 1/8"-16 THD.

SERRATED WHEEL STUDS - Stud Body Diameter .630

EUCLID NO.	REPLACES	A	B	C
E-10229	GMC 2202033	2.94"	.75"	1.25"
	GMC 3694508			
	Gunite K34460			
	Leland W79			
E-10230	GMC 3697043	3.19"	1"	1.50"
	Gunite K43939			
	Leland W81			

GRADE 8

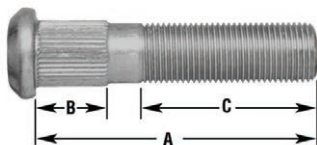

5/8"-18 THD.

WHEEL STUDS

SERRATED WHEEL STUDS - Stud Body Diameter .784

EUCLID NO.	REPLACES	A	B	C	D
E-10202-L	GMC 15514381	2.50"	.75"	1.50"	.50"
	Gunite W1091L				
	Leland W653				
E-10202-R	GMC 15514382	2.50"	.75"	1.50"	.50"
	Gunite W1091R				
	Leland W652				
E-8983-L	Gunite W1170L	2.69"	.97"	1.41"	.50"
Leland W681					
E-8983-R	Gunite W1170R	2.69"	.97"	1.41"	.50"
Leland W680					
E-8969-L	GMC 12386617	2.94"	1.31"	1.41"	.50"
	GMC 15580833				
	Gunite W112				
E-8969-R	Leland W609	2.94"	1.31"	1.41"	.50"
	Gunite W981L				
	GMC 15580830				
E-10206-L	Gunite W1121R	3.00"	1.66"	1.25"	.50"
	Leland W608				
	Gunite W981R				
E-10206-R	Navistar 1659065C1	3.00"	1.66"	1.25"	.50"
	Gunite W1064L				
	Leland W649				
E-8982-L	Navistar 1659066C1	3.13"	1.34"	1.59"	.50"
	Gunite W1064R				
	Leland W648				
E-8982-R	World Truck 1681008L	3.13"	1.34"	1.59"	.50"
	Gunite W1166L				
	Leland W665				
E-10209-L	World Truck 1681008R	3.16"	1.44"	1.50"	.50"
	Gunite W1166R				
	Leland W664				
E-10209-R	Conmet 102277	3.16"	1.44"	1.50"	.50"
	Motor Wheel 91156				
	Leland W729				
E-8968-L	Conmet 102278	3.19"	.97"	1.63"	.50"
	Motor Wheel 91155				
	Leland W728				
E-8968-R	World Truck 1681009L	3.19"	.97"	1.63"	.50"
	Leland W675				
	Gunite W980L				
E-10201-L	World Truck 1681009R	3.25"	1.75"	1.38"	.50"
	Leland W674				
	Gunite W980R				
E-10201-R	GMC 2095341	3.25"	1.75"	1.38"	.50"
	Navistar 584071C1				
	Gunite W1006L				
E-10201-R	GMC 2095342	3.25"	1.75"	1.38"	.50"
	Navistar 584072C1				
	Gunite W1006R				

GRADE 8

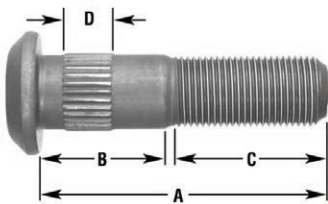

3/4"-16 THD.

WHEEL STUDS

SERRATED WHEEL STUDS - Stud Body Diameter .784

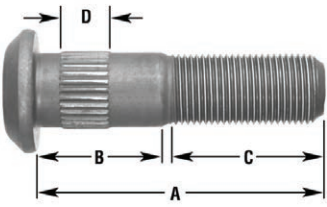
		EUCLID NO.	REPLACES	A	B	C	D
GRADE 8  3/4"-16 THD.	E-8979-L		Navistar 597991C1				
			Gunite W1133L				
			Leland W611				
			Gunite W992L	3.34"	1.28"	1.84"	.50"
			Navistar 597992C1				
		E-8979-R		Gunite W1133R			
			Leland W610				
			Gunite W992R				
		E-10208-L		Conmet 102279			
			Leland W707	3.41"	1.44"	1.63"	.50"
	E-10208-R		Conmet 102280				
		Leland W706					
	E-10210-L		Conmet 102281				
		Paccar SNAJ002L					
		Leland W731	3.78"	1.44"	2.00"	.50"	
	E-10210-R		Conmet 102282				
		Paccar SNAJ002R					
			Leland W730				

SERRATED WHEEL STUDS - Stud Body Diameter .974

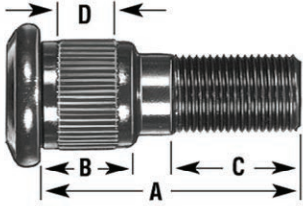
		EUCLID NO.	REPLACES	A	B	C	D
GRADE 8  3/4"-16 THD.	E-5718-L		Meritor 20X209				
			Navistar 212254R1				
			Budd 636262				
			Haldex 67292				
			Ford 7EQ1119				
			Leland W169				
			NWRA X1834	2.38"	.75"	1.16"	.50"
			Meritor 20X208				
			Navistar 212255R1				
		E-5718-R		Budd 636252			
			Haldex 67291				
			Ford 7EQ1118				
			Leland W168				
			NWRA X1833				
		E-5719-L		Meritor 20X211			
	Fruehauf 298484						
	Budd 636263						
	Leland W171						
	NWRA X1392		2.56"	.75"	1.38"	.50"	
		Meritor 20X210					
		Fruehauf 298485					
	E-5719-R		Budd 636253				
		Leland W170					
		NWRA X1391					

WHEEL STUDS

SERRATED WHEEL STUDS - Stud Body Diameter .974

EUCLID NO.	REPLACES	A	B	C	D
E-5900-L	Meritor 20X831				
	Leland W400				
	NWRA X1906				
	World Truck 1541405R	2.72"	.75"	1.59"	.50"
E-5900-R	Meritor 20X832				
	Leland W399				
	NWRA X1905				
E-5720-L	Meritor 20X207				
	Navistar 277773C1				
	Budd 636261				
	Budd 63626E1				
	Haldex 67290				
	Navistar 89764R1				
	Leland W167				
	NWRA X1394	2.75"	.75"	1.47"	.50"
E-5720-R	Meritor 20X206				
	Navistar 277774C1				
	Budd 636251				
	Budd 63625E1				
	Haldex 67289				
	Navistar 89765R1				
	Leland W166				
	NWRA X1393				
E-5987-L	GMC 717005				
	Motor Wheel 86798				
	Leland W381				
	NWRA X1763	2.91"	1.19"	1.25"	1.00"
E-5987-R	GMC 717004				
	Motor Wheel 86797				
	Leland W380				
E-5871-L	NWRA X1762				
	Meritor 20X481				
	Navistar 791042C1				
	Paccar K233344L				
	Paccar PAC4L				
	Paccar SNAV019L				
	Leland W275				
NWRA X1862	3.09"	1.38"	1.25"	1.00"	
E-5871-R	World Truck 1541404R				
	Meritor 20X482				
	Navistar 791043C1				
	Paccar K233344R				
	Paccar PAC3R				
E-6057-L	Paccar SNAV019R				
	Leland W274				
	NWRA X1861				
E-6057-R	Motor Wheel 90802				
	Leland W549	3.19"	1.19"	1.16"	1.00"
E-6057-R	Motor Wheel 90801				
	Leland W548				

GRADE 8

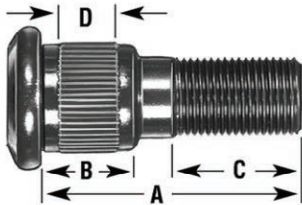

3/4"-16 THD.

WHEEL STUDS

SERRATED WHEEL STUDS - Stud Body Diameter .974

GRADE 8

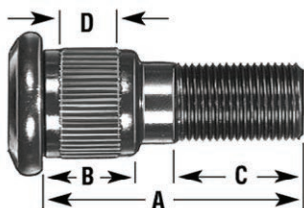

3/4"-16 THD.

EUCLID NO.	REPLACES	A	B	C	D
E-5896-L	Kenworth K233287L Leland W277 NWRA X1936	3.38"	1.31"	1.25"	1.00"
E-5896-R	Kenworth K233287R Leland W276 NWRA X1935				

SERRATED WHEEL STUDS - Stud Body Diameter .745

GRADE 8

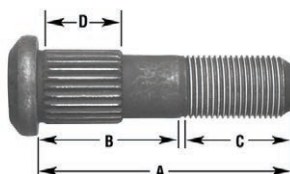

3/4"-16 THD.

EUCLID NO.	REPLACES	A	B	C	D
E-8994-L	Motor Wheel 82018 NWRA X1746	2.50"	1.16"	1.25"	.91"
E-8994-R	Motor Wheel 82017 NWRA X1745				
E-8992-L	Motor Wheel 82096 Leland W392 NWRA X1752	2.97"	1.59"	1.19"	.94"
E-8992-R	Motor Wheel 82095 Leland W391 NWRA X1751				
E-8993-L	GMC 02210240 Motor Wheel 82843 Leland W394 NWRA X1754 GMC 02210239	3.25"	1.88"	1.16"	1.13"
E-8993-R	Motor Wheel 82842 Leland W393 NWRA X1753				

DRIVE AXLE STUD - Stud Body Diameter .975 - For Aluminum Disc Wheels

GRADE 8

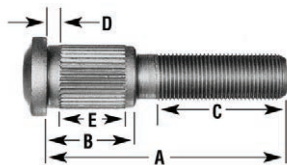

3/4"-16 THD.

EUCLID NO.	REPLACES	A	B	C	D	E
E-5983-L	Peterbilt 0302853 Leland W475 NWRA X2132	3.75"	1.38"	2.25"	.25"	1.00"
E-5983-R	Peterbilt 0302852 Leland W476 NWRA X2131					

WHEEL STUDS

SERRATED WHEEL STUDS

GRADE 8

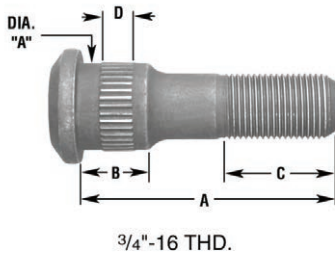

EUCLID NO.	REPLACES	BODY DIA.				
		"A"	A	B	C	D
E-8958-L	Leland W637	.772	2.88"	1.50"	1.19"	.50"
E-8958-R	Leland W636					
E-8955-L	Navistar 576711C1	.778	3.38"	1.28"	1.94"	.50"
	Leland W646					
E-8955-R	Leland W647					
E-8955-L	Navistar 576712C1					
E-8957-L	Ford E4HZ1108B	.778	3.50"	1.78"	1.28"	.50"
E-8957-R	Ford E4HZ1107B					
E-8954-L	Fruehauf MDS001327	.778	3.84"	2.34"	1.28"	.50"
	Leland W629					
E-8954-R	Fruehauf MDS001326					
E-8954-L	Leland W628					
E-11680-L	Meritor 09869702	.780	2.38"	1.00"	1.06"	.50"
E-11680-R	Meritor 09869701					
E-11680-L	Navistar 1647126C1					
E-11673-L	Meritor 09001966	.780	2.66"	.88"	1.34"	.50"
E-11673-R	Meritor 09001965					
E-11664-L	Meritor 09001540	.780	3.12"	1.66"	1.31"	.50"
E-11664-R	Meritor 09001539					
E-11667-L	Meritor 09001651	.782	2.75"	1.37"	1.21"	.50"
E-11667-R	Meritor 09001650					
E-11668-L	Meritor 09001653	.782	2.88"	1.00"	1.75"	.50"
E-11668-R	Meritor 09001652					
E-11666-L	Meritor 09001615	.782	2.94"	1.06"	1.75"	.50"
E-11666-R	Meritor 09001614					
E-9011-L	Webb 159191	.784	2.38"	.88"	1.06"	.50"
E-9011-R	Webb 159190					
E-8978-L	Meritor 20X1746	.784	3.41"	1.91"	1.22"	.50"
	Gunite W1073L					
E-8978-R	Leland W645					
	Meritor 20X1747					
E-8978-L	Gunite W1073R					
E-8978-R	Leland W644					
E-8977-L	Leland W635	.784	3.88"	2.06"	1.69"	.50"
E-8977-R	Leland W634					
E-11658-L	Meritor 09001255	.790	2.56"	1.08"	1.25"	.50"
E-11658-R	Meritor 09001254					
E-11660-L	Meritor 09002048	.890	2.12"	.69"	1.25"	.50"
E-11660-R	Meritor 09002047					
E-11681-L	Meritor 09002211	.890	2.42"	1.00"	1.24"	.50"
E-11681-R	Meritor 09002210					
E-11682-L	Meritor 09002205	.890	2.69"	1.12"	1.38"	.38"
E-11682-R	Meritor 09002204					
E-5911-L	Meritor 20X403	.974	2.56"	.94"	1.25"	.44"
	Leland W398					
E-5911-R	NWRA X1885					
	Meritor 20X402					
E-5911-L	Leland W397					
E-5911-R	NWRA X1884					

WHEEL STUDS

SERRATED WHEEL STUDS

EUCLID NO.	REPLACES	BODY DIA.				
		"A"	A	B	C	D
E-5721-L	Meritor 20X405					
	Navistar 443660C1					
	Budd 82579					
	Navistar 98726R1					
	Leland W271					
	NWRA X1844	.974	2.81"	1.19"	1.19"	.38"
E-5721-R	Meritor 20X404					
	Navistar 443661C1					
	Budd 82579					
	Navistar 98727R1					
E-9010-L	Leland W270					
	NWRA X1843					
	Webb 101173					
E-9010-R	Leland W701					
	Webb 101172	.974	2.84"	.81"	1.13"	.50"
E-5910-L	Leland W700					
	Meritor 20X345					
	Leland W396					
E-5910-R	NWRA X1889	.974	3.13"	.81"	1.31"	.44"
	Meritor 20X344					
	Leland W395					
E-9524-L	NWRA X1888					
	Webb 101175					
E-9524-R	Leland W735	.974	3.19"	.78"	1.59"	.50"
	Webb 101174					
E-9525-L	Leland W734					
	Webb 101179					
	Leland W737					
E-9525-R	Webb 101178	.974	3.34"	.78"	.78"	.50"
	Leland W736					
E-5909-L	Meritor 20X853					
	Navistar 351138C1					
	Leland W379					
	NWRA X1894	.974	3.34"	1.84"	1.06"	.50"
E-5909-R	Meritor 20X852					
	Navistar 351139C1					
	Leland W378					
E-5722-L	NWRA X1893					
	Meritor 20X478					
	Budd 83852					
	Leland W371					
E-5722-R	NWRA X1379	.974	4.00"	2.44"	1.19"	1.63"
	Meritor 20X477					
	Budd 83851					
E-5722-R	Leland W370					
	NWRA X1378					

GRADE 8

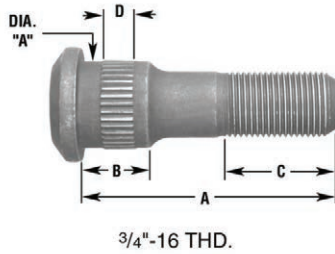

3/4"-16 THD.

WHEEL STUDS

SERRATED WHEEL STUDS

GRADE 8

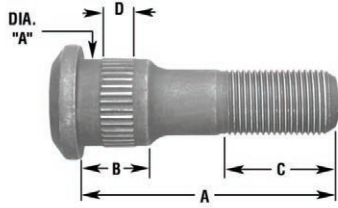

3/4"-16 THD.

EUCLID NO.

REPLACES

BODY DIA.

"A"

A

B

C

D

Webb 101171
Leland W733

E-9523-L

.974" 2.60" .81" 1.12" .25"

E-9523-R

Webb 101170
Leland W732

GRADE 8

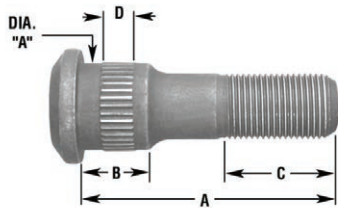

3/4"-16 THD.

Meritor 09001764

E-11669-L

.975 3.84" 1.21" 1.32" .56"

E-11669-R

Meritor 09001763

SERRATED WHEEL STUDS - Stud Body Diameter .784

GRADE 8

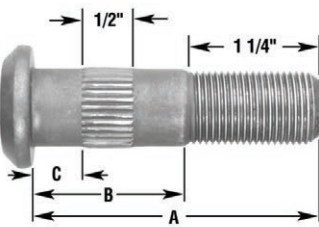

3/4"-16 THD.

EUCLID NO.

REPLACES

A

B

C

NOTES

E-4964-L

Budd 59365
Leland W63
NWRA X1859
World Truck 1541701R
Budd 59364

2.13" .75" .25"

Used on TK, TKL, RL, TL (also Eaton). With some cast drums on TK, TKL, use E-4968-R/L. Used on RN, RQ, TKN.

E-4964-R

Budd 593645
Leland W62
NWRA X1858

E-4965-L

Meritor 20X1805
Meritor 20X593
Meritor 20X687
Budd 59192
Haldex 67242
Gunite K36708
Leland W65
NWRA X1081
Meritor 20X1806
Meritor 20X592
Meritor 20X688

2.38" 1" .25"

Used on TK, TKL, RL, TL (also Eaton). With some cast drums on TK, TKL, use E-4968-R/L. Used on RN, RQ, TKN.

E-4965-R

Budd 59191
Haldex 67241
Gunite K36707
Leland W64
NWRA X1080

WHEEL STUDS

SERRATED WHEEL STUDS - Stud Body Diameter .784

2

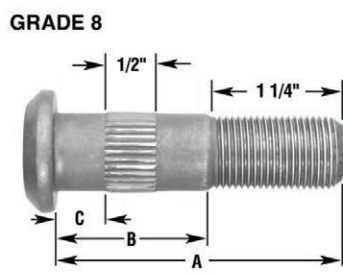
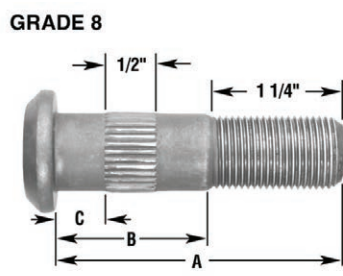
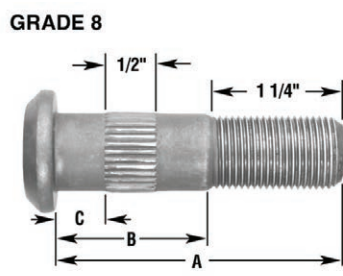
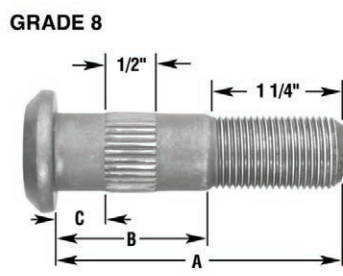
	EUCLID NO.	REPLACES	A	B	C	NOTES		
 <p style="text-align: center;">GRADE 8</p> <p style="text-align: center;">3/4"-16 THD.</p>	E-4966-L	Dayton-Walther 09853602						
		Navistar 184197R1						
		Meritor 20X431						
		Trailmobile 5033A30						
		Budd 59264						
		Haldex 67244						
		Navistar 983878R1						
		Fruehauf MWCX01713						
		Leland W67						
		NWRA X1713						
		Dayton-Walther 09853601	2.63"	1.25"	.31"			
		Navistar 184198R1						
		Meritor 20X430						
		Trailmobile 5033A29						
 <p style="text-align: center;">GRADE 8</p> <p style="text-align: center;">3/4"-16 THD.</p>	E-4966-R	Budd 59263						
		Haldex 67243						
		Navistar 793879R1						
		Fruehauf MWCX01712						
		Leland W66						
		NWRA X1712						
		Meritor 20X1575						
		Meritor 20X1811						
		GMC 3723967						
		 <p style="text-align: center;">GRADE 8</p> <p style="text-align: center;">3/4"-16 THD.</p>	E-4967-L	Budd 61969				
				Haldex 67246				
				Leland W69				
				NWRA X1824				
				Meritor 20X1576	2.88"	1.50"	.25"	
Meritor 20X1812								
 <p style="text-align: center;">GRADE 8</p> <p style="text-align: center;">3/4"-16 THD.</p>	E-4967-R	GMC 3723968						
		Budd 61968						
		Haldex 67245						
		Leland W68						
		NWRA X1823						

WHEEL STUDS

SERRATED WHEEL STUDS - Stud Body Diameter .784

EUCLID NO.	REPLACES	A	B	C	NOTES	
E-4968-L	Webb 198521					
	Meritor 20X1571					
	Meritor 20X997					
	Budd 49852					
	Trailmobile 5033A26					
	Volvo 6043826					
	Haldex 67248					
	Fruehauf MWCX01385					
	Leland W699					
	Leland W71					
	NWRA X1385					
	NWRA X2042					
	Webb 198510		2.88"	1.50"	.50"	Used on TK, TKL, RL, TL (also Eaton). With some cast drums on TK, TKL, use E-4968-R/L. Used on RN, RQ, TKN.
Meritor 20X1572						
Meritor 20X1816						
Meritor 20X996						
Budd 49851						
E-4968-R	Trailmobile 5033A25					
	Volvo 6043825					
	Haldex 67247					
	Fruehauf MWCX01384					
	Leland W698					
	Leland W70					
	NWRA X1384					
E-4969-L	Meritor 20X1469					
	Budd 59184					
	Haldex 67249					
	Haldex 67250					
	Trailmobile 700779					
	Fruehauf MWCX01387					
	Leland W73					
	NWRA X1387					
	Meritor 20X1470		3.13"	1.75"	.56"	Used on TK, TKL, RL, TL (also Eaton). With some cast drums on TK, TKL, use E
	Budd 59183					Used on TK, TKL, RL, TL (also Eaton). With some cast drums on TK, TKL, use E
Haldex 67249						
Haldex 67250						
E-4969-R	Trailmobile 700777					
	Fruehauf MWCX01386					
	Leland W72					
	NWRA X1386					
E-5869-L	Budd 59372					
	Leland W287					
	NWRA X1711					
E-5869-R	Budd 59371					
	Leland W286		4.13"	2.75"	.56"	Used on TK, TKL, RL, TL (also Eaton). With some cast drums on TK, TKL, use E
	NWRA X1710					

GRADE 8

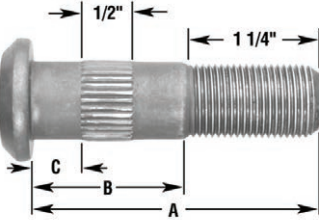

3/4"-16 THD.

WHEEL STUDS

SERRATED WHEEL STUDS

2

GRADE 8

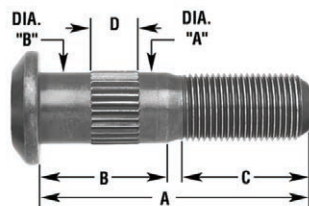

3/4"-16 THD.

EUCLID NO.	REPLACES	STUD BODY DIA.					
		"A"	"B"	A	B	C	D
E-8947-L	Budd 100146						
	Webb 159183						
	Erie 5309LH						
	Leland W576						
	NWRA X1715						
E-8947-R	Budd 100145	.777	.784	2.97"	1.41"	1.06"	.50"
	Webb 159184						
	Trailmobile 36159184						
	Erie 5308RH						
	Leland W575						
E-9003-L	Meritor 20X1467						
	Meritor 20X1811	.779	.779	2.91"	1.06"	1.59"	.31"
E-9003-R	Meritor 20X1468						
	Meritor 20X1812						
E-11662-L	Meritor 09001526	.784	.790	2.55"	1.14"	1.12"	.50"
E-11662-R	Meritor 09001525						
E-9008-L	Webb 100163						
	Leland W687	.786	.786	3.38"	1.41"	1.66"	.50"
E-9008-R	Webb 100164						
	Leland W686						
E-11665-L	Meritor 09001556	.875	.975	2.38"	1.10"	1.16"	.44"
E-11665-R	Meritor 09001555						
E-11659-L	Meritor 09001998	.890	.939	2.38"	.89"	1.25"	.50"
E-11659-R	Meritor 09001997						
E-11661-L	Meritor 09002050	.890	.939	2.38"	.89"	1.13"	.50"
E-11661-R	Meritor 09002049						
E-11674-L	Meritor 09001983	.890	.939	2.38"	1.00"	1.25"	.75"
E-11674-R	Meritor 09001982						
E-11676-L	Meritor 09001992	.890	.939	2.63"	.89"	1.38"	.50"
E-11676-R	Meritor 09001991						
E-11672-L	Meritor 09001911						
	Paccar SVVN610	.890	.939	2.63"	1.01"	1.38"	.50"
	Paccar SVVN611						
E-11672-R	Meritor 09001910						
	Paccar SVVN609						
E-11678-L	Meritor 09002086	.890	.939	2.77"	.87"	1.61"	.50"
E-11678-R	Meritor 09002085						
E-11677-L	Meritor 09001996						
	Paccar SVVN615	.890	.939	3.05"	.89"	1.80"	.50"
E-11677-R	Meritor 09001995						
	Paccar SVVN614						

WHEEL STUDS

SERRATED WHEEL STUDS - Stud Body Diameter .784

EUCID NO.	REPLACES	A	B	C	D
E-5764-L	Navistar 332528C1				
	Budd 90554				
	Leland W283				
	NWRA X1689	2.38"	1.00"	.38"	.19"
	Navistar 332529C1				
E-5764-R	Budd 90553				
	Leland W282				
	NWRA X1688				
E-5870-L	Meritor 20X1809				
	Budd 90514				
	Leland W285				
	NWRA X1693	2.63"	1.25"	.44"	.19"
	Meritor 20X1810				
E-5870-R	Budd 90513				
	Leland W284				
	NWRA X1692				
E-5775	World Truck 15418003				
	World Truck 1681015R				
	Dana/Spicer 501126	2.75"	1.38"	.50"	.25"
	Budd 85108				
	Ford C3TZ1118A				
E-5776	Leland W388				
	NWRA X2100				
	Budd 85141	3.00"	1.56"	.50"	.31"
	Leland W390				
E-5756-L	NWRA X1700				
	Trailmobile 13736				
	Budd 59067				
	Trailmobile 8-9-37				
	Fruehauf MWCX01705				
E-5756-R	Leland W373				
	NWRA X1705				
	Trailmobile 13371	3.38"	2.00"	.56"	.31"
	Budd 59066				
	Budd 590667				
E-5765-L	Trailmobile 8-9-36				
	Fruehauf MWCX01704				
	Leland W372				
	NWRA X1704				
	Haldex 67304				
E-5765-R	Budd 84098				
	Fruehauf MWCX01703				
	Leland W237				
	NWRA X1703	3.38"	2.00"	.38"	.19"
	Haldex 67303				
E-5757-L	Budd 84097				
	Fruehauf MWCX01702				
	Leland W236				
E-5757-R	NWRA X1702				
	Budd 59376				
	Fruehauf MWCX01707				
	Leland W279				
	NWRA X1707	3.63"	2.25"	.56"	.31"
E-5757-R	Budd 59375				
	Fruehauf MWCX01706				
	Leland W278				
	NWRA X1706				

GRADE 8

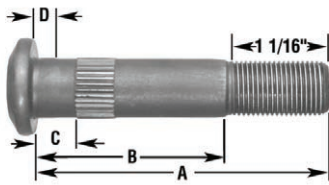

3/4"-16 THD.

WHEEL STUDS

SERRATED WHEEL STUDS - Stud Body Diameter .784

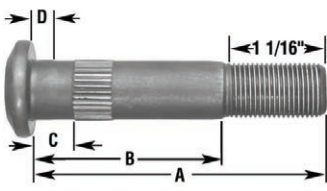
GRADE 8	EUCID NO.	REPLACES	A	B	C	D
 <p>3/4"-16 THD.</p>	E-5766-L	Budd 59374 Fruehauf MWCX01709 Leland W281 NWRA X1709	3.88"	2.50"	.56"	.31"
	E-5766-R	Budd 59373 Fruehauf MWCX01708 Leland W280 NWRA X1708				

SERRATED WHEEL STUDS - Stud Body Diameter .594

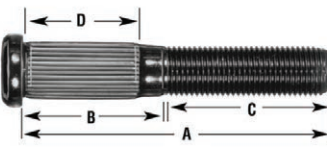
GRADE 8	EUCLID NO.	REPLACES	A	B	C	D
 <p>Use Euclid E-5892 Flanged Nut 9/16"-18 THD.</p>	E-5724	Std. Forge 3011161 Budd 31439 Meritor 4X199 Leland W74	3.25"	1.63"	1.63"	1.19"

SERRATED WHEEL STUDS - Stud Body Diameter .606

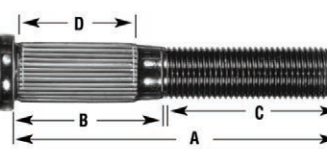
GRADE 8	EUCLID NO.	REPLACES	A	B	C	D
 <p>9/16"-18 THD.</p>	E-8963	GMC 3988538 Leland W600 NWRA X1473	3.00"	1.06"	1.25"	.88"
	E-8964	GMC 334386 Leland W601	3.50"	1.06"	1.63"	.88"
	E-8965	GMC 355815 Leland W602 NWRA X1424	3.59"	1.28"	2.00"	.88"

SERRATED WHEEL STUDS

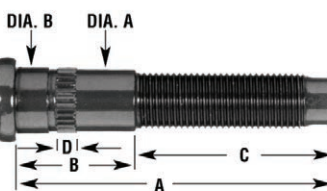
GRADE 8	EUCLID NO.	REPLACES	STUD BODY DIA.					
			"A"	"B"	A	B	C	D
 <p>9/16"-18 THD.</p>	E-8959-L	Ford 388381 Ford DOTZ1119A Leland W599	.600"	.641"	2.81"	1.13"	1.63"	.31"
	E-8959-R	Ford 388380 Ford DOTZ1107A Leland W598						

WHEEL STUDS

SERRATED WHEEL STUDS

GRADE 8

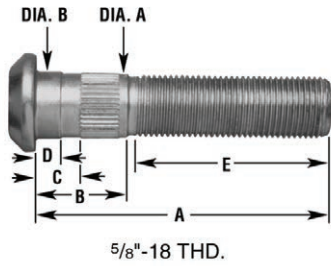

EUCID NO.

REPLACES

STUD BODY DIA.

E-8946-L

Std. Forge 3011351L
Budd 98349
Leland W385
Leland W604
NWRA X1842

"A"	"B"	A	B	C	D	E
.639	.673	2.94"	.94"	.44"	.673	1.69"

E-8946-R

Std. Forge 3011351R
Budd 98348
Leland E8946R
Leland W384
NWRA X1841

SERRATED WHEEL STUDS - Stud Body Diameter .730

GRADE 8

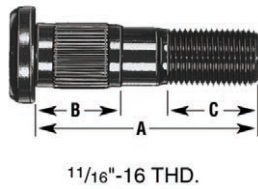

EUCLID NO.

REPLACES

A

B

C

E-5682

GMC 3763619
Budd 82525
Gunitite K46009
Leland W180
NWRA X1108

2.63"	1"	1.13"
-------	----	-------

E-5683

GMC 3765876
Gunitite 46009
Budd 82526
Leland W181
NWRA X1109

3.25"	1"	1.50"
-------	----	-------

E-5816

Std. Forge 3011121
Gunitite 46010
Budd 83172

3.25"	1.33"	1.36"
-------	-------	-------

SERRATED WHEEL STUDS

GRADE 8

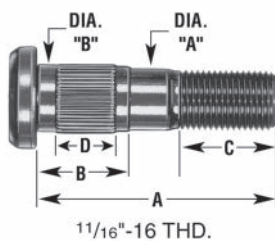

EUCLID NO.

REPLACES

STUD BODY DIA.

"A"

"B"

A

B

C

D

E-8962

GMC 3874369
Leland W677

.728	.747	3.25"	1.13"	1.84"	.63"
------	------	-------	-------	-------	------

E-8961

GMC 704173
Leland W682

.757	.757	3.63"	1.31"	1.97"	.50"
------	------	-------	-------	-------	------

SERRATED WHEEL STUDS

GRADE 8

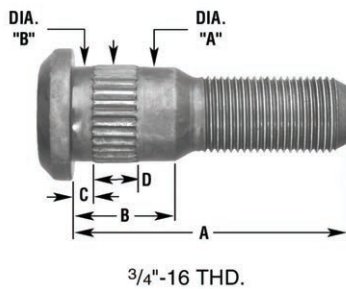

EUCLID NO.

REPLACES

STUD BODY DIA.

"A"

"B"

A

B

C

D

E-5632

Motor Wheel 83028
Leland W515

.747	.827	3.25"	.88"	1.75"	.75"
------	------	-------	------	-------	------

E-8949-L

Budd 106202
Budd 3008402
Leland W505

.902	.910	2.59"	.97"	.22"	.41"
------	------	-------	------	------	------

E-8949-R

Budd 106201
Budd 3008401
Ford E9HZ1151A
Leland W504

WHEEL STUDS

"D" HEAD STUDS - Stud Body Diameter .785 - Plain Body - For Aluminum Hubs

GRADE 8

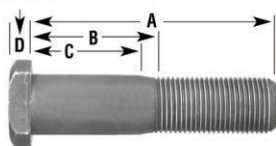

$\frac{3}{4}$ "-16 THD.

EUCLID NO.	REPLACES	A	B	C	D
E-10213-L	Paccar K03	2.94"	1.13"	.94"	.31"
	Paccar SNAA010L				
	Leland W743				
E-10213-R	Paccar K04	2.94"	1.13"	.94"	.31"
	Paccar SNAA010R				
	Leland W742				
E-6026-L	Conmet 100012	3.16"	1.72"	1.41"	.25"
	Fruehauf MWC101150				
	Leland W523				
	NWRA X2199				
E-6026-R	Conmet 100013	3.16"	1.72"	1.41"	.25"
	Fruehauf MWC101150				
	Leland W522				
	NWRA X2198				
E-6058-L	Conmet 100368	3.25"	1.88"	1.53"	.25"
	Freightliner 11108390				
	Leland W527				
	NWRA X2203				
E-6058-R	Conmet 100369	3.25"	1.88"	1.53"	.25"
	Freightliner 11108391				
	Leland W526				
	NWRA X2202				
E-10214-L	Paccar K05	3.31"	1.75"	.94"	.31"
	Leland W643				
E-10214-R	Paccar K06	3.31"	1.75"	.94"	.31"
	Leland W642				

WHEEL STUDS

"D" HEAD STUDS - Stud Body Diameter .785 - Plain Body - For Aluminum Hubs

GRADE 8

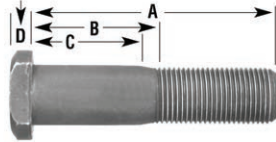

3/4"-16 THD.

EUCLID NO.	REPLACES	A	B	C	D
E-6027-L	Conmet 100255	3.41"	1.75"	1.41"	.31"
	Fruehauf MWC101150				
	Leland W543				
	NWRA X2209				
E-6027-R	Conmet 100254	3.41"	1.75"	1.41"	.31"
	Fruehauf MWC101150				
	Leland W542				
	NWRA X2208				
E-6059-L	Conmet 100370	3.53"	1.91"	1.56"	.25"
	Freightliner 11108392				
	Leland W529				
	NWRA X2205				
E-6059-R	Conmet 100371	3.53"	1.91"	1.56"	.25"
	Freightliner 11108393				
	Leland W528				
	NWRA X2204				
E-6028-L	Conmet 100226	3.78"	1.91"	1.56"	.25"
	Conmet 100372				
	Leland W578				
	NWRA X2200				
E-6028-R	Conmet 100225	3.78"	1.91"	1.56"	.25"
	Conmet 100373				
	Leland W577				
	NWRA X2201				

"D" HEAD STUDS - Stud Body Diameter .874

GRADE 8

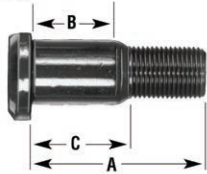

3/4"-16 THD.

EUCLID NO.	REPLACES	A	B	C				
E-5587-L	Budd 35787	2.00"	.78"	.97"				
	Leland W126							
	NWRA X1396							
E-5587-R	Budd 35786	2.00"	.78"	.97"				
	Leland W125							
	NWRA X1395							
E-4988-L	Gunite 20049	2.25"	1.03"	1.33"				
	Meritor 20X655							
	Budd 40337							
	Budd 43802							
	Ford 511108							
	Fruehauf 536365							
	Navistar 69327R2							
	Leland W102							
	NWRA X1051							
	Gunite 20048							
E-4988-R	Meritor 20X656	2.25"	1.03"	1.33"				
	Budd 40336							
	Budd 43801							
	Ford 511107							
	Navistar 69328R2							
	Leland W101							
	NWRA X1050							
	Budd 40339							
	E-5588-L				Leland W104	2.38"	1.19"	1.47"
					NWRA X1398			
Budd 40338								
E-5588-R	Leland W103	2.38"	1.19"	1.47"				
	NWRA X1397							

WHEEL STUDS

"D" HEAD STUDS - Stud Body Diameter .874

GRADE 8

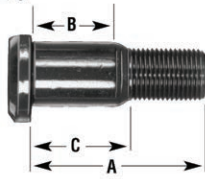

3/4"-16 THD.

EUCLID NO.	REPLACES	A	B	C
E-5618-L	Meritor 20X121	2.61"	1.31"	
	Budd 59537			
	Navistar 59790R1			
	Leland W402			
	NWRA X1667			
E-5618-R	Meritor 20X120			
	Budd 59536			
	Navistar 59791R1			
	Leland W401			
	NWRA X1666			

WHEEL STUDS

"D" HEAD STUDS - Stud Body Diameter .888 - For Dura-Light Hubs

GRADE 8	EUCLID NO.	REPLACES	A	B	C	D
 <p style="text-align: center;">3/4"-16 THD.</p>	E-10258-L		2.06"	.63"	1.13"	.31"
	E-10258-R					
	E-10259-L		2.34"	.63"	1.38"	.31"
	E-10259-R					

CLIPPED HEAD STUDS - Stud Body Diameter .907 - Plain Body

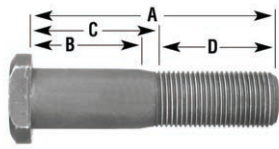
GRADE 8	EUCLID NO.	REPLACES	A	B	C	D
 <p style="text-align: center;">3/4"-16 THD.</p>	E-11685-L	Meritor 09002024	2.10"	.44"	.72"	1.39"
	E-11685-R	Meritor 09002023				
	E-11684-L	Meritor 09002022	2.37"	.44"	.72"	1.65"
	E-11684-R	Meritor 09002021				
	E-11686-L	Meritor 09002026	2.39"	.44"	.72"	1.67"
	E-11686-R	Meritor 09002025				

"D" HEAD STUDS - Stud Body Diameter .910

GRADE 8	EUCLID NO.	REPLACES	A	B	C
 <p style="text-align: center;">3/4"-16 THD.</p>	E-8952-L	Conmet 101773 Motor Wheel 90442 Volvo TDA E8952L Leland W627	3.16"	1.19"	1.25"
	E-8952-R	Conmet 101774 Motor Wheel 90441 Leland W626			

"D" HEAD STUDS - Stud Body Diameter 1.224 - Plain Body

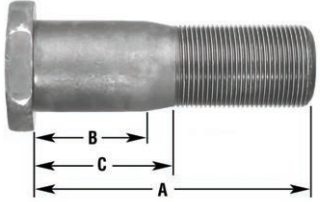
GRADE 8	EUCLID NO.	REPLACES	A	B	C
 <p style="text-align: center;">1 1/8"-16 THD.</p>	E-8950-L	Conmet 100149 Conmet 100264 Leland W531 NWRA X2207	3.72"	1.50"	1.75"
	E-8950-R	Conmet 100148 Conmet 100265 Leland W530 NWRA X2206			

WHEEL STUDS - METRIC

METRIC ROUND COLLAR SHOULDER STUDS - Stud Body Diameter .781

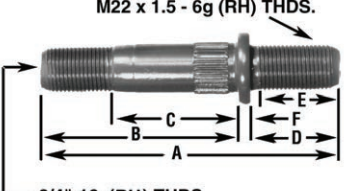
GRADE 8	EUCLID NO.	REPLACES	A	B	C	D	E	F
 <p style="text-align: center;">M22 x 1.5 - 6g (RH) THDS. 3/4"-16 (RH) THDS.</p>	E-11724	Meritor 09002073	5.54"	2.89"	1.64"	2.56"	2.25"	.09"
	E-11725	Meritor 09002140	6.40"	2.89"	1.43"	3.43"	3.11"	.09"

*Grade 10.9 is the metric equivalent of Grade 8.

WHEEL STUDS - METRIC

METRIC CLIPPED "D" HEAD STUDS - Stud Body Diameter .888 - For Dura-Light Hubs

GRADE 10.9*	EUCLID NO.	REPLACES	A	B	C
 <p style="text-align: center;">M22X1.5 THD.</p>	E-10256	Leland W770	3.38"	.50"	2.50"
	E-10257	Leland W759	4.19"	.50"	3.31"

METRIC CLIPPED HEAD STUDS - Stud Body Diameter .907 - Plain Body

GRADE 10.9*	EUCLID NO.	REPLACES	A	B	C	D
 <p style="text-align: center;">M22X1.5</p>	E-11693	Meritor 09001962	3.50"	.94"	.45"	.31"
	E-11692	Meritor 09001914	4.37"	.95"	.45"	.31"

METRIC "D" HEAD STUDS - Stud Body Diameter .910

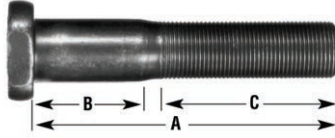
GRADE 10.9*	EUCLID NO.	REPLACES	A	B	C
 <p style="text-align: center;">M22X1.5 THD.</p>	E-6029A	Conmet 101151 Motor Wheel 89983 Fruehauf MWC101151 Leland W574	4.38"	1.30"	2.50"
	E-6001A	Conmet 101171 Motor Wheel 89774 Fruehauf MWC089774 Leland W547	4.97"	1.30"	3.25"
	E-6030A	Conmet 101150 Fruehauf MWC101150 Leland W524	5.25"	1.30"	3.34"

METRIC CLIPPED HEAD STUDS - Stud Body Diameter .981

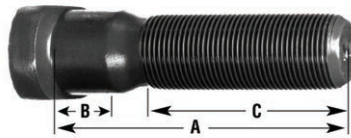
GRADE 10.9*	EUCLID NO.	REPLACES	A	B	C
 <p style="text-align: center;">M22X1.5 THD. E-5992A is "D" Head</p>	E-5994	Motor Wheel 88808 Fruehauf MWCX02141 Leland W490 NWRA X2141	3.25"	.67"	2.25"
	E-5992A	Meritor R005992 Meritor R005992A	3.56"	.72"	2.47"
	E-5993	Motor Wheel 88799 Leland W489 NWRA X2140	4.13"	.72"	3.06"
	E-8997	Motor Wheel 89620 Leland W679	4.72"	.63"	3.75"

METRIC SERRATED STUDS - Stud Body Diameter .791

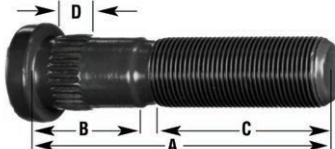
GRADE 10.9*	EUCLID NO.	REPLACES	A	B	C	D
 <p style="text-align: center;">M20X1.5 THD.</p>	E-11706	Meritor 09001853	2.75"	.75"	2.00"	.38"
	E-11712	Meritor 09001990	2.92"	.75"	2.17"	.38"
	E-11703	Meritor 09001811	3.68"	1.26"	2.42"	.38"
	E-11707	Meritor 09001855	3.88"	1.25"	2.63"	.38"
	E-11709	Meritor 09001964	4.17"	1.25"	2.92"	.38"

*Grade 10.9 is the metric equivalent of Grade 8.

WHEEL STUDS - METRIC

METRIC SERRATED STUDS - Stud Body Diameter .791

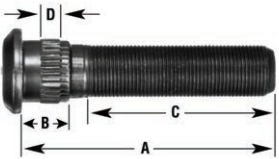
GRADE 10.9*	EUCLID NO.	REPLACES	A	B	C	D
 <p>M20X1.5 THD.</p>	E-11704	Meritor 09001825	2.54"	.83"	1.72"	.38"
	E-11705	Meritor 09001826	3.11"	.98"	2.13"	.38"

METRIC SERRATED STUDS - Stud Body Diameter .888

GRADE 10.9*	EUCLID NO.	REPLACES	A	B	C	D
 <p>M22X1.5 THD.</p>	E-9837	Meritor 09001989	3.72"	.87"	2.56"	.38"
		Navistar 1658475C1				
		Volvo 3133400				
		Paccar SVVN607				
		Paccar SVVN613				
		Leland W765				

METRIC SERRATED STUDS - Stud Body Diameter .890

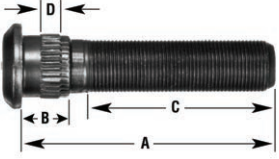
GRADE 10.9*	EUCLID NO.	REPLACES	A	B	C	D
 <p>M22X1.5 THD.</p>	E-11708	Meritor 09001958	2.76"	.79"	1.65"	.38"
	E-11718	Meritor 09002013	2.81"	.87"	1.68"	.38"
	E-11710	Meritor 09001988	3.34"	.87"	2.23"	.38"
	E-11714	Meritor 09002002	3.61"	.87"	2.67"	.38"
	E-11713	Meritor 09002001	3.85"	.87"	2.69"	.38"
	E-11717	Meritor 09002005	3.85"	1.12"	2.63"	.38"
	E-11701	Meritor 09001727	3.88"	.87"	2.75"	.38"
	E-11716	Meritor 09002004	4.17"	.87"	3.01"	.38"
	E-11702	Meritor 09001728	4.31"	.87"	3.18"	.38"
	E-11715	Meritor 09002003	4.78"	.81"	3.84"	.38"

METRIC SERRATED STUDS - Stud Body Diameter .901

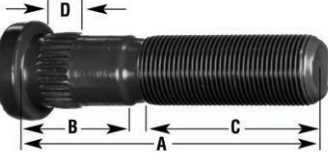
GRADE 10.9*	EUCLID NO.	REPLACES	A	B	C	D
 <p>M22X1.5 THD.</p>	E-5998	Budd 106377	3.19"	.88"	2.00"	.41"
		Budd 3018502				
		Navistar IT5998				
		Fruehauf MWCX02157				
		Leland W496				
		NWRA X2157				
		Budd 106216				
		Budd 3018503				
		Navistar IT5997				
	E-5997	Fruehauf MWCX02155	3.66"	.88"	2.45"	.41"
		Leland W497				
		NWRA X2155				

*Grade 10.9 is the metric equivalent of Grade 8.

WHEEL STUDS - METRIC

METRIC SERRATED STUDS - Stud Body Diameter .901

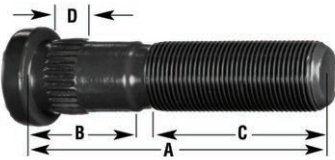
GRADE 10.9*	EUCLID NO.	REPLACES	A	B	C	D
 <p>M22X1.5 THD.</p>	E-5999	Budd 106397	4.56"	.88"	3.40"	.41"
		Budd 3018501				
		Navistar IT5999				
		Leland W495				
		NWRA X2158				

METRIC SERRATED STUDS - Stud Body Diameter .901

GRADE 10.9*	EUCLID NO.	REPLACES	A	B	C	D
 <p>M22X1.5 THD.</p>	E-11719	Meritor 09002184	2.94"	.87"	1.77"	.38"

METRIC SERRATED STUDS - Stud Body Diameter .910

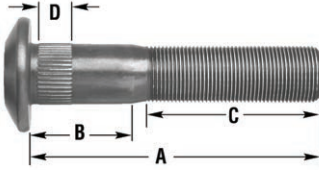
GRADE 10.9*	EUCLID NO.	REPLACES	A	B	C	D					
 <p>M22X1.5 THD.</p>	E-10222	Conmet 103193	3.66"	1.22"	2.09"	.50"					
		E-10218					Conmet 102033 Leland W703	3.97"	1.56"	2.06"	.50"
		E-10215					Conmet 102188 Motor Wheel 91161 Leland W716	4.09"	1.06"	2.34"	.50"
		E-10223					Conmet 103431	4.16"	1.22"	2.09"	.50"
		E-10219					Conmet 102290 Motor Wheel 91165 Leland W708	4.47"	1.56"	2.56"	.50"
		E-10216					Conmet 102189 Motor Wheel 91159 Leland W717	4.59"	1.06"	2.84"	.50"
		E-10217					Conmet 102190	4.97"	1.06"	3.22"	.50"
		E-10220					Conmet 102291 Motor Wheel 91163 Paccar SZAR010R Leland W718 Leland W719	4.97"	1.56"	3.06"	.50"
		E-10221					Conmet 102292 Paccar SZAR003R Leland W702	5.34"	1.56"	3.44"	.50"

*Grade 10.9 is the metric equivalent of Grade 8.

WHEEL STUDS - METRIC

METRIC SERRATED STUDS - Stud Body Diameter .975

EUCLID NO.	REPLACES	STUD BODY DIA.			
		"A"	"B"	C	D
E-9009	Navistar 1660579C1	2.56"	.72"	1.69"	.38"
	World Truck 1681047				
	Leland W661				
E-10242	Webb 101191	2.91"	.72"	1.66"	.38"
E-10675	Navistar 2007175C2	3.50"	.69"	2.50"	.50"
	Paccar SZAW013R				
	Gunite W1234				
	Gunite W1324				
E-6036	Webb 101164	3.50"	.72"	2.25"	.38"
	Webb 10164				
	Leland W544				
E-8988	Gunite W1246	3.69"	.88"	2.34"	.50"
	Leland W678				
E-6035	Conmet 10001399	3.94"	.72"	2.69"	.38"
	Webb 101162				
	Webb 36-101162				
	Erie 5324RH				
	Leland W545				
E-8981	Navistar 2010358C1	4.00"	.88"	2.91"	.50"
	Paccar SZAW021R				
	Gunite W1164				
	Gunite W1400				
E-10676	Leland W657	4.25"	.68"	3.25"	.50"
	Gunite W1196				
	Gunite W1249				
	Gunite W1327				
	Gunite W1403				
E-9526	Webb 101161	4.31"	.72"	3.06"	.38"
	Leland W714				
E-14640	Leland W715	4.50"	.47"	3.50"	.37"
E-6034	Webb 101160	4.78"	.72"	3.53"	.38"
	Webb 36-101160				
	Erie 5322RH				
	Leland W546				
E-8980	Gunite W1160	5.09"	.88"	3.75"	.50"
	Leland W656				
E-8987	Navistar 1652875C1	5.19"	1.06"	3.72"	.50"
	Mack 3398W1211				
	Leland W688				

GRADE 10.9*

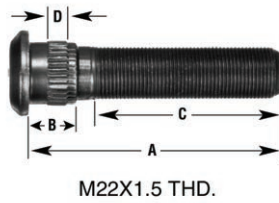

METRIC SERRATED STUDS

GRADE 10.9*



EUCLID NO.	REPLACES	STUD BODY DIA.		A	B	C	D
		"A"	"B"				
E-8960	Ford E6HZ1107A	.982	1.001	3.44"	2.00"	1.00"	.50"
	Leland W650						

*Grade 10.9 is the metric equivalent of Grade 8.

WHEEL STUDS - METRIC

METRIC SERRATED STUDS - Stud Body Diameter 1.22

GRADE 10.9*	EUCLID NO.	REPLACES	A	B	C	D
	E-8986	Gunite W1205 Leland W676	4.52"	1.00"	2.63"	.44"

M22X1.5 THD.

DRIVE FLANGE STUDS

BUDD, DAYTON, GUNITE, MERITOR

EUCLID NO.	REPLACES	BODY DIA.	LENGTH	HUB END	NUT END	HUB END THREAD	NUT END THREAD
				THREAD	THREAD		
E-5796	Meritor 08007358 Webb 142022 Budd 42793 Leland L1519	.44"	2.16"	.44"-14	.56"	.44"-20	.94"
	Meritor SC718 Meritor SC7181 Leland W595 Gunite WP28 NWRA X1787						
	Budd 37181 Budd 44577 Leland L1520 Meritor SC819 Meritor SC8191 NWRA X1790						
	Meritor 08004350 Webb 152026 Budd 19937						
	Leland L1521 Leland L2093 Gunite WP81 NWRA X1777						
	Meritor 08205435						
	Meritor 08205373						
E-5798	Leland L1521 Leland L2093 Gunite WP81 NWRA X1777	.50"	2.50"	.50"	.75"	.50"	.81"
	Meritor 08205435						
E-5799	Meritor 08205435	.50"	2.88"	.50"	.83"	.50"	.98"
E-11648	Meritor 08205373	.50"	3.00"	.50"	1.00"	.50"-13	1.00"
E-11652	Meritor 08205741	.50"	3.03"	.50"	1.00"	.50"-13	1.00"
E-5944	Meritor 4X1612 Leland L1532 Gunite WP693	.56"	2.50"	.56"-12	.81"	.56"-18	.88"
	Meritor 08203868						
	Meritor 08205575						
E-11647	Meritor 08203868	.56"	2.50"	.56"	1.00"	.56"	.90"
E-11650	Meritor 08205575	.56"	2.92"	.56"	1.25"	.56"	1.00"
E-11646	Meritor 08007591	.62"	2.88"	.62"-11	1.150"	.62"-18	1.12"
E-11651	Meritor 08205740	.62"	2.94"	.62"	.85"	.62"-11	1.38"
E-11654	Meritor 08205833	.62"	3.03"	.62"	.96"	.62"-18	1.36"
E-5946	Leland L2095 Meritor SC1020	.63"	2.50"	.63"-11	.94"	.63"-18	1.00"

GRADE 8

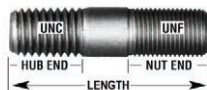

*Grade 10.9 is the metric equivalent of Grade 8.

DRIVE FLANGE STUDS

BUDD, DAYTON, GUNITE, MERITOR

EUCLID NO.	REPLACES	BODY DIA.	LENGTH	HUB END		NUT END	
				THREAD	THREAD LENGTH	THREAD	THREAD LENGTH
E-5800	Meritor 08007775						
	Navistar 119345H						
	Budd 63606						
	Leland L1525						
	Budd M2523	.63"	2.75"	.63"-11	1.00"	.63"-18	1.00"
	Meritor SC1022						
	Meritor SC10221						
	Paccar SVVN605						
E-5947	Gunite WP174						
	NWRA X1792						
	Navistar 684368R1						
	Leland L1526	.63"	2.88"	.63"-11	.94"	.63"-18	1.00"
E-5954	Meritor SC10231						
	Meritor 08008551						
E-5801	Leland L1526	.63"	2.88"	.63"-11	1.00"	.63"-18	1.06"
	Budd 48966						
	Leland L2094	.63"	3.06"	.63"-11	1.13"	.63"-18	1.06"
E-5949	NWRA X1793						
	Leland L2959						
E-5872	Meritor SC1026	.63"	3.25"	.63"-11	.94"	.63"-18	1.00"
	Meritor SC10261						
	Conmet 100383						
	World Truck 1511011						
	Trailmobile 385872						
	Meritor 4X1027						
	Dana/Spicer 54-1621-90						
	Dana/Spicer 541621	.63"	3.69"	.63"-11	1.53"	.63"-18	1.13"
	Navistar 60421R1						
	Motor Wheel 86478						
E-5955	Kenworth K233B305						
	Leland L1529						
	Budd M2524						
	Meritor 08007471						
	Navistar 611428						
E-4960	Navistar 61142H	.75"	3.25"	.75"-10	1.13"	.75"-16	1.25"
	Leland L1530						
	Budd M2525						
	Budd 37173						
	Budd 37179						
	Budd 3927302						
	Budd 49328						
	Meritor 4X1207						
	Navistar 55585H	.75"	3.75"	.75"-10	1.13"	.75"-16	1.63"
	Budd 99357						
Leland L1531							
Budd M2526							
Gunite WP39							

GRADE 8

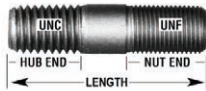

DRIVE FLANGE STUDS

DRIVE FLANGE & GENERAL PURPOSE STUDS

GRADE 8

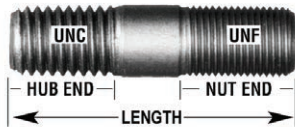

EUCLID NO.	BODY DIA.	LENGTH	HUB END		NUT END	
			THREAD	THREAD LENGTH	THREAD	THREAD LENGTH
E-4942	.50"	2.00"	.50"-13	.69"	.50"-20	1.06"
E-4944	.50"	2.50"	.50"	.81"	.50"	1.19"
E-4945	.50"	2.75"	.50"	.94"	.50"	1.44"
E-4946	.50"	3.00"	.50"	.94"	.50"	1.75"
E-4947	.50"	3.50"	.50"	.94"	.50"	2.25"
E-4948	.56"	2.50"	.50"	.88"	.50"	1.25"
E-4949	.56"	2.75"	.56"-12	.94"	.56"-18	1.50"
E-4950	.56"	3.25"	.56"-12	.94"	.56"-18	1.94"
E-4951	.63"	2.63"	.63"-11	.94"	.63"-18	1.25"
E-5702	.63"	2.63"	.63"	1.06"	.63"	1.06"
E-4952	.63"	3.00"	.63"	.88"	.63"	1.81"
E-4953	.63"	3.50"	.63"	.88"	.63"	2.25"

METRIC

GRADE 10.9

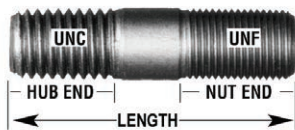

EUCLID NO.	BODY DIA.	LENGTH	HUB END		NUT END	
			THREAD	THREAD LENGTH	THREAD	THREAD LENGTH
E-11657	.62"	2.72"	.63"-11	.84"	M16 x 1.5-6g	.97"

DRIVE FLANGE WEDGES

DRIVE FLANGE WEDGE (Plated)

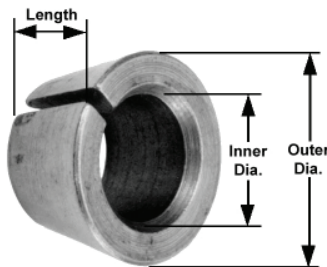

EUCLID NO.	REPLACES	INNER DIA.	OUTER DIA.	LENGTH
E-5952	Meritor 1246Z234	.44"	.69"	.41"
	Haldex 67543			
	Leland L1513			
	Budd M2527			
E-5736		.44"	.75"	.31"
E-5737 ¹	Meritor 1246X232	.44"	.75"	.41"
	Meritor 1246Z1170			
	Haldex 67544			
	Leland L1514			
E-5738		.44"	.81"	.34"
E-5739	Leland L1515	.50"	.81"	.31"
E-5740 ¹	Meritor 1246A1171	.50"	.81"	.41"
	Meritor 1246T306			
	Leland L1515			
E-5957	Meritor 1246B28	.50"	.88"	.47"
E-5742		.56"	.88"	.38"
E-5743	Meritor 1246Y233	.63"	1.00"	.47"
E-5960 ¹	Meritor 1246D290	.63"	1.00"	.56"
	Meritor 1246V1166			
E-10828	Meritor 1246L350	.75"	1.13"	.50"

DRIVE FLANGE NUTS

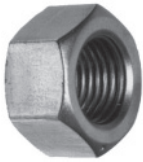

EUCLID NO.	REPLACES	THREAD	HEX	HEIGHT
E-5961	Meritor N171	.44"-20	.69"	.39"
	Meritor N47			
	Leland W554			
E-5962	Meritor N48	.50"-20	.75"	.56"
	Meritor N481			
	Meritor N48P			
	Leland W556			
E-5963	Meritor N19	.56"-18	.88"	.48"
	Meritor N191			
E-2002	Leland W557	.63"-18	.94"	.53"
	Leland L1102			
	Meritor N110			
	Meritor N1101			
	Leland SA1232			
E-5964	Leland SA1965	.75"-16	1.13"	.63"
	Leland W558			
E-5032	Leland W559	.50"-20	.75"	.44"
	Motor Wheel 86897			
	Meritor N18			
	Meritor N181			
	Leland W24			
	Leland W555			
NWRA X1122				

DRUM BOLT ASSEMBLIES

GRADE 8

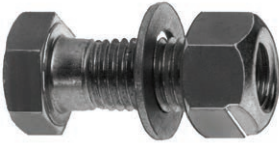

EUCLID NO.	THREAD SIZE	LENGTH
E-5970	.63"-18	2.00"
E-9261	.63"-18	2.25"
E-5971	.75"-10	2.00"
E-9262	.75"-10	2.25"
E-5972	.75"-16	2.00"

BRAKE DRUM ATTACHING SCREW

For Outboard Mounting



EUCLID NO.	REPLACES	THREAD	LENGTH
E-5018	Ford 35581657	.50" - 13	1.00"
	Budd 59891		
	Motor Wheel 87133		
	Meritor S788S		
	Leland W560		

SPOKE WHEEL & RIM STUDS

EUCLID NO.	REPLACES	A	THREAD	THREAD LENGTH	
				B	C
E-4955	Meritor 08005148	2.38"	.63" - 11	.88"	1.22"
	Haldex 67215				
	Trailmobile 8-9-5				
	NWRA B600				
	Dana/Spicer H504400				
	Goodyear ST69				
	Leland W17				
E-4958	Meritor 08006654	2.75"	.63 in - 11	.88"	1.69"
	Webb 161127				
	Navistar 260578C1				
	Ford 35867158B				
	Trailmobile 39303				
	Meritor 4X1424				
	Haldex 67204				
	Trailmobile 8-9-7				
	Navistar 91872H				
	NWRA B601				
	Leland L1524				
	Fruehauf MWCB00601				
	Goodyear ST68				
Leland W428					
Leland W5					
Gunite WP177					
E-4956A	Meritor 08-008411	3.00"	.75" - 10	1.06"	1.75"
	Webb 171027				
	Trailmobile 39669				
	Erie 5259				
	Navistar 54494R1				
	Haldex 67205				
	Trailmobile 8-9-8				
	NWRA B602				
	Meritor R004956APL				
	Goodyear ST29				
Leland W6					
Gunite W855					
Gunite WP147					
Gunite WP855					
E-5706	Meritor 08204734	3.13"	.75" - 10	1.06"	1.88"
	NWRA B612				
	NWRA B614				
	Paccar SVVN606				
	Leland W246				
Gunite WP202					
E-5726	Goodyear ST178	3.25"	.63" - 11	.88"	1.88"
	Leland W430				
	NWRA X2105				
E-5727	Goodyear ST1298	3.50"	.63" - 11	.88"	1.88"
	Leland W573				
	NWRA X1729				

GRADE 8

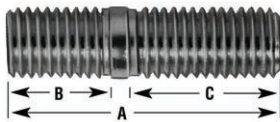

SPOKE WHEEL & RIM STUDS

GRADE 8

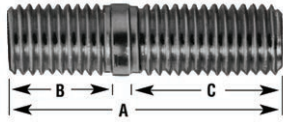

EUCLID NO.	REPLACES	A	THREAD	THREAD LENGTH	
				B	C
E-4957	Meritor 08034396	3.56"	.75" - 10	1.63"	1.63"
	Meritor 08203580				
	Trailmobile 43321				
	Haldex 67286				
	Trailmobile 8-9-18				
	NWRA B605				
E-5728	Leland W151	3.63"	.75" - 10	1.06"	2.38"
	Goodyear ST770				
	Leland W431				
	NWRA X1730				
E-5729	Goodyear ST570	4.00"	.75" - 10	1.06"	2.75"
	Leland W432				
	NWRA X2106				

GRADE 8

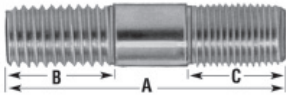

EUCLID NO.	REPLACES	A	THREAD	B	C
				LENGTH	THREAD
E-5887	Mack 18AX340	2.50"	.56"-12	.88"	.56"-18
	Leland L1532				
	Leland W457				
	Gunite WP83				

GRADE 8

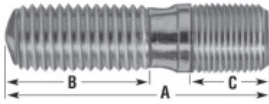

E-4987A	Mack 18AX405	2.88"	.75"-10	1.63"	.75"-16
	Haldex 67218				
	NWRA B606				
	Leland W22				
	Gunite WP477				

SPOKE WHEEL & RIM BOLTS

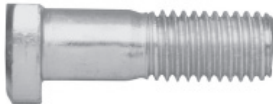

EUCLID NO.	REPLACES	THREAD	LENGTH	APPLICATION & GENERAL
				INFORMATION
E-4989	Erie 5095	.63"-11	2.00"	Use with E-4962 Nut. Grade 8.
	Erie 5095R			
	Haldex 67216			
	Navistar 68333H			
	Mack 6AX460			
	NWRA B610			
E-5012	Leland W10	.63 in-11	2.00"	Clipped head, round body. Use with E-4962 Nut. Grade 8.
	Leland W19			



E-5012	Haldex 67217	.63 in-11	2.00"	Clipped head, round body. Use with E-4962 Nut. Grade 8.
	Navistar 75887H			
	NWRA N3324			
	Leland W21			

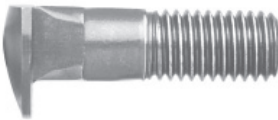

E-5712	Navistar 68333H	.63 in-11	2.06"	Use with E-4962 Nut. Grade 8.
	NWRA B467			
	Leland W19			

SPOKE WHEEL & RIM BOLTS

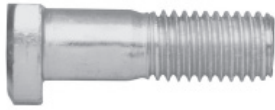

EUCLID NO.	REPLACES	THREAD	LENGTH	APPLICATION & GENERAL INFORMATION
E-5761	Erie 5247	.75"-10	2.19"	Use with E-4963 Nut. Grade 8.
	Erie 5247R			
	Haldex 67220			
	NWRA B607			
	Leland W220			



E-4990A	Mack 3AX1261	.63"-11	2.25"	Use with E-4962 Nut. Grade 8.
	Mack 3AX1901			
	Meritor R004990			

RIM CLAMPS



EUCLID NO.	REPLACES	A	B	C	D
E-5036	Navistar 239406R1	.63"	2.00"	2.38"	.63"
	Haldex 67284				
	Volvo 852957				
	Ford 8EQ1042				
	NWRA C181				
	Leland W146				
	Gunite WP80				

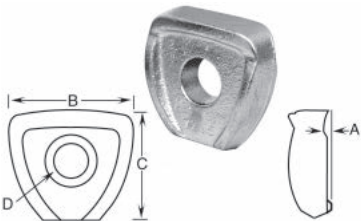

E-5927	Meritor 09007587	.50"	2.00"	2.00"	.63"
	Meritor 09839910				
	Navistar 215664R1				
	Navistar 215664R2				
	Volvo 499716				
	Haldex 67275				
	Leland W124				
E-5926	NWRA W83	.50"	2.00"	2.00"	.75"
	NWRA W84				
	Meritor 09885310				
E-5926	Leland W408	.50"	2.00"	2.00"	.75"
	NWRA W85				

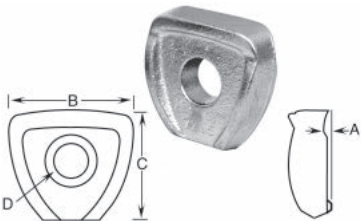

E-5838	Meritor 09007295	.19"	2.50"	2.63"	.75"
	Mack 15QJ210				
	Erie E4				
	Leland W407				

RIM CLAMPS

EUCLID NO.	REPLACES	A	B	C	D	SPACER WIDTH
E-5570	Meritor 09541417					
	Webb 15414					
	GMC 2398446					
	Trailmobile 37841					
	Haldex 67200					
	Trailmobile 8-8-3	1.00"	2.88"	2.50"	.63"	4.00"
	Navistar 92134H					
	Volvo A33768X					
	Erie E4					
	Leland W1					
NWRA W90						
E-5571A	Meritor 09612317					
	Mack 15QJ154A					
	Webb 16123					
	Meritor 3280K7863					
	Volvo 426957					
	Navistar 54493R2					
	GMC 5667139					
	Haldex 67202					
	Trailmobile 8-8-6					
	Navistar 973230R1	1.13"	2.88"	2.50"	.75"	4.00"
	Erie B					
	Ford D8HT1043AA					
	Erie E1					
	Erie E19					
	Erie E20					
Navistar IT6051						
Leland W3						
Leland W541						
NWRA XW96						
E-5784A	Meritor 09870817					
	Meritor 09890817					
	Webb 16126					
	Navistar 988339R1					
	Erie E12	1.38"	2.88"	2.50"	.75"	4.00"
	Erie E22					
	Leland W405					
Leland W408						
NWRA XW103						
E-5045	Meritor 09658417					
	Mack 15QJ118P3					
	Volvo 466121A					
	GMC 5767139					
	Haldex 67201					
	Navistar 92135H	1.44"	2.81"	2.47"	.63"	3.63"
	Erie E5					
	Leland W143					
	Leland W2					
NWRA W93						

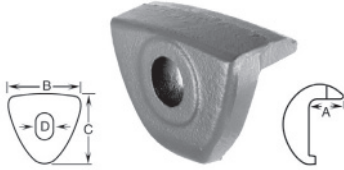

RIM CLAMPS

EUCLID NO.	REPLACES	A	B	C	D	SPACER WIDTH
E-5040A	Meritor 09699317					
	Webb 16124					
	Webb 16129					
	Trailmobile 44051					
	Volvo 451061A					
	GMC 576140					
	GMC 5767140					
	Haldex 67272	1.50"	2.88"	2.50"	.75"	3.63"
	Trailmobile 8-8-20					
	Erie E21					
	Erie E3					
	Navistar IT6051L					
	Navistar IT6058					
	Leland W120					
Leland W404						
NWRA W98						
E-5044	Meritor 09604017					
	Mack 15QJ118P2					
	GMC 2398447					
	Trailmobile 39668					
	Volvo 400245A					
	Fruehauf 535406	1.63"	2.75"	2.50"	.63"	3.38"
	Haldex 67271					
	Trailmobile 8-8-8					
	Erie E9					
	Leland W119					
NWRA W91						
E-5055	Mack 15A5223AP					
	Mack 15QJ223AP	1.75"	2.63"	2.47"	.75"	3.63"
	Leland W447					
E-5572A	Meritor 09623517					
	GMC 2393267					
	Trailmobile 42955					
	Volvo 448888A					
	Fruehauf 535414	1.75"	2.88"	2.50"	.75"	3.38"
	Haldex 67203					
	Trailmobile 8-8-17					
	Erie E2					
Leland W4						
NWRA W97						
E-5785A	Meritor 09705317					
	Meritor 09870917					
	Leland W403	1.88"	2.88"	2.41"	.75"	3.38"
	Leland W404					
	Leland W406					
NWRA W99						
E-5839	Meritor 09604317					
	Leland W193	2.00"	2.88"	2.41"	.63"	3.00"
	Leland W403					
	Leland W406					

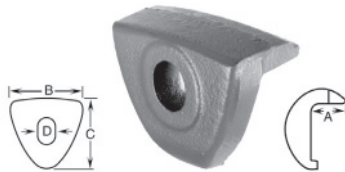

RIM CLAMPS

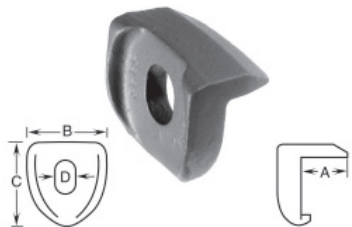
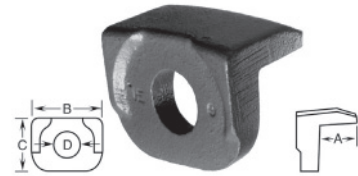
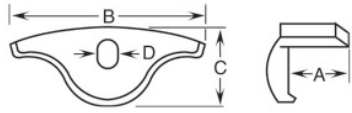

EUCLID NO.	REPLACES	A	B	C	D	SPACER WIDTH	
E-5827	Meritor 09006256						
	Mack 15QJ16	1.13"	6.00"	2.44"	.75"		
	NWRA W112						
	Leland W536						
E-5883	Mack 15QJ16P3	1.31"	6.00"	2.50"	.75"		
	Leland W537						
E-5829	Meritor 09006302						
	Haldex 67293	1.44"	6.63"	2.44"	.75"	4.00"	
	NWRA W114						
E-5828	Leland W184						
	Meritor 09006257						
	Mack 15QJ17P1	1.81"	6.00"	2.44"	.75"	3.38"	
	Mack 15QJ17P3						
	NWRA W113						
E-5573	Leland W450						
	Mack 15QJ121						
	Mack 15QJ21						
	Paccar 2E-5573	1.13"	3.50"	2.25"	.63"	4.00"	
	Erie K						
	Leland W136						
NWRA XW55K							
E-5747	EUCLID NO.	A	B	C	D		
	GMC 3778640						
	Haldex 67279						
	Erie E7						
	Leland W135	1.06"	2.38"	1.75"	.75"		
	NWRA W227						
	Gunite WP267						
	NWRA XW227						
	E-5755	Navistar 868368R1					
		Navistar 86836R1					
NWRA W228		1.31"	2.25"	1.81"	.75"		
Leland W533							
Gunite WP368							
NWRA XW228							
E-5753	GMC 2377906						
	Leland W446	1.44"	2.38"	1.81"	.75"		
	Gunite WP344						
	NWRA XW191						
E-5837	Navistar 578997C1						
	NWRA W240	1.81"	2.25"	1.81"	.75"		
	Leland W255						
	Gunite WP398						
E-5823	Mack 15QJ223BP4	1.13"	2.50"	2.44"	.75"		
	NWRA W189						
E-5885	Goodyear CL1008	1.19"	2.50"	2.41"	.75"		
	Leland W456						
E-5822	Mack 15AJ223BP5						
	Mack 15QJ223BP5						
	Mack 15QJ223CP5	1.50"	2.50"	2.44"	.75"		
	NWRA W252						
Leland W479							

RIM CLAMPS

EUCLID NO.	REPLACES	A	B	C	D	
E-5820	Mack 15QJ112BP2	1.63"	2.50"	2.44"	.75"	
	Mack 15QJ112BQ					
	Mack 15QJ223BP2					
	Leland W572					
E-5781	Mack 15QJ223BP8	1.88"	2.50"	2.44"	.75"	
	Mack 15QJ223CP8					
	NWRA W121					
	Leland W448					
E-5821	Leland W488	2.13"	2.50"	2.44"	.75"	
	Mack 15QJ223BP3					
	Mack 15QJ223CP3					
	NWRA W249					
E-5783	Leland W467	2.38"	2.50"	2.44"	.75"	
	Mack 15AJ223BP6					
	Mack 15QJ223BP6					
	Mack 15QJ223CP6					
E-5841	NWRA W120	.53"	1.88"	2.00"	.75"	
	Leland W449					
	GMC 644158					
	Leland W568					
EUCLID NO.	REPLACES	A	B	C	D	RIM WIDTH
E-5902	Meritor 09001275	.50"	2.50"	3.63"	.75"	8.00"
	Meritor 2257Y1013					
	Navistar 472277C1					
	Navistar IT6059					
	NWRA W243					
	Leland W256					
Gunite WP722						
E-9023	Leland W418	.63"	2.50"	3.63"	.75"	
	Gunite WP725					
	NWRA XW244					
E-5890	Mack 15QJ239	.50"	2.00"	2.13"	.75"	
	Navistar 386789C1					
	NWRA C233					
	Leland W416					
E-5889	Gunite WP544	.50"	2.00"	2.16"	.75"	
	NWRA C232					
	Leland W415					
E-5891	Gunite WP515	.75"	2.00"	2.16"	.75"	
	Navistar 512633C1					
	NWRA C234					
	Leland W417					
	Gunite WP545					

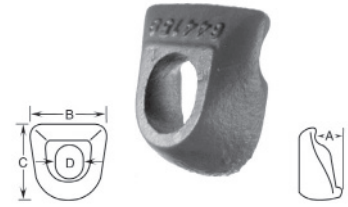
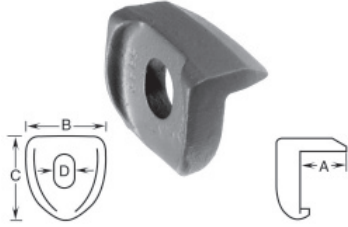

RIM CLAMPS



EUCLID NO.	REPLACES	A	B	C	D
E-9024	Webb 16177	.34"	2.63"	2.75"	.75"
	Leland W566				

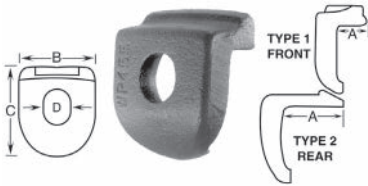

EUCLID NO.	REPLACES	A	B	C	D	TYPE
E-5974	NWRA W118	1.44"	2.31"	2.34"	.75"	Type 2 Rear Wheel
	Leland W413					
	Gunite WP682					

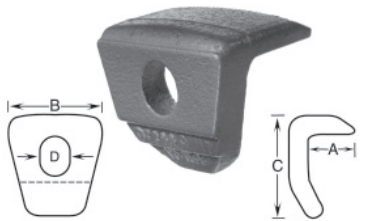

EUCLID NO.	REPLACES	A	B	C	D	SPACER WIDTH
E-5905A	Navistar 403961C1	1.19"	2.88"	2.38"	.75"	4.00"
	Ford D8HZ1403B					
	Gunite W1110					
	NWRA W241					
	Leland W258					
E-5904A	Gunite W858	1.38"	2.88"	2.38"	.75"	4.00"
	Gunite W1138					
	NWRA W242					
	Leland W257					
	Gunite W846					
E-5906	NWRA XW255	1.63"	2.25"	2.25"	.75"	3.63"
	NWRA W239					
	Leland W259					
	Gunite W866					
E-5778	NWRA XW239	1.31"	2.63"	2.19"	.75"	4.00"
	Leland W570					
	Gunite WP383					

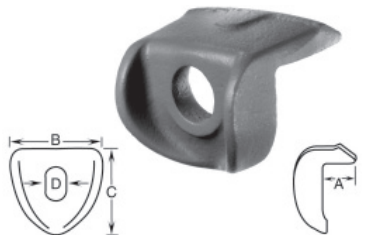

RIM CLAMPS

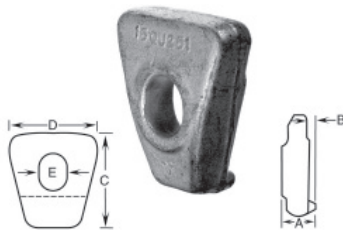

EUCLID NO.	REPLACES	A	B	C	D	E
E-6053	Mack 15QJ251	1.00"	.31"	2.63"	2.50"	.81"
	Leland W565					



EUCLID NO.	REPLACES	A	B	C	D	E
E-6054	Navistar 452010C1	.50"	1.25"	3.44"	2.06"	.81"
	Leland W494					

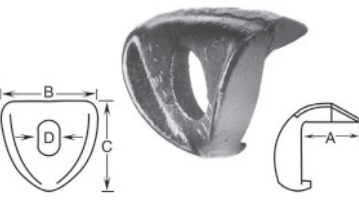

EUCLID NO.	REPLACES	A	B	C	D	SPACER WIDTH
E-5047	Meritor 09717510	1.06"	3.00"	2.41"	.63"	4.00"
	Navistar 171194R5					
	Trailmobile 41129					
	Trailmobile 8-8-12					
	Erie E10					
	Leland W118					
NWRA W94						
NWRA XW94						

E-5046	Meritor 09717110	1.06"	3.00"	2.41"	.75"	4.00"
	Trailmobile 43320					
	Haldex 67270					
	Trailmobile 8-8-18					
	Erie E6					
	NWRA W100					
Leland W117						
Leland W145						
NWRA XW100						

RIM CLAMPS

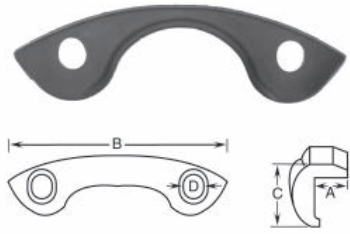

EUCLID NO.	REPLACES	A	B	C	D	WHEEL SIZE
E-5825	Webb 3322					
	Haldex 67302					
	Leland W227	1.06"	12.31"	2.31"	.75"	22"
	NWRA W74					
	NWRA XW74					
E-5824	Webb 3320					
	Leland W226	1.13"	10.63"	2.50"	.75"	20"
	NWRA W72					
	NWRA XW72					
E-5953	Webb 3314					
	Navistar IT6048					
	Leland W420	1.25"	7.75"	1.81"	.75"	15"
	NWRA W68					
E-5973	NWRA XW68					
	World Truck 1109005					
	Leland W421	1.94"	7.69"	1.86"	.75"	15"
	NWRA W69					

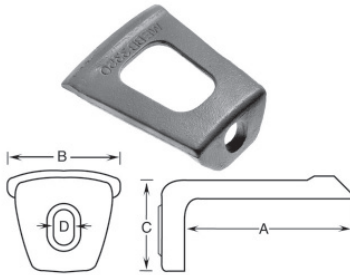

EUCLID NO.	REPLACES	A	B	C	STUD D
E-5976 ²	Meritor 09007564				
	Webb 3350	5.75"	3.25"	2.38"	.75"
	Leland W534				

² For mounting Single Wheel duplex rim in place of Dual Wheels.
Not recommended for Severe Service off-highway applications.

SPOKE WHEEL SERVICE INFORMATION

HEEL-LESS CLAMP

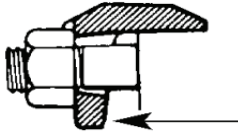

Heel-less clamps do not depend on a fulcrum at the bottom of the clamp to produce the force to wedge the rims.

Heel of clamp does not touch wheel here.

HEEL TYPE CLAMP

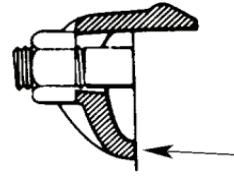

Gap permissible but not required - if gap exceeds 1/4" or if clamp bottoms out before reaching 80% of recommended torque, check to insure that proper clamps and spacer are being used.

MOUNTING INSTRUCTIONS

1. Position all Rim Clamps in place, then install the Rim Clamp Nuts finger tight. If Ball Faced Nuts are required by clamp design, be sure they are placed with the ball side to the Clamp.
2. Lightly tighten Nuts in the sequence shown to 50 foot-pounds.

Tighten Nuts to Wheel Manufacturer's Specifications in the sequence shown. Tighten Nuts a quarter turn at a time.

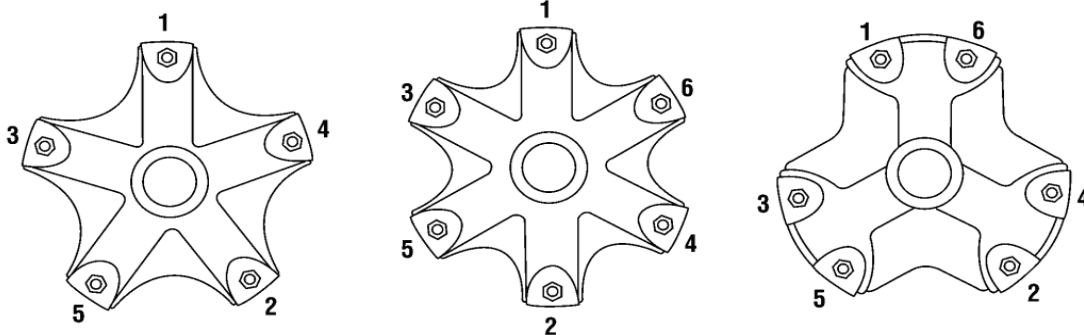

TORQUE CHART

NUT THREAD	TORQUE LEVEL
5/8"-11	160-200 ft. lbs. (dry)
3/4"-10	200-260 ft. lbs. (dry)

Information courtesy of TMC (The Maintenance Council of The American Trucking Association). For complete wheel service guidelines see TMC RP-222, "User's Guide to Wheels and Rims".

DISC WHEEL SERVICE INFORMATION

INSTALLATION TIPS

1. Never mix hub-piloted and stud-piloted wheels, hubs and nuts. The result could be loss of torque, a cracked wheel or possible wheel loss.
2. For nuts used on hub-piloted wheels, apply two drops of oil to a point between the nuts and flanges and two drops to the last 2 or 3 threads at the end of each stud. Also, lightly lubricate the pilots on the hub to ease wheel installation and removal. Do not get lubricant on the mounting face of the drum or wheel.
3. For nuts used on stud-piloted wheels, do not use lubrication. Never lubricate wheel or nut ball seats or mounting faces. If lubrication is used, consult the wheel manufacturer for torque recommendations.
4. Install nuts using proper installation sequence as shown below. Snug up nuts to about 50 ft.lbs. Torque. Do not tighten fully until all have been seated; then torque to specs as shown below using the same installation sequence.
5. After a wheel assembly has been installed, recheck the torque level between 50 and 100 miles of operation and retighten if necessary to the recommended torque using the proper sequence.
 - a. To check and retorque an inner cap nut, it is necessary to loosen the outer cap nut first; then tighten the inner cap nut. Outer cap nuts then must be retightened to the proper level.
 - b. It is recommended that a torque check be made as part of a vehicle's scheduled maintenance program or at 10,000 mile intervals, whichever comes first.

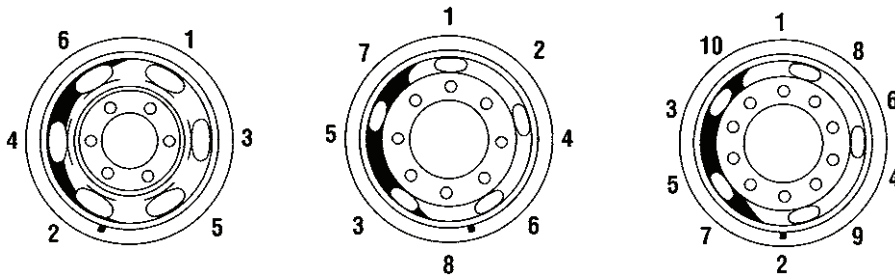



TORQUE CHART

MOUNTING TYPE	NUT THREAD	TORQUE LEVEL
Hub-piloted with flange nut	11/16" – 16	300-400 ft. lbs (oiled)*
	M20 x 1.5	280-330 ft. lbs (oiled)*
	M22 x 1.5	450-500 ft. lbs (oiled)*
Stud-piloted, double cap nut- heavy-duty type (7/8" ball seat radius)	3/4" – 16	450-500 ft. lbs (dry)*
	1-1/8" - 16	450-500 ft. lbs (dry)*
Stud-piloted, double cap nut - heavy-duty type (1-3/16" ball seat radius)	15/16" – 12	750-900 ft. lbs (dry)*
	1-1/8" – 16	750-900 ft. lbs (dry)*
	1-5/16" - 12	750-900 ft. lbs (dry)*
* See Installation Tip #2 (above)		



Information courtesy of TMC (The Maintenance Council of The American Trucking Association). For complete wheel service guidelines see TMC RP-222, "User's Guide to Wheels and Rims".

TRAILER AXLE SPINDLE HARDWARE

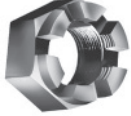
EATON & FRUEHAUF AXLES

	EUCLID NO.	DESCRIPTION	REPLACES	ACROSS THREAD		WASHERS			PIN	
				FLATS	SIZE	THICK	O.D.	I.D.	DIA.	LENGTH
	E-2306	Cotter Pin	Fruehauf 103426 Dana/Spicer 12406						.25"	3"
	E-620	Axle Spindle Washer	Fruehauf 530085 Navistar IT12405 Leland L249			.25"	3"	1.50" x 1.38" "D" Hole		
	E-576	Axle Spindle Nut	Gunite 4074 Fruehauf 530088 Navistar IT12404 Leland L195 Eaton X115	2.19"	1.50"-12	1.50"				

EATON, MERITOR, SPICER & STD. FORGE 13,000 & 14,000 LB. AXLES



	EUCLID NO.	DESCRIPTION	REPLACES	ACROSS THREAD		WASHERS		
				FLATS	SIZE	THICKNESS	O.D.	I.D.
	E-617	Axle Spindle Lock Washer	Standard Forge 105102 Meritor 1229G709 Trailmobile 37047 Trailmobile 6-5-1 Haldex 65467 Haldex 66108 Leland L210 Dana/Spicer M10HN105			.06"	3"	1.75" x 1.63" "D" Hole
	E-619	Axle Thrust Washer	Standard Forge 105103 Meritor 1229F708 Trailmobile 38874 Trailmobile 6-6-6 Haldex 65468 Haldex 66109 Leland L211 Dana/Spicer M10HN104			.13"	3"	1.75" x 1.63" "D" Hole
	E-618	Axle Spindle Nut	Std Forge 103100001 Meritor 1227H34 Trailmobile 37775 Trailmobile 6-3-3 Haldex 65466 Leland L209 Dana/Spicer M10HN107	2.50"	1.75"-12	.38"		

FRUEHAUF "PRO-PAR" AXLE AND MERITOR EARLY MODEL TP AXLE





	EUCLID NO.	DESCRIPTION	REPLACES	ACROSS THREAD		WASHERS			PIN	
				FLATS	SIZE	THICK	O.D.	I.D.	DIA.	LENGTH
	E-1559	Cotter Pin	Eaton 42204 Haldex 66904 Trailmobile 7007215 Fruehauf AXA000409001 Fruehauf AXA04091 Leland L1762						.25"	1"

TRAILER AXLE SPINDLE HARDWARE

FRUEHAUF "PRO-PAR" AXLE AND MERITOR EARLY MODEL TP AXLE

EUCLID NO.	DESCRIPTION	REPLACES	ACROSS THREAD		WASHERS		PIN		
			FLATS	SIZE	THICK	O.D.	I.D.	DIA.	LENGTH
	E-1561	Axle Spindle Washer	Eaton	42203					
			Haldex	65463					
			Haldex	66102					
			Trailmobile	700715					
			Hendrickson Turner	A26184			.22"	5.06"	3.50"
			Fruehauf	AXA000408001					
			Fruehauf	AXA04081					
			Leland	L1893					
			Leland	L893					
	E-2550	Axle Spindle Nut	Eaton	42202					
			Haldex	66101					
			Trailmobile	700714					
			Hendrickson Turner	A26173	4.75"	3.50"-12	1.13"		
			Fruehauf	ACE008510001					
			Fruehauf	ACE85101					
			Leland	L1395					

MERITOR RL, RN, RQ, TK, TKL, TKN AXLES - "POSITIVE" ADJUSTMENT



EUCLID NO.	DESCRIPTION	REPLACES	ACROSS FLATS	THREAD SIZE	THICKNESS	WASHERS		
						O.D.	I.D.	
	E-3010	Meritor R003010			.06"	4"	2.41"	
	E-1252	Meritor	1229T1996					
		Eaton	42199					
		Haldex	65465					
		Haldex	66122			.38"	3.81"	2.41"
		Trailmobile	700718					
		Navistar	IT12397					
		Leland	L1026					
Leland	L843							
	E-1251	Meritor	1227Z676					
		Eaton	42198					
		Haldex	65464					
		Haldex	66121	3.25"	2.38"16	.38"		
		Trailmobile	700716					
		Navistar	IT12398					
Leland	L840							
	E-1253	Meritor	1227B678					
		Eaton	42201					
		Haldex	66123					
		Navistar	IT12396	3.81"	2.38"16	.50"		
		Leland	L2099					
		Leland	L842					

TRAILER AXLE SPINDLE HARDWARE

MERITOR RL, RN, RQ, TK, TKL, TKN AXLES - "POSITIVE" ADJUSTMENT

	EUCLID NO.	DESCRIPTION	REPLACES	ACROSS FLATS	THREAD SIZE	THICKNESS	WASHERS	
							O.D.	I.D.
	E-2128 ¹	Replacement Service Nut	Meritor 1227S877 Dana/Spicer 12399 Eaton 42200 Haldex 66125 Haldex 66543 Trailmobile 700717 Meritor A1227S877 Leland L1025	3.81"	2.38"-16	.50"		





MERITOR TN, TQ AXLES - "MANUAL" ADJUSTMENT

	EUCLID NO.	DESCRIPTION	REPLACES	ACROSS FLATS	THREAD SIZE	THICKNESS	WASHERS	
							O.D.	I.D.
	E-3008 ²	Lock Washer	Meritor A1229W2545 Leland L3213			.25"	3.88"	2.64"
	E-572	Outer Axle Spindle Nut	Dana/Spicer 10286 Standard Forge 103102001 Dana/Spicer 10408 Meritor 1227B756 Trailmobile 37411 Eaton 42194 Haldex 65336 Haldex 66114 Trailmobile 700713 Eaton 820395 Leland L178 Dana/Spicer M10HN102	3.25"	2.63"-16	.38"		
	E-540	Inner Axle Spindle Nut	Dana/Spicer 10284 Standard Forge 103103002 Meritor 1227C549 GMC 2408341 Trailmobile 39236 Eaton 42196 Haldex 65334 Haldex 66117 Trailmobile 700711 Eaton 820394 Navistar 870813R1 Leland L176 Dana/Spicer M10HN101	3.81"	2.63"-16	.38"		



¹ Used in place of E-1253 to convert to "manual" adjustment.
² Includes E-10793 set screw.

TRAILER AXLE SPINDLE HARDWARE



MERITOR TN, TQ AXLES - "POSITIVE" ADJUSTMENT

	EUCLID NO.	DESCRIPTION	REPLACES	ACROSS FLATS	THREAD SIZE	THICKNESS	WASHERS	
							O.D.	I.D.
	E-7663	Axle Spindle Lock Washer	Meritor A1229X2546 Leland L3236			.23"	3.88"	2.39"
	E-1251	Outer Axle Spindle Nut	Meritor 1227Z676 Eaton 42198 Haldex 65464 Haldex 66121 Trailmobile 700716 Navistar IT12398 Leland L840	3.25"	2.38"-16	.38"		
	E-1253	Inner Axle Spindle Nut	Meritor 1227B678 Eaton 42201 Haldex 66123 Navistar IT12396 Leland L2099 Leland L842	3.81"	2.38"-16	.50"		
	E-2128 ¹	Replacement Service Nut	Meritor 1227S877 Dana/Spicer 12399 Eaton 42200 Haldex 66125 Haldex 66543 Trailmobile 700717 Meritor A1227S877 Leland L1025	3.81"	2.38"-16	.50"		

MERITOR TP AXLE - "MANUAL" ADJUSTMENT

	EUCLID NO.	DESCRIPTION	REPLACES	ACROSS FLATS	THREAD SIZE	THICKNESS	WASHERS	
							O.D.	I.D.
	E-7665 ²	Axle Spindle Lock Washer	Meritor 1229H4584 Leland L3222			.22"	5.06"	3.50"
	E-7666	Outer Axle Spindle Nut	Meritor 1227B1484 Leland L3223	4.38"	3.50"-12	.38"		
	E-7664	Inner Axle Spindle Nut	Meritor 1227K1389 Leland L3221	4.84"	3.50"-12	.38"		



MERITOR TP AXLE - "POSITIVE" ADJUSTMENT

	EUCLID NO.	DESCRIPTION	REPLACES	ACROSS FLATS	THREAD SIZE	THICKNESS	WASHERS	
							O.D.	I.D.
	E-7660 ²	Axle Spindle Lock Washer	Meritor 1229S4179 Leland E7660			.23"	4.75"	3.31"
	E-7659	Axle Spindle Lock Washer	Meritor 1229Y3119 Leland L3216			.28"	5"	3.28"



¹ Used in place of E-1253 to convert to "manual" adjustment.
² Includes E-10793 set screw.

TRAILER AXLE SPINDLE HARDWARE

MERITOR TP AXLE - "POSITIVE" ADJUSTMENT

				WASHERS				
	EUCLID NO.	DESCRIPTION	REPLACES	ACROSS FLATS	THREAD SIZE	THICKNESS	O.D.	I.D.
	E-2303	Inner Axle Spindle Nut	Eaton 119883 Meritor 1227W517 Mack 25QJ35 Eaton 42222 Haldex 66224 Meritor A1227S331 Leland L1355	4.00"	3.25"-12	.38"		
	E-2305	Outer Axle Spindle Nut	Eaton 119881 Meritor 1227R330 Mack 25QJ36 Eaton 42223 Haldex 66226 Leland L1353	4.00"	3.25"-12	.38"		
	E-7658 ⁴	Inner Axle Spindle Nut	Meritor 1227R1240 Leland L3214	4.00"	3.25"-12	.38"		

MERITOR TR AXLE

				WASHERS				
	EUCLID NO.	DESCRIPTION	REPLACES	ACROSS FLATS	THREAD SIZE	THICKNESS	O.D.	I.D.
	E-7660 ²	Axle Spindle Lock Washer	Meritor 1229S4179 Leland E7660			.23"	4.75"	3.31"
	E-2303	Inner Axle Spindle Nut	Eaton 119883 Meritor 1227W517 Mack 25QJ35 Eaton 42222 Haldex 66224 Meritor A1227S331 Leland L1355	4.00"	3.25"-12	.38"		
	E-2305	Outer Axle Spindle Nut	Eaton 119881 Meritor 1227R330 Mack 25QJ36 Eaton 42223 Haldex 66226 Leland L1353	4.00"	3.25"-12	.38"		

MERITOR, EATON, KERSHAW & STD. FORGE 17,000 & 18,000 LB. TRADE AXLES





				WASHERS					
	EUCLID NO.	DESCRIPTION	REPLACES	ACROSS FLATS	THREAD SIZE	THICK	O.D.	I.D.	TAB LENGTH
	E-3009	Axle Spindle Lock Washer	Dana/Spicer 7290			.06"	4.03"	2.64"	.09"

² Includes E-10793 set screw.

⁴ Use E-2303 and E-7660 together in place of E-7658 to convert to manual adjustment.

TRAILER AXLE SPINDLE HARDWARE



MERITOR, EATON, KERSHAW & STD. FORGE 17,000 & 18,000 LB. TRADE AXLES

	EUCLID NO.	DESCRIPTION	REPLACES	ACROSS THREAD		WASHERS			TAB LENGTH
				FLATS	SIZE	THICK	O.D.	I.D.	
	E-2237	Axle Spindle Lock Washer	Standard Forge 105106 Eaton 42197 Leland L1327 Dana/Spicer M10HN151			.06"	4.03"	2.64"	.16"
	E-573 ³	Axle Spindle Lock Washer	Dana/Spicer 10287 Standard Forge 105107 Meritor 1229V1660 Meritor 1229W2545 Trailmobile 39604 Eaton 42195 Haldex 65335 Haldex 66115 Trailmobile 700712 Ford 7EQ1124 Ford 7EQ1124A Eaton 820396 Meritor A1229W2545 Hendrickson Turner A1987 Leland L177 Dana/Spicer M10HN100			.25"	3.94"	2.64"	
	E-572	Outer Axle Spindle Nut	Dana/Spicer 10286 Standard Forge 103102001 Dana/Spicer 10408 Meritor 1227B756 Trailmobile 37411 Eaton 42194 Haldex 65336 Haldex 66114 Trailmobile 700713 Eaton 820395 Leland L178 Dana/Spicer M10HN102	3.25"	2.63"-16	.38"			
	E-540	Inner Axle Spindle Nut	Dana/Spicer 10284 Standard Forge 103103002 Meritor 1227C549 GMC 2408341 Trailmobile 39236 Eaton 42196 Haldex 65334 Haldex 66117 Trailmobile 700711 Eaton 820394 Navistar 870813R1 Leland L176 Dana/Spicer M10HN101	3.81"	2.63"-16	.38"			



³ Used with all Standard Depth Axle Keyway (long hub).

TRAILER AXLE SPINDLE HARDWARE

MERITOR, SPICER & STD. FORGE 11,000 LB. AXLES

	EUCLID NO.	DESCRIPTION	REPLACES	ACROSS FLATS	THREAD SIZE	THICKNESS	WASHERS	
							O.D.	I.D.
	E-1000	Axle Spindle Lock Washer	Standard Forge 105109 Meritor 1229T462 Trailmobile 39969 Trailmobile 6-5-9 Leland L1329 Dana/Spicer M10HN130 Meritor R00100			.06"	2.88"	1.50" x 1.38" "D" Hole
	E-1001	Axle Thrust Washer	Standard Forge 105108 Meritor 1229J712 Trailmobile 37413 Trailmobile 6-6-2 Leland L1330 Dana/Spicer M10HN129			.13"	2.25"	1.50" x 1.38" "D" Hole
	E-1087	Spindle Nut	Standard Forge 103105 Meritor 1227X102 Dana/Spicer 12458 Trailmobile 38506 Trailmobile 6-3-5 Leland L1328 Dana/Spicer M10HN128 Meritor R001087	2.25"	1.50"-12	.28"		



SPICER D21 & D22 AND STD. FORGE A25 & A26 AXLES

	EUCLID NO.	DESCRIPTION	REPLACES	ACROSS FLATS	THREAD SIZE	THICK	WASHERS	
							O.D.	I.D.
	E-2237	Axle Spindle Lock Washer	Standard Forge 105106 Eaton 42197 Leland L1327 Dana/Spicer M10HN151			.06"	4.03"	2.64"
	E-573 ³	Axle Spindle Lock Washer	Dana/Spicer 10287 Standard Forge 105107 Meritor 1229V1660 Meritor 1229W2545 Trailmobile 39604 Eaton 42195 Haldex 65335 Haldex 66115 Trailmobile 700712 Ford 7EQ1124 Ford 7EQ1124A Eaton 820396 Meritor A1229W2545 Hendrickson Turner A1987 Leland L177 Dana/Spicer M10HN100			.25"	3.94"	2.64"

³ Used with all Standard Depth Axle Keyway (long hub).

TRAILER AXLE SPINDLE HARDWARE

SPICER D21 & D22 AND STD. FORGE A25 & A26 AXLES

	EUCLID NO.	DESCRIPTION	REPLACES	ACROSS FLATS	THREAD SIZE	THICK	WASHERS	
							O.D.	I.D.
	E-572	Outer Axle Spindle Nut	Dana/Spicer 10286 Standard Forge 103102001 Dana/Spicer 10408 Meritor 1227B756 Trailmobile 37411	3.25"	2.63"-16	.38"		
			Eaton 42194 Haldex 65336 Haldex 66114 Trailmobile 700713 Eaton 820395 Leland L178 Dana/Spicer M10HN102					
	E-540	Inner Axle Spindle Nut	Dana/Spicer 10284 Standard Forge 103103002 Meritor 1227C549 GMC 2408341 Trailmobile 39236	3.81"	2.63"-16	.38"		
			Eaton 42196 Haldex 65334 Haldex 66117 Trailmobile 700711 Eaton 820394 Navistar 870813R1 Leland L176 Dana/Spicer M10HN101					

STEERING AXLE SPINDLE HARDWARE

For Light, Medium, and Heavy-Duty Trucks



CHEVROLET & GMC F070

	EUCLID NO.	DESCRIPTION	REPLACES	ACROSS FLATS	THREAD SIZE	THICKNESS	WASHERS	
							O.D.	I.D.
	E-4854	Axle Spindle Nut	GMC 3762598 Leland L2590	1.63"	1.13"-16	.75"		

STEERING AXLE SPINDLE HARDWARE

For Light, Medium, and Heavy-Duty Trucks



CHEVROLET & GMC G30, P30, G3500

	EUCLID NO.	DESCRIPTION	REPLACES	ACROSS FLATS	THREAD SIZE	THICKNESS	WASHERS	
							O.D.	I.D.
	E-4879	Thrust Washer	GMC 3936464 Leland L2622			.13"	2.25"	.88"
	E-4865	Axle Spindle Nut	GMC 3953436 Leland L2621	1.25"	.84"-20	.56"		



FORD 5,000 LB. FRONT AXLE

	EUCLID NO.	DESCRIPTION	REPLACES	ACROSS FLATS	THREAD SIZE	THICKNESS	WASHERS	
							O.D.	I.D.
	E-4859	Axle Spindle Nut	Ford 351163S	1.44"	1.00"-14	.63"		

FORD 6,000 LB. FRONT AXLE

	EUCLID NO.	DESCRIPTION	REPLACES	ACROSS FLATS	THREAD SIZE	THICKNESS	WASHERS	
							O.D.	I.D.
	E-4869	Thrust Washer	Ford D5HZ1195C Leland L2615			.19"	3"	1.50"
	E-4861	Axle Spindle Nut	Ford D5HZ3104A Leland L2614	2.25"	1.50"-18	.88"		

MACK FRONT AXLES

	EUCLID NO.	DESCRIPTION	REPLACES	ACROSS FLATS	THREAD SIZE	THICKNESS	WASHERS	
							O.D.	I.D.
	E-3502	Axle Thrust Washer	Mack 35AX1415			.13"	3"	
	E-3501	Axle Spindle Nut	Mack 21AX790	2.63"	1.63"-12	.38"		

NAVISTAR 02109 (DANA FA109) 9,000 LBS.

NAVISTAR 02139 (DANA FA139) 12,000 LBS.

NAVISTAR 02309 (DANA I-90) 9,000 LBS.



NAVISTAR 02329 (DANA I-108) 10,800 LBS.

	EUCLID NO.	DESCRIPTION	REPLACES	ACROSS FLATS	THREAD SIZE	THICKNESS	WASHERS	
							O.D.	I.D.
	E-4871	Lock Washer	Trailmobile 384871 Navistar 470421C1 Leland L2593 Leland L2594			.09"	3.44"	2.09"



STEERING AXLE SPINDLE HARDWARE

For Light, Medium, and Heavy-Duty Trucks

NAVISTAR 02109 (DANA FA109)	9,000 LBS.
NAVISTAR 02139 (DANA FA139)	12,000 LBS.
NAVISTAR 02309 (DANA I-90)	9,000 LBS.
NAVISTAR 02329 (DANA I-108)	10,800 LBS.

				WASHERS				
	EUCLID NO.	DESCRIPTION	REPLACES	ACROSS FLATS	THREAD SIZE	THICKNESS	O.D.	I.D.
	E-6138	Thrust Washer	Navistar 451941C1 Leland L3210			.25"	3.75"	2.09"
	E-4855	Axle Spindle Nut	Navistar 50325R1 Leland L2592	2.88"	2.06"-16	.38"		

NAVISTAR 02109 (DANA FA109)	9,000 LBS.
NAVISTAR 02139 (DANA FA139)	12,000 LBS.
NAVISTAR 02309 (DANA I-90)	9,000 LBS.
NAVISTAR 02329 (DANA I-108)	10,800 LBS.

				WASHERS				
	EUCLID NO.	DESCRIPTION	REPLACES	ACROSS FLATS	THREAD SIZE	THICKNESS	O.D.	I.D.
	E-4871	Lock Washer	Trailmobile 384871 Navistar 470421C1 Leland L2593 Leland L2594			.09"	3.44"	2.09"
	E-6139	Thrust Washer	Navistar 484188C1 Leland L3209			.25"	4.13"	2.09"
	E-4855	Axle Spindle Nut	Navistar 50325R1 Leland L2592	2.88"	2.06"-16	.38"		

NAVISTAR FA48

				WASHERS				
	EUCLID NO.	DESCRIPTION	REPLACES	ACROSS FLATS	THREAD SIZE	THICKNESS	O.D.	I.D.
	E-4875	Thrust Washer	Navistar 97788H Leland L2853			.20"	2.13"	1"

STEERING AXLE SPINDLE HARDWARE

For Light, Medium, and Heavy-Duty Trucks

NAVISTAR FA68, FA72



EUCLID NO.	DESCRIPTION	REPLACES	ACROSS FLATS	THREAD SIZE	THICKNESS	WASHERS	
						O.D.	I.D.
E-4851	Axle Spindle Nut	Navistar 27197H Leland L2584	1.50"	1.00"-14	.88"		

NAVISTAR FA70, FA89, FA91, FA98



EUCLID NO.	DESCRIPTION	REPLACES	ACROSS FLATS	THREAD SIZE	THICKNESS	WASHERS	
						O.D.	I.D.
E-4868	Thrust Washer	Navistar 50764V Leland L2589			.16"	2.63"	1.13"



E-4853	Axle Spindle Nut	Navistar 51207V Leland L2588	1.63"	1.13"-12	.75"		
--------	------------------	---------------------------------	-------	----------	------	--	--

NAVISTAR FA71, FA73, FA101



EUCLID NO.	DESCRIPTION	REPLACES	ACROSS FLATS	THREAD SIZE	THICKNESS	WASHERS	
						O.D.	I.D.
E-4852	Axle Spindle Nut	Navistar 441256C1 Leland L2586	1.63"	1.13"-12	.50"		

MERITOR FD-900, FD-901, FE-900, FF-901, FF931 AXLES



EUCLID NO.	DESCRIPTION	REPLACES	ACROSS FLATS	THREAD SIZE	THICKNESS	WASHERS	
						O.D.	I.D.
E-2298	Spindle Washer	Freightliner 1229F474 Navistar 141131H Trailmobile 21L1332 Eaton 42208 Haldex 66144 Volvo 8060080 Mack 8235-1229F474 Ford 8EB1195 Freightliner TDA 1229F474 Freightliner TDA1229F474 Volvo V8060080			.03", .05"	2.75"	1.53"





E-2297	Axle Spindle Lock Washer	Meritor 1229G475 Navistar 141130H Eaton 42207 Haldex 66143 Ford 8EB3293 Leland L1333			.19"	2.75"	1.53"
--------	--------------------------	---	--	--	------	-------	-------

STEERING AXLE SPINDLE HARDWARE

For Light, Medium, and Heavy-Duty Trucks



MERITOR FD-900, FD-901, FE-900, FF-901, FF931 AXLES

WASHERS

	EUCLID NO.	DESCRIPTION	REPLACES	ACROSS FLATS	THREAD SIZE	THICKNESS	O.D.	I.D.
	E-2296	Outer Axle Spindle Nut	Meritor 1227B106	2.25"	1.50"-12	.44"		
Navistar 141132H								
Eaton 42206								
Haldex 66145								
Leland L1331								
	E-2299	Inner Axle Spindle Nut	Meritor 1227L194	2.63"	1.50"-12	.38"		
Meritor 1227U541								
Eaton 42205								
Meritor A1227A105								
Ford C9HZ3295A								
Leland L1334								



MERITOR FE-970 AND "E" SERIES DRIVE AXLES

WASHERS

	EUCLID NO.	DESCRIPTION	REPLACES	ACROSS FLATS	THREAD SIZE	THICKNESS	O.D.	I.D.
	E-2301	Axle Spindle Lock Washer	Meritor 1229S721	2.88"	2.25"-16	.06"	3.31"	2.25"
Trailmobile 21L1336								
Eaton 42210								
Haldex 66155								
	E-2300	Axle Spindle Nut	Meritor 1227F162	2.88"	2.25"-16	.31"		
Eaton 42209								
Haldex 66154								
Leland L1335								

MERITOR FG-900 AXLE

WASHERS

	EUCLID NO.	DESCRIPTION	REPLACES	ACROSS FLATS	THREAD SIZE	THICKNESS	O.D.	I.D.
	E-2659	Axle Spindle Washer	Meritor 1229J478	2.88"	1.75"-12	.03"	3.25"	1.78"
Haldex 66136								
Leland L1341								
Meritor R002659								
	E-2660	Lock Washer	Meritor 1229H476	2.88"	1.75"-12	.22"	3.00"	1.78"
Haldex 66135								
Leland L1342								
Meritor R002660								
	E-3510	Inner Nut	Meritor A1227C107	2.88"	1.75"-12	.50"	3.31"	
Budd M2549								

STEERING AXLE SPINDLE HARDWARE

For Light, Medium, and Heavy-Duty Trucks

MERITOR FG-900 AXLE



EUCLID NO.	DESCRIPTION	REPLACES	ACROSS FLATS	THREAD SIZE	THICKNESS	WASHERS	
						O.D.	I.D.
E-2658	Outer Axle Spindle Nut	Meritor 1227D108 Haldex 66137 Leland L1340	2.50"	1.75"-12	.69"		

MERITOR 16,000 LB. AXLE



EUCLID NO.	DESCRIPTION	REPLACES	ACROSS FLATS	THREAD SIZE	THICKNESS	WASHERS	
						O.D.	I.D.
E-2659	Axle Spindle Washer	Meritor 1229J478 Haldex 66136 Leland L1341 Meritor R002659			.03"	3.25"	1.78"



E-2660	Lock Washer	Meritor 1229H476 Haldex 66135 Leland L1342 Meritor R002660			.22"	3.00"	1.78"
--------	-------------	---	--	--	------	-------	-------



E-2658	Outer Axle Spindle Nut	Meritor 1227D108 Haldex 66137 Leland L1340	2.50"	1.75"-12	.69"		
--------	------------------------	--	-------	----------	------	--	--

MERITOR FH-901, FL-901, FL-931 AXLES



EUCLID NO.	DESCRIPTION	REPLACES	ACROSS FLATS	THREAD SIZE	THICKNESS	WASHERS	
						O.D.	I.D.
E-2663	Axle Thrust Washer	Meritor 1229C1693 Haldex 66169 Leland L1339			.25"	4.13"	1.78"



E-2662	Axle Spindle Nut	Meritor 1227Y571 Meritor KIT1416 Leland L1338	2.63"	1.75"-12	1.38"		
--------	------------------	---	-------	----------	-------	--	--

DRIVE AXLE SPINDLE HARDWARE

For Light, Medium, and Heavy-Duty Trucks

CHEVROLET & GMC H150





EUCLID NO.	DESCRIPTION	REPLACES	ACROSS FLATS	THREAD SIZE	THICKNESS	WASHERS	
						O.D.	I.D.
E-4873	Lock Washer	GMC 473629 Leland L2595			.06"	3.13"	2.13"



DRIVE AXLE SPINDLE HARDWARE

For Light, Medium, and Heavy-Duty Trucks

CHEVROLET & GMC T150 & T170

	EUCLID NO.	DESCRIPTION	REPLACES	ACROSS FLATS	THREAD SIZE	THICKNESS	WASHERS	
							O.D.	I.D.
	E-4876	Lock Washer	GMC 3874371 Leland L2602			.08"	3.88"	2.50"
	E-4858	Axle Spindle Nut	GMC 3703711 Leland L2601	3.63"	2.50"-16	.38"		

EATON 32M-MR, -34M, -MF, 34D-DT-RT, 17800-17801 SERIES AXLES

	EUCLID NO.	DESCRIPTION	REPLACES	ACROSS FLATS	THREAD SIZE	THICKNESS	WASHERS	
							O.D.	I.D.
	E-2461	Lock Washer	Trailmobile 21L1360 Eaton 30714 Eaton 42228 Ford EQH1124			.13"	4"	2.63"
	E-2462	Inner Axle Spindle Nut	Meritor 1227E1045 Meritor 1227M715 Eaton 19186 Eaton 42226 Eaton 42227 Navistar 67678R1 Ford D74Z4245A Ford D7HZ4245A Leland L1361	3.44"	2.63"-12	.47"		
	E-2460	Drive Axle Spindle Nut	Eaton 34090 Eaton 42229 Navistar 67675R92 Leland L1359	3.50"	2.63"-12	1"		



EATON 38R3, RP-RT, 42R3-RP-RT, 18800, 18801-02-03 SERIES AXLES

	EUCLID NO.	DESCRIPTION	REPLACES	ACROSS FLATS	THREAD SIZE	THICKNESS	WASHERS	
							O.D.	I.D.
	E-2464	Axle Spindle Lock Washer	Eaton 42231 Eaton 90180 Leland L1363			.13"	4.50"	3"



DRIVE AXLE SPINDLE HARDWARE

For Light, Medium, and Heavy-Duty Trucks



EATON 38R3, RP-RT, 42R3-RP-RT, 18800, 18801-02-03 SERIES AXLES

	EUCLID NO.	DESCRIPTION	REPLACES	ACROSS FLATS	THREAD SIZE	THICKNESS	WASHERS	
							O.D.	I.D.
	E-2465	Inner Axle Spindle Nut	Navistar 17903HA	3.81"	3.00"-12	.38"		
Eaton 42230								
Eaton 90229								
Leland L1364								
	E-2463	Outer Axle Spindle Nut	Eaton 31926	3.81"	3.00"-12	1"		
Eaton 42232								
Leland L1362								

EATON 32M-MR, -34M, -MF, 34D-DT-RT, 17800-17801 SERIES AXLES

	EUCLID NO.	DESCRIPTION	REPLACES	ACROSS FLATS	THREAD SIZE	THICKNESS	WASHERS	
							O.D.	I.D.
	E-2467	Axle Spindle Lock Washer	Eaton 11245			.13"	4.75"	3.25"
Eaton 42234								
Leland L1366								
	E-2468	Inner Axle Spindle Nut	Eaton 011249	4.13"	3.25"-12	.50"		
Eaton 42233								
Leland L1367								





FORD 15,000 LB. REAR AXLE

	EUCLID NO.	DESCRIPTION	REPLACES	ACROSS FLATS	THREAD SIZE	THICKNESS	WASHERS	
							O.D.	I.D.
	E-4878	Lock Washer	Ford B6Y1124A			.06"	3"	2"
	E-4862	Axle Spindle Nut	Ford B6Y4252	2.56"	2.00"-16	.31"		
			Leland L2616					
	E-4863	Axle Spindle Nut	Ford D5UZ4255A	2.56"	2.00"-16	2.03"		
			Leland L2618					

DRIVE AXLE SPINDLE HARDWARE

For Light, Medium, and Heavy-Duty Trucks

FORD 18,000 LB. REAR AXLE

	EUCLID NO.	DESCRIPTION	REPLACES	ACROSS FLATS	THREAD SIZE	THICKNESS	WASHERS	
							O.D.	I.D.
	E-2461	Lock Washer	Trailmobile 21L1360 Eaton 30714 Eaton 42228 Ford EQH1124			.13"	4"	2.63"
	E-573 ³	Axle Spindle Lock Washer	Dana/Spicer 10287 Standard Forge 105107 Meritor 1229V1660 Meritor 1229W2545 Trailmobile 39604 Eaton 42195 Haldex 65335 Haldex 66115 Trailmobile 700712 Ford 7EQ1124 Ford 7EQ1124A Eaton 820396 Meritor A1229W2545 Hendrickson Turner A1987 Leland L177 Dana/Spicer M10HN100			.25"	3.94"	2.64"
	E-2462	Inner Axle Spindle Nut	Meritor 1227E1045 Meritor 1227M715 Eaton 19186 Eaton 42226 Eaton 42227 Navistar 67678R1 Ford D74Z4245A Ford D7HZ4245A Leland L1361	3.44"	2.63"-12	.47"		
	E-6142	Axle Spindle Nut	Meritor 1227Z1040 Eaton 42225 Ford D7HZ4255A Leland L2620 Meritor R006142	3.50"	2.63"-12	.38"		

MACK 50,000 LB.



	EUCLID NO.	DESCRIPTION	REPLACES	ACROSS FLATS	THREAD SIZE	THICKNESS	WASHERS	
							O.D.	I.D.
	E-2304	Axle Spindle Lock Washer	Eaton 119882 Meritor 1229U1009 Mack 23QJ201 Eaton 42224 Haldex 66225 Leland L1354			.19"	4.38"	3.25"

³ Used with all Standard Depth Axle Keyway (long hub).

DRIVE AXLE SPINDLE HARDWARE





For Light, Medium, and Heavy-Duty Trucks

MACK 50,000 LB.



				WASHERS				
	EUCLID NO.	DESCRIPTION	REPLACES	ACROSS FLATS	THREAD SIZE	THICKNESS	O.D.	I.D.
	E-2305	Outer Axle Spindle Nut	Eaton 119881	4.00"	3.25"-12	.38"		
			Meritor 1227R330					
			Mack 25QJ36					
			Eaton 42223					
			Haldex 66226					
			Leland L1353					
	E-2303	Inner Axle Spindle Nut	Eaton 119883	4.00"	3.25"-12	.38"		
			Meritor 1227W517					
			Mack 25QJ35					
			Eaton 42222					
			Haldex 66224					
			Meritor A1227S331					
	Leland L1355							

MACK 55,000, 58,000, 65,000 LB.

SW-50C, SW-55C, SW-58C, SW-65C, S-50C, S-55C, S-58C, S-65C

				WASHERS				
	EUCLID NO.	DESCRIPTION	REPLACES	ACROSS FLATS	THREAD SIZE	THICKNESS	O.D.	I.D.
	E-6148	Thrust Washer	Mack 35AX338			.25"	6.38"	4"
	E-6146	Lock Washer	Mack 23QJ117B			.25"	5.25"	3.56"
	E-6147	Axle Spindle Nut	Mack 21AX863	5.25"	3.56"-12	.50"		
	E-6145	Axle Spindle Nut	Mack 25QJ225	5.25"	3.56"-12	.50"		



MACK SW-56C SERIES AXLE

				WASHERS				
	EUCLID NO.	DESCRIPTION	REPLACES	ACROSS FLATS	THREAD SIZE	THICKNESS	O.D.	I.D.
	E-3505	Axle Spindle Lock Washer	Mack 23QJ129			.16"	4.44"	2.89"
			Mack 25QJ125					
			Leland L2375					
	E-6144	Washer	Mack 35AX1411			.25"	4.13"	3.25"



DRIVE AXLE SPINDLE HARDWARE

For Light, Medium, and Heavy-Duty Trucks



MACK SW-56C SERIES AXLE

	EUCLID NO.	DESCRIPTION	REPLACES	ACROSS FLATS	THREAD SIZE	THICKNESS	WASHERS	
							O.D.	I.D.
	E-3504	Inner Axle Spindle Nut	Dana/Spicer 12-443-90 Mack 25QJ168 Leland L2376	4.13"	2.88"-12	.38"		
	E-3506	Outer Axle Spindle Nut	Mack 21AX626 Leland L2378	4.13"	2.88"-12	.38"		

MACK SW-57C SERIES AXLES

	EUCLID NO.	DESCRIPTION	REPLACES	ACROSS FLATS	THREAD SIZE	THICKNESS	WASHERS	
							O.D.	I.D.
	E-3508	Axle Spindle Lock Washer	Mack 23QJ12B Leland L2373			.25"	4.44"	2.95"
	E-3509	Outer Axle Spindle Nut	Mack 21AX335 Leland L2377	4.13"	2.94"-12	.38"		
	E-3507	Inner Axle Spindle Nut	Mack 25QJ13 Leland L2374	4.13"	2.94"-12	.38"		

NAVISTAR 14039 (INTERNATIONAL/DANA F170S)	17,000 LBS.
NAVISTAR 14042 (INTERNATIONAL/DANA J175S)	17,500 LBS.
NAVISTAR 14199 (EATON 16244)	17,500 LBS.
NAVISTAR 14341 (INTERNATIONAL/DANA RA341)	30,000 LBS.

	EUCLID NO.	DESCRIPTION	REPLACES	ACROSS FLATS	THREAD SIZE	THICKNESS	WASHERS	
							O.D.	I.D.
	E-4881	Lock Washer	Navistar 36416HB Leland L2600			.13"	3.75"	2.53"
	E-4857	Axle Spindle Nut	Meritor 1227G709 Navistar 36415HB Leland L2599	3.25"	2.50"-12	.34"		

NAVISTAR 14044 (INTERNATIONAL/DANA J190S)	19,000 LBS.
NAVISTAR 14186 (EATON 17202/22)	19,000 LBS.
NAVISTAR 14351 (INTERNATIONAL/DANA G340S)	34,000 LBS.

	EUCLID NO.	DESCRIPTION	REPLACES	ACROSS FLATS	THREAD SIZE	THICKNESS	WASHERS	
							O.D.	I.D.
	E-4877	Lock Washer	Navistar 470422C1 Leland L2604			.13"	4.06"	2.63"

DRIVE AXLE SPINDLE HARDWARE



For Light, Medium, and Heavy-Duty Trucks

NAVISTAR 14044 (INTERNATIONAL/DANA J190S)	19,000 LBS.
NAVISTAR 14186 (EATON 17202/22)	19,000 LBS.
NAVISTAR 14351 (INTERNATIONAL/DANA G340S)	34,000 LBS.



2

				WASHERS				
EUCLID NO.	DESCRIPTION	REPLACES	ACROSS FLATS	THREAD SIZE	THICKNESS	O.D.	I.D.	
	E-2462	Inner Axle Spindle Nut	Meritor 1227E1045	3.44"	2.63"-12	.47"		
			Meritor 1227M715					
			Eaton 19186					
			Eaton 42226					
			Eaton 42227					
			Navistar 67678R1					
			Ford D74Z4245A					
			Ford D7HZ4245A					
			Leland L1361					

NAVISTAR 14308 (EATON DS402P)	40,000 LBS.
NAVISTAR 14309 (EATON RT402)	40,000 LBS.
NAVISTAR 14342, 14464 (EATON DT401P)	40,000 LBS.
NAVISTAR 14311 (EATON RS460/461)	46,000 LBS.
NAVISTAR 14364 (EATON RS401)	40,000 LBS.
NAVISTAR 14493 (EATON RS341)	34,000 LBS.
NAVISTAR 14494 (EATON RS381/402)	38,000 LBS.
NAVISTAR 14277 (MERITOR U240)	29,000 LBS.
NAVISTAR 14348 (MERITOR SQHD)	38,000 LBS.
NAVISTAR 14338, 14336 (MERITOR SRDD)	44,000 LBS.
NAVISTAR 14368 (MERITOR STDD)	50,000 LBS.

				WASHERS				
EUCLID NO.	DESCRIPTION	REPLACES	ACROSS FLATS	THREAD SIZE	THICKNESS	O.D.	I.D.	
	E-6141	Lock Washer	Navistar 581694C1	4.13"	3.25"-12	.38"		
			Leland L3212					
	E-6140	Axle Spindle Nut	Meritor 1227V464	4.13"	3.25"-12	.38"		
			Navistar 157501R1					
			Leland L3211					

MERITOR "F" SERIES AXLES

				WASHERS				
EUCLID NO.	DESCRIPTION	REPLACES	ACROSS FLATS	THREAD SIZE	THICKNESS	O.D.	I.D.	
	E-2418	Axle Spindle Lock Washer	Meritor 1229C1459	3.50"	2.50"-16	.31"		
			Hallex 66184					
			Leland L1345					
	E-2419	Outer Axle Spindle Nut	Meritor 1227D446	3.50"	2.50"-16	.31"		
			Leland L1344					

DRIVE AXLE SPINDLE HARDWARE

For Light, Medium, and Heavy-Duty Trucks

MERITOR "F" SERIES AXLES



EUCLID NO.	DESCRIPTION	REPLACES
E-2417	Inner Axle Spindle Nut	Meritor 1227U515 Haldex 66182 Leland L1346

WASHERS		ACROSS FLATS	THREAD SIZE	THICKNESS	O.D.	I.D.
		3.50"	2.50"-16	.31"		

MERITOR "H" SERIES AXLES



EUCLID NO.	DESCRIPTION	REPLACES
E-2421	Axle Spindle Lock Washer	Meritor 1229G1021 Eaton 42218 Haldex 66197 Mack E2421 Leland L1348

WASHERS		ACROSS FLATS	THREAD SIZE	THICKNESS	O.D.	I.D.
				.19"	3.75"	2.63"



EUCLID NO.	DESCRIPTION	REPLACES
E-2422	Outer Axle Spindle Nut	Meritor 1227T228 Eaton 42217 Leland L1347

ACROSS FLATS	THREAD SIZE	THICKNESS
3.50"	2.63"-16	.31"



EUCLID NO.	DESCRIPTION	REPLACES
E-2420	Inner Axle Spindle Nut	Meritor 1227T540 Eaton 42216 Haldex 66196 Meritor A1227T540 Leland L1349

ACROSS FLATS	THREAD SIZE	THICKNESS
3.50"	2.63"-16	.31"

MERITOR SPECIAL "H" SERIES AXLES

H-145, H-162, H-172, H-240, H-262, H-362, H-350



EUCLID NO.	DESCRIPTION	REPLACES
E-2421	Axle Spindle Lock Washer	Meritor 1229G1021 Eaton 42218 Haldex 66197 Mack E2421 Leland L1348

WASHERS		ACROSS FLATS	THREAD SIZE	THICKNESS	O.D.	I.D.
				.19"	3.75"	2.63"



EUCLID NO.	DESCRIPTION	REPLACES
E-2462	Inner Axle Spindle Nut	Meritor 1227E1045 Meritor 1227M715 Eaton 19186 Eaton 42226 Eaton 42227 Navistar 67678R1 Ford D74Z4245A Ford D7HZ4245A Leland L1361

ACROSS FLATS	THREAD SIZE	THICKNESS
3.44"	2.63"-12	.47"





EUCLID NO.	DESCRIPTION	REPLACES
E-6142	Axle Spindle Nut	Meritor 1227Z1040 Eaton 42225 Ford D7HZ4255A Leland L2620 Meritor R006142

ACROSS FLATS	THREAD SIZE	THICKNESS
3.50"	2.63"-12	.38"



DRIVE AXLE SPINDLE HARDWARE

For Light, Medium, and Heavy-Duty Trucks

MERITOR "L" SERIES AXLES

	EUCLID NO.	DESCRIPTION	REPLACES	ACROSS FLATS	THREAD SIZE	THICKNESS	WASHERS	
							O.D.	I.D.
	E-2424	Axle Spindle Lock Washer	Meritor 1229R1058	4.00"	3.00"-12	.19"	4.25"	3"
Eaton 42221								
Haldex 66216								
Leland L1351								
	E-2425	Outer Axle Spindle Nut	Meritor 1227H346	4.00"	3.00"-12	.38"		
Eaton 42220								
Haldex 66217								
Leland L1350								
	E-2423	Inner Axle Spindle Nut	Meritor 1227V516	4.00"	3.00"-12	.38"		
Eaton 42219								
Haldex 66215								
Meritor A1227V516								
Leland L1352								

MERITOR "Q" & "R" SERIES AXLES FOR SQHD & R170 DRIVE AXLES

	EUCLID NO.	DESCRIPTION	REPLACES	ACROSS FLATS	THREAD SIZE	THICKNESS	WASHERS	
							O.D.	I.D.
	E-2304	Axle Spindle Lock Washer	Eaton 119882	4.00"	3.25"-12	.19"	4.38"	3.25"
Meritor 1229U1009								
Mack 23QJ201								
Eaton 42224								
Haldex 66225								
Leland L1354								
	E-2305	Outer Axle Spindle Nut	Eaton 119881	4.00"	3.25"-12	.38"		
Meritor 1227R330								
Mack 25QJ36								
Eaton 42223								
Haldex 66226								
Leland L1353								
	E-2303	Inner Axle Spindle Nut	Eaton 119883	4.00"	3.25"-12	.38"		
Meritor 1227W517								
Mack 25QJ35								
Eaton 42222								
Haldex 66224								
Meritor A1227S331								
Leland L1355								

ASSORTMENTS AND DISPLAY BOARDS



Board Size: 24" Wide x 32" High

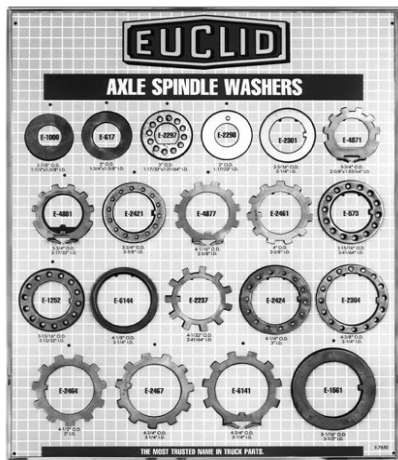

Board Size: 24" Wide x 32" High

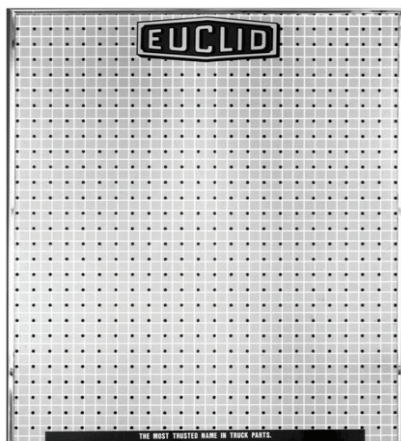

Board Size: 24" Wide x 32" High

SPINDLE NUT ASSORTMENT

EUCLID E-7647

SPINDLE NUTS

WITH FREE DISPLAY BOARD

Features Euclid's most popular Spindle Nuts for medium and heavy-duty trucks.

Included with Display Board are two each of:

EUCLID NO.	OPENING SIZE	EUCLID NO.	OPENING SIZE	EUCLID NO.	OPENING SIZE
E-540	Inner Nut	E-2303	Inner Nut	E-2462	Outer Nut
E-572	Outer Nut	E-2305	Outer Nut	E-2465	Outer Nut
E-618	Nut	E-2417	Inner Nut	E-2468	Outer Nut
E-1087	Nut	E-2419	Outer Nut	E-2550	Nut
E-1251	Outer Nut	E-2420	Inner Nut	E-3504	Inner Nut
E-2128	Service Nut	E-2422	Outer Nut	E-3506	Outer Nut
E-2296	Outer Nut	E-2423	Inner Nut		
E-2299	Inner Nut	E-2425	Outer Nut		

Display Board only E-7648

SPINDLE WASHER ASSORTMENT

EUCLID E-7649

SPINDLE WASHER

WITH FREE DISPLAY BOARD

Features Euclid's most popular Spindle Washers for medium and heavy-duty trucks

Included with Display Board:

QTY.	EUCLID NO.	DESCRIPTION	QTY.	EUCLID NO.	DESCRIPTION
2	E-573	Lockwasher	2	E-2421	Lockwasher
12	E-617	Lockwasher	12	E-2424	Lockwasher
12	E-1000	Lockwasher	12	E-2461	Lockwasher
2	E-1252	Lockwasher	2	E-2464	Lockwasher
2	E-1561	Spindle Washer	2	E-2467	Lockwasher
12	E-2237	Lockwasher	12	E-4871	Lockwasher
2	E-2297	Lockwasher	2	E-4877	Lockwasher
2	E-2298	Spindle Washer	2	E-4881	Lockwasher
2	E-2301	Lockwasher	2	E-6141	Lockwasher
2	E-2304	Lockwasher	2	E-6144	Tab Washer

Display Board only E-7654

UNIVERSAL DISPLAY BOARD

EUCLID E-7657

This Euclid Display Board provides the flexibility to feature specific promotional products, monthly specials, or new products. An assortment of hangers and hooks and two plan-o-grams are included to illustrate how the board may be used.

TRUCK WHEEL BEARING LOCK-NUT WRENCH ASSORTMENTS

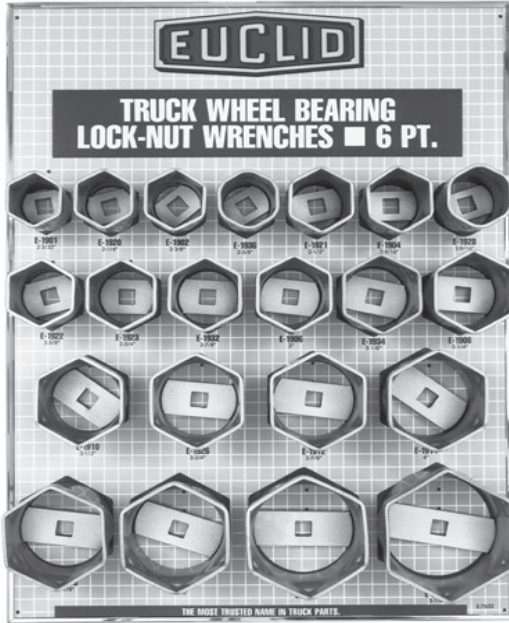

Board Size: 24" Wide x 32" High

6 PT. WRENCH ASSORTMENT

EUCLID E-7651

WHEEL BEARING LOCK-NUT WRENCHES
WITH FREE DISPLAY BOARD

Included with Display Board are one each of the
21 Wrenches listed:

EUCLID NO.	OPENING SIZE	EUCLID NO.	OPENING SIZE	EUCLID NO.	OPENING SIZE
E-1901	2-3/32"	E-1922	2-5/8"	E-1926	3-3/4"
E-1920	2-1/4"	E-1923	2-3/4"	E-1912	3-7/8"
E-1902	2-3/8"	E-1932	2-7/8"	E-1914	4"
E-1936 (1)	2-3/8"	E-1906	3"	E-1915	4-1/8"
E-1921	2-1/2"	E-1934	3-1/8"	E-1916	4-3/8"
E-1904	2-9/16"	E-1908	3-1/4"	E-1918	4-7/8"
E-1928 (1)	2-9/16"	E-1910	3-1/2"	E-3371	5-1/4"

Display Board only E-7652

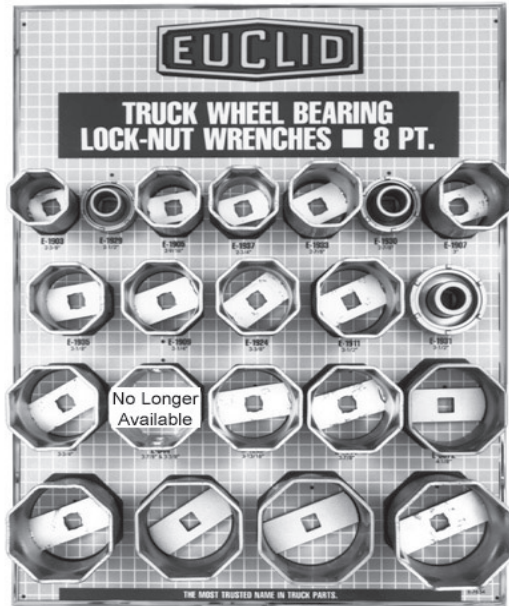

Board Size: 24" Wide x 32" High

8 PT. WRENCH ASSORTMENT

EUCLID E-7653

WHEEL BEARING LOCK-NUT WRENCHES
WITH FREE DISPLAY BOARD

Included with Display Board are one each of the
20 Wrenches listed:

EUCLID NO.	OPENING SIZE	EUCLID NO.	OPENING SIZE	EUCLID NO.	OPENING SIZE
E-1903	2-3/8"	E-1935	3-1/8"	E-1913	3-7/8"
E-1929 (2)	2-1/2"	E-1909	3-1/4"	E-3372	4-1/8"
E-1937	2-3/4"	E-1924	3-3/8"	E-1917	4-3/8"
E-1905	2-9/16"	E-1911	3-1/2"	E-6137	4-1/2"
E-1933	2-7/8"	E-1931 (2)	3-1/2"	E-1597A	4-13/16"
E-1930 (2)	2-7/8"	E-1925	3-3/4"	E-1919	4-7/8"
E-1907	3"	E-1927	3-13/16"		

Display Board only E-7654

(1) Fits special "rounded" hex nuts found on Dana Axles of some Ford Trucks.

(2) Tubular Spanner Wrenches

WHEEL HUB CAPS

GREASE HUB CAP



EUCLID NO.	REPLACES	BOLT CIRCLE DIA.	O.D.	I.D.	BOLT HOLE DIA.	NO. OF BOLT HOLES	COMMENTS
E-975	Trailmobile 19143 Std Forge 304104 Meritor 3262S45 Meritor 3262W1245 Std Forge A170074 Leland L454	5.50"	6.13"	4.50"	.31"	6	Use with E-03009 Gasket

HUB CAP GASKET



EUCLID NO.	BOLT CIRCLE DIA.	O.D.	I.D.	BOLT HOLE DIA.	NO. OF BOLT HOLES
E-03009	5.50"	6.38"	4.42"	.31", .38"	3, 5, 6

HUB CAP FOR FRUEHAUF "PRO-PAR" AXLE



EUCLID NO.	DESCRIPTION	COMMENTS/REPLACES	THREAD SIZE
E-04075V	Vented Hub Cap	For use with non-Fruehauf/Pro-Par axles.	6.25"-8
E-04075	Hub Cap Finished	Fruehauf ACC-007538-900	6.25"-8



E-04075H	Hub Cap	Hub Cap includes O-Ring and Filler Plug. For use with Hubodometers.	6.25"-8
E-04075AH	Hub Cap	Hub Cap includes O-Ring and Filler Plug. For use with Hubodometers. Aluminum Cover.	6.25"-8

HUB CAP O-RING



EUCLID NO.	DESCRIPTION	COMMENTS/REPLACES	O.D.	I.D.
E-05500	Hub Cap O-Ring	Fruehauf AXA-0484-1	6"	5.50"

HUB CAP PLUGS

EUCLID NO.
E-04000
E-04000V

DESCRIPTION
Hub Cap Filler Plug
Vented Hub Cap Filler Plug

COMMENTS/REPLACES
Fruehauf AXA-1005-1
For use with non-Fruehauf/Pro-Par axles.

EUCLID DRIVE AXLE GASKET ASSORTMENT

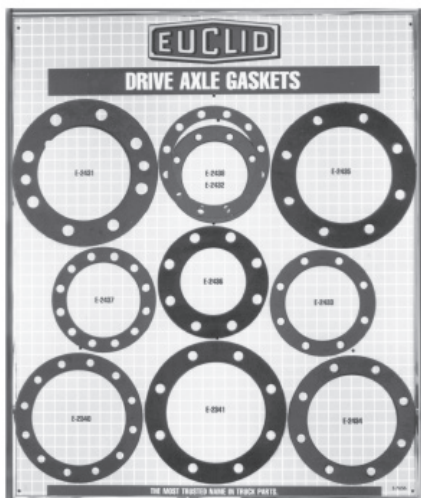

EUCLID E-7655

DRIVE AXLE GASKETS
WITH **FREE** DISPLAY BOARD

Included with Display Board are 25 each of:

E-2340	E-2434
E-2341	E-2435
E-2431	E-2436
E-2432	E-2437
E-2433	E-2438

Display Board only E-7656

DRIVE AXLE FLANGE GASKETS

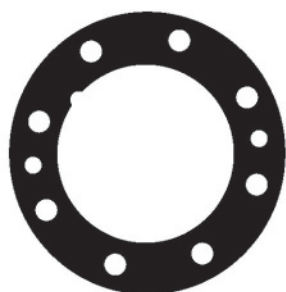

TYPE 1

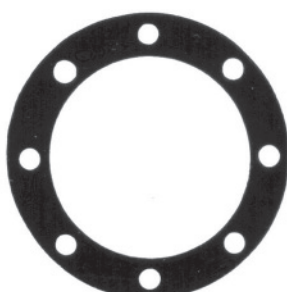

TYPE 2

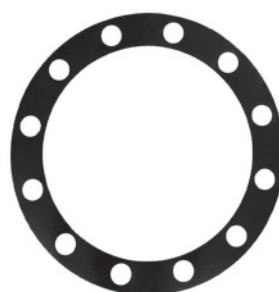

TYPE 3

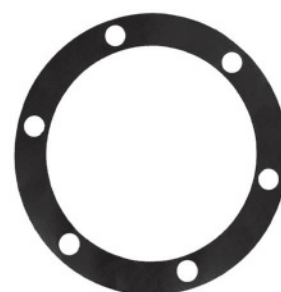

TYPE 4

EUCLID GASKET NO.	TYPE	O.D.	I.D.	BOLT CIRCLE DIA.	BOLT SIZE	NO. OF BOLT HOLES
E-2432	2	5.56"	4.00"	4.75"	.44"	8
E-10237	2	6.00"	4.31"	5.13"	.50"	8
E-2437	3	6.06"	4.50"	5.25"	.56"	12
E-2433	2	6.13"	4.50"	5.28"	.50"	8
E-2436	2	6.44"	4.00"	5.50"	.63"	8
E-2438	3	6.50"	5.00"	5.69"	.44"	12
E-2434	2	7.38"	5.38"	6.38"	.56"	8
E-2340	3	7.44"	5.69"	6.56"	.50"	12
E-2341	2	8.25"	6.00"	7.00"	.63"	8
E-2435	2	8.38"	5.75"	7.00"	.63"	8
E-2431	1	8.50"	5.63"	7.00"	.75"	8
E-10238	4	8.50"	6.44"	7.44"	.69"	6

CROSS REFERENCE LISTING

COMPETITOR NUMBER	COMPETITOR NAME	EUCLID NUMBER	COMPETITOR NUMBER	COMPETITOR NAME	EUCLID NUMBER	COMPETITOR NUMBER	COMPETITOR NAME	EUCLID NUMBER
000207	Reyco	E-2002	03-123399	Paccar	03-123399-002	08-008411	Meritor	E-4956A
011249	Eafon	E-2468	03-123399-002	Trailmobile	03-123399-002	08004350	Dayton-Walther	E-5799
0200572	Paccar	E-5868-L	03-123406	Paccar	03-123406-002	08004350	Meritor	E-5799
0200573	Paccar	E-5868-R	03-123409	Paccar	03-123409-002	08005148	Dayton-Walther	E-4955
0200771	Peterbilt	E-5982-L	03-123409	Trailmobile	03-123409-002	08005148	Meritor	E-4955
0200772	Peterbilt	E-5982-R	03-123420	Paccar	03-123420-002	08005149	Dayton-Walther	E-4962
0201484	Paccar	E-5982-L	03-123427	Paccar	03-123427-002	08005149	Meritor	E-4962
0201485	Paccar	E-5982-R	03-123428	Paccar	03-123428-002	08005716	Meritor	E-4963
02210239	GMC	E-8993-R	03-123428	Trailmobile	03-123428-002	08006654	Dayton-Walther	E-4958
02210240	GMC	E-8993-L	03-123430	Paccar	03-123430-002	08006654	Meritor	E-4958
03-012488	Paccar	03-012488-002	03-123431	Paccar	03-123431-002	08007358	Dayton-Walther	E-5796
03-012582	Paccar	03-012582-002	03-123448	Paccar	03-123448-002	08007358	Meritor	E-5796
03-120376	Paccar	03-120376-002	03-123448-002	Trailmobile	03-123448-002	08007471	Dayton-Walther	E-5955
03-120376-002	Strick	03-120376-002	03-123466	Paccar	03-123466-002	08007471	Meritor	E-5955
03-120442	Paccar	03-120442-002	03-123500	Paccar	03-123500-002	08007591	Meritor	E-11646
03-120459	Paccar	03-120459-002	03-123520	Paccar	03-123520-002	08007775	Dayton-Walther	E-5800
03-120516	Paccar	03-120516-002	03-123538	Paccar	03-123538-002	08007775	Meritor	E-5800
03-120517	Paccar	03-120517-002	03-12480	Paccar	03-012480-002	08008134	Dayton-Walther	E-4945
03-120553	Paccar	03-120553-002	03012480002	Volvo	03-012480-002	08008134	Meritor	E-4945
03-120566	Paccar	03-120566-002	03012582002	Strick	03-012582-002	08008551	Dayton-Walther	E-5954
03-120574	Paccar	03-120574-002	0302207	Paccar	E-5896-R	08008551	Meritor	E-5954
03-120586	Paccar	03-120586-002	0302208	Paccar	E-5896-L	08017000	Hendrickson	E-1828
03-120705	Paccar	03-120705-002	0302852	Peterbilt	E-5983-R	08034396	Dayton-Walther	E-4957
03-120743	Paccar	03-120743-002	0302853	Peterbilt	E-5983-L	08034396	Meritor	E-4957
03-120754	Paccar	03-120754-002	03120574002	Strick	03-120574-002	08201140	Dayton-Walther	E-5970
03-120822	Paccar	03-120822-002	03120586002	Strick	03-120586-002	08201140	Meritor	E-5970
03-120855	Paccar	03-120855-002	03120754002	Strick	03-120754-002	08201500	Dayton-Walther	E-5972
03-120877	Paccar	03-120877-002	03120855002	Volvo	03-120855-002	08201500	Meritor	E-5972
03-120877-002	Strick	03-120877-002	03120936002	Mack	03-120936-002	08201758	Dayton-Walther	E-5796
03-120882	Paccar	03-120882-002	03120981	Paccar	03-120981-002	08201758	Meritor	E-5796
03-120936	Paccar	03-120936-002	03120981002	Volvo	03-120981-002	08201931	Dayton-Walther	E-5970
03-120988	Paccar	03-120988-002	03122104002	Strick	03-122104-002	08201932	Dayton-Walther	E-5972
03-122009	Paccar	03-122009-002	03122455002	Strick	03-122455-002	08201932	Meritor	E-5972
03-122011	Paccar	03-122011-002	03122529002	Freightliner	03-122529-002	08201941	Dayton-Walther	E-5970
03-122027	Paccar	03-122027-002	03122550002	Strick	03-122550-002	08201943	Dayton-Walther	E-5972
03-122078	Paccar	03-122078-002	03122600002	Strick	03-122600-002	08201943	Meritor	E-5972
03-122104	Paccar	03-122104-002	03122607002	Strick	03-122607-002	08203580	Dayton-Walther	E-4957
03-122126	Paccar	03-122126-002	03122683002	Strick	03-122683-002	08203580	Meritor	E-4957
03-122126-002	Strick	03-122126-002	03122947002	Volvo	03-122947-002	08203868	Meritor	E-11647
03-122222	Paccar	03-122222-002	03122948002	Paccar	03-122948-002	08204734	Dayton-Walther	E-5706
03-122222-002	Strick	03-122222-002	03122966002	Paccar	03-122966-002	08204734	Meritor	E-5706
03-122239	Paccar	03-122239-002	03123025002	Volvo	03-123025-002	08205349	Dayton-Walther	E-4956A
03-122290	Paccar	03-122290-002	03123200002	Strick	03-123200-002	08205349	Dayton-Walther	E-5706
03-122314	Paccar	03-122314-002	03123219	Paccar	03-123219-002	08205349	Meritor	E-4956A
03-122453	Paccar	03-122453-002	03123331002	Paccar	03-123331-002	08205373	Meritor	E-11648
03-122455	Paccar	03-122455-002	03123399002	Volvo	03-123399-002	08205435	Meritor	E-11649
03-122488	Paccar	03-122488-002	03123421002	Paccar	03-123421-002	08205575	Meritor	E-11650
03-122513	Paccar	03-122513-002	03123428002	Mack	03-123428-002	08205740	Meritor	E-11651
03-122518	Paccar	03-122518-002	03123520002	Volvo	03-123520-002	08205741	Meritor	E-11652
03-122529	Paccar	03-122529-002	04-15413-003	Paccar	04-15413-003	08205833	Meritor	E-11654
03-122550	Paccar	03-122550-002	04-15413-004	Paccar	04-15413-004	08205895	Meritor	E-11657
03-122561	Paccar	03-122561-002	04-15502-001	Paccar	04-15502-001	08434	Motor Wheel	E-5708
03-122562	Paccar	03-122562-002	04-15502-002	Paccar	04-15502-002	08434S	Motor Wheel	E-5708
03-122575	Paccar	03-122575-002	04-15502-004	Paccar	04-15502-004	09-008422	Meritor	E-5746
03-122600	Paccar	03-122600-002	04-15502-005	Paccar	04-15502-005	09001217	Meritor	E-11695-R
03-122603	Paccar	03-122603-002	04-15502-006	Paccar	04-15502-006	09001218	Meritor	E-11695-L
03-122607	Strick	03-122607-002	04-15502-007	Paccar	04-15502-007	09001254	Meritor	E-11658-R
03-122607-002	Paccar	03-122607-002	04-15502-021	Paccar	04-15502-021	09001255	Meritor	E-11658-L
03-122683	Paccar	03-122683-002	04-15502-022	Paccar	04-15502-022	09001275	Dayton-Walther	E-5902
03-122921	Paccar	03-122921-002	04-15502-029	Paccar	04-15502-029	09001275	Meritor	E-5902
03-122921	Trailmobile	03-122921-002	04-15502-030	Paccar	04-15502-030	09001400	Meritor	E-11721-R
03-122925	Paccar	03-122925-002	04-15502-032	Paccar	04-15502-032	09001401	Meritor	E-11721-L
03-122925	Trailmobile	03-122925-002	04-15502-041	Paccar	04-15502-041	09001525	Meritor	E-11662-R
03-122947	Paccar	03-122947-002	04-15728-002	Paccar	04-15728-002	09001526	Meritor	E-11662-L
03-122948	Paccar	03-122948-002	04-15728-004	Paccar	04-15728-004	09001539	Meritor	E-11664-R
03-122948	Trailmobile	03-122948-002	04-15968-002	Paccar	04-15968-002	09001540	Meritor	E-11664-L
03-122963	Paccar	03-122963-002	04-15968-007	Paccar	04-15968-007	09001555	Meritor	E-11665-R
03-122964	Paccar	03-122964-002	04-15968-009	Paccar	04-15968-009	09001556	Meritor	E-11665-L
03-122964	Trailmobile	03-122964-002	04-15968-045	Paccar	04-15968-045	09001614	Meritor	E-11666-R
03-122966	Paccar	03-122966-002	04-15981-016	Paccar	04-15981-016	09001615	Meritor	E-11666-L
03-122971	Paccar	03-122971-002	04-15981-017	Paccar	04-15981-017	09001650	Meritor	E-11667-R
03-122978	Paccar	03-122978-002	04-15981-018	Paccar	04-15981-018	09001651	Meritor	E-11667-L
03-123020	Paccar	03-123020-002	04-15981-019	Paccar	04-15981-019	09001652	Meritor	E-11668-R
03-123020-002	Paccar	03-123020-002	04-15984-001	Paccar	04-15984-001	09001653	Meritor	E-11668-L
03-123024	Paccar	03-123024-002	04-15984-002	Paccar	04-15984-002	09001668	Meritor	E-11696-R
03-123025	Paccar	03-123025-002	04-15984-003	Paccar	04-15984-003	09001669	Meritor	E-11696-L
03-123200	Paccar	03-123200-002	04-15984-004	Paccar	04-15984-004	09001727	Meritor	E-11701
03-123200	Trailmobile	03-123200-002	04-15984-005	Paccar	04-15984-005	09001728	Meritor	E-11702
03-123207	Paccar	03-123207-002	04-15984-006	Paccar	04-15984-006	09001740	Dayton-Walther	E-9837
03-123207-002	Strick	03-123207-002	04-15984-007	Paccar	04-15984-007	09001740	Meritor	E-9837
03-123219	Paccar	03-123219-002	04-15984-010	Paccar	04-15984-010	09001763	Meritor	E-11669-R
03-123254	Paccar	03-123254-002	04-15984-012	Paccar	04-15984-012	09001764	Meritor	E-11669-L
03-123254-002	Strick	03-123254-002	04-15984-036	Paccar	04-15984-036	09001811	Meritor	E-11703
03-123276	Paccar	03-123276-002	04-15984-041	Paccar	04-15984-041	09001825	Meritor	E-11704
03-123297	Paccar	03-123297-002	04-15984-042	Paccar	04-15984-042	09001826	Meritor	E-11705
03-123302	Paccar	03-123302-002	0414131	Dayton-Walther	04-15502-021	09001827	Meritor	E-11722-R
03-123331	Paccar	03-123331-002	0415502001	Strick	04-15502-001	09001828	Meritor	E-11722-L
03-123332	Paccar	03-123332-002	0415984001	Volvo	04-15984-001	09001853	Meritor	E-11706
03-123365	Paccar	03-123365-002	04842000	Hendrickson	E-1835	09001855	Meritor	E-11707
03-123365-002	Strick	03-123365-002	05203868	Meritor	E-11647	09001910	Meritor	E-11672-R
03-123366	Paccar	03-123366-002	059190	Webb	E-9011-R	09001911	Meritor	E-11672-L
03-123382	Paccar	03-123382-002	06605	Motor Wheel	E-5708	09001914	Meritor	E-11692
03-123383	Paccar	03-123383-002	07652	Motor Wheel	E-5710	09001925	Meritor	E-11697-R
03-123396	Paccar	03-123396-002	07652A	Motor Wheel	E-5710	09001926	Meritor	E-11697-L
03-123397	Paccar	03-123397-002	07669	Motor Wheel	E-5711	09001958	Meritor	E-11708
03-123398	Paccar	03-123398-002	07669S	Motor Wheel	E-5711	09001962	Meritor	E-11693

Not an exact match. Quality level or bill of materials may differ between the Euclid and competitors part. Refer to Euclid catalog for complete information on Euclid Parts.

CROSS REFERENCE LISTING

COMPETITOR NUMBER	COMPETITOR NAME	EUCLID NUMBER	COMPETITOR NUMBER	COMPETITOR NAME	EUCLID NUMBER	COMPETITOR NUMBER	COMPETITOR NAME	EUCLID NUMBER
09001964	Meritor	E-11709	09870917	Meritor	E-5785A	10286	Dana/Spicer	E-572
09001965	Meritor	E-11673-R	09885310	Dayton-Walther	E-5926	10287	Dana/Spicer	E-573
09001966	Meritor	E-11673-L	09885310	Meritor	E-5926	1030001	World Truck	E-5970
09001982	Meritor	E-11674-R	09890817	Dayton-Walther	E-5784A	1030002	World Truck	E-5970
09001983	Meritor	E-11674-L	09890817	Meritor	E-5784A	1030003	World Truck	E-5971
09001984	Meritor	E-11675-R	100012	Conmet	E-6026-L	1030004	World Truck	E-5972
09001985	Meritor	E-11675-L	100012L	Conmet	E-6026-L	103100001	Standard Forge	E-618
09001988	Meritor	E-11710	100013	Conmet	E-6026-R	103100001	Std. Forge	E-618
09001989	Dayton-Walther	E-9837	10001399	Conmet	E-6035	103102001	Standard Forge	E-572
09001989	Meritor	E-9837	100013R	Conmet	E-6026-R	103102001	Std. Forge	E-572
09001990	Meritor	E-11712	100017	Budd	E-6033-R	103103002	Standard Forge	E-540
09001991	Meritor	E-11676-R	100018	Budd	E-6033-L	103103002	Std. Forge	E-540
09001992	Meritor	E-11676-L	10003830A	Conmet	E-12523	103105	Standard Forge	E-1087
09001995	Meritor	E-11677-R	100117	Conmet	E-6023-R	103105	Std. Forge	E-1087
09001996	Meritor	E-11677-L	100118	Conmet	E-6023-L	103189	Conmet	E-10227-L
09001997	Meritor	E-11659-R	100145	Budd	E-8947-R	103190	Conmet	E-10227-R
09001998	Meritor	E-11659-L	100146	Budd	E-8947-L	103191	Conmet	E-10228-L
09001999	Meritor	E-11699-R	100148	Conmet	E-8950-R	103192	Conmet	E-10228-R
09002000	Meritor	E-11699-L	100149	Conmet	E-8950-L	103193	Conmet	E-10222
09002001	Meritor	E-11713	100163	Webb	E-9008-L	103426	Fruehauf	E-2306
09002002	Meritor	E-11714	100164	Webb	E-9008-R	103431	Conmet	E-10223
09002003	Meritor	E-11715	100170	Webb	E-6033-R	10406	Dana/Spicer	E-540
09002004	Meritor	E-11716	100181	Webb	E-6033-L	10408	Dana/Spicer	E-572
09002005	Meritor	E-11717	100225	Conmet	E-6028-R	105102	Standard Forge	E-617
09002013	Meritor	E-11718	100226	Conmet	E-6028-L	105102	Std. Forge	E-617
09002021	Meritor	E-11684-R	100254	Conmet	E-6027-R	105103	Standard Forge	E-619
09002022	Meritor	E-11684-L	100255	Conmet	E-6027-L	105103	Std. Forge	E-619
09002023	Meritor	E-11685-R	100256	Conmet	E-6024-R	105106	Standard Forge	E-2237
09002024	Meritor	E-11685-L	100257	Conmet	E-6024-L	105106	Std. Forge	E-2237
09002025	Meritor	E-11686-R	100264	Conmet	E-8950-L	105107	Standard Forge	E-573
09002026	Meritor	E-11686-L	100265	Conmet	E-8950-R	105107	Std. Forge	E-573
09002027	Meritor	E-11687-R	100329	Conmet	E-10200-R	105108	Standard Forge	E-1001
09002028	Meritor	E-11687-L	100330	Conmet	E-10200-L	105108	Std. Forge	E-1001
09002047	Meritor	E-11660-R	100343	Conmet	E-8951-L	105109	Standard Forge	E-1000
09002048	Meritor	E-11660-L	100344	Conmet	E-8951-R	105109	Std. Forge	E-1000
09002049	Meritor	E-11661-R	100368	Conmet	E-6058-L	105345	Budd	E-9805
09002050	Meritor	E-11661-L	100369	Conmet	E-6058-R	105417	Budd	E-4229
09002073	Meritor	E-11724	100370	Conmet	E-6059-L	105424	Budd	E-9805
09002082	Meritor	E-11723-R	100371	Conmet	E-6059-R	105425	Budd	E-4229
09002083	Meritor	E-11723-L	100372	Conmet	E-6028-L	105988	Webb	E-5988-R
09002085	Meritor	E-11678-R	100372/3	Conmet	E-6028-R	105989	Webb	E-5988-L
09002086	Meritor	E-11678-L	100372/3	Conmet	E-6028-R	106201	Budd	E-8949-R
09002140	Meritor	E-11725	100373	Conmet	E-6028-R	106202	Budd	E-8949-L
09002184	Meritor	E-11719	100383	Conmet	E-5872	106216	Budd	E-5997
09002204	Meritor	E-11682-R	100524	Conmet	E-5989-L	106333	Budd	E-6000A
09002205	Meritor	E-11682-L	100524/5	Conmet	E-5929-R	106377	Budd	E-5998
09002210	Meritor	E-11681-R	100525	Conmet	E-5989-R	106397	Budd	E-5999
09002211	Meritor	E-11681-L	100526	Conmet	E-5930-R	10708	Budd	E-7895-R
09006256	Dayton-Walther	E-5827	100858006	Eaton	E-6033-L	107080	Webb	E-7895-R
09006256	Meritor	E-5827	100858010	Eaton	E-6033-R	107082	Webb	E-7895-R
09006257	Dayton-Walther	E-5828	101150	Conmet	E-6030A	107083	Webb	E-7895-L
09006257	Meritor	E-5828	101151	Conmet	E-6029A	10709	Budd	E-7895-L
09006302	Dayton-Walther	E-5829	101160	Webb	E-6034	107091	Webb	E-7895-L
09006302	Meritor	E-5829	101161	Webb	E-9526	107150	Conmet	85-123207-002
09007295	Dayton-Walther	E-5838	101162	Webb	E-6035	107164	Conmet	85-123448-002
09007295	Gunite	E-5838	101164	Webb	E-6036	107193	Conmet	03-123399-002
09007295	Meritor	E-5838	101166	Webb	E-9009	107453	Conmet	85-123383-002
09007564	Dayton-Walther	E-5976	101170	Webb	E-9523-R	107637	Conmet	85-123520-002
09007564	Meritor	E-5976	101171	Conmet	E-6001A	107638	Conmet	85-123570-002
09007587	Dayton-Walther	E-5927	101171	Webb	E-9523-L	107863	Conmet	85-123465-002
09007587	Meritor	E-5927	101172	Webb	E-9010-R	107866	Conmet	85-123466-002
09541417	Dayton-Walther	E-5570	101173	Webb	E-9010-L	107875	Conmet	85-123409-002
09541417	Meritor	E-5570	101174	Webb	E-9524-R	107885	Conmet	85-123397-002
09604017	Dayton-Walther	E-5044	101175	Webb	E-9524-L	107904	Conmet	85-122550-002
09604017	Meritor	E-5044	101178	Webb	E-9525-R	1080001	World Truck	E-4989
09604317	Dayton-Walther	E-5839	101179	Webb	E-9525-L	1080002	World Truck	E-5761
09604317	Gunite	E-5839	101191	Webb	E-10242	10820001	World Truck	E-5012
09604317	Meritor	E-5839	101250	Conmet	04-15984-001	10820003	World Truck	E-5712
09612317	Dayton-Walther	E-5571A	101251	Conmet	04-15984-001	1093772	Volvo	03-123024-002
09612317	Meritor	E-5571A	101265	Conmet	04-15502-021	1096070	Freightliner	E-5990-R
09623517	Dayton-Walther	E-5572A	101266	Conmet	04-15502-021	109607000	Freightliner	E-5990-R
09623517	Meritor	E-5572A	101301	Webb	E-5589-L	109607001	Freightliner	E-5990-L
09658417	Dayton-Walther	E-5045	101302	Webb	E-5589-R	1096071	Freightliner	E-5990-L
09658417	Meritor	E-5045	101321	Budd	E-8948-R	1100002	World Truck	E-5926
09699317	Dayton-Walther	E-5040A	101322	Budd	E-8948-L	1100003	World Truck	E-5927
09699317	Meritor	E-5040A	10164	Webb	E-6036	1100004	World Truck	E-5746
09705317	Dayton-Walther	E-5785A	101773	Conmet	E-8952-L	1100005	World Truck	E-5838
09717110	Dayton-Walther	E-5046	101774	Conmet	E-8952-R	1100006	World Truck	E-5570
09717110	Meritor	E-5046	101873	Conmet	E-10225-L	1100007	World Truck	E-5571A
09717510	Dayton-Walther	E-5047	101874	Conmet	E-10225-R	1100008	World Truck	E-5046
09717510	Meritor	E-5047	102033	Conmet	E-10218	1100009	World Truck	E-5047
09839910	Dayton-Walther	E-5927	102084	Conmet	E-10226-L	1100010	World Truck	E-5784A
09839910	Meritor	E-5927	102085	Conmet	E-10226-R	1100011	World Truck	E-5040A
09853601	Dayton-Walther	E-4966-R	102188	Conmet	E-10215	1100012	World Truck	E-5045
09853601	Meritor	E-4966-R	102189	Conmet	E-10216	1100013	World Truck	E-5044
09853602	Dayton-Walther	E-4966-L	102190	Conmet	E-10217	1100014	World Truck	E-5572A
09853602	Meritor	E-4966-L	102277	Conmet	E-10209-L	1100016	World Truck	E-5839
09861901	Dayton-Walther	E-8958-R	102278	Conmet	E-10209-R	1100017	World Truck	E-5785A
09861901	Meritor	E-8958-R	102279	Conmet	E-10208-L	1100018	World Truck	E-5827
09861902	Dayton-Walther	E-8958-L	102280	Conmet	E-10208-R	1100019	World Truck	E-5883
09861902	Meritor	E-8958-L	102281	Conmet	E-10210-L	1100019R	Navistar	E-5748-L
09869701	Meritor	E-11680-R	102282	Conmet	E-10210-R	1100020	World Truck	E-5829
09869702	Meritor	E-11680-L	102290	Conmet	E-10219	1100021	World Truck	E-5828
09870817	Dayton-Walther	E-5784A	102291	Conmet	E-10220	1100021R	Navistar	E-5748-R
09870817	Meritor	E-5784A	102292	Conmet	E-10221	1102001	World Truck	E-5573
09870917	Dayton-Walther	E-5785A	10284	Dana/Spicer	E-540	1102016	World Truck	E-5747

Not an exact match. Quality level or bill of materials may differ between the Euclid and competitors part. Refer to Euclid catalog for complete information on Euclid Parts.

CROSS REFERENCE LISTING

COMPETITOR NUMBER	COMPETITOR NAME	EUCLID NUMBER	COMPETITOR NUMBER	COMPETITOR NAME	EUCLID NUMBER	COMPETITOR NUMBER	COMPETITOR NAME	EUCLID NUMBER
1103001	World Truck	E-5841	12-429	Dana/Spicer	E-2302	12416	Dana/Spicer	E-2425
1104001	World Truck	E-5885	12-430	Dana/Spicer	E-2661	12417	Dana/Spicer	E-2303
1105001	World Truck	E-5036	12-443-90	Dana/Spicer	E-3504	12418	Dana/Spicer	E-2304
1105003	World Truck	E-5902	12247	Budd	E-5558-L	12419	Dana/Spicer	E-2305
1105004	World Truck	E-5889	12247	Budd	E-5558-R	12423	Dana/Spicer	E-2299
1105005	World Truck	E-5890	12247/48	Budd	E-5558-R	12424	Dana/Spicer	E-2297
1105006	World Truck	E-5891	12247/48	Budd	E-5558-R	12426	Dana/Spicer	E-2296
1105007	World Truck	E-5754	122478	Budd	E-5558-R	12427	Dana/Spicer	E-2300
1105008	World Truck	E-5974	12248	Budd	E-5558-L	12428	Dana/Spicer	E-2301
1105009	World Truck	E-5905A	122729	Dayton-Walther	23-122729-002	12430	Dana/Spicer	E-3510
1105010	World Truck	E-5904A	122729	Dayton-Walther	E-4230	12431	Dana/Spicer	E-2660
1105011	World Truck	E-5906	1227B106	Meritor	E-2296	12432	Dana/Spicer	E-2659
1105013	World Truck	E-5753	1227B1484	Meritor	E-7666	12433	Dana/Spicer	E-2658
1105014	World Truck	E-5837	1227B678	Meritor	E-1253	12434	Dana/Spicer	E-2462
1105016	World Truck	E-5778	1227B756	Meritor	E-572	12435	Dana/Spicer	E-2461
1105017	World Truck	E-5782	1227C549	Meritor	E-540	12436	Dana/Spicer	E-2460
1105021	World Truck	E-5041	1227D108	Meritor	E-2658	12437	Dana/Spicer	E-2465
1106001	World Truck	E-6053	1227D446	Meritor	E-2419	12438	Dana/Spicer	E-2464
1106002	World Truck	E-5882	1227E1045	Meritor	E-2462	12439	Dana/Spicer	E-2463
1106003	World Truck	E-5823	1227F162	Meritor	E-2300	12440	Dana/Spicer	E-2468
1106004	World Truck	E-5822	1227G709	Meritor	E-4857	12441	Dana/Spicer	E-2467
1106005	World Truck	E-5820	1227H34	Meritor	E-618	12443	Dana/Spicer	E-3504
1106006	World Truck	E-5781	1227H346	Meritor	E-2425	12444	Dana/Spicer	E-3505
1106007	World Truck	E-5821	1227K1389	Meritor	E-7664	12445	Dana/Spicer	E-3506
1106008	World Truck	E-5783	1227L194	Meritor	E-2299	12448	Dana/Spicer	E-2662
1106012	World Truck	E-5055	1227M715	Meritor	E-2462	12449	Dana/Spicer	E-2663
1106013	World Truck	E-5780	1227R1240	Meritor	E-7658	12450	Dana/Spicer	E-3507
1107001	World Truck	E-6054	1227R330	Meritor	E-2305	12451	Dana/Spicer	E-3508
1107002	World Truck	E-5755	1227S877	Meritor	E-2128	12452	Dana/Spicer	E-3509
1108001	World Truck	E-5840	1227T228	Meritor	E-2422	12452001L	Paccar	E-5983-L
1109001	World Truck	E-5825	1227T540	Meritor	E-2420	12452001R	Paccar	E-5983-R
1109002	World Truck	E-5824	1227U515	Meritor	E-2417	12453	Dana/Spicer	E-3501
1109003	World Truck	E-5953	1227U541	Meritor	E-2299	12454	Dana/Spicer	E-3502
1109005	World Truck	E-5973	1227V464	Meritor	E-6140	12458	Dana/Spicer	E-1087
1109008	World Truck	E-5976	1227V516	Meritor	E-2423	12459	Dana/Spicer	E-1000
11108390	Freightliner	E-6058-L	1227W517	Meritor	E-2303	12460	Dana/Spicer	E-1001
11108391	Freightliner	E-6058-R	1227X102	Meritor	E-1087	12461	Dana/Spicer	E-618
11108392	Freightliner	E-6059-L	1227Y571	Meritor	E-2662	12462	Dana/Spicer	E-617
11108393	Freightliner	E-6059-R	1227Z1040	Meritor	E-6142	12463	Dana/Spicer	E-619
111428H	Navistar	E-5798	1227Z676	Meritor	E-1251	1246A1171	Meritor	E-5740
11245	Eaton	E-2467	1229B3122	Meritor	E-7662	1246B28	Meritor	E-5957
11249	Eaton	E-2468	1229C1459	Meritor	E-2418	1246D290	Meritor	E-5960
115135H	Navistar	E-2431	1229C1693	Meritor	E-2663	1246L350	Meritor	E-10236
1164301	Reyco	E-1828	1229F708	Meritor	E-619	1246T306	Meritor	E-5740
1191797	Chrysler	E-5740	1229G1021	Meritor	E-2421	1246V1166	Meritor	E-5960
1191846	Chrysler	E-5718-R	1229G475	Meritor	E-2297	1246X232	Meritor	E-5737
1191847	Chrysler	E-5718-L	1229G709	Meritor	E-617	1246Y233	Meritor	E-5743
119345H	Navistar	E-5800	1229H1568	Meritor	E-2302	1246Z1170	Meritor	E-5737
1197140	Freightliner	E-5933-L	1229H4584	Meritor	E-7665	1246Z234	Meritor	E-5952
1197140	Freightliner	E-5933-R	1229H476	Meritor	E-2660	12547785	GMC	E-11307
119714006	Freightliner	E-10200-L	1229J478	Meritor	E-2659	125629	Gunite	E-5008
119714007	Freightliner	E-10200-R	1229J712	Meritor	E-1001	1267751	Chrysler	E-2435
1197141	Freightliner	E-5933-L	1229R1058	Meritor	E-2424	1267752	Chrysler	E-5960
1197141	Freightliner	E-5933-R	1229S4179	Meritor	E-7660	1270823	Chrysler	E-5743
11971411	Freightliner	E-5931-L	1229S721	Meritor	E-2301	1272771	Chrysler	E-4988-L
11971411	Freightliner	E-5931-R	1229T1996	Meritor	E-1252	1272772	Chrysler	E-4988-R
11971412	Freightliner	E-5931-L	1229T462	Meritor	E-1000	129300R1	Navistar	E-5554-L
11971412	Freightliner	E-5931-R	1229U1009	Meritor	E-2304	129301R1	Navistar	E-5554-R
11971413	Freightliner	E-5930-L	1229V1660	Meritor	E-573	129302R1	Navistar	E-7897-L
11971414	Freightliner	E-5930-L	1229W2545	Meritor	E-573	129303R1	Navistar	E-7897-R
11971414	Freightliner	E-5930-R	1229Y3119	Meritor	E-7659	12AK2189	Mack	E-5746
11971415	Freightliner	E-5929-L	123493DTN	Paccar	03-123493-002	13-123219	Paccar	13-123219-002
11971415	Freightliner	E-5930-R	123550MH	Bendix	E-11470	13-123219-002	Paccar	13-123219-002
11971416	Freightliner	E-5929-L	123552MH	Bendix	E-12523	13-123302	Paccar	13-123302-002
11971416	Freightliner	E-5929-R	123572MH	Bendix	E-6115	1300	Webb	04-15502-021
1197142	Freightliner	E-5932-L	12361076	GMC	E-11308	13096	Budd	E-5556-R
1197142	Freightliner	E-5932-R	12386617	GMC	E-8969-L	13096/97	Budd	E-5556-R
1197143	Freightliner	E-5932-L	12386682	GMC	E-11310	130967	Budd	E-5556-R
1197143	Freightliner	E-5932-R	12386685	GMC	E-11313	1309697	Budd	E-5556-R
1197144	Freightliner	E-5989-R	12386716	GMC	E-11327	13097	Budd	E-5556-L
1197145	Freightliner	E-5989-L	12386718	GMC	E-11125	130SP19	Mack	E-2431
1197146	Freightliner	E-10200-L	12388047	GMC	E-11311	131281R1	Navistar	E-5911-L
1197147	Freightliner	E-10200-R	12391	Dana/Spicer	E-540	131282R1	Navistar	E-5911-R
119881	Eaton	E-2305	12392	Dana/Spicer	E-573	131SP31	Mack	E-2435
119882	Eaton	E-2304	12393	Dana/Spicer	E-572	131SP47	Mack	E-2438
119883	Eaton	E-2303	12394	Dana/Spicer	E-2237	131SP59	Mack	E-2340
1199-Y-1351	Meritor	E-5576-L	12396	Dana/Spicer	E-1253	1320	Webb	04-15502-002
1199B1432	Meritor	E-6060-R	12397	Dana/Spicer	E-1252	1320	Webb	04-15502-021
1199B2160	Meritor	E-5710	12398	Dana/Spicer	E-1251	132896H1	Navistar	E-5957
1199C1433	Meritor	E-6060-L	12399	Dana/Spicer	E-2128	1330001	World Truck	E-5961
1199F968	Meritor	E-7897-R	1238	HDA	E-5571A	1330003	World Truck	E-5962
1199G111	Meritor	E-5652-L	12400	Dana/Spicer	E-2550	1330004	World Truck	E-5963
1199G969	Meritor	E-7897-L	12402	Dana/Spicer	E-1561	1330005	World Truck	E-2002
1199H112	Meritor	E-5652-R	12403	Dana/Spicer	E-1559	1330006	World Truck	E-5964
1199J114	Meritor	E-7895-R	12404	Dana/Spicer	E-576	13310001	World Truck	E-4961A
1199K115	Meritor	E-7895-L	12405	Dana/Spicer	E-620	13310002	World Truck	E-1835
1199M117	Meritor	E-5977-L	12406	Dana/Spicer	E-2306	13310003	World Truck	E-1828
1199N118	Meritor	E-5977-R	12407	Dana/Spicer	E-540	1331001L	World Truck	E-7895-L
1199Q1811	Meritor	E-5579-L	12408	Dana/Spicer	E-2417	1331001R	World Truck	E-7895-R
1199R1812	Meritor	E-5579-R	12409	Dana/Spicer	E-2418	1331002L	World Truck	E-7896-L
1199R616	Meritor	E-5711	12410	Dana/Spicer	E-2419	1331002R	World Truck	E-7896-R
1199V1348	Meritor	E-7898-R	12411	Dana/Spicer	E-2420	1331003L	World Truck	E-7897-L
1199W1349	Meritor	E-7898-L	12412	Dana/Spicer	E-2421	1331003R	World Truck	E-7897-R
11BMT148	Mack	E-5957	12413	Dana/Spicer	E-2422	1331004L	World Truck	E-7898-L
11CG198	Mack	E-2434	12414	Dana/Spicer	E-2423	1331004R	World Truck	E-7898-R
11EHT31	Mack	E-5952	12415	Dana/Spicer	E-2424	13311001	World Truck	E-5032

Not an exact match. Quality level or bill of materials may differ between the Euclid and competitors part. Refer to Euclid catalog for complete information on Euclid Parts.

CROSS REFERENCE LISTING

COMPETITOR NUMBER	COMPETITOR NAME	EUCLID NUMBER	COMPETITOR NUMBER	COMPETITOR NAME	EUCLID NUMBER	COMPETITOR NUMBER	COMPETITOR NAME	EUCLID NUMBER
13311002	World Truck	E-5008	141489	Bendix	E-9807	1541201L	World Truck	E-5748-L
13311003	World Truck	E-5007	141490	Bendix	E-9808	1541201R	World Truck	E-5748-R
13312002	World Truck	E-4962	141494	Bendix	E-4247	1541202L	World Truck	E-5749-L
13312003	World Truck	E-4963	1415502050	Paccar	14-15502-050	1541202R	World Truck	E-5749-R
1332003L	World Truck	E-5978-L	141583	Bendix	E-9805	1541203L	World Truck	E-5750-L
1332003R	World Truck	E-5978-R	141584	Bendix	E-4229	1541203R	World Truck	E-5750-R
1332004L	World Truck	E-5988-L	141585	Bendix	E-9804	1541204L	World Truck	E-5868-L
1332004R	World Truck	E-5988-R	141606	Bendix	E-4246	1541204R	World Truck	E-5868-R
1333001L	World Truck	E-5977-L	141607	Bendix	23-122729-002	1541205L	World Truck	E-5897-L
1333001R	World Truck	E-5977-R	141607	Bendix	E-4230	1541205R	World Truck	E-5897-R
1333003L	World Truck	E-5996-L	141627	Bendix	E-4242	1541206L	World Truck	E-5899-L
1333003R	World Truck	E-5996-R	141629	Bendix	E-4240	1541206R	World Truck	E-5899-R
1333004L	World Truck	E-5554-L	141730	Bendix	E-9817	1541207L	World Truck	E-5898-L
1333004R	World Truck	E-5554-R	141856	Bendix	E-8903	1541207R	World Truck	E-5898-R
1333005L	World Truck	E-5995-L	141874	Bendix	E-9809	1541208L	World Truck	E-6033-L
1333005R	World Truck	E-5995-R	141875	Bendix	E-9873	1541208R	World Truck	E-6033-R
1333006L	World Truck	E-6652-L	141877	Bendix	E-4229	1541209L	World Truck	E-5986-L
1333006R	World Truck	E-6652-R	142022	Webb	E-5796	1541209R	World Truck	E-5986-R
1334001L	World Truck	E-5579-L	1423330230	Isuzu	E-10254-R	1541301L	World Truck	E-5982-L
1334001R	World Truck	E-5579-R	1423340230	Isuzu	E-10254-L	1541301R	World Truck	E-5982-R
1334002L	World Truck	E-5578-L	1423350050	Isuzu	E-10253-R	1541302L	World Truck	E-5985-L
1334002R	World Truck	E-5578-R	1423360050	Isuzu	E-10253-L	1541302R	World Truck	E-5985-R
1335001L	World Truck	E-5576-L	1434401	Reyco	E-4961A	15414	Webb	E-5570
1335001R	World Truck	E-5576-R	1434501	Reyco	E-1835	1541401L	World Truck	E-5718-L
1335003L	World Truck	E-6060-L	145058	Bendix	E-11306	1541401R	World Truck	E-5718-R
1335003R	World Truck	E-6060-R	14569	Eaton	E-2437	1541402L	World Truck	E-5719-L
1336001	World Truck	E-6000A	149B	HDA	E-4962	1541402R	World Truck	E-5719-R
133609	Webb	E-5868-L	1508989	Chrysler	E-5737	1541403L	World Truck	E-5720-L
133610	Webb	E-5868-R	1510003	World Truck	E-5796	1541403R	World Truck	E-5720-R
1337001	World Truck	E-5991	1510005	World Truck	E-5798	1541404L	World Truck	E-5871-L
13371	Trailmobile	E-5756-R	1510006	World Truck	E-5799	1541404R	World Truck	E-5871-R
1338001	World Truck	E-5704	1510007	World Truck	E-5800	1541405L	World Truck	E-5900-L
1338002	World Truck	E-5734	1510008	World Truck	E-5801	1541405R	Wagner	E-5900-R
1338003	World Truck	E-5892	1511004	World Truck	E-5944	1541405R	World Truck	E-5900-R
1339001	World Truck	E-5708	1511006	World Truck	E-5946	1541406L	World Truck	E-5896-L
1339002	World Truck	E-5710	1511008	World Truck	E-5947	1541406R	World Truck	E-5896-R
1339003	World Truck	E-5711	1511009	World Truck	E-5949	1541407L	World Truck	E-5987-L
1339004L	World Truck	E-9012-L	1511011	World Truck	E-5872	1541407R	World Truck	E-5987-R
1339004R	World Truck	E-9012-R	1511012	World Truck	E-4960	1541408L	World Truck	E-6057-L
1339005R	World Truck	E-9022-R	1512004	World Truck	E-5954	1541408R	World Truck	E-6057-R
1339006	World Truck	E-9021	1512005	World Truck	E-5955	1541501L	World Truck	E-5983-L
1339007	World Truck	E-6000A	1513001	World Truck	E-4942	1541501R	World Truck	E-5983-R
1339008	World Truck	E-9020	1513003	World Truck	E-4944	1541603L	World Truck	E-5909-L
1339009L	World Truck	E-5977-L	1513004	World Truck	E-4945	1541603R	World Truck	E-5909-R
1339009R	World Truck	E-5977-R	1513005	World Truck	E-4946	1541604L	World Truck	E-5910-L
1339010L	World Truck	E-7895-L	1513006	World Truck	E-4947	1541604R	World Truck	E-5910-R
1339010R	World Truck	E-7895-R	1513007	World Truck	E-4948	1541605L	World Truck	E-5911-L
133909RC	World Truck	E-5977-R	1513008	World Truck	E-4949	1541605R	World Truck	E-5911-R
13736	Trailmobile	E-5756-L	1513009	World Truck	E-4950	1541606L	World Truck	E-5721-L
138776R1	Navistar	E-2340	1513010	World Truck	E-5702	1541606R	World Truck	E-5721-R
1391	Webb	04-15502-002	1513011	World Truck	E-4951	1541608L	World Truck	E-5722-L
13988	Budd	E-5559-R	1513012	World Truck	E-4952	1541608R	World Truck	E-5722-R
139889	Budd	E-5559-R	1513013	World Truck	E-4953	1541701L	World Truck	E-4964-L
13989	Budd	E-5559-L	1513015	World Truck	E-9023	1541701R	Wagner	E-4964-R
13989	Budd	E-5559-R	1513016	World Truck	E-9024	1541701R	World Truck	E-4964-R
13990	Budd	E-5561-R	152026	Webb	E-5799	1541702L	World Truck	E-4965-L
139902	Webb	E-5561-R	1540001L	World Truck	E-5713-L	1541702R	World Truck	E-4965-R
13991	Budd	E-5561-L	1540001R	World Truck	E-5713-R	1541703L	World Truck	E-4966-L
139913	Webb	E-5561-L	1540002L	World Truck	E-5714-L	1541703R	World Truck	E-4966-R
14-15502-050	Paccar	14-15502-050	1540002R	World Truck	E-5714-R	1541704L	World Truck	E-4967-L
14-15502-050	Trailmobile	14-15502-050	1540003L	World Truck	E-5715-L	1541704R	World Truck	E-4967-R
14-15502-051	Paccar	14-15502-051	1540003R	World Truck	E-5715-R	1541705L	World Truck	E-4968-L
14-15502-064	Paccar	14-15502-064	1540004L	World Truck	E-5716-L	1541705R	World Truck	E-4968-R
14-15502-087	Paccar	14-15502-087	1540004R	World Truck	E-5716-R	1541706L	World Truck	E-4969-L
14-15502-088	Paccar	14-15502-088	1540005L	World Truck	E-5717-L	1541706R	World Truck	E-4969-R
14-15502-503	Paccar	14-15502-503	1540005R	World Truck	E-5717-R	1541707L	World Truck	E-5869-L
14-15968-129	Paccar	14-15968-129	1540006L	World Truck	E-5589-L	1541707R	World Truck	E-5869-R
14-15968-130	Paccar	14-15968-130	1540006R	World Truck	E-5589-R	15418003	World Truck	E-5775
14-15968-350X30	Paccar	14-15968-350X30	1541001L	World Truck	E-5558-L	15418004	World Truck	E-5776
14-159681-293MTB	Paccar	14-15968-1293MTB	1541001R	World Truck	E-5558-R	1541801L	World Truck	E-5764-L
14-15984-1039X30	Paccar	14-15984-1039X30	1541002L	World Truck	E-5556-L	1541801R	World Truck	E-5764-R
14-15984-1067	Paccar	14-15984-1067	1541002R	World Truck	E-5556-R	1541802L	World Truck	E-5870-L
14-15984-1068	Paccar	14-15984-1068	1541003L	World Truck	E-5559-L	1541802R	World Truck	E-5870-R
14-15984-1069	Paccar	14-15984-1069	1541003R	World Truck	E-5559-R	1541806L	World Truck	E-5756-L
14-15984-1070	Paccar	14-15984-1070	1541004L	World Truck	E-5561-L	1541806R	World Truck	E-5756-R
14-15984-1072	Paccar	14-15984-1072	1541004R	World Truck	E-5561-R	1541807L	World Truck	E-5765-L
14-15984-1089X30	Paccar	14-15984-1089X30	1541005L	World Truck	E-5560-L	1541807R	World Truck	E-5765-R
14-15984-1184	Paccar	14-15984-1184	1541005R	World Truck	E-5560-R	1541808L	World Truck	E-5757-L
14-15984-1185	Paccar	14-15984-1185	1541006L	World Truck	E-5551-L	1541808R	World Truck	E-5757-R
14-159841-085X30	Paccar	14-15984-1085X30	1541006R	World Truck	E-5551-R	1541809L	World Truck	E-5766-L
140270	Bendix	E-4228	1541007L	World Truck	E-5585-L	1541809R	World Truck	E-5766-R
141130H	Navistar	E-2297	1541007R	World Truck	E-5585-R	15419001	World Truck	E-5724
141132H	Navistar	E-2296	1541008L	World Truck	E-5553-L	15420001	World Truck	E-5682
141269	Bendix	E-4227	1541008R	World Truck	E-5553-R	15420002	World Truck	E-5683
141270	Bendix	E-4228	1541009L	World Truck	E-6023-L	15420003	World Truck	E-5816
141271	Bendix	E-11322	1541009R	World Truck	E-6023-R	1542001L	World Truck	E-5929-L
141271	Bendix	E-4229	1541010L	World Truck	E-5557-L	1542001R	World Truck	E-5929-R
141272	Bendix	23-122729-002	1541010R	World Truck	E-5557-R	1542002L	World Truck	E-5930-L
141272	Bendix	E-11311	1541012L	World Truck	E-6024-L	1542002R	World Truck	E-5930-R
141272	Bendix	E-4230	1541012R	World Truck	E-6024-R	1542003L	World Truck	E-5931-L
141273	Bendix	E-4231	1541013L	World Truck	E-5923-L	1542003R	World Truck	E-5931-R
141274	Bendix	E-4232	1541013R	World Truck	E-5923-R	1542004L	World Truck	E-5932-L
141275	Bendix	E-4233	1541014L	World Truck	E-5916-L	1542004R	World Truck	E-5932-R
141316H	Navistar	E-5743	1541014R	World Truck	E-5916-R	1542005L	World Truck	E-5933-L
141475	Bendix	E-6115	1541015L	World Truck	E-5924-L	1542005R	World Truck	E-5933-R
141476	Bendix	E-6114	1541015R	World Truck	E-5924-R	1542007L	World Truck	E-5989-L

Not an exact match. Quality level or bill of materials may differ between the Euclid and competitors part. Refer to Euclid catalog for complete information on Euclid Parts.

CROSS REFERENCE LISTING

COMPETITOR NUMBER	COMPETITOR NAME	EUCLID NUMBER	COMPETITOR NUMBER	COMPETITOR NAME	EUCLID NUMBER	COMPETITOR NUMBER	COMPETITOR NAME	EUCLID NUMBER
1542007R	World Truck	E-5989-R	1549017R	World Truck	E-8995-R	1646750C1	Navistar	E-4247
15421002	World Truck	E-5632	15500326	GMC	23-122729-002	1646770C1	Navistar	E-6115
1542201L	World Truck	E-4988-L	1550326	GMC	E-4230	1647126C1	Navistar	E-11680-R
1542201R	World Truck	E-4988-R	15514357	GMC	23-122729-002	1648518C1	Navistar	E-4242
1542202L	World Truck	E-5588-L	15514357	GMC	E-4230	1649492C1	Navistar	E-9020
1542202R	World Truck	E-5588-R	15514381	GMC	E-10202-L	1652875C1	Navistar	E-8987
1542203L	World Truck	E-5618-L	15514382	GMC	E-10202-R	1658475C1	Navistar	E-9837
1542203R	World Truck	E-5618-R	15514399	GMC	E-8966-R	1659065C1	Navistar	E-10206-L
1542204L	World Truck	E-5587-L	15514406	GMC	23-122729-002	1659066C1	Navistar	E-10206-R
1542204R	World Truck	E-5587-R	15514406	GMC	E-4230	1660001	World Truck	E-5736
1542301L	World Truck	E-6026-L	15514470	GMC	E-4229	1660002	World Truck	E-5737
1542301R	World Truck	E-6026-R	15514476	GMC	E-9805	1660003	World Truck	E-5738
1542302L	World Truck	E-6058-L	15514492	GMC	E-4246	1660004	World Truck	E-5952
1542302R	World Truck	E-6058-R	15515786	GMC	E-4229	1660005	World Truck	E-5739
1542303L	World Truck	E-6027-L	15515786	GMC	E-9804	1660006	World Truck	E-5740
1542303R	World Truck	E-6027-R	15515789	GMC	E-9804	1660007	World Truck	E-5957
1542304L	World Truck	E-6059-L	15519970	GMC	23-122729-002	1660008	World Truck	E-5742
1542304R	World Truck	E-6059-R	15519970	GMC	E-4230	1660009	World Truck	E-5743
1542305L	World Truck	E-6028-L	15543998	GMC	E-8966-L	1660010	World Truck	E-5960
1542305R	World Truck	E-6028-R	15552787	GMC	E-8972-L	1660579C1	Navistar	E-9009
1542401L	World Truck	E-5610-L	15552788	GMC	E-8972-R	1660699C1	Navistar	E-9873
1542401R	World Truck	E-5610-R	15579020	GMC	E-9807	1660699C91	Navistar	E-9873
1542402L	World Truck	E-5612-L	15579025	GMC	E-9808	1670001	World Truck	E-5018
1542402R	World Truck	E-5612-R	15579754	GMC	E-9808	168-1041	World Truck	E-8991
1542403L	World Truck	E-5613-L	15580830	GMC	E-8969-R	1681006L	World Truck	E-8983-L
1542403R	World Truck	E-5613-R	15580833	GMC	E-8969-L	1681006R	World Truck	E-8983-R
15425001	World Truck	E-5994	15611098	GMC	E-9804	1681007L	World Truck	E-8969-L
15425003	World Truck	E-5993	15611099	GMC	E-9804	1681007R	World Truck	E-8969-R
15425004	World Truck	E-6001A	15616450	GMC	E-9807	1681008L	World Truck	E-8982-L
15426001	World Truck	E-6029A	15619578	GMC	E-4246	1681008R	World Truck	E-8982-R
15426002	World Truck	E-6030A	15619626	GMC	E-4246	1681009L	World Truck	E-8968-L
15427001	World Truck	E-5998	15619954	GMC	E-4229	1681009R	World Truck	E-8968-R
15427002	World Truck	E-5997	15619970	GMC	23-122729-002	1681010L	World Truck	E-8979-L
15427003	World Truck	E-5999	15619970	GMC	E-4230	1681010R	World Truck	E-8979-R
15428001	World Truck	E-6036	15642921	GMC	E-10235	1681011L	World Truck	E-8994-L
15428002	World Truck	E-6035	15661542	GMC	E-9809	1681011R	World Truck	E-8994-R
15428003	World Truck	E-6034	15661543	GMC	E-9809	1681012L	World Truck	E-8992-L
15429001	World Truck	E-4955	1569970	GMC	23-122729-002	1681012R	World Truck	E-8992-R
15429002	World Truck	E-4958	1569970	GMC	E-4230	1681013L	World Truck	E-8993-L
15429003	World Truck	E-4958	157501R1	Navistar	E-6140	1681013R	World Truck	E-8993-R
15429004	World Truck	E-5726	159183	Webb	E-8947-L	1681014L	World Truck	E-9011-L
15429005	World Truck	E-5727	159184	Webb	E-8947-R	1681014R	World Truck	E-9011-R
15429006	World Truck	E-4956A	159190	Webb	E-9011-R	1681015R	World Truck	E-5775
15429008	World Truck	E-5706	159191	Webb	E-9011-L	1681016L	World Truck	E-9010-L
15429009	World Truck	E-4957	15A5223AP	Mack	E-5055	1681016R	World Truck	E-9010-R
15429010	World Truck	E-5728	15AJ23BP5	Mack	E-5822	1681017L	World Truck	E-8958-L
15429011	World Truck	E-5729	15AJ23BP6	Mack	E-5783	1681017R	World Truck	E-8958-R
1543002L	World Truck	E-5876-L	15BJ121	Mack	E-5780	1681018L	World Truck	E-8955-L
1543002R	World Truck	E-5876-R	15QJ112BP2	Mack	E-5820	1681018R	World Truck	E-8955-R
15432001	World Truck	E-5887	15QJ112BQ	Mack	E-5820	1681019L	World Truck	E-8978-L
15432002	World Truck	E-4987A	15QJ118P2	Mack	E-5044	1681019R	World Truck	E-8978-R
1545001L	World Truck	E-5918-L	15QJ118P3	Mack	E-5045	1681020L	World Truck	E-8957-L
1545001R	World Truck	E-5918-R	15QJ121	Mack	E-5573	1681020R	World Truck	E-8957-R
1545003L	World Truck	E-5920-L	15QJ121B	Mack	E-5780	1681021L	World Truck	E-8954-L
1545003R	World Truck	E-5920-R	15QJ121C	Mack	E-5780	1681021R	World Truck	E-8954-R
1546001L	World Truck	E-3723-L	15QJ154A	Mack	E-5571A	1681023L	World Truck	E-8977-L
1546001R	World Truck	E-3723-R	15QJ16	Mack	E-5827	1681023R	World Truck	E-8977-R
1546005L	World Truck	E-3727-L	15QJ16P3	Mack	E-5883	1681025L	World Truck	E-9003-L
1546005R	World Truck	E-3727-R	15QJ17P1	Mack	E-5828	1681025R	World Truck	E-9003-R
1546006L	World Truck	E-3728-L	15QJ17P3	Mack	E-5828	1681026L	World Truck	E-8947-L
1546006R	World Truck	E-3728-R	15QJ21	Mack	E-5573	1681026R	World Truck	E-8947-R
1547001L	World Truck	E-5935-L	15QJ210	Mack	E-5838	1681028L	World Truck	E-9008-L
1547001R	World Truck	E-5935-R	15QJ223AP	Mack	E-5055	1681028R	World Truck	E-9008-R
1547002L	World Truck	E-5936-L	15QJ223BP1	Mack	E-5882	1681030	World Truck	E-8963
1547002R	World Truck	E-5936-R	15QJ223BP2	Mack	E-5820	1681031	World Truck	E-8964
1547003L	World Truck	E-5937-L	15QJ223BP3	Mack	E-5821	1681032	World Truck	E-8965
1547003R	World Truck	E-5937-R	15QJ223BP4	Mack	E-5823	1681033L	World Truck	E-8959-L
1547004L	World Truck	E-5990-L	15QJ223BP5	Mack	E-5822	1681033R	World Truck	E-8959-R
1547004R	World Truck	E-5990-R	15QJ223BP6	Mack	E-5783	1681034L	World Truck	E-8946-L
1548002L	World Truck	E-5922-L	15QJ223BP8	Mack	E-5781	1681034R	World Truck	E-8946-R
1548002R	World Truck	E-5922-R	15QJ223CP3	Mack	E-5821	1681037	World Truck	E-8962
1549003L	World Truck	E-8948-L	15QJ223CP5	Mack	E-5822	1681038	World Truck	E-8961
1549003R	World Truck	E-8948-R	15QJ223CP6	Mack	E-5783	1681039L	World Truck	E-8949-L
1549006L	World Truck	E-9005-L	15QJ223CP8	Mack	E-5781	1681039R	World Truck	E-8949-R
1549006R	World Truck	E-9005-R	15QJ239	Mack	E-5890	1681040	World Truck	E-8960
1549007L	World Truck	E-9004-L	15QJ251	Mack	E-6053	1681042	World Truck	E-8988
1549007R	World Truck	E-9004-R	16003	Budd	E-5557-R	1681043	World Truck	E-8981
1549008L	World Truck	E-9002-L	16003/04	Budd	E-5557-R	1681044	World Truck	E-10676
1549008R	World Truck	E-9002-R	1600304	Budd	E-5557-R	1681045	World Truck	E-8980
1549009L	World Truck	E-9000-L	160034	Budd	E-5557-R	1681046	World Truck	E-8987
1549009R	World Truck	E-9000-R	16004	Budd	E-5557-L	1681047	World Truck	E-9009
1549010L	World Truck	E-8966-L	1610751C1	Navistar	E-5991	1681048	World Truck	E-8986
1549010R	World Truck	E-8966-R	161127	Webb	E-4958	1691002	World Truck	E-9006
1549011L	World Truck	E-8966-L	16123	Webb	E-5571A	1691003	World Truck	E-9007
1549011R	World Truck	E-8966-R	16124	Webb	E-5040A	1691004L	World Truck	E-8951-L
1549012L	World Truck	E-8985-L	16126	Webb	E-5784A	1691004R	World Truck	E-8951-R
1549012R	World Truck	E-8985-R	16129	Webb	E-5040A	1691005L	World Truck	E-8976-L
1549013L	World Truck	E-8990-L	16177	Webb	E-9024	1691005R	World Truck	E-8976-R
1549013R	World Truck	E-8990-R	1617829C1	Navistar	E-6000A	1701003L	World Truck	E-8952-L
1549014L	World Truck	E-8996-L	161832	Webb	E-4953	1701003R	World Truck	E-8952-R
1549014R	World Truck	E-8996-R	16271	Budd	E-5553-R	1701004L	World Truck	E-8950-L
1549015L	World Truck	E-8972-L	16271/72	Budd	E-5553-R	1701004R	World Truck	E-8950-R
1549015R	World Truck	E-8972-R	162712	Budd	E-5553-R	1701005	World Truck	E-8997
1549016L	World Truck	E-9001-L	1627172	Budd	E-5553-R	171027	Webb	E-4956A
1549016R	World Truck	E-9001-R	16272	Budd	E-5553-L	171194R5	Navistar	E-5047
1549017L	World Truck	E-8995-L	16466750C1	Navistar	E-4247	17123	Budd	E-5551-R

Not an exact match. Quality level or bill of materials may differ between the Euclid and competitors part. Refer to Euclid catalog for complete information on Euclid Parts.



CROSS REFERENCE LISTING

COMPETITOR NUMBER	COMPETITOR NAME	EUCLID NUMBER	COMPETITOR NUMBER	COMPETITOR NAME	EUCLID NUMBER	COMPETITOR NUMBER	COMPETITOR NAME	EUCLID NUMBER
17124	Budd	E-5551-L	20X1335	Meritor	E-5924-R	20X482	Meritor	E-5871-R
178736	Webb	E-5652-R	20X1356	Meritor	E-9001-R	20X482BK	Meritor	E-5871-R
178737	Webb	E-5652-L	20X1357	Meritor	E-9001-L	20X482BULK	Meritor	E-5871-R
178910	Webb	E-5977-R	20X142	Meritor	E-6023-R	20X52	Meritor	E-5561-R
178921	Webb	E-5977-L	20X143	Meritor	E-6023-L	20X53	Meritor	E-5561-L
178950	Webb	E-5995-R	20X1457	Meritor	E-5923-L	20X53	Meritor	E-5561-R
17903HA	Navistar	E-2465	20X1458	Meritor	E-5923-R	20X54	Meritor	E-5556-R
179920	Webb	E-10235	20X1459	Meritor	E-5916-L	20X55	Meritor	E-5556-L
179933	Webb	E-6000A	20X1460	Meritor	E-5916-R	20X58	Meritor	E-5551-R
179955	Webb	E-5991	20X1463	Meritor	E-5924-L	20X582	Meritor	E-10224-R
17QH4115	Mack	53-123542-002	20X1464	Meritor	E-5924-R	20X583	Meritor	E-10224-L
17QJ3239A	Mack	85-122266-002	20X1467	Meritor	E-9003-L	20X584	Meritor	E-5750-R
17QJ3260	Mack	53-123537-002	20X1468	Meritor	E-9003-R	20X585	Meritor	E-5750-L
17QJ3260	Mack	53-123608-002	20X1469	Meritor	E-4969-L	20X586	Meritor	E-5985-R
17QJ4111	Mack	53-123566-002	20X1470	Meritor	E-4969-R	20X587	Meritor	E-5985-L
17QJ4115	Mack	53-123542-002	20X1471	Meritor	E-9002-L	20X588	Meritor	E-5898-R
17QJ4116	Mack	53-123537-002	20X1472	Meritor	E-9002-R	20X589	Meritor	E-5898-L
17QJ4123	Mack	53-123537-002	20X1475	Meritor	E-10249-L	20X59	Meritor	E-5551-L
17QJ4132	Mack	53-123568-002	20X1476	Meritor	E-10249-R	20X592	Meritor	E-4965-R
18301	Webb	E-5989-L	20X1477	Meritor	E-9001-L	20X593	Meritor	E-4965-L
183101	Webb	E-5989-L	20X1477	Meritor	E-9001-R	20X601	Meritor	E-5589-L
183102	Webb	E-5989-R	20X1478	Meritor	E-9001-L	20X602	Meritor	E-5589-R
184197R1	Navistar	E-4966-L	20X1478	Meritor	E-9001-R	20X603	Meritor	E-5714-L
184198R1	Navistar	E-4966-R	20X1563	Meritor	E-5897-L	20X604	Meritor	E-5714-R
18515	Dana/Spicer	E-4227	20X1563	Meritor	E-5897-R	20X605	Meritor	E-5714-L
188108	Webb	E-5986-R	20X1564	Meritor	E-5897-L	20X606	Meritor	E-5713-R
188109	Webb	E-5986-L	20X1564	Meritor	E-5897-R	20X655	Meritor	E-4988-L
189445R1	Navistar	E-4962	20X1571	Meritor	E-4968-L	20X656	Meritor	E-4988-R
189446R1	Navistar	E-5746	20X1571BK	Meritor	E-4968-L	20X66	Meritor	E-5553-R
18AX1158	Mack	E-8966-R	20X1572	Meritor	E-4968-R	20X67	Meritor	E-5553-L
18AX1159	Mack	E-8966-L	20X1572BK	Meritor	E-4968-R	20X687	Meritor	E-4965-L
18AX340	Mack	E-5887	20X1575	Meritor	E-4967-L	20X688	Meritor	E-4965-R
18AX405	Mack	E-4987A	20X1576	Meritor	E-4967-R	20X70	Meritor	E-5585-R
18AX423	Mack	E-5551-R	20X1746	Meritor	E-8978-L	20X71	Meritor	E-5585-L
18AX424	Mack	E-5551-L	20X1747	Meritor	E-8978-R	20X746	Meritor	E-5899-R
18AX48	Mack	E-5558-R	20X1754	Meritor	E-8966-R	20X747	Meritor	E-5899-L
18AX49	Mack	E-5558-L	20X1755	Meritor	E-8966-L	20X831	Meritor	E-5900-L
18AX825	Mack	E-5558-R	20X1760	Meritor	E-8976-R	20X832	Meritor	E-5900-R
18AX826	Mack	E-5558-L	20X1761	Meritor	E-8976-L	20X85	Meritor	E-5560-L
18AX829	Mack	E-5556-R	20X1805	Meritor	E-4965-L	20X85	Meritor	E-5560-R
18AX830	Mack	E-5556-L	20X1806	Meritor	E-4965-R	20X852	Meritor	E-5909-R
18AX989	Mack	E-5557-R	20X1809	Meritor	E-5870-L	20X853	Meritor	E-5909-L
18AX990	Mack	E-5557-L	20X1810	Meritor	E-5870-R	20X86	Meritor	E-5560-L
19004	Budd	E-5560-R	20X1811	Meritor	E-4967-L	20X86	Meritor	E-5560-R
19005	Budd	E-5560-L	20X1811	Meritor	E-9003-L	20X89	Meritor	E-3723-R
19091	Trailmobile	E-1251	20X1812	Meritor	E-4967-R	20X90	Meritor	E-3723-L
19092	Trailmobile	E-1253	20X1812	Meritor	E-9003-R	20X996	Meritor	E-4968-R
19093	Trailmobile	E-1252	20X1816	Meritor	E-4968-R	20X997	Meritor	E-4968-L
19103	Trailmobile	E-618	20X1816BULK	Meritor	E-4968-R	21-W158/159	Trailmobile	E-7896-R
19105	Trailmobile	E-572	20X1867	Meritor	E-5922-L	21-W276/277	Trailmobile	E-5896-R
19107	Trailmobile	E-573	20X1868	Meritor	E-5922-R	21-W40/41	Trailmobile	E-5559-R
19143	Trailmobile	E-975	20X19	Meritor	E-5558-R	21-W486/487	Trailmobile	E-5988-R
19186	Eaton	E-2462	20X1977	Meritor	E-5924-R	21-W64/65	Trailmobile	E-4965-R
1927774	Chrysler	E-5571A	20X1978	Meritor	E-5924-L	21-W68/69	Trailmobile	E-4967-R
1932231	Chrysler	E-5927	20X1979	Meritor	E-9004-L	21137	Gunite	E-4961A
195693	Webb	E-5932-R	20X1980	Meritor	E-9004-R	21210415728004	Mack	04-15728-004
195694	Webb	E-5932-L	20X20	Meritor	E-5558-L	2121122550	Mack	03-122550-002
198510	Webb	E-4968-R	20X206	Meritor	E-5720-R	2121123276	Mack	03-123276-002
198521	Webb	E-4968-L	20X207	Meritor	E-5720-L	212112480	Mack	03-012480-002
19937	Budd	E-5799	20X208	Meritor	E-5718-R	212123122691	Mack	E-4228
20048	Gunite	E-4988-R	20X2089	Meritor	E-9005-R	21213122490002	Mack	03-122683-002
20049	Gunite	E-4988-L	20X2089	Meritor	E-9005-L	212185123570002	Mack	85-123570-002
2007175C2	Navistar	E-10675	20X209	Meritor	E-5718-L	212254R1	Navistar	E-5718-L
2010358C1	Navistar	E-8981	20X210	Meritor	E-5719-R	212255R1	Navistar	E-5718-R
2019459	GMC	E-5708	20X211	Meritor	E-5719-L	2124231	GMC	E-5737
2019573	GMC	E-5743	20X2128	Meritor	E-9006	212E+11	Mack	E-4228
203 122518 002	Mack	03-122518-002	20X2144	Meritor	E-9007	215664R1	Navistar	E-5927
203 122978 002	Volvo	03-122978-002	20X2233	Meritor	E-8976-L	215664R2	Navistar	E-5927
20354828	Volvo	53-123568-002	20X2234	Meritor	E-8976-R	218208R1	Navistar	E-2433
204 15968 002	Volvo	04-15968-002	20X344	Meritor	E-5910-R	21943	Budd	E-6023-L
20421880	Volvo	53-123575-002	20X345	Meritor	E-5910-L	21AX335	Mack	E-3509
2071619	GMC	E-9020	20X369	Meritor	E-5748-L	21AX442	Mack	E-7897-R
2075453	GMC	E-8966-L	20X37	Meritor	E-5559-L	21AX443	Mack	E-7897-L
2075454	GMC	E-8966-R	20X370	Meritor	E-5748-R	21AX480	Mack	E-1835
2095341	GMC	E-10201-L	20X371	Meritor	E-5749-L	21AX609	Mack	E-7898-R
2095342	GMC	E-10201-R	20X372	Meritor	E-5749-R	21AX610	Mack	E-7898-L
20AX7	Mack	E-2002	20X377	Meritor	E-5897-R	21AX611	Mack	E-5576-R
20X1040	Meritor	E-5558-R	20X378	Meritor	E-5897-L	21AX612	Mack	E-5576-L
20X1041	Meritor	E-5558-L	20X379	Meritor	E-5749-L	21AX626	Mack	E-3506
20X120	Meritor	E-5618-R	20X38	Meritor	E-5559-R	21AX790	Mack	E-3501
20X121	Meritor	E-5618-L	20X380	Meritor	E-5749-R	21AX863	Mack	E-6147
20X121	Meritor	E-5721-L	20X402	Meritor	E-5911-R	21AX899	Mack	E-5554-R
20X1227	Meritor	E-5920-L	20X403	Meritor	E-5911-L	21AX91	Mack	E-5652-R
20X1228	Meritor	E-5920-R	20X404	Meritor	E-5721-R	21AX92	Mack	E-5652-L
20X1233	Meritor	E-5918-L	20X405	Meritor	E-5721-L	21AX93	Mack	E-7895-R
20X1234	Meritor	E-5918-R	20X41	Meritor	E-5557-L	21AX94	Mack	E-7895-L
20X1241	Meritor	E-5922-L	20X42	Meritor	E-5557-R	21AX95	Mack	E-5977-R
20X1242	Meritor	E-5922-R	20X430	Meritor	E-4966-R	21AX96	Mack	E-5977-L
20X1283	Meritor	E-5722-R	20X431	Meritor	E-4966-L	21L 1336	Trailmobile	E-2301
20X1307	Meritor	E-9000-L	20X460	Meritor	E-10224-R	21L 1355	Trailmobile	E-2303
20X1308	Meritor	E-9000-R	20X469	Meritor	E-10224-L	21L 1359	Trailmobile	E-2460
20X1309	Meritor	E-5923-L	20X477	Meritor	E-5722-R	21L 1360	Trailmobile	E-2461
20X1310	Meritor	E-5923-R	20X478	Meritor	E-5722-L	21L840	Trailmobile	E-1251
20X1311	Meritor	E-5916-L	20X481	Meritor	E-5871-L	21W158159	Trailmobile	E-7896-R
20X1312	Meritor	E-5916-R	20X481BK	Meritor	E-5871-L	21W181	Trailmobile	E-5683
20X1334	Meritor	E-5924-L	20X481BULK	Meritor	E-5871-L	21W182	Trailmobile	E-5734

Not an exact match. Quality level or bill of materials may differ between the Euclid and competitors part. Refer to Euclid catalog for complete information on Euclid Parts.

CROSS REFERENCE LISTING

COMPETITOR NUMBER	COMPETITOR NAME	EUCLID NUMBER	COMPETITOR NUMBER	COMPETITOR NAME	EUCLID NUMBER	COMPETITOR NUMBER	COMPETITOR NAME	EUCLID NUMBER
21W205	Trailmobile	E-5713-R	23-123572-004	Meritor	E-6115	2398446	GMC	E-5570
21W227	Trailmobile	E-5825	23-123572-004	Paccar	E-6115	2398447	GMC	E-5044
21W244	Trailmobile	E-5750-R	23-123573-004	Meritor	E-6114	239901216	Freightliner	E-1828
21W276277	Trailmobile	E-5896-R	23-123573-004	Paccar	E-6114	23QJ117B	Mack	E-6146
21W4041	Trailmobile	E-5559-R	23-123574-004	Meritor	E-12517	23QJ129	Mack	E-3505
21W486487	Trailmobile	E-5988-R	23-123574-004	Paccar	E-12517	23QJ12B	Mack	E-3508
21W6465	Trailmobile	E-4965-R	23-123618-002	Meritor	E-12513	23QJ201	Mack	E-2304
21W6869	Trailmobile	E-4967-R	23-123618-002	Paccar	E-12513	2408341	GMC	E-540
22005	Budd	E-5585-L	23-123624-002	Meritor	E-12515	2505097C1	Navistar	E-6115
22005	Budd	E-5585-R	23-123624-002	Paccar	E-12515	2509072C1	Navistar	E-11470
22006	Budd	E-5585-L	23-123625-002	Meritor	E-12516	2509073C1	Navistar	E-12523
2202033	GMC	E-10229	23-123625-002	Paccar	E-12516	2509073C1	Navistar	E-6114
2208F422	Meritor	E-2438	23-123626-002	Meritor	E-12514	25169009	Mack	53-123608-002
2208J426	Meritor	E-2433	23-123626-002	Paccar	E-12514	25264	Gunitite	E-5652-R
2208W413	Meritor	E-2341	2309598014	Freightliner	E-1835	25265	Gunitite	E-5652-L
2208X440	Meritor	E-2341	230959814	Freightliner	E-1835	253 123589 002	Volvo	53-123589-002
2208X440	Meritor	E-2435	23105251	Dayton-Walther	23-122729-002	253 123600 002	Volvo	53-123600-002
2208Z416	Meritor	E-2340	23105251	Dayton-Walther	E-4230	253 123601 002	Mack	53-123601-002
2210239	GMC	E-8993-R	2310537	GMC	E-2433	2546C	Gunitite	85-120586-002
2210240	GMC	E-8993-L	2310540	GMC	E-2435	2577A	Gunitite	03-120754-002
223 123461 002	Mack	E-12520	23105425	Dayton-Walther	23-122729-002	2594595C1	Navistar	E-11470
223122693002	Mack	E-4246	23105425	Dayton-Walther	E-4230	25QJ125	Mack	E-3505
2231319	GMC	E-5960	2311480144	Freightliner	E-4961A	25QJ13	Mack	E-3507
2236581	GMC	E-1835	23122527	Dayton-Walther	E-4231	25QJ168	Mack	E-3504
22422V	Navistar	E-4965-R	23122527002	Meritor	E-4231	25QJ225	Mack	E-6145
22423V	Navistar	E-4965-L	23122527002	Paccar	E-4231	25QJ35	Mack	E-2303
224957R1	Navistar	E-5749-L	23122687	Dayton-Walther	E-4229	25QJ36	Mack	E-2305
224958R1	Navistar	E-5749-R	23122688002	Meritor	E-9804	2603	Gunitite	03-120517-002
2257Y1013	Meritor	E-5902	23122691	Dayton-Walther	E-4228	2604	Gunitite	03-120516-002
22621	Budd	E-7897-R	23122700	Dayton-Walther	E-4227	260578C1	Navistar	E-4958
22621/22	Budd	E-7897-R	23122701	Dayton-Walther	E-4232	26265	Gunitite	E-5652-L
2262122	Budd	E-7897-R	23122703	Dayton-Walther	E-4233	2672	Gunitite	03-122603-002
22622	Budd	E-7897-L	23122729	Dayton-Walther	23-122729-002	2697	Gunitite	03-120459-002
226604	Fruehauf	E-7898-L	23122729	Dayton-Walther	E-4230	270010	Erie	03-122971-002
226605	Fruehauf	E-7898-R	23122729	Paccar	23-122729-002	2700311008	Peterbilt	E-5032
2271704	Trailmobile	E-5032	23122729	Paccar	E-4230	2705	Gunitite	03-012582-002
23-122527-002	Meritor	E-4231	23122729002	Meritor	23-122729-002	2717	Gunitite	03-120553-002
23-122527-002	Paccar	E-4231	23122729002	Meritor	E-4230	27197H	Navistar	E-4851
23-122687-002	Meritor	E-4229	23122897	Dayton-Walther	E-4247	2738	Erie	03-122222-002
23-122688-002	Meritor	E-9804	23122962	Dayton-Walther	E-4242	2740	Erie	03-120586-002
23-122691-002	Meritor	E-4228	23123046002	Meritor	E-9808	27401	Erie	03-122126-002
23-122691-002	Paccar	E-4228	23123296002	Meritor	E-9809	27501	Erie	03-012480-002
23-122693-002	Meritor	E-4246	23123433002	Meritor	E-11327	27501	Erie	03-120574-002
23-122693-002	Paccar	E-4246	23123433002	Paccar	E-11327	2751	Erie	03-012488-002
23-122700-002	Meritor	E-4227	23123434	Dayton-Walther	E-11307	2752	Erie	03-122963-002
23-122700-002	Paccar	E-4227	23123439	Dayton-Walther	E-11306	2760	Erie	03-012582-002
23-122701-002	Meritor	E-4232	23123439002	Meritor	E-11306	2762	Erie	03-120754-002
23-122701-002	Paccar	E-4232	23123440	Dayton-Walther	E-11308	2764	Erie	03-123207-002
23-122703-002	Meritor	E-4233	23123440002	Meritor	E-11308	27645	Erie	03-123207-002
23-122703-002	Paccar	E-4233	23123443	Dayton-Walther	E-11320	276451	Erie	03-120877-002
23-122729-002	Meritor	23-122729-002	23123443002	Meritor	E-11320	2765	Erie	03-122600-002
23-122729-002	Meritor	E-4230	23123458	Dayton-Walther	E-11309	2766	Erie	03-120936-002
23-122729-002	Paccar	23-122729-002	23123458002	Meritor	E-11309	2769X	Gunitite	85-122550-002
23-122729-002	Paccar	E-4230	23123460	Dayton-Walther	E-11321	2771	Erie	03-122550-002
23-122897-002	Meritor	E-4247	23123460002	Meritor	E-11321	277118	Erie	03-123409-002
23-123041-002	Meritor	E-9807	23123468	Dayton-Walther	E-11322	2773	Erie	03-122455-002
23-123041-002	Paccar	E-9807	23123468	Paccar	E-11322	27733	Erie	03-122925-002
23-123046-002	Meritor	E-9808	23123468002	Meritor	E-11322	2774	Erie	03-122948-002
23-123046-002	Paccar	E-9808	23123480001	Dayton-Walther	E-11323	2775	Erie	03-123430-002
23-123296-002	Meritor	E-9809	23123480002	Meritor	E-11323	27773C1	Navistar	E-5720-L
23-123341-002	Meritor	E-12519	2312348002	Meritor	E-11323	277774C1	Navistar	E-5720-R
23-123433-002	Meritor	E-11327	23123485	Dayton-Walther	E-11125	279670	GMC	E-5977-R
23-123433-002	Paccar	E-11327	23123485002	Paccar	E-11125	279671	GMC	E-5977-L
23-123434-002	Meritor	E-11307	23123486	Dayton-Walther	E-11310	279672	GMC	E-7895-R
23-123439-002	Meritor	E-11306	23123486002	Meritor	E-11310	279673	GMC	E-7895-L
23-123440-002	Meritor	E-11308	23123486002	Paccar	E-11310	282	Trailmobile	E-6114
23-123440-005	Meritor	E-11308	23123487	Dayton-Walther	E-11324	283832C1	Navistar	E-5754
23-123443-002	Meritor	E-11320	23123489	Dayton-Walther	E-11311	285 123370 002	Volvo	85-123370-002
23-123458-002	Meritor	E-11309	23123489002	Meritor	E-11311	285 123400 002	Volvo	85-123400-002
23-123458-005	Meritor	E-11309	23123489002	Paccar	E-11311	285 123466 002	Mack	85-123466-002
23-123460-002	Meritor	E-11321	23123494	Dayton-Walther	E-11312	2850	Gunitite	03-120705-002
23-123461-002	Meritor	E-12520	23123494002	Meritor	E-11312	2851	Gunitite	03-120442-002
23-123461-002	Paccar	E-12520	23123495	Dayton-Walther	E-11313	29248	Hendrickson	E-1835
23-123468-002	Meritor	E-11322	23123495002	Meritor	E-11313	29248000	Hendrickson	E-1835
23-123468-002	Paccar	E-11322	23123495002	Paccar	E-11313	292963C1	Navistar	E-8972-L
23-123480-002	Meritor	E-11323	23123495002	Volvo	E-11313	292964C1	Navistar	E-8972-R
23-123485-002	Meritor	E-11125	23123527	Dayton-Walther	E-11326	297331C1	Navistar	E-2341
23-123485-002	Paccar	E-11125	23123527002	Meritor	E-11326	297331C1	Navistar	E-2435
23-123486-002	Meritor	E-11310	23123550004	Volvo	E-11470	2974	Gunitite	03-120574-002
23-123486-002	Paccar	E-11310	23123552004	Volvo	E-12523	2983C	Gunitite	03-122222-002
23-123487-002	Meritor	E-11324	23123557004	Volvo	E-12524	298484	Fruehauf	E-5719-L
23-123489-002	Meritor	E-11311	23123572004	Meritor	E-6115	298485	Fruehauf	E-5719-R
23-123489-002	Paccar	E-11311	23123573004	Dayton-Walther	E-6114	2997	Gunitite	03-123430-002
23-123489-005	Meritor	E-11311	23123574004	Volvo	E-12517	2997A	Gunitite	03-123430-002
23-123494-002	Meritor	E-11312	2320989	GMC	E-1828	2997C	Gunitite	03-123430-002
23-123495-002	Meritor	E-11313	2321015	GMC	E-2438	2997D	Gunitite	03-122009-002
23-123497-002	Meritor	E-11328	2323	Webb	04-15502-002	2997D	Gunitite	03-123200-002
23-123498-002	Meritor	E-12521	234616	Freightliner	E-4961A	2997D	Gunitite	03-123430-002
23-123498-002	Paccar	E-12521	235B	HDA	E-5572A	2E-10208-L	Paccar	E-10208-L
23-123527-002	Meritor	E-11326	2362158	GMC	E-2437	2E-10257	Paccar	E-10257
23-123550-004	Meritor	E-11470	2362287	GMC	E-2435	2E-4962	Paccar	E-4962
23-123550-004	Paccar	E-11470	2377906	GMC	E-5753	2E-5573	Paccar	E-5573
23-123552-004	Meritor	E-12523	2393267	GMC	E-5572A	2E-8950-L	Paccar	E-8950-L
23-123552-004	Paccar	E-12523	23933813	Freightliner	E-4961A	2E-9525-R	Paccar	E-9525-R
23-123557-004	Meritor	E-12524	2393941	GMC	E-4246	30002	Reyco	E-5977-R
23-123557-004	Paccar	E-12524	239406R1	Navistar	E-5036	30003	Reyco	E-5977-L

Not an exact match. Quality level or bill of materials may differ between the Euclid and competitors part. Refer to Euclid catalog for complete information on Euclid Parts.

CROSS REFERENCE LISTING

COMPETITOR NUMBER	COMPETITOR NAME	EUCLID NUMBER	COMPETITOR NUMBER	COMPETITOR NAME	EUCLID NUMBER	COMPETITOR NUMBER	COMPETITOR NAME	EUCLID NUMBER
30006	Reyco	E-7895-R	31439	Budd	E-5724	35786	Budd	E-5587-R
30007	Reyco	E-7895-L	3166	Gunite	03-122978-002	35786/87	Budd	E-5587-R
30008	Reyco	E-4968-R	3168	Gunite	03-120376-002	3578687	Budd	E-5587-R
30009	Reyco	E-4968-L	3169	Gunite	03-122561-002	35787	Budd	E-5587-L
30010	Reyco	E-5756-R	3169A	Gunite	03-122562-002	35867158B	Ford	E-4958
30011	Reyco	E-5757-L	31703	Budd	E-5936-R	35AX1415	Mack	E-3502
300190	Volvo	E-5652-L	31704	Budd	E-5936-L	35AX338	Mack	E-6148
300191	Volvo	E-5652-R	3174	Gunite	03-122963-002	35AX600	Mack	E-5737
30023	Gunite	E-5008	3186	Gunite	03-122314-002	35AX606	Mack	E-5743
3005301	Budd	E-4969-R	3188224	Volvo	53-123537-002	36-101160	Webb	E-6034
3006201	Budd	E-5612-R	31926	Eaton	E-2463	36-101162	Webb	E-6035
3008401	Budd	E-8949-R	3197	Gunite	03-120936-002	3600A	Gunite	03-123207-002
3008402	Budd	E-8949-L	3203001	Budd	E-7897-R	3600AX	Gunite	85-123207-002
3011101L	Std. Forge	E-5558-L	3203002	Budd	E-7897-L	36101160	Trailmobile	E-6034
3011101R	Std. Forge	E-5558-R	3203401	Budd	E-7896-R	36101162	Trailmobile	E-6035
3011102L	Std. Forge	E-5556-L	3203402	Budd	E-7896-L	36101166	Trailmobile	E-9009
3011102R	Std. Forge	E-5556-R	3203403	Budd	E-7895-R	36101172	Trailmobile	E-9010-R
3011104L	Std. Forge	E-5561-L	3203404	Budd	E-7895-L	36101173	Trailmobile	E-9010-L
3011104R	Std. Forge	E-5561-R	3203801	Budd	E-5977-R	36105988	Trailmobile	E-5988-R
3011105L	Std. Forge	E-5560-L	3203802	Budd	E-5977-L	36105989	Trailmobile	E-5988-L
3011105R	Std. Forge	E-5560-R	320401	Budd	E-7896-R	36139913	Trailmobile	E-5561-L
3011106L	Std. Forge	E-5585-L	320402	Budd	E-7896-L	36159183	Trailmobile	E-8947-L
3011106R	Std. Forge	E-5585-R	3204501	Budd	E-5576-R	36159184	Trailmobile	E-8947-R
3011121	Std. Forge	E-5816	3204502	Budd	E-5576-L	3616123	Trailmobile	E-5571A
3011161	Std. Forge	E-5724	3204503	Budd	E-7898-R	36162	Gunite	E-7895-R
3011351L	Std. Forge	E-8946-L	3204504	Budd	E-7898-L	36163	Gunite	E-7895-L
3011351R	Std. Forge	E-8946-R	3205101	Budd	E-5652-R	36179933	Trailmobile	E-6000A
3011371L	Std. Forge	E-5713-L	3205102	Budd	E-5652-L	36179955	Trailmobile	E-5991
3011371R	Std. Forge	E-5713-R	3205201	Budd	E-5579-R	36183101	Trailmobile	E-5989-L
3011373L	Std. Forge	E-5716-L	3205202	Budd	E-5579-L	36183102	Trailmobile	E-5989-R
3011373R	Std. Forge	E-5716-R	3205301	Budd	E-5554-R	36198510	Trailmobile	E-4968-R
3012A	Gunite	03-122239-002	3205302	Budd	E-5554-L	36198521	Trailmobile	E-4968-L
3012B	Gunite	03-122027-002	3206201	Budd	E-7897-R	362023	Trailmobile	04-15984-001
3012B	Gunite	03-122290-002	3208401	Budd	E-6000A	363319	Trailmobile	E-5973
3018501	Budd	E-5999	32309	Budd	E-3723-R	363320	Trailmobile	E-5824
3018502	Budd	E-5998	32309/10	Budd	E-3723-R	363322	Trailmobile	E-5825
3018503	Budd	E-5997	3230910	Budd	E-3723-R	363350	Trailmobile	E-5976
3018A	Gunite	03-122126-002	32310	Budd	E-3723-L	3637720	Chrysler	E-9022-R
3018A	Gunite	03-122518-002	3244A	Gunite	03-122575-002	3638A	Gunite	03-123020-002
3018B	Gunite	03-120586-002	3262545	Meritor	E-975	36415HB	Navistar	E-4857
30191	Hendrickson	E-4961A	3262W1245	Meritor	E-975	36416HB	Navistar	E-4881
3022B	Gunite	03-123427-002	3280K7863	Meritor	E-5571A	3651372	Ford	E-5738
3023	Gunite	03-122078-002	3280S7871	Meritor	E-5988-L	3651372	GMC	E-5738
3025201	Budd	E-5559-R	3289	Gunite	03-123500-002	3654102	Trailmobile	E-4229
3025202	Budd	E-5559-L	3295A	Gunite	03-122683-002	3654301	Trailmobile	23-122729-002
303100	Std. Forge	E-7895-R	3314	Webb	E-5953	3654301	Trailmobile	E-4230
303101	Std. Forge	E-7895-L	3319	Webb	E-5973	3654770	Trailmobile	E-6115
303104	Std. Forge	E-5977-R	3320	Webb	E-5824	3674	Gunite	03-120981-002
303105	Std. Forge	E-5977-L	3322	Webb	E-5825	3676	Gunite	03-120988-002
303106	Std. Forge	E-5652-R	332528C1	Navistar	E-5764-L	3687	Gunite	85-123400-002
303107	Std. Forge	E-5652-L	332529C1	Navistar	E-5764-R	3687X	Gunite	03-123399-002
303108	Std. Forge	E-5576-R	334386	GMC	E-8964	3687X	Gunite	85-123399-002
303109	Std. Forge	E-5576-L	334816	Fruehauf	E-7896-R	3694508	GMC	E-10229
303110	Std. Forge	E-5579-R	3350	Webb	E-5976	3697043	GMC	E-10230
303111	Std. Forge	E-5579-L	337LB/336RB	HDA	E-7896-R	3699	Gunite	03-122453-002
303119	Std. Forge	E-5734	337LB336RB	HDA	E-7896-R	3702236	GMC	E-4874
304104	Standard Forge	E-975	3383857	Navistar	E-4961A	3703711	GMC	E-4858
304104	Std. Forge	E-975	3398W1211	Mack	E-8987	37047	Trailmobile	E-617
304981	Volvo	E-5737	3398W883L	Mack	E-8978-L	3710	Gunite	85-123383-002
30714	Eaton	E-2461	3398W883R	Mack	E-8978-R	37173	Budd	E-4960
3093400502	Trailmobile	E-1828	3401	Gunite	03-123365-002	37179	Budd	E-4960
3095800	Volvo	E-4228	3402	Gunite	03-123397-002	37181	Budd	E-5798
3095801	Volvo	E-4246	3402X	Gunite	85-123397-002	3721AX	Gunite	85-123254-002
3095940	Volvo	E-4227	34090	Eaton	E-2460	3721AX	Gunite	85-123366-002
3095942	Volvo	E-4233	341551	Dana/Spicer	E-4961A	3721AX	Gunite	85-123382-002
3095944	Volvo	23-122729-002	34271	Gunite	E-5977-R	3721AX	Gunite	85-123421-002
3095944	Volvo	E-4230	34272	Gunite	E-5977-L	3721X	Gunite	85-123366-002
3098912	Volvo	03-123207-002	3441	Gunite	85-123297-002	3721X	Gunite	85-123421-002
3098913	Volvo	03-122222-002	34435	Gunite	E-5032	3723967	GMC	E-4967-L
3098914	Volvo	03-122607-002	3467	Gunite	03-122971-002	3723968	GMC	E-4967-R
3098915	Volvo	03-122126-002	3483	Gunite	03-122607-002	3726212	GMC	E-5007
3098916	Volvo	03-122550-002	3485B	Gunite	03-122011-002	3726X	Gunite	03-123448-002
3098917	Volvo	03-122683-002	3485BX	Gunite	85-123203-002	3726X	Gunite	85-123448-002
3098918	Volvo	03-120877-002	349510C1	Navistar	E-1835	3729737	GMC	E-5652-L
3098919	Volvo	03-123254-002	35089	Budd	E-3728-R	3729738	GMC	E-5652-R
3098920	Volvo	03-120586-002	35089/90	Budd	E-3728-R	3732	Gunite	03-012582-002
3098922	Volvo	53-123542-002	3508990	Budd	E-3728-R	3735549	GMC	E-5977-L
3098923	Volvo	53-123565-002	35090	Budd	E-3728-L	3735550	GMC	E-5977-R
3098924	Volvo	53-123566-002	351138C1	Navistar	E-5909-L	373912	GMC	E-5008
3098925	Volvo	53-123564-002	351139C1	Navistar	E-5909-R	37411	Trailmobile	E-572
3099615	Volvo	03-123382-002	351163S	Ford	E-4859	37413	Trailmobile	E-1001
3099723	Volvo	85-123207-002	3531661C1	Navistar	E-6114	3744X	Gunite	85-123466-002
3099724	Volvo	03-120376-002	3531661C2	Navistar	E-6114	37477	Trailmobile	E-4989
3099725	Volvo	85-123366-002	3531662C1	Navistar	E-11470	3750B	Gunite	03-123466-002
3099728	Volvo	85-123570-002	3531662C2	Navistar	E-11470	3752789	GMC	E-7895-L
3099732	Volvo	04-15502-001	3531663C1	Navistar	E-12523	3752790	GMC	E-7895-R
3120	Gunite	03-120877-002	3531663C2	Navistar	E-12523	3753X	Gunite	85-123465-002
3133400	Volvo	E-9837	35336	Budd	E-7896-R	37555	Gunite	E-5613-R
3133400	Volvo White GMC	E-9837	35336/37	Budd	E-7896-R	37556	Gunite	E-5613-L
3136A	Gunite	03-122455-002	3533637	Budd	E-7896-R	3758X	Gunite	85-123383-002
3136B	Gunite	03-122925-002	35337	Budd	E-7896-L	3760B	Gunite	03-122104-002
3141	Gunite	03-122550-002	3538353	Ford	E-1828	3760B	Gunite	03-123431-002
3141B	Gunite	03-123409-002	3544	Gunite	03-012480-002	3762598	GMC	E-4854
3141BX	Gunite	85-123409-002	355815	GMC	E-8965	3763619	GMC	E-5682
3141X	Gunite	53-123565-002	35581657	Ford	E-5018	3765876	GMC	E-5683
3141X	Gunite	85-122550-002	3576X	Gunite	85-123652-002	3767	Gunite	03-120855-002

Not an exact match. Quality level or bill of materials may differ between the Euclid and competitors part. Refer to Euclid catalog for complete information on Euclid Parts.

CROSS REFERENCE LISTING

COMPETITOR NUMBER	COMPETITOR NAME	EUCLID NUMBER	COMPETITOR NUMBER	COMPETITOR NAME	EUCLID NUMBER	COMPETITOR NUMBER	COMPETITOR NAME	EUCLID NUMBER
3771410	GMC	E-5734	38540	Trailmobile	E-540	385910R	Trailmobile	E-5910-R
37775	Trailmobile	E-618	385549L	Trailmobile	E-7895-L	385916L	Trailmobile	E-5916-L
3778640	GMC	E-5747	385549R	Trailmobile	E-7895-R	385916R	Trailmobile	E-5916-R
3782	Gunite	03-123520-002	385551L	Trailmobile	E-5551-L	385922L	Trailmobile	E-5922-L
3782X	Gunite	85-123520-002	385551R	Trailmobile	E-5551-R	385922R	Trailmobile	E-5922-R
37841	Trailmobile	E-5570	385552L	Trailmobile	E-5977-L	385923L	Trailmobile	E-5923-L
37849	Trailmobile	E-4962	385552R	Trailmobile	E-5977-R	385923R	Trailmobile	E-5923-R
37888	Budd	E-5652-R	385552RC	Trailmobile	E-5977-R	385924L	Trailmobile	E-5924-L
37888/89	Budd	E-5652-R	385553R	Trailmobile	E-5553-R	385924R	Trailmobile	E-5924-R
3788889	Budd	E-5652-R	385554L	Trailmobile	E-5554-L	385930L	Trailmobile	E-5930-L
37889	Budd	E-5652-L	385554R	Trailmobile	E-5554-R	385930R	Trailmobile	E-5930-R
37891	Budd	E-5977-R	3855553L	Trailmobile	E-5553-L	385931L	Trailmobile	E-5931-L
37892	Budd	E-5977-L	385556L	Trailmobile	E-5556-L	385931R	Trailmobile	E-5931-R
379656	GMC	E-4849	385556R	Trailmobile	E-5556-R	385932L	Trailmobile	E-5932-L
38-5840	Trailmobile	E-5840	385557L	Trailmobile	E-5557-L	385932R	Trailmobile	E-5932-R
3800X	Gunite	03-123448-002	385557R	Trailmobile	E-5557-R	385933R	Trailmobile	E-5933-R
3800X	Gunite	85-123448-002	385558L	Trailmobile	E-5558-L	385937L	Trailmobile	E-5937-L
3804000	Trailmobile	E-04000	385558R	Trailmobile	E-5558-R	385937R	Trailmobile	E-5937-R
3804075	Trailmobile	E-04075	385559L	Trailmobile	E-5559-L	385953	Trailmobile	E-5953
3804075H	Trailmobile	E-04075H	385560L	Trailmobile	E-5560-L	385960	Trailmobile	E-5960
3805500	Trailmobile	E-05500	385560R	Trailmobile	E-5560-R	385969	Trailmobile	E-5970
3807AX	Gunite	85-123570-002	385561L	Trailmobile	E-5561-L	385970	Trailmobile	E-5970
381087	Trailmobile	E-1087	385561R	Trailmobile	E-5561-R	385971	Trailmobile	E-5971
381251	Trailmobile	E-1251	385571A	Trailmobile	E-5571A	385972	Trailmobile	E-5972
381252	Trailmobile	E-1252	385572A	Trailmobile	E-5572A	385973	Trailmobile	E-5973
381253	Trailmobile	E-1253	385585L	Trailmobile	E-5585-L	385976	Trailmobile	E-5976
381559	Trailmobile	E-1559	385585R	Trailmobile	E-5585-R	385977L	Trailmobile	E-5977-L
381561	Trailmobile	E-1561	385588L	Trailmobile	E-5588-L	385977R	Trailmobile	E-5977-R
381828	Trailmobile	E-1828	385589L	Trailmobile	E-5589-L	385978L	Trailmobile	E-5978-L
381835	Trailmobile	E-1835	385589R	Trailmobile	E-5589-R	385978T	Trailmobile	E-5978-R
382002	Trailmobile	E-2002	385618L	Trailmobile	E-5618-L	385982L	Trailmobile	E-5982-L
382128	Trailmobile	E-2128	385618R	Trailmobile	E-5618-R	385982R	Trailmobile	E-5982-R
38214	Trailmobile	E-4962	385652L	Trailmobile	E-5652-L	385983L	Trailmobile	E-5983-L
38214	Trailmobile	E-4963	385652R	Trailmobile	E-5652-R	385983R	Trailmobile	E-5983-R
382237	Trailmobile	E-2237	385706	Trailmobile	E-5706	385985L	Trailmobile	E-5985-L
382296	Trailmobile	E-2296	385708	Trailmobile	E-5708	385985R	Trailmobile	E-5985-R
382297	Trailmobile	E-2297	385715L	Trailmobile	E-5715-L	385986L	Trailmobile	E-5986-L
382299	Trailmobile	E-2299	385715R	Trailmobile	E-5715-R	385986R	Trailmobile	E-5986-R
382301	Trailmobile	E-2301	385718L	Trailmobile	E-5718-L	385987L	Trailmobile	E-5987-L
382303	Trailmobile	E-2303	385718R	Trailmobile	E-5718-R	385987R	Trailmobile	E-5987-R
382304	Trailmobile	E-2304	385719L	Trailmobile	E-5719-L	385988L	Trailmobile	E-5988-L
382305	Trailmobile	E-2305	385719R	Trailmobile	E-5719-R	385988R	Trailmobile	E-5988-R
382340	Trailmobile	E-2340	38572	Trailmobile	E-572	385989L	Trailmobile	E-5989-L
382341	Trailmobile	E-2341	385720L	Trailmobile	E-5720-L	385989R	Trailmobile	E-5989-R
382420	Trailmobile	E-2420	385720R	Trailmobile	E-5720-R	385990L	Trailmobile	E-5990-L
382421	Trailmobile	E-2421	385724	Trailmobile	E-5724	385990R	Trailmobile	E-5990-R
382422	Trailmobile	E-2422	385727	Trailmobile	E-5727	385991	Trailmobile	E-5991
382425	Trailmobile	E-2425	385728	Trailmobile	E-5728	385993	Trailmobile	E-5993
382431	Trailmobile	E-2431	38573	Trailmobile	E-4955	385995L	Trailmobile	E-5995-L
382433	Trailmobile	E-2433	38573	Trailmobile	E-573	385995R	Trailmobile	E-5995-R
382434	Trailmobile	E-2434	385734	Trailmobile	E-5734	385996L	Trailmobile	E-5996-L
382435	Trailmobile	E-2435	385740	Trailmobile	E-5740	385996R	Trailmobile	E-5996-R
382436	Trailmobile	E-2436	385743	Trailmobile	E-5743	385997	Trailmobile	E-5997
382437	Trailmobile	E-2437	385747	Trailmobile	E-5747	385999	Trailmobile	E-5999
382461	Trailmobile	E-2461	385749L	Trailmobile	E-5749-L	3859999	Trailmobile	E-5999
382462	Trailmobile	E-2462	385755	Trailmobile	E-5755	386000	Trailmobile	E-6000A
382463	Trailmobile	E-2463	385756L	Trailmobile	E-5756-L	386001	Trailmobile	E-6001A
382464	Trailmobile	E-2464	385756R	Trailmobile	E-5756-R	386023L	Trailmobile	E-6023-L
382465	Trailmobile	E-2465	385757L	Trailmobile	E-5757-L	386023R	Trailmobile	E-6023-R
382467	Trailmobile	E-2467	385757R	Trailmobile	E-5757-R	386027L	Trailmobile	E-6027-L
382468	Trailmobile	E-2468	38576	Trailmobile	E-576	386027R	Trailmobile	E-6027-R
382550	Trailmobile	E-2550	385761	Trailmobile	E-5761	386028L	Trailmobile	E-6028-L
383010	Trailmobile	E-3010	385765L	Trailmobile	E-5765-L	386028R	Trailmobile	E-6028-R
383506	Trailmobile	E-3506	385765R	Trailmobile	E-5765-R	386030	Trailmobile	E-6030A
384227	Trailmobile	E-4227	385766L	Trailmobile	E-5766-L	386033L	Trailmobile	E-6033-L
384229	Trailmobile	E-4229	385766R	Trailmobile	E-5766-R	386033R	Trailmobile	E-6033-R
384230	Trailmobile	23-122729-002	385778	Trailmobile	E-5778	386034	Trailmobile	E-6034
384230	Trailmobile	E-4230	385783	Trailmobile	E-5783	386035	Trailmobile	E-6035
384232	Trailmobile	E-4232	385784A	Trailmobile	E-5784A	386054	Trailmobile	E-6054
384242	Trailmobile	E-4242	385799	Trailmobile	E-5799	386057L	Trailmobile	E-6057-L
384247	Trailmobile	E-4247	385816	Trailmobile	E-5816	386057R	Trailmobile	E-6057-R
384871	Trailmobile	E-4871	385824	Trailmobile	E-5824	386059L	Trailmobile	E-6059-L
384877	Trailmobile	E-4877	385825	Trailmobile	E-5825	386059R	Trailmobile	E-6059-R
384944	Trailmobile	E-4944	385829	Trailmobile	E-5829	386141	Trailmobile	E-6141
384946	Trailmobile	E-4946	385837	Trailmobile	E-5837	38618	Trailmobile	E-618
384956A	Trailmobile	E-4956A	385868L	Trailmobile	E-5868-L	38620	Trailmobile	E-620
384957	Trailmobile	E-4957	385868R	Trailmobile	E-5868-R	386789C1	Navistar	E-890
384958	Trailmobile	E-4958	385869L	Trailmobile	E-5869-L	3874369	GMC	E-8962
384961A	Trailmobile	E-4961A	385870L	Trailmobile	E-5870-L	3874371	GMC	E-4876
384962	Trailmobile	E-4962	385870R	Trailmobile	E-5870-R	387655	Trailmobile	E-7655
384963	Trailmobile	E-4963	385871L	Trailmobile	E-5871-L	387895L	Trailmobile	E-7895-L
384965L	Trailmobile	E-4965-L	385871R	Trailmobile	E-5871-R	387895R	Trailmobile	E-7895-R
384965R	Trailmobile	E-4965-R	385872	Trailmobile	E-5872	387896L	Trailmobile	E-7896-L
384966L	Trailmobile	E-4966-L	385885	Trailmobile	E-5885	387896R	Trailmobile	E-7896-R
384966R	Trailmobile	E-4966-R	385890	Trailmobile	E-5890	387897L	Trailmobile	E-7897-L
384967L	Trailmobile	E-4967-L	385892	Trailmobile	E-5892	387897R	Trailmobile	E-7897-R
384967R	Trailmobile	E-4967-R	385896L	Trailmobile	E-5896-L	388380	Ford	E-8959-R
384968L	Trailmobile	E-4968-L	385896R	Trailmobile	E-5896-R	388381	Ford	E-8959-L
384968R	Trailmobile	E-4968-R	385898R	Trailmobile	E-5898-R	38874	Trailmobile	E-619
384969L	Trailmobile	E-4969-L	385900L	Trailmobile	E-5900-L	388897T	Trailmobile	E-7897-R
384969R	Trailmobile	E-4969-R	385900R	Trailmobile	E-5900-R	388952L	Trailmobile	E-8952-L
384987A	Trailmobile	E-4987A	385902	Trailmobile	E-5902	388952R	Trailmobile	E-8952-R
385040A	Trailmobile	E-5040A	385904A	Trailmobile	E-5904A	388977L	Trailmobile	E-8977-L
385045	Trailmobile	E-5045	385905A	Trailmobile	E-5905A	388977R	Trailmobile	E-8977-R
385055	Trailmobile	E-5055	385906	Trailmobile	E-5906	388979L	Trailmobile	E-8979-L
38506	Trailmobile	E-1087	385910L	Trailmobile	E-5910-L	388979R	Trailmobile	E-8979-R

Not an exact match. Quality level or bill of materials may differ between the Euclid and competitors part. Refer to Euclid catalog for complete information on Euclid Parts.

CROSS REFERENCE LISTING

COMPETITOR NUMBER	COMPETITOR NAME	EUCLID NUMBER	COMPETITOR NUMBER	COMPETITOR NAME	EUCLID NUMBER	COMPETITOR NUMBER	COMPETITOR NAME	EUCLID NUMBER
388986	Trailmobile	E-8986	42230	Eaton	E-2465	499716	Volvo	E-5927
388987	Trailmobile	E-8987	42231	Eaton	E-2464	499716	Volvo White GMC	E-5927
389005L	Trailmobile	E-9005-L	42232	Eaton	E-2463	4C4Z1125A	Ford	E-12523
389005R	Trailmobile	E-9005-R	42233	Eaton	E-2468	4C4Z1125CA	Ford	E-12523
389010L	Trailmobile	E-9010-L	42234	Eaton	E-2467	4C4Z1125GC	Ford	E-6114
389010R	Trailmobile	E-9010-R	422821R1	Navistar	E-1828	4X1027	Meritor	E-5872
38937	Trailmobile	E-5571A	425282R1	Navistar	E-5579-L	4X1051	Meritor	E-4953
38975	Trailmobile	E-975	425283R1	Navistar	E-5579-R	4X1207	Meritor	E-4960
3918468	Volvo	85-123421-002	426957	Volvo	E-5571A	4X1424	Meritor	E-4958
39236	Trailmobile	E-540	426957	Volvo White GMC	E-5571A	4X1612	Meritor	E-5944
3927302	Budd	E-4960	427646	Navistar	E-4850	4X199	Meritor	E-5724
39303	Trailmobile	E-4958	42793	Budd	E-5796	50-1003L-90	Dana/Spicer	E-5556-L
3936464	GMC	E-4879	42955	Trailmobile	E-5572A	50-1004L-90	Dana/Spicer	E-5559-L
3953436	GMC	E-4865	431023	Trailmobile	E-2002	50-1004R-90	Dana/Spicer	E-5559-R
39604	Trailmobile	E-573	43212Z5025	Navistar	E-10253-R	50-1008L-90	Dana/Spicer	E-5551-L
39668	Trailmobile	E-5044	43241Z5025	Navistar	E-10254-R	50-1008R-90	Dana/Spicer	E-5551-R
39669	Trailmobile	E-4956A	43320	Trailmobile	E-5046	50-1067L-90	Dana/Spicer	E-5715-L
3988538	GMC	E-8963	43320	Trailmobile	E-5840	50-1067R-90	Dana/Spicer	E-5715-R
3988631	GMC	E-5892	43321	Trailmobile	E-4957	50-1081R-90	Dana/Spicer	E-5749-R
39969	Trailmobile	E-1000	437858C1	Navistar	E-9022-R	50-1122L-90	Dana/Spicer	E-4965-L
3AX1261	Mack	E-4990A	43801	Budd	E-4988-R	50-1122R-90	Dana/Spicer	E-4965-R
3AX1901	Mack	E-4990A	43802	Budd	E-4988-L	50-1164R-90	Dana/Spicer	E-5720-R
400245A	Volvo	E-5044	438061R1	Navistar	E-5898-L	50-1182R-90	Dana/Spicer	E-5896-R
400245A	Volvo White GMC	E-5044	438062R1	Navistar	E-5898-R	50-1202R-90	Dana/Spicer	E-5588-R
401551	Haldex	E-7655	43935	Gunite	E-5007	50-1251R-90	Dana/Spicer	E-5916-R
401575	Haldex	E-2340	44051	Trailmobile	E-5040A	50-1320L	Dana/Spicer	E-5610-L
401575P	Haldex	E-2340	441255C1	Navistar	E-4870	50-1321L	Dana/Spicer	E-5612-L
401576	Haldex	E-2341	441256C1	Navistar	E-4852	50-1326L	Dana/Spicer	E-5613-L
401576P	Haldex	E-2341	443660C1	Navistar	E-5721-L	50-1326R	Dana/Spicer	E-5613-R
401577	Haldex	E-2431	443661C1	Navistar	E-5721-R	50-33A-10/9	Trailmobile	E-5556-R
401577P	Haldex	E-2431	44577	Budd	E-5798	50-33A-25/26	Trailmobile	E-4968-R
401578	Haldex	E-2432	44668H	Navistar	E-5551-R	50-33A-29/30	Trailmobile	E-4966-R
401578P	Haldex	E-2432	44669H	Navistar	E-5551-L	50-34A-1/2	Trailmobile	E-5652-R
401579	Haldex	E-2433	446729	Budd	E-1828	50-34B-1/2	Trailmobile	E-7895-R
401579P	Haldex	E-2433	447556R1	Navistar	E-5750-L	50-34C-10	Trailmobile	E-5578-L
401580	Haldex	E-2434	447557R1	Navistar	E-5750-R	50-34C-2/1	Trailmobile	E-5977-R
401580P	Haldex	E-2434	448888A	Volvo	E-5572A	5000438684	Mack	E-8991
401581	Haldex	E-2435	448888A	Volvo White GMC	E-5572A	5000471861	Mack	E-6000A
401581P	Haldex	E-2435	451061A	Volvo	E-5040A	501000L	Dana/Spicer	E-5558-L
401582	Haldex	E-2436	451061A	Volvo White GMC	E-5040A	501000R	Dana/Spicer	E-5558-R
401582P	Haldex	E-2436	451941C1	Navistar	E-6138	501003L	Dana/Spicer	E-5556-L
401583	Haldex	E-2437	452010C1	Navistar	E-6054	501003R	Dana/Spicer	E-5556-R
401583P	Haldex	E-2437	453127	White Truck	E-2435	501004L	Dana/Spicer	E-5559-L
401584	Haldex	E-2438	45631	Budd	E-3727-R	501004R	Dana/Spicer	E-5559-R
402136	Std. Forge	E-1828	45632	Budd	E-3727-L	501006L	Dana/Spicer	E-5561-L
40336	Budd	E-4988-R	45681	Gunite	E-5734	501006R	Dana/Spicer	E-5561-R
40337	Budd	E-4988-L	46009	Gunite	E-5683	501007L	Dana/Spicer	E-5560-L
40338	Budd	E-5588-R	46010	Gunite	E-5816	501007R	Dana/Spicer	E-5560-R
40339	Budd	E-5588-L	462596	White Truck	E-2435	501008L	Dana/Spicer	E-5551-L
403926	Volvo	E-5743	462598	White Truck	E-5960	501008R	Dana/Spicer	E-5551-R
403961C1	Navistar	E-5905A	46578	Hendrickson	E-5736	501009L	Dana/Spicer	E-5585-L
4074	Gunite	E-576	466121A	Volvo	E-5045	501009R	Dana/Spicer	E-5585-R
409	Reyco	04-15502-021	466121A	Volvo White GMC	E-5045	501010L	Dana/Spicer	E-5553-L
410737	Budd	E-4961A	466884	White Truck	E-2433	501010R	Dana/Spicer	E-5553-R
4117	Reyco	04-15502-021	466885	White Truck	E-5740	501012L	Dana/Spicer	E-6023-L
41129	Trailmobile	E-5047	467018C1	Navistar	E-5796	501012R	Dana/Spicer	E-6023-R
411655	Haldex	E-04075	467836	White Truck	E-2438	501013L	Dana/Spicer	E-5557-L
411655P	Haldex	E-04075	467837	Volvo	E-5952	501013R	Dana/Spicer	E-5557-R
411872	Haldex	E-04075H	469025C1	Navistar	E-5923-L	501020L	Dana/Spicer	E-10200-L
411872P	Haldex	E-04075H	469026C1	Navistar	E-5923-R	501020R	Dana/Spicer	E-10200-R
411B	HDA	E-5706	469609C1	Navistar	E-5868-R	501021L	Dana/Spicer	E-5989-L
412	Reyco	04-15984-001	469609C7	Navistar	E-5868-R	501021R	Dana/Spicer	E-5989-R
41233	Budd	E-4976-R	469610C1	Navistar	E-5868-L	501025L	Dana/Spicer	E-5932-L
41419V	Navistar	E-7895-R	469610C7	Navistar	E-5868-L	501025R	Dana/Spicer	E-5932-R
41420V	Navistar	E-7895-L	470421C1	Navistar	E-4871	501026L	Dana/Spicer	E-5931-L
42194	Eaton	E-572	470422C1	Navistar	E-4877	501026R	Dana/Spicer	E-5931-R
42195	Eaton	E-573	47147	Budd	E-4979-R	501027L	Dana/Spicer	E-5933-L
42196	Eaton	E-540	472007R1	Navistar	E-5986-R	501027R	Dana/Spicer	E-5933-R
42197	Eaton	E-2237	472008R1	Navistar	E-5986-L	501028L	Dana/Spicer	E-5929-L
42198	Eaton	E-1251	472277C1	Navistar	E-5902	501028R	Dana/Spicer	E-5929-R
42199	Eaton	E-1252	473629	GMC	E-4873	501029L	Dana/Spicer	E-5930-L
42200	Eaton	E-2128	473636	GMC	E-4856	501029R	Dana/Spicer	E-5930-R
42201	Eaton	E-1253	476375	White Truck	E-2340	501031L	Dana/Spicer	E-6024-L
42202	Eaton	E-2550	476937	Budd	E-4961A	501031R	Dana/Spicer	E-6024-R
42203	Eaton	E-1561	476938	Budd	E-1835	501041L	Dana/Spicer	E-5876-L
42204	Eaton	E-1559	484188C1	Navistar	E-6139	501041R	Dana/Spicer	E-5876-R
42205	Eaton	E-2299	4842	Hendrickson	E-1835	501061L	Dana/Spicer	E-5713-L
42206	Eaton	E-2296	4842P	HDA	E-1835	501061R	Dana/Spicer	E-5713-R
42207	Eaton	E-2297	48796H	Navistar	E-5551-L	501062L	Dana/Spicer	E-5714-L
42209	Eaton	E-2300	48797H	Navistar	E-5551-R	501062R	Dana/Spicer	E-5714-R
42210	Eaton	E-2301	48966	Budd	E-5801	501063L	Dana/Spicer	E-5716-L
42211	Eaton	E-2302	49328	Budd	E-4960	501063R	Dana/Spicer	E-5716-R
42216	Eaton	E-2420	49414	Budd	E-7898-R	501064L	Dana/Spicer	E-5589-L
42217	Eaton	E-2422	494145	Budd	E-7898-R	501064R	Dana/Spicer	E-5589-R
42218	Eaton	E-2421	49415	Budd	E-7898-L	501066L	Dana/Spicer	E-5717-L
42219	Eaton	E-2423	49416	Budd	E-5576-R	501066R	Dana/Spicer	E-5717-R
42220	Eaton	E-2425	49416/17	Budd	E-5576-R	501067L	Dana/Spicer	E-5715-L
42221	Eaton	E-2424	4941617	Budd	E-5576-R	501067R	Dana/Spicer	E-5715-R
42222	Eaton	E-2303	494167	Budd	E-5576-R	501080L	Dana/Spicer	E-5897-L
42223	Eaton	E-2305	49417	Budd	E-5576-L	501080R	Dana/Spicer	E-5897-R
42224	Eaton	E-2304	49748	Gunite	E-5704	501081L	Dana/Spicer	E-5749-L
42225	Eaton	E-6142	49851	Budd	E-4968-R	501081R	Dana/Spicer	E-5749-R
42226	Eaton	E-2462	49851/52	Budd	E-4968-R	501082L	Dana/Spicer	E-5748-L
42227	Eaton	E-2462	498512	Budd	E-4968-R	501082R	Dana/Spicer	E-5748-R
42228	Eaton	E-2461	4985152	Budd	E-4968-R	501084L	Dana/Spicer	E-10224-L
42229	Eaton	E-2460	49852	Budd	E-4968-L	501084R	Dana/Spicer	E-10224-R

Not an exact match. Quality level or bill of materials may differ between the Euclid and competitors part. Refer to Euclid catalog for complete information on Euclid Parts.

CROSS REFERENCE LISTING

COMPETITOR NUMBER	COMPETITOR NAME	EUCLID NUMBER	COMPETITOR NUMBER	COMPETITOR NAME	EUCLID NUMBER	COMPETITOR NUMBER	COMPETITOR NAME	EUCLID NUMBER
501085L	Dana/Spicer	E-5750-L	501205L	Dana/Spicer	E-5618-L	511009L	Dana/Spicer	E-5988-L
501085R	Dana/Spicer	E-5750-R	501205R	Dana/Spicer	E-5618-R	511009R	Dana/Spicer	E-5988-R
501087L	Dana/Spicer	E-5986-L	501225	Dana/Spicer	E-5632	511010L	Dana/Spicer	E-5978-L
501087R	Dana/Spicer	E-5986-R	501250L	Dana/Spicer	E-5924-L	511010R	Dana/Spicer	E-5978-R
501088L	Dana/Spicer	E-5899-L	501250R	Dana/Spicer	E-5924-R	511011L	Dana/Spicer	E-5978-L
501088R	Dana/Spicer	E-5899-R	501251L	Dana/Spicer	E-5916-L	511011R	Dana/Spicer	E-5978-R
501089L	Dana/Spicer	E-5898-L	501251R	Dana/Spicer	E-5916-R	511012L	Dana/Spicer	E-5977-L
501089R	Dana/Spicer	E-5898-R	501253L	Dana/Spicer	E-5923-L	511012R	Dana/Spicer	E-5977-R
501092L	Dana/Spicer	E-8995-L	501253R	Dana/Spicer	E-5923-R	511013L	Dana/Spicer	E-5652-L
501092R	Dana/Spicer	E-8995-R	501260L	Dana/Spicer	E-6026-L	511013R	Dana/Spicer	E-5652-R
501093L	Dana/Spicer	E-9001-L	501260R	Dana/Spicer	E-6026-R	511014L	Dana/Spicer	E-6060-L
501093R	Dana/Spicer	E-9001-R	501261L	Dana/Spicer	E-6028-L	511014R	Dana/Spicer	E-6060-R
501093R	Dana/Spicer	E-9001-L	501261R	Dana/Spicer	E-6028-R	511015L	Dana/Spicer	E-5576-L
501093R	Dana/Spicer	E-9001-R	501263L	Dana/Spicer	E-6058-L	511015R	Dana/Spicer	E-5576-R
501095L	Dana/Spicer	E-5868-L	501263R	Dana/Spicer	E-6058-R	511017L	Dana/Spicer	E-5554-L
501095R	Dana/Spicer	E-5868-R	501264L	Dana/Spicer	E-6059-L	511017R	Dana/Spicer	E-5554-R
501096L	Dana/Spicer	E-5985-L	501264R	Dana/Spicer	E-6059-R	511018L	Dana/Spicer	E-5579-L
501096R	Dana/Spicer	E-5985-R	501265L	Dana/Spicer	E-6027-L	511018R	Dana/Spicer	E-5579-R
501097L	Dana/Spicer	E-5982-L	501265R	Dana/Spicer	E-6027-R	511019R	Dana/Spicer	E-5578-R
501097R	Dana/Spicer	E-5982-R	501267	Dana/Spicer	E-6036	511020	Dana/Spicer	E-4961A
501098L	Dana/Spicer	E-10249-L	501268	Dana/Spicer	E-6035	511021	Dana/Spicer	E-1835
501098R	Dana/Spicer	E-10249-R	501269	Dana/Spicer	E-6034	511022	Dana/Spicer	E-1828
501110	Dana/Spicer	E-5682	501274	Dana/Spicer	E-5993	511025R	Dana/Spicer	E-4976-R
5011101R	Dana/Spicer	E-5558-R	501275	Dana/Spicer	E-5994	511029	Dana/Spicer	E-5892
501111	Dana/Spicer	E-5683	501284	Dana/Spicer	E-5998	511030	Dana/Spicer	E-5734
501112	Dana/Spicer	E-5816	501285	Dana/Spicer	E-5997	511031	Dana/Spicer	E-5704
501113	Dana/Spicer	E-5724	501286	Dana/Spicer	E-5999	511032	Dana/Spicer	E-5991
501115	Dana/Spicer	E-10229	501291L	Dana/Spicer	E-5922-L	511033	Dana/Spicer	E-6000A
501116	Dana/Spicer	E-10230	501291R	Dana/Spicer	E-5922-R	511107	Ford	E-4988-R
501120L	Dana/Spicer	E-4964-L	501295L	Dana/Spicer	E-5918-L	511108	Ford	E-4988-L
501120R	Dana/Spicer	E-4964-R	501295R	Dana/Spicer	E-5918-R	511403	Dana/Spicer	E-6053
501121L	Dana/Spicer	E-5764-L	501297L	Dana/Spicer	E-5920-L	51174B	Webb	85-122966-002
501121R	Dana/Spicer	E-5764-R	501297R	Dana/Spicer	E-5920-R	51207V	Navistar	E-4853
501122L	Dana/Spicer	E-4965-L	501320R	Dana/Spicer	E-5610-R	512633C1	Navistar	E-5891
501122R	Dana/Spicer	E-4965-R	501321R	Dana/Spicer	E-5612-R	52-1320	Dana/Spicer	E-5840
501123L	Dana/Spicer	E-4966-L	502786	Fruehauf	E-5551-L	52-1352	Dana/Spicer	E-5041
501123R	Dana/Spicer	E-4966-R	502787	Fruehauf	E-5551-R	52-1355	Dana/Spicer	E-5782
501124L	Dana/Spicer	E-5870-L	502A7C	Trailmobile	E-4962	52-1376	Dana/Spicer	E-5882
501124R	Dana/Spicer	E-5870-R	502Z69	Trailmobile	E-2002	52-1425	Dana/Spicer	E-5754
501126	Dana/Spicer	E-5775	50325R1	Navistar	E-4855	52-1435	Dana/Spicer	E-5746
501127L	Dana/Spicer	E-4967-L	5033A10	Trailmobile	E-5556-L	521300	Dana/Spicer	E-5570
501127R	Dana/Spicer	E-4967-R	5033A109	Trailmobile	E-5556-R	521301	Dana/Spicer	E-5571A
501128L	Dana/Spicer	E-4968-L	5033A15	Trailmobile	E-5553-R	521303	Dana/Spicer	E-5045
501128R	Dana/Spicer	E-4968-R	5033A16	Trailmobile	E-5553-L	521304	Dana/Spicer	E-5040A
501129	Dana/Spicer	E-5776	5033A25	Trailmobile	E-4968-R	521305	Dana/Spicer	E-5044
501131L	Dana/Spicer	E-4969-L	5033A2526	Trailmobile	E-4968-R	521306	Dana/Spicer	E-5572A
501131R	Dana/Spicer	E-4969-R	5033A26	Trailmobile	E-4968-L	521307	Dana/Spicer	E-5785A
501133L	Dana/Spicer	E-5765-L	5033A27	Trailmobile	E-4965-R	521309	Dana/Spicer	E-5784A
501133R	Dana/Spicer	E-5765-R	5033A28	Trailmobile	E-4965-L	521320	Dana/Spicer	E-5046
501134L	Dana/Spicer	E-5756-L	5033A29	Trailmobile	E-4966-R	521321	Dana/Spicer	E-5047
501134R	Dana/Spicer	E-5756-R	5033A2930	Trailmobile	E-4966-R	521331	Dana/Spicer	E-5573
501135L	Dana/Spicer	E-5757-L	5033A30	Trailmobile	E-4966-L	521335	Dana/Spicer	E-5906
501135R	Dana/Spicer	E-5757-R	5033A31	Trailmobile	E-5764-R	521336	Dana/Spicer	E-5905A
501136L	Dana/Spicer	E-5766-L	5033A32	Trailmobile	E-5764-L	521337	Dana/Spicer	E-5904A
501136R	Dana/Spicer	E-5766-R	5033A37	Trailmobile	E-5585-R	521358	Dana/Spicer	E-5974
501137L	Dana/Spicer	E-5869-L	5033A38	Trailmobile	E-5585-L	521368	Dana/Spicer	E-6054
501137R	Dana/Spicer	E-5869-R	5033A9	Trailmobile	E-5556-R	521369	Dana/Spicer	E-5837
501146	Dana/Spicer	E-6030A	5034A1	Trailmobile	E-5652-R	521370	Dana/Spicer	E-5747
501147	Dana/Spicer	E-6029A	5034A12	Trailmobile	E-5652-L	521371	Dana/Spicer	E-5753
501148	Dana/Spicer	E-6001A	5034A2	Trailmobile	E-5652-L	521372	Dana/Spicer	E-5755
501152L	Dana/Spicer	E-8994-L	5034A7	Trailmobile	E-4961A	521375	Dana/Spicer	E-5055
501152R	Dana/Spicer	E-8994-R	5034B1	Trailmobile	E-7895-R	521377	Dana/Spicer	E-5823
501155L	Dana/Spicer	E-8992-L	5034B11	Trailmobile	E-7898-R	521378	Dana/Spicer	E-5822
501155R	Dana/Spicer	E-8992-R	5034B12	Trailmobile	E-7895-R	521379	Dana/Spicer	E-5820
501156L	Dana/Spicer	E-8993-L	5034B12	Trailmobile	E-7898-L	521380	Dana/Spicer	E-5781
501156R	Dana/Spicer	E-8993-R	5034B2	Trailmobile	E-7895-L	521381	Dana/Spicer	E-5783
501160L	Dana/Spicer	E-5718-L	5034B6	Trailmobile	E-5988-L	521382	Dana/Spicer	E-5821
501160R	Dana/Spicer	E-5718-R	5034C1	Trailmobile	E-5977-R	521385	Dana/Spicer	E-5885
501161L	Dana/Spicer	E-5719-L	5034C13	Trailmobile	E-5576-R	521390	Dana/Spicer	E-5883
501161R	Dana/Spicer	E-5719-R	5034C14	Trailmobile	E-5576-L	521392	Dana/Spicer	E-5827
501162L	Dana/Spicer	E-5911-L	5034C19	Trailmobile	E-5991	521394	Dana/Spicer	E-5828
501162R	Dana/Spicer	E-5911-R	5034C2	Trailmobile	E-5977-L	521395	Dana/Spicer	E-5829
501163L	Dana/Spicer	E-5900-L	5034C21	Trailmobile	E-5977-R	521400	Dana/Spicer	E-5976
501163R	Dana/Spicer	E-5900-R	5034C5	Trailmobile	E-5579-R	521405	Dana/Spicer	E-5824
501164L	Dana/Spicer	E-5720-L	5034C6	Trailmobile	E-5579-L	521407	Dana/Spicer	E-5825
501164R	Dana/Spicer	E-5720-R	5034C9	Trailmobile	E-5578-R	521410	Dana/Spicer	E-5953
501165L	Dana/Spicer	E-5910-L	503550	Chrysler	E-7895-R	521411	Dana/Spicer	E-5973
501165R	Dana/Spicer	E-5910-R	503551	Chrysler	E-7895-L	521420	Dana/Spicer	E-5036
501170L	Dana/Spicer	E-5721-L	507305	Fruehauf	E-5746	521421	Dana/Spicer	E-5889
501170R	Dana/Spicer	E-5721-R	50764V	Navistar	E-4868	521422	Dana/Spicer	E-5890
501173L	Dana/Spicer	E-5722-L	508865	Fruehauf	E-5560-R	521423	Dana/Spicer	E-5891
501173R	Dana/Spicer	E-5722-R	509360	Fruehauf	E-5560-L	521430	Dana/Spicer	E-5902
501181L	Dana/Spicer	E-5871-L	5095	Erie	E-4989	521431	Dana/Spicer	E-9023
501181R	Dana/Spicer	E-5871-R	5095R	Erie	E-4989	521436	Dana/Spicer	E-5838
501182L	Dana/Spicer	E-5896-L	51-1019L	Dana/Spicer	E-5578-L	521440	Dana/Spicer	E-5927
501182R	Dana/Spicer	E-5896-R	511003L	Dana/Spicer	E-5988-L	521441	Dana/Spicer	E-5926
501183L	Dana/Spicer	E-5909-L	511003R	Dana/Spicer	E-5988-R	521445	Dana/Spicer	E-5780
501183R	Dana/Spicer	E-5909-R	511005L	Dana/Spicer	E-7895-L	5247	Erie	E-5761
501185L	Dana/Spicer	E-5983-L	511005R	Dana/Spicer	E-7895-R	5247R	Erie	E-5761
501185R	Dana/Spicer	E-5983-R	511005RBULK	Dana/Spicer	E-7895-R	5259	Erie	E-4956A
501200L	Dana/Spicer	E-5587-L	511006L	Dana/Spicer	E-7896-L	5260	Erie	E-4963
501200R	Dana/Spicer	E-5587-R	511006R	Dana/Spicer	E-7896-R	5270	Erie	E-4962
501201L	Dana/Spicer	E-4988-L	511007L	Dana/Spicer	E-7897-L	53-123512	Paccar	53-123512-002
501201R	Dana/Spicer	E-4988-R	511007R	Dana/Spicer	E-7897-R	53-123535	Paccar	53-123535-002
501202L	Dana/Spicer	E-5588-L	511008L	Dana/Spicer	E-7898-L	53-123537	Paccar	53-123537-002
501202R	Dana/Spicer	E-5588-R	511008R	Dana/Spicer	E-7898-R	53-123537-002	Trailmobile	53-123537-002

Not an exact match. Quality level or bill of materials may differ between the Euclid and competitors part. Refer to Euclid catalog for complete information on Euclid Parts.

CROSS REFERENCE LISTING

COMPETITOR NUMBER	COMPETITOR NAME	EUCLID NUMBER	COMPETITOR NUMBER	COMPETITOR NAME	EUCLID NUMBER	COMPETITOR NUMBER	COMPETITOR NAME	EUCLID NUMBER
53-123542	Paccar	53-123542-002	54-1641-90	Dana/Spicer	E-5032	59067	Budd	E-5756-L
53-123544	Paccar	53-123544-002	54102	Webb	E-11322	59183	Budd	E-4969-R
53-123544-002	Paccar	53-123544-002	54102P	Webb	E-11322	59183/84	Budd	E-4969-R
53-123564	Paccar	53-123564-002	54103	Dayton-Walthers	E-4227	591834	Budd	E-4969-R
53-123564-002	Trailmobile	53-123564-002	54103	Webb	E-4227	5918384	Budd	E-4969-R
53-123565	Paccar	53-123565-002	54104	Webb	E-11310	59184	Budd	E-4969-L
53-123566	Paccar	53-123566-002	54104	Webb	E-11313	59191	Budd	E-4965-R
53-123566-002	Trailmobile	53-123566-002	54104F	Webb	E-11313	59191/92	Budd	E-4965-R
53-123567	Paccar	53-123567-002	54106	Webb	E-11313	591912	Budd	E-4965-R
53-123568	Paccar	53-123568-002	541602	Dana/Spicer	E-5796	5919192	Budd	E-4965-R
53-123575	Paccar	53-123575-002	541606	Dana/Spicer	E-5798	59192	Budd	E-4965-L
53-123579	Paccar	53-123579-002	541607	Dana/Spicer	E-5799	59192	Budd	E-4965-R
53-123580	Paccar	53-123580-002	541614	Dana/Spicer	E-5800	59263	Budd	E-4966-R
53-123581	Paccar	53-123581-002	541618	Dana/Spicer	E-5954	59263/64	Budd	E-4966-R
53-123582-002	Paccar	53-123582-002	541619	Dana/Spicer	E-5801	592634	Budd	E-4966-R
53-123583-002	Paccar	53-123583-002	541620	Dana/Spicer	E-4953	5926364	Budd	E-4966-R
53-123588	Paccar	53-123588-002	541621	Dana/Spicer	E-5872	59264	Budd	E-4966-L
53-123589	Paccar	53-123589-002	541624	Dana/Spicer	E-5955	593096C1	Navistar	E-8972-L
53-123590	Paccar	53-123590-002	541627	Dana/Spicer	E-4960	593097C1	Navistar	E-8972-R
53-123592-002	Paccar	53-123592-002	541630	Dana/Spicer	E-5737	59364	Budd	E-4964-R
53-123598	Paccar	53-123598-002	541631	Dana/Spicer	E-5736	59364/65	Budd	E-4964-R
53-123600	Paccar	53-123600-002	541632	Dana/Spicer	E-5952	593645	Budd	E-4964-R
53-123601	Paccar	53-123601-002	541633	Dana/Spicer	E-5739	5936465	Budd	E-4964-R
53-123602	Paccar	53-123602-002	541634	Dana/Spicer	E-5740	59365	Budd	E-4964-L
53-123605	Paccar	53-123605-002	541635	Dana/Spicer	E-5957	59371	Budd	E-5869-R
53-123606	Paccar	53-123606-002	541636	Dana/Spicer	E-5742	59371/72	Budd	E-5869-R
53-123607	Paccar	53-123607-002	541637	Dana/Spicer	E-5743	593712	Budd	E-5869-R
53-123608	Paccar	53-123608-002	541638	Dana/Spicer	E-5960	5937172	Budd	E-5869-R
53-123609	Paccar	53-123609-002	541640	Dana/Spicer	E-5961	59372	Budd	E-5869-L
53-123609-002	Paccar	53-123609-002	541641	Dana/Spicer	E-5032	59373	Budd	E-5766-R
53-123627	Paccar	53-123627-002	541642	Dana/Spicer	E-5962	59373/74	Budd	E-5766-R
530085	Fruehauf	E-620	541643	Dana/Spicer	E-5963	593734	Budd	E-5766-R
530088	Fruehauf	E-576	541644	Dana/Spicer	E-5964	5937374	Budd	E-5766-R
5300RH	Erie	E-5932-R	541645	Dana/Spicer	E-2002	59374	Budd	E-5766-L
5301LH	Erie	E-5932-L	541647	Dana/Spicer	E-5970	59375	Budd	E-5757-R
5302RH	Erie	E-7895-R	541648	Dana/Spicer	E-5972	59375/76	Budd	E-5757-R
5303LH	Erie	E-7895-L	541650	Dana/Spicer	E-5970	593756	Budd	E-5757-R
5304RH	Erie	E-5977-R	541651	Dana/Spicer	E-5972	5937576	Budd	E-5757-R
5305LH	Erie	E-5977-L	541660	Dana/Spicer	E-5970	59376	Budd	E-5757-L
5308RH	Erie	E-8947-R	541661	Dana/Spicer	E-5972	59536	Budd	E-5618-R
5309LH	Erie	E-8947-L	54251	Dayton-Walthers	E-4231	59536/37	Budd	E-5618-R
53123535002	Volvo	53-123535-002	54251	Webb	E-4231	5953637	Budd	E-5618-R
53123567002	Freightliner	53-123567-002	54251F	Webb	E-11309	595367	Budd	E-5618-R
53123567002	Volvo	53-123567-002	54251F	Webb	E-4231	59537	Budd	E-5618-L
53123605002	Mack	53-123605-002	54301	Webb	23-122729-002	59790R1	Navistar	E-5618-L
5312RH	Erie	E-5978-R	54301	Webb	E-4230	59791R1	Navistar	E-5618-R
531306	Dana/Spicer	E-5706	54301F	Webb	E-11320	597991C1	Navistar	E-8979-L
531378	Chrysler	E-5957	54351	Dayton-Walthers	E-4228	597992C1	Navistar	E-8979-R
5313LH	Erie	E-5978-L	54351	Webb	E-4228	59863H	Navistar	E-5553-R
531500	Dana/Spicer	E-4958	54351F	Webb	E-4228	59864H	Navistar	E-5553-L
531501	Dana/Spicer	E-4956A	54492R1	Navistar	E-4963	59891	Budd	E-5018
531502	Dana/Spicer	E-4957	54493R2	Navistar	E-5571A	6-3-3	Trailmobile	E-618
531511	Dana/Spicer	E-5726	54494R1	Navistar	E-4956A	6-3-5	Trailmobile	E-1087
531512	Dana/Spicer	E-4958	54700R1	Navistar	E-5960	6-3-7	Trailmobile	E-540
531513	Dana/Spicer	E-5727	54769	Webb	E-6114	6-4-2	Trailmobile	E-572
531514	Dana/Spicer	E-4955	54769F	Webb	E-6114	6-5-1	Trailmobile	E-617
531517	Dana/Spicer	E-5728	54770	Webb	E-6115	6-5-8	Trailmobile	E-573
531518	Dana/Spicer	E-5729	54771	Webb	E-12523	6-5-9	Trailmobile	E-1000
531525	Dana/Spicer	E-4987A	54771F	Webb	E-11311	6-6-2	Trailmobile	E-1001
531530	Dana/Spicer	E-5887	54771P	Webb	E-12523	6-6-6	Trailmobile	E-619
531540	Dana/Spicer	E-5012	54771P65	Webb	E-12523	60152B	Webb	85-123399-002
531550	Dana/Spicer	E-4989	549807C1	Navistar	E-5922-L	60162B	Webb	85-123400-002
531551	Dana/Spicer	E-5761	549809C1	Navistar	E-9000-L	60421R1	Navistar	E-5872
531555	Dana/Spicer	E-5018	549810C1	Navistar	E-9000-R	6043825	Volvo	E-4968-R
531560	Dana/Spicer	E-4962	55585H	Navistar	E-4960	6043826	Volvo	E-4968-L
531561	Dana/Spicer	E-4963	56152R2	Navistar	E-2435	60528B	Webb	53-123512-002
5322RH	Erie	E-6034	5667139	GMC	E-5571A	60528B	Webb	85-123254-002
5324RH	Erie	E-6035	56AX120	Mack	E-10238	60545B	Webb	53-123568-002
5326RH	Erie	E-6000A	56AX128	Mack	E-10238	60793R2	Navistar	E-5798
534764	Fruehauf	E-5977-R	573922C1	Navistar	E-6114	60854B	Webb	85-123570-002
534765	Fruehauf	E-5977-L	576140	GMC	E-5040A	60864	Webb	53-123537-002
534766	Fruehauf	E-7895-R	576711C1	Navistar	E-8955-L	60864B	Webb	53-123537-002
534767	Fruehauf	E-7895-L	576712C1	Navistar	E-8955-R	60875B	Webb	53-123566-002
534768	Fruehauf	E-5652-R	5767139	GMC	E-5045	60875B	Webb	85-123409-002
534769	Fruehauf	E-5652-L	5767140	GMC	E-5040A	60876	Webb	03-120877-002
534770	Fruehauf	E-5558-R	577227	GMC	E-5754	60895	Webb	53-123565-002
534771	Fruehauf	E-5558-L	578997C1	Navistar	E-5837	60895B	Webb	53-123565-002
534772	Fruehauf	E-5561-R	581674C1	Navistar	E-5898-L	60895B	Webb	85-122550-002
534773	Fruehauf	E-5561-L	581694C1	Navistar	E-6141	610044	Dorman	E-5561-R
534780	Fruehauf	E-5556-R	582884	Fruehauf	E-5589-R	610045	Dorman	E-5561-L
534781	Fruehauf	E-5556-L	582885	Fruehauf	E-5589-L	610046	Dorman	E-5551-R
534782	Fruehauf	E-5559-R	582886	Fruehauf	E-4969-R	610047	Dorman	E-5551-L
534783	Fruehauf	E-5559-L	582887	Fruehauf	E-4969-L	610050	Dorman	E-4965-R
534784	Fruehauf	E-5557-R	584071C1	Navistar	E-10201-L	610051	Dorman	E-4965-L
534785	Fruehauf	E-5557-L	584072C1	Navistar	E-10201-R	610052	Dorman	E-4988-R
535406	Fruehauf	E-5044	585192	Chrysler	E-5652-R	610053	Dorman	E-4988-L
535414	Fruehauf	E-5572A	585193	Chrysler	E-5652-L	610054	Dorman	E-5718-R
535860PKG	Fruehauf	E-4958	585194	Chrysler	E-5977-R	610055	Dorman	E-5718-L
535920	Fruehauf	E-5553-R	585195	Chrysler	E-5977-L	610060	Dorman	E-5556-R
535921	Fruehauf	E-5553-L	588126C1	Navistar	E-4232	610061	Dorman	E-5556-L
536365	Fruehauf	E-4988-L	589843C1	Navistar	E-4231	610062	Dorman	E-5558-R
54-1602-90	Dana/Spicer	E-5796	589868C1	Navistar	E-4240	610063	Dorman	E-5558-L
54-1614-90	Dana/Spicer	E-5800	59066	Budd	E-5756-R	610064	Dorman	E-5559-R
54-1619-90	Dana/Spicer	E-5801	59066/67	Budd	E-5756-R	610065	Dorman	E-5559-L
54-1621-90	Dana/Spicer	E-5872	5906667	Budd	E-5756-R	610066	Dorman	E-5553-R
54-1638-90	Dana/Spicer	E-5960	590667	Budd	E-5756-R	610067	Dorman	E-5553-L

Not an exact match. Quality level or bill of materials may differ between the Euclid and competitors part. Refer to Euclid catalog for complete information on Euclid Parts.

CROSS REFERENCE LISTING

COMPETITOR NUMBER	COMPETITOR NAME	EUCLID NUMBER	COMPETITOR NUMBER	COMPETITOR NAME	EUCLID NUMBER	COMPETITOR NUMBER	COMPETITOR NAME	EUCLID NUMBER
610068	Dorman	E-5560-R	64414	Webb	03-122575-002	67147	Budd	E-4975-R
610069	Dorman	E-5560-L	64414F	Webb	03-122575-002	67200	HalDEX	E-5570
610088	Dorman	E-4967-L	644158	GMC	E-5841	67201	HalDEX	E-5045
610089	Dorman	E-4967-R	64420	Webb	03-120517-002	67202	HalDEX	E-5571A
610145	Dorman	E-4955	64420F	Webb	03-120517-002	67203	HalDEX	E-5572A
610146	Dorman	E-4956A	64453	Webb	03-122314-002	67204	HalDEX	E-4958
610208	Dorman	E-4966-R	64453F	Webb	03-122314-002	67205	HalDEX	E-4956A
610209	Dorman	E-4966-L	64478	Webb	03-122078-002	67206	HalDEX	E-4962
611028	Dorman	E-5652-R	64478F	Webb	03-122078-002	67207	HalDEX	E-4963
611029	Dorman	E-5652-L	64481	Webb	03-120981-002	67209	HalDEX	E-7895-R
611032	Dorman	E-7895-R	64481F	Webb	03-120981-002	67210	HalDEX	E-7895-L
611033	Dorman	E-7895-R	64489	Webb	03-123020-002	67211	HalDEX	E-5977-R
611034	Dorman	E-5977-R	64489F	Webb	03-123020-002	67212	HalDEX	E-5977-L
611035	Dorman	E-5977-R	65152B	Webb	85-123399-002	67213	HalDEX	E-5652-R
611038	Dorman	E-4961A	65162B	Webb	85-123400-002	67214	HalDEX	E-5652-L
611040	Dorman	E-5554-R	65174B	Webb	85-123463-002	67215	HalDEX	E-4955
611041	Dorman	E-5554-L	652328	GMC	E-5957	67216	HalDEX	E-4989
611043	Dorman	E-5734	65266	Webb	03-123427-002	67217	HalDEX	E-5012
611046	Dorman	E-5007	65266B	Webb	85-123427-002	67218	HalDEX	E-4987A
611048	Dorman	E-4962	65334	HalDEX	E-540	67220	HalDEX	E-5761
611049	Dorman	E-4963	65335	HalDEX	E-573	67224	HalDEX	E-5558-R
611054	Dorman	E-5892	65336	HalDEX	E-572	67225	HalDEX	E-5558-L
611079	Dorman	E-5988-R	65463	HalDEX	E-1561	67226	HalDEX	E-5556-R
611080	Dorman	E-5988-R	65464	HalDEX	E-1251	67227	HalDEX	E-5556-L
611428	Navistar	E-5955	65465	HalDEX	E-1252	67228	HalDEX	E-5559-L
61142H	Navistar	E-5955	65466	HalDEX	E-618	67229	HalDEX	E-5561-R
61528	Webb	03-123254-002	65467	HalDEX	E-617	67229/67230	HalDEX	E-5561-R
61528B	Webb	85-123254-002	65468	HalDEX	E-619	67229/67230	HalDEX	E-5561-R
61529	Webb	03-122529-002	6548	HDA	E-4958	67230	HalDEX	E-5561-L
61566	Webb	03-120516-002	65514	Webb	03-122104-002	67231	HalDEX	E-5560-R
61727	Webb	03-120442-002	65516	Webb	03-120855-002	67231/67232	HalDEX	E-5560-R
61780	Webb	03-120754-002	65516B	Webb	85-120855-002	67231/67232	HalDEX	E-5560-R
61788	Webb	03-120936-002	65541B	Webb	85-123345-002	67232	HalDEX	E-5560-L
61968	Budd	E-4967-R	65545	Webb	03-123366-002	67233	HalDEX	E-5551-R
61968/69	Budd	E-4967-R	65545B	Webb	85-123366-002	67233/67234	HalDEX	E-5551-R
61968/69	Budd	E-4967-R	65554	Webb	03-123448-002	67233/67234	HalDEX	E-5551-R
619689	Budd	E-4967-R	65554B	Webb	03-123448-002	67234	HalDEX	E-5551-L
61969	Budd	E-4967-L	65554B	Webb	85-123448-002	67235	HalDEX	E-5585-R
62117	Webb	03-123500-002	65565B	Webb	53-123568-002	67235/67236	HalDEX	E-5585-R
62200	Webb	03-012582-002	6605	Motor Wheel	E-5708	67235/67236	HalDEX	E-5585-R
62240	Webb	03-120574-002	66101	HalDEX	E-2550	67236	HalDEX	E-5585-L
62358	Webb	03-122488-002	66102	HalDEX	E-1561	67237	HalDEX	E-5553-R
62997	Webb	03-122009-002	66108	HalDEX	E-617	67237/67238	HalDEX	E-5553-R
62997	Webb	03-123430-002	66109	HalDEX	E-619	67237/67238	HalDEX	E-5553-R
62997F	Webb	03-122009-002	66114	HalDEX	E-572	67238	HalDEX	E-5553-L
62997F	Webb	03-123430-002	66115	HalDEX	E-573	67239	HalDEX	E-5557-R
62998	Webb	03-123200-002	66117	HalDEX	E-540	67239/67240	HalDEX	E-5557-R
63035	Webb	03-122011-002	66121	HalDEX	E-1251	67239/67240	HalDEX	E-5557-R
63035	Webb	85-123203-002	66122	HalDEX	E-1252	67240	HalDEX	E-5557-L
63035B	Webb	85-123203-002	66123	HalDEX	E-1253	67241	HalDEX	E-4965-R
63035F	Webb	03-122011-002	66125	HalDEX	E-2128	67242	HalDEX	E-4965-L
63341	Budd	E-5876-R	66135	HalDEX	E-2660	67243	HalDEX	E-4966-R
63341/42	Budd	E-5876-R	66136	HalDEX	E-2659	67244	HalDEX	E-4966-L
633412	Budd	E-5876-R	66137	HalDEX	E-2658	67245	HalDEX	E-4967-R
6334142	Budd	E-5876-R	66138	HalDEX	E-2661	67245/67246	HalDEX	E-4967-R
63342	Budd	E-5876-L	66143	HalDEX	E-2297	67245/67246	HalDEX	E-4967-R
63385	Budd	E-5715-L	66145	HalDEX	E-2296	67246	HalDEX	E-4967-L
63385	Budd	E-5715-R	66154	HalDEX	E-2300	67247	HalDEX	E-4968-R
63386	Budd	E-5715-L	66155	HalDEX	E-2301	67248	HalDEX	E-4968-L
63606	Budd	E-5800	66156	HalDEX	E-2302	67249	HalDEX	E-4969-L
63617	Webb	03-122963-002	66169	HalDEX	E-2663	67249	HalDEX	E-4969-R
63617F	Webb	03-122963-002	66182	HalDEX	E-2417	67250	HalDEX	E-4969-L
63625-1/26-1	Budd	E-5720-R	66184	HalDEX	E-2418	67250	HalDEX	E-4969-R
63625-2/26-2	Budd	E-5718-R	66196	HalDEX	E-2420	67265	HalDEX	E-4961A
63625-3/26-3	Budd	E-5719-R	66197	HalDEX	E-2421	67266	HalDEX	E-7898-R
636251	Budd	E-5720-R	66215	HalDEX	E-2423	67267	HalDEX	E-5988-L
636251261	Budd	E-5720-R	66216	HalDEX	E-2424	67268	HalDEX	E-5579-R
636252	Budd	E-5718-R	66217	HalDEX	E-2425	67268/67269	HalDEX	E-5579-R
636252262	Budd	E-5718-R	66224	HalDEX	E-2303	67268/67269	HalDEX	E-5579-R
636253	Budd	E-5719-R	66225	HalDEX	E-2304	67269	HalDEX	E-5579-L
636253263	Budd	E-5719-R	66226	HalDEX	E-2305	67270	HalDEX	E-5046
6362561	Budd	E-5720-R	66250	Webb	03-123025-002	67271	HalDEX	E-5044
6362562	Budd	E-5718-R	66250F	Webb	03-123025-002	67272	HalDEX	E-5040A
6362563	Budd	E-5719-R	66366	Webb	03-123302-002	67273	HalDEX	E-5554-R
63625E1	Budd	E-5720-R	66543	HalDEX	E-2128	67274	HalDEX	E-5554-L
63625E2	Budd	E-5718-R	66808B	Webb	85-123520-002	67275	HalDEX	E-5927
63625E3	Budd	E-5719-R	66808F	Webb	03-123520-002	67279	HalDEX	E-5747
636261	Budd	E-5720-L	66809B	Webb	85-123570-002	67284	HalDEX	E-5036
636262	Budd	E-5718-L	66814F	Dayton-Walther	03-123428-002	67285	HalDEX	E-5746
636263	Budd	E-5719-L	66817	Webb	03-122513-002	67286	HalDEX	E-4957
63626E1	Budd	E-5720-L	66817F	Webb	03-122513-002	67287	HalDEX	E-7896-R
63626E2	Budd	E-5718-L	66864	Webb	03-123207-002	67287/67288	HalDEX	E-7896-R
63647	Webb	03-122963-002	66865	Webb	03-122948-002	67287/67288	HalDEX	E-7896-R
63647F	Webb	03-122963-002	66865	Webb	85-123297-002	67288	HalDEX	E-7896-L
63SP23	Mack	E-5960	66873	Webb	03-123397-002	67289	HalDEX	E-5720-R
63SP29	Mack	E-5952	66875	Webb	03-123409-002	67289/67290	HalDEX	E-5720-R
64018	Webb	03-120705-002	66884	Webb	03-123365-002	67289/67290	HalDEX	E-5720-R
64018F	Webb	03-120705-002	66888	HalDEX	E-4961A	67290	HalDEX	E-5720-L
64404	Webb	03-122561-002	66892	Webb	03-122453-002	67291	HalDEX	E-5718-R
64404F	Webb	03-122561-002	66895	Webb	03-122550-002	67291/67292	HalDEX	E-5718-R
64405	Webb	03-122562-002	66904	HalDEX	E-1559	67291/67292	HalDEX	E-5718-R
64405F	Webb	03-122562-002	67011	Budd	E-6060-R	67292	HalDEX	E-5718-L
64406	Webb	03-120459-002	67012	Budd	E-6060-L	67293	HalDEX	E-5829
64406F	Webb	03-120459-002	67101	Webb	03-122978-002	67295	HalDEX	E-5714-R
64408	Webb	03-120553-002	67143	Budd	E-5610-R	67296	HalDEX	E-5714-L
64408F	Webb	03-120553-002	67144	Budd	E-5610-L	67297	HalDEX	E-5589-L

Not an exact match. Quality level or bill of materials may differ between the Euclid and competitors part. Refer to Euclid catalog for complete information on Euclid Parts.

CROSS REFERENCE LISTING

COMPETITOR NUMBER	COMPETITOR NAME	EUCLID NUMBER	COMPETITOR NUMBER	COMPETITOR NAME	EUCLID NUMBER	COMPETITOR NUMBER	COMPETITOR NAME	EUCLID NUMBER
67297	Haldex	E-5589-R	700782	Trailmobile	E-5579-L	81T1118	Ford	E-5588-R
67297/67298	Haldex	E-5589-R	70085	Trailmobile	E-04075	81T1119	Ford	E-5588-L
67297/67298	Haldex	E-5589-R	70086	Trailmobile	E-05500	81T1119	Ford	E-5588-L
67298	Haldex	E-5589-L	70087	Trailmobile	E-04000	82017	Motor Wheel	E-8994-R
67298	Haldex	E-5589-R	704173	GMC	E-8961	82018	Motor Wheel	E-8994-L
67301	Haldex	E-5782	706	Erie	04-15984-001	8203868	Meritor	E-11647
67302	Haldex	E-5825	70611	Budd	E-5988-L	820394	Eaton	E-540
67303	Haldex	E-5765-R	70611	Budd	E-5988-R	820395	Eaton	E-572
67303/67304	Haldex	E-5765-R	70612	Budd	E-5988-L	820396	Eaton	E-573
67303/67304	Haldex	E-5765-R	70613	Budd	E-5554-R	8205373	Meritor	E-11648
67304	Haldex	E-5765-L	70613/14	Budd	E-5554-R	8205435	Meritor	E-11649
67305	Haldex	E-5749-L	70613/14	Budd	E-5554-R	8205575	Meritor	E-11650
67305	Haldex	E-5749-R	70614	Budd	E-5554-L	8205740	Meritor	E-11651
67305/67306	Haldex	E-5749-R	708-00	Erie	04-15502-004	8205741	Meritor	E-11652
67305/67306	Haldex	E-5749-R	708-00	Erie	04-15502-005	8205833	Meritor	E-11654
67306	Haldex	E-5749-L	708-53	Erie	04-15502-001	8205895	Meritor	E-11657
67306	Haldex	E-5749-R	708-59	Erie	04-15502-001	82095	Motor Wheel	E-8992-R
67307	Haldex	E-5750-R	715B	HDA	E-4956A	82096	Motor Wheel	E-8992-L
67307/67308	Haldex	E-5750-R	716B	HDA	E-4963	8234-85123448002	Mack	85-123448-002
67307/67308	Haldex	E-5750-R	717004	GMC	E-5987-R	8235-03012480002	Mack	03-012480-002
67308	Haldex	E-5750-L	717005	GMC	E-5987-L	8235-03012488002	Mack	03-012488-002
67310	Haldex	E-5559-R	71736	Budd	E-5578-R	8235-03012582002	Mack	03-012582-002
67458	Budd	E-5610-R	71736/37	Budd	E-5578-R	8235-03120574002	Mack	03-120574-002
67459	Budd	E-5610-L	71736/37	Budd	E-5578-R	8235-03120754002	Mack	03-120754-002
67461	Budd	E-5612-R	71737	Budd	E-5578-L	8235-03120988002	Mack	03-120988-002
67461/62	Budd	E-5612-R	72169R1	Navistar	E-5796	8235-03122126002	Mack	03-122126-002
67461/62	Budd	E-5612-R	72338R1	Navistar	E-4953	8235-03122222002	Mack	03-122222-002
67462	Budd	E-5612-L	72342R1	Navistar	E-5952	8235-03122600002	Mack	03-122600-002
67518	Webb	03-122222-002	7276	Dana/Spicer	E-2436	8235-03122607002	Mack	03-122607-002
67543	Haldex	E-5952	7277	Dana/Spicer	E-2433	8235-03122683002	Mack	03-122683-002
67544	Haldex	E-5737	7278	Dana/Spicer	E-2437	8235-03122964002	Mack	03-122964-002
67545	Haldex	E-5957	7279	Dana/Spicer	E-2438	8235-03122966002	Mack	03-122966-002
67546	Haldex	E-5743	7280	Dana/Spicer	E-2340	8235-03122971002	Mack	03-122971-002
67547	Haldex	E-5960	7281	Dana/Spicer	E-2341	8235-03123020002	Mack	03-123020-002
67558	Budd	E-5610-R	7283	Dana/Spicer	E-2434	8235-03123024002	Mack	03-123024-002
67559	Budd	E-5610-L	7284	Dana/Spicer	E-2431	8235-03123207002	Mack	03-123207-002
67675R92	Navistar	E-2460	7286	Dana/Spicer	E-03009	8235-03123276002	Mack	03-123276-002
67678R1	Navistar	E-2462	7290	Dana/Spicer	E-3009	8235-03123331002	Mack	03-123331-002
677583	GMC	E-5920-R	7292	Dana/Spicer	E-2435	8235-03123365002	Mack	03-123365-002
68012	Webb	03-122027-002	733108	Eaton	E-2432	8235-03123396002	Mack	03-123396-002
68012	Webb	03-122290-002	733113	Eaton	E-2437	8235-03123397002	Mack	03-123397-002
68013	Webb	03-122239-002	733115	Eaton	E-2433	8235-03123399002	Mack	03-123399-002
6823	Eaton	E-2431	74611	Webb	E-4962	8235-03123430002	Mack	03-123430-002
68333H	Navistar	E-4989	74710	Webb	E-4963	8235-03123448002	Mack	03-123448-002
68333H	Navistar	E-5712	74725	Budd	E-5610-R	8235-03123500002	Mack	03-123500-002
684368R1	Navistar	E-5947	74726	Budd	E-5610-L	8235-03123520002	Mack	03-123520-002
68730	Webb	03-122126-002	753612C1	Navistar	E-5988-L	8235-0415502002	Mack	04-15502-002
68730	Webb	03-122518-002	753613C1	Navistar	E-5899-R	8235-04157280004	Mack	04-15728-004
68760	Webb	03-122603-002	75716	Webb	E-4961A	8235-04159680002	Mack	04-15968-002
68765	Webb	03-120586-002	75887H	Navistar	E-5012	8235-0415984001	Mack	04-15984-001
68897	Webb	03-120743-002	75931	Budd	E-5713-R	8235-0415984002	Mack	04-15984-002
68897	Webb	03-122600-002	75931/32	Budd	E-5713-R	8235-122550	Mack	03-122550-002
68903	Webb	03-012480-002	7593132	Budd	E-5713-R	8235-123276	Mack	03-123276-002
68927	Webb	03-120376-002	75932	Budd	E-5713-L	8235-12480	Mack	03-012480-002
68931	Webb	03-120376-002	7652	Motor Wheel	E-5710	8235-20X1463	Mack	E-5924-R
68942	Webb	03-122455-002	773433C1	Navistar	E-5868-R	8235-20X1464	Mack	E-5924-L
68958	Webb	03-122925-002	773434C1	Navistar	E-5868-L	8235-23122691	Mack	E-4228
68981	Webb	03-122683-002	790328	GMC	E-4246	8235-23122700002	Mack	E-4227
68988	Webb	03-120988-002	791042C1	Navistar	E-5871-L	8235-23122703002	Mack	E-4233
69205	Budd	E-5717-R	791043C1	Navistar	E-5871-R	8235-23122729002	Mack	23-122729-002
69206	Budd	E-5717-L	793879R1	Navistar	E-4966-R	8235-23122729002	Mack	E-4230
69327R2	Navistar	E-4988-L	7EQ1118	Ford	E-5718-R	8235-23123485002	Mack	E-11125
69328R2	Navistar	E-4988-R	7EQ1119	Ford	E-5718-L	8235-23123486002	Mack	E-11310
69672F	Webb	03-123397-002	7EQ1124	Ford	E-573	8235-23123489002	Mack	E-11311
698165R1	Navistar	E-7898-R	7EQ1124A	Ford	E-573	8235-23123495002	Mack	E-11313
698166R1	Navistar	E-7898-L	7EQ1142	Ford	E-5740	8235-23123498002	Mack	E-12521
698167R1	Navistar	E-5576-R	8-15-4	Trailmobile	E-4962	8235-23123550004	Mack	E-11470
698168R1	Navistar	E-5576-L	8-15-4	Trailmobile	E-4963	8235-23123552004	Mack	E-12523
69877B	Webb	53-123583-002	8-16-3	Trailmobile	E-4962	8235-23123557004	Mack	E-12524
698794R1	Navistar	E-5559-R	8-8-12	Trailmobile	E-5047	8235-23123573004	Mack	E-6114
698795R1	Navistar	E-5559-L	8-8-17	Trailmobile	E-5572A	8235-23123574004	Mack	E-12517
698796R1	Navistar	E-5557-R	8-8-18	Trailmobile	E-5046	8235-23123625002	Mack	E-12516
698797R1	Navistar	E-5557-L	8-8-18	Trailmobile	E-5840	8235-23123626002	Mack	E-12514
69912	Budd	E-5579-R	8-8-20	Trailmobile	E-5040A	8235-53123512002	Mack	53-123512-002
69912/13	Budd	E-5579-R	8-8-3	Trailmobile	E-5570	8235-53123537002	Mack	53-123537-002
69912/13	Budd	E-5579-R	8-8-6	Trailmobile	E-5571A	8235-53123542002	Mack	53-123542-002
69913	Budd	E-5579-L	8-8-8	Trailmobile	E-5044	8235-53123544002	Mack	53-123544-002
69996B	Webb	53-123537-002	8-9-18	Trailmobile	E-4957	8235-53123564002	Mack	53-123564-002
6AX460	Mack	E-4989	8-9-2	Trailmobile	E-4989	8235-53123565002	Mack	53-123565-002
7-4-240	Trailmobile	03-120574-002	8-9-36	Trailmobile	E-5756-R	8235-53123566002	Mack	53-123566-002
7-4-264	Trailmobile	03-120877-002	8-9-37	Trailmobile	E-5756-L	8235-53123567002	Mack	53-123567-002
700711	Trailmobile	E-540	8-9-5	Trailmobile	E-4955	8235-53123575002	Mack	53-123575-002
700712	Trailmobile	E-573	8-9-7	Trailmobile	E-4958	8235-53123579002	Mack	53-123579-002
700713	Trailmobile	E-572	8-9-8	Trailmobile	E-4956A	8235-53123582002	Volvo	53-123582-002
700714	Trailmobile	E-2550	8007591	Meritor	E-11646	8235-53123583002	Mack	53-123583-002
700715	Trailmobile	E-1561	8017	Hendrickson	E-1828	8235-53123589002	Mack	53-123589-002
700716	Trailmobile	E-1251	8017P	HDA	E-1828	8235-53123598002	Mack	53-123598-002
700717	Trailmobile	E-2128	8060365	Volvo	85-123297-002	8235-85122266002	Mack	85-122266-002
700718	Trailmobile	E-1252	80697	Budd	E-5716-L	8235-85122550002	Mack	85-122550-002
7007215	Trailmobile	E-1559	80697	Budd	E-5716-R	8235-85122921002	Mack	85-122921-002
7007226	Trailmobile	E-6000A	80697/98	Budd	E-5716-R	8235-85122948002	Mack	85-122948-002
700777	Trailmobile	E-4969-R	8069798	Budd	E-5716-R	8235-85122954002	Mack	85-122954-002
700778	Trailmobile	E-7897-R	80698	Budd	E-5716-L	8235-85122964002	Mack	85-122964-002
700779	Trailmobile	E-4969-L	81124	Motor Wheel	E-4976-R	8235-85122966002	Mack	85-122966-002
700780	Trailmobile	E-7897-L	81269	Budd	E-5734	8235-85123200002	Mack	85-123200-002
700781	Trailmobile	E-5579-R	81323	Motor Wheel	E-7897-L	8235-85123207002	Mack	85-123207-002

Not an exact match. Quality level or bill of materials may differ between the Euclid and competitors part. Refer to Euclid catalog for complete information on Euclid Parts.

CROSS REFERENCE LISTING

COMPETITOR NUMBER	COMPETITOR NAME	EUCLID NUMBER	COMPETITOR NUMBER	COMPETITOR NAME	EUCLID NUMBER	COMPETITOR NUMBER	COMPETITOR NAME	EUCLID NUMBER
8235-85123254002	Mack	85-123254-002	85-122921	Paccar	85-122921-002	868368R1	Navistar	E-5755
8235-85123276002	Mack	85-123276-002	85-122947	Paccar	85-122947-002	86836R1	Navistar	E-5755
8235-85123331002	Mack	85-123331-002	85-122948	Paccar	85-122948-002	86897	Motor Wheel	E-5032
8235-85123365002	Mack	85-123365-002	85-122954	Paccar	85-122954-002	86922	Motor Wheel	E-4950
8235-85123366002	Mack	85-123366-002	85-122964	Paccar	85-122964-002	870813R1	Navistar	E-540
8235-85123370002	Mack	85-123370-002	85-122966	Paccar	85-122966-002	87101B	Motor Wheel	53-123564-002
8235-85123382002	Mack	85-123382-002	85-123200	Paccar	85-123200-002	87101B	Motor Wheel	53-123564-002
8235-85123383002	Mack	85-123383-002	85-123203	Paccar	85-123203-002	87128B	Hayes	53-123592-002
8235-85123396002	Mack	85-123396-002	85-123207	Paccar	85-123207-002	87128B	Motor Wheel	53-123592-002
8235-85123397002	Mack	85-123397-002	85-123254	Paccar	85-123254-002	87133	Motor Wheel	E-5018
8235-85123399002	Mack	85-123399-002	85-123276	Paccar	85-123276-002	87142	Motor Wheel	E-8995-R
8235-85123448002	Mack	85-123448-002	85-123297	Paccar	85-123297-002	87143	Motor Wheel	E-8995-L
8235-85123463002	Mack	85-123463-002	85-123331	Paccar	85-123331-002	87156B	Hayes	53-123565-002
8235-85123520002	Mack	85-123520-002	85-123332	Paccar	85-123332-002	87156B	Motor Wheel	53-123565-002
8235-85123570002	Mack	85-123570-002	85-123345	Paccar	85-123345-002	87295B	Hayes	53-123582-002
823520X1463	Mack	E-5924-L	85-123348	Paccar	85-123348-002	87295B	Motor Wheel	53-123582-002
823520X1464	Mack	E-5924-R	85-123365	Paccar	85-123365-002	87396	Motor Wheel	04-15602-021
823590415968007	Mack	04-15968-007	85-123366	Paccar	85-123366-002	87521	Webb	E-5971
82525	Budd	E-5682	85-123366-002	Strick	85-123366-002	87615B	Hayes	53-123580-002
82526	Budd	E-5683	85-123370	Paccar	85-123370-002	87615B	Motor Wheel	53-123580-002
82573	Budd	E-5748-R	85-123382	Paccar	85-123382-002	87707B	Hayes	53-123590-002
82573/74	Budd	E-5748-R	85-123382-002	Strick	85-123382-002	87707B	Motor Wheel	53-123590-002
8257374	Budd	E-5748-R	85-123383	Paccar	85-123383-002	878179R1	Navistar	E-4961A
82574	Budd	E-5748-L	85-123396	Paccar	85-123396-002	878210R1	Navistar	E-4965-R
82575	Budd	E-5749-R	85-123397	Paccar	85-123397-002	878211R1	Navistar	E-4965-L
82575/76	Budd	E-5749-R	85-123399	Paccar	85-123399-002	87945B	Hayes	53-123609-002
8257576	Budd	E-5749-R	85-123400	Paccar	85-123400-002	88013	Budd	E-7897-R
82576	Budd	E-5749-L	85-123406	Paccar	85-123406-002	88014	Budd	E-7897-L
82578	Budd	E-5558-L	85-123409	Paccar	85-123409-002	88108	Motor Wheel	E-5986-R
82578	Budd	E-5721-R	85-123420	Paccar	85-123420-002	88109	Motor Wheel	E-5986-L
82578/79	Budd	E-5721-R	85-123421	Paccar	85-123421-002	88291	Motor Wheel	E-8996-R
8257879	Budd	E-5721-R	85-123427	Paccar	85-123427-002	88292	Motor Wheel	E-8996-L
82579	Budd	E-5721-L	85-123428-002	Paccar	85-123428-002	88739B	Hayes	53-123605-002
82579	Budd	E-5721-R	85-123431	Paccar	85-123431-002	88739B	Motor Wheel	53-123605-002
82581	Budd	E-5714-R	85-123431-002	Paccar	85-123431-002	88797B	Hayes	53-123566-002
82581/82	Budd	E-5714-R	85-123444	Paccar	85-123444-002	88797B	Motor Wheel	53-123566-002
8258182	Budd	E-5714-R	85-123448	Paccar	85-123448-002	88799	Motor Wheel	E-5993
82582	Budd	E-5714-L	85-123463	Paccar	85-123463-002	88808	Motor Wheel	E-5994
82700	Motor Wheel	E-4961A	85-123465	Paccar	85-123465-002	88814B	Hayes	53-123588-002
828235	Volvo	E-1828	85-123466	Paccar	85-123466-002	88814B	Motor Wheel	53-123588-002
828325	Volvo White GMC	E-1828	85-123470	Paccar	85-123470-002	88870BK	Hayes	53-123575-002
82842	Motor Wheel	E-8993-R	85-123520	Paccar	85-123520-002	88870BK	Motor Wheel	53-123575-002
82843	Motor Wheel	E-8993-L	85-123548	Paccar	85-123548-002	88881	Motor Wheel	E-5991
828437	Volvo	E-5576-R	85-123553	Paccar	85-123553-002	88936204	GMC	E-12524
82853	Budd	E-5750-R	85-123556	Paccar	85-123556-002	889LB/888RB	HDA	E-5652-R
8293	Dana/Spicer	E-975	85-123561	Paccar	85-123561-002	889LB/888RB	HDA	E-5652-R
8295	Dana/Spicer	E-04075	85-123569-002	Paccar	85-123569-002	89085	Motor Wheel	E-5986-R
8296	Dana/Spicer	E-05500	85-123570	Paccar	85-123570-002	89086	Motor Wheel	E-5986-L
8297	Dana/Spicer	E-04000	85-123651	Paccar	85-123651-002	894786R1	Navistar	E-5897-L
83028	Motor Wheel	E-5632	85-123652	Paccar	85-123652-002	894787R1	Navistar	E-5897-R
83155H	Navistar	E-5977-R	85101166	Volvo	03-123406-002	89571B	Hayes	53-123579-002
83156H	Navistar	E-5977-L	85106039	Volvo	85-122964-002	89571B	Motor Wheel	53-123579-002
83172	Budd	E-5816	85106040	Volvo	85-123465-002	89620	Motor Wheel	E-8997
83812	Budd	E-5589-R	85108	Budd	E-5775	8970153570	Isuzu	E-9817
83812/13	Budd	E-5589-R	85122103002	Mack	85-122103-002	8970158570	Isuzu	E-9817
8381213	Budd	E-5589-R	85122921002	Volvo	85-122921-002	8970951522	Isuzu	E-9817
83813	Budd	E-5589-L	85122947002	Volvo	85-122947-002	89764R1	Navistar	E-5720-L
83818	Budd	E-5897-R	85123200002	Volvo	85-123200-002	89765R1	Navistar	E-5720-R
83819	Budd	E-5897-L	85123207002	Trailmobile	85-123207-002	89774	Motor Wheel	E-6001A
83851	Budd	E-5722-R	85123276002	Trailmobile	85-123276-002	898375R1	Navistar	E-7897-R
83851/52	Budd	E-5722-R	85123276002	Volvo	85-123276-002	898376R1	Navistar	E-7897-L
8385152	Budd	E-5722-R	85123345002	Mack	85-123345-002	89870BK	Hayes	53-123542-002
83852	Budd	E-5722-L	85123365002	Strick	85-123365-002	89870BK	Motor Wheel	53-123542-002
83853	Budd	E-5750-R	85123365002	Volvo	85-123365-002	89877B	Hayes	53-123583-002
83853/54	Budd	E-5750-R	85123396002	Volvo	85-123396-002	89877B	Motor Wheel	53-123583-002
8385354	Budd	E-5750-R	85123399002	Volvo	85-123399-002	89983	Motor Wheel	E-6029A
83854	Budd	E-5750-L	85123400002	Mack	85-123400-002	89996B	Hayes	53-123537-002
8399B	HDA	E-5927	85123421002	Trailmobile	85-123421-002	89996B	Motor Wheel	53-123537-002
84097	Budd	E-5765-R	85123463002	Paccar	85-123463-002	8EB3293	Ford	E-2297
84097/98	Budd	E-5765-R	85123463002	Volvo	85-123463-002	8EQ1042	Ford	E-5036
8409798	Budd	E-5765-R	85123466002	Volvo	85-123466-002	9000X	Gunitite	53-123512-002
84098	Budd	E-5765-L	85123520002	Volvo	85-123520-002	9001217	Meritor	E-11695-R
84523	Motor Wheel	E-5652-R	85123570	Strick	85-123570-002	9001218	Meritor	E-11695-L
84524	Motor Wheel	E-5652-L	85126317	Volvo	E-11125	9001254	Meritor	E-11658-R
84525	Motor Wheel	E-7895-R	85141	Budd	E-5776	9001255	Meritor	E-11658-L
84526	Motor Wheel	E-7895-L	852957	Volvo	E-5036	9001400	Meritor	E-11721-R
845260	White Truck	E-5957	852957	Volvo White GMC	E-5036	9001401	Meritor	E-11721-L
84527	Motor Wheel	E-5977-R	85381	Budd	E-5868-R	9001525	Meritor	E-11662-R
84528	Motor Wheel	E-5977-L	85382	Budd	E-5868-L	9001526	Meritor	E-11662-L
84608	Budd	E-5704	85521	Motor Wheel	E-4945	9001539	Meritor	E-11664-R
84711H	Navistar	E-5652-R	85858	HalDEX	23-122729-002	9001540	Meritor	E-11664-L
84712H	Navistar	E-5652-L	85858	HalDEX	E-4230	9001555	Meritor	E-11665-R
85-120516	Paccar	85-120516-002	85859	HalDEX	E-4229	9001556	Meritor	E-11665-L
85-120517	Paccar	85-120517-002	85860	HalDEX	E-4227	9001614	Meritor	E-11666-R
85-120586	Paccar	85-120586-002	85861	HalDEX	E-4228	9001615	Meritor	E-11666-L
85-120855	Paccar	85-120855-002	85862	HalDEX	E-4232	9001650	Meritor	E-11667-R
85-120877	Paccar	85-120877-002	85863	HalDEX	E-4231	9001651	Meritor	E-11667-L
85-122009	Paccar	85-122009-002	85932	Budd	E-5713-L	9001652	Meritor	E-11668-R
85-122011	Paccar	85-122011-002	86221	Webb	E-5970	9001653	Meritor	E-11668-L
85-122103	Paccar	85-122103-002	86222	Webb	E-5970	9001668	Meritor	E-11696-R
85-122266	Paccar	85-122266-002	86478	Motor Wheel	E-5872	9001669	Meritor	E-11696-L
85-122505	Paccar	85-122505-002	86514074	Ford	E-11312	9001727	Meritor	E-11701
85-122518	Paccar	85-122518-002	8656	Gunitite	03-120743-002	9001728	Meritor	E-11702
85-122550	Paccar	85-122550-002	8656	Gunitite	03-122600-002	9001763	Meritor	E-11669-R
85-122600	Paccar	85-122600-002	86797	Motor Wheel	E-5987-R	9001764	Meritor	E-11669-L
85-122683	Paccar	85-122683-002	86798	Motor Wheel	E-5987-L	9001811	Meritor	E-11703

Not an exact match. Quality level or bill of materials may differ between the Euclid and competitors part. Refer to Euclid catalog for complete information on Euclid Parts.

CROSS REFERENCE LISTING

COMPETITOR NUMBER	COMPETITOR NAME	EUCLID NUMBER	COMPETITOR NUMBER	COMPETITOR NAME	EUCLID NUMBER	COMPETITOR NUMBER	COMPETITOR NAME	EUCLID NUMBER
9001825	Meritor	E-11704	9041X	Gunite	53-123565-002	947971-8	Volvo White GMC	E-10235
9001826	Meritor	E-11705	90434B	Motor Wheel	53-123568-002	9479718	Volvo	E-10235
9001827	Meritor	E-11722-R	90441	Motor Wheel	E-8952-R	9486B	Motor Wheel	53-123581-002
9001828	Meritor	E-11722-L	90442	Motor Wheel	E-8952-L	95188	Budd	E-9022-R
9001853	Meritor	E-11706	90486B	Hayes	53-123581-002	95691	Budd	E-5933-R
9001855	Meritor	E-11707	90486B	Motor Wheel	53-123581-002	95692	Budd	E-5933-L
9001910	Meritor	E-11672-R	90513	Budd	E-5870-R	95693	Budd	E-5932-R
9001911	Meritor	E-11672-L	90513/14	Budd	E-5870-R	95694	Budd	E-5932-L
9001914	Meritor	E-11692	9051314	Budd	E-5870-R	956LB/956RB	HDA	E-5978-R
9001925	Meritor	E-11697-R	90514	Budd	E-5870-L	956LB956RB	HDA	E-5978-R
9001926	Meritor	E-11697-L	90553	Budd	E-5764-R	95707	Budd	E-5936-L
9001958	Meritor	E-11708	90553/54	Budd	E-5764-R	95708	Budd	E-5936-L
9001962	Meritor	E-11693	9055354	Budd	E-5764-R	95711	Budd	E-5935-R
9001964	Meritor	E-11709	90554	Budd	E-5764-L	95712	Budd	E-5935-L
9001965	Meritor	E-11673-R	90600B	Hayes	53-123589-002	972423R1	Navistar	E-5740
9001966	Meritor	E-11673-L	90600B	Motor Wheel	53-123589-002	973230R1	Navistar	E-5571A
9001982	Meritor	E-11674-R	90606BK	Hayes	53-123568-002	973230R1	Navistar	E-5840
9001983	Meritor	E-11674-L	90606BK	Motor Wheel	53-123568-002	974272R1	Navistar	E-5737
9001984	Meritor	E-11675-R	90801	Motor Wheel	E-6057-R	974577R1	Navistar	E-2438
9001985	Meritor	E-11675-L	90802	Motor Wheel	E-6057-L	974745R1	Navistar	E-6060-L
9001988	Meritor	E-11710	91001-0080	Volvo	03-123025-002	974746R1	Navistar	E-6060-R
9001990	Meritor	E-11712	91001-8003	Volvo	03-123365-002	97788H	Navistar	E-4875
9001991	Meritor	E-11676-R	91049B	Hayes	53-123607-002	982553R1	Navistar	E-2436
9001992	Meritor	E-11676-L	91049B	Motor Wheel	53-123607-002	98348	Budd	E-8946-R
9001995	Meritor	E-11677-R	91137BK	Hayes	53-123567-002	98349	Budd	E-8946-L
9001996	Meritor	E-11677-L	91137BK	Motor Wheel	53-123567-002	983878R1	Navistar	E-4966-L
9001997	Meritor	E-11659-R	91155	Motor Wheel	E-10209-R	9869701	Meritor	E-11680-R
9001998	Meritor	E-11659-L	91156	Motor Wheel	E-10209-L	9869702	Meritor	E-11680-L
9001999	Meritor	E-11699-R	91159	Motor Wheel	E-10216	9869702	Navistar	E-11680-L
9001X	Gunite	53-123542-002	91161	Motor Wheel	E-10215	98726R1	Navistar	E-5721-L
9002000	Meritor	E-11699-L	91163	Motor Wheel	E-10220	98727R1	Navistar	E-5721-R
9002001	Meritor	E-11713	91165	Motor Wheel	E-10219	988339R1	Navistar	E-5784A
9002002	Meritor	E-11714	91265B	Hayes	53-123608-002	988LB/988RB	HDA	E-5988-R
9002003	Meritor	E-11715	91265B	Motor Wheel	53-123608-002	988LB988RB	HDA	E-5988-R
9002004	Meritor	E-11716	916000	Wagner	E-4962	99357	Budd	E-4960
9002005	Meritor	E-11717	916001	Wagner	E-4963	993B	HDA	E-5040A
9002013	Meritor	E-11718	916010	Wagner	E-4958	99616	Budd	E-5868-R
9002021	Meritor	E-11684-R	916011	Wagner	E-4956A	99617	Budd	E-5868-L
9002022	Meritor	E-11684-L	916012	Wagner	E-5706	A1227A105	Meritor	E-2299
9002023	Meritor	E-11685-R	916040	Wagner	E-5571A	A1227A391	Meritor	E-2661
9002024	Meritor	E-11685-L	916041	Wagner	E-5784A	A1227C107	Meritor	E-3510
9002025	Meritor	E-11686-R	916042	Wagner	E-5572A	A1227S331	Meritor	E-2303
9002026	Meritor	E-11686-L	916045	Wagner	E-5040A	A1227S877	Meritor	E-2128
9002027	Meritor	E-11687-R	916100	Wagner	E-7895-R	A1227T540	Meritor	E-2420
9002028	Meritor	E-11687-L	916101	Wagner	E-7895-L	A1227V516	Meritor	E-2423
9002047	Meritor	E-11660-R	916102	Wagner	E-7896-R	A1227Z1404	Meritor	E-9021
9002048	Meritor	E-11660-L	916103	Wagner	E-7896-L	A1229W2545	Meritor	E-3008
9002049	Meritor	E-11661-R	916104	Wagner	E-7897-R	A1229W2545	Meritor	E-573
9002050	Meritor	E-11661-L	916105	Wagner	E-7897-L	A1229X2546	Meritor	E-7663
9002073	Meritor	E-11724	916109	Wagner	E-5988-L	A170074	Standard Forge	E-975
9002082	Meritor	E-11723-R	916110	Wagner	E-5978-R	A170074	Std. Forge	E-975
9002083	Meritor	E-11723-L	916111	Wagner	E-5978-L	A1987	Hendrickson Turner	E-573
9002085	Meritor	E-11678-R	916112	Wagner	E-5988-R	A26173	Hendrickson Turner	E-2550
9002086	Meritor	E-11678-L	916113	Wagner	E-5988-L	A26184	Hendrickson Turner	E-1561
9002140	Meritor	E-11725	916116	Wagner	E-5977-R	A33768X	Volvo	E-5570
9002184	Meritor	E-11719	916117	Wagner	E-5977-L	A33768X	Volvo White GMC	E-5570
9002204	Meritor	E-11682-R	916150	Wagner	E-5871-R	A635B	HDA	E-1559
9002205	Meritor	E-11682-L	916151	Wagner	E-5871-L	A8TZ1001C	Ford	E-2433
9002210	Meritor	E-11681-R	916152	Wagner	E-5896-R	A8TZ1001D	Ford	E-2437
9002211	Meritor	E-11681-L	916153	Wagner	E-5896-L	ACC006113900	Fruehauf	E-04075H
9002X	Gunite	53-123606-002	916156	Wagner	E-4968-R	ACC007538900	Fruehauf	E-04075
900421112	Hino	E-10254-R	916157	Wagner	E-4968-L	ACC007539900	Fruehauf	E-04075
900422104	Hino	E-10254-L	916200	Wagner	E-618	ACC7538900	Holland Hitch	E-04075
900423101	Hino	E-10253-R	916201	Wagner	E-619	ACD007629PK3	Fruehauf	E-5589-R
900424101	Hino	E-10253-L	916202	Wagner	E-2550	ACD007629PK4	Fruehauf	E-5589-L
9006X	Gunite	53-123537-002	916203	Wagner	E-1561	ACD7629PK1	Fruehauf	E-5589-R
90089BK	Hayes	53-123512-002	916204	Wagner	E-1559	ACD7629PK2	Fruehauf	E-5589-L
90089BK	Motor Wheel	53-123512-002	916205	Wagner	E-540	ACE008510001	Fruehauf	E-2550
90137B	Hayes	53-123606-002	916206	Wagner	E-572	ACE85101	Fruehauf	E-2550
90137B	Motor Wheel	53-123606-002	916207	Wagner	E-573	ACE85101	Holland Hitch	E-2550
9013P	HDA	E-04075	916210	Wagner	E-1253	ACF003323001	Fruehauf	04-15502-021
9014P	HDA	E-04000	916211	Wagner	E-1251	APA11971	Fruehauf	E-10253-R
9015P	HDA	E-05500	916212	Wagner	E-1252	APA11972	Fruehauf	E-10253-L
9016X	Gunite	53-123575-002	916213	Wagner	E-2128	AXA000408001	Fruehauf	E-1561
90174B	Hayes	53-123598-002	91723B	Hayes	53-123602-002	AXA000409001	Fruehauf	E-1559
90174B	Motor Wheel	53-123598-002	91723B	Motor Wheel	53-123602-002	AXA000484001	Fruehauf	E-05500
90180	Eaton	E-2464	91725B	Hayes	53-123601-002	AXA001005001	Fruehauf	E-04000
90217	Budd	E-5937-R	91725B	Motor Wheel	53-123601-002	AXA04081	Fruehauf	E-1561
90218	Budd	E-5937-L	91792B	Hayes	53-123535-002	AXA04081	Holland Hitch	E-1561
9021X	Gunite	53-123564-002	91792B	Motor Wheel	53-123535-002	AXA04091	Fruehauf	E-1559
90229	Eaton	E-2465	91872H	Navistar	E-4958	AXA04091	Holland Hitch	E-1559
9022X	Gunite	53-123582-002	92134H	Navistar	E-5570	AXA04321	Holland Hitch	E-05500
9035X	Gunite	53-123512-002	92135H	Navistar	E-5045	AXA04841	Holland Hitch	E-05500
9036X	Gunite	53-123583-002	9248P	HDA	E-1835	AXA10051	Holland Hitch	E-04000
9041BX	Gunite	53-123566-002	94039630	GMC	E-10253-R			

Not an exact match. Quality level or bill of materials may differ between the Euclid and competitors part. Refer to Euclid catalog for complete information on Euclid Parts.

CROSS REFERENCE LISTING

COMPETITOR NUMBER	COMPETITOR NAME	EUCLID NUMBER	COMPETITOR NUMBER	COMPETITOR NAME	EUCLID NUMBER	COMPETITOR NUMBER	COMPETITOR NAME	EUCLID NUMBER
B	Erie	E-5571A	D6176 ABS			E9HZ1151A	Ford	E-8949-R
B3TZ1001A	Ford	E-2431	(D6153 non ABS)	Gunite	E-11470	EQH1124	Ford	E-2461
B467	NWRA	E-5712	D6176M	Gunite	E-11470	FOHZ1012A	Ford	E-10235
B4TZ1001A	Ford	E-10237	D6183	Gunite	E-12523	FOHZ1126C	Ford	85-123332-002
B4TZ4255A	Ford	E-4864	D6194A	Gunite	E-6115	F1005	World Truck	E-2002
B600	NWRA	E-4955	D74Z4245A	Ford	E-2462	F1202	Eaton	E-618
B601	NWRA	E-4958	D7HZ4245A	Ford	E-2462	F1203	Eaton	E-617
B602	NWRA	E-4956A	D7HZ4255A	Ford	E-6142	F1247	Eaton	E-619
B605	NWRA	E-4957	D8HT1043AA	Ford	E-5571A	F1529	Eaton	E-540
B606	NWRA	E-4987A	D8HZ1403B	Ford	E-5905A	F1530	Eaton	E-572
B607	NWRA	E-5761	DTW85 123207 002	Freightliner	85-123207-002	F1531	Eaton	E-573
B610	NWRA	E-4989	DTW85 123448 002	Freightliner	85-123448-002	F184710	Eaton	E-5868-R
B612	NWRA	E-5706	DTW85123463002	Freightliner	85-123463-002	F18479	Eaton	E-5868-L
B614	NWRA	E-5706	DW-03-012480	Trailmobile	03-012480-002	F4HZ1125A	Ford	E-11306
B6Y1124A	Ford	E-4878	DW-03-012488	Trailmobile	03-012488-002	F4HZ1125C	Ford	E-11309
B6Y4252	Ford	E-4862	DW-03-012582	Trailmobile	03-012582-002	F940	Eaton	E-540
B701043A	Ford	E-5041	DW-03-120376	Trailmobile	03-120376-002	F941	Eaton	E-572
B8QH1142A	Ford	E-5960	DW-03-120586	Trailmobile	03-120586-002	F942	Eaton	E-573
B9TT1118A	Ford	E-5613-R	DW-03-120754	Trailmobile	03-120754-002	FOHZ 1126 C	Freightliner	85-123332-002
B9TT1118B	Ford	E-5613-R	DW-03-120882	Trailmobile	03-120882-002	FSP00402013	Fruehauf	E-1835
B9TT1119A	Ford	E-5613-L	DW-03-122009	Trailmobile	03-122009-002	H075	Eaton	E-04075
B9TT1119B	Ford	E-5613-L	DW-03-122126	Trailmobile	03-122126-002	H504400	Dana/Spicer	E-4955
BB1120	Ford	E-5652-R	DW-03-122222	Trailmobile	03-122222-002	HT683K	Gunite	04-15502-021
BB1121	Ford	E-5652-L	DW-03-122453	Trailmobile	03-122453-002	IT12396	Navistar	E-1253
BB1132	Ford	E-7895-R	DW-03-122455	Trailmobile	03-122455-002	IT12397	Navistar	E-1252
BB1133	Ford	E-7895-L	DW-03-122550	Trailmobile	03-122550-002	IT12398	Navistar	E-1251
BB1134	Ford	E-5977-R	DW-03-122600	Trailmobile	03-122600-002	IT12404	Navistar	E-576
BB1135	Ford	E-5977-L	DW-03-122603	Trailmobile	03-122603-002	IT12405	Navistar	E-620
BB1142A	Ford	E-5736	DW-03-122607	Trailmobile	03-122607-002	IT5997	Navistar	E-5997
BB1142B	Ford	E-5737	DW-03-122683	Trailmobile	03-122683-002	IT5998	Navistar	E-5998
BD125085	Wagner	E-4227	DW-03-122963	Trailmobile	03-122963-002	IT5999	Navistar	E-5999
BD125087	Wagner	E-4233	DW-03-122971	Trailmobile	03-122971-002	IT6002	Navistar	E-4963
BD125088	Wagner	E-4229	DW-03-123207	Trailmobile	03-123207-002	IT6048	Navistar	E-5953
BD125089	Wagner	E-9808	DW-03-123365	Trailmobile	03-123365-002	IT6051	Navistar	E-5571A
BD125090	Wagner	23-122729-002	DW-03-123430	Trailmobile	03-123430-002	IT6051L	Navistar	E-5040A
BD125090	Wagner	E-4230	DW03-122513-002	Trailmobile	03-122513-002	IT6058	Navistar	E-5040A
BD125096	Wagner	E-4231	E-5955	Webb	E-5955	IT6059	Navistar	E-5902
BD125097	Wagner	E-4247	E-5995-L	Webb	E-5995-L	IT8295	Navistar	E-04075
BD125098	Wagner	E-4232	E1	Erie	E-5571A	IT8295A	Navistar	E-04075H
BD125115	Wagner	E-9807	E10	Erie	E-5047	IT8296	Navistar	E-05500
BD125214	Wagner	E-4228	E10208R	Paccar	E-10208-R	IT8297	Navistar	E-04000
BD125304	Wagner	E-7185	E12	Erie	E-5784A	K	Erie	E-5573
BD125324	Wagner	E-9817	E12581006	Bendix	E-9817	K-37555	Gunite	E-5613-R
BD125339	Wagner	E-9809	E12584019	Bendix	E-4228	K-37556	Gunite	E-5613-L
BD125357	Wagner	E-9805	E12584020	Bendix	E-4227	K03	Paccar	E-10213-L
BD125358	Wagner	E-9804	E12584021	Bendix	E-4233	K04	Paccar	E-10213-R
BD125359	Wagner	E-4229	E12584027	Bendix	E-11306	K05	Paccar	E-10214-L
BD125361	Wagner	E-6114	E12585006	Bendix	E-11311	K06	Paccar	E-10214-R
BD125362	Wagner	E-6115	E12585010	Bendix	E-9805	K169187	Kenworth	E-6000A
BHNA011R	Paccar	E-5970	E12585013	Bendix	E-4229	K19374	Gunite	E-7897-R
BHNA015R	Paccar	E-5972	E12585014	Bendix	E-9807	K20048	Gunite	E-4988-R
C-230	NWRA	E-5754	E12585015	Bendix	E-9808	K20049	Gunite	E-4988-L
C181	NWRA	E-5036	E12585016	Bendix	E-9809	K20441	Gunite	E-7897-L
C232	NWRA	E-5889	E12588006	Bendix	E-4231	K2332871L	Paccar	E-5896-L
C233	NWRA	E-5890	E12588007	Bendix	E-4232	K2332871R	Paccar	E-5896-R
C234	NWRA	E-5891	E12588013	Bendix	E-4242	K233287L	Kenworth	E-5896-L
C3TZ1118A	Ford	E-5775	E12588014	Bendix	E-4240	K233287R	Kenworth	E-5896-R
C3TZ1120A	Ford	E-5704	E12588018	Bendix	E-12523	K233344L	Paccar	E-5871-L
C3TZ4A106A	Ford	E-5957	E12588019	Bendix	E-11470	K233344R	Paccar	E-5871-R
C6TS1144A	Ford	E-2435	E12588020	Bendix	E-6115	K233B305	Kenworth	E-5872
C7TZ1120A	Ford	E-9012-R	E12588022	Bendix	E-9873	K233B359L	Kenworth	E-5982-L
C7TZ1121A	Ford	E-9012-L	E12685009	Bendix	E-9804	K233B359R	Kenworth	E-5982-R
C8TX1107B	Ford	E-10203-L	E19	Erie	E-5571A	K233C372L	Kenworth	E-8990-L
C8TZ1107A	Ford	E-10203-R	E2	Erie	E-5572A	K233C372R	Kenworth	E-8990-R
C8TZ1107H	Ford	E-10203-L	E20	Erie	E-5571A	K233C372R	Paccar	E-8990-R
C8TZ1107J	Ford	E-10203-R	E21	Erie	E-5040A	K25260	Gunite	E-5556-R
C9HZ3295A	Ford	E-2299	E22	Erie	E-5784A	K25261	Gunite	E-5556-L
CL1008	Goodyear	E-5885	E2421	Mack	E-2421	K25264	Gunite	E-5652-R
CL1008	Motor Wheel	E-5885	E3	Erie	E-5040A	K25265	Gunite	E-5652-L
D0TZ1107A	Ford	E-8959-R	E3HZ1102A	Ford	E-4228	K30023	Gunite	E-5008
D0TZ1119A	Ford	E-8959-L	E4	Erie	E-5570	K34271	Gunite	E-5977-R
D5054A	Gunite	E-11313	E4	Erie	E-5838	K34272	Gunite	E-5977-L
D5HZ1102A	Ford	E-8903	E4HZ1107B	Ford	E-8957-R	K34435	Gunite	E-5032
D5HZ1102B	Ford	E-8904	E4HZ1107E	Ford	E-8972-R	K34460	Gunite	E-10229
D5HZ1107A	Ford	E-8966-R	E4HZ1108B	Ford	E-8957-L	K36162	Gunite	E-7895-R
D5HZ1108A	Ford	E-8966-L	E4HZ1108E	Ford	E-8972-L	K36163	Gunite	E-7895-L
D5HZ1195C	Ford	E-4869	E4HZ1125A	Ford	E-4227	K36707	Gunite	E-4965-R
D5HZ3104A	Ford	E-4861	E4HZ1125C	Ford	E-4233	K36708	Gunite	E-4965-L
D5UZ4255A	Ford	E-4863	E5	Erie	E-5045	K36733	Gunite	E-5610-R
D6052	Gunite	23-122729-002	E5871R	Paccar	E-5871-R	K36734	Gunite	E-5610-L
D6052	Gunite	E-4230	E6	Erie	E-5046	K43935	Gunite	E-5007
D6054	Gunite	E-11322	E6HZ1107A	Ford	E-8960	K43939	Gunite	E-10230
D6054	Gunite	E-4229	E6HZ1120A	Ford	E-9020	K45681	Gunite	E-5734
D6054A	Gunite	E-11310	E6HZ1120B	Ford	E-10235	K46009	Gunite	E-5682
D6054A	Gunite	E-9804	E6HZ1125F	Ford	E-7185	K46010	Gunite	E-5683
D6054C	Gunite	E-4227	E7	Erie	E-5747	KHKA005R	Paccar	E-5970
D6059	Gunite	E-4246	E7660	Leland	E-7660	KHNA001R	Paccar	E-5972
D6128	Gunite	E-4232	E7895L	Paccar	E-7895-L	KIT11416	Meritor	E-2662
D6133	Gunite	E-4247	E7897L	Paccar	E-7897-L	L1025	Leland	E-2128
D6147	Gunite	E-9873	E7TZ1120A	Ford	E-9012-R	L1026	Leland	E-1252
D6151	Gunite	E-11311	E8946R	Leland	E-8946-R	L107089	Budd	E-7895-R
D6151	Gunite	E-4247	E8979L	Paccar	E-8979-L	L1102	Leland	E-2002
D6168	Gunite	E-9873	E8979R	Paccar	E-8979-R	L1109	Leland	E-1835
D6175	Gunite	E-12523	E8HZ1107A	Ford	E-8972-R	L1120	Leland	E-1835
D6176	Gunite	E-11470	E8HZ1107B	Ford	E-8972-L	L1226	Leland	E-1828
D6176 ABS	Gunite	E-11470	E9	Erie	E-5044	L132	Leland	E-2423

Not an exact match. Quality level or bill of materials may differ between the Euclid and competitors part. Refer to Euclid catalog for complete information on Euclid Parts.

CROSS REFERENCE LISTING

COMPETITOR NUMBER	COMPETITOR NAME	EUCLID NUMBER	COMPETITOR NUMBER	COMPETITOR NAME	EUCLID NUMBER	COMPETITOR NUMBER	COMPETITOR NAME	EUCLID NUMBER
L1327	Leland	E-2237	L2581	Leland	E-4874	MWC101150	Fruehauf	E-6027-R
L1328	Leland	E-1087	L2584	Leland	E-4851	MWC101150	Fruehauf	E-6030A
L1329	Leland	E-1000	L2586	Leland	E-4852	MWC101151	Fruehauf	E-6029A
L1330	Leland	E-1001	L2587	Leland	E-4870	MWCB00601	Fruehauf	E-4958
L1331	Leland	E-2296	L2588	Leland	E-4853	MWCN00026	Fruehauf	E-4962
L1333	Leland	E-2297	L2589	Leland	E-4868	MWCN00040	Fruehauf	E-4963
L1334	Leland	E-2299	L2590	Leland	E-4854	MWCX01068	Fruehauf	E-4961A
L1335	Leland	E-2300	L2592	Leland	E-4855	MWCX01384	Fruehauf	E-4968-R
L1336	Leland	E-2301	L2593	Leland	E-4871	MWCX01385	Fruehauf	E-4968-L
L1337	Leland	E-2302	L2594	Leland	E-4871	MWCX01386	Fruehauf	E-4969-R
L1338	Leland	E-2662	L2595	Leland	E-4873	MWCX01387	Fruehauf	E-4969-L
L1339	Leland	E-2663	L2599	Leland	E-4857	MWCX01558	Fruehauf	E-5556-R
L1340	Leland	E-2658	L2600	Leland	E-4881	MWCX01562	Fruehauf	E-5559-R
L1341	Leland	E-2659	L2601	Leland	E-4858	MWCX01563	Fruehauf	E-5559-L
L1342	Leland	E-2660	L2602	Leland	E-4876	MWCX01572	Fruehauf	E-5560-R
L1343	Leland	E-2661	L2604	Leland	E-4877	MWCX01573	Fruehauf	E-5560-L
L1344	Leland	E-2419	L2614	Leland	E-4861	MWCX01580	Fruehauf	E-5553-R
L1345	Leland	E-2418	L2615	Leland	E-4869	MWCX01581	Fruehauf	E-5553-L
L1346	Leland	E-2417	L2616	Leland	E-4862	MWCX01614	Fruehauf	E-5716-R
L1347	Leland	E-2422	L2618	Leland	E-4863	MWCX01615	Fruehauf	E-5716-L
L1348	Leland	E-2421	L2619	Leland	E-4864	MWCX01616	Fruehauf	E-5589-R
L1349	Leland	E-2420	L2620	Leland	E-6142	MWCX01617	Fruehauf	E-5589-L
L1350	Leland	E-2425	L2621	Leland	E-4865	MWCX01702	Fruehauf	E-5765-R
L1351	Leland	E-2424	L2622	Leland	E-4879	MWCX01703	Fruehauf	E-5765-L
L1352	Leland	E-2423	L2853	Leland	E-4875	MWCX01704	Fruehauf	E-5756-R
L1353	Leland	E-2305	L2946	Leland	E-4961A	MWCX01705	Fruehauf	E-5756-L
L1354	Leland	E-2304	L2956	Leland	E-10237	MWCX01706	Fruehauf	E-5757-R
L1355	Leland	E-2303	L2957	Leland	E-10236	MWCX01707	Fruehauf	E-5757-L
L1359	Leland	E-2460	L2958	Leland	E-5742	MWCX01708	Fruehauf	E-5766-R
L136	Leland	E-2461	L2959	Leland	E-5949	MWCX01709	Fruehauf	E-5766-L
L1360	Leland	E-2461	L3209	Leland	E-6139	MWCX01712	Fruehauf	E-4966-R
L1361	Leland	E-2462	L3210	Leland	E-6138	MWCX01713	Fruehauf	E-4966-L
L1362	Leland	E-2463	L3211	Leland	E-6140	MWCX01803	Fruehauf	E-5652-R
L1363	Leland	E-2464	L3212	Leland	E-6141	MWCX01804	Fruehauf	E-5652-L
L1364	Leland	E-2465	L3213	Leland	E-3008	MWCX01807	Fruehauf	E-5554-R
L1366	Leland	E-2467	L3214	Leland	E-7658	MWCX01808	Fruehauf	E-5554-L
L1367	Leland	E-2468	L3215	Leland	E-7662	MWCX01828	Fruehauf	E-7895-R
L1395	Leland	E-2550	L3216	Leland	E-7659	MWCX01829	Fruehauf	E-7895-L
L1502	Leland	E-2432	L3221	Leland	E-7664	MWCX01831	Fruehauf	E-5977-R
L1503	Leland	E-2437	L3222	Leland	E-7665	MWCX01831O0Y	Fruehauf	E-5977-L
L1504	Leland	E-2433	L3223	Leland	E-7666	MWCX01832	Fruehauf	E-5977-L
L1505	Leland	E-2437	L3236	Leland	E-7663	MWCX01832O0Y	Fruehauf	E-5977-L
L1506	Leland	E-2438	L3382	Leland	E-10238	MWCX01835	Fruehauf	E-7896-R
L1507	Leland	E-2436	L453	Leland	E-03009	MWCX01836	Fruehauf	E-7896-L
L1508	Leland	E-2340	L454	Leland	E-975	MWCX01873	Fruehauf	E-5978-R
L1509	Leland	E-2341	L685	Leland	E-03009	MWCX01874	Fruehauf	E-5978-L
L1509	Leland	E-2435	L840	Leland	E-1251	MWCX02138	Fruehauf	E-5988-R
L1510	Leland	E-2435	L842	Leland	E-1253	MWCX02139	Fruehauf	E-5988-L
L1511	Leland	E-2431	L843	Leland	E-1252	MWCX02141	Fruehauf	E-5994
L1513	Leland	E-5952	L885	Leland	E-04075	MWCX02143	Fruehauf	E-5991
L1514	Leland	E-5737	L893	Leland	E-1561	MWCX02155	Fruehauf	E-5997
L1515	Leland	E-5739	M10HK162	Dana/Spicer	E-04075	MWCX02156	Fruehauf	E-6000A
L1515	Leland	E-5740	M10HN100	Dana/Spicer	E-573	MWCX02157	Fruehauf	E-5998
L1516	Leland	E-5957	M10HN101	Dana/Spicer	E-540	MXCX01559	Fruehauf	E-5556-L
L1517	Leland	E-5743	M10HN102	Dana/Spicer	E-572	N110	Meritor	E-2002
L1518	Leland	E-5960	M10HN104	Dana/Spicer	E-619	N1101	Meritor	E-2002
L1519	Leland	E-5796	M10HN105	Dana/Spicer	E-617	N1121	Meritor	E-4961A
L1520	Leland	E-5798	M10HN107	Dana/Spicer	E-618	N171	Meritor	E-5961
L1521	Leland	E-5799	M10HN128	Dana/Spicer	E-1087	N18	Meritor	E-5032
L1522	Leland	E-4945	M10HN129	Dana/Spicer	E-1001	N181	Meritor	E-5032
L1524	Leland	E-4958	M10HN130	Dana/Spicer	E-1000	N19	Meritor	E-5963
L1525	Leland	E-5800	M10HN151	Dana/Spicer	E-2237	N191	Meritor	E-5963
L1526	Leland	E-5947	M10MH1782	Dana/Spicer	E-8946-R	N26	NWRA	E-4962
L1526	Leland	E-5954	M10MH1792	Dana/Spicer	E-8946-L	N3324	NWRA	E-5012
L1528	Leland	E-4953	M2523	Budd	E-5800	N40	NWRA	E-4963
L1529	Leland	E-5872	M2524	Budd	E-5872	N47	Meritor	E-5961
L1530	Leland	E-5955	M2525	Budd	E-5955	N48	Meritor	E-5962
L1531	Leland	E-4960	M2526	Budd	E-4960	N481	Meritor	E-5962
L1532	Leland	E-5887	M2527	Budd	E-5952	N48P	Meritor	E-5962
L1532	Leland	E-5944	M2528	Budd	E-5957	NL1121	Meritor	E-4961A
L1700	Leland	E-05500	M2529	Budd	E-5960	NLA-NO	Meritor	E-10224-R
L1701	Leland	E-04000	M2530	Budd	E-2432	NRJA007R	Paccar	E-4962
L1752	Leland	E-4961A	M2531	Budd	E-2437	NRMA009R	Paccar	E-4963
L176	Leland	E-540	M2532	Budd	E-2433	NS-53-123565-002	Trailmobile	53-123565-002
L1762	Leland	E-1559	M2533	Budd	E-2438	NS03-120981	Trailmobile	03-120981-002
L177	Leland	E-573	M2534	Budd	E-2431	NT16	Firestone	E-4962
L178	Leland	E-572	M2535	Budd	E-2340	NT17	Firestone	E-4963
L1791	Leland	E-2434	M2536	Budd	E-2435	NT28	Firestone	E-5710
L1893	Leland	E-1561	M2537	Budd	E-2341	NT29	Firestone	E-5711
L195	Leland	E-576	M2538	Budd	E-7655	NT30	Firestone	E-5734
L209	Leland	E-618	M2549	Budd	E-3510	NT31	Firestone	E-4961A
L2093	Leland	E-5799	MDS001326	Fruehauf	E-8954-R	NTL25	Firestone	E-5977-L
L2094	Leland	E-5801	MDS001327	Fruehauf	E-8954-L	NTL26	Firestone	E-5652-L
L2095	Leland	E-5946	MHS003703	Fruehauf	E-2002	NTL27	Firestone	E-7895-L
L2099	Leland	E-1253	MMGW1061L	Fruehauf	E-8977-L	NTR25	Firestone	E-5977-R
L210	Leland	E-617	MMGW1061R	Fruehauf	E-8977-R	NTR26	Firestone	E-5652-R
L211	Leland	E-619	MNW93400502D	Fruehauf	E-1828	NTR27	Firestone	E-7895-R
L2121	Leland	E-4961A	MNW93400502S	Fruehauf	E-1828	NU30	Goodyear	E-4963
L2373	Leland	E-3508	MRMT1704	Fruehauf	E-5032	NU65	Goodyear	E-4962
L2374	Leland	E-3507	MRMT1704D	Fruehauf	E-5032	NU65	Motor Wheel	E-4962
L2375	Leland	E-3505	MWC05995L	Fruehauf	E-5995-L	PAC1	Paccar	E-5896-R
L2376	Leland	E-3504	MWC05995R	Fruehauf	E-5995-R	PAC15L	Paccar	E-5982-L
L2377	Leland	E-3509	MWC089774	Fruehauf	E-6001A	PAC15R	Paccar	E-5982-R
L2378	Leland	E-3506	MWC101150	Fruehauf	E-6026-L	PAC2	Paccar	E-5896-L
L249	Leland	E-620	MWC101150	Fruehauf	E-6026-R	PAC3	Paccar	E-5871-R
L2580	Leland	E-4849	MWC101150	Fruehauf	E-6027-L	PAC3R	Paccar	E-5871-R

Not an exact match. Quality level or bill of materials may differ between the Euclid and competitors part. Refer to Euclid catalog for complete information on Euclid Parts.

CROSS REFERENCE LISTING

COMPETITOR NUMBER	COMPETITOR NAME	EUCLID NUMBER	COMPETITOR NUMBER	COMPETITOR NAME	EUCLID NUMBER	COMPETITOR NUMBER	COMPETITOR NAME	EUCLID NUMBER
PAC4	Paccar	E-5871-L	R002437	Meritor	E-2437	R004965R	Meritor	E-4965-R
PAC4L	Paccar	E-5871-L	R002438	Meritor	E-2438	R004966L	Meritor	E-4966-L
PAC5L	Paccar	E-5749-L	R002460	Meritor	E-2460	R004966R	Meritor	E-4966-R
PAC5R	Paccar	E-5749-R	R002461	Meritor	E-2461	R004967L	Meritor	E-4967-L
R000540	Meritor	E-540	R002462	Meritor	E-2462	R004967R	Meritor	E-4967-R
R000572	Meritor	E-572	R002463	Meritor	E-2463	R004968L	Meritor	E-4968-L
R000573	Meritor	E-573	R002464	Meritor	E-2464	R004968R	Meritor	E-4968-R
R000618	Meritor	E-618	R002465	Meritor	E-2465	R004969L	Meritor	E-4969-L
R00100	Meritor	E-1000	R002467	Meritor	E-2467	R004969R	Meritor	E-4969-R
R001016L	Meritor	E-10200-L	R002468	Meritor	E-2468	R004975R	Meritor	E-4975-R
R001016R	Meritor	E-10200-R	R002550	Meritor	E-2550	R004976R	Meritor	E-4976-R
R001016R	Meritor	E-10202-L	R002571L	Meritor	E-5610-L	R004979R	Meritor	E-4979-R
R0010202L	Meritor	E-10202-L	R002571R	Meritor	E-5610-R	R004986A	Meritor	E-4986
R0010202R	Meritor	E-10202-R	R002650	Meritor	E-8963	R004987A	Meritor	E-4987A
R0010203L	Meritor	E-10203-L	R002651	Meritor	E-8964	R004988L	Meritor	E-4988-L
R0010203R	Meritor	E-10203-R	R002653	Meritor	E-8965	R004988R	Meritor	E-4988-R
R0010206L	Meritor	E-10206-L	R002659	Meritor	E-2659	R004989	Meritor	E-4989
R0010206R	Meritor	E-10206-R	R002660	Meritor	E-2660	R004990	Meritor	E-4990A
R0010208L	Meritor	E-10208-L	R002661	Meritor	E-2661	R005007	Meritor	E-5007
R0010208R	Meritor	E-10208-R	R003009	Meritor	E-3009	R005008	Meritor	E-5008
R0010209L	Meritor	E-10209-L	R003010	Meritor	E-3010	R005012	Meritor	E-5012
R0010209R	Meritor	E-10209-R	R003027L	Meritor	E-7897-L	R005018	Meritor	E-5018
R0010210L	Meritor	E-10210-L	R003027R	Meritor	E-7897-R	R005032	Meritor	E-5032
R0010210R	Meritor	E-10210-R	R003114	Meritor	E-10235	R005036	Meritor	E-5036
R0010213L	Meritor	E-10213-L	R003130L	Meritor	E-10253-L	R005040A	Meritor	E-5040A
R0010213R	Meritor	E-10213-R	R003130R	Meritor	E-10253-R	R005041	Meritor	E-5041
R0010214L	Meritor	E-10214-L	R003131L	Meritor	E-10254-L	R005044	Meritor	E-5044
R0010214R	Meritor	E-10214-R	R003131R	Meritor	E-10254-R	R005045	Meritor	E-5045
R0010215	Meritor	E-10215	R003501	Meritor	E-3501	R005046	Meritor	E-5046
R0010216	Meritor	E-10216	R003502	Meritor	E-3502	R005047	Meritor	E-5047
R0010217	Meritor	E-10217	R003504	Meritor	E-3504	R005055	Meritor	E-5055
R0010218	Meritor	E-10218	R003505	Meritor	E-3505	R005050	Meritor	E-05500
R0010219	Meritor	E-10219	R003506	Meritor	E-3506	R005548L	Meritor	E-5988-L
R0010220	Meritor	E-10220	R003507	Meritor	E-3507	R005551L	Meritor	E-5551-L
R0010221	Meritor	E-10221	R003508	Meritor	E-3508	R005551R	Meritor	E-5551-R
R0010222	Meritor	E-10222	R003509	Meritor	E-3509	R005552L	Meritor	E-5977-L
R0010223	Meritor	E-10223	R003723L	Meritor	E-3723-L	R005552R	Meritor	E-5977-R
R0010225L	Meritor	E-10225-L	R003723R	Meritor	E-3723-R	R005553L	Meritor	E-5553-L
R0010225R	Meritor	E-10225-R	R003727L	Meritor	E-3727-L	R005553R	Meritor	E-5553-R
R0010226L	Meritor	E-10226-L	R003727R	Meritor	E-3727-R	R005554L	Meritor	E-5554-L
R0010226R	Meritor	E-10226-R	R003728L	Meritor	E-3728-L	R005554R	Meritor	E-5554-R
R0010227L	Meritor	E-10227-L	R003728R	Meritor	E-3728-R	R005556L	Meritor	E-5556-L
R0010227R	Meritor	E-10227-R	R004075	Meritor	E-04075	R005556R	Meritor	E-5556-R
R0010228L	Meritor	E-10228-L	R004075H	Meritor	E-04075H	R005557L	Meritor	E-5557-L
R0010228R	Meritor	E-10228-R	R004849	Meritor	E-4849	R005557R	Meritor	E-5557-R
R0010229	Meritor	E-10229	R004850	Meritor	E-4850	R005558L	Meritor	E-5558-L
R0010230	Meritor	E-10230	R004851	Meritor	E-4851	R005558R	Meritor	E-5558-R
R0010234	Meritor	E-10234	R004852	Meritor	E-4852	R005559L	Meritor	E-5559-L
R0010235	Meritor	E-10235	R004853	Meritor	E-4853	R005559R	Meritor	E-5559-R
R0010242	Meritor	E-10242	R004854	Meritor	E-4854	R005560L	Meritor	E-5560-L
R0010254L	Meritor	E-10254-L	R004855	Meritor	E-4855	R005560R	Meritor	E-5560-R
R0010254R	Meritor	E-10254-R	R004856	Meritor	E-4856	R005561L	Meritor	E-5561-L
R0010256	Meritor	E-10256	R004857	Meritor	E-4857	R005561R	Meritor	E-5561-R
R0010257	Meritor	E-10257	R004858	Meritor	E-4858	R005570	Meritor	E-5570
R0010258L	Meritor	E-10258-L	R004859	Meritor	E-4859	R005571A	Meritor	E-5571A
R0010258R	Meritor	E-10258-R	R004861	Meritor	E-4861	R005572A	Meritor	E-5572A
R0010259L	Meritor	E-10259-L	R004862	Meritor	E-4862	R005573	Meritor	E-5573
R0010259R	Meritor	E-10259-R	R004863	Meritor	E-4863	R005575	Meritor	E-5775
R0010675	Meritor	E-10675	R004864	Meritor	E-4864	R005576L	Meritor	E-5576-L
R0010676	Meritor	E-10676	R004865	Meritor	E-4865	R005576R	Meritor	E-5576-R
R001087	Meritor	E-1087	R004868	Meritor	E-4868	R005578L	Meritor	E-5578-L
R001116L	Meritor	E-4968-L	R004869	Meritor	E-4869	R005578R	Meritor	E-5578-R
R001116R	Meritor	E-4968-R	R004870	Meritor	E-4870	R005579L	Meritor	E-5579-L
R001124L	Meritor	E-10201-L	R004871	Meritor	E-4871	R005579R	Meritor	E-5579-R
R001124R	Meritor	E-10201-R	R004873	Meritor	E-4873	R005585L	Meritor	E-5585-L
R001251	Meritor	E-1251	R004874	Meritor	E-4874	R005585R	Meritor	E-5585-R
R001252	Meritor	E-1252	R004875	Meritor	E-4875	R005587L	Meritor	E-5587-L
R001559	Meritor	E-1559	R004876	Meritor	E-4876	R005587R	Meritor	E-5587-R
R001561	Meritor	E-1561	R004877	Meritor	E-4877	R005588L	Meritor	E-5588-L
R001607L	Meritor	E-10224-L	R004878	Meritor	E-4878	R005588R	Meritor	E-5588-R
R001607R	Meritor	E-10224-R	R004879	Meritor	E-4879	R005589L	Meritor	E-5589-L
R001607R	Meritor	E-5610-R	R004881	Meritor	E-4881	R005589R	Meritor	E-5589-R
R001623L	Meritor	E-10249-L	R004942	Meritor	E-4942	R005610L	Meritor	E-5610-L
R001623R	Meritor	E-10249-R	R004943	Meritor	E-4944	R005610R	Meritor	E-5610-R
R001828	Meritor	E-1828	R004944	Meritor	E-4944	R005612L	Meritor	E-5612-L
R001835	Meritor	E-1835	R004945	Meritor	E-4945	R005612R	Meritor	E-5612-R
R001905	Meritor	E-10230	R004946	Meritor	E-4946	R005613L	Meritor	E-5613-L
R002002	Meritor	E-2002	R004947	Meritor	E-4947	R005613R	Meritor	E-5613-R
R002128	Meritor	E-2128	R004948	Meritor	E-4948	R005618L	Meritor	E-5618-L
R002237	Meritor	E-2237	R004949	Meritor	E-4949	R005618R	Meritor	E-5618-R
R002296	Meritor	E-2296	R004950	Meritor	E-4950	R005632	Meritor	E-5632
R002297	Meritor	E-2297	R004951	Meritor	E-4951	R005652L	Meritor	E-5652-L
R002299	Meritor	E-2299	R004952	Meritor	E-4952	R005652R	Meritor	E-5652-R
R002301	Meritor	E-2301	R004953	Meritor	E-4953	R005655	Meritor	E-4958
R002303	Meritor	E-2303	R004955	Meritor	E-4955	R005682	Meritor	E-5682
R002304	Meritor	E-2304	R004956A	Meritor	E-4956A	R005683	Meritor	E-5683
R002305	Meritor	E-2305	R004956APL	Meritor	E-4956A	R005702	Meritor	E-5702
R002306	Meritor	E-2306	R004957	Meritor	E-4957	R005704	Meritor	E-5704
R002340	Meritor	E-2340	R004958	Meritor	E-4958	R005706	Meritor	E-5706
R002341	Meritor	E-2341	R004960	Meritor	E-4960	R005708	Meritor	E-5708
R002424	Meritor	E-2424	R004961A	Meritor	E-4961A	R005710	Meritor	E-5710
R002431	Meritor	E-2431	R004962	Meritor	E-4962	R005711	Meritor	E-5711
R002433	Meritor	E-2433	R004963	Meritor	E-4963	R005712	Meritor	E-5712
R002434	Meritor	E-2434	R004964L	Meritor	E-4964-L	R005713L	Meritor	E-5713-L
R002435	Meritor	E-2435	R004964R	Meritor	E-4964-R	R005713R	Meritor	E-5713-R
R002436	Meritor	E-2436	R004965L	Meritor	E-4965-L	R005714L	Meritor	E-5714-L

Not an exact match. Quality level or bill of materials may differ between the Euclid and competitors part. Refer to Euclid catalog for complete information on Euclid Parts.

CROSS REFERENCE LISTING

COMPETITOR NUMBER	COMPETITOR NAME	EUCLID NUMBER	COMPETITOR NUMBER	COMPETITOR NAME	EUCLID NUMBER	COMPETITOR NUMBER	COMPETITOR NAME	EUCLID NUMBER
R005714R	Meritor	E-5714-R	R005872	Meritor	E-5872	R005983R	Meritor	E-5983-R
R005715L	Meritor	E-5715-L	R005876L	Meritor	E-5876-L	R005985L	Meritor	E-5985-L
R005715R	Meritor	E-5715-R	R005876R	Meritor	E-5876-R	R005985R	Meritor	E-5985-R
R005716L	Meritor	E-5716-L	R005877	Meritor	E-1835	R005986L	Meritor	E-5986-L
R005716R	Meritor	E-5716-R	R005882	Meritor	E-5882	R005986R	Meritor	E-5986-R
R005717L	Meritor	E-5717-L	R005883	Meritor	E-5883	R005987L	Meritor	E-5987-L
R005717R	Meritor	E-5717-R	R005885	Meritor	E-5885	R005987R	Meritor	E-5987-R
R005717X	Meritor	E-5717-L	R005885G	Meritor	E-5885	R005988L	Meritor	E-5988-L
R005718L	Meritor	E-5718-L	R005887	Meritor	E-5887	R005988R	Meritor	E-5988-R
R005718R	Meritor	E-5718-R	R005889	Meritor	E-5889	R005989L	Meritor	E-5989-L
R005719L	Meritor	E-5719-L	R005890	Meritor	E-5890	R005989R	Meritor	E-5989-R
R005719R	Meritor	E-5719-R	R005891	Meritor	E-5891	R005990L	Meritor	E-5990-L
R005720L	Meritor	E-5720-L	R005892	Meritor	E-5892	R005990R	Meritor	E-5990-R
R005720R	Meritor	E-5720-R	R005896L	Meritor	E-5896-L	R005991	Meritor	E-5991
R005721L	Meritor	E-5721-L	R005896R	Meritor	E-5896-R	R005992	Meritor	E-5992A
R005721R	Meritor	E-5721-R	R005897L	Meritor	E-5897-L	R005992A	Meritor	E-5992A
R005722L	Meritor	E-5722-L	R005897R	Meritor	E-5897-R	R005993	Meritor	E-5993
R005722R	Meritor	E-5722-R	R005898L	Meritor	E-5898-L	R005994	Meritor	E-5994
R005724	Meritor	E-5724	R005898R	Meritor	E-5898-R	R005995L	Meritor	E-5995-L
R005726	Meritor	E-5726	R005899L	Meritor	E-5899-L	R005995R	Meritor	E-5995-R
R005727	Meritor	E-5727	R005899R	Meritor	E-5899-R	R005996L	Meritor	E-5996-L
R005728	Meritor	E-5728	R005900L	Meritor	E-5900-L	R005996R	Meritor	E-5996-R
R005729	Meritor	E-5729	R005900R	Meritor	E-5900-R	R005997	Meritor	E-5997
R005734	Meritor	E-5734	R005901	Meritor	E-4956A	R005998	Meritor	E-5998
R005736	Meritor	E-5736	R005902	Meritor	E-5902	R005999	Meritor	E-5999
R005737	Meritor	E-5737	R005904A	Meritor	E-5904A	R006000A	Meritor	E-6000A
R005738	Meritor	E-5738	R005904A	Meritor	E-5905A	R006001	Meritor	E-6001A
R005739	Meritor	E-5739	R005905A	Meritor	E-5905A	R006003PL	Meritor	E-4956A
R005740	Meritor	E-5740	R005906	Meritor	E-5906	R006023L	Meritor	E-6023-L
R005742	Meritor	E-5742	R005909L	Meritor	E-5909-L	R006023R	Meritor	E-6023-R
R005743	Meritor	E-5743	R005909R	Meritor	E-5909-R	R006024L	Meritor	E-6024-L
R005746	Meritor	E-5746	R005910L	Meritor	E-5910-L	R006024R	Meritor	E-6024-R
R005747	Meritor	E-5747	R005910R	Meritor	E-5910-R	R006026L	Meritor	E-6026-L
R005748L	Meritor	E-5748-L	R005911L	Meritor	E-5911-L	R006026R	Meritor	E-6026-R
R005748R	Meritor	E-5748-R	R005911R	Meritor	E-5911-R	R006027L	Meritor	E-6027-L
R005749L	Meritor	E-5749-L	R005916L	Meritor	E-5916-L	R006027R	Meritor	E-6027-R
R005749R	Meritor	E-5749-R	R005916R	Meritor	E-5916-R	R006028L	Meritor	E-6028-L
R005750L	Meritor	E-5750-L	R005918L	Meritor	E-5918-L	R006028R	Meritor	E-6028-R
R005750R	Meritor	E-5750-R	R005918R	Meritor	E-5918-R	R006029	Meritor	E-6029A
R005753	Meritor	E-5753	R005920L	Meritor	E-5920-L	R006030	Meritor	E-6030A
R005754	Meritor	E-5754	R005920R	Meritor	E-5920-R	R006030A	Meritor	E-6030A
R005755	Meritor	E-5755	R005922L	Meritor	E-5922-L	R006033L	Meritor	E-6033-L
R005756L	Meritor	E-5756-L	R005922R	Meritor	E-5922-R	R006033R	Meritor	E-6033-R
R005756R	Meritor	E-5756-R	R005923L	Meritor	E-5923-L	R006034	Meritor	E-6034
R005757L	Meritor	E-5757-L	R005923R	Meritor	E-5923-R	R006035	Meritor	E-6035
R005757R	Meritor	E-5757-R	R005924L	Meritor	E-5924-L	R006036	Meritor	E-6036
R005761	Meritor	E-5761	R005924R	Meritor	E-5924-R	R006053	Meritor	E-6053
R005762	Meritor	E-4963	R005926	Meritor	E-5926	R006054	Meritor	E-6054
R005764L	Meritor	E-5764-L	R005926G	Meritor	E-5926	R006057L	Meritor	E-6057-L
R005764R	Meritor	E-5764-R	R005927	Meritor	E-5927	R006057R	Meritor	E-6057-R
R005765L	Meritor	E-5765-L	R005927G	Meritor	E-5927	R006058L	Meritor	E-6058-L
R005765R	Meritor	E-5765-R	R005929L	Meritor	E-5929-L	R006058R	Meritor	E-6058-R
R005766L	Meritor	E-5766-L	R005929R	Meritor	E-5929-R	R006059L	Meritor	E-6059-L
R005766R	Meritor	E-5766-R	R005930L	Meritor	E-5930-L	R006059R	Meritor	E-6059-R
R005775	Meritor	E-5775	R005930R	Meritor	E-5930-R	R006060L	Meritor	E-6060-L
R005776	Meritor	E-5776	R005931L	Meritor	E-5931-L	R006060R	Meritor	E-6060-R
R005778	Meritor	E-5776	R005931R	Meritor	E-5931-R	R006138	Meritor	E-6138
R005778	Meritor	E-5778	R005932L	Meritor	E-5932-L	R006139	Meritor	E-6139
R005780	Meritor	E-5780	R005932R	Meritor	E-5932-R	R006141	Meritor	E-6141
R005781	Meritor	E-5781	R005933L	Meritor	E-5933-L	R006142	Meritor	E-6142
R005782	Meritor	E-5782	R005933R	Meritor	E-5933-R	R006144	Meritor	E-6144
R005783	Meritor	E-5783	R005935L	Meritor	E-5935-L	R006145	Meritor	E-6145
R005784	Meritor	E-5783	R005935R	Meritor	E-5935-R	R006146	Meritor	E-6146
R005784	Meritor	E-5784A	R005936L	Meritor	E-5936-L	R006147	Meritor	E-6147
R005785	Meritor	E-5785A	R005936R	Meritor	E-5936-R	R006148	Meritor	E-6148
R005785A	Meritor	E-5785A	R005937L	Meritor	E-5937-L	R007011	Meritor	E-5799
R005786	Meritor	E-5785A	R005937R	Meritor	E-5937-R	R007014	Meritor	E-4945
R005796	Meritor	E-5796	R005944	Meritor	E-5944	R007018	Meritor	E-4950
R005798	Meritor	E-5798	R005945	Meritor	E-4950	R007051	Meritor	E-4960
R005799	Meritor	E-5799	R005946	Meritor	E-5946	R007118	Meritor	E-10238
R005800	Meritor	E-5800	R005947	Meritor	E-5947	R007122	Meritor	E-10237
R005801	Meritor	E-5801	R005949	Meritor	E-5949	R007224	Meritor	E-10236
R005816	Meritor	E-5816	R005952	Meritor	E-5952	R007775	Meritor	E-7775
R005820	Meritor	E-5820	R005953	Meritor	E-5953	R007895L	Meritor	E-7895-L
R005821	Meritor	E-5821	R005954	Meritor	E-5954	R007895R	Meritor	E-7895-R
R005821G	Meritor	E-5821	R005955	Meritor	E-5955	R007896L	Meritor	E-7896-L
R005822	Meritor	E-5822	R005957	Meritor	E-5957	R007896PL	Meritor	E-7896-L
R005823	Meritor	E-5823	R005958	Meritor	E-5571A	R007896R	Meritor	E-7896-R
R005824	Meritor	E-5824	R005960	Meritor	E-5960	R007896RPL	Meritor	E-7896-R
R005825	Meritor	E-5825	R005961	Meritor	E-5961	R007897L	Meritor	E-7897-L
R005827	Meritor	E-5827	R005962	Meritor	E-5962	R007897R	Meritor	E-7897-R
R005828	Meritor	E-5828	R005963	Meritor	E-5963	R007898L	Meritor	E-7898-L
R005829	Meritor	E-5829	R005964	Meritor	E-5964	R007898R	Meritor	E-7898-R
R005837	Meritor	E-5837	R005969	Meritor	E-5970	R008946L	Meritor	E-8946-L
R005838	Meritor	E-5838	R005970	Meritor	E-5970	R008946R	Meritor	E-8946-R
R005838G	Meritor	E-5838	R005971	Meritor	E-5971	R008947L	Meritor	E-8947-L
R005840	Meritor	E-5840	R005972	Meritor	E-5972	R008947R	Meritor	E-8947-R
R005841	Meritor	E-5841	R005974	Meritor	E-5974	R008948L	Meritor	E-8948-L
R005868L	Meritor	E-5868-L	R005976	Meritor	E-5976	R008948R	Meritor	E-8948-R
R005868R	Meritor	E-5868-R	R005977L	Meritor	E-5977-L	R008949L	Meritor	E-8949-L
R005869L	Meritor	E-5869-L	R005977R	Meritor	E-5977-R	R008949R	Meritor	E-8949-R
R005869R	Meritor	E-5869-R	R005978L	Meritor	E-5978-L	R008950L	Meritor	E-8950-L
R005870L	Meritor	E-5870-L	R005978R	Meritor	E-5978-R	R008950R	Meritor	E-8950-R
R005870R	Meritor	E-5870-R	R005982L	Meritor	E-5982-L	R008951L	Meritor	E-8951-L
R005871L	Meritor	E-5871-L	R005982R	Meritor	E-5982-R	R008951R	Meritor	E-8951-R
R005871R	Meritor	E-5871-R	R005983L	Meritor	E-5983-L	R008952L	Meritor	E-8952-L

Not an exact match. Quality level or bill of materials may differ between the Euclid and competitors part. Refer to Euclid catalog for complete information on Euclid Parts.

CROSS REFERENCE LISTING

COMPETITOR NUMBER	COMPETITOR NAME	EUCLID NUMBER	COMPETITOR NUMBER	COMPETITOR NAME	EUCLID NUMBER	COMPETITOR NUMBER	COMPETITOR NAME	EUCLID NUMBER
R008952R	Meritor	E-8952-R	R20001503	Strick	E-4956A	SNNK013R	Paccar	E-11721-R
R008954L	Meritor	E-8954-L	R20001504	Strick	E-4963	SNNK017L	Paccar	E-5589-R
R008954R	Meritor	E-8954-R	R20001505	Strick	E-5571A	SNNK017R	Paccar	E-5589-R
R008955L	Meritor	E-8955-L	R20001519	Strick	E-5706	SNNK023L	Paccar	E-8948-L
R008955R	Meritor	E-8955-R	R20001520	Strick	E-5570	SNNK023R	Paccar	E-8948-R
R008957L	Meritor	E-8957-L	R20001521	Strick	E-4958	ST1298	Goodyear	E-5727
R008957R	Meritor	E-8957-R	R20001522	Strick	E-4962	ST178	Goodyear	E-5726
R008958L	Meritor	E-8958-L	R301828	Meritor	E-1828	ST29	Goodyear	E-4956A
R008958R	Meritor	E-8958-R	R301835	Meritor	E-1835	ST570	Goodyear	E-5729
R008959L	Meritor	E-8959-L	R302002	Meritor	E-2002	ST68	Goodyear	E-4958
R008959R	Meritor	E-8959-R	R3064X	Gunite	E-8904	ST68	Motor Wheel	E-4958
R008960	Meritor	E-8960	R3065X	Gunite	E-8903	ST69	Goodyear	E-4955
R008961	Meritor	E-8961	R3306	Gunite	E-4240	ST69	Motor Wheel	E-4955
R008962	Meritor	E-8962	R4410156	Meritor	E-11306	ST770	Goodyear	E-5728
R008963	Meritor	E-8963	R4411306	Meritor	E-11306	SVVN605	Paccar	E-5800
R008964	Meritor	E-8964	R4411308	Meritor	E-11308	SVVN606	Paccar	E-5706
R008965	Meritor	E-8965	R4411309	Meritor	E-11309	SVVN607	Paccar	E-9837
R008966L	Meritor	E-8966-L	R4411312	Meritor	E-11312	SVVN608	Paccar	E-11715
R008966R	Meritor	E-8966-R	R4411320	Meritor	E-11320	SVVN609	Paccar	E-11672-R
R008968L	Meritor	E-8968-L	R4411321	Meritor	E-11321	SVVN610	Paccar	E-11672-L
R008968R	Meritor	E-8968-R	R4411323	Meritor	E-11323	SVVN611	Paccar	E-11672-L
R008969L	Meritor	E-8969-L	R4411324	Meritor	E-11324	SVVN611	Paccar	E-11693
R008969R	Meritor	E-8969-R	R4411326	Meritor	E-11326	SVVN612	Paccar	E-11710
R008972L	Meritor	E-8972-L	R4411328	Meritor	E-11328	SVVN613	Paccar	E-9837
R008972R	Meritor	E-8972-R	R44141583	Meritor	E-9805	SVVN614	Paccar	E-11677-R
R008976L	Meritor	E-8976-L	R44141627	Meritor	E-4242	SVVN615	Paccar	E-11677-L
R008976R	Meritor	E-8976-R	R44141629	Meritor	E-4240	SVVN616	Paccar	E-11713
R008977L	Meritor	E-8977-L	R44141730	Meritor	E-9817	SVVN617	Paccar	E-11714
R008977R	Meritor	E-8977-R	R44141856	Meritor	E-8903	SVVN618	Paccar	E-11715
R008978L	Meritor	E-8978-L	R44141875	Meritor	E-9873	SVVN619	Paccar	E-11716
R008978R	Meritor	E-8978-R	R444240	Meritor	E-4240	SWAX005L	Paccar	E-5897-L
R008979L	Meritor	E-8979-L	R444242	Meritor	E-4242	SWAX005R	Paccar	E-5897-R
R008979R	Meritor	E-8979-R	R447185	Meritor	E-7185	SWAX035L	Paccar	E-5899-L
R008980	Meritor	E-8980	R448903	Meritor	E-8903	SWAX035R	Paccar	E-5899-R
R008981	Meritor	E-8981	R448904	Meritor	E-8904	SWAX039L	Paccar	E-11695-L
R008982L	Meritor	E-8982-L	R449805	Meritor	E-9805	SWAX039R	Paccar	E-11695-R
R008982R	Meritor	E-8982-R	R449817	Meritor	E-9817	SWAZ004L	Paccar	E-10228-L
R008983L	Meritor	E-8983-L	R449873	Meritor	E-9873	SWAZ004R	Paccar	E-10228-R
R008983R	Meritor	E-8983-R	R517506	Meritor	E-2296	SZAR003R	Paccar	E-10221
R008985L	Meritor	E-8985-L	R6052	Gunite	23-122729-002	SZAR010R	Paccar	E-10220
R008985R	Meritor	E-8985-R	R6052	Gunite	E-4230	SZAW013R	Paccar	E-10675
R008986	Meritor	E-8986	R6059	Gunite	E-4246	SZAW021R	Paccar	E-8981
R008987	Meritor	E-8987	R6066	Gunite	E-4232	T1704	Reyco	E-5032
R008988	Meritor	E-8988	R6114	Gunite	E-4240	T3564	Meritor	E-572
R008989	Meritor	E-10676	R6115A	Gunite	E-4242	T3840	Meritor	E-573
R008990L	Meritor	E-8990-L	R6121A	Gunite	E-4242	T6880	Meritor	E-540
R008990R	Meritor	E-8990-R	R6128	Gunite	E-4232	TDA 03 120855 002	Freightliner	03-120855-002
R008991	Meritor	E-8991	R851004	Meritor	E-5712	TDA 03 122513 002	Freightliner	03-122513-002
R008992L	Meritor	E-8992-L	R852056	Meritor	E-5840	TDA 03 122603 002	Freightliner	03-122603-002
R008992R	Meritor	E-8992-R	R852057	Meritor	E-5841	TDA 03 122921 002	Freightliner	03-122921-002
R008993L	Meritor	E-8993-L	R852070	Meritor	E-5905A	TDA 03 122966 002	Freightliner	03-122966-002
R008993R	Meritor	E-8993-R	R854021	Meritor	E-5554-L	TDA 03 123396 002	Freightliner	03-123396-002
R008994L	Meritor	E-8994-L	R854022	Meritor	E-5554-R	TDA 03 123399 002	Freightliner	03-123399-002
R008994R	Meritor	E-8994-R	R854047	Meritor	E-5710	TDA 03 123406 002	Freightliner	03-123406-002
R008995L	Meritor	E-8995-L	R854048	Meritor	E-5711	TDA 03 123428 002	Freightliner	03-123428-002
R008995R	Meritor	E-8995-R	R854069	Meritor	E-5995-L	TDA 03 123493 002	Freightliner	03-123493-002
R008996L	Meritor	E-8996-L	R854070	Meritor	E-5995-R	TDA 03 123520 002	Freightliner	03-123520-002
R008996R	Meritor	E-8996-R	R856022	Meritor	E-4949	TDA 03 123538 002	Freightliner	03-123538-002
R008997	Meritor	E-8997	R856038	Meritor	E-4967-L	TDA 03012488002	Freightliner	03-012488-002
R009000L	Meritor	E-9000-L	R856039	Meritor	E-4967-R	TDA 03012582	Freightliner	03-012582-002
R009000R	Meritor	E-9000-R	R856040	Meritor	E-4968-L	TDA 03012582002	Freightliner	03-012582-002
R009001L	Meritor	E-9001-L	R856041	Meritor	E-4968-R	TDA 03120442 002	Freightliner	03-120442-002
R009001R	Meritor	E-9001-R	R856060	Meritor	E-5560-L	TDA 03120553002	Freightliner	03-120553-002
R009002L	Meritor	E-9002-L	R856061	Meritor	E-5560-R	TDA 03120586	Freightliner	03-120586-002
R009002R	Meritor	E-9002-R	R856062	Meritor	E-5561-L	TDA 03120705002	Freightliner	03-120705-002
R009003L	Meritor	E-9003-L	R856063	Meritor	E-5561-R	TDA 03120754	Freightliner	03-120754-002
R009003R	Meritor	E-9003-R	R856226	Meritor	E-5946	TDA 03120877	Freightliner	03-120877-002
R009004L	Meritor	E-9004-L	R856250	Meritor	E-5998	TDA 03120877002	Freightliner	03-120877-002
R009004R	Meritor	E-9004-R	S788S	Meritor	E-5018	TDA 03120882	Freightliner	03-120882-002
R009005L	Meritor	E-9005-L	SA1162	Leland	E-4961A	TDA 03120936002	Freightliner	03-120936-002
R009005R	Meritor	E-9005-R	SA1201	Leland	E-1828	TDA 03120981002	Freightliner	03-120981-002
R009006	Meritor	E-9006	SA1232	Leland	E-2002	TDA 03122009	Freightliner	03-122009-002
R009007	Meritor	E-9007	SA1286	Leland	E-1828	TDA 03122104002	Freightliner	03-122104-002
R009008L	Meritor	E-9008-L	SA1288	Leland	E-1835	TDA 03122126	Freightliner	03-122126-002
R009008R	Meritor	E-9008-R	SA1336	Leland	E-1835	TDA 03122126002	Freightliner	03-122126-002
R009009	Meritor	E-9009	SA1534	Leland	E-1835	TDA 03122222	Freightliner	03-122222-002
R009010L	Meritor	E-9010-L	SA1579	Leland	E-1828	TDA 03122222002	Freightliner	03-122222-002
R009010R	Meritor	E-9010-R	SA1965	Leland	E-2002	TDA 03122453	Freightliner	03-122453-002
R009011L	Meritor	E-9011-L	SC1020	Meritor	E-5946	TDA 03122488	Freightliner	03-122488-002
R009011R	Meritor	E-9011-R	SC1022	Meritor	E-5800	TDA 03122488002	Freightliner	03-122488-002
R009012L	Meritor	E-9012-L	SC1021	Meritor	E-5800	TDA 03122518	Freightliner	03-122518-002
R009012R	Meritor	E-9012-R	SC1023	Meritor	E-5947	TDA 03122550002	Freightliner	03-122550-002
R009020	Meritor	E-9020	SC10231	Meritor	E-5947	TDA 03122600	Freightliner	03-122600-002
R009021	Meritor	E-9021	SC1026	Meritor	E-5949	TDA 03122600002	Freightliner	03-122600-002
R009022R	Meritor	E-9022-R	SC10261	Meritor	E-5949	TDA 03122607002	Freightliner	03-122607-002
R009023	Meritor	E-9023	SC718	Meritor	E-5796	TDA 03122683	Freightliner	03-122683-002
R009024	Meritor	E-9024	SC7181	Meritor	E-5796	TDA 03122683002	Freightliner	03-122683-002
R009261	Meritor	E-9261	SC819	Meritor	E-5798	TDA 03122925002	Freightliner	03-122925-002
R009262	Meritor	E-9262	SC8191	Meritor	E-5798	TDA 03122947002	Freightliner	03-122947-002
R009524L	Meritor	E-9524-L	SNAA010L	Paccar	E-10213-L	TDA 03122948002	Freightliner	03-122948-002
R009524R	Meritor	E-9524-R	SNAA010R	Paccar	E-10213-R	TDA 03122963	Freightliner	03-122963-002
R009525L	Meritor	E-9525-L	SNAJ002L	Paccar	E-10210-L	TDA 03122964	Freightliner	03-122964-002
R009525R	Meritor	E-9525-R	SNAJ002R	Paccar	E-10210-R	TDA 03122964002	Freightliner	03-122964-002
R009526	Meritor	E-9526	SNAV019L	Paccar	E-5871-L	TDA 03122971	Freightliner	03-122971-002
R1025	World Truck	E-5032	SNAV019R	Paccar	E-5871-R	TDA 03122971002	Freightliner	03-122971-002
R20001500	Strick	E-5572A	SNNK013L	Paccar	E-11721-L	TDA 03122978002	Freightliner	03-122978-002

Not an exact match. Quality level or bill of materials may differ between the Euclid and competitors part. Refer to Euclid catalog for complete information on Euclid Parts.

CROSS REFERENCE LISTING

COMPETITOR NUMBER	COMPETITOR NAME	EUCLID NUMBER	COMPETITOR NUMBER	COMPETITOR NAME	EUCLID NUMBER	COMPETITOR NUMBER	COMPETITOR NAME	EUCLID NUMBER
TDA 03123024	Freightliner	03-123024-002	TDA 85 120516 002	Freightliner	85-120516-002	W101	Leland	E-4988-R
TDA 03123025	Freightliner	03-123025-002	TDA 85 120517 002	Freightliner	85-120517-002	W102	Leland	E-4988-L
TDA 03123025002	Freightliner	03-123025-002	TDA 85 120877 002	Freightliner	85-120877-002	W103	Leland	E-5588-R
TDA 03123207002	Freightliner	03-123207-002	TDA 85 122009 002	Freightliner	85-122009-002	W1038L	Gunite	E-7895-L
TDA 03123219002	Freightliner	03-123219-002	TDA 85 122011 002	Freightliner	85-122011-002	W1038R	Gunite	E-7895-R
TDA 03123276002	Freightliner	03-123276-002	TDA 85 122550 002	Freightliner	85-122550-002	W104	Leland	E-5588-L
TDA 03123302002	Freightliner	03-123302-002	TDA 85 122921 002	Freightliner	85-122921-002	W1049L	Gunite	E-5589-L
TDA 03123365002	Freightliner	03-123365-002	TDA 85 122954 002	Freightliner	85-122954-002	W106	Leland	E-5988-L
TDA 03123382002	Freightliner	03-123382-002	TDA 85 122964 002	Freightliner	85-122964-002	W1060L	Gunite	E-8976-L
TDA 03123383002	Freightliner	03-123383-002	TDA 85 122966 002	Freightliner	85-122966-002	W1060R	Gunite	E-8976-R
TDA 03123397002	Freightliner	03-123397-002	TDA 85 123200 002	Freightliner	85-123200-002	W1061L	Gunite	E-8977-L
TDA 03123398002	Freightliner	03-123398-002	TDA 85 123203 002	Freightliner	85-123203-002	W1061R	Gunite	E-8977-R
TDA 03123409002	Freightliner	03-123409-002	TDA 85 123207 002	Freightliner	85-123207-002	W1064L	Gunite	E-10206-L
TDA 03123421002	Freightliner	03-123421-002	TDA 85 123254 002	Freightliner	85-123254-002	W1064R	Gunite	E-10206-R
TDA 03123427002	Freightliner	03-123427-002	TDA 85 123276 002	Freightliner	85-123276-002	W107	Leland	E-7897-R
TDA 03123430	Freightliner	03-123430-002	TDA 85 123331 002	Freightliner	85-123331-002	W1073L	Gunite	E-8978-L
TDA 03123430002	Freightliner	03-123430-002	TDA 85 123332 002	Freightliner	85-123332-002	W1073R	Gunite	E-8978-R
TDA 03123448002	Freightliner	03-123448-002	TDA 85 123345 002	Freightliner	85-123345-002	W108	Leland	E-7897-L
TDA 03123466002	Freightliner	03-123466-002	TDA 85 123348 002	Freightliner	85-123348-002	W109	Leland	E-5008
TDA 03123500002	Freightliner	03-123500-002	TDA 85 123365 002	Freightliner	85-123365-002	W1091L	Gunite	E-10202-L
TDA 04 15502 007	Freightliner	04-15502-007	TDA 85 123366 002	Freightliner	85-123366-002	W1091R	Gunite	E-10202-R
TDA 04 15968 002	Freightliner	04-15968-002	TDA 85 123370 002	Freightliner	85-123370-002	W11	Leland	E-7895-R
TDA 04 15968 009	Freightliner	04-15968-009	TDA 85 123383 002	Freightliner	85-123383-002	W110	Leland	E-4961A
TDA 04 15981 019	Freightliner	04-15981-019	TDA 85 123396 002	Freightliner	85-123396-002	W1104L	Gunite	E-8966-L
TDA 04 15984 001	Freightliner	04-15984-001	TDA 85 123397 002	Freightliner	85-123397-002	W1104R	Gunite	E-8966-R
TDA 04 15984 003	Freightliner	04-15984-003	TDA 85 123399 002	Freightliner	85-123399-002	W111	Leland	E-5007
TDA 04 15984 004	Freightliner	04-15984-004	TDA 85 123400 002	Freightliner	85-123400-002	W1110	Gunite	E-5905A
TDA 0415502001	Freightliner	04-15502-001	TDA 85 123420 002	Freightliner	85-123420-002	W1118L	Gunite	E-8972-L
TDA 0415502002	Freightliner	04-15502-002	TDA 85 123421 002	Freightliner	85-123421-002	W1118R	Gunite	E-8972-R
TDA 0415502004	Freightliner	04-15502-004	TDA 85 123427 002	Freightliner	85-123427-002	W112	Gunite	E-8969-L
TDA 0415728002	Freightliner	04-15728-002	TDA 85 123428 002	Freightliner	85-123428-002	W112	NWRA	E-5827
TDA 0415728004	Freightliner	04-15728-004	TDA 85 123431 002	Freightliner	85-123431-002	W1121R	Gunite	E-8969-R
TDA 0415984010	Freightliner	04-15984-010	TDA 85 123448 002	Freightliner	85-123448-002	W113	NWRA	E-5828
TDA 0415984036	Freightliner	04-15984-036	TDA 85 123463 002	Freightliner	85-123463-002	W1133L	Gunite	E-8979-L
TDA 13123302002	Freightliner	13-123302-002	TDA 85 123465 002	Freightliner	85-123465-002	W1133R	Gunite	E-8979-R
TDA 23123552004	Freightliner	E-12523	TDA 85 123520 002	Freightliner	85-123520-002	W1138	Gunite	E-5904A
TDA 23 123461 002	Freightliner	E-12520	TDA 85 123548 002	Freightliner	85-123548-002	W114	NWRA	E-5829
TDA 23 123486 002	Freightliner	E-11310	TDA 85 123553 002	Freightliner	85-123553-002	W1148L	Gunite	E-5898-L
TDA 23 123498 002	Freightliner	E-12521	TDA 85 123556 002	Freightliner	85-123556-002	W1148R	Gunite	E-5898-R
TDA 23 123550 004	Freightliner	E-11470	TDA 85 123561 002	Freightliner	85-123561-002	W115	Leland	E-5579-R
TDA 23 123552 004	Freightliner	E-12523	TDA 85 123569 002	Freightliner	85-123569-002	W116	Leland	E-5579-L
TDA 23 123557 004	Freightliner	E-12524	TDA 85 123570 002	Freightliner	85-123570-002	W1160	Gunite	E-8980
TDA 23 123572 004	Freightliner	E-6115	TDA 85 123652 002	Freightliner	85-123652-002	W1164	Gunite	E-8981
TDA 23 123573 004	Freightliner	E-6114	TDA 85120586002	Freightliner	85-120586-002	W1166L	Gunite	E-8982-L
TDA 23 123574 004	Freightliner	E-12517	TDA 85120855002	Volvo	85-120855-002	W1166R	Gunite	E-8982-R
TDA 23 123624 002	Freightliner	E-12515	TDA 85120877	Freightliner	85-120877-002	W117	Leland	E-5046
TDA 23122527002	Freightliner	E-4231	TDA 85122266002	Freightliner	85-122266-002	W117	Leland	E-5840
TDA 23122691	Freightliner	E-4228	TDA 85122505	Freightliner	85-122505-002	W1170L	Gunite	E-8983-L
TDA 23122691002	Freightliner	E-4228	TDA 85122518	Freightliner	85-122518-002	W1170R	Gunite	E-8983-R
TDA 23122693002	Freightliner	E-4246	TDA 85122550	Freightliner	85-122550-002	W118	Leland	E-5047
TDA 23122700002	Freightliner	E-4227	TDA 85123254	Freightliner	85-123254-002	W118	NWRA	E-5974
TDA 23122701002	Freightliner	E-4232	TDA 85123276	Freightliner	85-123276-002	W119	Leland	E-5044
TDA 23122703	Freightliner	E-4233	TDA 85123297002	Freightliner	85-123297-002	W1196	Gunite	E-10676
TDA 23122703002	Freightliner	E-4233	TDA 85123348003	Freightliner	85-123348-002	W12	Leland	E-7895-L
TDA 23122729002	Freightliner	23-122729-002	TDA 85123409	Freightliner	85-123409-002	W120	Leland	E-5040A
TDA 23122729002	Freightliner	E-4230	TDA 85123448	Freightliner	85-123448-002	W120	NWRA	E-5783
TDA 23123046002	Freightliner	E-9808	TDA 85123466002	Freightliner	85-123466-002	W1203L	Gunite	E-8985-L
TDA 23123433002	Freightliner	E-11327	TDA 85123548002	Volvo	85-123548-002	W1203R	Gunite	E-8985-R
TDA 23123468002	Freightliner	E-11322	TDA E8952L	Volvo	E-8952-L	W1205	Gunite	E-8986
TDA 23123485002	Freightliner	E-11125	TDA-03123332002	Freightliner	03-123332-002	W121	NWRA	E-5781
TDA 23123489002	Freightliner	E-11311	TDA-85120855002	Freightliner	85-120855-002	W1211	Gunite	E-8987
TDA 23123495002	Freightliner	E-11313	TDA-85123382002	Freightliner	85-123382-002	W122	Leland	E-5554-R
TDA 23123573004	Volvo	E-6114	TDA03122027002	Volvo	03-122027-002	W122	NWRA	E-5780
TDA 23123625002	Freightliner	E-12516	TDA03123406002	Freightliner	03-123406-002	W123	Leland	E-5554-L
TDA 23123626002	Freightliner	E-12514	TDA03123520002	Freightliner	03-123520-002	W1234	Gunite	E-10675
TDA 53 123512 002	Freightliner	53-123512-002	TDA0415502029	Volvo	04-15502-029	W124	Leland	E-5927
TDA 53 123535 002	Freightliner	53-123535-002	TDA0415502030	Volvo	04-15502-030	W1246	Gunite	E-8988
TDA 53 123537	Freightliner	53-123537-002	TDA0415968007	Volvo	04-15968-007	W1249	Gunite	E-10676
TDA 53 123537 002	Freightliner	53-123537-002	TDA0415968044	Paccar	04-15968-044	W125	Leland	E-5587-R
TDA 53 123542	Freightliner	53-123542-002	TDA0415981016	Volvo	04-15981-016	W126	Leland	E-5587-L
TDA 53 123542 002	Freightliner	53-123542-002	TDA0415981019	Volvo	04-15981-019	W13	Leland	E-5977-R
TDA 53 123544 002	Freightliner	53-123544-002	TDA23122527002	Volvo	E-4231	W1324	Gunite	E-10675
TDA 53 123564 002	Freightliner	53-123564-002	TDA23123433002	Freightliner	E-11327	W1327	Gunite	E-10676
TDA 53 123565	Freightliner	53-123565-002	TDA23123433002	Volvo	E-11327	W133	Leland	E-5041
TDA 53 123565 002	Freightliner	53-123565-002	TDA23123485002	Freightliner	E-11125	W1338	Gunite	E-6000A
TDA 53 123566	Freightliner	53-123566-002	TDA23123486002	Volvo	E-11310	W135	Leland	E-5747
TDA 53 123566 002	Freightliner	53-123566-002	TDA23123495002	Freightliner	E-11313	W136	Leland	E-5573
TDA 53 123567 002	Freightliner	53-123567-002	TDA23123498002	Volvo	E-12521	W14	Leland	E-5977-L
TDA 53 123568	Freightliner	53-123568-002	TDA23123572004	Freightliner	E-6115	W1400	Gunite	E-8981
TDA 53 123568 002	Freightliner	53-123568-002	TDA23123625002	Volvo	E-12516	W1403	Gunite	E-10676
TDA 53 123575 002	Freightliner	53-123575-002	TDA53123544002	Volvo	53-123544-002	W143	Leland	E-5045
TDA 53 123579 002	Freightliner	53-123579-002	TDA53123601002	Freightliner	53-123601-002	W145	Leland	E-5046
TDA 53 123583 002	Freightliner	53-123583-002	TDA85122954002	Volvo	85-122954-002	W146	Leland	E-5036
TDA 53 123588 002	Freightliner	53-123588-002	TDA85122966002	Freightliner	85-122966-002	W149	Leland	E-5746
TDA 53 123589 002	Freightliner	53-123589-002	TDA85123348002	Volvo	85-123348-002	W15	Leland	E-5652-R
TDA 53 12359 0002	Freightliner	53-123590-002	TDA85123365002	Volvo	85-123365-002	W151	Leland	E-4957
TDA 53 123598 002	Freightliner	53-123598-002	TDA85123397002	Volvo	85-123397-002	W154	Leland	E-5576-R
TDA 53 123601 002	Freightliner	53-123601-002	TR1033	World Truck	E-1835	W155	Leland	E-5576-L
TDA 53 123602 002	Freightliner	53-123602-002	W-185	NWRA	E-5041	W158	Leland	E-7896-R
TDA 53 123605 002	Freightliner	53-123605-002	W-195	NWRA	E-5782	W159	Leland	E-7896-L
TDA 53 123606 002	Freightliner	53-123606-002	W-86	NWRA	E-5746	W16	Leland	E-5652-L
TDA 53 123607 002	Freightliner	53-123607-002	W1	Leland	E-5570	W160	Leland	E-5978-R
TDA 53 123608 002	Freightliner	53-123608-002	W10	Leland	E-4989	W160	Leland	E-7898-R
TDA 53 123627 002	Freightliner	53-123627-002	W100	NWRA	E-5046	W161	Leland	E-5978-L
TDA 53123592002	Freightliner	53-123592-002	W1006L	Gunite	E-10201-L	W161	Leland	E-7898-L
TDA 53123607	Freightliner	53-123607-002	W1006R	Gunite	E-10201-R	W166	Leland	E-5720-R

Not an exact match. Quality level or bill of materials may differ between the Euclid and competitors part. Refer to Euclid catalog for complete information on Euclid Parts.

CROSS REFERENCE LISTING

COMPETITOR NUMBER	COMPETITOR NAME	EUCLID NUMBER	COMPETITOR NUMBER	COMPETITOR NAME	EUCLID NUMBER	COMPETITOR NUMBER	COMPETITOR NAME	EUCLID NUMBER
W167	Leland	E-5720-L	W314	Leland	E-5922-R	W448	Leland	E-5781
W168	Leland	E-5718-R	W315	Leland	E-5922-L	W449	Leland	E-5783
W169	Leland	E-5718-L	W316	Leland	E-5918-R	W45	Leland	E-5560-L
W17	Leland	E-4955	W317	Leland	E-5918-L	W450	Leland	E-5828
W170	Leland	E-5719-R	W320	Leland	E-5920-R	W451	Leland	E-4961A
W171	Leland	E-5719-L	W321	Leland	E-5920-L	W452	Leland	E-5612-R
W180	Leland	E-5682	W322	Leland	E-3723-R	W453	Leland	E-5612-L
W181	Leland	E-5683	W323	Leland	E-3723-L	W454	Leland	E-5717-R
W182	Leland	E-5734	W328	Leland	E-3728-R	W455	Leland	E-5717-L
W183	Leland	E-5704	W329	Leland	E-3728-L	W456	Leland	E-5885
W184	Leland	E-5829	W330	Leland	E-9001-R	W457	Leland	E-5887
W189	NWRA	E-5823	W331	Leland	E-9001-L	W458	Leland	E-5892
W19	Leland	E-4989	W332	Leland	E-10249-R	W459	Leland	E-5929-R
W19	Leland	E-5712	W333	Leland	E-10249-L	W46	Leland	E-5551-R
W193	Leland	E-5839	W336	Leland	E-5932-R	W460	Leland	E-5929-L
W194	NWRA	E-5778	W337	Leland	E-5932-L	W461	Leland	E-5930-R
W2	Leland	E-5045	W338	Leland	E-5933-R	W462	Leland	E-5930-L
W205	Leland	E-5713-R	W339	Leland	E-5933-L	W463	Leland	E-5931-R
W206	Leland	E-5713-L	W342	Leland	E-5935-R	W464	Leland	E-5931-L
W207	Leland	E-5714-R	W343	Leland	E-5935-L	W467	Leland	E-5821
W208	Leland	E-5714-L	W344	Leland	E-5936-R	W47	Leland	E-5551-L
W209	Leland	E-5715-R	W345	Leland	E-5936-L	W474	Leland	E-5710
W21	Leland	E-5012	W346	Leland	E-3727-R	W475	Leland	E-5983-L
W210	Leland	E-5715-L	W346	Leland	E-5937-R	W476	Leland	E-5983-R
W211	Leland	E-5716-R	W347	Leland	E-3727-L	W477	Leland	E-5982-R
W212	Leland	E-5716-L	W347	Leland	E-5937-L	W478	Leland	E-5982-L
W215	Leland	E-5589-R	W356	Leland	E-10224-R	W479	Leland	E-5822
W216	Leland	E-5589-L	W356	Leland	E-5610-L	W48	Leland	E-5585-R
W22	Leland	E-4987A	W357	Leland	E-10224-L	W486	Leland	E-5978-R
W220	Leland	E-5761	W358	Leland	E-5985-R	W486	Leland	E-5988-R
W226	Leland	E-5824	W359	Leland	E-5985-L	W487	Leland	E-5978-L
W227	Leland	E-5825	W36	Leland	E-5558-R	W487	Leland	E-5988-L
W227	NWRA	E-5747	W362	Leland	E-8995-R	W488	Leland	E-5781
W228	NWRA	E-5755	W363	Leland	E-8995-L	W489	Leland	E-5993
W230	Leland	E-4975-R	W364	Leland	E-8996-R	W49	Leland	E-5585-L
W232	Leland	E-1835	W365	Leland	E-8996-L	W490	Leland	E-5994
W234	Leland	E-5708	W37	Leland	E-5558-L	W492	Leland	E-5991
W235	Leland	E-5711	W370	Leland	E-5722-R	W494	Leland	E-6054
W236	Leland	E-5765-R	W371	Leland	E-5722-L	W495	Leland	E-5999
W237	Leland	E-5765-L	W372	Leland	E-5756-R	W496	Leland	E-5998
W239	NWRA	E-5906	W373	Leland	E-5756-L	W497	Leland	E-5997
W24	Leland	E-5032	W378	Leland	E-5909-R	W498	Leland	E-6000A
W240	Leland	E-5748-L	W379	Leland	E-5909-L	W5	Leland	E-4958
W240	NWRA	E-5837	W38	Leland	E-5556-R	W50	Leland	E-5553-R
W241	Leland	E-5748-R	W380	Leland	E-5987-R	W500	Leland	E-5989-R
W241	NWRA	E-5905A	W381	Leland	E-5987-L	W501	Leland	E-5989-L
W242	Leland	E-5749-L	W384	Leland	E-8946-R	W502	Leland	E-10200-R
W242	NWRA	E-5904A	W385	Leland	E-8946-L	W503	Leland	E-10200-L
W243	Leland	E-5749-R	W388	Leland	E-5775	W504	Leland	E-8949-R
W243	NWRA	E-5902	W39	Leland	E-5556-L	W505	Leland	E-8949-L
W244	Leland	E-5750-R	W390	Leland	E-5776	W506	Leland	E-5995-R
W245	Leland	E-5750-L	W391	Leland	E-8992-R	W507	Leland	E-5995-L
W246	Leland	E-5706	W392	Leland	E-8992-L	W508	Leland	E-5996-R
W249	NWRA	E-5821	W393	Leland	E-8993-R	W509	Leland	E-5996-L
W252	NWRA	E-5822	W394	Leland	E-8993-L	W51	Leland	E-5553-L
W255	Leland	E-5837	W395	Leland	E-5910-R	W510	Leland	E-8972-R
W256	Leland	E-5902	W396	Leland	E-5910-L	W511	Leland	E-8972-L
W257	Leland	E-5904A	W397	Leland	E-5911-R	W512	Leland	E-8951-R
W258	Leland	E-5905A	W398	Leland	E-5911-L	W513	Leland	E-8951-L
W259	Leland	E-5906	W399	Leland	E-5900-R	W515	Leland	E-5632
W260	Leland	E-5923-R	W4	Leland	E-5572A	W516	Leland	E-3728-R
W261	Leland	E-5923-L	W40	Leland	E-5559-R	W516	Leland	E-5990-R
W262	Leland	E-5916-R	W400	Leland	E-5900-L	W517	Leland	E-3728-L
W263	Leland	E-5916-L	W401	Leland	E-5618-R	W517	Leland	E-5990-L
W264	Leland	E-5924-R	W402	Leland	E-5618-L	W518	Leland	E-8948-R
W265	Leland	E-5924-L	W403	Leland	E-5785A	W519	Leland	E-8948-L
W270	Leland	E-5721-R	W403	Leland	E-5839	W52	Leland	E-5557-R
W271	Leland	E-5721-L	W404	Leland	E-5040A	W520	Leland	E-5986-R
W274	Leland	E-5871-R	W404	Leland	E-5785A	W521	Leland	E-5986-L
W275	Leland	E-5871-L	W405	Leland	E-5784A	W522	Leland	E-6026-R
W276	Leland	E-5896-R	W406	Leland	E-5785A	W523	Leland	E-6026-L
W277	Leland	E-5896-L	W406	Leland	E-5839	W524	Leland	E-6030A
W278	Leland	E-5757-R	W407	Leland	E-5838	W525	Leland	E-9020
W279	Leland	E-5757-L	W408	Leland	E-5784A	W526	Leland	E-6058-R
W280	Leland	E-5766-R	W408	Leland	E-5926	W527	Leland	E-6058-L
W281	Leland	E-5766-L	W41	Leland	E-5559-L	W528	Leland	E-6059-R
W282	Leland	E-5764-R	W413	Leland	E-5974	W529	Leland	E-6059-L
W283	Leland	E-5764-L	W414	Leland	E-5754	W53	Leland	E-5557-L
W284	Leland	E-5870-R	W415	Leland	E-5889	W530	Leland	E-8950-R
W285	Leland	E-5870-L	W416	Leland	E-5890	W531	Leland	E-8950-L
W286	Leland	E-5869-R	W417	Leland	E-5891	W533	Leland	E-5755
W287	Leland	E-5869-L	W418	Leland	E-9023	W534	Leland	E-5976
W288	Leland	E-5868-R	W42	Leland	E-5561-R	W536	Leland	E-5827
W289	Leland	E-5868-L	W420	Leland	E-5953	W537	Leland	E-5883
W290	Leland	E-5899-R	W421	Leland	E-5973	W538	Leland	E-6000A
W291	Leland	E-5899-L	W426	Leland	E-6060-R	W539	Leland	E-5780
W292	Leland	E-5897-R	W427	Leland	E-6060-L	W541	Leland	E-5571A
W293	Leland	E-5897-L	W428	Leland	E-4958	W542	Leland	E-6027-R
W294	Leland	E-5898-R	W43	Leland	E-5561-L	W543	Leland	E-6027-L
W295	Leland	E-5898-L	W430	Leland	E-5726	W544	Leland	E-6036
W296	Leland	E-5978-R	W431	Leland	E-5728	W545	Leland	E-6035
W297	Leland	E-5978-L	W432	Leland	E-5729	W546	Leland	E-6034
W3	Leland	E-5571A	W433	Leland	E-5702	W547	Leland	E-6001A
W300	Leland	E-5876-R	W44	Leland	E-5560-R	W548	Leland	E-6057-R
W301	Leland	E-5876-L	W446	Leland	E-5753	W549	Leland	E-6057-L
W313	Leland	E-10224-L	W447	Leland	E-5055	W550	Leland	E-8990-R

Not an exact match. Quality level or bill of materials may differ between the Euclid and competitors part. Refer to Euclid catalog for complete information on Euclid Parts.

CROSS REFERENCE LISTING

COMPETITOR NUMBER	COMPETITOR NAME	EUCLID NUMBER	COMPETITOR NUMBER	COMPETITOR NAME	EUCLID NUMBER	COMPETITOR NUMBER	COMPETITOR NAME	EUCLID NUMBER
W551	Leland	E-8990-L	W669	Leland	E-10676	W89	Leland	E-4944
W554	Leland	E-5961	W67	Leland	E-4966-L	W890L	Gunite	E-8966-L
W555	Leland	E-5032	W674	Leland	E-8968-R	W890R	Gunite	E-8966-R
W556	Leland	E-5962	W675	Leland	E-8968-L	W90	Leland	E-4945
W557	Leland	E-5963	W676	Leland	E-8986	W90	NWRA	E-5570
W558	Leland	E-2002	W677	Leland	E-8962	W91	Leland	E-4946
W559	Leland	E-5964	W678	Leland	E-8988	W91	NWRA	E-5044
W560	Leland	E-5018	W679	Leland	E-8997	W92	Leland	E-4947
W561	Leland	E-5970	W68	Leland	E-4967-R	W93	Leland	E-4948
W562	Leland	E-5970	W68	NWRA	E-5953	W93	NWRA	E-5045
W563	Leland	E-5971	W680	Leland	E-8983-R	W932L	Gunite	E-8966-L
W564	Leland	E-5972	W681	Leland	E-8983-L	W932R	Gunite	E-8966-R
W565	Leland	E-6053	W682	Leland	E-8961	W94	Leland	E-4949
W566	Leland	E-9024	W686	Leland	E-9008-R	W94	NWRA	E-5047
W568	Leland	E-5841	W687	Leland	E-9008-L	W95	Leland	E-4950
W570	Leland	E-5778	W688	Leland	E-8987	W96	Leland	E-4951
W571	Leland	E-5782	W69	Leland	E-4967-L	W97	Leland	E-4952
W572	Leland	E-5820	W69	NWRA	E-5973	W97	NWRA	E-5572A
W573	Leland	E-5727	W690	Leland	E-8991	W98	Leland	E-4953
W574	Leland	E-6029A	W694	Leland	E-7895-R	W98	NWRA	E-5040A
W575	Leland	E-8947-R	W695	Leland	E-7895-L	W980L	Gunite	E-8968-L
W576	Leland	E-8947-L	W698	Leland	E-4968-R	W980R	Gunite	E-8968-R
W577	Leland	E-6028-R	W699	Leland	E-4968-L	W981L	Gunite	E-8969-L
W578	Leland	E-6028-L	W7	Leland	E-4962	W981R	Gunite	E-8969-R
W579	Leland	E-6023-R	W70	Leland	E-4968-R	W984L	Gunite	E-5977-L
W580	Leland	E-6023-L	W700	Leland	E-9010-R	W984R	Gunite	E-5977-R
W581	Leland	E-6024-R	W701	Leland	E-9010-L	W988L	Gunite	E-8972-L
W582	Leland	E-6024-L	W702	Leland	E-10221	W988R	Gunite	E-8972-R
W584	Leland	E-9012-R	W703	Leland	E-10218	W99	Leland	E-4961A
W585	Leland	E-9012-L	W706	Leland	E-10208-R	W99	NWRA	E-5785A
W586	Leland	E-4976-R	W707	Leland	E-10208-L	W992L	Gunite	E-8979-L
W588	Leland	E-4979-R	W708	Leland	E-10219	W992R	Gunite	E-8979-R
W590	Leland	E-9022-R	W71	Leland	E-4968-L	WP-259	Gunite	E-5754
W595	Leland	E-5796	W710	Leland	E-8985-R	WP-466L	Gunite	E-10203-L
W598	Leland	E-8959-R	W711	Leland	E-8985-L	WP-466R	Gunite	E-10203-R
W599	Leland	E-8959-L	W712	Leland	E-8966-R	WP1138	Gunite	E-5904A
W6	Leland	E-4956A	W713	Leland	E-8966-L	WP147	Gunite	E-4956A
W600	Leland	E-8963	W714	Leland	E-9526	WP148	Gunite	E-4963
W601	Leland	E-8964	W716	Leland	E-10215	WP166	Gunite	E-5041
W602	Leland	E-8965	W717	Leland	E-10216	WP174	Gunite	E-5800
W604	Leland	E-8946-L	W718	Leland	E-10220	WP177	Gunite	E-4958
W606	Leland	E-3723-R	W719	Leland	E-10220	WP2	Gunite	E-4962
W607	Leland	E-3723-L	W72	Leland	E-4969-R	WP202	Gunite	E-5706
W608	Leland	E-8969-R	W72	NWRA	E-5824	WP267	Gunite	E-5747
W609	Leland	E-8969-L	W720	Leland	E-10253-R	WP28	Gunite	E-5796
W610	Leland	E-8979-R	W720L	Gunite	E-8972-L	WP344	Gunite	E-5753
W611	Leland	E-8979-L	W720R	Gunite	E-8972-R	WP368	Gunite	E-5755
W612	Leland	E-9005-R	W721	Leland	E-10253-L	WP383	Gunite	E-5778
W613	Leland	E-9005-L	W722	Leland	E-10254-R	WP384	Gunite	E-5782
W616	Leland	E-7897-R	W723	Leland	E-10254-L	WP39	Gunite	E-4960
W617	Leland	E-7897-L	W724	Leland	E-6033-R	WP398	Gunite	E-5837
W618	Leland	E-10234	W725	Leland	E-6033-L	WP455	Gunite	E-5754
W619	Leland	E-10235	W728	Leland	E-10209-R	WP477	Gunite	E-4987A
W62	Leland	E-4964-R	W729	Leland	E-10209-L	WP515	Gunite	E-5889
W620	Leland	E-7896-R	W73	Leland	E-4969-L	WP541	Gunite	E-5970
W621	Leland	E-7896-L	W730	Leland	E-10210-R	WP544	Gunite	E-5890
W623	Leland	E-9021	W731	Leland	E-10210-L	WP545	Gunite	E-5891
W625	Leland	E-5988-L	W732	Leland	E-9523-R	WP682	Gunite	E-5974
W626	Leland	E-8952-R	W733	Leland	E-9523-L	WP693	Gunite	E-5944
W627	Leland	E-8952-L	W734	Leland	E-9524-R	WP722	Gunite	E-5902
W628	Leland	E-8954-R	W735	Leland	E-9524-L	WP725	Gunite	E-9023
W629	Leland	E-8954-L	W736	Leland	E-9525-R	WP80	Gunite	E-5036
W63	Leland	E-4964-L	W737	Leland	E-9525-L	WP81	Gunite	E-5799
W630	Leland	E-9007	W74	Leland	E-5724	WP83	Gunite	E-5887
W631	Leland	E-9006	W74	NWRA	E-5825	WP845	Gunite	E-5972
W634	Leland	E-8977-R	W742	Leland	E-10213-R	WP846	Gunite	E-5904A
W635	Leland	E-8977-L	W743	Leland	E-10213-L	WP855	Gunite	E-4956A
W636	Leland	E-8958-R	W746	Leland	E-5977-R	WP858	Gunite	E-5905A
W637	Leland	E-8958-L	W747	Leland	E-5977-L	WP866	Gunite	E-5906
W638	Leland	E-9000-R	W748	Leland	E-7775	X-1251	NWRA	E-5612-L
W639	Leland	E-9000-L	W759	Leland	E-10257	X-1419	NWRA	E-5578-L
W64	Leland	E-4965-R	W765	Leland	E-9837	X1050	NWRA	E-4988-R
W640	Leland	E-8976-R	W766	Leland	E-5978-R	X1051	NWRA	E-4988-L
W641	Leland	E-8976-L	W767	Leland	E-5978-L	X1068	NWRA	E-4961A
W642	Leland	E-10214-R	W770	Leland	E-10256	X1080	NWRA	E-4965-R
W643	Leland	E-10214-L	W788L	Gunite	E-8972-L	X1081	NWRA	E-4965-L
W644	Leland	E-8978-R	W788R	Gunite	E-8972-R	X1108	NWRA	E-5682
W645	Leland	E-8978-L	W79	Leland	E-10229	X1109	NWRA	E-5683
W646	Leland	E-8955-L	W8	Leland	E-4963	X1110	NWRA	E-5734
W647	Leland	E-8955-L	W81	Leland	E-10230	X1122	NWRA	E-5032
W648	Leland	E-10206-R	W82	Leland	E-5610-R	X1124	NWRA	E-5007
W649	Leland	E-10206-L	W826L	Gunite	E-8966-L	X1146	NWRA	E-4976-R
W65	Leland	E-4965-L	W826R	Gunite	E-8966-R	X1148	NWRA	E-4975-R
W650	Leland	E-8960	W83	Leland	E-5610-L	X115	Eaton	E-576
W652	Leland	E-10202-R	W83	NWRA	E-5927	X1164	NWRA	E-5708
W653	Leland	E-10202-L	W84	Leland	E-5613-R	X1250	NWRA	E-5612-R
W656	Leland	E-8980	W84	NWRA	E-5927	X1263	NWRA	E-5613-R
W657	Leland	E-8981	W846	Gunite	E-5904A	X1264	NWRA	E-5613-L
W66	Leland	E-4966-R	W85	Leland	E-5613-L	X1286	NWRA	E-5610-R
W661	Leland	E-9009	W85	NWRA	E-5926	X1287	NWRA	E-5610-L
W662	Leland	E-10225-R	W855	Gunite	E-4956A	X1342	NWRA	E-5704
W663	Leland	E-10225-L	W858	Gunite	E-5905A	X1362	NWRA	E-6060-R
W664	Leland	E-8982-R	W866	Gunite	E-5906	X1363	NWRA	E-6060-L
W665	Leland	E-8982-L	W87	Leland	E-4942	X1378	NWRA	E-5722-R
W666	Leland	E-9004-R	W883L	Gunite	E-8978-L	X1379	NWRA	E-5722-L
W667	Leland	E-9004-L	W883R	Gunite	E-8978-R	X1384	NWRA	E-4968-R

Not an exact match. Quality level or bill of materials may differ between the Euclid and competitors part. Refer to Euclid catalog for complete information on Euclid Parts.

CROSS REFERENCE LISTING

COMPETITOR NUMBER	COMPETITOR NAME	EUCLID NUMBER	COMPETITOR NUMBER	COMPETITOR NAME	EUCLID NUMBER	COMPETITOR NUMBER	COMPETITOR NAME	EUCLID NUMBER
X1385	NWRA	E-4968-L	X1714	NWRA	E-8947-R	X2042	NWRA	E-4968-L
X1386	NWRA	E-4969-R	X1715	NWRA	E-8947-L	X2043	NWRA	E-9000-R
X1387	NWRA	E-4969-L	X1718	NWRA	E-5748-R	X2044	NWRA	E-9000-L
X1389	NWRA	E-5588-L	X1719	NWRA	E-5748-L	X2053	NWRA	E-5931-R
X1391	NWRA	E-5719-R	X1723	NWRA	E-5897-R	X2054	NWRA	E-5931-L
X1392	NWRA	E-5719-L	X1724	NWRA	E-5897-L	X2055	NWRA	E-5929-R
X1393	NWRA	E-5720-R	X1725	NWRA	E-5749-R	X2056	NWRA	E-5929-L
X1394	NWRA	E-5720-L	X1726	NWRA	E-5749-L	X2057	NWRA	E-5930-R
X1395	NWRA	E-5587-R	X1727	NWRA	E-5750-R	X2058	NWRA	E-5930-L
X1396	NWRA	E-5587-L	X1728	NWRA	E-5750-L	X2081	NWRA	E-10235
X1397	NWRA	E-5588-R	X1729	NWRA	E-5727	X2100	NWRA	E-5775
X1398	NWRA	E-5588-L	X1730	NWRA	E-5728	X2105	NWRA	E-5726
X1407	NWRA	E-7897-R	X1731	NWRA	E-5868-R	X2106	NWRA	E-5729
X1408	NWRA	E-7897-L	X1732	NWRA	E-5868-L	X2107	NWRA	E-5717-R
X1411	NWRA	E-7898-R	X1745	NWRA	E-8994-R	X2108	NWRA	E-5717-L
X1412	NWRA	E-7898-L	X1746	NWRA	E-8994-L	X2111	NWRA	E-10249-R
X1416	NWRA	E-5576-R	X1751	NWRA	E-8992-R	X2112	NWRA	E-10249-L
X1417	NWRA	E-5576-L	X1752	NWRA	E-8992-L	X2113	NWRA	E-5985-R
X1418	NWRA	E-5578-R	X1753	NWRA	E-8993-R	X2114	NWRA	E-5985-L
X1420	NWRA	E-5579-R	X1754	NWRA	E-8993-L	X2122	NWRA	E-7897-R
X1421	NWRA	E-5579-L	X1762	NWRA	E-5987-R	X2131	NWRA	E-5983-R
X1424	NWRA	E-8965	X1763	NWRA	E-5987-L	X2132	NWRA	E-5983-L
X1429	NWRA	E-5008	X1766	NWRA	E-8995-R	X2133	NWRA	E-5982-R
X1445	NWRA	E-1828	X1767	NWRA	E-8995-L	X2134	NWRA	E-5982-L
X1473	NWRA	E-8963	X1777	NWRA	E-5799	X2138	NWRA	E-5988-R
X1512	NWRA	E-3723-R	X1787	NWRA	E-5796	X2139	NWRA	E-5988-L
X1513	NWRA	E-3723-L	X1790	NWRA	E-5798	X2140	NWRA	E-5993
X1516	NWRA	E-5935-R	X1792	NWRA	E-5800	X2141	NWRA	E-5994
X1517	NWRA	E-5935-L	X1793	NWRA	E-5801	X2143	NWRA	E-5991
X1520	NWRA	E-5936-R	X1802	NWRA	E-5988-L	X2155	NWRA	E-5997
X1521	NWRA	E-5936-L	X1803	NWRA	E-5652-R	X2156	NWRA	E-6000A
X1522	NWRA	E-5937-R	X1804	NWRA	E-5652-L	X2157	NWRA	E-5998
X1523	NWRA	E-5937-L	X1807	NWRA	E-5554-R	X2158	NWRA	E-5999
X1524	NWRA	E-3728-R	X1808	NWRA	E-5554-L	X2159	NWRA	E-9020
X1525	NWRA	E-3728-L	X1818	NWRA	E-5711	X2171	NWRA	E-8990-R
X1554	NWRA	E-5558-R	X1823	NWRA	E-4967-R	X2172	NWRA	E-8990-L
X1555	NWRA	E-5558-L	X1824	NWRA	E-4967-L	X2198	NWRA	E-6026-R
X1558	NWRA	E-5556-R	X1828	NWRA	E-7895-R	X2199	NWRA	E-6026-L
X1559	NWRA	E-5556-L	X1829	NWRA	E-7895-L	X2200	NWRA	E-6028-L
X1562	NWRA	E-5559-R	X1831	NWRA	E-5977-R	X2201	NWRA	E-6028-R
X1563	NWRA	E-5559-L	X1832	NWRA	E-5977-L	X2202	NWRA	E-6058-R
X1568	NWRA	E-5561-R	X1833	NWRA	E-5718-R	X2203	NWRA	E-6058-L
X1569	NWRA	E-5561-L	X1834	NWRA	E-5718-L	X2204	NWRA	E-6059-R
X1572	NWRA	E-5560-R	X1835	NWRA	E-7896-R	X2205	NWRA	E-6059-L
X1573	NWRA	E-5560-L	X1836	NWRA	E-7896-L	X2206	NWRA	E-8950-R
X1574	NWRA	E-5551-R	X1837	NWRA	E-9022-R	X2207	NWRA	E-8950-L
X1575	NWRA	E-5551-L	X1841	NWRA	E-8946-R	X2208	NWRA	E-6027-R
X1576	NWRA	E-5932-R	X1842	NWRA	E-8946-L	X2209	NWRA	E-6027-L
X1577	NWRA	E-5932-L	X1843	NWRA	E-5721-R	X50586	NWRA	E-9804
X1578	NWRA	E-5585-R	X1844	NWRA	E-5721-L	X50588	NWRA	E-9808
X1579	NWRA	E-5585-L	X1858	NWRA	E-4964-R	X50589	NWRA	E-9807
X1580	NWRA	E-5553-R	X1859	NWRA	E-4964-L	X50590	NWRA	E-9809
X1581	NWRA	E-5553-L	X1861	NWRA	E-5871-R	X50593	NWRA	E-4247
X1583	NWRA	E-5933-L	X1862	NWRA	E-5871-L	X50600	NWRA	23-122729-002
X1586	NWRA	E-6023-R	X1870	NWRA	E-5711	X50600	NWRA	E-4230
X1587	NWRA	E-6023-L	X1873	NWRA	E-5978-R	XW100	NWRA	E-5046
X1588	NWRA	E-5557-R	X1874	NWRA	E-5978-L	XW103	NWRA	E-5784A
X1589	NWRA	E-5557-L	X1884	NWRA	E-5911-R	XW112	NWRA	E-5827
X1592	NWRA	E-5933-R	X1885	NWRA	E-5911-L	XW113	NWRA	E-5828
X1593	NWRA	E-5933-L	X1888	NWRA	E-5910-R	XW114	NWRA	E-5829
X1606	NWRA	E-5713-R	X1889	NWRA	E-5910-L	XW120	NWRA	E-5783
X1607	NWRA	E-5713-L	X1893	NWRA	E-5909-R	XW121	NWRA	E-5781
X1608	NWRA	E-5714-R	X1894	NWRA	E-5909-L	XW122	NWRA	E-5780
X1609	NWRA	E-5714-L	X1905	NWRA	E-5900-R	XW185	NWRA	E-5041
X1612	NWRA	E-5715-R	X1906	NWRA	E-5900-L	XW191	NWRA	E-5753
X1613	NWRA	E-5715-L	X1913	NWRA	E-5924-R	XW194	NWRA	E-5778
X1614	NWRA	E-5716-R	X1914	NWRA	E-5924-L	XW227	NWRA	E-5747
X1615	NWRA	E-5716-L	X1915	NWRA	E-5916-R	XW228	NWRA	E-5755
X1616	NWRA	E-5589-R	X1916	NWRA	E-5916-L	XW239	NWRA	E-5906
X1617	NWRA	E-5589-L	X1917	NWRA	E-5923-R	XW240	NWRA	E-5837
X1636	NWRA	E-5876-R	X1918	NWRA	E-5923-L	XW243	NWRA	E-5902
X1637	NWRA	E-5876-L	X1927	NWRA	E-5899-R	XW244	NWRA	E-9023
X1666	NWRA	E-5618-R	X1928	NWRA	E-5899-L	XW249	NWRA	E-5821
X1667	NWRA	E-5618-L	X1931	NWRA	E-5898-R	XW252	NWRA	E-5822
X1687	NWRA	E-5710	X1932	NWRA	E-5898-L	XW255	NWRA	E-5904A
X1688	NWRA	E-5764-R	X1935	NWRA	E-5896-R	XW55K	NWRA	E-5573
X1689	NWRA	E-5764-L	X1936	NWRA	E-5896-L	XW68	NWRA	E-5953
X1692	NWRA	E-5870-R	X1941	NWRA	E-5920-R	XW72	NWRA	E-5824
X1693	NWRA	E-5870-L	X1942	NWRA	E-5920-L	XW74	NWRA	E-5825
X1700	NWRA	E-5776	X1945	NWRA	E-5918-R	XW85	NWRA	E-5926
X1702	NWRA	E-5765-R	X1946	NWRA	E-5918-L	XW86	NWRA	E-5746
X1703	NWRA	E-5765-L	X1947	NWRA	E-5922-R	XW90	NWRA	E-5570
X1704	NWRA	E-5756-R	X1948	NWRA	E-5922-L	XW91	NWRA	E-5044
X1705	NWRA	E-5756-L	X1983	NWRA	E-5986-R	XW93	NWRA	E-5045
X1706	NWRA	E-5757-R	X1984	NWRA	E-5986-L	XW94	NWRA	E-5047
X1707	NWRA	E-5757-L	X1991	NWRA	E-8996-R	XW96	NWRA	E-5571A
X1708	NWRA	E-5766-R	X1992	NWRA	E-8996-L	XW97	NWRA	E-5572A
X1709	NWRA	E-5766-L	X2033	NWRA	E-10224-R	XW98	NWRA	E-5040A
X1710	NWRA	E-5869-R	X2033	NWRA	E-5610-R	YC3Z1125AA	Ford	E-11326
X1711	NWRA	E-5869-L	X2034	NWRA	E-10224-L	YC3Z2C026AA	Ford	E-12521
X1712	NWRA	E-4966-R	X2037	NWRA	E-9001-R			
X1713	NWRA	E-4966-L	X2038	NWRA	E-9001-L			

Not an exact match. Quality level or bill of materials may differ between the Euclid and competitors part. Refer to Euclid catalog for complete information on Euclid Parts.

S.O.S.

Special Order Service

Can't find it? Trouble sourcing parts? Need assistance?

Let Euclid's Special Order Service (S.O.S.) help.

Euclid's position as the market leader provides you access to the products and manufacturers listed below. These entire product lines are available to you by just placing a phone call to Euclid's S.O.S. Department at 866-238-2543 (option 2) in the U.S. or 800-387-3889 in Canada.

AIR BRAKE PARTS

- Anchorlok
- Bendix (Allied Signal)
- Brake Shoes
- Camshafts
- Dana
- Fruehauf
- Hallex

HYDRAULIC BRAKE PARTS

- Calipers - New & Remanufactured
- Clutch Master Cylinders
- Clutch Slave Cylinders
- Dayton
- EIS
- Lucas
- Master Cylinders
- Rotors
- Wagner Brake
- Wheel Cylinders

FRICTION MATERIAL

- Performance Friction
- Tenneco HD Brake/CM

WHEEL & HUB PARTS

- ConMet
- Gunite
- Webb Wheel

SHOCK ABSORBERS & AIR SPRINGS

- Gabriel
- Firestone
- Neway
- Monroe
- Others

SUSPENSION PARTS

- Binkley
- Cambria
- Chalmers
- Fruehauf
- Hendrickson
- Hendrickson Turner
- Hutchens
- Kwik-Loc (Jifflox)
- Neway
- Page
- Reyco/Transpro
- Ridewell
- Suspensions Incorporated
- Torque Arms
- Trailmobile

Full Suspensions Are Available

FRONT END PARTS

- King Pin Kits
- Tie Rod Ends
- Drag Link Ends
- Drag Links

AIR CONDITIONING & HEATING PARTS

- Air Source
- Robinair

TOOLS & SHOP EQUIPMENT

- Fraser Gauge Company
- Kent Moore
- Ken Tool
- OTC (Owatonna Tool Company)
- Tiger Tool

Don't miss the sale! Call Euclid's Special Order Service.

NUMERICAL PARTS LISTING

Part No.	Page	Part No.	Page	Part No.	Page	Part No.	Page
03-012480-002	1-12,1-13, 1-21	03-122488-002	1-12,1-14, 1-18	03-123431-002	1-15,1-18	14-15968-1235	1-28
03-012488-002	1-12,1-13, 1-22	03-122513-002	1-12,1-14, 1-22	03-123448-002	1-15,1-19	14-15968-129	1-27
03-012582-002	1-12,1-13, 1-21	03-122518-002	1-12,1-14, 1-21	03-123466-002	1-15,1-20	14-15968-1293MTB	1-28
03-120376-002	1-12,1-13, 1-22	03-122529-002	1-12,1-14, 1-19	03-123493-002	1-15,1-19	14-15968-130	1-27
03-120442-002	1-12,1-13, 1-21	03-122550-002	1-12,1-14, 1-21	03-123500-002	1-15,1-20	14-15968-350X30	1-28
03-120516-002	1-12,1-13, 1-19	03-122561-002	1-12,1-14, 1-19	03-123520-002	1-15,1-22	14-15968-351X30	1-28
03-120517-002	1-12,1-13, 1-19	03-122562-002	1-12,1-14, 1-19	03-123538-002	1-15,1-20	14-15968-352X30	1-28
03-120566-002	1-12,1-13, 1-18	03-122575-002	1-12,1-14, 1-18	04-15502-004	1-25	14-15968-352X30	1-28
03-120574-002	1-12,1-13, 1-21	03-122600-002	1-12,1-14, 1-21	04-15502-006	1-25	14-15968-353X30	1-28
03-120586-002	1-12,1-13, 1-21	03-122603-002	1-12,1-14, 1-21	04-15502-007	1-25	14-15984-1016	1-31
03-120705-002	1-12,1-13, 1-18	03-122607-002	1-12,1-14, 1-22	04-15502-022	1-25	14-15984-1017	1-31
03-120743-002	1-12,1-13, 1-21	03-122683-002	1-12,1-14, 1-21	04-15502-029	1-25	14-15984-1038X30	1-31
03-120754-002	1-12,1-13, 1-21	03-122921-002	1-14,1-19	04-15502-030	1-25	14-15984-1039X30	1-31
03-120822-002	1-12,1-13, 1-18	03-122925-002	1-14,1-21	04-15502-031	1-25	14-15984-1067	1-31
03-120855-002	1-12,1-13, 1-20	03-122947-002	1-14,1-18	04-15502-032	1-25	14-15984-1068	1-31
03-120877-002	1-12,1-13, 1-22	03-122948-002	1-14,1-21	04-15502-041	1-25	14-15984-1069	1-31
03-120882-002	1-12,1-13, 1-22	03-122963-002	1-14,1-18	04-15968-002	1-27	14-15984-1070	1-31
03-120936-002	1-12,1-13, 1-22	03-122964-002	1-14,1-18	04-15968-007	1-27	14-15984-1072	1-31
03-120981-002	1-12,1-14, 1-18	03-122966-002	1-14,1-20	04-15968-009	1-27	14-15984-1081	1-31
03-120988-002	1-12,1-14, 1-20	03-122971-002	1-14,1-18	04-15968-037	1-27	14-15984-1085X30	1-31
03-122009-002	1-12,1-14, 1-21	03-122978-002	1-14,1-22	04-15968-038	1-27	14-15984-1089X30	1-31
03-122011-002	1-12,1-14, 1-19	03-122978-002	1-14,1-22	04-15968-043	1-27	14-15984-1184	1-31
03-122027-002	1-12,1-14, 1-21	03-123020-002	1-14,1-18	04-15968-044	1-27	14-15984-1185	1-31
03-122078-002	1-12,1-14, 1-18	03-123024-002	1-14,1-19	04-15968-045	1-27	14-15984-1186	1-31
03-122104-002	1-12,1-14, 1-18	03-123025-002	1-14,1-21, 1-23,1-24	04-15981-016	1-29	14-15984-1187	1-31
03-122126-002	1-12,1-14, 1-21	03-123200-002	1-14,1-21	04-15981-017	1-29	14-15984-1537X30	1-31
03-122222-002	1-12,1-14, 1-21	03-123207-002	1-14,1-21, 1-26,1-28, 1-31	04-15981-018	1-29	14-15984-1540X30	1-31
03-122239-002	1-12,1-14, 1-21	03-123219-002	1-14,1-20	04-15981-019	1-29	53-123512-002	1-13,1-15, 1-18
03-122290-002	1-12,1-14, 1-21	03-123254-002	1-14,1-18	04-15984-001	1-30	53-123535-002	1-13,1-15, 1-22
03-122314-002	1-12,1-14, 1-18	03-123276-002	1-14,1-19	04-15984-002	1-31	53-123537-002	1-13,1-15, 1-21,1-28, 1-31
03-122453-002	1-12,1-14, 1-21	03-123297-002	1-14,1-21	04-15984-003	1-31	53-123542-002	1-13,1-15, 1-19
03-122455-002	1-12,1-14, 1-21	03-123302-002	1-14,1-20	04-15984-004	1-31	53-123544-002	1-13,1-15, 1-22
		03-123331-002	1-15,1-19	04-15984-005	1-31	53-123564-002	1-13,1-15, 1-21
		03-123332-002	1-15,1-19	04-15984-006	1-30	53-123565-002	1-13,1-15, 1-21
		03-123365-002	1-15,1-21, 1-26,1-28	04-15984-007	1-30	53-123566-002	1-13,1-15, 1-21
		03-123366-002	1-15,1-18	04-15984-010	1-31	53-123567-002	1-13,1-15, 1-18
		03-123382-002	1-15,1-18	04-15984-012	1-31	53-123568-002	1-13,1-16, 1-19
		03-123383-002	1-15,1-20	04-15984-013	1-31	53-123575-002	1-13,1-16, 1-19
		03-123396-002	1-15,1-19	04-15984-036	1-31	53-123579-002	1-13,1-16, 1-22
		03-123397-002	1-15,1-21	04-15984-041	1-30	53-123580-002	1-13,1-16, 1-22
		03-123398-002	1-15,1-21	04-15984-042	1-30	53-123581-002	1-13,1-16, 1-22
		03-123399-002	1-15,1-20	04-15984-052	1-30	53-123582-002	1-13,1-16, 1-21
		03-123406-002	1-15,1-22	04-15984-053	1-30	53-123583-002	1-13,1-16, 1-21
		03-123409-002	1-15,1-21	13-123219-002	1-15,1-20	53-123588-002	1-13,1-16, 1-20
		03-123420-002	1-15,1-18	13-123302-002	1-15,1-20	53-123589-002	1-13,1-16, 1-20
		03-123421-002	1-15,1-18	14-15413-1032	1-23		
		03-123427-002	1-15,1-20	14-15479-1000	1-24		
		03-123428-002	1-15,1-22	14-15502-050	1-26		
		03-123430-002	1-15,1-21	14-15502-051	1-26		
				14-15502-064	1-26		
				14-15502-087	1-25		
				14-15502-088	1-25		
				14-15502-503	1-26		
				14-15502-504	1-26		
				04-15968-002	1-25		
				14-15968-1033	1-28		
				14-15968-1082	1-28		
				14-15968-1083	1-28		
				14-15968-1107X30	1-28		
				14-15968-111	1-28		
				14-15968-112	1-28		
				14-15968-114	1-28		
				14-15968-1230	1-28		
				14-15968-1234	1-28		

NUMERICAL PARTS LISTING

Part No	Page	Part No	Page	Part No	Page	Part No	Page
53-123590-002	1-13,1-16, 1-20	85-123421-002	1-17,1-18	E-2341	2-88	E-4869	2-71
53-123592-002	1-13,1-16, 1-19	85-123427-002	1-17,1-20	E-2417	2-82	E-4871	2-71,2-72
53-123598-002	1-13,1-16, 1-19	85-123428-002	1-17,1-22	E-2418	2-81	E-4873	2-75
53-123600-002	1-13,1-16, 1-19	85-123431-002	1-17,1-18	E-2419	2-81	E-4875	2-72
53-123601-002	1-13,1-16, 1-20	85-123444-002	1-17,1-19	E-2420	2-82	E-4876	2-76
53-123602-002	1-13,1-16, 1-20	85-123448-002	1-17,1-19	E-2421	2-82	E-4877	2-80
53-123605-002	1-13,1-16, 1-20	85-123463-002	1-17,1-20	E-2422	2-82	E-4878	2-77
53-123606-002	1-13,1-16, 1-20	85-123465-002	1-17,1-19	E-2423	2-83	E-4879	2-71
53-123607-002	1-13,1-16, 1-20	85-123466-002	1-17,1-20	E-2424	2-83	E-4881	2-80
53-123608-002	1-13,1-16, 1-20	85-123520-002	1-17,1-22	E-2425	2-83	E-4942	2-49
53-123609-002	1-16,1-19	85-123548-002	1-17,1-19	E-2431	2-88	E-4944	2-49
53-123627-002	1-16,1-20	85-123553-002	1-17,1-19	E-2432	2-88	E-4945	2-49
85-120516-002	1-16,1-19	85-123556-002	1-17,1-20	E-2433	2-88	E-4946	2-49
85-120517-002	1-16,1-19	85-123561-002	1-17,1-20	E-2434	2-88	E-4947	2-49
85-120586-002	1-16,1-21	85-123569-002	1-17,1-20	E-2435	2-88	E-4948	2-49
85-120855-002	1-16,1-20	85-123570-002	1-17,1-22, 1-28	E-2436	2-88	E-4949	2-49
85-120877-002	1-16,1-22	85-123651-002	1-17,1-20	E-2437	2-88	E-4950	2-49
85-122009-002	1-16,1-21	85-123652-002	1-17,1-21	E-2438	2-88	E-4951	2-49
85-122011-002	1-16,1-19	E-03009	2-87	E-2460	2-76	E-4952	2-49
85-122103-002	1-16,1-21	E-04000	2-87	E-2461	2-76,2-78	E-4953	2-49
85-122266-002	1-16,1-20	E-04000V	2-87	E-2462	2-76,2-78, 2-81,2-82	E-4955	2-51
85-122505-002	1-16,1-18	E-04075	2-87	E-2463	2-77	E-4956A	2-51
85-122518-002	1-16,1-21	E-04075AH	2-87	E-2464	2-76	E-4957	2-52
85-122550-002	1-16,1-21	E-04075H	2-87	E-2465	2-77	E-4958	2-51
85-122600-002	1-16,1-21	E-04075V	2-87	E-2467	2-77	E-4960	2-48
85-122683-002	1-16,1-21	E-05500	2-87	E-2468	2-77	E-4961A	2-9
85-122921-002	1-16,1-19	E-540	2-65,2-68, 2-70	E-2550	2-64	E-4962	2-10
85-122947-002	1-16,1-18	E-572	2-65,2-68, 2-70	E-2658	2-75	E-4963	2-10
85-122948-002	1-16,1-21	E-573	2-68,2-69, 2-78	E-2659	2-74,2-75	E-4964-L	2-32
85-122954-002	1-16,1-20	E-576	2-63	E-2660	2-74,2-75	E-4964-R	2-32
85-122964-002	1-16,1-18	E-617	2-63	E-2662	2-75	E-4965-L	2-32
85-122966-002	1-16,1-20	E-618	2-63	E-2663	2-75	E-4965-R	2-32
85-122968-002	1-16,1-21	E-619	2-63	E-3008	2-65	E-4966-L	2-33
85-122974-002	1-16,1-18	E-620	2-63	E-3009	2-67	E-4966-R	2-33
85-122978-002	1-16,1-21	E-975	2-87	E-3010	2-64	E-4967-L	2-33
85-122984-002	1-16,1-20	E-1000	2-69	E-3501	2-71	E-4967-R	2-33
85-122986-002	1-16,1-18	E-1001	2-69	E-3502	2-71	E-4968-L	2-34
85-122988-002	1-16,1-20	E-1087	2-69	E-3504	2-80	E-4968-R	2-34
85-123000-002	1-16,1-21	E-1251	2-64,2-66	E-3505	2-79	E-4969-L	2-34
85-123203-002	1-16,1-19	E-1252	2-64	E-3506	2-80	E-4969-R	2-34
85-123207-002	1-16,1-21	E-1253	2-64,2-66	E-3507	2-80	E-4975-R	2-4
85-123254-002	1-17,1-18	E-1559	2-63	E-3508	2-80	E-4976-R	2-4
85-123276-002	1-17,1-19	E-1561	2-64	E-3509	2-80	E-4979-R	2-4
85-123297-002	1-17,1-21	E-1828	2-10	E-3510	2-74	E-4987A	2-52
85-123331-002	1-17,1-19	E-1835	2-9	E-3723-L	2-18	E-4988-L	2-40
85-123332-002	1-17,1-19	E-2002	2-50	E-3723-R	2-18	E-4988-R	2-40
85-123345-002	1-17,1-18	E-2128	2-65,2-66	E-3727-L	2-18	E-4989	2-52
85-123348-002	1-17,1-22	E-2237	2-68,2-69	E-3727-R	2-18	E-4990A	2-53
85-123365-002	1-17,1-21	E-2296	2-74	E-3728-L	2-18	E-5007	2-10
85-123366-002	1-17,1-18	E-2297	2-73	E-3728-R	2-18	E-5008	2-10
85-123370-002	1-17,1-20	E-2299	2-74	E-4851	2-73	E-5012	2-52
85-123382-002	1-17,1-19	E-2300	2-74	E-4852	2-73	E-5018	2-50
85-123383-002	1-17,1-20	E-2301	2-74	E-4853	2-73	E-5032	2-10,2-50
85-123396-002	1-17,1-19	E-2303	2-67,2-79, 2-83	E-4854	2-70	E-5036	2-53
85-123397-002	1-17,1-21	E-2304	2-78,2-83	E-4855	2-72	E-5040A	2-55
85-123399-002	1-17,1-20	E-2305	2-67,2-79, 2-83	E-4857	2-80	E-5044	2-55
85-123400-002	1-17,1-20	E-2306	2-63	E-4858	2-76	E-5045	2-54
85-123406-002	1-17,1-22	E-2340	2-88	E-4859	2-71	E-5046	2-59
85-123409-002	1-17,1-21			E-4861	2-71	E-5047	2-59
85-123420-002	1-17,1-18			E-4862	2-77	E-5055	2-55
				E-4863	2-77	E-5551-L	2-14
				E-4865	2-71	E-5551-R	2-14
				E-4868	2-73	E-5553-L	2-15
						E-5553-R	2-15

NUMERICAL PARTS LISTING

Part No	Page	Part No	Page	Part No	Page	Part No	Page
E-5554-L	2-4	E-5722-L	2-31	E-5869-R	2-34	E-5937-R	2-19
E-5554-R	2-4	E-5722-R	2-31	E-5870-L	2-36	E-5944	2-47
E-5556-L	2-13	E-5724	2-37	E-5870-R	2-36	E-5946	2-47
E-5556-R	2-13	E-5726	2-51	E-5871-L	2-28	E-5947	2-48
E-5557-L	2-16	E-5727	2-51	E-5871-R	2-28	E-5949	2-48
E-5557-R	2-16	E-5728	2-52	E-5872	2-48	E-5952	2-49
E-5558-L	2-12	E-5729	2-52	E-5876-L	2-17	E-5953	2-60
E-5558-R	2-12	E-5734	2-7	E-5876-R	2-17	E-5954	2-48
E-5559-L	2-13	E-5736	2-49	E-5883	2-56	E-5955	2-48
E-5559-R	2-13	E-5737	2-49	E-5885	2-56	E-5957	2-49
E-5560-L	2-14	E-5738	2-49	E-5887	2-52	E-5960	2-49
E-5560-R	2-14	E-5739	2-49	E-5889	2-57	E-5961	2-50
E-5561-L	2-13	E-5740	2-49	E-5890	2-57	E-5962	2-50
E-5561-R	2-14	E-5742	2-49	E-5891	2-57	E-5963	2-50
E-5570	2-54	E-5743	2-49	E-5892	2-7	E-5964	2-50
E-5571A	2-54	E-5747	2-56	E-5896-L	2-29	E-5970	2-50
E-5572A	2-55	E-5748-L	2-23	E-5896-R	2-29	E-5971	2-50
E-5573	2-56	E-5748-R	2-23	E-5897-L	2-21	E-5972	2-50
E-5576-L	2-7	E-5749-L	2-23	E-5897-R	2-21	E-5973	2-60
E-5576-R	2-7	E-5749-R	2-23	E-5898-L	2-21	E-5974	2-58
E-5578-L	2-6	E-5750-L	2-23	E-5898-R	2-21	E-5976	2-60
E-5578-R	2-6	E-5750-R	2-23	E-5899-L	2-23	E-5977-L	2-5
E-5579-L	2-6	E-5753	2-56	E-5899-R	2-23	E-5977-R	2-5
E-5579-R	2-6	E-5755	2-56	E-5900-L	2-28	E-5978-L	2-3
E-5585-L	2-15	E-5756-L	2-36	E-5900-R	2-28	E-5978-R	2-3
E-5585-R	2-15	E-5756-R	2-36	E-5902	2-57	E-5982-L	2-25
E-5587-L	2-40	E-5757-L	2-36	E-5904A	2-58	E-5982-R	2-25
E-5587-R	2-40	E-5757-R	2-36	E-5905A	2-58	E-5983-L	2-29
E-5588-L	2-40	E-5761	2-53	E-5906	2-58	E-5983-R	2-29
E-5588-R	2-40	E-5764-L	2-36	E-5909-L	2-31	E-5985-L	2-25
E-5589-L	2-12	E-5764-R	2-36	E-5909-R	2-31	E-5985-R	2-25
E-5589-R	2-12	E-5765-L	2-36	E-5910-L	2-31	E-5986-L	2-21
E-5618-L	2-41	E-5765-R	2-36	E-5910-R	2-31	E-5986-R	2-21
E-5618-R	2-41	E-5766-L	2-37	E-5911-L	2-30	E-5987-L	2-28
E-5632	2-38	E-5766-R	2-37	E-5911-R	2-30	E-5987-R	2-28
E-5652-L	2-4	E-5775	2-36	E-5916-L	2-20	E-5988-L	2-3
E-5652-R	2-4	E-5776	2-36	E-5916-R	2-20	E-5988-R	2-3
E-5682	2-38	E-5778	2-58	E-5918-L	2-18	E-5989-L	2-16
E-5683	2-38	E-5781	2-57	E-5918-R	2-18	E-5989-R	2-16
E-5702	2-49	E-5783	2-57	E-5920-L	2-18	E-5990-L	2-19
E-5704	2-7	E-5784A	2-54	E-5920-R	2-18	E-5990-R	2-19
E-5706	2-51	E-5785A	2-55	E-5922-L	2-19	E-5991	2-8
E-5708	2-8	E-5796	2-47	E-5922-R	2-19	E-5992A	2-43
E-5710	2-8	E-5798	2-47	E-5923-L	2-20	E-5993	2-43
E-5711	2-9	E-5799	2-47	E-5923-R	2-20	E-5994	2-43
E-5712	2-52	E-5800	2-48	E-5924-L	2-20	E-5995-L	2-5
E-5713-L	2-11	E-5801	2-48	E-5924-R	2-20	E-5995-R	2-5
E-5713-R	2-11	E-5816	2-38	E-5926	2-53	E-5996-L	2-5
E-5714-L	2-11	E-5820	2-57	E-5927	2-53	E-5996-R	2-5
E-5714-R	2-11	E-5821	2-57	E-5929-L	2-17	E-5997	2-44
E-5715-L	2-11	E-5822	2-56	E-5929-R	2-17	E-5998	2-44
E-5715-R	2-11	E-5823	2-56	E-5930-L	2-17	E-5999	2-45
E-5716-L	2-11	E-5824	2-60	E-5930-R	2-17	E-6000A	2-8
E-5716-R	2-11	E-5825	2-60	E-5931-L	2-16	E-6001A	2-43
E-5717-L	2-11	E-5827	2-56	E-5931-R	2-16	E-6023-L	2-15
E-5717-R	2-11	E-5828	2-56	E-5932-L	2-16	E-6023-R	2-15
E-5718-L	2-27	E-5829	2-56	E-5932-R	2-16	E-6024-L	2-16
E-5718-R	2-27	E-5837	2-56	E-5933-L	2-17	E-6024-R	2-16
E-5719-L	2-27	E-5838	2-53	E-5933-R	2-17	E-6026-L	2-39
E-5719-R	2-27	E-5839	2-55	E-5935-L	2-18	E-6026-R	2-39
E-5720-L	2-28	E-5841	2-57	E-5935-R	2-18	E-6027-L	2-40
E-5720-R	2-28	E-5868-L	2-24	E-5936-L	2-19	E-6027-R	2-40
E-5721-L	2-31	E-5868-R	2-24	E-5936-R	2-19	E-6028-L	2-40
E-5721-R	2-31	E-5869-L	2-34	E-5937-L	2-19	E-6028-R	2-40



NUMERICAL PARTS LISTING

Part No	Page	Part No	Page	Part No	Page	Part No	Page
E-6029A	2-43	E-8951-L	2-19	E-9002-L	2-20	E-10224-L	2-25
E-6030A	2-43	E-8951-R	2-19	E-9002-R	2-20	E-10224-R	2-25
E-6033-L	2-22	E-8952-L	2-42	E-9003-L	2-35	E-10225-L	2-25
E-6033-R	2-22	E-8952-R	2-42	E-9003-R	2-35	E-10225-R	2-25
E-6034	2-46	E-8954-L	2-30	E-9004-L	2-20	E-10226-L	2-25
E-6035	2-46	E-8954-R	2-30	E-9004-R	2-20	E-10226-R	2-25
E-6036	2-46	E-8955-L	2-30	E-9005-L	2-20	E-10227-L	2-25
E-6053	2-59	E-8955-R	2-30	E-9005-R	2-20	E-10227-R	2-25
E-6054	2-59	E-8957-L	2-30	E-9006	2-18	E-10228-L	2-25
E-6057-L	2-28	E-8957-R	2-30	E-9007	2-18	E-10228-R	2-25
E-6057-R	2-28	E-8958-L	2-30	E-9008-L	2-35	E-10229	2-25
E-6058-L	2-39	E-8958-R	2-30	E-9008-R	2-35	E-10230	2-25
E-6058-R	2-39	E-8959-L	2-37	E-9009	2-46	E-10234	2-7
E-6059-L	2-40	E-8959-R	2-37	E-9010-L	2-31	E-10235	2-8
E-6059-R	2-40	E-8960	2-46	E-9010-R	2-31	E-10237	2-88
E-6060-L	2-6	E-8961	2-38	E-9011-L	2-30	E-10238	2-88
E-6060-R	2-6	E-8962	2-38	E-9011-R	2-30	E-10242	2-46
E-6138	2-72	E-8963	2-37	E-9012-L	2-4	E-10249-L	2-25
E-6139	2-72	E-8964	2-37	E-9012-R	2-4	E-10249-R	2-25
E-6140	2-81	E-8965	2-37	E-9020	2-8	E-10253-L	2-2
E-6141	2-81	E-8966-L	2-24	E-9021	2-8	E-10253-R	2-2
E-6142	2-78,2-82	E-8966-R	2-24	E-9022-R	2-7	E-10254-L	2-3
E-6144	2-79	E-8968-L	2-26	E-9023	2-57	E-10254-R	2-3
E-6145	2-79	E-8968-R	2-26	E-9024	2-58	E-10256	2-43
E-6146	2-79	E-8969-L	2-26	E-9261	2-50	E-10257	2-43
E-6147	2-79	E-8969-R	2-26	E-9262	2-50	E-10258-L	2-42
E-6148	2-79	E-8972-L	2-22	E-9523-L	2-32	E-10258-R	2-42
E-7647	2-85	E-8972-R	2-22	E-9523-R	2-32	E-10259-L	2-42
E-7648	2-85	E-8976-L	2-19	E-9524-L	2-31	E-10259-R	2-42
E-7649	2-85	E-8976-R	2-19	E-9524-R	2-31	E-10675	2-46
E-7650	2-85	E-8977-L	2-30	E-9525-L	2-31	E-10676	2-46
E-7651	2-86	E-8977-R	2-30	E-9525-R	2-31	E-10828	2-49
E-7652	2-86	E-8978-L	2-30	E-9526	2-46	E-11646	2-47
E-7653	2-86	E-8978-R	2-30	E-9837	1-23,1-24, 1-26,1-28, 1-29,1-31, 2-44	E-11647	2-47
E-7654	2-86	E-8979-L	2-27			E-11648	2-47
E-7655	2-88	E-8979-R	2-27			E-11649	2-47
E-7656	2-88	E-8980	2-46			E-11650	2-47
E-7657	2-85	E-8981	2-46	E-10200-L	2-15	E-11651	2-47
E-7658	2-67	E-8982-L	2-26	E-10200-R	2-15	E-11652	2-47
E-7659	2-66	E-8982-R	2-26	E-10201-L	2-26	E-11654	2-47
E-7660	2-66,2-67	E-8983-L	2-26	E-10201-R	2-26	E-11657	2-49
E-7663	2-66	E-8983-R	2-26	E-10202-L	2-26	E-11658-L	2-30
E-7664	2-66	E-8985-L	2-24	E-10202-R	2-26	E-11658-R	2-30
E-7665	2-66	E-8985-R	2-24	E-10206-L	2-26	E-11659-L	2-35
E-7666	2-66	E-8986	2-47	E-10206-R	2-26	E-11659-R	2-35
E-7775	2-10	E-8987	2-46	E-10208-L	2-27	E-11660-L	2-30
E-7895-L	2-1	E-8988	2-46	E-10208-R	2-27	E-11660-R	2-30
E-7895-R	2-1	E-8990-L	2-24	E-10209-L	2-26	E-11661-L	1-31,2-35
E-7896-L	2-1	E-8990-R	2-24	E-10209-R	2-26	E-11661-R	1-31,2-35
E-7896-R	2-1	E-8992-L	2-29	E-10210-L	2-27	E-11662-L	2-35
E-7897-L	2-2	E-8992-R	2-29	E-10210-R	2-27	E-11662-R	2-35
E-7897-R	2-2	E-8993-L	2-29	E-10213-L	2-39	E-11664-L	2-30
E-7898-L	2-2	E-8993-R	2-29	E-10213-R	2-39	E-11664-R	2-30
E-7898-R	2-2	E-8994-L	2-29	E-10214-L	2-39	E-11665-L	2-35
E-8946-L	2-38	E-8994-R	2-29	E-10214-R	2-39	E-11665-R	2-35
E-8946-R	2-38	E-8995-L	2-22	E-10215	2-45	E-11666-L	2-30
E-8947-L	2-35	E-8995-R	2-22	E-10216	2-45	E-11666-R	2-30
E-8947-R	2-35	E-8996-L	2-21	E-10217	2-45	E-11667-L	2-30
E-8948-L	2-12	E-8996-R	2-21	E-10218	2-45	E-11667-R	2-30
E-8948-R	2-12	E-8997	2-43	E-10219	2-45	E-11668-L	2-30
E-8949-L	2-38	E-9000-L	2-20	E-10220	2-45	E-11668-R	2-30
E-8949-R	2-38	E-9000-R	2-20	E-10221	2-45	E-11669-L	2-32
E-8950-L	2-42	E-9001-L	2-22	E-10222	2-45	E-11669-R	2-32
E-8950-R	2-42	E-9001-R	2-22	E-10223	2-45		

NUMERICAL PARTS LISTING

Part No	Page	Part No	Page	Part No	Page	Part No	Page
E-11672-L	1-26,1-28, 1-31,2-35						
E-11672-R	1-26,1-28, 1-31,2-35						
E-11673-L	2-30						
E-11673-R	2-30						
E-11674-L	2-35						
E-11674-R	2-35						
E-11676-L	2-35						
E-11676-R	2-35						
E-11677-L	2-35						
E-11677-R	2-35						
E-11678-L	2-35						
E-11678-R	2-35						
E-11680-L	2-30						
E-11680-R	2-30						
E-11681-L	2-30						
E-11681-R	2-30						
E-11682-L	2-30						
E-11682-R	2-30						
E-11684-L	2-42						
E-11684-R	2-42						
E-11685-L	2-42						
E-11685-R	2-42						
E-11686-L	2-42						
E-11686-R	2-42						
E-11692	2-43						
E-11693	2-43						
E-11695-L	2-21						
E-11695-R	2-21						
E-11696-L	2-21						
E-11696-R	2-21						
E-11697-L	2-21						
E-11697-R	2-21						
E-11699-L	2-21						
E-11699-R	2-21						
E-11701	2-44						
E-11702	2-44						
E-11703	2-43						
E-11704	2-44						
E-11705	2-44						
E-11706	2-43						
E-11707	2-43						
E-11708	2-44						
E-11709	2-43						
E-11710	2-44						
E-11712	2-43						
E-11713	2-44						
E-11714	1-28,1-31, 2-44						
E-11715	1-23,1-26, 1-28,1-29, 1-31,2-44						
E-11716	1-31,2-44						
E-11717	2-44						
E-11718	2-44						
E-11719	2-45						
E-11722-L	2-11						
E-11722-R	2-11						
E-11723-L	2-11						
E-11723-R	2-11						
E-11724	2-42						
E-11725	2-42						
E-14640	2-46						

EUCLID AFTERMARKET PARTS WARRANTY

We warrant all new parts for one year from date of shipment to the buyer against defective material or workmanship (but not against damage caused by accident, abuse or improper installation, maintenance or repair) when such parts are used on vehicles the specifications of which have been approved by our Engineering Department.

As the exclusive remedy under this warranty, we will, at our option, repair or replace such parts free of charge, or take back the nonconforming parts and refund the monies paid by buyer for such parts, if found on examination by us to be nonconforming and if any necessary return charges are prepaid.

If it is necessary to return any parts under this warranty, buyer agrees not to make any deduction on account thereof from remittances on current accounts while claims are in the process of disposition. Any expense incurred without our consent for repairs or replacement will not be allowed.

THIS WARRANTY IS EXPRESSLY IN LIEU OF ALL OTHER WARRANTIES OR CONDITIONS, EXPRESS, IMPLIED OR STATUTORY, INCLUDING ANY IMPLIED WARRANTY OF MERCHANTABILITY OR FITNESS FOR PARTICULAR PURPOSE. IN NO EVENT SHALL SELLER BE LIABLE FOR INCIDENTAL OR CONSEQUENTIAL DAMAGES OF ANY NATURE.

Only genuine replacement parts are covered by this aftermarket parts warranty.



Meritor Heavy Vehicle Systems, LLC

7975 Dixie Highway
Florence, KY 41042 USA
USA 888-725-9355
Canada 800-387-3889

www.meritor.com
XpresswayPlus.com

Distributed by:

Information contained in this publication was in effect at the time the publication was approved for printing and is subject to change without notice or liability. Meritor reserves the right to revise the information presented or discontinue the production of parts at any time.

Litho in USA
Revised 2-12
100WE
©2012 Meritor, Inc.