



DESIGNER AND MANUFACTURER
OF CARGO RESTRAINT SYSTEMS



EVERYTHING YOU NEED FROM A TO Z TO MOVE ANYTHING FROM A TO B.

WELCOME TO OUR CATALOG.

From anchor points to zinc coated winches and everything in-between, Ancra's world class cargo restraint systems equip you to take to the road with a stable, secure load. Whether your cargo calls for standard or heavy-duty restraint, in this comprehensive catalog you'll find dependable flatbed, interior van solutions, lifting slings, auto transport products, hardware, and utility tie downs to meet all your load securement requirements and ensure your compliance with CSA.

THIS CATALOG IS ORGANIZED TO SAVE YOU TIME AND EFFORT.

There are seven major product sections:

- Flatbed
- Interior Van
- Auto Transport
- Lifting Slings
- Utility Tie Downs
- General Hardware & Webbing
- General Information

Color-coded pages in each section help you find the desired category quickly. All products are presented with photos and complete descriptions, capacities and sizes. **Drawings** and **sidebar how-tos** give you additional details, as well as **web links** and **Quick Response (QR) Codes** that connect you to dynamic online information.

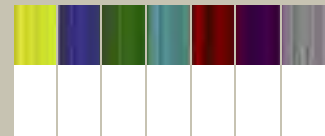

Trucker-Friendly Pages

If you're looking for a specific product, it's easy to find in our Index listings. Whether you're searching by part number or product name, you can find what you're looking for in our Numerical Index starting on page 98, or our Alphabetical Index on page 109.

Product pages offer comprehensive product information and more:

Trucker Tips:

Handy, helpful tips in boxes framed in black and yellow stripes.

Part Numbers:

Listed in boldfaced type followed by technical specifications.

Warnings:

Vital Information regarding product use or hazards on the road highlighted in color boxes.



Did you know?:

Facts and figures, historical industry notes stand out with their blue background.

QR Codes:

Quick Response icons when scanned on your smart phone can connect you to videos, demonstrations and details.

Links:

Take you to website pages for deeper information.

PAYMENT OPTIONS

AUTHORIZED DISTRIBUTORS CAN PAY BY CHECK, MONEY ORDER, OR WIRE OR BANK TRANSFER. YOU CAN OPEN A LINE OF CREDIT BY REQUESTING A CREDIT APPLICATION FROM OUR CUSTOMER SERVICE DEPARTMENT. AFTER THE SHORT APPROVAL PROCESS, YOU WILL BE READY TO PLACE YOUR ORDER.

HOW TO PLACE AN ORDER

ANCRA'S EXPERIENCED CUSTOMER SERVICE DEPARTMENT WILL HELP YOU WITH ALL QUESTIONS AND SPECIAL REQUESTS. YOU CAN CONTACT OUR STAFF TOLL FREE AT 1-800-929-2627. FAX ORDERS TO 1-800-347-2627, OR EMAIL CARGO-SALES@ANCRA.COM. ELECTRONIC ORDERING OPTIONS ARE AVAILABLE AS WELL.

SAFETY IN NUMBERS TIMES 3

Solid parent organization

Ancra International has continuous access to professional services, financial and insurance partners and best practices policies, plus the further advantage of a solid parent organization, the Heico Companies, with annual sales approaching \$3-billion.

Safety factors

It doesn't take a numbers person to appreciate the built-in safety factor of reputable products. At Ancra, we use our own in-house testing facilities as well as independent sources to test and retest our securement products. It's a process that begins with initial design concepts and continues through the final manufacturing.

It doesn't end there. We constantly spot test finished products to make sure they meet quality cargo control standards day after day. We even test and evaluate products that have been in service for signs of corrosion and fatigue. When you see the working load limits permanently marked on Ancra winches, you can be sure those numbers will be met, and more.

In-service record

There's a third way we ensure safety in numbers. Serving the trucking industry for decades we have hundreds of thousands of reliable products working hard everyday. Truckers know what's good.

OUR SAFETY TESTING PROCESS



ABRASION TESTER CONFIRMS THE STRENGTH OF ANCRA STRAPS.

Random webbing samples are abrasion tested per ASTM D6770-097 then load tested for its ability to withstand accelerated wear.



TENSILE TEST EQUIPMENT CHECKS ANCRA WEBBING AND HARDWARE FOR LOAD CAPACITY USING UP TO 50,000 LBS. OF FORCE. If a product doesn't meet the minimum required capacity, the lot is rejected.



TOLERANCES. During the process of first article inspection, Ancra measures crucial tolerances with a granite table and height stand. This assures the product is built to design specs.

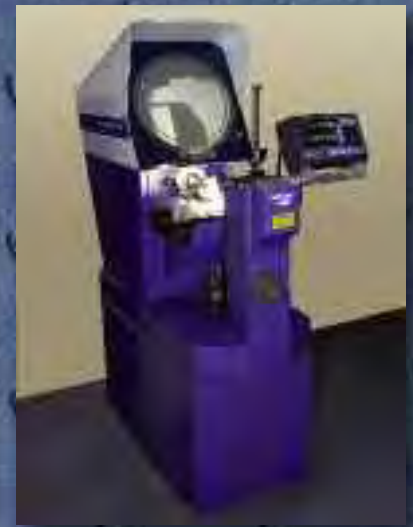

HIGH DEFINITION COMPARATOR verifies dimensions. Ancra products are inspected for accuracy and proper fit with mating parts that will assure trouble-free performance.

TABLE OF CONTENTS

COLOR-CODED PRODUCT SECTION

Flatbed Solutions

Web Winches	.2, 3, 4, 5
Combination Winches	.6
Cable Winches	.6
Lashing Winches	.7
PortaWinch™ & Porta Anchor™	.8
Winch Dimension Chart	.9
Winch Track	.10
SilverCap™ OverDrive™ Ratcheting Cap	.11
Cable & Chain Anchors	.11
Winch Bars	.12
Forged D-Rings	.13
Hooks & Web Winders	.13
Safety Products, Banners, Flags	.14
GlideLock®	.15
Coil Rack	.15
Corner Protectors	.16, 17
Tarp Protector	.16
Web Protector	.16
Rubber Rope & Hooks	.17
Tarp Ties	.18
Transport Chain & Hardware	.19, 20, 21, 22, 23
Chain Load Binder & Accessories	.24, 25
Floor Chain Tie Downs	.25
Winch Strap Assemblies, X-TREME	.26, 27, 28
Winch Strap Assemblies, Standard	.29, 30, 31
Roll On/Off Container Straps	.31
Ratchet Strap Assemblies, X-TREME	.32, 33
Ratchet Strap Assemblies, Standard	.34, 35, 36
Ratchet Strap Replacements	.37, 38

Interior Van Solutions

Lift-A-Deck® II	.40, 41, 42, 43, 44, 45
Poly Board Deck	.46
Retract-A-Roll® II	.47
Logistic Track	.48, 49
Beams, Bars & Hoops	.50, 51
Shoring Bars	.50
Garment Beams	.51
Beam Sockets	.51
Cargo Sta®	.52
Hoop Set for Cargo Sta®	.52
Heavy-Duty Jack Bars	.52
Cargo Bar Holder	.53
Tie Offs	.54
Trailer Fittings	.54
Door Pull Straps	.54
Transmat®	.54
Tension Limiting Ratchet Assemblies	.55
Cam Buckle Strap Assemblies	.56, 57
Plate Trailer Straps	.57
Ratchet Buckle Straps	.58
Custom Nets	.59

Auto Transport Solutions

Car Hauler Straps	.62
Car Tie Downs	.62, 63
Dolly Straps	.63
Transit Straps	.63
Tire Bonnets	.64
Lashing Winches	.64

Lifting Solutions

Round Slings	.66
Eye to Eye Web Slings	.67, 68

Utility Tie Downs

Ratchet Strap Assemblies	.70
Cam Strap Assemblies	.70
Packaged Straps	.71
Trackstar Motorcycle Wheelchock	.71
Pickup Truck Cargo Nets	.72

General Hardware & Webbing

Ratchet Buckles	.74, 75, 76
Overcenter Buckles	.76
Cam Buckles	.77
Roller Buckle	.77
3-Bar Slide Adjuster	.77
Wire Hooks	.78
Flat Hooks	.79
Snap Hooks	.80
Rings	.80
Bolt Plates	.81
Track Fittings	.82, 83
Chain Attachments	.83
Clevis Hooks	.84
RTJ Cluster Hook	.84
Chain Hardware	.85, 86
Webbing	.87
Heavy Duty Aircraft Style Track	.88
Heavy Duty Beveled Aircraft Style Track	.88
Bottle Jacks	.89
Merchandising	.90

General Information

Specifications/Warranty	.92
Industry Standards	.93, 94
Replacement Criteria	.95
Glossary	.96
Trade Association, Resources	.97
Index by Product Number	.98
Index by Product Name	.109

FLATBED SOLUTIONS

Ankra's trusted straps and high performance winches, tie downs, and chain assemblies are engineered to meet the challenges of today's highways. If it wears the Ankra name, it can be trusted.

- Long wearing heavy-duty components in every assembly
- Weather resistant, performance proven products
- Specially engineered construction for maximum durability
- Quick and easy operation
- Products to meet your most demanding applications
- Custom products available to meet your unique needs



FLATBED SOLUTIONS

STRONGEST IN THE INDUSTRY

Ancra winches comply with DOT, WSTDA-T3 and Canadian Standard 905 regulations. Available in different base configurations to suit a variety of needs and load requirements.

All winches shown are right hand models. Left hand models may be available on special orders.

Black powder coat finishes are standard on portable and slider winches. E-coat finishes are standard on weld-on and 3-bar winches.

Smooth ground web slots prevent web wear.

Seamless solid steel mandrel.

Powder coating withstands 250 hours of standard salt spray testing to ensure years of service.

Stamped working load limit and Ancra name certify quality.

High-strength alloy pawl pins.



WEB WINCHES

Bottom Mount



43563-10

Standard
Weight: 9.6 lbs./4.4 kg.
WLL: 5,500 lbs./2,500 kg.



43573-10

Standard Storable
Weight: 8.5 lbs./3.9 kg.
WLL: 5,500 lbs./2,500 kg.



43564-12

Standard Storable Portable w/ 2SS
Weight: 11.1 lbs./5.0 kg.
WLL: 5,500 lbs./2,500 kg.



43564-14

Standard Portable w/ 2SS
Weight: 10.7 lbs./4.85 kg.
WLL: 5,500 lbs./2,500 kg.



43564-16

Low Profile Portable w/ 2SS
Weight: 10.1 lbs./4.58 kg.
WLL: 5,500 lbs./2,500 kg.



43573-11

Standard Storable 2" Spool
Weight: 10.4 lbs./4.7 kg.
WLL: 5,500 lbs./2,500 kg.



43573-12

Standard Storable 3" Spool
Weight: 10.5 lbs./4.77 kg.
WLL: 5,500 lbs./2,500 kg.



43573-13

Standard Storable 4" Spool
Weight: 12.4 lbs./5.6 kg.
WLL: 5,500 lbs./2,500 kg.



48783-10

Standard Double Cap
Weight: 9.0 lbs./4.1 kg.
WLL: 5,500 lbs./2,500 kg.

WEB WINCHES

Side Mount



43579-20

Low Profile
Weight: 7.3 lbs./3.3 kg.
WLL: 5,500 lbs./2,500 kg.



41691-10

Leg Bracket
Weight: 7.1 lbs./3.2 kg.
WLL: 5,500 lbs./2,500 kg.

DID YOU KNOW? About Winches

3-BAR: Designed for easy strap insertion during snow and ice conditions. Prevents the mandrel from freezing up.

PORTABLE: Versatile and meant for temporary installation, and can be placed along the trailer side frame.

SPOOL: Designed to reduce strap wear, spool discs guide and store the webbing into a single roll up to 30°.

STANDARD DOUBLE CAP: Incremental adjustment from both sides of the winch allows for clearance applications.

SLIDERS: Allow for easy positioning in the track, but lock into place when tension is applied to the strap. For use with Ancra track 42357-11, 42357-21, 49242-10-120 or equivalent.

Sliders



43565-127

Storable Bottom Mount
C Track Slider
Lighter 7mm heat treated frame
Weight: 8.3 lbs./3.8 kg.
WLL: 6,000 lbs./2,730 kg.



43565-12-SG

Storable Bottom Mount
Silver Galvanized Finish
C Track Slider
Weight: 11.4 lbs./5.2 kg.
WLL: 6,000 lbs./2,730 kg.



43565-137

Standard Double Cap
C Track Slider
Lighter 7mm heat treated frame
Weight: 8.3 lbs./3.8 kg.
WLL: 6,000 lbs./2,730 kg.



43565-147

Storable w/ Side Washers
C Track Slider
Lighter 7mm heat treated frame
Weight: 8.1 lbs./3.7 kg.
WLL: 6,000 lbs./2,730 kg.



43565-157

Standard Bottom Mount
C Track Slider
Lighter 7mm heat treated frame
Weight: 7.5 lbs./3.4 kg.
WLL: 6,000 lbs./2,730 kg.



43565-15-SG

Standard Bottom Mount
Silver Galvanized Finish
C Track Slider
Weight: 10.3 lbs./4.6 kg.
Weight: 10.0 lbs./4.5 kg.

FLATBED SOLUTIONS

WEB WINCHES

Sliders



49207-127

Storable
Double L Track Slider
Lighter 7mm heat treated frame
Weight: 6.8 lbs./3.09 kg.
WLL: 5,500 lbs./2,500 kg.



49207-127-ZP

Storable
Double L Track Slider
Zinc Plated
Lighter 7mm heat treated frame
Weight: 6.8 lbs./3.09 kg.
WLL: 5,500 lbs./2,500 kg.



49207-137

Standard
Double L Track Slider
Lighter 7mm heat treated frame
Weight: 6.5 lbs./2.95 kg.
WLL: 5,500 lbs./2,500 kg.



49207-137-ZP

Standard
Double L Track Slider
Zinc Plated
Lighter 7mm heat treated frame
Weight: 6.5 lbs./2.95 kg.
WLL: 5,500 lbs./2,500 kg.



49207-187

Low Profile
Double L Track Slider
Lighter 7mm heat treated frame
Weight: 6.2 lbs./2.81 kg.
WLL: 5,500 lbs./2,500 kg.



49246-10-BP

Standard
Utility Trailer Track Slider
Weight: 13 lbs./5.9 kg.
WLL: 5,500 lbs./2,500 kg.

PRODUCT FEATURES

- + USE SLIDER WINCHES WITH ANCRA 49242-10-120, 49789-10-120.00, AND 42357 SERIES TRACK
- + SLIDERS POSITION EASILY IN THE TRACK
- + LOCK IN PLACE WITH STRAP TENSION
- + STRONG HEAT-TREATED 7MM FRAMES FOR LIGHTER WEIGHT, FUEL ECONOMY ON MOST MODELS
- + BLACK POWDER COAT FINISHES ARE STANDARD ON PORTABLE AND SLIDER WINCHES AND E-COAT FINISHES ARE STANDARD ON WELD-ON AND 3-BAR WINCHES.
- + SPECIAL ZINC-PLATED FINISHES AVAILABLE ON SELECT MODELS

LOOSE TIE DOWNS?

Even with enough tie downs in place, if any are loose or defective, you could get a citation.

WEB WINCHES

Sliders



49706-10
Standard
Wilson Track Slider
Weight: 12.5 lbs./5.7 kg.
WLL: 5,500 lbs./2,500 kg.



49706-11
Low Profile
Wilson Track Slider
Weight: 11.5 lbs./5.2 kg.
WLL: 5,500 lbs./2,500 kg.

DID YOU KNOW?
Portable and slider winches are engineered to be placed anywhere along side the trailer as needed to best secure the load.

3-Bar

Weld-on and 3-Bar winches have black E-coat finish. Select models are offered with zinc plating (ZP) or a Silver Galvanized (SG) finish for corrosion resistance.



48101-177
3-Bar Standard
C Track Slider
Lighter 7mm heat treated frame
Weight: 12.8 lbs./6.81 kg.
WLL: 6,000 lbs./2,730 kg.



48101-10
3-Bar Low Profile
Side Mount
Weight: 13.3 lbs./6.0 kg.
WLL: 6,000 lbs./2,730 kg.



48101-10-SG
3-Bar Low Profile
Side Mount
Silver Galvanized Finish
Weight: 13.3 lbs./6.0 kg.
WLL: 6,000 lbs./2,700 kg.



48101-14
3-Bar Standard
Bottom Mount
Weight: 14.6 lbs./6.6 kg.
WLL: 6,000 lbs./2,730 kg.



48101-16-SG
3-Bar Standard Portable
w/ 2 Set Screws
Silver Galvanized Finish
Weight: 16.0 lbs./7.26 kg.
WLL: 6,000 lbs./2,730 kg.



49207-207
3-Bar Standard w/ Side Washers
Double L Track Slider
Lighter 7mm heat treated frame
Weight: 11.9 lbs./5.4 kg.
WLL: 5,500 lbs./2,500 kg.



49207-207-ZP
3-Bar Standard w/ Side Washers
Double L Track Slider
Lighter 7mm heat treated frame
Zinc Plated
Weight: 11.9 lbs./5.4 kg.
WLL: 5,500 lbs./2,500 kg.

FLATBED SOLUTIONS

COMBINATION WINCHES

Ankra winches are made in a variety of configurations to fit any application that requires cable or up to a 4" wide strap.



41681-10

Standard Bottom Mount
Weight: 10.6 lbs./4.8 kg.
WLL: 5,500 lbs./2,500 kg.



43488-20

Low Profile Side Mount
Weight: 10.9 lbs./4.9 kg.
WLL: 5,500 lbs./2,500 kg.



43908-10

Recessed Box
Weight: 12.9 lbs./5.9 kg.
WLL: 5,500 lbs./2,500 kg.



43997-10

Low Profile Leg Bracket
Weight: 8.7 lbs./3.9 kg.
WLL: 5,500 lbs./2,500 kg.



44466-10

2" Web
Weight: 9.4 lbs./4.3 kg.
WLL: 5,500 lbs./2,500 kg.

CABLE WINCH

For cable applications, Ankra offers these popular models. Your cable selection must be consistent with your cable manufacturer's safe working load ratings.



END MOUNT

41696-10

End Mount RH
Weight: 15.4 lbs./7.0 kg.
WLL: 5,500 lbs./2,500 kg.

41696-11

End Mount LH
Weight: 15.4 lbs./7.0 kg.
WLL: 5,500 lbs./2,500 kg.



LASHING WINCHES

The lashing winch with double hex drive can be bolted or welded to the trailer like a standard winch, yet offers the quick release and easy operation of a ratchet buckle.



47640-31

With double hex drive and three mounting holes.
Weight: 3.8 lbs./1.7 kg.
WLL: 3,333 lbs./1,515 kg.

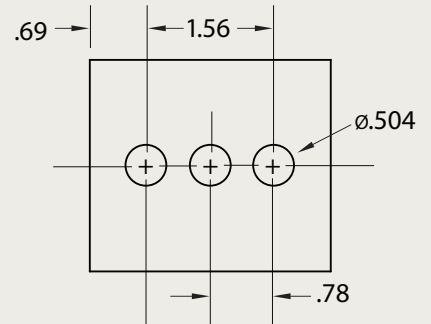

48496-11

With double hex drive, release latch, and single mounting hole.
Weight: 2.2 lbs./1 kg.
WLL: 2,500 lbs./1,135 kg.



WINCH MAINTENANCE

Though winches don't actually come in contact with the load, their function of tightening and anchoring the webbing or cable is critical to the security of over-the-road cargo hauling.

INSPECTION

To insure winches will perform, a quick inspection before each use will assure they are undamaged and working properly. Damaged or non-operational winches should be replaced immediately.

CARE

For optimum performance, winches should be cleaned to remove dirt, mud, road salt, and ice. Lubrication ensures that gravity will allow the winch pawl to drop freely into the sprocket teeth, and the sprocket will rotate freely. When not in use, portable winches should be cleaned and stored in a dry location. With a little care, your winches will go a long way.

FLATBED SOLUTIONS

PORTAWINCH™ AND PORTANCHOR™

PATENTED

Turn stake pockets into strap anchor points.

Ancra has created a way you can turn standard stake pockets into solid anchor points for securement straps. Our DOT and FMCSA compliant 3-Bar PortaWinch and PortaAnchor offer a versatile system that allows you to position the tie down straps anywhere along either side, front or back of the trailer, using stake pockets that best accommodate your load.

- ▶ Fasten straps securely and legally.
- ▶ Working Load Limit (WLL) 5,500 lbs./ 2,495 kg.
- ▶ For use with standard winch straps and tensions with standard winch bar.
- ▶ Fits all standard stake pockets. Will not fit tapered stake pockets.
- ▶ Installs easily without tools.
- ▶ Works over tires and toolboxes.
- ▶ Removable when not in use.



Installs easily with patented spring-loaded front hook design that distributes the load evenly across the stake pocket. Cap has four holes and accommodates standard winch bars.



PortaAnchor accepts straps with flat hooks and straps with chain anchors.

PORTAWINCH™

Patented
No 6,626,621



49716-10

Standard outward off-set.
Weight: 11.5 lbs./5.2 kg. WLL: 5,500 lbs.

49716-11

Inward off-set to allow for track-mounted tarp clearance.
Weight: 11.5 lbs./5.2 kg. WLL: 5,500 lbs.

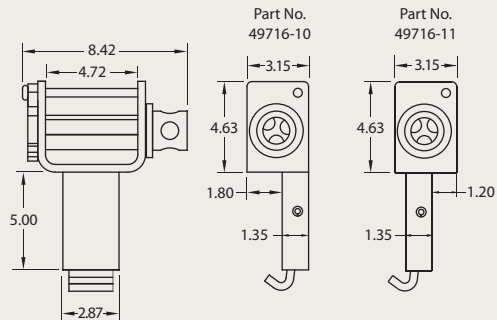

PORTANCHOR™

Patented
No 6,939,095 & 7,090,449



49717-10

Standard outward off-set.
Weight: 9.5 lbs./4.3 kg.
WLL: 5,500 lbs.

49717-11

Inward off-set to allow for track-mounted tarp clearance.
Weight: 9.5 lbs./4.3 kg.
WLL: 5,500 lbs.

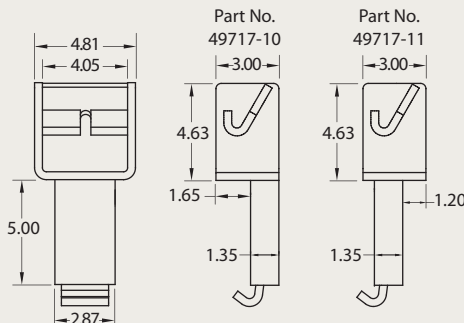

Flat Hook Application



Chain Anchor Application

WINCH DIMENSIONS (inches)

Ancra Part No.	A Overall Width	B Inside Frame Width	C Frame Height	D Frame Depth	Ancra Part No.	A Overall Width	B Inside Frame Width	C Frame Height	D Frame Depth
41681-10	9.75	6.8	5.4	3.5	43908-10	10.3	9.5	5.5	4.0
41691-10	7.6	4.8	5.0	3.9	43997-10	10.3	7.2	5.0	3.9
41696-10	7.1	4.2	10.0	3.9	44466-10	7.6	4.6	5.4	3.5
41696-11	7.1	4.2	10.0	3.9	47640-31	5.9	2.1	4.0	3.0
43488-20	9.4	6.5	4.1	4.0	48101-10	9.9	6.0	4.2	4.0
43563-10	7.6	4.6	5.4	3.5	48101-14	9.9	6.0	5.5	4.0
43564-12	7.6	4.6	6.2	3.5	48101-16-XZ	9.9	6.0	5.5	4.0
43564-14	7.6	4.6	5.3	3.5	48101-177	9.7	6.0	6.2	4.0
43564-16	7.6	4.7	4.1	4.0	48496-11	4.4	2.1	2.5	4.9
43565-127	7.6	4.6	7.5	4.0	48783-10	9.2	4.6	5.4	3.5
43565-127-XZ	7.6	4.6	7.5	4.0	49207-127	7.5	4.6	6.6	4.0
43565-137	9.2	4.6	6.5	4.0	49207-127-XZ	7.5	4.6	6.6	4.0
43565-147	7.6	4.2	7.5	4.0	49207-137	7.5	4.6	6.0	4.0
43565-157	7.6	4.6	6.5	4.0	49207-137-XZ	7.5	4.6	6.0	4.0
43565-157-XZ	7.6	4.6	6.5	4.0	49207-187	7.5	4.6	5.3	4.0
43573-10	7.6	4.6	6.2	3.5	49207-207	9.9	6.0	5.7	4.0
43573-11	7.6	2.2	6.2	3.5	49207-207-XZ	9.9	6.0	5.7	4.0
43573-12	7.6	3.2	6.2	3.5	49246-10-BP	7.6	4.6	6.5	3.5
43573-13	7.6	4.1	6.2	3.5	49706-10	7.9	4.9	6.5	4.0
43579-20	7.4	4.8	4.1	4.0	49706-11	7.9	4.9	5.1	4.0

Winch dimensions are subject to change.

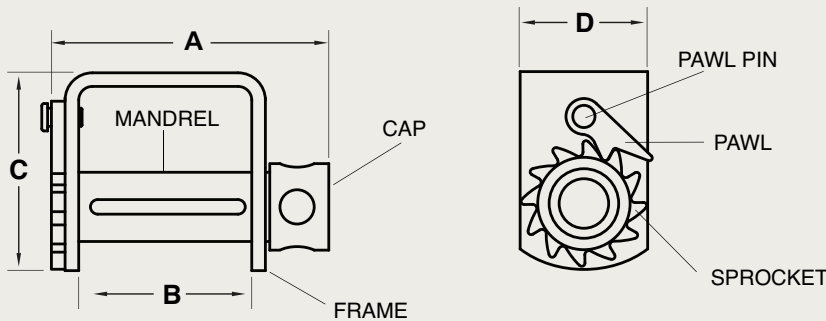

Winches are labeled with installation, maintenance and proper use instructions.

FLATBED SOLUTIONS

WINCH TRACK

Ankra winch track comes in two distinct styles:

- ▶ Standard C track, designed for use with standard slider winches (43565-127 and 43565-157), is available in roll-formed ¼" plate steel (42357-11), or aluminum (42357-21) for aluminum trailers.
- ▶ Double L aluminum track (49242-10-120) is designed for 49207 Double L slider winches.

Custom lengths are available upon request. Winch track should be installed to meet the testing requirements of TTMA RP No. 47-03. For installation instructions, go to our website at <http://link.ankra.com/?L=1>, or just scan the QR Code.



42357-11
Steel C Track
Weight: 39.0 lbs./17.73 kg. Length: 6'

42357-12
Steel C Track
Weight: 78.0 lbs./35.4 kg. Length 12'

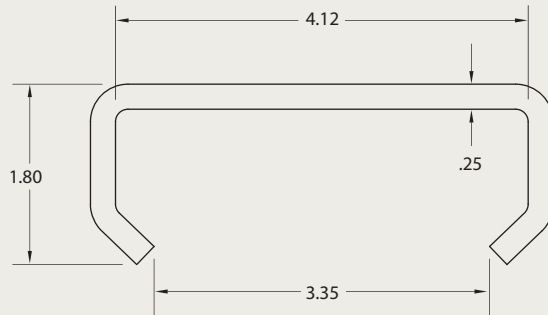

42357-21
Aluminum C Track
Weight: 19.0 lbs./8.64 kg. Length: 6'

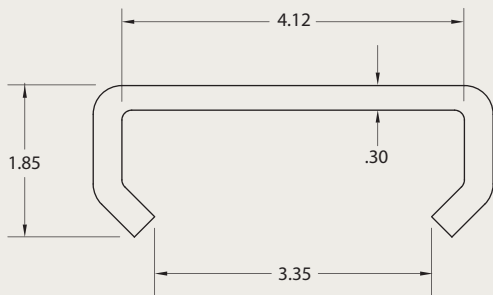

49242-10-120
Aluminum Double L Track
Weight: 26.25 lbs./11.92 kg. Length: 10'

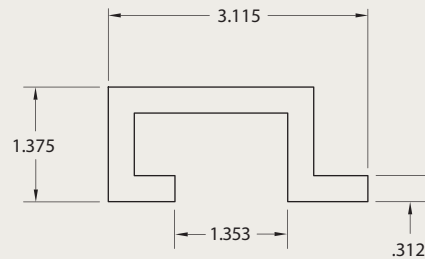

49789-10-120.00
Low Profile Aluminum Double L Track
Weight: 16.83 lbs./7.64 kg. Length: 10'

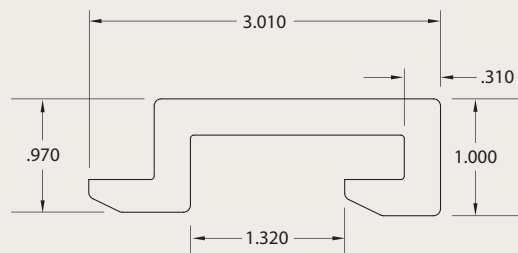

SILVERCAP OVERDRIVE® RATCHETING CAP

PATENTED

Convert any winch into a ratcheting winch by adding Ancra's OverDrive Ratcheting Cap. The lubricated cap with a Grime Guard Weather-Tight Seal fits over the existing winch cap without having to remove the winch from the trailer, making it faster and safer than conventional winches. Your winch bar stays in the winch until your straps are tight. For more information about Ancra's one-year warranty, please call Customer Service at 800-929-2627.



**SilverCap
OverDrive**
Patent Number 7,618,021



49723-10

Weight: 3.45 lbs./1.56 kg.



Ancra's OverDrive® is the easy upgrade for winches. With a ratcheting winch, you work faster and safer because the winch bar stays in the winch until the strap is tight.

To install on any existing winch:

1. Simply slide the OverDrive unit over the cap of the old winch.
2. Spin it in place.
3. Secure it with the bolt.

It's that simple. All necessary parts are included.



FLATBED ACCESSORIES

Cable Assemblies with Chain Anchor



Ancra's heavy-duty cable assemblies with zinc-plated gold chromate chain anchor can be used on cable, combination winches, or web winches with side washers to prevent binding. Constructed of galvanized aircraft cable with grade 70 NACM-compliant chain anchor. The cable assemblies are available in 7/32", 1/4" and 5/16" diameter cable in 30' and 32' lengths. The chain anchors are 19" in length.

49828-12-30

7/32" x 30' Weight: 4.9 lbs./2.2 kg. WLL: 1,867 lbs./848 kg.

49828-12-32

7/32" x 32' Weight: 5.1 lbs./2.3 kg. WLL: 1,867 lbs./848 kg.

49828-10-30

1/4" x 30' Weight: 5.4 lbs./2.45 kg. WLL: 2,300 lbs./1,050 kg.

49828-10-32

1/4" x 32' Weight: 5.8 lbs./2.6 kg. WLL: 2,300 lbs./1,050 kg.

49828-11-30

5/16" x 30' Weight: 7.9 lbs./3.6 kg. WLL: 3,300 lbs./1,500 kg.

49828-11-32

5/16" x 32' Weight: 8.4 lbs./3.8 kg. WLL: 3,300 lbs./1,500 kg.

FLATBED SOLUTIONS

FLATBED ACCESSORIES

ERGO 360° Winch Bars

PATENTED

No. 7,740,232

FIRST ANGRA RAISED THE BAR. THEN WE BENT IT.

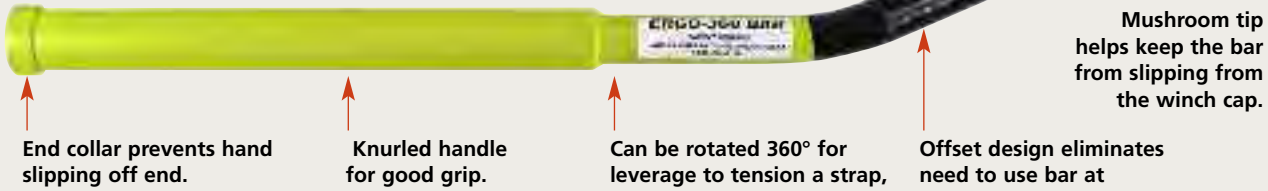

End collar prevents hand slipping off end.

Knurled handle for good grip.

Can be rotated 360° for leverage to tension a strap, accommodating various clearance requirements.

Offset design eliminates need to use bar at extreme upward or downward angles.

Mushroom tip helps keep the bar from slipping from the winch cap.



See what a difference a bend in the bar makes.

The Ergo 360° Bar takes Ancra's winch bars to the next level. The patented ergonomic design maintains parallel alignment of handle and tip, so you can rotate the bar for optimum leverage without removing it, and keep it secured in the winch cap through the mushroom tip. Easy to carry, easy to handle, the Ergo 360° Bar is the most efficient and economical new tool you'll use. Available in standard, combination and combination box end models. Combination winch bars can be used to release tension on chain binders. Use caution to avoid injury. Not to be used as a cheater bar.

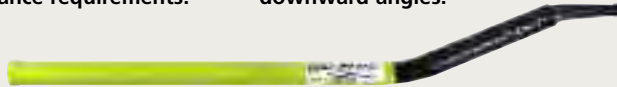

50015-10

Standard Painted. Weight: 5.0 lbs./2.27 kg.

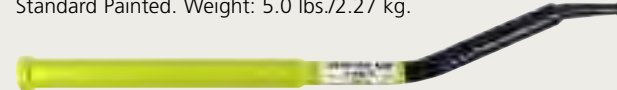

50015-20

Combination Painted. Weight: 6.5 lbs./2.95 kg.

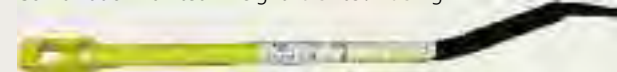

50015-21

Combination Box End Painted. Weight: 6.0 lbs./2.72 kg.



Learn how this uniquely designed winch bar prevents injuries. Scan this QR Code to watch the video or go to our website at <http://link.ancra.com/?L=2>

Standard Winch Bars

Tapered and angled at the end for easy operation, Ancra's winch bar handles are knurled at two sections, and the mushroom tip helps keep the bar from slipping from the winch cap. They are heat-treated for extra strength and cycle tested to simulate years of heavy use. Combination winch bars can be used to release tension on chain binders. Use caution to avoid injury. Not to be used as a cheater bar.

Flanged mushroom tip helps keep the bar from slipping from the winch cap.



42313-10

Standard Painted. Weight: 5.0 lbs./2.27 kg.



42313-17

Standard Chrome. Weight: 5.0 lbs./2.27 kg.



42313-19

Combination Chrome. Weight: 6.5 lbs./2.95 kg.



42313-12

Combination Box End Painted Silver and Yellow. Weight: 6.5 lbs./2.95 kg.

FLATBED ACCESSORIES

Heavy Duty D-Rings



Rugged forged steel D-Rings add versatility for securing complex loads. Utility trailers typically use 1/2 and 5/8 inch models, while heavy-duty applications rely on the 3/4 and 1-inch sizes. Individually polybagged.

49896-10

1/2-inch forged steel w/
Bolt-on clip
Weight: 1.0 lbs./ .50 kg.
WLL: 4,000 lbs.

49896-11

1/2-inch forged steel w/
Weld-on clip
Weight: 1.0 lbs./ .50 kg.
WLL: 4,000 lbs.

49897-10

5/8-inch forged steel w/
Weld-on clip
Weight: 1.9 lbs./ .86 kg.
WLL: 6,300 lbs.

49898-10

3/4-inch forged steel w/
Weld-on clip
Weight: 2.2 lbs./1.0 kg.
WLL: 9,000 lbs.

49899-10

1-inch forged steel w/
Weld-on clip
Weight: 4.4 lbs./2.0 kg.
WLL: 15,600 lbs.

Hooks & Web Winders

44102-11

H-2 Hook. Flame-cut from 5/8-in. material and can be welded on vehicles. Accepts web loops, D-Rings, cable or rope. Meets anchorage requirements when properly secured. Hook opening .81" Weight: .61 lb./ .28 kg. WLL: 5,400 lbs./2,450 kg.

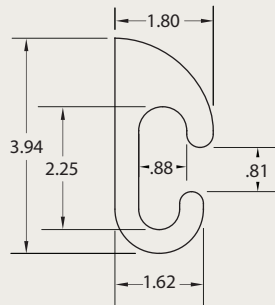

44122-10

Corner Iron Hook
Constructed with no sharp corners to reduce abrasion to rope or cable.
Weight: .63 lb./ .29 kg.



50024-10

Tarp Hook. For securing tarp straps to trailers.
1/2-in. steel wire.
Unfinished light oil.
Weight: .39 lb./ .18 kg.

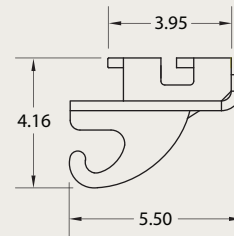

49768-10

Double L Track Slider Hook
Black powder coat finish.
Hook opening .71"
Weight: 5.65 lb./2.57 kg.
WLL: 5,500 lbs./2,500 kg.



50092-10

EZ Winder Strap Winder quickly and easily winds webbing onto your winch for storage.



45801-10

Web Winder. Constructed of all steel, the Ankra Web Winder winds 2-in., 3-in. and 4-in. winch straps for compact storage. Easy to attach to vehicle rails, easy to remove with tapered forks, and easy to disassemble for storage. Weight: 3.25 lbs./1.48 kg.

PRODUCT FEATURES

- + ROLLS ALL YOUR WINCH STRAPS NEATLY AND QUICKLY.
- + HELPS TO EXTEND THE LIFE OF YOUR WINCH STRAPS.

FLATBED SOLUTIONS

FLATBED ACCESSORIES

Safety Related Products

Meet FMCSA 393.87 standards.



49893-10

Fluorescent Red Heavy-Duty Mesh Flag w/ wooden dowel. 18" x 18"



49893-11

Red Cotton Flag w/ steel wire rod. 18" x 18"



49893-12

Fluorescent Red Mesh Flag w/ 2 brass grommets. 18" x 18"



49893-13

Fluorescent Orange Mesh Flag w/ wooden dowel. 18" x 18"

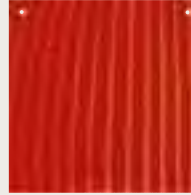

49893-14

Fluorescent Orange Mesh Flag w/ 2 brass grommets. 18" x 18"



49894-10

Double-sided banner reads WIDE LOAD and OVERSIZED LOAD. Made of durable vinyl fabric and comes with four grommets and four 44" attachment ropes. 84" x 18" Tri-lingual package.



49894-11

Double-sided banner reads WIDE LOAD and OVERSIZED LOAD. Made of durable vinyl fabric and comes with sewn-in ropes top and bottom, plus four grommets. 84" x 18" Tri-lingual package.



49894-12

Double-sided banner reads WIDE LOAD and OVERSIZED LOAD. Made of durable vinyl fabric and comes with four grommets and four 44" attachment ropes. 72" x 14" Tri-lingual package.



49894-13

Mesh OVERSIZED LOAD banner. Made of woven polyester mesh with 4 grommets and four 44" attachment ropes. 84" x 18" Tri-lingual package.



49894-14

Mesh WIDE LOAD banner. Made of woven polyester mesh with 4 grommets and four 44" attachment ropes. 84" x 18" Tri-lingual package.



49895-10

Canadian D sign is made of durable vinyl fabric. Comes with 10 grommet attachment points. 96" x 12"

FLATBED ACCESSORIES

GlideLock® Sliding Load-Securement Bracket

GLIDELOCK®
Sliding Load-Securement Bracket

Lock and load with GlideLock® movable securement bracket

GlideLock Sliding Load-Securement Bracket offers versatility and positioning of tie down anchor point.

1. GlideLock positions exactly where it's needed, no matter what type of load or the location of cargo on the vehicle.
2. Once the flat hook is engaged, the unit locks the hook in position. It cannot shift or come undone, it remains secure until you unlock it.

With a Working Load Limit of 5,400 lbs., GlideLock glides into any position along the trailer rail or winch track to ensure the correct pull-angle for securing cargo. The compact unit keeps the strap inboard of the rub rail and works with any standard flat-hook strap.



49527-10

GlideLock for Double L Track
WLL: 5,400 lbs./2,450 kg.
Weight 4.50 lbs./2.04 kg



How GlideLock Works

1. Slide the unit onto the Double L Track.
2. Glide to correct position to ensure a correct pull-angle.
3. Release the keeper to allow the flat hook to engage GlideLock.
4. Secure the keeper to lock the flat hook into position. Once in place, the hook can't shift or come undone. Ideal for trailers with double L winch track and slider winches. Meets Federal Motor Safety Administration (FMCSA) standards.

Watch the **GlideLock** video. Scan this QR Code to view a movie or go to our website at <http://link.ancra.com/?L=3>



Coil Racks

Our coil racks are designed to aid in supporting steel coils on flatbed trailers. Available for both light and heavy duty applications. Used with lumber blocks which provide extra cradling of the coils. Both have a black lacquer finish. New D.O.T. standards specifically address securement of metal coils. If chocks are used, they must be held in place by coil bunks or racks to prevent them from coming loose.

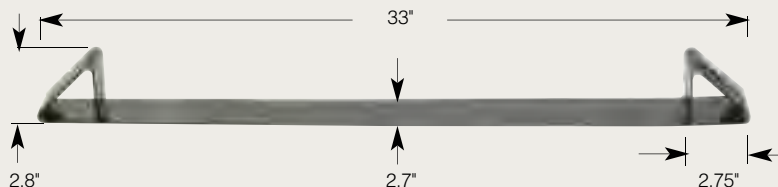

49344-10

Light Duty
Metal Gauge: 10
Weight: 5.7 lbs./2.60 kg.

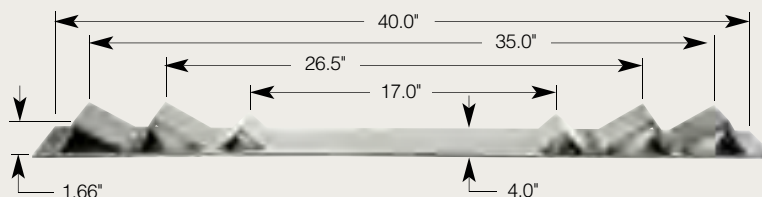

49344-12

Heavy-Duty 1/4" steel sheet per
ASTM A36
Weight: 15.63 lbs./7.09 kg.

FLATBED SOLUTIONS

FLATBED ACCESSORIES

Corner Protectors

Along with our standard rugged flatbed products, Ancra web accessories offer high performance and durability. Sturdy corner and web protectors prevent abrasion of cargo and cargo-securing straps.



43986-10

High Density Polymer
Suitable for webbing up to 4".
5.25" wide and extends
approx. 3.5" to protect the
load. Weight: .06 lb./03 kg.



49377-10

Steel (Zinc Plated)
For use with chain and extends
4" to protect the load.
Weight: 1.10 lbs./50 kg.



49377-11

Rubber coated Steel
For use with chain and extends
4" to protect load.
Weight: 1.9 lbs./86 kg.



49577-10

Steel (Galvanized)
For use with chain. 4" wide
and extends 3" on top and
3.5" to protect the load.
Weight: .90 lb./41 kg.



49756-10

Steel Corner Protector for chain and up to
4" winch straps and extends 3-5/8" to
protect the load. Weight: 1.26 lbs./57 kg.



41516-11

Aluminum 6061-T6
Suitable for 2" webbing.
Weight: .63 lbs./29 kg.



49584-10

12" Long Plastic. Extends approx. 3" to
protect the load. Suitable for webbing up to
4" in width. Weight: .47 lb./21 kg.



42098-11

Fiber Reinforced Rubber. Extends approx
5" to protect the load for webbing up to
3" in width. Weight: .63 lb./29 kg.

42098-12

Extends approx 5" to protect the load for webbing up to 4" in width.
Weight: .75 lb./34 kg.



49913-10

Tarp Protector. Yellow plastic.
Weight: .21 lb./09 kg.

Web Protector



40985-05-12

12-in. Cordura® Nylon sleeve for 2-in.
webbing. Weight: .13 lb./06 kg.

40985-05-RL

100-yd. bulk roll Cordura Nylon sleeve
for 2-in. webbing. Weight: .39 lb./yd./
.18 kg./meter. Cordura® is a registered
trademark of Dupont.



FLATBED ACCESSORIES

X-TREME GUARD™ PROTECTS YOUR LOAD AND YOUR STRAPS



Ankra's new high-density polyethylene X-TREME GUARD™ Corner Protector distributes strap tension over the length of the guard to prevent your cargo from being crushed by the straps and protects your webbing from abrasion. Made in lengths of 12-, 24-, 36- and 48-inches, this durable guard is strong yet lightweight, and crack/weather resistant to -30°.

Made in the USA



50089-12	8" x 1' long — Weight: .8 lbs./,36 kg.
50089-24	8" x 2' long — Weight: 1.7 lbs./,78 kg.
50089-36	8" x 3' long — Weight: 2.7 lbs./,1.23 kg.
50089-48	8" x 4' long — Weight: 3.6 lbs./,1.63 kg.

Rubber Rope & Hooks



- Standard 150-ft. coils
- Easily assembled to desired length for application.

49454-11
3/8" Solid Core Rubber Rope
Weight: 10.7 lbs./4.86 kg.

49454-13
7/16" Solid Core Rubber Rope
Weight: 7.4 lbs./3.35 kg.



49211-10
Rubber Rope Hook
100 per pack
Weight: 5.2 lbs./2.37 kg.

HOW TO ATTACH HOOK TO RUBBER ROPE

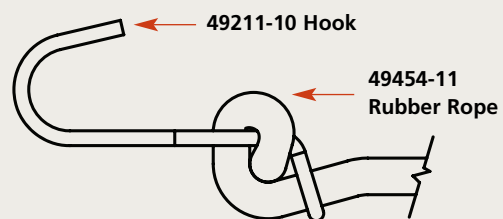
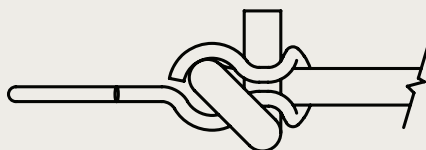

FLATBED SOLUTIONS

FLATBED ACCESSORIES

Top Premium Brand Tarp Ties



In the heavy duty trucking industry, Goldline® and Silverline® Tarp Ties have been a favorite with fleets and independent owners for 40 years.

Made in the USA and known for quality, durability, and resistance to weather, these tarp ties offer good stretch recovery and maintain their strength over the entire life of the tarp ties. The three lines include the longest lasting, larger cross section Goldline EPDM tarp ties best recognized by truckers, and the smaller cross section Silverline Elite™ EPDM, and Silverline natural rubber

tarp ties. They all offer exceptional strength and costs that compete with import tarp ties. All hooks are made in the USA from wire coils.



- Quantity 50 per box
- Designed to hold tarp covers on trucks and trailers
- Not to be used to restrain or secure cargo
- Molded EPDM construction for high Ozone resistance and strength resiliency or molded natural rubber for good cold weather stretch properties
- Wear safety glasses and use caution when using tarp ties
- WARNING: SUDDEN RUPTURE OR DISCONNECT WHILE IN STRETCHED POSITION CAN CAUSE SERIOUS INJURY

Made in the USA 

GOLDLINE®

52210GL

Goldline HD EPDM made in the USA-10"

52215GL

Goldline HD EPDM made in the USA-15"

52221GL

Goldline HD EPDM made in the USA-21"

52231GL

Goldline HD EPDM made in the USA-31"

52241GL

Goldline HD EPDM made in the USA-41"

SILVERLINE®

ELITE
EPDM

52210SE

Silverline Elite EPDM made in the USA-10"

52215SE

Silverline Elite EPDM made in the USA-15"

52221SE

Silverline Elite EPDM made in the USA-21"

52231SE

Silverline Elite EPDM made in the USA-31"

52241SE

Silverline Elite EPDM made in the USA-41"

SILVERLINE®

52210

Silverline Natural Rubber made in the USA-10"

52215

Silverline Natural Rubber made in the USA-15"

52221

Silverline Natural Rubber made in the USA-21"

52231

Silverline Natural Rubber made in the USA-31"

52241

Silverline Natural Rubber made in the USA-41"

GRADE 70 'TRANSPORT' CHAIN

Grade 70 chain was designed specifically to provide a light, yet strong chain for tie downs. Made from carbon steel and zinc plated gold chromate for corrosion resistance. Heat treated and 100% proof tested to 2X WLL rating. Made to NACM standards per specifications of the Department of Transportation & CCMTA for tie down use. All clevis hooks are made of heat treated alloy steel.



BROWN BARREL
1/4-in. Chain



ORANGE BARREL
5/16-in. Chain



GREEN BARREL
3/8-in. Chain



RED BARREL
1/2-in. Chain

Grade 70 Chain Assemblies with Clevis Hooks



- 45881-10-16** 5/16-in. x 16-ft. WLL: 4,700 lbs./2,133 kg. Weight: 17.4 lbs./7.89 kg.
10 Assemblies per Orange Barrel
- 45881-10-20** 5/16-in. x 20-ft. WLL: 4,700 lbs./2,133 kg. Weight: 21.7 lbs./9.90 kg.
10 Assemblies per Orange Barrel
- 45881-10-25** 5/16-in. x 25-ft. WLL: 4,700 lbs./2,133 kg. Weight: 26.7 lbs./12.10 kg.
10 Assemblies per Orange Barrel
- 45881-11-16** 3/8-in x 16-ft. WLL: 6,600 lbs./2,996 kg. Weight: 24.4 lbs./11.08 kg.
10 Assemblies per Green Barrel
- 45881-11-20** 3/8-in. x 20-ft. WLL: 6,600 lbs./2,996 kg. Weight: 30.4 lbs./13.80 kg.
10 assemblies per Green Barrel
- 45881-11-25** 3/8-in. x 25-ft. WLL: 6,600 lbs./2,996 kg.. Weight: 39.0 lbs./17.71 kg.
10 Assemblies per Green Barrel
- 45881-13-20** 1/2-in x 20-ft. WLL: 11,300 lbs./5,130 kg. Weight: 53.6 lbs./24.33 kg.
5 Assemblies per Red Barrel
- 45881-13-25** 1/2-in. x 25-ft. WLL: 11,300 lbs./5,130 kg. Weight: 66.2 lbs./30.05 kg.
5 Assemblies per Red Barrel

Grade 70 Bulk Chain



- 45880-12** 1/4-in. x 400-ft. WLL: 3,150 lbs./1,430 kg. Weight: 262 lbs./118.9 kg.
Brown Barrel
- 45880-10** 5/16-in x 400-ft. WLL: 4,700 lbs./2,133 kg. Weight: 408 lbs./185 kg.
Orange Barrel
- 45880-11** 3/8-in. x 200-ft. WLL: 6,600 lbs./2,996 kg. Weight: 296 lbs./134.4 kg.
Green Barrel
- 45880-13** 1/2-in x 100-ft. WLL: 11,300 lbs./5,130 kg. Weight: 251 lbs./114 kg.
Red Barrel

FLATBED SOLUTIONS

GRADE 70 'TRANSPORT' CHAIN

Packaged Transport Chain In A Pail

Packaged Grade 70 transport chain assemblies are offered in a convenient storage pail to keep organized in your tool box or vehicle. Grade 70 chain is specifically designed to provide a light, yet strong chain for tie downs. Made from carbon steel, heat treated for strength and zinc plated gold chromate for corrosion resistance. Made to NACM standards to meet the specifications of the DOT & CCMTA for tie down use. All clevis hooks are made of heat-treated alloy steel.



- 45881-10-16-SP** 5/16-in x 16-ft. WLL: 4,700 lbs./2,133 kg. Weight: 18.8 lbs./8.52 kg.
- 45881-10-20-SP** 5/16-in x 20-ft. WLL: 4,700 lbs./2,133 kg. Weight: 23.4 lbs./10.61 kg.
- 45881-10-25-SP** 5/16-in x 25-ft. WLL: 4,700 lbs./2,133 kg. Weight: 28.3 lbs./12.83 kg.
- 45881-11-16-SP** 3/8-in x 16-ft. WLL: 6,600 lbs./2,996 kg. Weight: 25.8 lbs./11.71 kg.
- 45881-11-20-SP** 3/8-in x 20-ft. WLL: 6,600 lbs./2,996 kg. Weight: 31.9 lbs./14.48 kg.
- 45881-11-25-SP** 3/8-in x 25-ft. WLL: 6,600 lbs./2,996 kg. Weight: 40.5 lbs./18.39 kg.

Grade 70 Agricultural Safety Chain

For use as a safety chain to prevent the separation of the towed vehicle and the towing vehicle in the event the primary attachment becomes disengaged. The safety chain allows for the two vehicles to come to a controlled stop. Conforms to the specifications of the ASABE as a Safety Chain for towed field equipment for agriculture. Has a zinc plated gold chromate finish and complies with NACM Standards for grade 70 transport chain.



- 50090-31** 5/16-in x 67.5-in. WLL: 4,700 lbs./2,133 kg. For towed machines not exceeding 16,100 lbs./7,309 kg. gross weight. Weight: 6.8 lbs./3.08 kg. 20 per Black Barrel, Weight in barrel: 148 lbs./67.19 kg.
- 50090-38** 3/8-in x 69-in. WLL: 6,600 lbs./2,996 kg. For towed machines not exceeding 20,200 lbs./9,170 kg. gross weight. Weight: 11.6 lbs./5.26 kg. 10 per Black Barrel, Weight in barrel: 120 lbs./54.48 kg.
- 50090-50** 1/2-in x 70-in. WLL: 11,300 lbs./5,130 kg. For towed machines not exceeding 40,500 lbs./18,387 kg. gross weight. Weight: 18.6 lbs./8.44 kg. 10 per Black Barrel, Weight in barrel: 195 lbs./88.53 kg.

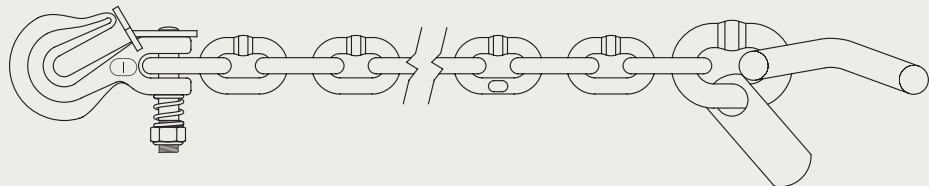

GRADE 70 CLEVIS HOOKS

Forged from high strength alloy steel, Ancra clevis hooks are made for Grade 70 chain. Sized from 1/4" to 1/2", the chain hooks are strength tested and heat treated for strength and durability. Meets Department of Transportation requirements.

Forged steel hook, zinc plated gold chromate finish. Individually polybagged.

- 45946-12** 1/4-in. Clevis Hook WLL: 3,150 lbs./1,430 kg. Weight: .40 lbs./.18 kg.
- 45946-10** 5/16-in. Clevis Hook WLL: 4,700 lbs./2,133 kg. Weight: .85 lbs./.39 kg.
- 45946-11** 3/8-in. Clevis Hook WLL: 6,600 lbs./2,996 kg. Weight: 1.10 lbs./.5 kg.
- 45946-13** 1/2-in. Clevis Hook WLL: 11,300 lbs./5,130 kg. Weight: 2.10 lbs./1.04 kg.

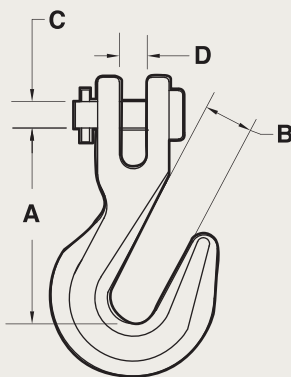

DIMENSION TABLE				
	A	B	C	D
45946-12	2.00	.40	.38	.36
45946-10	2.30	.43	.38	.38
45946-11	2.70	.50	.48	.44
45946-13	3.20	.66	.63	.75

Grade 70 Clevis Hooks with Keeper

Forged steel hook with Keeper, zinc plated gold chromate. Individually polybagged, 30 per box.

- 50091-31** 5/16-in. Clevis Hook w/ Keeper WLL: 4,700 lbs./2,133 kg. Weight: .9 lbs./.41 kg.
- 50091-38** 3/8-in. Clevis Hook w/ Keeper WLL: 6,600 lbs./2,996 kg. Weight: 1.3 lbs./.59 kg.
- 50091-50** 1/2-in. Clevis Hook w/ Keeper WLL: 11,300 lbs./5,130 kg. Weight: 2.2 lbs./1.00

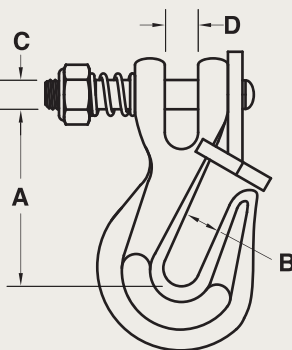

DIMENSION TABLE				
	A	B	C	D
50091-31	2.3	.43	.38	.42
50091-38	2.7	.56	.48	.48
50091-50	3.0	.61	.63	.57

WARNING: Never exceed the Working Load Limit. Not to be used for overhead lifting.

FLATBED SOLUTIONS

CHAIN HARDWARE

We offer a wide selection of chain hardware for popular applications — from zinc plated clear chromate anchor shackles in screw pins and clevis pin models to Quick Links in various sizes. Corrosion resistant, zinc plated gold chromate Grade 70 Twin Clevis and Slip Hooks come in a wide range of sizes, with and without safety latches.

Screw Pin Anchor Shackle — Galvanized and individually polybagged

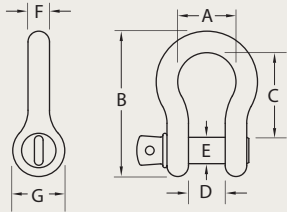

PART NUMBER	SIZE	WEIGHT	WLL				
50013-31	5/16-in.	.18 lbs./08 kg.	1,500 lbs./681 kg.				
50013-38	3/8-in.	.30 lbs./14 kg.	2,000 lbs./900 kg.				
50013-44	7/16-in.	.49 lbs./22 kg.	3,000 lbs./1,362 kg.				
50013-50	1/2-in.	.74 lbs./34 kg.	4,000 lbs./1,816 kg.				
50013-63	5/8-in.	1.44 lbs./65 kg.	6,500 lbs./2,951 kg.				
50013-75	3/4-in.	2.16 lbs./98 kg.	9,500 lbs./4,313 kg.				
	A	B	C	D	E	F	G
50013-31	.81	2.25	1.25	.53	Ø3/8	Ø.31	1.00
50013-38	.94	2.61	1.44	.66	Ø7/16	Ø.38	1.13
50013-44	1.06	3.01	1.69	.72	Ø1/2	Ø.44	1.25
50013-50	1.19	3.34	1.88	.81	Ø5/8	Ø.50	1.38
50013-63	1.50	4.04	2.41	1.06	Ø3/4	Ø.63	1.88
50013-75	1.75	5.04	2.84	1.25	Ø7/8	Ø.75	2.13

Clevis Pin Anchor Shackle — Galvanized and individually polybagged

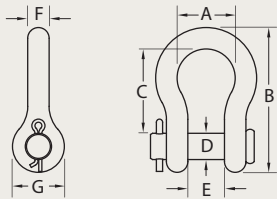

PART NUMBER	SIZE	WEIGHT	WLL				
50014-50	1/2-in.	.74 lbs./34 kg.	4,000 lbs./1,816 kg.				
50014-63	5/8-in.	1.44 lbs./65 kg.	6,500 lbs./2,951 kg.				
	A	B	C	D	E	F	G
50014-50	1.19	3.39	1.88	Ø5/8	.81	Ø.50	1.38
50014-63	1.50	4.17	2.41	Ø3/4	1.06	Ø.63	1.88

Quick Links — Zinc plated clear chromate and individually polybagged

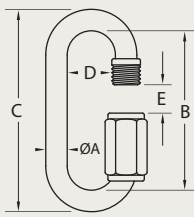

PART NUMBER	SIZE	WEIGHT	WLL		
50016-25	1/4-in.	.062 lbs./028 kg.	880 lbs./399 kg.		
50016-31	5/16-in.	.154 lbs./07 kg.	1,760 lbs./799 kg.		
50016-38	3/8-in.	.198 lbs./90kg.	2,200 lbs./998 kg.		
	A	B	C	D	E
50016-25	.235	1.85	2.31	.51	.32
50016-31	.313	2.32	2.95	.65	.41
50016-38	.350	2.54	3.22	.67	.43

CHAIN HARDWARE

Twin Clevis G70

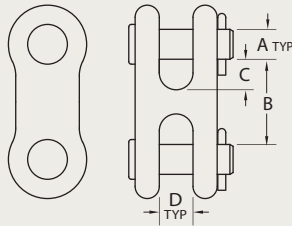

Forged steel with zinc plated gold chromate and individually polybagged

PART NUMBER	SIZE	WEIGHT	WLL	
50017-10	1/4-in. – 5/16-in.	.30 lbs./14 kg.	4,700 lbs./2,133 kg.	
50017-11	3/8-in.	.40 lbs./18 kg.	6,600 lbs./2,996 kg.	
50017-12	7/16-in – 1/2-in.	.98 lbs./44 kg.	11,300 lbs./5,130 kg.	
	A	B	C	D
50017-10	.38	1.18	.43	.47
50017-11	.47	1.34	.48	.53
50017-12	.56	1.75	.63	.65

Slip Hooks G70 without Safety Latch

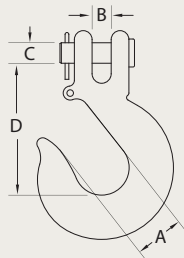

Forged steel with zinc plated gold chromate and individually polybagged

PART NUMBER	SIZE	WEIGHT	WLL	
50019-10	1/4-in.	.44 lbs./20 kg.	3,150 lbs./1,430 kg.	
50019-11	5/16-in.	.75 lbs./34 kg.	4,700 lbs./2,133 kg.	
50019-12	3/8-in.	1.13 lbs./51 kg.	6,600 lbs./2,996 kg.	
50019-13	1/2-in.	2.75 lbs./1.25 kg.	11,300 lbs./5,130 kg.	
	A	B	C	D
50019-10	.94	.44	.38	2.44
50019-11	1.06	.41	.44	2.72
50019-12	1.31	.59	.47	3.25
50019-13	1.75	.75	.63	4.00

Slip Hooks G70 with Safety Latch

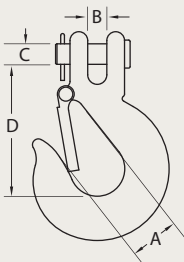

Forged steel with zinc plated gold chromate and individually polybagged

PART NUMBER	SIZE	WEIGHT	WLL	
50019-20	1/4-in.	.59 lbs./27 kg.	3,150 lbs./1,430 kg.	
50019-21	5/16-in.	.92 lbs./42 kg.	4,700 lbs./2,133 kg.	
50019-22	3/8-in.	1.32 lbs./60 kg.	6,600 lbs./2,996 kg.	
50019-23	1/2-in.	2.90 lbs./1.32 kg.	11,300 lbs./5,130 kg.	
	A	B	C	D
50019-20	.94	.44	.38	2.44
50019-21	1.06	.41	.44	2.72
50019-22	1.31	.59	.47	3.25
50019-23	1.75	.75	.63	4.00

FLATBED SOLUTIONS

EZ BINDER



- ▶ Quick acting ratchet design is easy to tension and release
- ▶ Extra long handle provides mechanical advantage needed for secure tensioning
- ▶ Durable contoured handle grip for comfortable operation
- ▶ Heavy gauge steel construction with corrosion resistant electro zinc plating
- ▶ Dual solid gears distribute tensioning forces evenly
- ▶ Free wheel function for quick take up
- ▶ Quality grade 100 load chain is used in binder
- ▶ Use with 5/16" grade 70 or 3/8" grade 43 binder chains
- ▶ Swiveling grab hooks for ease of use
- ▶ Will take up 12" of chain during tensioning



See how easy it is to use chain to secure heavy loads. Scan this QR Code for a demonstration video or go to our website at <http://link.ancra.com/?L=5>



50140-10

EZ Binder
WLL: 5,400 lbs./2,450 kg.
Weight: 11.5 lbs./5.22 kg.

CHAIN LOAD BINDERS

All traditional chain load binders are constructed of drop forged steel for strength and durability and are Grade 70 for use with transport chain. They are available in traditional Lever, Recoilless and Ratcheting models, and are finished in a red E-coat paint. They meet or exceed WSTDA T-6 standards.

Lever Chain Load Binders



- 45943-12** 1/4-in. Lever Load Binder. Accepts chain from 1/4-in. G70 up to 5/16-in. G43. WLL: 2,600 lbs./1,180 kg. Weight: 3.5 lbs./1.59 kg.
- 45943-10** 5/16-in. Lever Load Binder. Accepts chain from 5/16-in. G70 up to 3/8-in. G43. WLL: 5,400 lbs./2,450 kg. Weight: 7.9 lbs./3.59 kg.
- 45943-10HD** 5/16-in, Heavy-Duty Lever Load Binder. Accepts chain from 5/16-in G70 up to 3/8-in G70. WLL: 6,600 lbs./2,996 kg. Weight: 9.4 lbs./4.3 kg.
- 45943-11** 3/8-in Lever Load Binder. Accepts chain from 3/8-in. G70 up to 1/2-in. G43. WLL: 9,200 lbs./4,176 kg. Weight: 11.9 lbs./5.4 kg.
- 45943-13** 1/2-in Lever Load Binder. Accepts chain from 1/2-in. G70 up to 5/8-in. G43. WLL: 13,000 lbs./5,902 kg. Weight: 20.8 lbs./9.44 kg.

Recoilless Lever Chain Load Binders



- 45943-14** 5/16-in. Lever Load Binder. Accepts chain from 5/16-in. G70 up to 3/8-in. G43. WLL: 5,400 lbs./2,450 kg. Weight: 9.0 lbs./4.09 kg.

CHAIN LOAD BINDERS

Ratcheting Chain Load Binders



45943-20

5/16-in Ratchet Load Binder accepts chain from 5/16-in. G70 up to 3/8-in. G43. WLL: 5,400 lbs./2,450 kg. Weight: 10.4 lbs./4.72 kg.

45943-20HD

5/16-in, Heavy-Duty Ratchet Load Binder. Accepts chain from 5/16-in G70 up to 3/8-in G70. WLL: 6,600 lbs./2,996 kg. Weight: 10.5 lbs./4.8 kg.

45943-21

3/8-in Ratchet Load Binder accepts chain from 3/8-in. G70 up to 1/2-in. G43. WLL: 9,200 lbs./4,176 kg. Weight: 11.8 lbs./5.36 kg.

45943-23

1/2-in Ratchet Load Binder accepts chain from 1/2-in. G70 up to 5/8-in. G43. WLL: 13,000 lbs./5,902 kg. Weight: 15.7 lbs./7.13 kg.

WARNING:

Follow all instructions. Failure to do so may result in serious personal injury, property damage and or loss of life. Observe the working load limits as noted above and on tags for determining the number of tie downs and hardware required under federal D.O.T. FMCSA 40 CFR Parts 392-393 vehicle inspection criteria. Extreme caution should be used in tensioning load binders to ensure chain links are seated securely in the hook before releasing the tension on the load binder.

LEVER BINDER LOCKING CLIP

Specifically designed locking clip to secure the handle on lever load binders and recoilless lever load binders to avoid the possible rotation of the handle and release of chain tension. Powder coated in a yellow finish for corrosion protection and visibility. When the locking clip is properly installed it helps prevent the lever handle from opening.



50117-10

Weight: .40 lbs./0.18 kg.

FLOOR CHAIN TIE DOWNS

Floor chain tie down anchors are available in either weld-on or bolt-on models to meet your specific needs. Each with a working load limit of 6,000 lbs./2,724 kg. Each are made with 3/8-in grade 70 transport chain for strength and durability.



49345-10

Weld-on Black E-coat. Weight: 5.6 lbs./2.54 kg.

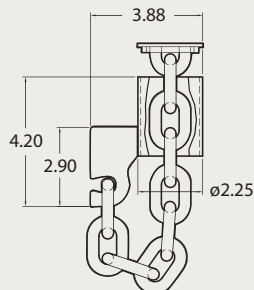

49583-10

Bolt-on Plated. Weight: 5.25 lbs./2.38 kg.

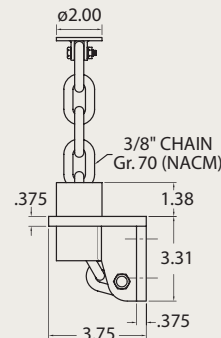

FLATBED SOLUTIONS

ANCRA X-TREME: WEBBING PERFORMANCE LEADER

As the name implies, Ancra's X-TREME webbing offers our greatest performance, durability, strength and abrasion resistance. Because of its special weave construction and coating process, X-TREME realizes an impressive 80% retained strength after abrasion testing, as opposed to 40% for standard webbing.

X-TREME's coating is durable and permanent, and reduces water absorption and freezing. Ancra X-TREME is available in popular winch and ratchet strap models that meet or exceed WSTDA T-1 standards. Custom lengths and end hardware quoted upon request.



ANCRA X-TREME WINCH STRAP ASSEMBLIES

Custom lengths and webbing configurations available.

2" WINCH STRAPS — WLL: 3,333 lbs./1,515 kg. using 41632-37 X-TREME Webbing



41659-90-27

2-in. x 27-ft. ANCRA X-TREME Strap w/ 40891-18 Flat Hook

41659-90-30

2-in x 30-ft. ANCRA X-TREME Strap w/ 40891-18 Flat Hook



41659-92-30

2-in x 30-ft. ANCRA X-TREME Strap w/ 43120-13 Wire Hook



41659-93-30

2-in x 30-ft. ANCRA X-TREME Strap w/ 43366-21 Chain Anchor



41659-94-30

2-in x 30-ft. ANCRA X-TREME Strap w/o hardware. For winch to winch applications. Custom lengths available.



ANCRA X-TREME WINCH STRAP ASSEMBLIES

3" WINCH STRAPS — WLL: 5,400 lbs./2,450 kg. using 41632-38 X-TREME Webbing



41660-90-30

3-in. x 30-ft. ANCRA X-TREME Strap w/ 41766-18 Flat Hook



41660-93-30

3-in. x 30-ft. ANCRA X-TREME Strap w/ 43366-14 Chain Anchor



41660-95-30

3-in. x 30-ft. ANCRA X-TREME Strap w/o hardware. For winch to winch applications. Custom lengths available.

ANATOMY OF A WINCH STRAP

Overall Length

The overall distance from the tip of the attachment hardware (flat hook pictured) to the end of the webbing. Standard lengths are 27' and 30', with the most popular being 30'.



Hardware End

Webbing

Width

Determined by the width of the webbing used, 2", 3" or 4"



Label

Sewn near the hook end is our new extremely durable, yellow reinforced label with proper warnings, usage and working load limits in pounds and kilos.

FLATBED SOLUTIONS

ANCRA X-TREME WINCH STRAP ASSEMBLIES

4" WINCH STRAPS — WLL: 5,400 lbs./2,450 kg. using 43797-37 X-TREME Webbing



43795-90-27

4-in. x 27-ft. ANCRA X-TREME Strap w/ 41766-18 Flat Hook

43795-90-30

4-in. x 30-ft. ANCRA X-TREME Strap w/ 41766-18 Flat Hook

43795-90-40

4-in. x 40-ft. ANCRA X-TREME Strap w/ 41766-18 Flat Hook



43795-91-27

4-in. x 27-ft. ANCRA X-TREME Strap w/ 41631-12 Delta Ring

43795-91-30

4-in. x 30-ft. ANCRA X-TREME Strap w/ 41631-12 Delta Ring

43795-91-40

4-in. x 40-ft. ANCRA X-TREME Strap w/ 41631-12 Delta Ring



43795-93-30

4-in. x 30-ft. ANCRA X-TREME Strap w/ Half Twisted Loop



43795-95-30

4-in. x 30-ft. ANCRA X-TREME Strap w/ 43366-14 Chain Anchor



43795-92-30

4-in. x 30-ft. ANCRA X-TREME Strap w/o hardware. For winch to winch applications. Custom lengths available.

MILE AFTER MILE, YOUR DEPENDABLE CLASSIC.

Ancra Winch Strap Assemblies combine heavy-duty, wear and weather resistant latex treated polyester webbing with strong, dependable hardware to meet the demanding conditions of flatbed operations. Ancra straps meet DOT specifications and are tested for strength and durability. Meets or exceeds WSTDA T-1 Recommended Standard Specifications for synthetic web tie downs.



WINCH STRAP ASSEMBLIES

2" WINCH STRAPS — WLL: 3,333 lbs./1,515 kg. using 41632-46 Webbing



41659-10-27

2-in. x 27-ft. Winch Strap w/
40891-18 Flat Hook

41659-10-30

2-in. x 30-ft. Winch Strap w/
40891-18 Flat Hook



41659-11-27

2-in. x 27-ft. Winch Strap w/
40978-11 Delta Ring

41659-11-30

2-in. x 30-ft. Winch Strap w/
40978-11 Delta Ring



41659-13-27

2-in. x 27-ft. Winch Strap w/
43120-13 Wire Hook

41659-13-30

2-in. x 30-ft. Winch Strap w/
43120-13 Wire Hook



41659-15-27

2-in. x 27-ft. Winch Strap w/
43366-21 Chain Anchor

41659-15-30

2-in. x 30-ft. Winch Strap w/
43366-21 Chain Anchor



41659-16-30

2-in. x 30-ft. Winch Strap w/o hardware for winch to winch application.
Custom lengths available.

FLATBED SOLUTIONS

WINCH STRAP ASSEMBLIES

3" WINCH STRAPS — WLL: 5,400 lbs./2,450 kg. using 41632-14 Webbing



41660-10-27

3-in. x 27-ft. Winch Strap w/
41766-18 Flat Hook

41660-10-30

3-in. x 30-ft. Winch Strap w/
41766-18 Flat Hook



41660-14-27

3-in. x 27-ft. Winch Strap w/
43366-14 Chain Anchor

41660-14-30

3-in. x 30-ft. Winch Strap w/
43366-14 Chain Anchor



41660-18-27

3-in. x 27-ft. Winch Strap w/
43120-20 Wire Hook

41660-18-30

3-in. x 30-ft. Winch Strap w/
43120-20 Wire Hook



41660-17-30

3-in. x 30-ft. strap w/o hardware for winch to winch application.
Custom lengths available.

4" WINCH STRAPS — WLL: 5,400 lbs./2,450 kg. using 43797-12 Webbing



43795-10-27

4-in. x 27-ft. Winch Strap w/
41766-18 Flat Hook

43795-10-40

4-in. x 40-ft. Winch Strap w/
41766-18 Flat Hook

43795-10-30

4-in. x 30-ft. Winch Strap w/
41766-18 Flat Hook

43795-10-50

4-in. x 50-ft. Winch Strap w/
41766-18 Flat Hook

43795-10-35

4-in. x 35-ft. Winch Strap w/
41766-18 Flat Hook



43795-11-27

4-in. x 27-ft. Winch Strap w/
41631-12 Delta Ring

43795-11-40

4-in. x 40-ft. Winch Strap w/
41631-12 Delta Ring

43795-11-30

4-in. x 30-ft. Winch Strap w/
41631-12 Delta Ring

43795-11-50

4-in. x 50-ft. Winch Strap w/
41631-12 Delta Ring

43795-11-35

4-in. x 35-ft. Winch Strap w/
41631-12 Delta Ring



43795-13-30

4-in. x 30-ft. Winch Strap w/
Half Twisted Loop

43795-13-65

4-in. x 65-ft. Winch Strap w/
Half Twisted Loop

43795-13-45

4-in. x 45-ft. Winch Strap w/
Half Twisted Loop

43795-13-75

4-in. x 75-ft. Winch Strap w/
Half Twisted Loop

43795-13-50

4-in. x 50-ft. Winch Strap w/
Half Twisted Loop



43795-14-27

4-in. x 27-ft. Winch Strap w/
43365-12 Grab Hook

43795-14-30

4-in. x 30-ft. Winch Strap w/
43365-12 Grab Hook

WINCH STRAP ASSEMBLIES

4" WINCH STRAPS — WLL: 5,400 lbs./2,450 kg. using 43797-12 Webbing



43795-15-27

4-in. x 27-ft. Winch Strap w/
43366-14 Chain Anchor

43795-15-30

4-in. x 30-ft. Winch Strap w/
43366-14 Chain Anchor



43795-19-30

4-in. x 30-ft. Winch Strap w/o hardware for winch to winch
application. Custom lengths available.



43795-40-30

4-in. x 30-ft. Winch Strap w/ 41766-18 Flat Hook.
using 43797-19 Blue Webbing.



43795-60-30

4-in. x 30-ft. Winch Strap w/ 41766-18 Flat Hook.
using 43797-23 Crimson Red Webbing.

ROLL-ON/ROLL-OFF CONTAINER STRAPS

STANDARD



49526-10

4-in. x 5-ft. Strap w/ 48968-11 Container Hook.
WLL: 5,400 lbs./2,450 kg.



49526-11

4-in. x 5-ft. Strap w/ 48968-11 Container Hook and Sewn Loop
end. WLL: 5,400 lbs./2,450 kg.

ANKRA X-TREME



49526-90

4-in. x 5-ft. Ankra X-TREME Strap w/ 48968-11 Container Hook.
WLL: 5,400 lbs./2,450 kg.



49526-91

4-in. x 5-ft. Ankra X-TREME Strap w/ 48968-11 Container Hook and
Sewn loop end.
WLL: 5,400 lbs./2,450 kg.

FLATBED SOLUTIONS

ENGINEERED FOR STRENGTH AND DURABILITY

Ancra Ratchet Buckle Strap Assemblies have redefined the industry standard. Now with the tested and proven 80% retained strength of Ancra X-TREME webbing and the integrity of our ratchet buckles, these assemblies surpass the others. A complete line of Ancra's standard and heavy-duty assemblies and accessories can meet all your specific requirements.

- ▶ Custom lengths and a wide range of end hardware are available.
- ▶ Complies with WSTDA T-1 Standards
- ▶ Webbing meets or exceeds WSTDA T-4 Standards
- ▶ Standard fixed end length is 18-in., unless otherwise specified.



ANCRA X-TREME RATCHET STRAP ASSEMBLIES

2" ANCRA X-TREME RATCHET STRAPS USING 41632-37 WEBBING WITH LONG-WIDE HANDLE

RATCHET BUCKLE 44587-10 — WLL: 3,333 lbs./1,515 kg.



45982-90-27

2-in. x 27-ft. ANCRA X-TREME Ratchet Strap w/ 40891-18 Flat Hooks.

45982-90-30

2-in. x 30-ft. ANCRA X-TREME Ratchet Strap w/ 40891-18 Flat Hooks.



45982-93-30

2-in. x 30-ft. ANCRA X-TREME Ratchet Strap w/ 43366-21 Chain Anchors. Fixed End 33-in.



45982-95-27

2-in. x 27-ft. ANCRA X-TREME Ratchet Strap w/ 43120-13 Wire Hooks.

45982-95-30

2-in. x 30-ft. ANCRA X-TREME Ratchet Strap w/ 43120-13 Wire Hooks.

3" ANCRA X-TREME RATCHET STRAPS USING 41632-38 WEBBING WITH RATCHET BUCKLE

48965-10 — WLL: 5,400 lbs./2,450 kg.



48987-90-27

3-in. x 27-ft. ANCRA X-TREME Ratchet Strap w/ 41766-18 Flat Hooks. Fixed End 22-in.

48987-90-30

3-in. x 30-ft. ANCRA X-TREME Ratchet Strap w/ 41766-18 Flat Hooks. Fixed End 22-in.



48987-92-27

3-in. x 27-ft. ANCRA X-TREME Ratchet Strap w/ 43366-14 Chain Anchors. Fixed End 37-in.

48987-92-30

3-in. x 30-ft. ANCRA X-TREME Ratchet Strap w/ 43366-14 Chain Anchors. Fixed End 37-in.

ANCRA X-TREME RATCHET STRAP ASSEMBLIES

4" ANCRA X-TREME RATCHET STRAPS USING 43797-37 WEBBING WITH RATCHET BUCKLE
49349-10 — WLL: 5,400 lbs./2,450 kg.



49346-90-27

4-in. x 27-ft. ANCRA X-TREME Ratchet Strap w/ 41766-18 Flat Hooks. Fixed End 20-in.

49346-90-30

4-in. x 30-ft. ANCRA X-TREME Ratchet Strap w/ 41766-18 Flat Hooks. Fixed End 20-in.



49346-91-27

4-in. x 27-ft. ANCRA X-TREME Ratchet Strap w/ 43366-14 Chain Anchors. Fixed End 35-in.

49346-91-30

4-in. x 30-ft. ANCRA X-TREME Ratchet Strap w/ 43366-14 Chain Anchors. Fixed End 35-in.



49346-93-27

4-in. x 27-ft. ANCRA X-TREME Ratchet Strap w/ 43120-20 Wire Hooks. Fixed End 20-in.

49346-93-30

4-in. x 30-ft. ANCRA X-TREME Ratchet Strap w/ 43120-20 Wire Hooks. Fixed End 20-in.

ANATOMY OF A RATCHET STRAP

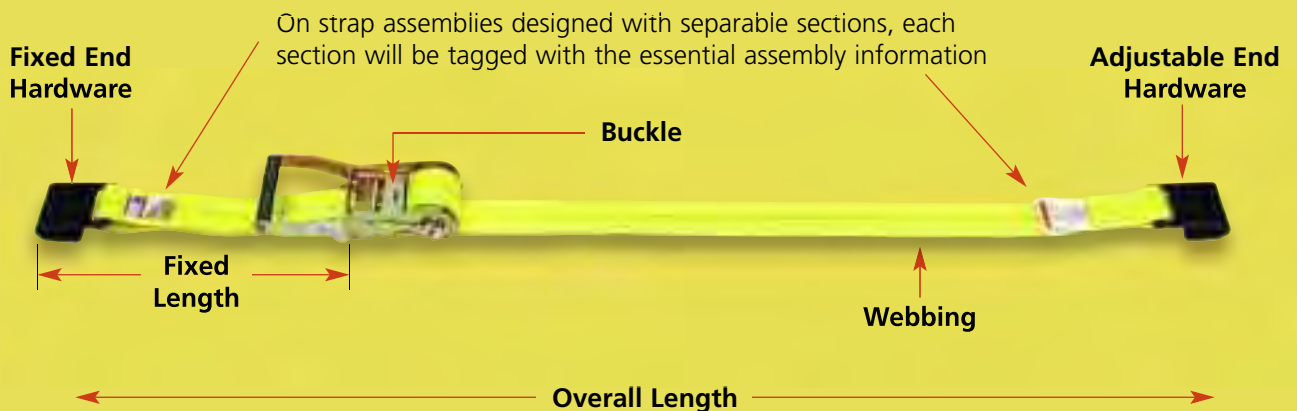

The distance between extreme end bearing points of the web tie down assembly, including the fittings. Standard fixed end length is 18" (33" for chain anchor straps). This puts the ratchet in the optimum position on the side of the trailer.

FLATBED SOLUTIONS

RATCHET STRAP ASSEMBLIES

The strength of Ancra Ratchet Strap Assemblies reflects the strength of Ancra's reputation in the Transportation Industry. Our heavy-duty, weather resistant straps and solid, reliable hardware have met the demands of the road for more than 40 years. Our straps are stringently tested for strength and durability in order to bear the Ancra name.

2" RATCHET BUCKLE STRAPS USING 41632-46 WEBBING WITH LONG-WIDE HANDLE RATCHET BUCKLE 44587-10 — WLL: 3,333 lbs./1,515 kg.



45982-10

2-in. x 27-ft. Ratchet Strap w/
40891-18 Flat Hooks.

45982-11

2-in. x 30-ft. Ratchet Strap w/
40891-18 Flat Hooks.



45982-15

2-in. x 27-ft. Ratchet Strap w/
43366-21 Chain Anchors.
Fixed End 33-in.

45982-34

2-in. x 30-ft. Ratchet Strap w/
43366-21 Chain Anchors.
Fixed End 33-in.



45982-19

2-in. x 27-ft. Ratchet Strap w/
40758-11 Twisted Snap Hooks.

45982-36

2-in. x 30-ft. Ratchet Strap w/
40758-11 Twisted Snap Hooks.



45982-42

2-in. x 27-ft. Ratchet Strap w/
43120-13 Wire Hooks.

45982-43

2-in. x 30-ft. Ratchet Strap w/
43120-13 Wire Hooks.

2" RATCHET BUCKLE STRAPS USING 41632-46 WEBBING WITH SHORT-WIDE HANDLE RATCHET BUCKLE 47105-11 — WLL: 3,333 lbs./1,515 kg.



47970-10

2-in. x 27-ft. Ratchet Strap w/
40891-18 Flat Hooks.

47970-11

2-in. x 30-ft. Ratchet Strap w/
40891-18 Flat Hooks.

2" RATCHET BUCKLE STRAPS USING 41632-46 WEBBING WITH STANDARD HANDLE RATCHET BUCKLE 44627-11 — WLL: 3,333 lbs./1,515 kg.



47971-10

2-in. x 27-ft. Ratchet Strap w/
40891-18 Flat Hooks.

47971-11

2-in. x 30-ft. Ratchet Strap w/
40891-18 Flat Hooks.

RATCHET STRAP ASSEMBLIES

3" RATCHET BUCKLE STRAPS USING 41632-14 WEBBING WITH RATCHET BUCKLE 48965-10 —
WLL: 5,400 lbs./2,450 kg.



48987-20

3-in. x 27-ft. Ratchet Strap w/ 41766-18 Flat Hooks.

48987-21

3-in. x 30-ft. Ratchet Strap w/ 41766-18 Flat Hooks.



48987-24

3-in. x 27-ft. Ratchet Strap w/ 43366-14 Chain Anchors. Fixed End 33-in.

48987-25

3-in. x 30-ft. Ratchet Strap w/ 43366-14 Chain Anchors. Fixed End 33-in.



48987-28

3-in. x 27-ft. Ratchet Strap w/ 43120-13 Wire Hook.

48987-29

3-in. x 30-ft. Ratchet Strap w/ 43120-13 Wire Hook.

4" RATCHET BUCKLE STRAPS USING 43797-12 WEBBING WITH RATCHET BUCKLE 49349-10 —
WLL: 5,400 lbs./2,450 kg.



49346-10

4-in. x 27-ft. Ratchet Strap w/ 41766-18 Flat Hooks.

49346-11

4-in. x 30-ft. Ratchet Strap w/ 41766-18 Flat Hooks.

WLL: 5,400 lbs./2,450 kg.



49346-14

4-in. x 27-ft. Ratchet Strap w/ 43366-14 Chain Anchors. Fixed End 33-in.

49346-15

4-in. x 30-ft. Ratchet Strap w/ 43366-14 Chain Anchors. Fixed End 33-in.

4" RATCHET BUCKLE STRAPS USING 41632-15 WEBBING WITH RATCHET BUCKLE 49349-10 —
WLL: 6,600 lbs./3,000 kg.



49346-12

4-in. x 27-ft. Ratchet Strap w/ 43120-20 Narrow Wire Hooks.

49346-13

4-in. x 30-ft. Ratchet Strap w/ 43120-20 Narrow Wire Hooks.

FLATBED SOLUTIONS

WEB KEEPER RATCHET STRAP ASSEMBLIES



Keep your excess webbing neat and secure with our new patented Web Keeper Ratchet Buckle Straps.

PATENTED

Tension your strap, roll up excess webbing and store it under the lever. Straps are available in 27' and 30' lengths in flat hook or wire hook models in standard or X-TREME webbing. These straps have a fixed end length of 18" and meet or exceed WSTDA T-1 Standard Specification for synthetic web tie downs.

2" WEB KEEPER RATCHET BUCKLE STRAPS USING 41632-46 WEBBING WITH LONG-WIDE HANDLE WEB KEEPER RATCHET BUCKLE 50037-10 — WLL: 3,333 lbs./1,515 kg.



45982-10-27-WK

2-in. x 27-ft. Web Keeper Ratchet Strap w/ 40891-18 Flat Hooks.

45982-11-30-WK

2-in. x 30-ft. Web Keeper Ratchet Strap w/ 40891-18 Flat Hooks.



45982-42-27-WK

2-in. x 27-ft. Web Keeper Ratchet Strap w/ 43120-13 Wire Hooks.

45982-43-30-WK

2-in. x 30-ft. Web Keeper Ratchet Strap w/ 43120-13 Wire Hooks.

2" WEB KEEPER RATCHET BUCKLE STRAPS USING 41632-37 X-TREME WEBBING WITH LONG-WIDE HANDLE WEB KEEPER RATCHET BUCKLE 50037-10 — WLL: 3,333 lbs./1,515 kg.



45982-90-27-WK

2-in. x 27-ft. X-TREME Web Keeper Ratchet Strap w/ 40891-18

45982-90-30-WK

2-in. x 30-ft. X-TREME Web Keeper Ratchet Strap w/ 40891-18 Flat Hooks.



45982-95-27-WK

2-in. x 27-ft. X-TREME Web Keeper Ratchet Strap w/ 43120-13 Wire Hooks.

45982-95-30-WK

2-in. x 30-ft. X-TREME Web Keeper Ratchet Strap w/ 43120-13 Wire Hooks.

RATCHET STRAP ASSEMBLIES



Flat Hook



Wire Hook



Chain Anchor



FOR ANCRAX-TREME 2" RATCHET STRAP ASSEMBLIES

Replacement for:

Replacement for:	Part No.	Description
45982-90-27 & -30	10632-90	2" x 18" Fixed end strap w/ 44587-10 Buckle and 40891-18 Flat hook
45982-90-27 & -30, 45982-90-27-WK, 45982-90-30-WK	10632-90-28	2" x 28' Adjustable end strap w/ 40891-18 Flat hook
45982-93-30	10632-93	2" x 33" Fixed end strap w/ 44587-10 Buckle and 43366-21 Chain Anchor
45982-93-30	10632-93-28	2" x 28' Adjustable end strap w/ 43366-21 Chain Anchor
45982-95-27 & -30	10632-95	2" x 18" Fixed end strap w/ 44587-10 Buckle and 43120-13 Wire hook
45982-95-27 & -30, 45982-95-27-WK, 45982-95-30-WK	10632-95-28	2" x 28' Adjustable end strap w/ 43120-13 Wire hook

FOR ANCRAX-TREME 3" RATCHET STRAP ASSEMBLIES

48987-90-27 & -30	10633-90	3" x 22" Fixed end strap w/ 48965-10 Buckle and 41766-18 Flat hook
48987-90-27 & -30	10633-90-28	3" x 28' Adjustable end strap w/ 41766-18 Flat hook
48987-92-27 & -30	10633-92	3" x 37" Fixed end strap w/ 48965-10 Buckle and 43366-14 Chain Anchor
48987-92-27 & -30	10633-92-28	3" x 28' Adjustable end strap w/ 43366-14 Chain Anchor

FOR ANCRAX-TREME 4" RATCHET STRAP ASSEMBLIES

49346-90-27 & -30	10634-90	4" x 20" Fixed end strap w/ 49349-10 Buckle and 41766-18 Flat hook
49346-90-27 & -30	10634-90-28	4" x 28' Adjustable end strap w/ 41766-18 Flat hook
49346-91-27 & -30	10634-91	4" x 35" Fixed end strap w/ 49349-10 Buckle and 43366-14 Chain Anchor
49346-91-27 & -30	10634-91-28	4" x 28' Adjustable end strap w/ 43366-14 Chain Anchor
49346-93-27 & -30	10634-93	4" x 20" Fixed end strap w/ 49349-10 Buckle and 43120-20 Wire hook
49346-93-27 & -30	10634-93-28	4" x 28' Adjustable end strap w/ 43120-20 Wire hook

FOR STANDARD 2" RATCHET STRAP ASSEMBLIES

Replacement for:

Replacement for:	Part No.	Description
45982-10 & -11, 47970-10 & -11, 47971-10 & -11, 45982-10-27-WK, 45982-11-30-WK	48922-10	2" x 18" Fixed end strap w/ 40891-18 Flat hook & loop end
45982-42 & -43	48922-13	2" x 18" Fixed end strap w/ 43120-13 Wire hook & loop end
445982-15 & -34, 45982-42-27-WK, 45982-43-30-WK	48922-16	2" x 33" Fixed end strap w/ 43366-21 Chain Anchor & loop end
45982-10 & -11	49347-10	2" x 18" Fixed end strap w/ 40891-18 Flat hook & 44587-10 Buckle
45982-42 & -43	49347-19	2" x 18" Fixed end strap w/ 43120-13 Wire hook & 44587-10 Buckle
45982-15 & -34	49347-28	2" x 33" Fixed end strap w/ 43366-21 Chain Anchor & 44587-10 Buckle
45982-10, 47970-10, 47971-10	49347-11	2" x 25' Adjustable end strap w/ 40891-18 Flat hook
45982-42	49347-20	2" x 25' Adjustable end strap w/ 43120-13 Wire hook
45982-15	49347-29	2" x 25' Adjustable end strap w/ 43366-21 Chain Anchor
45982-11, 47970-11, 47971-11	49347-12	2" x 28' Adjustable end strap w/ 40891-18 Flat hook
45982-43	49347-21	2" x 28' Adjustable end strap w/ 43120-13 Wire hook
45982-34	49347-30	2" x 28' Adjustable end strap w/ 43366-21 Chain Anchor

FLATBED SOLUTIONS

RATCHET STRAP ASSEMBLIES

FOR STANDARD 3" RATCHET STRAP ASSEMBLIES

Replacement for:	Part No.	Description
48987-20 & -21	48922-11	3" x 18" Fixed end strap w/ 41766-18 Flat hook & loop end
48987-24 & -25	48922-17	3" x 33" Fixed end strap w/ 43366-14 Chain Anchor & loop end
48987-22 & -23	48922-20	3" x 18" Fixed end strap w/ 43365-12 Grab hook & loop end
48987-20 & -21	49347-13	3" x 18" Fixed end strap w/ 41766-18 Flat hook & 48965-10 Buckle
48987-24 & -25	49347-31	3" x 33" Fixed end strap w/ 43366-14 Chain Anchor & 48965-10 Buckle
48987-22 & -23	49347-40	3" x 18" Fixed end strap w/ 43365-12 Grab hook & 48965-10 Buckle
48987-20	49347-14	3" x 25' Adjustable end strap w/ 41766-18 Flat hook
48987-24	49347-32	3" x 25' Adjustable end strap w/ 43366-14 Chain Anchor
48987-22	49347-41	3" x 25' Adjustable end strap w/ 43365-12 Grab hook
48987-21	49347-15	3" x 28' Adjustable end strap w/ 41766-18 Flat hook
48987-25	49347-33	3" x 28' Adjustable end strap w/ 43366-14 Chain Anchor
48987-23	49347-42	3" x 28' Adjustable end strap w/ 43365-12 Grab hook

FOR STANDARD 4" RATCHET STRAP ASSEMBLIES

49346-10 & -11	48922-12	4" x 18" Fixed end strap w/ 41766-18 Flat hook & loop end
49346-12 & -13	48922-15	4" x 18" Fixed end strap w/ 43120-20 Wire hook & loop end
49346-14 & -15	48922-18	4" x 33" Fixed end strap w/ 43366-14 Chain Anchor & loop end
49346-10 & -11	49347-16	4" x 18" Fixed end strap w/ 41766-18 Flat hook & 49349-10 Buckle
49346-12 & -13	49347-25	4" x 18" Fixed end strap w/ 43120-20 Wire hook & 49349-10 Buckle
49346-14 & -15	49347-34	4" x 33" Fixed end strap w/ 43366-14 Chain Anchor & 49349-10 Buckle
49346-10	49347-17	4" x 25' Adjustable end strap w/ 41766-18 Flat hook
49346-12	49347-26	4" x 25' Adjustable end strap w/ 43120-20 Wire hook
49346-14	49347-35	4" x 25' Adjustable end strap w/ 43366-14 Chain Anchor
49346-11	49347-18	4" x 28' Adjustable end strap w/ 41766-18 Flat hook
49346-13	49347-27	4" x 28' Adjustable end strap w/ 43120-20 Wire hook
49346-15	49347-36	4" x 28' Adjustable end strap w/ 43366-14 Chain Anchor



TIE DOWN TIPS

From the Web Sling and Tie Down Association

- ▶ The angle from the horizontal (tie down to trailer deck) has an enormous influence on load securement.
- ▶ If the angle is 90 degrees, the effective downward pressure is 100% of the tie down tension.
- ▶ If the angle is 60 degrees, the effective downward pressure is reduced to 87% of the tie down tension.
- ▶ If the angle is 45 degrees, the effective downward pressure is reduced to 71% of the tie down tension.
- ▶ If the angle is 30 degrees, the effective downward pressure is reduced to 50% of the tie down tension.
- ▶ For more information about the Recommended Standard for Tie Downs, contact WSTDA.

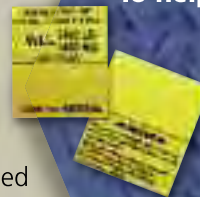

To help prevent unrated straps, Ancra uses high-quality, tear and fade-resistant, reinforced vinyl WLL labels on all flatbed tie downs.

www.wstda.com

INTERIOR VAN SOLUTIONS

From decking systems, track, beams and bars, to strap assemblies and custom nets, Ancra's Interior Van Solutions are made of quality components to secure your loads. Whether your application is standard or heavy-duty, your solution is here.

- Loading systems match your application
- Track treated with high quality finishes for corrosion resistance
- Versatile beams and bars with the best possible strength-to-weight ratio
- Replacement parts for added life and efficiency
- Strength tested and highway proven



INTERIOR VAN SOLUTIONS

LIFT-A-DECK® II

The most popular patented solution for decking loads in trailer and van bodies.

With Ancra's patented adjustable second deck in your trailer, you can carry double the amount of palletized freight, or you can mix loads with only part of the vehicle double decked. Either way, you can increase your payload capacity and your profits. For the loads where you need full height, you simply push the adjustable beams to the roof for convenient and safe storage. There will be no more beams left on the loading dock. The Ancra Lift-A-Deck® II system is the most versatile you can install. With many track styles to choose from, installations can be made on any type of vehicle construction, including sheet and post. Lift-A-Deck II track can also be used with a wide range of Ancra accessories for cargo containment. For information about Ancra's two-year warranty, call our Customer Service Department at 800-929-2627.

Convenient storage.

When not in use, beams are easily pushed to the roof for secure storage. No more lost beams.

Easy operation.

Beams are easily moved by one operator.

Super strength.

Ancra standard beams have the highest rating in the industry – 2,200 lbs./1,000 kg.

Wide range of accessories.

Lift-A-Deck II track can be used for securing loads with cargo straps, tie-offs, and decking/shoring beams.



Fits all trailers.

Available for 96 or 102 inch trailer widths and height can be specified. Track also can be made as an integral part of sidewall structure.

Versatile.

Beams can be adjusted in one-inch increments to accommodate various loads within a trailer. Only Ancra offers this much adjustability.

Snag resistant.

Low profile track design with sloping shoulders helps protect against forklift damage and allows for surface mounting. Standard track length is 72-inches. Custom lengths are available.

Simple, yet secure.

Double engagement lock on the aluminum beam features a simplified trigger release mechanism. Internal locking design helps protect against forklift damage.

LIFT-A-DECK® II

Only Ankra gives you so many decking options.

Cargo beams and Lift-A-Deck beams are rated at Working Load Limits (WLL) that are 1/3 of the breaking strength or failure load capacity of the beams. In order to account for dynamics and vibrations that are experienced during transit and avoid overloading the beams beyond the WLL rating, the actual weight of cargo supported by the beams should be reduced below the rated WLL value of the beam. The allowable weight of cargo supported by the beams should be factored down based on anticipated dynamic G forces expected during transit. Below are typical examples of de-rated weight carrying values for beams based on a range of expected levels of transport dynamics.

Recommended Maximum Cargo Weight per Beam	BEAM TYPE	WLL VALUE OF BEAM	LOW LEVEL (2G)	MID LEVEL (3G)	HIGH LEVEL (4G)
	Standard	2200 lb	1100 lb	733 lb	550 lb
	Heavy Duty	3000 lb	1500 lb	1000 lb	750 lb
	Wide Top	4000 lb	2000 lb	1333 lb	1000 lb

- ▶ Beams can be positioned in one-inch increments for most efficient utilization of space
- ▶ Beams easily moved by just one operator
- ▶ Low Profile locking mechanism to help protect against forklift damage.



See how Lift-A-Deck maximizes your cargo area to increase profits. Scan this QR Code for a how-to video or go to our website at <http://link.ankra.com/?L=4>

STANDARD AND LOW PROFILE BEAMS W/ LOW PROFILE FOOT AND CHANNEL ASSEMBLY



PATENTED
No. 6,074,143

49414-15
Standard LAD Beam
Adjustment range: 95.1" - 105.6"
Weight: 18.1 lbs./8.2 kg.
Decking WLL: 2,200 lbs./999 kg.*
Shoring WLL: 2,200 lbs./999 kg.



PATENTED
No. 6,074,143

49414-19
Heavy Duty LAD Beam
Adjustment range: 95.1" - 105.6"
Weight: 19.7 lbs./8.9 kg.
Decking WLL: 3,000 lbs./1,360 kg.
Shoring WLL: 2,500 lbs./1,135 kg.*

WIDE TOP BEAM W/ LOW PROFILE FOOT AND CHANNEL ASSEMBLY

The textured Beam top surface is 4-1/2" wide to increase the contact area for cargo on the beam deck.

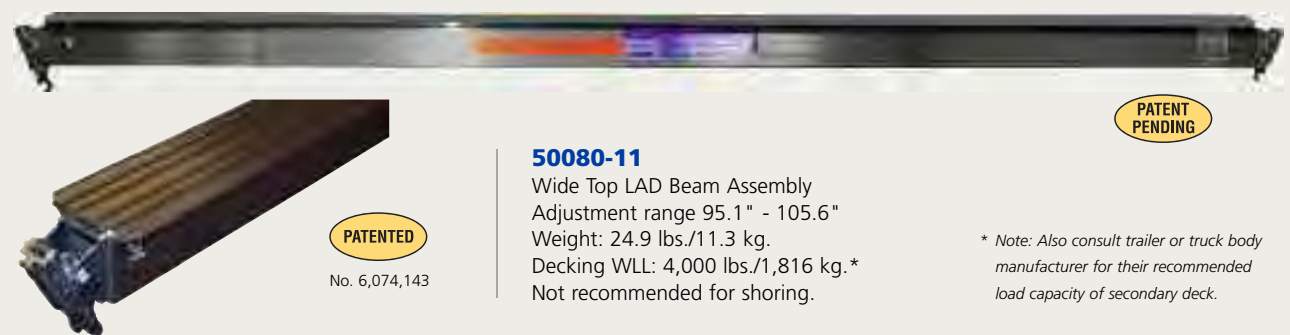

PATENTED
No. 6,074,143

50080-11
Wide Top LAD Beam Assembly
Adjustment range 95.1" - 105.6"
Weight: 24.9 lbs./11.3 kg.
Decking WLL: 4,000 lbs./1,816 kg.*
Not recommended for shoring.

PATENT PENDING

* Note: Also consult trailer or truck body manufacturer for their recommended load capacity of secondary deck.

INTERIOR VAN SOLUTIONS

LIFT-A-DECK® II

BEAM ACCESSORIES AND COMPONENTS —

RT Beams have all the required labels.



49414-15-RT

Replacement Tube for 49414-15 Standard LAD Beam. Length 90.71 inches.

49414-19-RT

Replacement Tube for 49414-19 Heavy-Duty LAD Beam. Length 90.71 inches.

50080-11-RT

Replacement Tube for 50080-11 Wide Top LAD Beam. Length 90.71 inches.



49445-12

Beam Release Bar
Weight: 2.5 lbs./1.14 kg.



PRODUCT FEATURES

WITH MORE THAN 45,000 SYSTEMS OPERATING YEAR AFTER YEAR WITH LOW MAINTENANCE COSTS, LIFT-A-DECK IS THE DECK SYSTEM MOST REQUESTED BY MAJOR FLEETS.

- + NO TRACK LUBRICATION REQUIRED.
- + SYSTEM TRACK AND FOOT ASSEMBLIES ARE PRECISION MACHINED RESULTING IN SMOOTH SLIDING BEAMS.
- + EVALUATION, TESTING, TRAINING AND INSTALLATION BY CERTIFIED DECK SPECIALISTS WILL HELP DETERMINE THE BEST LAD II SYSTEM FOR YOUR APPLICATION AND ENSURE MAXIMUM EFFICIENCY AND ROI.



50055-10

Beam Release Bar Holder
Weight: .44 lbs./0.2 kg.



49384-12 Track Stop

Weight: .04 lb./0.02 kg.



PATENTED

No. 6,074,143

49811-20L

Low Profile Foot and Channel Assembly
Weight: 3.1 lbs./1.41 kg.



50194-100 Low Profile Allen Sleeve Nut and Bolt Kit

Low profile allen head bolt and sleeve nut with a semi-flush head height of .10". Used for attaching channel assemblies to beams. The bolt has a self locking patch to prevent loosening due to vibration. For 43638, 49039, 49360, 49414, 50080, 50158, 50186 and 50191 beams. Weight: .10 lb./0.5 kg.

* Note: Also consult trailer or truck body manufacturer for their recommended load capacity of secondary deck.

AFTERMARKET DECKING SYSTEM BEAMS

AFTERMARKET DECKING BEAMS — OLDER STYLE CAPTIVE BEAM SYSTEMS



49414-21

Standard Aftermarket Beam
 Adjustment range 97.3" - 108.8"
 Weight: 23.7 lbs./10.76 kg.
 Decking WLL: 2,200 lbs./1,000 kg.
 Shoring WLL: 1,500 lbs./680 kg.

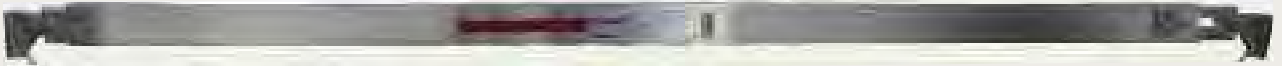

50191-10

Heavy-Duty Aftermarket Beam
 Adjustment range 97.3" - 108.8"
 Weight: 25.3 lbs./11.49 kg.
 Decking WLL: 2,200 lbs./1,000 kg.
 Shoring WLL: 1,500 lbs./680 kg.

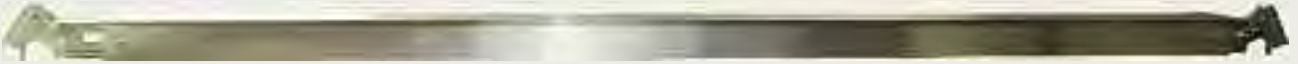

50186-10

Wide Top Aftermarket Beam
 Adjustment range 97.3" - 108.8"
 Weight: 30.5 lbs./13.85 kg.
 Decking WLL: 2,500 lbs./1,135 kg.
 Not recommended for shoring.

** Note: Also consult trailer or truck body manufacturer for their recommended load capacity of secondary deck.*

AFTERMARKET BEAM ACCESSORIES AND COMPONENTS — RT Beams have all the required labels.

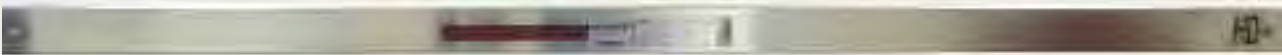

49414-21-RT

Replacement Tube for 49414-21 Standard Aftermarket Beam. Length 90.71 inches.

50191-10-RT

Replacement Tube for 50191-10 Heavy-Duty Aftermarket Beam. Length 90.71 inches.

50186-10-RT (shown above)

Replacement Tube for 50186-10 Wide Top Aftermarket Beam. Length 90.71 inches.

50188-10

Foot and Channel Assembly for 49414-22, 50186-10 and 50191-10 Aftermarket Beams.
 Weight: 5.9 lbs./2.68 kg.



50194-100

Low Profile Allen Sleeve Nut and Bolt Kit
 Low profile allen head bolt and sleeve nut with a semi-flush head height of .10". Used for attaching channel assemblies to beams. The bolt has a self locking patch to prevent loosening due to vibration. For 43638, 49039, 49360, 49414, 50080, 50158, 50186 and 50191 beams. Weight: .10 lb./5 kg.



LIFT-A-DECK® II

Lift-A-Deck® II Track Options

- ▶ Widest choice of track types to meet every application.
- ▶ No track lubrication is required.
- ▶ Beam access slot is provided as standard for easy beam removal and replacement. Standard track length is 72 inches (61 inch loadable). Custom lengths and an installation manual are available upon request.



50192-14-72.00
Standard Single Track

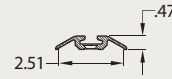
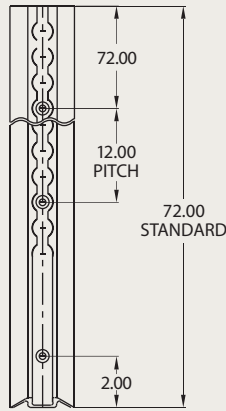

50058-18-72.00
Flanged Single Track.

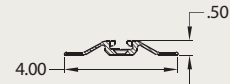
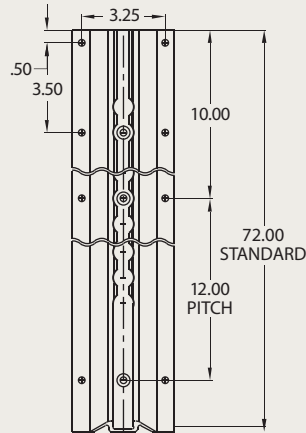

49562-17-72.00
Narrow Single Track

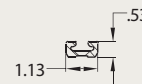
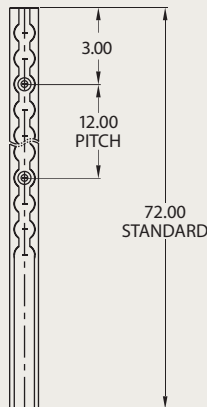

LIFT-A-DECK® II

LIFT-A-DECK® II TRACK OPTIONS



50072-14-72.00
Flanged Double Track

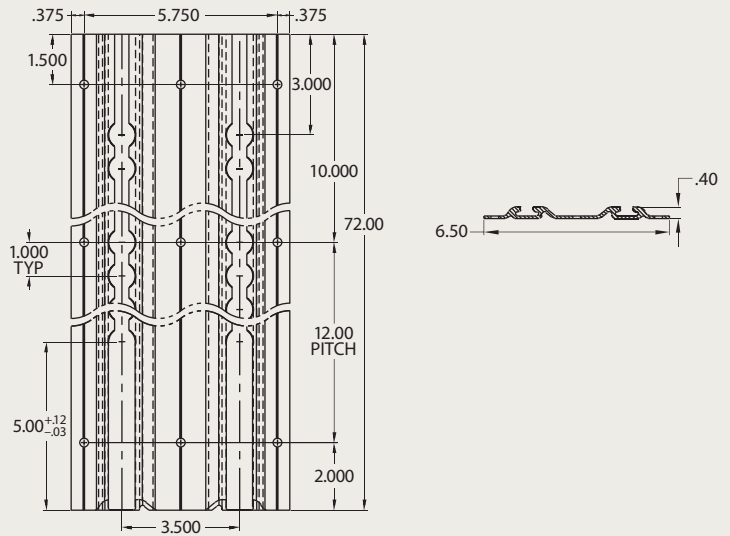

LIFT-A-DECK® II LOGISTIC STRAPS



6,000 lb. Polyester Webbing (47200) with Cam Buckle (40880-15) and (40340-27) Single Stud Fitting. Fixed End: 48-in.
Working Load Limit: 833 lbs./378 kg.

Part No.	Length	Weight
40602-100	12 ft.	1.40 lbs.
40602-101	16 ft.	1.55 lbs.
40602-102	20 ft.	1.70 lbs.



6,000 lb. Polyester Webbing (47200) with Ratchet Buckle (44258-13) and (47556-11) Double Stud Fitting. Fixed End: 48-in.
Working Load Limit: 1,500 lbs./680 kg.

Part No.	Length	Weight
48672-16	12 ft.	2.50 lbs.
48672-17	16 ft.	2.65 lbs.
48672-18	20 ft.	2.80 lbs.

INTERIOR VAN SOLUTIONS

POLY DECK BOARD



- ▶ Lighter than plywood - Increase trailer capacity
- ▶ Ergonomic - Convenient hand slot
- ▶ Splinter Proof - Reduces labor to clean out trailers and docks - longer life than plywood
- ▶ Stackable - Nests for storage
- ▶ Durable - Reduces purchase frequency
- ▶ Recyclable - Energy savings
- ▶ Tough high density polyethylene has excellent low temperature performance down to -40°F
- ▶ Tested to demonstrate durability under load and vibration at -40°F

50105-10

Poly Deck Board for LAD System
For beams set at 16" on center.
48" x 48" x 2.7"H
Weight: 21 lbs./9.53 kg.

50105-11

Poly Deck Board for LAD System
For beams set at 24" on center.
48" x 48" x 2.7"H
Weight: 21 lbs./9.53 kg.

RETRACT-A-ROLL® Cargo containers glide on, glide off.

ANCRA PUTS AIRCRAFT CARGO LOADING CONVENIENCE IN YOUR TRAILER.

Your trailers can benefit from the same high speed loading that moves thousands of tons of air cargo everyday.



Move 1,000 pound loads with one finger.

Available for air freight or palletized freight, both systems instantly convert back to a flat floor for general freight.

ENGINEERED FOR LIGHT WEIGHT, HEAVY DURABILITY.

Steel top cap and rollers fend off forklifts. Lower sections are aluminum to reduce weight. All parts are easily accessed for inspection or repair. System is powered by pneumatics off the truck's existing air supply.

Ancra's next generation heavy cargo system uses retractable rollers to lift and slide containers to speed turnarounds. Loading and unloading is quicker, reducing handling time and lowering labor costs.

Available for air freight or palletized freight, both systems instantly convert back to a flat floor for general freight.



Centralized controls.
Easy to use controls are housed in a weatherproof container.

Easy to operate.
Low pressure pneumatic system runs off your truck's air supply. No other air supply is needed.

Light, strong and rugged.
Extruded aluminum main and roller channel saves weight and adds strength.

Industry-standard connectors.
Standard DOT fittings and 3/8" air line used throughout for reliability, serviceability and for reduced cycle times.



Exclusive safety interlock.
If rollers are not lowered by the operator, a control valve automatically lowers rollers when the vehicle brakes are released.

Simple roller replacement.
Rollers can be easily replaced by removing a spring clip.

Fast operation.
Rollers take less than 15 seconds to raise.

PATENTED

No. 6,193,043 and international

Heavy-duty top plate.
Hi-tensile, 11-gauge folded steel top plate with reinforcing ribs takes the abuse of forklifts. Galvanized finish fights corrosion.

Flanged roller opening.
Helps prevent debris collection in roller cradle and reduces clean out requirement. It also increases top plate stiffness.



Air bag protection.
Ancra's exclusive air bag sleeve offers 360° protection plus the industry's best air bag warranty.

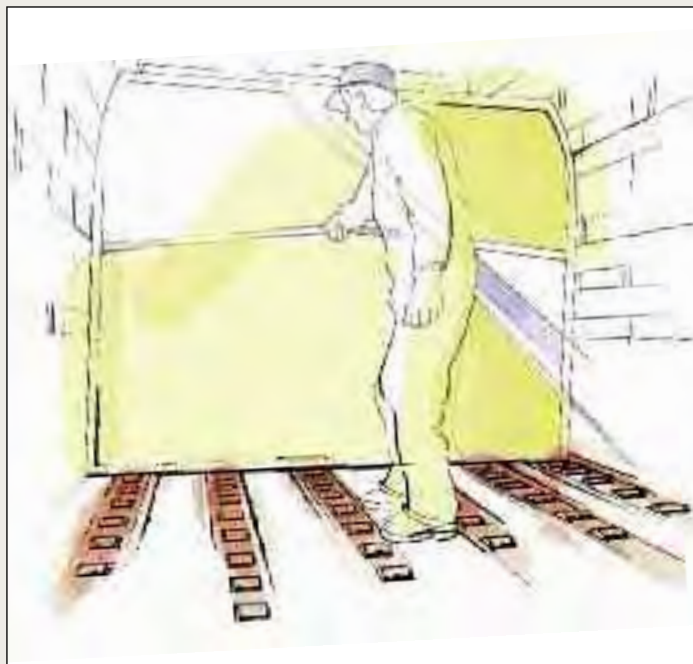

RETRACT-A-ROLL II SPECIFICATIONS

Track width:	4.2 inches / 107 mm
Track height:	2.75 inches / 70 mm
Track weight:	7.2 lbs/ft / 10.7 kg/m (3" roller, 4" pitch)
Inflated height:	3.3 inches / 84 mm
Roller width:	2.0 inches / 51 mm (air freight)
Roller spacing:	4" / 6" straight pitch / 102 / 152 mm
Track lengths:	8', 10' and 13' standard 2.4 m, 3 m, 4 m standard (custom lengths available)
Lifting capacity:	450 lbs/ft / 671 kg/m
Bearing capacity:	500 lbs/ft / 745 kg/m (standard duty)
Operating air pressure:	30 psi / 2 bar
Control box:	weatherproof with centralized controls.

INTERIOR VAN SOLUTIONS

THE RIGHT TRACK

Ankra Series E, A and F Track were designed to team with Ankra end fittings, Beam Sockets, and Decking/Shoring Beams for the strongest, most reliable support. Steel constructed and tested for strength, Ankra Track comes in 10 ft. (3 m) lengths for a wide range of cargo restraint applications. To withstand corrosion, Ankra galvanized track has a G-90 hot dip finish with a surface chemical treatment. Painted track is finished with either high-quality, powder coat or semi-gloss enamel. Custom lengths and special finishes available, contact Customer Service Department.

WARNING: Reference TTMA RP No. 47-99 for installation. Attach track using screws, rivets or by welding. Contact vehicle manufacturer or qualified installer to determine fastener size and mounting method. Welding of galvanized material may emit toxic fumes. Please use caution and proper ventilation.



LOGISTIC TRACK

Series E

Series E track is made of high strength 12-gauge steel for Series E end fittings, Beam Sockets and Decking/Shoring Beams. (See products on page 50 and 51.) This track may be attached with screws, rivets, or by welding.*

HORIZONTAL

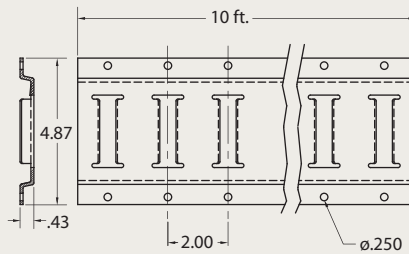
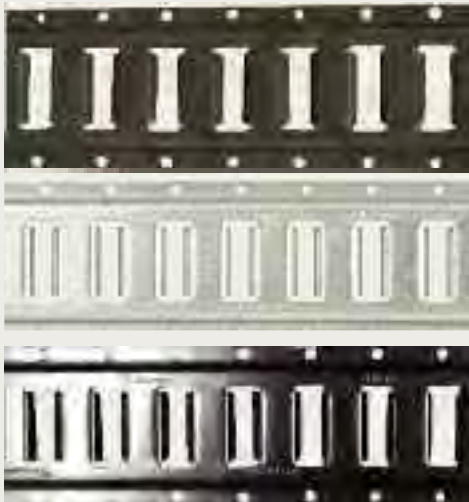

48117-25-120.00

Gray Powdercoat. Weight/Length:
16.6 lbs./10 ft. 7.5 kg./3 m

48117-25-60.00

Gray Powdercoat. Weight/Length:
8.3 lbs./5 ft. 3.77 kg./1.5 m

48117-21-120.00

Galvanized. Weight/Length:
17.2 lb./10 ft., 7.80 kg./3 m

48117-21-60.00

Galvanized. Weight/Length:
8.6 lbs./5 ft. 3.90 kg./1.5 m

48117-32-120.00

Black Powdercoat Weight/Length:
16.6 lbs./10 ft., 7.5 kg./3 m

VERTICAL

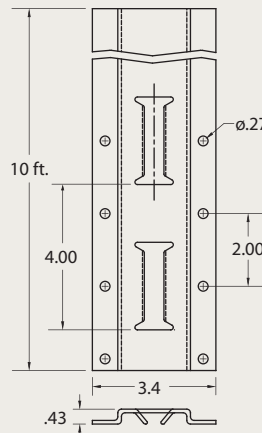

40838-10

Gray Powdercoat.
Weight/Length: 13.5 lbs./10 ft.
6.1 kg./3 m

40838-11

Galvanized.
Weight/Length: 14 lbs./10 ft.
6.4 kg./3 m

** Caution: Welding of galvanized track should be done only in well ventilated areas. Welding fumes may be toxic.*

LOGISTIC TRACK

Series A

Series A track, made of high strength steel or 6061 T6 aluminum, is designed for Series E end fittings, Beam Sockets and Decking/Shoring Beams. (See products on page 50 and 51.) This track may be attached with screws, rivets, or by welding.*

HORIZONTAL

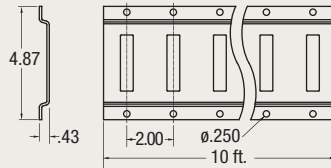

42948-10

Gray Powdercoat. Weight/Length: 15.0 lbs./10 ft. 6.8 kg./3 m. 12-gauge.

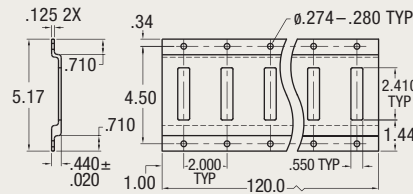

49359-10

Aluminum. Weight/Length: 8 lbs./10 ft. 3.6 kg./3 m.

Series F

Series F track is made of high strength steel for F end fittings and Shoring Beams. (See products on page 50.) This track may be attached with screws, rivets, or by welding.*

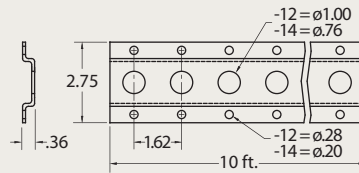

40849-14

Galvanized. 1.62 in. hole spacing & 3/4" hole dia. Weight/length: 6.0 lbs./10 ft., 2.7 kg./3 m. 15-gauge.

40849-12

Galvanized. 1.62 in. hole spacing & 1" hole dia. Weight/length: 6.0 lbs./10 ft., 2.7 kg./3 m. 14-gauge.

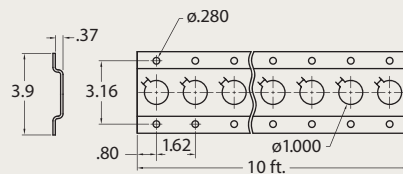

49313-13

Galvanized. 1.62 in. hole spacing. Weight/length: 12.2 lbs./10 ft., 5.53 kg./3 m. 12-gauge.

Series F Channel



47235-10

Galvanized. 1.62 in. hole spacing. Weight/length: 9.0 lbs./10 ft., 4.05 kg./3 m.

47235-15

Galvanized. 1 in. hole spacing. Weight/length: 6.2 lbs./7.5 ft., 2.8 kg./2.25 m.

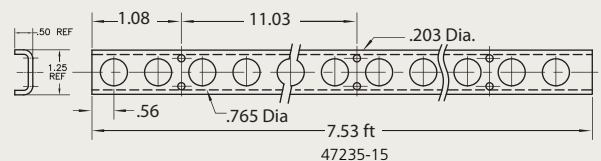
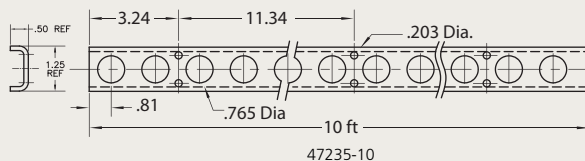

* Caution: Welding of galvanized track should be done only in well ventilated areas. Welding fumes may be toxic.

INTERIOR VAN SOLUTIONS

BEAMS, BARS & HOOPS

All the innovation and selection you'll ever need. Ancra gives you a choice of shoring beams with steel, aluminum, or heavy-duty aluminum models. Aluminum beams feature a patented flat latch mechanism that eliminates the age old problem of damaged trigger mechanisms. It's easier to release, even while wearing gloves. There is even a replacement flat latch channel assembly that can be used to update your existing beams. Extend beam life and keep your costs low.

ANCR A BEAMS ARE PROUDLY MADE IN USA

STANDARD-DUTY ALUMINUM SERIES E AND A DECKING/SHORING BEAM WITH PATENTED FLAT LATCH

Decking and Shoring WLL: 2,200 lbs./999 kg.*



43638-50

Adjustable Range/Weight:
85.7 – 96.6 in./16.0 lbs./7.27 kg.

43638-51

Adjustable Range/Weight:
91.9 – 102.9 in./18.8 lbs./8.55 kg.

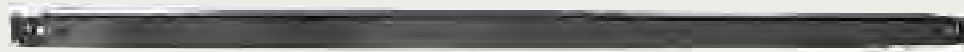

50158-10

Wide Top Decking Beam with textured, 4-1/2" top surface to increase contact area for cargo on the beam deck. Adjustable Range/Weight: 92.9-103.8 in./26.4 lbs./12.0 kg. Decking WLL: 3000 lbs. not recommended for shoring. Patented Flat Latch.

HEAVY-DUTY ALUMINUM SERIES E AND A BEAM ASSEMBLY WITH PATENTED FLAT LATCH

Decking WLL: 3,000 lbs./1,363 kg.* Shoring WLL: 2,500 lbs./1,136 kg.*

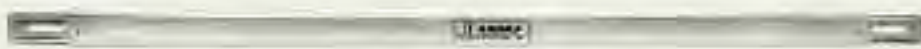

49039-50

Adjustable Range/Weight:
84.7 - 95.7 in./20.50 lbs./
9.32 kg.

49039-51

Adjustable Range/Weight:
91.9 - 102.9 in./22.5 lbs./
10.23 kg.

49039-52

Adjustable Range/Weight:
95.8 - 106.8 in./24.5 lbs./
11.03 kg.

SERIES E AND A STEEL DECKING/SHORING BEAM WITH TRIGGER LATCH

Decking WLL: 2,000 lbs./900 kg. Shoring WLL: 1,100 lbs./499 kg.*



49360-13

Adjustable Range/Weight: 92.1 – 102.9 in./27 lbs./12.26 kg. 14 gauge steel.

DECKING BEAM HOOPS

47670-10

Designed to help restrain the movement of packages of cargo within your truck or trailer. Two hoops and attachment hardware are included providing easy mounting. For 43638, 49039 and 49360 series E and A Decking/Shoring Beams. Weight: 13.25 lbs./6.01 kg.

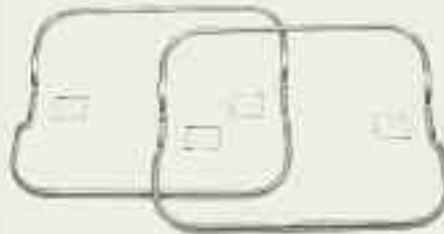

*Working Load Capacity is 1/3 of Breaking Strength Capacity, and based on evenly distributed loads.

BEAMS, BARS & HOOPS

REPLACEMENT PARTS

PATENTED

No. 6,895,867



43627-13

Replacement Channel Assembly with patented flat latch. 11 Gauge. Weight: 3.8 lbs./1.73 kg. For aluminum beams 43638, 49039 and 50158. Can be retrofitted into conventional trigger style beams.



50194-100 Low Profile Allen Sleeve Nut and Bolt Kit. Low profile allen head bolt and sleeve nut with a semi-flush head height of .10". Used for attaching channel assemblies to beams. The bolt has a self locking patch to prevent loosening due to vibration. For 43638, 49039, 49360, 49414, 50080, 50158, 50186 and 50191 beams. Weight: .10 lb./5 kg.

PATENTED

No. 6,895,867



45951-12

Flat Latch Repair Kit Includes latch, screw, nut, springs and instructions. Weight: .14 lb./06 kg. For Part No. 43627-13 channel assembly.

GARMENT BEAMS — WLL: 1,500 lbs./681 kg.*



Specially designed for transporting hanging garments suspended from rope loops in closed trailers. Features a curved top beam to reduce wear on ropes, and is made of high strength extruded aluminum for durability. Assembled with Ankra Beam Socket 40921-10.

45867-12

Length/Weight: 96 in./14.0 lbs./6.36 kg.

45867-13

Length/Weight: 102 in./15.0 lbs./6.82 kg.



10751-10

Garment Rope 1/4" x 8' Yellow braided Polypropylene. 12" loop end w/ knots approx. every 9". NOTE: Contact Ankra Customer Service for minimum order quantities.

BEAM SOCKETS — For use with standard commercial grade Douglas Fir 2-in. x 6-in. lumber.

PLEASE NOTE: The working load limit of lumber varies widely.



40921-10

Standard Beam Socket. Weight: .70 lb./32 kg.



40921-11

Heavy-Duty Beam Socket. Internally welded plate for added strength. Weight: .85 lb./39 kg.

SHORING BARS – F SERIES WITH NEW EASY PUSH BUTTON DESIGN



49439-10

Round Shoring Bar. Adjustable in 2" increments to 117". Weight: 20.0 lbs./9.1 kg. Shoring WLL: 500 lbs./227 kg. Recommended installed length: 81" – 117". Outer tube diameter: 1.66" Inner tube diameter: .72"

49439-11

Round Shoring Bar for 1" hole diameter track (Canada). Adjustable in 2" increments to 117". Weight: 20.0 lbs./9.1 kg. Shoring WLL: 500 lbs./227 kg. Recommended installed length: 81" – 117". Outer tube diameter: 1.66" Inner tube diameter: .945"



49439-20

Square Shoring Bar. Adjustable in 2" increments to 117". Weight: 28.0 lbs./12.71 kg. Shoring WLL: 1,000 lbs./454 kg. Recommended installed length: 81" – 117". Tube size 2" square. Inner tube diameter: .72"

49439-21

Square Shoring Bar for 1" hole diameter track (Canada). Adjustable in 2" increments to 117". Weight: 28.0 lbs./12.71 kg. Shoring WLL: 1,000 lbs./454 kg. Recommended installed length: 81" – 117". Tube size 2" square. Inner tube diameter: .945" for Canadian application.

*Working Load Capacity is 1/3 of Breaking Strength Capacity, and based on evenly distributed loads.

INTERIOR VAN SOLUTIONS

CARGO STA® BARS & HOOP SET

ALUMINUM STANDARD CARGO STA®



43782-15 6061 T6 Aluminum
Length/Weight: 89.75 – 104.5 in. 8.95 lbs./4.07 kg.
Long Tube Diameter: 1.50 in.

CAUTION: Due to the wall construction of a trailer, Cargo Sta® and Jack Bars do not have a working load limit.

ECONOMY STEEL CARGO STA® W/ BOLT-ON FEET



48407-10 Galvanized Steel Tubing
Length/Weight: 89.75 – 104.5 in. 11.72 lbs./5.33 kg.
Long Tube Diameter: 1.50 in.

HOOP SET FOR CARGO STA®

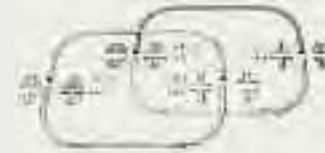

43991-10
Designed to help restrain the movement of small packages of cargo within your truck or trailer. Two hoops and attachment hardware are included providing easy mounting. For 43782, 48407 round tube bars. Tube Diameter: 1.5 in. Weight: 10.0 lbs./4.5 kg.

CARGO STA® AND JACK BAR REPLACEMENTS



Foot, Adjustable End (short)

43781-15S

2 in. x 4 in. Bolt-on.
Weight: .78 lb./.36 kg.
For 43782-15, 48407-10.

43781-17

4 in. x 4 in. Bolt-on.
Weight: 1.35 lbs./.61 kg.
For 49205-25, 49205-26, 49205-27, 49205-28, 49205-31.



Foot, Fixed End (long)

43781-14S

2 in. x 4 in. Bolt-on.
Weight: .62 lb./.29 kg.
For 43782-15, 48407-10.

43781-16

4 in. x 4 in. Bolt-on.
Weight: 1.1 lbs./.5 kg.
For 49205-25, 49205-26, 49205-27, 49205-28, 49205-31.



49443-10 Housing, Rack and Lever Assembly
For Cargo Sta 43782-15, 48407-10.
Complete with necessary hardware.
Weight: 2.12 lbs./.97 kg.



49400-10 38" Red Handle Assembly

49400-11 28" Black Handle Assembly

Jack Bar Component Kits

Complete kit consisting of a Jack Assembly Housing, 4" x 4" adjustable end foot, 4" x 4" fixed end foot and all necessary hardware.

49400-10 Red Handle for 49205-26, 49205-27 & 49205-31 Jack Bars.

49400-11 Black Handle for 49205-25 & 49205-28 Jack Bars.

HEAVY-DUTY JACK BARS

Jack Bars feature 4" x 4" bolt-on feet assemblies and are designed for use in light to medium duty cargo applications. They feature 1-1/2" square heavy-gauge, galvanized steel tubing with a cycle tested, heavy duty automotive jack assembly. For ease of recognition, bars with the longest adjustment range have red handles.

HEAVY-DUTY ONE-PIECE GALVANIZED



PATENTED
No. 6,736,371



49205-25 Weight: 16.2 lbs./7.35 kg. Adjustment range: 85.0" – 104.0" Black Handle

49205-26 Weight: 16.6 lbs./7.54 kg. Adjustment range: 85.0" – 114.0" Red Handle

HEAVY-DUTY ONE-PIECE GALVANIZED WITH HOOPS



49205-27 Weight: 20.0 lbs./9.08 kg. Adjustment range: 85.0" – 114.0" Red Handle

49205-28 Weight: 19.6 lbs./9.0 kg. Adjustment range: 85.0" – 104.0" Black Handle

UNIVERSAL JACK BAR



PATENTED
No. 6,736,371

49205-31

Weight: 18.2 lbs./8.26 kg.

- 51" size used to restrain half loads; compact to fit in locked tool box
- Useful in various load configurations through the universal design
- Patented Safety Snap Pin



Fully Retracted

Adjustment Range: 51" – 80"



Mid Extension

Adjustment Range: 70" – 99"



Full Extension

Adjustment Range: 85" – 114"

CAUTION:

Due to the wall construction of a trailer, Cargo Sta® and Jack Bars do not have a working load limit. The Jack mechanism has a quick release feature that allows the bar to be retracted for easy removal. Read and follow instructions to prevent damage or injury.

INTERIOR VAN SOLUTIONS

ACCESSORIES

BAR KEEP™ CARGO BAR HOLDER

Constructed of high quality steel and finished with black powder coating for corrosion resistance. Holds two standard or heavy-duty cargo bars. A built in gasket reduces vibration and rattle while protecting the bars. Accommodates both 2"x4" or 4"x4" feet.



49348-11 Weight: 6.68 lbs./3.03 kg.

DOOR PULL STRAPS

For pulling overhead, and side doors and wheel carts. Rust protected galvanized steel clip is pre-punched for easy installation.



49015-18	18-in. Door Pull Strap.	Weight: .20 lb./0.09 kg.
49015-24	24-in. Door Pull Strap.	Weight: .30 lb./0.14 kg.
49015-36	36-in. Door Pull Strap.	Weight: .40 lb./0.18 kg.

TIE OFFS A convenient way to attach rope or web to trailer side wall.



40386-10
Series E and A Rope Tie Off 3-piece end fitting for use with Series E or A Track.
WLL: 1,000 lbs./454 kg.
Weight: .30 lb./0.14 kg.

40386-12
Series F Rope Tie Off. For use with Series F Track.
WLL: 500 lbs./225 kg. Weight: .30 lb./0.14 kg.

40386-13
For use with Series F Track Canada.
WLL: 500 lbs./ 225 kg. Weight: .30 lb./0.14 kg.

40386-11
Series E and A Rope Tie Off Spring actuated fitting for use with Series E or Series A Track.
WLL: 1,333lbs./605 kg.
Weight: .40 lbs./0.18 kg.



49542-10
Series E and A Fitting w/ D-Ring.
WLL: 1,000 lbs./454 kg.
Weight: .34 lb./0.15 kg.

47772-12
Series E and A Track Fitting w/ Round Ring.
WLL: 1,000 lbs./454 kg.
Weight: .45 lb./0.20 kg.

50115-10
Heavy-Duty Series E and A Track Fitting w/ Round Ring. Heat treated. WLL: 2,000 lbs./908 kg.
Weight: .40 lbs./0.18 kg.

50115-11
Heavy-Duty Series E and A Track Fitting w/ D-Ring. Heat treated. WLL: 2,000 lbs./908 kg.
Weight: .40 lbs./0.18 kg.

TRUCK & TRAILER FITTINGS

Designed for low-profile mounting in trucks and trailers, the Recessed Pan Fitting is tensioned to reduce ring movement, but allows easy lifting. The Stake Pocket Anchor can be surface or flush mounted and accepts roll cart lock pins.



45545-15
With black trim collar.
WLL: 530 lbs./240 kg.
Weight: .30 lb./0.14 kg.



45849-13
Recessed Pan Fitting
WLL: 1,666 lbs./757 kg.
Weight: 1.20 lbs./0.55 kg.



49371-10
Stake Pocket Anchor. Conforms to USPS drawing B-13956. Black Lacquer Finish. Weight: 0.98 lb./0.44 kg.

TRANSMAT® FRICTION MAT

These durable rubber mats offer stability to any load and reduce risk of load shifting in box cars or intermodal transport.

- ▶ Coefficient of friction of 1.2 min
- ▶ Shore A hardness of 35-55 points
- ▶ Meets new minimum 1g loading regulations



49382-10 Sheet 30" x 42" 2mm thick

TENSION-LIMITING RATCHET ASSEMBLIES

No more overtightening

You can prevent damage caused by over-tightened ratchet buckles with the Tension-Limiting Ratchet Buckle. Ancra's innovative buckle will tighten to no more than 300 pounds of tension. It's enough force to secure the cargo, but not enough to damage your vehicle. Not even your strongest driver can apply too much force.

How it works

Once the strap is installed in the track, ratchet the strap normally. When proper tension is reached, the handle releases and no more tension can be applied. Even if you try, you can never go too tight.



Detents in the handle are designed to release at preset loads that will hold the cargo securely, but not damage the vehicle or the cargo.

PATENTED

10/821,987



Assemblies are available with Low Profile (49715-10, patented) or Heavy-Duty (49410-13, patented) long handle buckles. There are six Torque-Limiting Ratchet Straps available in lengths from 12 to 20 feet.



Series E Heavy-Duty Buckle Strap w/ Spring E Fitting
Heavy-duty 12,000 lbs. yellow latex treated polyester webbing.
WLL: 1,333 lbs./605 kg. Fixed End: 48-in.

Part No.	Strap Length	Weight
49021-30	12 ft.	4.00 lbs.
49021-31	16 ft.	4.25 lbs.
49021-32	20 ft.	4.50 lbs.



Series E Low Profile Buckle Strap w/ Spring E Fitting
Strong 6,000 lbs. polyester webbing.
WLL: 1,333 lbs./605 kg. Fixed End: 48-in.

Part No.	Strap Length	Weight
48672-33	12 ft.	2.50 lbs.
48672-34	16 ft.	2.65 lbs.
48672-35	20 ft.	2.80 lbs.

INTERIOR VAN SOLUTIONS

LOGISTIC STRAPS & ASSEMBLIES

Ancra logistic straps are available in cam buckle and ratchet buckle models with end hardware to suit your specific application. Made with strong polyester webbing, they are color coded to easily identify the length. The standard fixed end length for all straps is 48". Built on a reputation for dependability and strength, these strap assemblies promise the quality that comes with every product that bears the Ancra name.



CAM BUCKLE STRAP ASSEMBLIES

6,000 lb. Polyester Webbing (47200) with a Cam Buckle (40880-15). The adjustable end of the straps are captivated to prevent them from pulling out of the buckle and separating.

SERIES E STRAP ASSEMBLY Working Load Limit: 833 lbs./378 kg.



Series E Assembly with spring actuated end fitting



Part No.	Strap Length	Weight
40602-17	12 ft.	1.65 lbs.
40602-18	16 ft.	1.80 lbs.
40602-19	20 ft.	1.95 lbs.

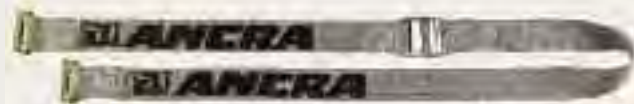

Series E Assembly with 3-piece end fitting

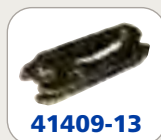

Part No.	Strap Length	Weight
40602-10	12 ft.	1.55 lbs.
40602-11	16 ft.	1.70 lbs.
40602-12	20 ft.	1.85 lbs.

SERIES F STRAP ASSEMBLY Working Load Limit: 500 lbs./225 kg.

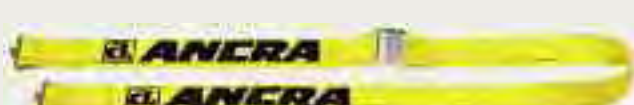

Part No.	Strap Length	Weight
40602-20	12 ft.	2.40 lbs.
40602-21	16 ft.	2.55 lbs.
40602-22	20 ft.	2.70 lbs.

SERIES F STRAP ASSEMBLY (CANADA) Working Load Limit: 500 lbs./225 kg.

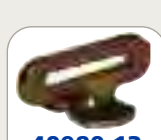

Part No.	Strap Length	Weight
40602-103	12 ft.	2.40 lbs.
40602-104	16 ft.	2.55 lbs.
40602-105	20 ft.	2.70 lbs.

For Canada

Please note: Ancra logistics straps come in three webbing colors, coded according to lengths. 12 ft. webbing is yellow, 16 ft. webbing is gray, 20 ft. webbing is blue. End fitting part numbers are shown for reference only.

WARNING:

Interior van straps should be inserted in track behind the front edge of the load and cinched tight.

CAM BUCKLE STRAP ASSEMBLIES

ELECTRONIC STRAP ASSEMBLY Working Load Limit: 833 lbs./378 kg. Fixed Ends: 7-in. & 48-in. 6,000 lbs. polyester webbing 47200 and cam buckle 40880-19. Fixed End: 48-in.



Part No.	Strap Length	Weight
49025-20	12 ft.	1.90 lbs.
49025-21	16 ft.	2.05 lbs.
49025-22	20 ft.	2.20 lbs.

An additional E fitting allows for increased adjustability for various applications.

PLATE TRAILER STRAPS 6,000 lbs. polyester webbing 47200 and cam buckle 40880-19.

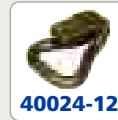

Part No.	Strap Length	Weight
48253-19	12 ft.	1.85 lbs.
48253-20	16 ft.	2.00 lbs.
48253-21	20 ft.	2.15 lbs.

Cam Buckle Strap w/ Wire Hook & Spring E Fitting
WLL: 833 lbs./378 kg.

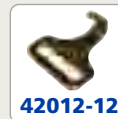

Part No.	Strap Length	Weight
48253-22	12ft.	2.00 lbs.
48253-23	16 ft.	2.15 lbs.
48253-24	20 ft.	2.30 lbs.

Cam Buckle Strap w/ F Hook & Spring E Fitting. Fixed End: 48-in.
WLL: 800 lbs./360 kg.



Part No.	Strap Length	Weight
40602-97	12ft.	1.50 lbs.
40602-98	16 ft.	1.65 lbs.
40602-99	20 ft.	1.80 lbs.

Cam Buckle Strap w/ Wire Hooks. Fixed End: 48-in.
WLL: 500 lbs./225 kg.

WARNING:

Interior van straps should be inserted in track behind the front edge of the load and cinched tight.

INTERIOR VAN SOLUTIONS

RATCHET BUCKLE STRAP ASSEMBLIES

RATCHET BUCKLE STRAPS Working Load Limit: 1,333 lbs./605 kg. Fixed End: 48-in.



Series E Ratchet Buckle Strap w/ 47608-21 Spring End Fitting

6,000 lb. polyester webbing 47200 and low profile ratchet buckle 44258-13 for durability and wear.

Part No.	Strap Length	Weight
48672-13	12 ft.	2.25 lbs.
48672-14	16 ft.	2.40 lbs.
48672-15	20 ft.	2.55 lbs.



Series E Heavy-Duty Ratchet Buckle Strap w/ 47608-21 Spring End Fitting
WLL: 1,333 lbs./605 kg. Fixed End: 48-in.

Heavy-duty 12,000 lb. yellow polyester webbing 41632-13 and standard handle ratchet buckle 44627-11 for durability and wear. All yellow straps.

Part No.	Strap Length	Weight
49021-20	12 ft.	3.50 lbs.
49021-21	16 ft.	3.75 lbs.
49021-22	20 ft.	4.00 lbs.

PLATE TRAILER STRAPS 6,000 lbs. polyester webbing 47200 and low profile ratchet buckle 44258-13.
Fixed End: 48-in.



Ratchet Buckle Strap w/ Wire Hook & Spring E Fitting
WLL: 833 lbs./378 kg.



Part No.	Strap Length	Weight
48253-13	12 ft.	2.50 lbs.
48253-14	16 ft.	2.65 lbs.
48253-15	20 ft.	2.80 lbs.



Ratchet Buckle Strap w/ F Hook & Spring E Fitting
WLL: 800 lbs./360 kg.

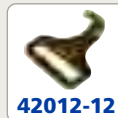

Part No.	Strap Length	Weight
48253-16	12 ft.	2.70 lbs.
48253-17	16 ft.	2.85 lbs.
48253-18	20 ft.	3.00 lbs.



Ratchet Buckle Strap w/ Wire Hooks
WLL: 500 lbs./225 kg.

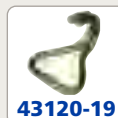

Part No.	Strap Length	Weight
48672-22	12 ft.	2.00 lbs.
48672-23	16 ft.	2.15 lbs.
48672-24	20 ft.	2.30 lbs.

WARNING:

Interior van straps should be inserted in track behind the front edge of the load and cinched tight.

TIE DOWN STRAPS & ASSEMBLIES

CUSTOM NETS



Ancra custom solutions promise quality and performance.

Designed for your particular application, Ancra custom nets offer retention support for various sized and shaped packages. Using strong 1" or 2" webbing, they're individually tailored to fit your loading condition, assuring maximum effectiveness in transporting a load securely.

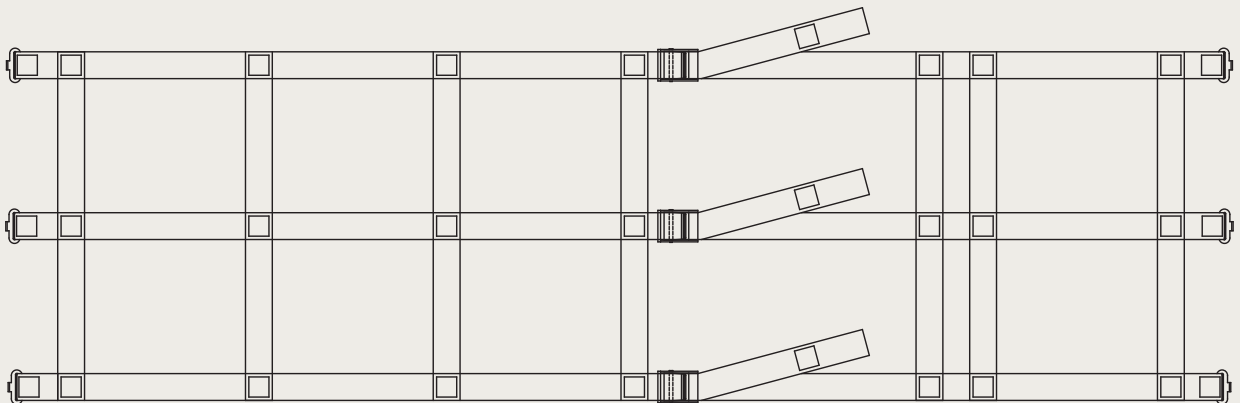

**FOR MORE INFORMATION ON CUSTOM APPLICATION CONTACT YOUR
ANCRA CUSTOMER SERVICE REPRESENTATIVE @ 1-800-929-2627**

NOTES

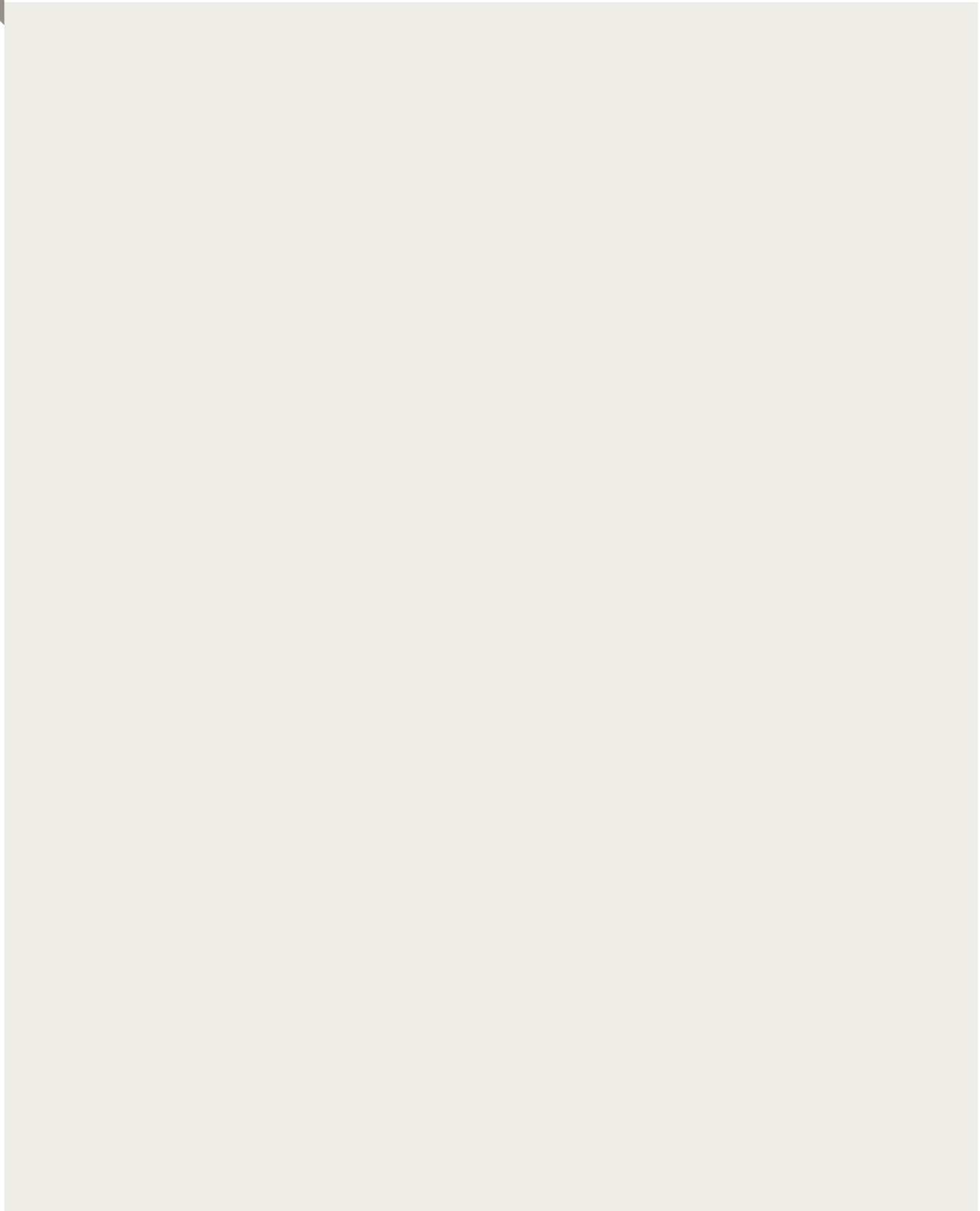

AUTO 'TRANSPORT' SOLUTIONS

Whether transporting a load of cars or someone's pride and joy, you depend on proven quality restraint products. Ancra designs and manufactures auto transport products, strap assemblies, harnesses and hardware to meet your most demanding requirements. We're committed to offering you the quality you demand.



AUTO 'TRANSPORT' SOLUTIONS

TIE DOWNS & ACCESSORIES

CAR HAULER RATCHET STRAPS WLL: 3,333 lbs./1,515 kg. using 41632-46 yellow latex treated polyester webbing and 47105-11 Short Wide Handle Ratchet Buckle. Available with 43120-13 Wire Hooks or 49914-11 Low Profile Swivel J Hooks.



50179-10

2" x 102" Ratchet Strap w/ Wire Hooks



50179-11

2" x 102" Ratchet Strap w/ Low Profile Swivel J Hook

AUTO HAULER WINCH STRAP



48487-24

2" x 140" Winch Strap w/ cleats
The auto tie down strap goes over the tire and utilizes three cleated rubber pads that mesh with the tread to keep the strap centered and secured.

SINGLE CLEAT

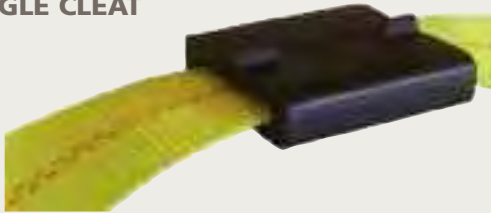

48485-10

Rubber tread cleat for Auto Hauler Winch Strap.
Used with 2-inch webbing to secure vehicle tire.
Length: 3.0-in. Width: 2.8-in.
Weight: .20 lbs./09 kg.

TIE DOWN W/ SNAP HOOKS Working Load Limit: 1,666 lbs./757 kg. using 41632-13 yellow latex treated polyester webbing, a 47105-11 Short Wide Handle Ratchet Buckle and 40084-14 Snap Hooks.



Ankra's tie downs feature yellow latex treated polyester webbing (41632-13) with Ratchet Buckle (47105-11) and Snap Hook (40084-14).

Part No.	Strap Length	Weight	Fixed End
49020-20	6 ft.	3.80 lbs./1.73 kg.	6 in.
49020-21	8 ft.	4.44 lbs./2.02 kg.	8 in.
49020-22	12 ft.	4.84 lbs./2.20 kg.	12 in.

TIE DOWNS & 'TRANSIT' STRAPS

ANTIQUE & RACE CAR TIE DOWNS



30AS33-BK

2" x 33" Black Axle Strap w/ sleeve. Individually display packaged. WLL: 3,300 lbs./1,498 kg.



500-C8-RD

2" x 8' Red Ratchet Strap w/ Twisted Snap Hooks. WLL: 3,300 lbs.

DOLLY STRAPS Ancra designs and manufactures a complete line of wheel straps for automobile-towing dollies. Three of the more popular designs are shown here. Call us about your specific requirements.



BASKET STRAP

45143-20

for tires 7"W x 20"H
Weight: 2.25 lbs./1.02 kg.
WLL: 1,666 lbs./755 kg.

45143-22

for tires 8"W x 24"H
Weight: 2.5 lbs./1.14 kg.
WLL: 1,666 lbs./755 kg.



WHEEL DOLLY STRAP

47934-11

2" x 86" with Round Ring
for tires 8"W x 22"H
Weight: 1.0 lbs./.46 kg.
WLL: 900 lbs./410 kg.



WHEEL DOLLY STRAP

47935-11

with S Hooks
for tires 10"W x 24"H
Weight: 1.5 lbs./.46 kg.
WLL: 800 lbs./360 kg.

47935-12

with Spring E Fittings
for tires 10"W x 24" H
Weight: 1.5 lbs./.46 kg.
WLL: 1,300 lbs./590 kg.

SERIES E TRANSIT STRAP W/ RTJ HOOKS



49023-20

6-foot Strap

49023-21

8-foot Strap

49023-22

12-foot Strap

Working Load Limit: 1,000 lbs./454 kg. Fixed End: 14"

Assembled with durable latex treated polyester webbing (41632-13) and Ratchet Buckle (47105-11). Fixed end features a heavy-duty Series E & A Track Fitting (47772-12), and the adjustable end features a Cluster Hook (45515-10) with R,T, and J Hooks.

AUTO 'TRANSPORT' SOLUTIONS

'TIE DOWNS & 'TRANSIT' STRAPS

ADJUSTABLE TIRE BONNETS



30ATB Adjustable Tire Bonnet

for 13" - 17" OEM Tires.
WLL: 3,333 lbs./1,515 kg.



30RT Double Adjustable Tire Bonnet

for 10" - 22" Wide Tires.
WLL: 3,333 lbs./1,515 kg.

LASHING WINCHES

The lashing winch with double hex drive can be bolted or welded to the trailer like a standard winch, yet offers the quick release and easy operation of a ratchet buckle.

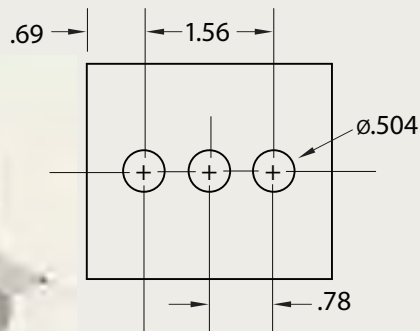

47640-31

With double hex drive and three mounting holes.
WLL: 3,333 lbs./ 1,515 kg.
Weight: 3.8 lbs./1.7 kg.



48496-11

With double hex drive, release latch, and single mounting hole.
WLL: 2,500 lbs./ 1,135 kg.
Weight: 2.2 lbs./1 kg.

LIFTING SOLUTIONS

Trust Ancra's slings for your lifting and rigging needs. Our durable polyester round slings and eye to eye web slings come in a full range of lengths and widths for your application.



LIFTING SOLUTIONS

GET A LIFT FROM ANCRA'S WEB SLINGS

Flexible and resistant to abrasion, Ancra's line of durable polyester round slings and polyester twisted eye to eye slings are built for strength and durability. Round slings are color-coded by width from 1" to 7". Eye to eye web slings are available in 1", 2", 3" and 4" web widths in single- and double-ply models. Custom sizes and models may be available. For details, contact Ancra Customer Service Department at 800-929-2627.

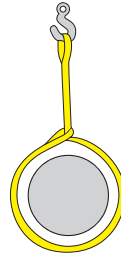

CHOKER



VERTICAL

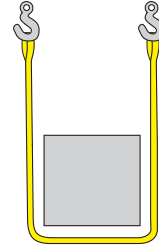

BASKET

ROUND SLINGS



LIFTING SLINGS — ROUND

Part No.	Description	Choker	Vertical	Basket
20-ENR1X3	1" x 3' Purple Endless Round Sling	2,100	2,600	5,200
20-ENR1X4	1" x 4' Purple Endless Round Sling	2,100	2,600	5,200
20-ENR1X6	1" x 6' Purple Endless Round Sling	2,100	2,600	5,200
20-ENR1X8	1" x 8' Purple Endless Round Sling	2,100	2,600	5,200
20-ENR1X12	1" x 12' Purple Endless Round Sling	2,100	2,600	5,200
20-ENR2X3	2" x 3' Green Endless Round Sling	4,200	5,300	10,600
20-ENR2X4	2" x 4' Green Endless Round Sling	4,200	5,300	10,600
20-ENR2X8	2" x 8' Green Endless Round Sling	4,200	5,300	10,600
20-ENR2X12	2" x 12' Green Endless Round Sling	4,200	5,300	10,600
20-ENR2X20	2" x 20' Green Endless Round Sling	4,200	5,300	10,600
20-ENR3X3	3" x 3' Yellow Endless Round Sling	6,700	8,400	16,800
20-ENR3X4	3" x 4' Yellow Endless Round Sling	6,700	8,400	16,800
20-ENR3X8	3" x 8' Yellow Endless Round Sling	6,700	8,400	16,800
20-ENR3X12	3" x 12' Yellow Endless Round Sling	6,700	8,400	16,800
20-ENR3X20	3" x 20' Yellow Endless Round Sling	6,700	8,400	16,800
20-ENR4X10	4" x 10' Tan Endless Round Sling	8,500	10,600	21,200
20-ENR4X16	4" x 16' Tan Endless Round Sling	8,500	10,600	21,200
20-ENR5X4	5" x 4' Red Endless Round Sling	10,600	13,200	24,400
20-ENR5X6	5" x 6' Red Endless Round Sling	10,600	13,200	24,400
20-ENR5X12	5" x 12' Red Endless Round Sling	10,600	13,200	24,400
20-ENR5X20	5" x 20' Red Endless Round Sling	10,600	13,200	24,400
20-ENR7X6	7" x 6' Blue Endless Round Sling	17,000	21,200	42,400

POLYESTER TWISTED EYE TO EYE WEB SLINGS

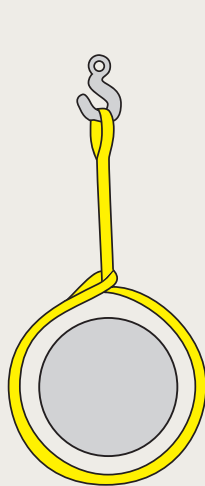

CHOKER



VERTICAL

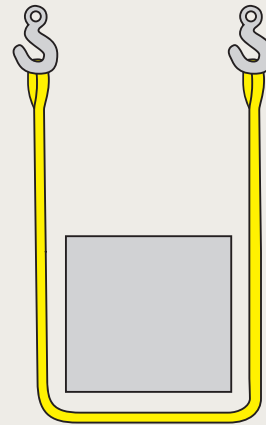

BASKET



- ▶ Light Weight & Economical
- ▶ 9,800 lbs. Polyester Webbing
- ▶ Single-Ply & Double-Ply Styles
- ▶ Industry Compliant Sewn In Warning Tags
- ▶ Reinforced Eyes
- ▶ Tapered Eyes on 2", 3", & 4" Widths

SINGLE-PLY 9,800 LB. TWISTED EYE TO EYE SLING

Part No.	Size	Choker	Vertical	Basket
20-EE1-9801X3	1" x 3'	1,250	1,600	3,200
20-EE1-9801X4	1" x 4'	1,250	1,600	3,200
20-EE1-9801X6	1" x 6'	1,250	1,600	3,200
20-EE1-9801X10	1" x 10'	1,250	1,600	3,200
20-EE1-9802X3	2" x 3'	2,500	3,200	6,400
20-EE1-9802X4	2" x 4'	2,500	3,200	6,400
20-EE1-9802X6	2" x 6'	2,500	3,200	6,400
20-EE1-9802X10	2" x 10'	2,500	3,200	6,400
20-EE1-9802X12	2" x 12'	2,500	3,200	6,400
20-EE1-9802X14	2" x 14'	2,500	3,200	6,400

POLYESTER TWISTED EYE TO EYE WEB SLINGS

DOUBLE-PLY 9,800 LB. TWISTED EYE TO EYE SLING

Part No.	Size	Choker	Vertical	Basket
20-EE2-9801X4	1" x 4'	2,500	3,200	6,400
20-EE2-9801X8	1" x 8'	2,500	3,200	6,400
20-EE2-9802X3	2" x 3'	5,000	6,400	12,800
20-EE2-9802X4	2" x 4'	5,000	6,400	12,800
20-EE2-9802X6	2" x 6'	5,000	6,400	12,800
20-EE2-9802X8	2" x 8'	5,000	6,400	12,800
20-EE2-9802X10	2" x 10'	5,000	6,400	12,800
20-EE2-9802X12	2" x 12'	5,000	6,400	12,800
20-EE2-9802X16	2" x 16'	5,000	6,400	12,800
20-EE2-9802X20	2" x 20'	5,000	6,400	12,800
20-EE2-9802X30	2" x 30'	5,000	6,400	12,800
20-EE2-9803X10	3" x 10'	6,900	8,600	17,200
20-EE2-9803X12	3" x 12'	6,900	8,600	17,200
20-EE2-9803X16	3" x 16'	6,900	8,600	17,200
20-EE2-9803X20	3" x 20'	6,900	8,600	17,200
20-EE2-9804X6	4" x 6'	9,200	11,500	23,000
20-EE2-9804X8	4" x 8'	9,200	11,500	23,000
20-EE2-9804X10	4" x 10'	9,200	11,500	23,000
20-EE2-9804X12	4" x 12'	9,200	11,500	23,000
20-EE2-9804X16	4" x 16'	9,200	11,500	23,000
20-EE2-9804X20	4" x 20'	9,200	11,500	23,000

WARNING:

Please read and comply with all warnings on labels and packaging. Failure to do so may result in loss of load, serious property damage, and/or personal injury!

DO NOT exceed the rated capacity shown on the package and label attached to the sling. For examples of out-of-service criteria, please see page 74.

For Operating and Inspection Manuals for synthetic Web Slings, see the Web Sling and Tie Down Association Publication WSTDA-WS-2.

For Operating and Inspection Manuals for polyester Round Slings, see the Web Slings and Tie Down Association Publication WSTDA-RS-2.

UTILITY TIE DOWNS

Ankra offers high quality restraint products for both commercial truckers and consumers. For transporting motorcycles, ATVs, household furnishings or equipment, our utility strap assemblies are made of high strength steel components and durable materials. Look to Ancra for years of trouble free use.



UTILITY TIE DOWNS

UTILITY TIE DOWNS

Ancra Utility Tie Downs are versatile and reliable for securing a wide range of light to medium duty cargo. Made of high-strength steel and abrasion-resistant webbing, they're quick and easy to use for secure performance in recreational, light industrial, and agricultural applications.

MINI RATCHET STRAP



Ratchet strap with Wire Hooks and floating D-Ring for use together or separately. Fixed End: 23"
Individually display packaged.

- 43887-10** 1" x 16' Weight: 1.56 lbs./71 kg.
- 43887-11** 1" x 20' Weight: 1.69 lbs./77 kg.
WLL: 1,000 lbs./454 kg.

ANCRA LASH WITH RATCHET BUCKLE STRAP



- 44557-10**
15' long endless multipurpose Ratchet strap.
WLL: 500 lbs./227 kg.
Weight: .84 lb./38 kg.

HEAVY-DUTY RATCHET STRAP ASSEMBLY



- 44340-11**
1" x 10' Ratchet strap with Wire Hooks for multipurpose use.
WLL: 1,000 lbs./454 kg.
Weight: 1.60 lbs./73 kg.

ANCRA RED UTILITY STRAP



- 41048-10**
1" x 5.5' Cam buckle strap with vinyl-coated S Hooks.
Fixed End: 6-in.
WLL: 400 lbs./181 kg.
Weight: 1.60 lbs./73 kg.
- 41048-23**
1" x 13' Cam buckle strap with vinyl-coated S Hooks.
Fixed End: 30-in.
WLL: 400 lbs./181 kg.
Weight: 1.78 lbs./81 kg.

RATCHETING TIE DOWNS



- 49368-10** 1" x 15' 4-pack
1" red Ratchet strap with vinyl-coated S Hooks secures cargo, equipment and household furnishings.
Weight: 4.7 lbs./2.14 kg.
WLL: 266 lbs./121 kg.

CAM BUCKLE TIE DOWNS



- 49368-11** 1" x 6' 4-pack
1" black Cam strap with scratch-resistant vinyl-coated S Hooks. A simple way to secure your possessions.
Weight: 3.7 lbs./1.69 kg.
WLL: 266 lbs./121 kg.

RATCHETING & CAM BUCKLE TIE DOWNS



- 49368-12** Combo Pack
Contains two each 1" multipurpose Ratchet and Cam Buckle tie downs with scratch-resistant vinyl coating.
Weight: 4.2 lbs./1.91 kg.
WLL: 266 lbs./121 kg.

CAM BUCKLE TIE DOWNS



- 95001** 1" x 8' 2-pack
1" Cam strap with vinyl-coated S Hooks. Packaged in an interactive package.
Weight: 1.85 lbs./84 kg.
WLL: 400 lbs./180 kg.

MULTI-PACK CONSUMER TIE DOWNS

RATCHETING TIE DOWNS



95002 1" x 10' 2-pack
1" black Ratchet straps with vinyl-coated S Hooks in an interactive package.
Weight: 2.25 lbs./1.0 kg.
WLL: 550 lbs./250 kg.

RETRACTABLE RATCHETING TIE DOWNS



95003 1" x 6' 2-pack
1" black Retractable Ratchet straps with scratch-resistant vinyl-coated S Hooks in an interactive package.
Weight: 3.20 lbs./1.45 kg.
WLL: 500 lbs./227 kg.

CAM BUCKLE TIE DOWNS



95004 1" x 8' 4-pack
1" red Cam straps with scratch-resistant vinyl-coated S Hooks in an interactive package.
Weight: 3.8 lbs./1.72 kg.
WLL: 400 lbs./180 kg.

RATCHETING TIE DOWNS



95005 1" x 10' 4-pack
1" black Ratchet straps with vinyl-coated S Hooks in an interactive package.
Weight: 4.6 lbs./2.1 kg.
WLL: 550 lbs./250 kg.

RATCHETING & CAM BUCKLE TIE DOWNS



95006 Combo Pack
Contains two each 1" multipurpose 10' Ratchet straps and 8' Cam Buckle tie downs. All have scratch-resistant vinyl-coated S Hooks and are in an interactive package.
Weight: 5.20 lbs./1.90 kg.
Ratchet Strap WLL: 550 lbs./250 kg.
Cam Strap WLL: 400 lbs./180 kg.

RATCHETING TIE DOWNS



95007 1" x 12' Endless Loop, 2-pack, 1" Ratchet straps in an interactive package.
Weight: 1.75 lbs./.79 kg.
WLL: 550 lbs./250 kg.

TRACKSTAR MOTORCYCLE WHEELCHOCK



49603-10
Quick Connect to aircraft style L track. Fits tire widths from 3.5" to 5.5". Comes complete with mounting kit.
Weight: 7.0 lbs./3.18 kg.

TRACKSTAR ACCESSORY MOUNTING KIT



49288-10
TrackStar Accessory Mounting Kit (8" L track & hardware) for installation in a second vehicle.

UTILITY TIE DOWNS

PICKUP TRUCK CARGO NETS



SHORT BED PICKUPS

50199-10

For short beds - 72" W x 80" L

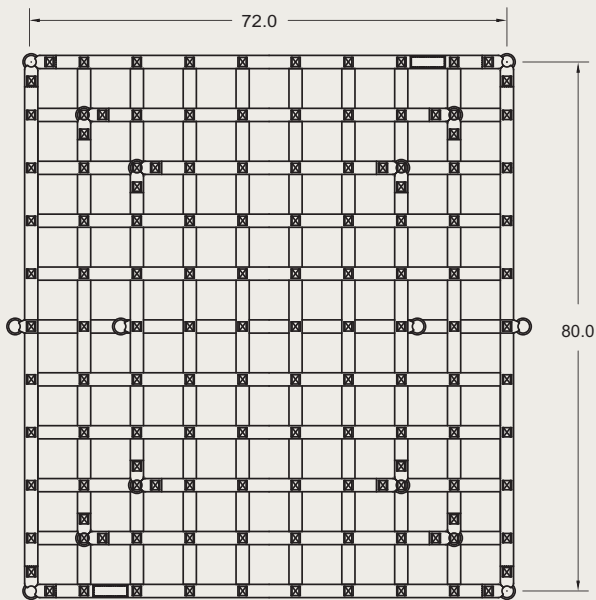

LONG BED PICKUPS

50199-11

For standard beds - 72" W x 96" L

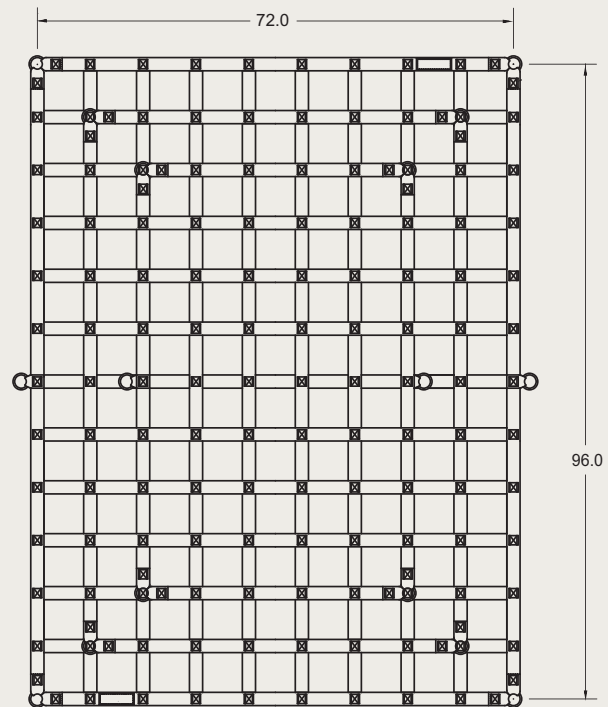

D-Rings and Connectors are spaced to accommodate various heights of loads. Each net comes with six (6), 1-1/4" x 5' long straps with a die cast cam buckle. Each strap has vinyl-coated S hooks with wire keepers to prevent them from disengaging.

Net openings: 6.0"
WLL: 1,200 lbs./540 kg.

GENERAL HARDWARE & WEBBING

We make them tough. Buckles, hooks, rings, track fittings and attachment hardware are made from high-strength steel. Webbing is abrasion-resistant, a trademark of Ancra quality. Standard or custom, these products are the core of Ancra's first-rate reputation.

- Quality materials and solid steel construction ensures long life
- Positive locking feature on tensioning hardware for security
- Wide assortment of hardware and webbing to suit your application
- Protective coatings for improved corrosion resistance



INSTRUCTIONS: Before use, please read the instructions carefully. The instructions are printed on the back of the product.

1. Before use, please read the instructions carefully. The instructions are printed on the back of the product.

2. Before use, please read the instructions carefully. The instructions are printed on the back of the product.

3. Before use, please read the instructions carefully. The instructions are printed on the back of the product.

4. Before use, please read the instructions carefully. The instructions are printed on the back of the product.

5. Before use, please read the instructions carefully. The instructions are printed on the back of the product.

Part No.	Description	Material	Quantity
101	Buckle	Steel	1
102	Hook	Steel	1
103	Ring	Steel	1
104	Track fitting	Steel	1
105	Attachment hardware	Steel	1

GENERAL HARDWARE & WEBBING

ANCRA BUCKLE QUALITY –

The standard of the industry, Ankra's durable buckles are designed with a unique latch and fast release cam that reduces sprocket wear. Our broad line of steel Ratchet, Cam and Overcenter Buckles meets your wide ranging load requirements, offering quick and easy release and secure locking tension. The popular and often copied long, wide-handle ratchet is a classic example of Ankra innovation. Our locking mechanism guards against vibration release, the 1.5-inch longer handle increases leverage by 20%, and the wider frame and latch design allows more hand room for easier operation. What began as innovation, is now the standard of the industry.



RATCHET BUCKLES

Ankra Ratchet Buckles are available in a wide range of models for 1-inch to 4-inch webbing widths. The buckles have a locking latch that engages when the handle is closed and prevents the inadvertent release of tension when under load. The handle cross pin interlocks with the frame, maintaining a low profile design. A removable rear bolt on most models allows for in field conversion or repair.

1-INCH

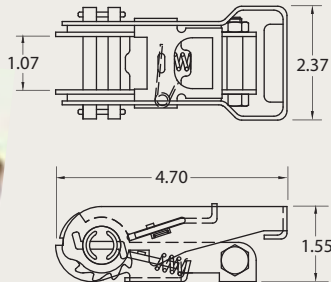

43320-32

WLL: 1,466 lbs./666 kg.
Weight: .76 lb./34 kg.

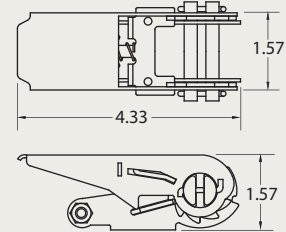

48770-10

Low profile, black powder coat
WLL: 500 lbs./227 kg.
Weight: .50 lb./22 kg.

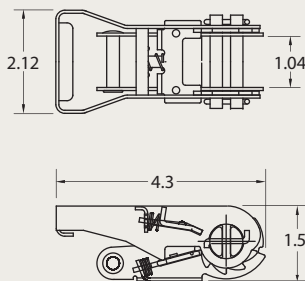

44232-10

WLL: 400 lbs./181 kg.
Weight: .50 lb./22 kg.

1-3/4 INCH

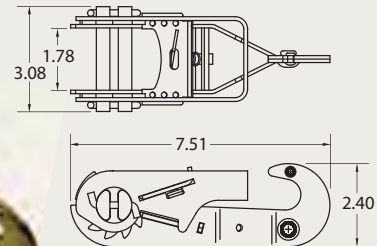

41808-14

1-3/4 in. Hook End
WLL: 2,000 lbs./908 kg.
Weight: 1.65 lbs./75 kg.

RATCHET BUCKLES

2-INCH

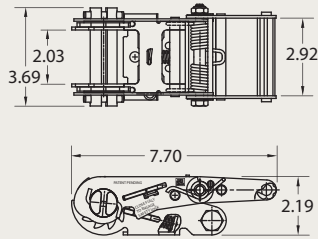

49410-13

Long Wide Handle Torque Limiting. Reduces trailer damage by limiting overzealous tensioning. See page 55.
WLL: 3,666 lbs./1,663 kg.
Weight: 2.7 lbs./1.23 kg.

PATENT PENDING

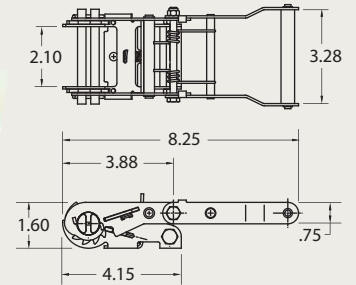

49715-10

Low Profile Torque Limiting. Reduces trailer damage by limiting overzealous tensioning. See page 55.
WLL: 1,500 lbs./681 kg.
Weight: 1.56 lbs./.71 kg.

PATENTED

No. 10/821,987

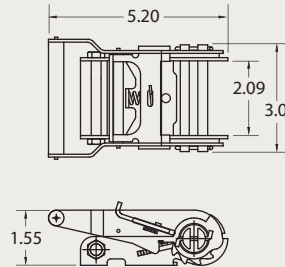

44258-13

Low Profile. Nut & bolt packaged separately.
WLL: 1,500 lbs./680 kg.
Weight: 1.30 lbs./.59 kg.

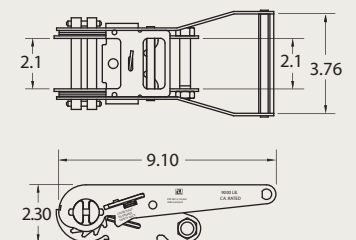

44587-10

Long Wide Handle
WLL: 3,666 lbs./1,666 kg.
Weight: 2.3 lbs./1.05 kg.

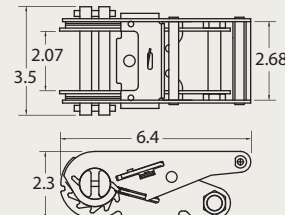

44627-11

Standard Handle
WLL: 3,333 lbs./1,515 kg.
Weight: 2.10 lbs./.95 kg.

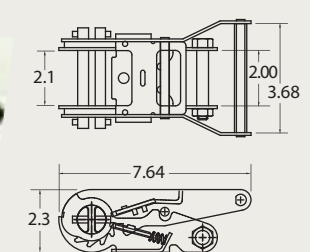

47105-11

Short Wide Handle
WLL: 3,666 lbs./1,666 kg.
Weight: 2.20 lbs./1.0 kg.



50037-10

Long Wide Handle Web Keeper Ratchet Buckle
WLL: 3,666 lbs./1,666 kg.
Weight: 2.35 lbs./1.07 kg.

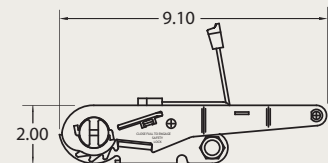
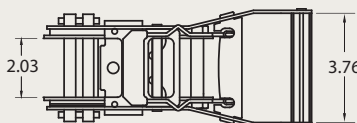

GENERAL HARDWARE & WEBBING

RATCHET BUCKLES

3-INCH

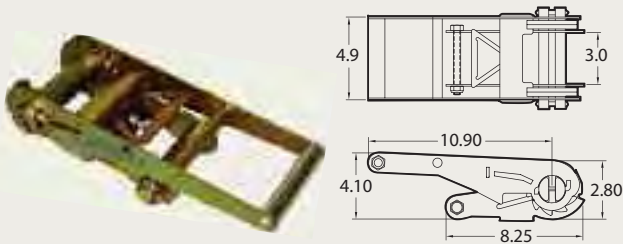

48965-10

WLL: 7,333 lbs./3,333 kg.

Weight: 7.0 lbs./3.18 kg.

4-INCH

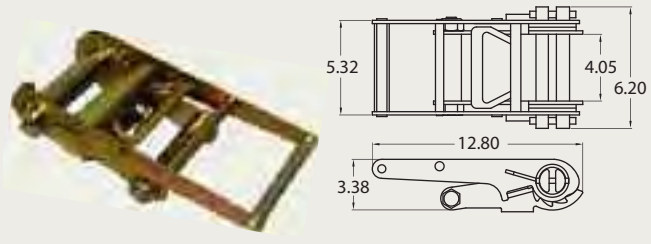

49349-10

WLL: 8,000 lbs./3,636 kg.

Weight: 8.0 lbs./3.63 kg.

OVERCENTER BUCKLES

Ankra Overcenter Buckles have one-piece steel frame construction. Designed for simple and easy operation. When attached to the strap, the webbing provides a pad between the buckle and the cargo.

1-INCH

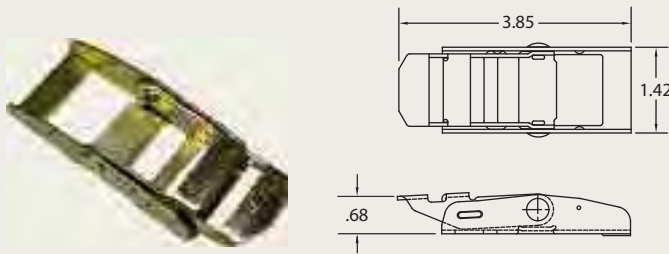

42816-18

WLL: 600 lbs./272 kg.

Weight: .15 lb./0.06 kg.

1 3/4-INCH

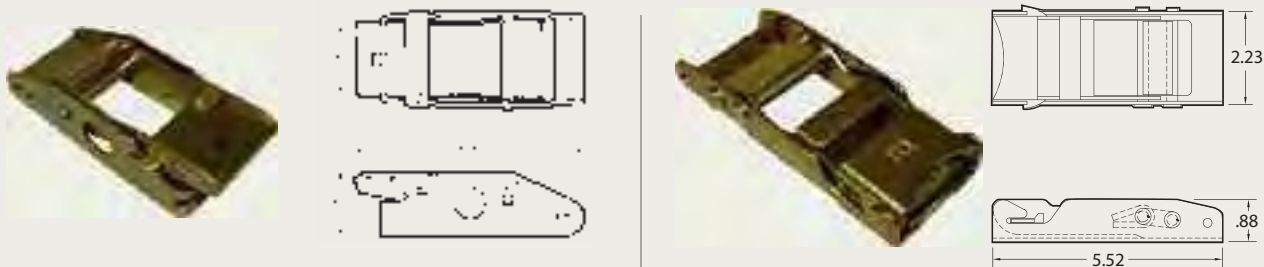

44639-12

WLL: 1,666 lbs./757 kg.

Weight: 1.20 lbs./0.54 kg.

47800-10

WLL: 1,666 lbs./757 kg.

Weight: .70 lb./0.31 kg.

DID YOU KNOW?

In addition to the trucking industry, Ankra buckles are used in specialty markets that include aircraft, marine, automotive, material handling and military applications.

In each case, material specifications have been modified to give optimum performance for their specific use.

CAM BUCKLES

A one-piece frame design lengthens the service life of Ankra Cam Buckles. Quick and easy operation consists of simply pulling the handhold to tension and depressing the cam lever to release.

1-INCH

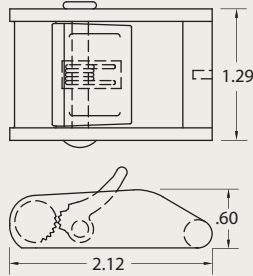

41030-12

WLL: 166 lbs./75 kg.
Weight: .13 lb./0.06 kg.

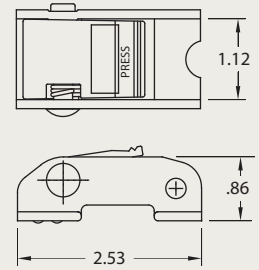

42195-11

WLL: 500 lbs./227 kg.
Weight: .25 lb./0.11 kg.

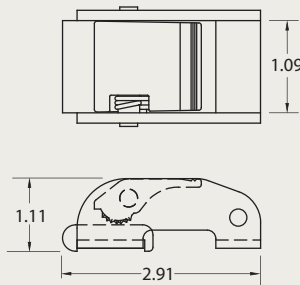

40880-22

WLL: 600 lbs./272 kg.
Weight: .40 lb./0.18 kg.

2-INCH

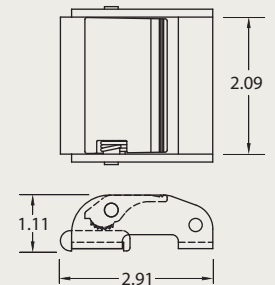

40880-15

WLL: 833 lbs./378 kg.
Weight: .69 lb./0.31 kg.

ROLLER BUCKLE

A simple slide bar adjuster buckle for light duty applications.

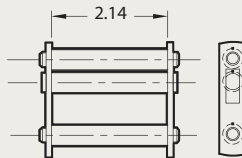

41645-10 Roller Buckle

WLL: 500 lbs./227 kg.
Weight: .20 lb./0.10 kg.

3-BAR SLIDE ADJUSTER

This adjuster is designed to be used for adjustment of strap lengths only, not for tensioning.

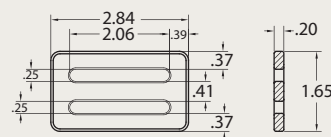

49834-10 3-Bar Slide Adjuster

WLL: 1,000 lbs./454 kg.
Weight: .30 lb./0.14 kg.

GENERAL HARDWARE & WEBBING

ATTACHMENT HARDWARE

Ankra hooks, rings and fittings are made to last. With heat treating and corrosion resistant plating or vinyl-coating, this quality line of attachment hardware is strong and durable.

WIRE HOOKS

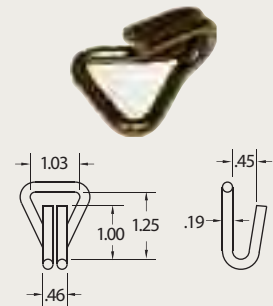

40316-12

1-inch Narrow Hook
WLL: 166 lbs./75 kg.
Weight: .10 lb./05 kg.

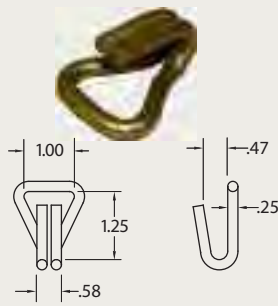

40024-10

1-inch Narrow Hook
WLL: 1,000 lbs./454 kg.
Weight: .10 lb./05 kg.

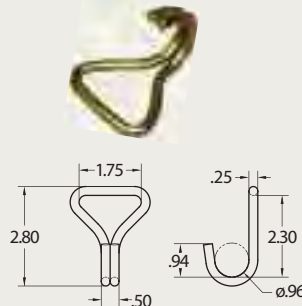

43120-19

1 3/4-inch Narrow Hook
WLL: 500 lbs./227 kg.
Weight: .17 lb./08 kg.

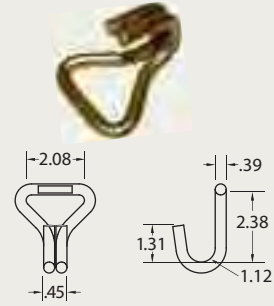

43120-11

2-inch Narrow Hook
WLL: 1,666 lbs./757 kg.
Weight: .39 lb./18 kg.

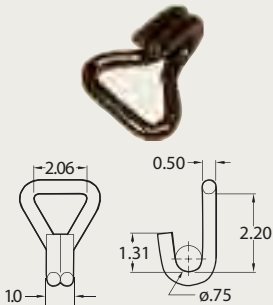

43120-13

2-inch Narrow Hook
WLL: 3,333 lbs./1,575 kg.
Weight: .62 lb./28 kg.

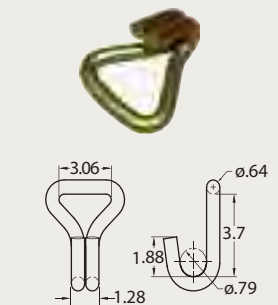

43120-20

3-inch Narrow Hook
WLL: 7,333 lbs./3,333 kg.
Weight: 1.39 lbs./63 kg.

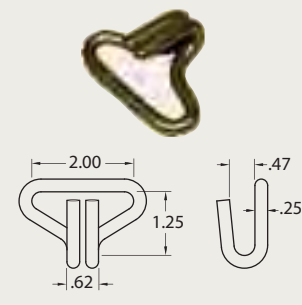

40024-12

2-inch Narrow Hook
WLL: 833 lbs./378 kg.
Weight: .10 lb./05 kg.

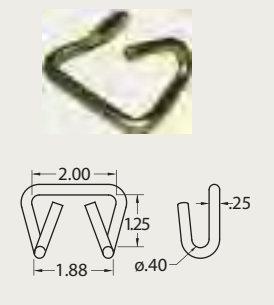

40023-12

2-inch Wide Hook
WLL: 833 lbs./378 kg.
Weight: .12 lb./06 kg.

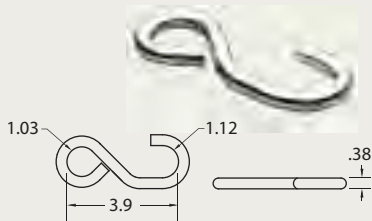

41313-12

Zinc-plated S Hook
WLL: 400 lbs./181 kg.
Weight: .28 lbs./13 kg.

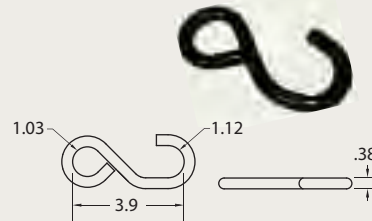

41313-13

1-inch Vinyl S Hook
WLL: 400 lbs./181 kg.
Weight: .29 lb./13 kg.

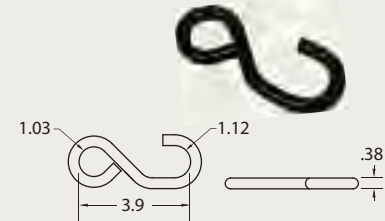

41313-19

1-inch Vinyl S Hook Heat Treated
WLL: 600 lbs./272 kg.
Weight: .30 lb./14 kg.

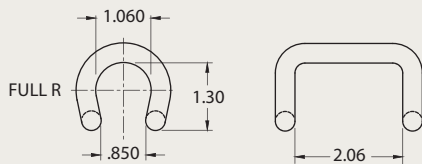

45228-10

Rave Hook
WLL: 1,167 lb./530 kg.
Weight: .29 lb./13 kg.

ATTACHMENT HARDWARE

FLAT HOOKS

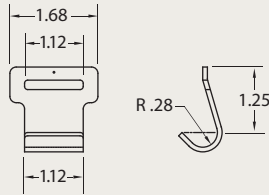

43546-10
1-inch Gutter Hook
WLL: 250 lbs./113 kg.
Weight: .05 lb./02 kg.

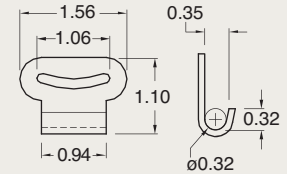

40065-10
1-inch Plated Flat Hook
WLL: 333 lbs./151 kg.
Weight: .04 lb./02 kg.

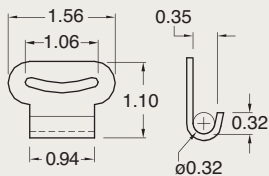

40065-12
1-inch Vinyl Flat Hook
WLL: 333 lbs./151 kg.
Weight: .05 lb./02 kg.

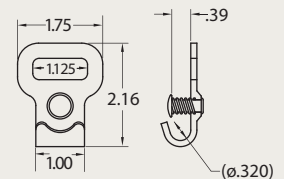

40044-10
1-inch Flat Hook with Keeper
WLL: 1,166 lbs./530 kg.
Weight: .68 lb./31 kg.

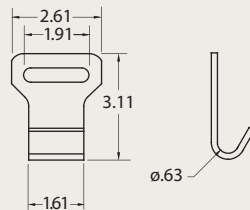

43099-10
2-inch Flat Hook
WLL: 1,666 lbs./757 kg.
Weight: .40 lb./18 kg.

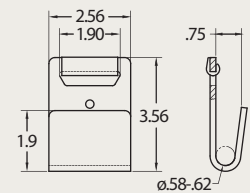

40891-18
2-inch Flat Hook
WLL: 3,333 lbs./1,515 kg.
Weight: .68 lb./31 kg.

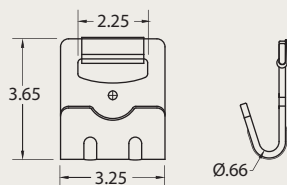

41766-18
3-inch Flat Hook
WLL: 5,400 lbs./2,450 kg.
Weight: .98 lb./45 kg.

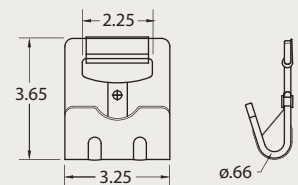

41766-19
3-inch Flat Hook with Keeper
WLL: 5,400 lbs./2,450 kg.
Weight: 1.03/47 kg.

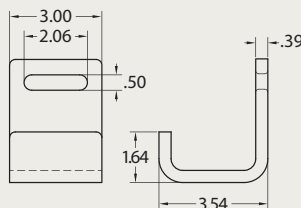

48968-11
2-inch Container Hook
WLL: 5,400 lbs./2,450 kg.
Weight: 2.0 lbs./91 kg.

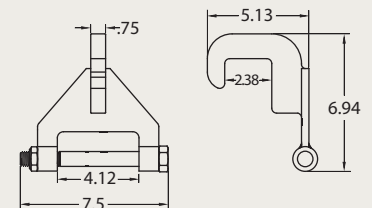

49770-10
4-inch Heavy-Duty Waste Hook
WLL: 5,400 lbs./2,454 kg.
Weight: 5.0 lbs./2.27 kg.

GENERAL HARDWARE & WEBBING

ATTACHMENT HARDWARE

SNAP HOOKS

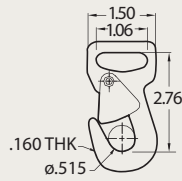

43044-10

1-inch Snap Hook
WLL: 1,666 lbs./757 kg.
Weight: .20 lb./.09 kg.

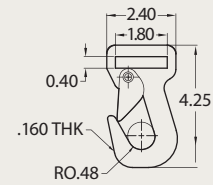

40084-14

2-inch Snap Hook
WLL: 2,766 lbs./1,255 kg.
Weight: .34 lb./.15 kg.

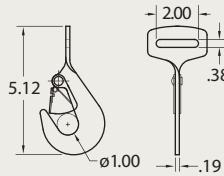

40758-11

2-inch Snap Hook w/ Satin Black Finish. Twisted Version
WLL: 3,333 lbs./1,515 kg.
Weight: .59 lb./.27 kg.

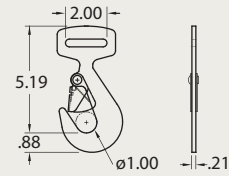

40758-13

2-inch Snap Hook w/ Satin Black Finish
WLL: 3,333 lbs./1,515 kg.
Weight: .59 lb./.27 kg.

RINGS

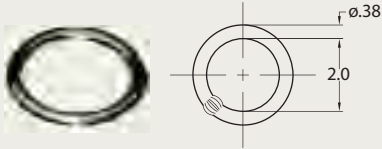

47944-10

Round Ring
WLL: 900 lbs./409 kg.
Weight: .25 lbs./.11 kg.

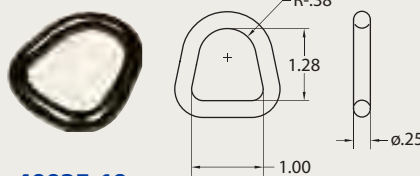

40025-10

1-inch D-Ring
WLL: 1,666 lbs./757 kg.
Weight: .05 lb./.02 kg.

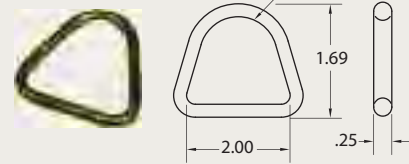

40025-12

2-inch D-Ring
WLL: 1,666 lbs./757 kg.
Weight: .09 lb./.04 kg.

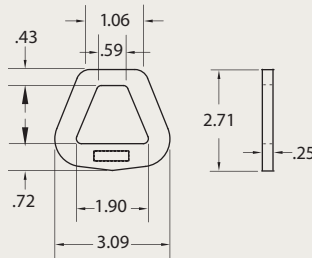

40978-11

2-inch Delta Ring
WLL: 3,333 lbs./1,515 kg.
Weight: .28 lb./.13 kg.

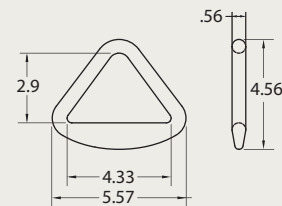

41631-12

4-inch Delta Ring
WLL: 6,666 lbs./3,030 kg.
Weight: 1.30 lbs./.59 kg.

PRODUCT FEATURES

- + ANCRAs RUST-RESISTANT, HIGH QUALITY ATTACHMENT HARDWARE IS MADE TO LAST.
- + OUR PRODUCTS AND COMPONENTS ARE FULLY TESTED TO MEET OUR EXACTING STANDARDS.

ATTACHMENT HARDWARE

BOLT PLATES

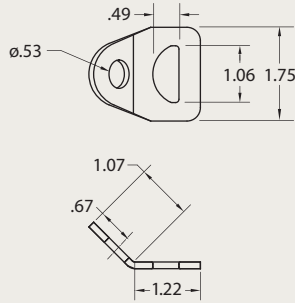

49917-10 1", 45 degree
Heat treated, Zinc Plated Gold Chromate Finish.
WLL: 1,000 lbs./450 kg.
Weight: .10 lbs./05 kg.

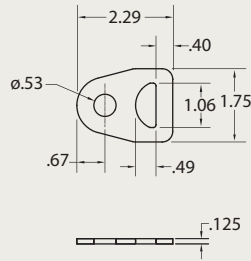

49917-11 1", Flat
Heat treated, Zinc Plated Gold Chromate Finish.
WLL: 1,000 lbs./450 kg.
Weight: .10 lbs./05 kg.

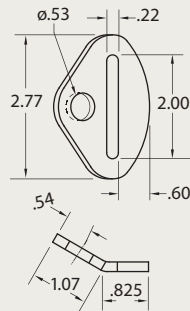

48904-10 2", 30 degree
Heat treated, Zinc Plated Clear Chromate Finish.
WLL: 1,000 lbs./450 kg.
Weight: .14 lbs./07 kg.

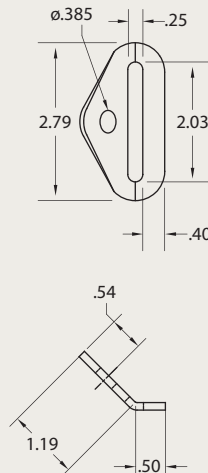

49968-10 2", 45 degree
Heat treated, Chrome Plated Finish.
WLL: 1,000 lbs./450 kg.
Weight: .10 lbs./05 kg.

OUR COMMITMENT TO
QUALITY IS NEVER ENDING



*All Ankra products and
components are fully tested to
meet our exacting standards.*

GENERAL HARDWARE & WEBBING

ATTACHMENT HARDWARE

Designed to fit securely into Ankra Track, sturdy Ankra Track Fittings are easy to use and long wearing.

TRACK FITTINGS

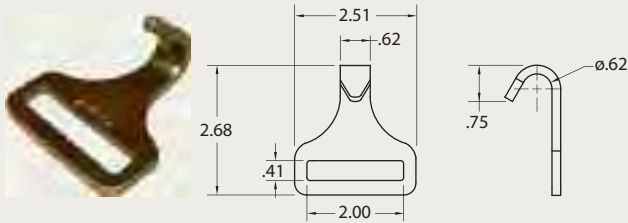

42012-12

Series F Heavy-Duty Track Hook
WLL: 800 lbs./363 kg.
Weight: .20 lb./.09 kg.

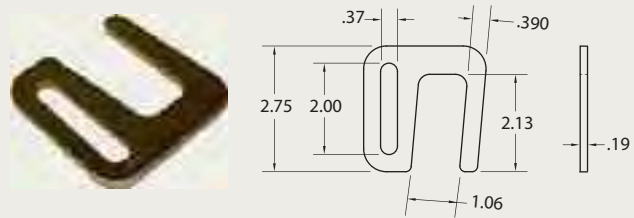

41325-10

Slat Hook. For use with Attachment Rails (Wooden Slats).
WLL: 1,000 lbs./454 kg.
Weight: .23 lb./.10 kg.

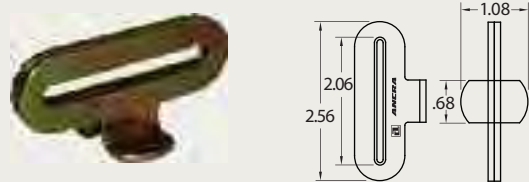

40980-11

Series F Track Fitting
WLL: 500 lbs./225 kg.
Weight: .60 lb./.27 kg.

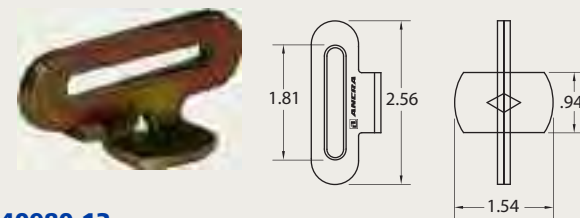

40980-13

For 1" hole diameter track (Canada).
WLL: 500 lbs./225 kg.
Weight: .60 lb./.27 kg.

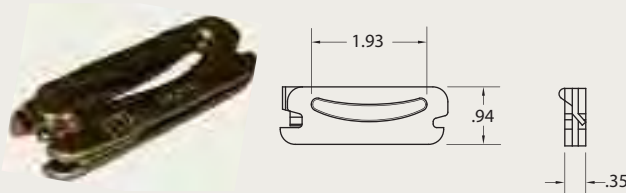

41409-13

Series E & A 3-Piece Track Fitting
WLL: 1,000 lbs./454 kg.
Weight: .20 lb./.09 kg.

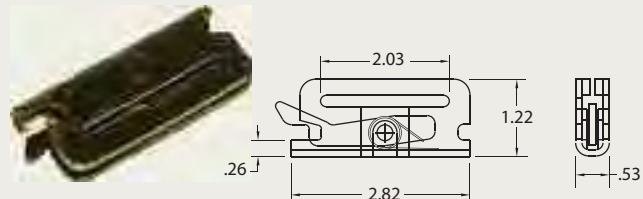

47608-21

Series E & A Track Spring Fitting
WLL: 1,333 lbs./605 kg. in 12-ga. track,
WLL: 1,500 lbs./680 kg. in 11-ga. track.
Weight: .22 lb./.10 kg.

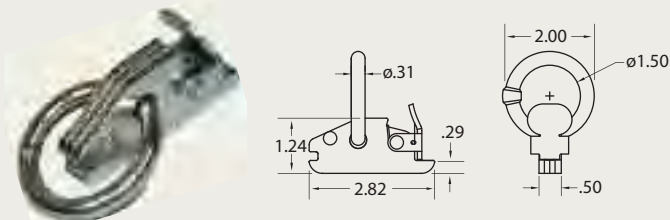

50115-10

Heavy-Duty Series E and A Track Fitting w/ Round Ring. Heat treated.
WLL: 2,000 lbs./900 kg.
Weight: .40 lbs./.18 kg.

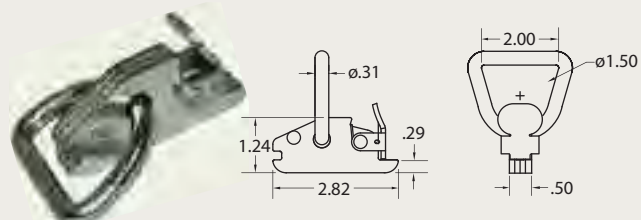

50115-11

Heavy-Duty Series E and A Track Fitting w/ D-Ring. Heat treated.
WLL: 2,000 lbs./900 kg.
Weight: .40 lbs./.18 kg.

ATTACHMENT HARDWARE

TRACK FITTINGS

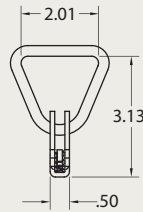
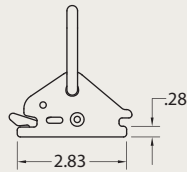

49542-10

Series E & A Fitting w/ D-Ring
WLL: 1,000 lbs./454 kg.
Weight: .32 lb./15 kg.

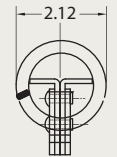
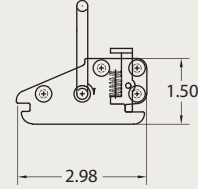

47772-12

Series E & A Track Fitting
WLL: 1,000 lbs./454 kg.
Weight: .45 lb./20 kg.

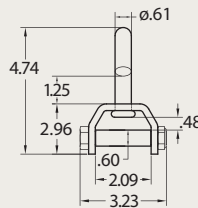
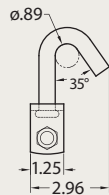

49914-10

Swivel J Idler Hook
Heat treated w/ gold zinc finish.
WLL: 3,333 lbs./1,515 kg.
Weight: 1.12 lbs./51 kg.

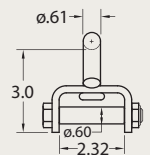
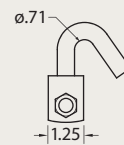

49914-11

Low Profile Swivel J Idler Hook
Heat treated w/ gold zinc finish.
WLL: 3,333 lbs./1,515 kg.
Weight: .98 lb./44 kg.

CHAIN ATTACHMENTS

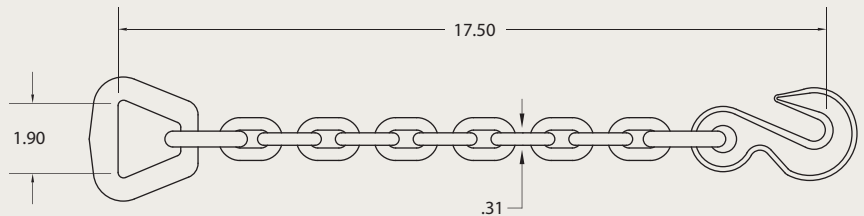

43366-21

Chain Anchor with Delta Ring for 2" Strap Assemblies. 5/16", G43 Chain and Grab Hook, gold zinc plated.
WLL: 3,330 lbs./1,510 kg.
Weight: 2.55 lbs./1.16 kg.

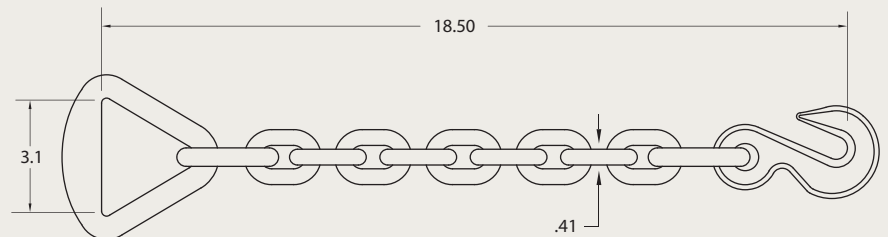

43366-14

Chain Anchor with Delta Ring for 3" & 4" Strap Assemblies. 3/8", G43 Chain and 3/8" G70 Grab Hook, gold zinc plated.
WLL: 5,400 lbs./2,450 kg.
Weight: 3.4 lbs./1.54 kg.

GENERAL HARDWARE & WEBBING

ATTACHMENT HARDWARE

Forged from high strength alloy steel, Ancra clevis hooks are made for Grade 70 chain. Sized from 1/4" to 1/2", the chain hooks are strength tested and heat treated for safety and durability. Meets Department of Transportation requirements.

Forged steel hook, Zinc Plated Gold Chromate finish. Individually polybagged.

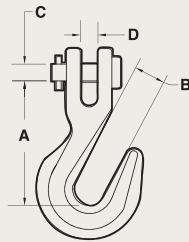

45946-12

1/4-in. Clevis Hook WLL: 3,150 lbs./1,430 kg.
Weight: .40 lbs./.18 kg.

45946-10

5/16-in. Clevis Hook WLL: 4,700 lbs./2,130 kg.
Weight: .85 lbs./.39 kg.

45946-11

3/8-in. Clevis Hook WLL: 6,600 lbs./2,990 kg.
Weight: 1.10 lbs./.5 kg.

45946-13

1/2-in. Clevis Hook WLL: 11,300 lbs./5,130 kg.
Weight: 2.10 lbs./1.04 kg.

DIMENSION TABLE

	A	B	C	D
45946-12	2.00	.40	.38	.36
45946-10	2.30	.43	.38	.38
45946-11	2.70	.50	.48	.44
45946-13	3.20	.66	.63	.75

Grade 70 Clevis Hooks with Keeper

Forged steel hook with Keeper, Zinc Plated Gold Chromate finish. Individually polybagged, 30 per box.

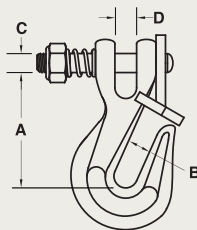

50091-31

5/16-in. Clevis Hook w/ Keeper WLL: 4,700 lbs./2,130 kg.
Weight: .9 lbs./.41 kg.

50091-38

3/8-in. Clevis Hook w/ Keeper WLL: 6,600 lbs./2,990 kg.
Weight: 1.3 lbs./.59 kg.

50091-50

1/2-in. Clevis Hook w/ Keeper WLL: 11,300 lbs./5,130 kg.
Weight: 2.2 lbs./1.00 kg.

DIMENSION TABLE

	A	B	C	D
50091-31	2.3	.43	.38	.42
50091-38	2.7	.56	.48	.48
50091-50	3.0	.61	.63	.57

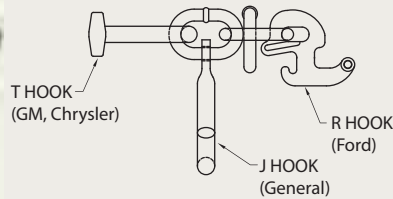

45515-10

RTJ Cluster Hook
WLL: 3,900 lbs./1,770 kg.
Weight: 2.65 lbs./1.20 kg.

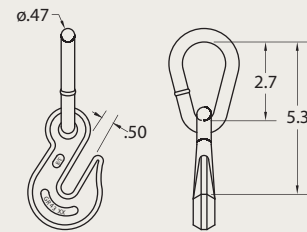

43365-12

Grab Hook Assembly
Heat Treated, Gold Zinc plated finish.
WLL: 5,400 lbs./2,450 kg.
Weight: 1.60 lbs./.73 kg.

CHAIN HARDWARE

We offer a wide selection of chain hardware for popular applications — from anchor shackles with screw pins and clevis pin models to Quick Links in various sizes. Corrosion resistant, gold zinc plated Grade 70 Twin Clevis and Slip Hooks come in a wide range of sizes, with and without safety latches. All are individually packaged.

Screw Pin Anchor Shackle — Galvanized and individually polybagged

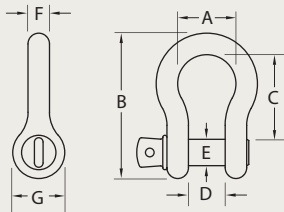

PART NUMBER	SIZE	WEIGHT	WLL				
50013-31	5/16-in.	.18 lbs./08 kg.	1,500 lbs./681 kg.				
50013-38	3/8-in.	.30 lbs./14 kg.	2,000 lbs./900 kg.				
50013-44	7/16-in.	.49 lbs./22 kg.	3,000 lbs./1,362 kg.				
50013-50	1/2-in.	.74 lbs./34 kg.	4,000 lbs./1,816 kg.				
50013-63	5/8-in.	1.44 lbs./65 kg.	6,500 lbs./2,951 kg.				
50013-75	3/4-in.	2.16 lbs./98 kg.	9,500 lbs./4,313 kg.				
	A	B	C	D	E	F	G
50013-31	.81	2.25	1.25	.53	Ø3/8	Ø.31	1.00
50013-38	.94	2.61	1.44	.66	Ø7/16	Ø.38	1.13
50013-44	1.06	3.01	1.69	.72	Ø1/2	Ø.44	1.25
50013-50	1.19	3.34	1.88	.81	Ø5/8	Ø.50	1.38
50013-63	1.50	4.04	2.41	1.06	Ø3/4	Ø.63	1.88
50013-75	1.75	5.04	2.84	1.25	Ø7/8	Ø.75	2.13

Clevis Pin Anchor Shackle — Galvanized and individually polybagged

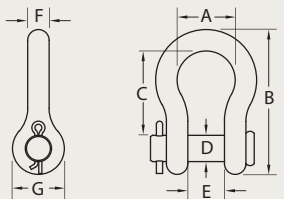

PART NUMBER	SIZE	WEIGHT	WLL				
50014-50	1/2-in.	.74 lbs./34 kg.	4,000 lbs./1,816 kg.				
50014-63	5/8-in.	1.44 lbs./65 kg.	6,500 lbs./2,951 kg.				
	A	B	C	D	E	F	G
50014-50	1.19	3.39	1.88	Ø5/8	.81	Ø.50	1.38
50014-63	1.50	4.17	2.41	Ø3/4	1.06	Ø.63	1.88

Quick Links — Zinc Plated Clear Chromate finish and individually polybagged

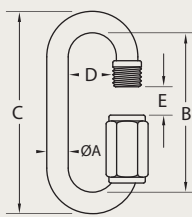

PART NUMBER	SIZE	WEIGHT	WLL		
50016-25	1/4-in.	.062 lbs./028 kg.	880 lbs./399 kg.		
50016-31	5/16-in.	.154 lbs./07 kg.	1,760 lbs./799 kg.		
50016-38	3/8-in.	.198 lbs./90kg.	2,200 lbs./998 kg.		
	A	B	C	D	E
50016-25	.235	1.85	2.31	.51	.32
50016-31	.313	2.32	2.95	.65	.41
50016-38	.350	2.54	3.22	.67	.43

GENERAL HARDWARE & WEBBING

CHAIN HARDWARE

Twin Clevis G70 — Forged steel with Zinc Plated Gold Chromate finish and individually polybagged.

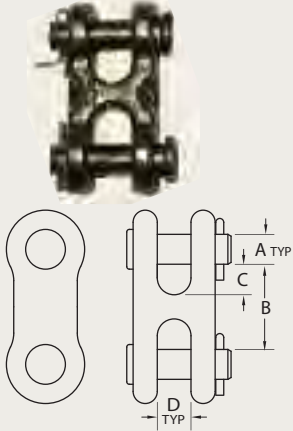

PART NUMBER	SIZE	WEIGHT	WLL	
50017-10	1/4-in. – 5/16-in.	.30 lbs./14 kg.	4,700 lbs./2,130 kg.	
50017-11	3/8-in.	.40 lbs./18 kg.	6,600 lbs./2,990 kg.	
50017-12	7/16-in – 1/2-in.	.98 lbs./44 kg.	11,300 lbs./5,130 kg.	
	A	B	C	D
50017-10	.38	1.18	.43	.47
50017-11	.47	1.34	.48	.53
50017-12	.56	1.75	.63	.65

Slip Hooks G70 without Safety Latch — Forged steel with Zinc Plated Gold Chromate finish and individually polybagged.

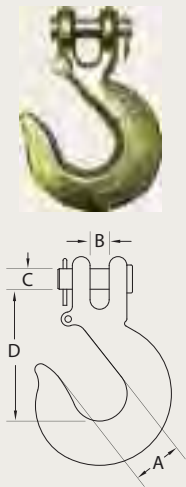

PART NUMBER	SIZE	WEIGHT	WLL	
50019-10	1/4-in.	.44 lbs./20 kg.	3,150 lbs./1,430 kg.	
50019-11	5/16-in.	.75 lbs./34 kg.	4,700 lbs./2,130 kg.	
50019-12	3/8-in.	1.13 lbs./51 kg.	6,600 lbs./2,990 kg.	
50019-13	1/2-in.	2.75 lbs./1.25 kg.	11,300 lbs./5,130 kg.	
	A	B	C	D
50019-10	.94	.44	.38	2.44
50019-11	1.06	.41	.44	2.72
50019-12	1.31	.59	.47	3.25
50019-13	1.75	.75	.63	4.00

Slip Hooks G70 with Safety Latch — Forged steel with Zinc Plated Gold Chromate finish and individually polybagged.



PART NUMBER	SIZE	WEIGHT	WLL	
50019-20	1/4-in.	.59 lbs./27 kg.	3,150 lbs./1,430 kg.	
50019-21	5/16-in.	.92 lbs./42 kg.	4,700 lbs./2,130 kg.	
50019-22	3/8-in.	1.32 lbs./60 kg.	6,600 lbs./2,990 kg.	
50019-23	1/2-in.	2.90 lbs./1.32 kg.	11,300 lbs./5,130 kg.	
	A	B	C	D
50019-20	.94	.44	.38	2.44
50019-21	1.06	.41	.44	2.72
50019-22	1.31	.59	.47	3.25
50019-23	1.75	.75	.63	4.00

WEBBING

Along with exceptional quality, Ancra's broad line of webbing gives you a range of choices to match your application. Custom made according to our strict specifications, Ancra webbing is treated for extra strength and durability, offering additional flexibility and ease of use.



Width in./mm.		Breaking Strength Capacity		Type	Standard Color	Part No.
in.	mm.	lbs.	kg.			
1.00	25	4,500	2,045	Nylon	■ Red ■ Blue ■ Black	41820-10-RL 41820-14-RL 41820-15-RL
2.00	50	6,000	2,727	Polyester	■ Yellow	47200-61-BULK-CUT
2.00	50	6,000	2,727	Polyester	■ Gray	47200-60-BULK-CUT
2.00	50	6,000	2,727	Polyester	■ Blue ■ Red	47200-62-BULK-CUT 47200-64-BULK-CUT
2.00	50	12,000	5,454	Polyester, Latex Treated	■ Blue ■ Yellow ■ Red	41632-26-BULK-CUT 41632-31-BULK-CUT 41632-19-BULK-CUT
3.00	75	18,000	8,181	Polyester, Latex Treated	■ Yellow ■ Blue	41632-17-BULK-CUT 41632-24-BULK-CUT
4.00	100	20,000	9,090	Polyester, Latex Treated	■ Gray ■ Blue ■ Red ■ Yellow ■ Green	43797-18-BULK-CUT 43797-19-BULK-CUT 43797-23-BULK-CUT 43797-36-RL 43797-34-BULK-CUT

Webbing will have a longer life if stored in a dry, dark location. Continuous exposure to ultra-violet light can degrade the strength of synthetic webbing.

WEBBING CHARACTERISTICS



Nylon's elongation characteristics make it suitable for slings and tow straps, but less desirable for heavy-duty tie downs. It displays good UV, abrasion, alkaline resistance and color fast properties. Polyester is well suited for webbing because of its low cost, high-strength, and resistance to abrasion. It also withstands acid environments and resists elongation in high moisture applications. Its durability and abrasion resistance can be increased even further with coatings of latex or other materials. Call Customer Service Department at 800-929-2627 for specific details and color availability.

SPECIALTY PRODUCTS

AIRCRAFT STYLE SEAT / LOGISTIC TRACK

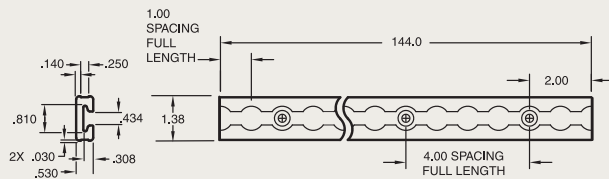

40467-33-144

12' long. Weight: 7.0 lbs./3.2 kg.

HEAVY-DUTY BEVELED AIRCRAFT STYLE TRACK

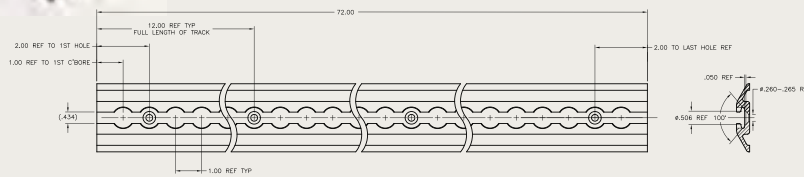

50193-30-72.00

72" long. Weight: 4.30 lbs./1.95 kg.

SINGLE STUD TRACK FITTING

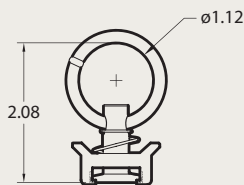

40340-27 Aluminum Retainer
WLL: 1,333 lbs./605 kg. Vertical.
Weight: .10 lb./04 kg.

**Load rating varies with the angle of pull.*

DOUBLE STUD TRACK FITTING WITH ROUND RING

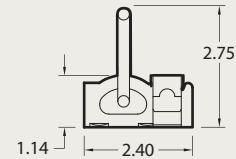

47556-11

WLL: 1,666 lbs./757 kg.
Weight: .35 lb./16 kg.

For installation manual: Fasteners for Aircraft and Lift-A-Deck Track,
go to our website at <http://link.ankra.com/?L=6>, or just scan the QR Code.



Dedicated to You

Ankra designs and manufactures a full spectrum of restraints and hardware to meet your wide ranging needs. Our specialty items represent our ongoing mission to provide the right solutions for a changing industry. If you can't find a specific product in this catalog, or if you have a particular requirement that calls for a unique solution, give us a call. Our customization capabilities can be your assurance that you have Ankra quality for all your cargo restraint applications.



SPECIALTY PRODUCTS

12 & 20 TON BOTTLE JACKS



49880-12

12 Ton Bottle Jack w/ 3-Pc. Handle
Weight: 16.7 lb./7.58 kg.

- 24,000 lb./10,900 kg. rated capacity
- Compact 7.5-inch height
- Lifts 4.1 inches
- Adjustable to screw height of 2.6 inches
- Extends to 14 inches
- Complies with ASME PALD-2005 standard



49880-20

20 Ton Bottle Jack w/ 3-Pc. Handle
Weight: 24.9 lb./11.30 kg.

- 40,000 lb./18,180 kg. rated capacity
- Compact 7.5-inch height
- Lifts 3.9 inches
- Adjustable screw height of 2.6 inches
- Extends to 14 inches
- Complies with ASME PALD-2005 standard



GENERAL HARDWARE & WEBBING

MERCHANDISING AIDS

Contact our Customer Service Department to obtain.



Floor Stickers

Sold Here Sticker



Outdoor Banner



Indoor Banner



X-TREME_CC



Ergo_Bar_CC



Product_CC

Goldline_CC



Catalog-220-LAM

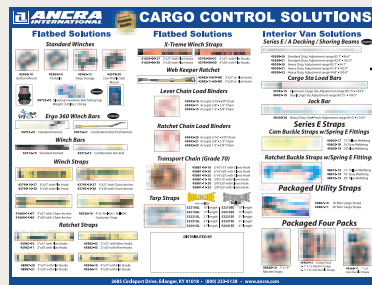

Wall Chart

PortaWinch
49714-10



Cargo Bar Display
49458-10



Part No.

Description

BANNERS
OUTDOOR_BANNER
SOLD_HERE_STICKER
FLOOR_STICKERS

INDOOR BANNER, 4' x 18" w/ 4 grommets
OUTDOOR BANNER, 6' x 3' w/ 4 grommets
SOLD HERE WINDOW STICKER, 5" x 9-1/2"
TIE DOWN ZONE FLOOR GRAPHICS, 11" x 17"

CATALOG-220-LAM
49458-10
49714-10
WALL_CHART

CATALOG 220 LAMINATED
CARGO BAR DISPLAY
PORTA WINCH / PORTA ANCHOR IN STORE DISPLAY
CARGO CONTROL WALL CHART - 18" x 24"

ERGO_BAR_CC
X-TREME_CC
PRODUCT_CC
GOLDLINE_CC

ERGO BAR COUNTER CARD, 8-1/2" x 11"
X-TREME PRODUCT COUNTER CARD, 8-1/2" x 11"
CARGO CONTROL COUNTER CARD, 8-1/2" x 11"
GOLDLINE TARP TIES COUNTER CARD, 8-1/2" x 11"

LAD_TRAINING_DVD
LAD_SALES_DVD
GLIDELOCK_DVD

LIFT A DECK II TRAINING VIDEO (DVD)
LIFT A DECK II SALES VIDEO (DVD)
GLIDELOCK VIDEO (DVD)

GENERAL INFORMATION

Ancra's cargo restraint products are backed by outstanding service:

Customer Assistance:

- Bar coding on standard products
- Technical training manuals
- CD ROM marketing material assistance
- Point of purchase selling aids

Engineering and Technical Services:

- Product development
- Design and drawing check – 3D solids
- Product testing and evaluation

Quality Assurance:

- Product inspection
- Vendor qualifications
- Internal and supplier audits
- Product and lot testing

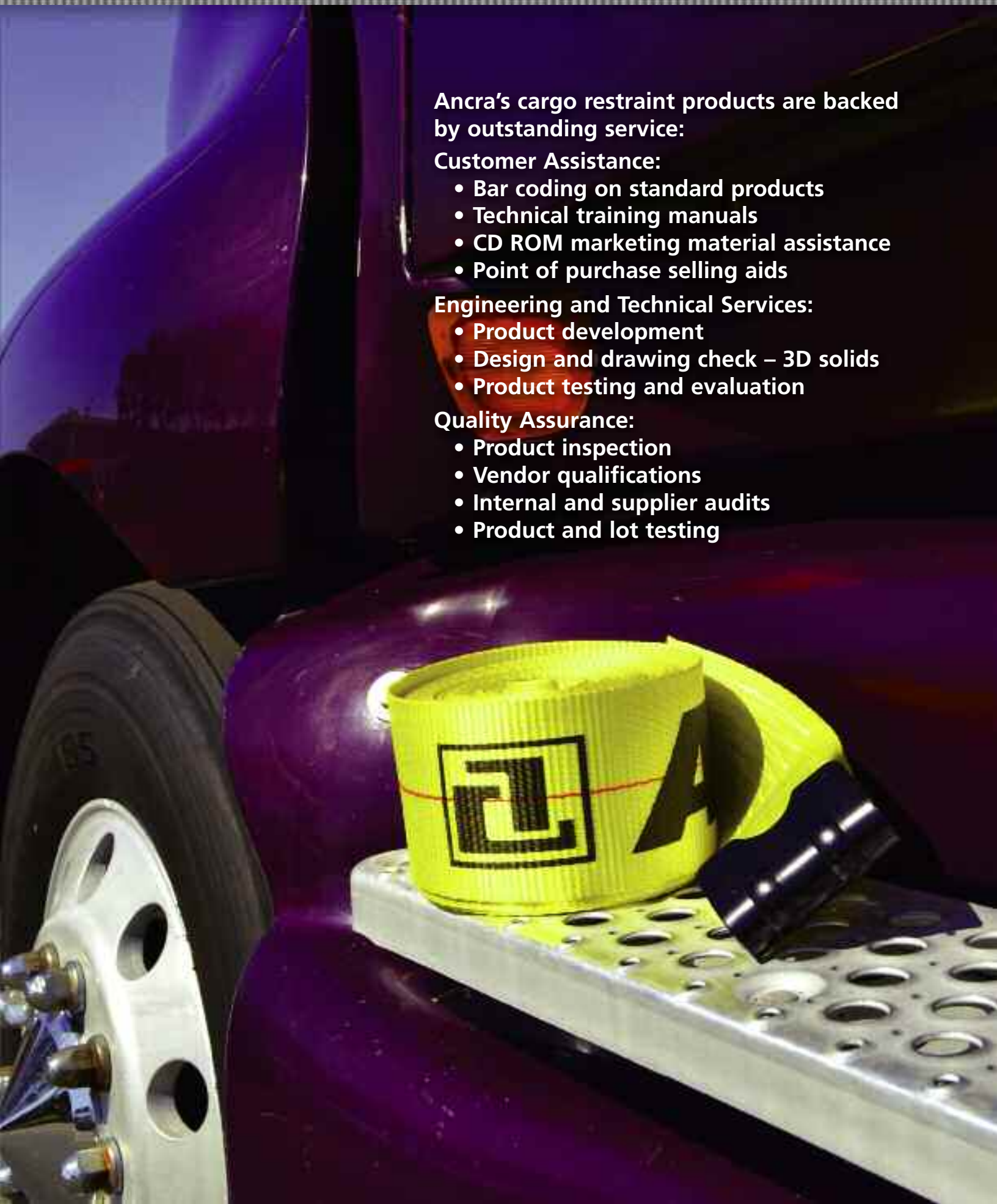

SPECIFICATIONS

Working Load Limit (WLL)

The maximum load a component or assembly should be subjected to during routine use.

Rated Load Capacity

Ratings are generally established and/or regulated by industry or legislative standards and may vary from industry to industry. The working load limit rating (WLL) is established by Federal DOT Standards at 1/3 of the Breaking Strength of the assembly.

Note: All strengths referenced in this brochure unless noted, are based on a straight pull application.

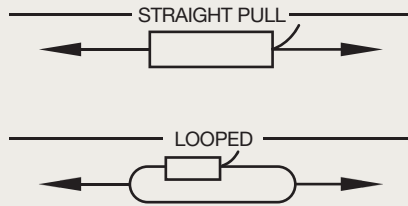

IMPORTANT NOTE:

It is the owner's and user's responsibility to determine suitability of a product for any particular use. Check all applicable industry, trade association, federal, state and local regulations. Read all operating instructions and warnings carefully.

All ratings shown in this catalog are based on the product being new, and used in normal environmental conditions. Special consideration must be given to item selection when unusual conditions can be expected. Particular caution should be exercised to avoid exposing the product to sharp edges, acids, alkalis and temperatures above 194°F.

Products are subjected to age, wear, and deterioration, all of which cause a reduction in the product's working load limit. We recommend that all products be regularly inspected. Any worn, deformed, misused or overloaded products should be replaced.

CAUTION! The component with the lowest working load capacity in the entire restraint system will determine its strength. Each component of the entire system plays an important part in restraining cargo. It is important that tie downs be attached to anchorage that are of sufficient strength to properly secure the load. For example, if one anchors a standard web binder assembly with a rated WLL of 5,000 lbs. to a device with a WLL of 1,000 lbs., then that system is only as good as the anchorage and would be limited to a 1,000 lbs. capacity WLL.

The purpose of this catalog is to assist our customers in the selection of cargo restraint products suitable for their specific applications. Because we continuously strive to offer new and improved products, part numbers and specifications are subject to change without notice. Please contact your Ancra Representative or our Customer Service Department for any new information.

WARRANTY

All Ancra International LLC products, unless otherwise indicated are warranted to be free from defect in material or workmanship for a period of six (6) months from date of shipment. During this period, Ancra International LLC will, at its option repair or replace without charge any products or part thereof found to be defective in material or workmanship. This warranty does not extend to any product which has been subject to misuse, abuse, negligence, accident, alteration or repair.

All Ancra International LLC SilverCap OverDrive product, unless otherwise indicated are warranted to be free from defect in material or workmanship for a period of twelve (12) months from date of shipment. During this period, Ancra International LLC will, at its option repair or replace without charge any product or part thereof found to be defective in material or workmanship. This warranty does not extend to any product which has been subject to misuse, abuse, negligence, accident, alteration or repair.

Ancra International LLC LAD II & or RAR systems, unless otherwise indicated are warranted to be free from defect in material or workmanship for a period of twenty (24) months from date of shipment. During this period, Ancra International LLC will, at its option repair or replace without charge any product or part thereof found to be defective in material or workmanship. This warranty does not extend to any product which has been subject to misuse, abuse, negligence, accident, alteration or repair.

Defective products must be returned to Ancra International LLC within the above period, transportation prepaid. Ancra will bear the cost of return transportation. Contact Customer Service for details.

THIS WARRANTY IS IN LIEU OF ALL OTHER WARRANTIES EXPRESSED OR IMPLIED INCLUDING BUT NOT LIMITED TO ANY IMPLIED WARRANTY OF MERCHANTABILITY OR FITNESS FOR ANY PARTICULAR PURPOSE. IN NO EVENT WILL ANCRA INTERNATIONAL LLC BE LIABLE FOR SPECIAL, INDIRECT OR CONSEQUENTIAL DAMAGES OR LOSS OF VEHICLE, CARGO OR PROFITS.

INDUSTRY STANDARDS

Ankra has provided the following information as a service to our customers. This information is intended to promote the safe and informed sales and use of our products.

ALL CARGO RESTRAINTS, INCLUDING SYNTHETIC WEB TIE DOWNS SHALL BE USED IN ACCORDANCE WITH ALL STATE, FEDERAL, PROVINCIAL, LOCAL AND INDUSTRY REGULATIONS, AS APPLICABLE.

U.S. Department of Transportation regulations subchapter B-Motor Carrier Safety Regulations, 49 CFR, Part 393, Paragraph 393.102(b) requires that: "The aggregate working load limit of the tie down assemblies used to secure an article against movement in any direction must be at least 1/2 times the weight of that article."

It is the owner's and user's responsibility to determine suitability of a product for any particular use. All strap assemblies or systems are as strong as their weakest component, including the point of attachment.

An example using this regulation follows:

- Determine the number of synthetic web tie downs required when using the Working Load Limit (WLL) value marked on the synthetic web tie down assembly.
- Weight of article being secured is 24,000 LB (10,910 KG).
- Working Load Limit of the 3-inch synthetic web tie down is 4,000 LB (1,820 kg) as marked on the label.
- Required Aggregate WLL
 $1/2 \times 24,000 \text{ LB (Article Weight)} = 12,000 \text{ LB (5,455 KG)}$
- Minimum number of tie downs
 $12,000 \text{ LB} \div 4,000 \text{ LB (WLL of tie down)} = 3 \text{ tie downs}$

In this example, a minimum of 3 synthetic web tie downs are required to secure the article, based only on the weight of the article.

Some factors to be considered when determining the number and location of synthetic web tie downs, as specified by applicable regulations are:

- Article weight
- Configuration of load to be secured (pipe, coil, equipment, stacking, etc.)
- Number of tiers
- Length of load to be secured
- WLL of synthetic web tie downs
- Stakes, blocking and bracing
- Tension in the synthetic tie down shall never exceed the WLL strength rating of anchorage.
- Any other factors that may affect safe securement of the load during normal and emergency conditions.

Operating Guidelines

This section provides recommended guidelines for the use, care, and inspection of synthetic web tie downs.

Use

- Inspect tie downs before each use, see Out-Of-Service Criteria.
- Synthetic web tie down assemblies shall not be loaded in excess of their Working Load Limit (WLL).

- Synthetic web tie downs shall be attached to provide control of load and positioned in accordance with applicable regulations.
- Synthetic web tie down assemblies shall not be dragged on floor, ground, or over an abrasive surface.
- Synthetic web tie downs shall not be tied in knots, or joined by knotting.
- Synthetic web tie downs shall not be pulled from under loads if the load is resting on the tie down.
- Synthetic web tie downs shall always be protected from being cut by sharp corners, sharp edges, protrusions or abrasive surfaces.
- The opening in fittings shall have the required shape and size to insure that the fitting will sit properly in the vehicle anchorage or other attachments. If the anchorage is inadequate to support the rating of the synthetic web tie down assembly, then the load rating will be limited to the strength of the anchorage.
- Synthetic web tie downs shall not be used for lifting or towing. This includes raising, lowering and suspending.
- Before operating any tie down assembly, the user shall secure his footing to prevent slipping or falling.
- In freezing temperatures caution shall be exercised when operating frozen tie down assemblies.
- A minimum of two (2) wraps of webbing shall be on the winch or ratchet buckle mandrel. Caution: Excessive wraps of webbing on the mandrel will reduce the working load limit of the winch or ratchet buckle.

When tightening or loosening winches, always maintain a firm grip on the winch bar. Never release a winch bar without checking the pawl to ensure that it is fully engaged between ratchet teeth. Releasing a winch bar without the pawl being properly engaged can cause serious injury to the user or bystanders. The use of a slip resistant handle winch bar specifically designed to tighten or loosen winches is recommended. Only winch bars designed to be used with winches shall be used to tension and release the tie down.

"Cheater Bars" ("extenders") shall not be used with winch bars.

The user shall stand clear (to one side) of the winch bar handle during operation, in case the winch bar slips. The tip of the winch bar shall be inserted through both holes in the end cap to prevent the winch bar from "slipping out" and overloading the tip and end cap.

Synthetic web tie downs shall be used, checked and adjusted during the transportation of cargo per applicable federal, state, provincial, local and industry regulations.

Care

Environments in which synthetic web tie downs are continuously exposed to ultra-violet sunlight can affect the strength in varying degrees, ranging from slight to total degradation.

- Store in a clean, dry location out of direct sunlight.
- Avoid exposure to acids, alkalis or temperatures in excess of 194°F.

Inspection

Inspect equipment before each use. Do not use synthetic web tie downs that have excessive wear, cuts, abrasion or which have any other defect that should cause it to be pulled from service.

INDUSTRY STANDARDS

IT IS ULTIMATELY THE DRIVER'S RESPONSIBILITY TO INSURE THAT THE CARGO BEING HAULED IS PROPERLY SECURED. The U.S. Department of Transportation, Federal Motor Carrier Safety Administration regulation 49CFR Part 392.9(a) states: "A driver may not operate a commercial motor vehicle, and a motor carrier may not require or permit a driver to operate a commercial motor vehicle unless the commercial motor vehicle's cargo is properly distributed and adequately secured as specified in sections 393.100 through 393.142 of this subchapter." In addition, 49CFR Part 392.9(b) states: "Drivers of truck and truck tractors must assure himself/herself that the provisions of paragraph (a) of this section have been complied with before he/she drives that commercial motor vehicle; inspect the cargo and the devices used to secure the cargo within the first 50 miles after beginning a trip and cause any adjustments to be made to the cargo or load securement devices as necessary, including adding more securement devices, to ensure that cargo cannot shift on or within, or fall from the commercial motor vehicle; and reexamine the commercial motor vehicle's cargo and its load securement devices during the course of transportation and make any necessary adjustments to the cargo or load securement devices, including adding more securement devices, to ensure that the cargo cannot shift on or within, or fall from, the commercial motor vehicle."

The Federal Motor Carrier Safety Administration (FMCSA) has many useful guides to aid in understanding the cargo securement rules available at

<http://www.fmcsa.dot.gov/rulesregulations/truck/driver/education-material.htm>

The Canadian Council of Motor Transport Administrators (CCMTA) has issued National Safety Code Standard 10 for Cargo Securement. They have copies of the regulation, training guides and driver handbooks available for purchase on their web site:

<http://www.ccmta.ca/english/productstandservices/publications/publications.cfm#cargo>

Many states and provinces have their own unique requirements and it is again the driver's responsibility to make sure their load is secure and in compliance with local requirements.

CARE AND USE

INSPECT BEFORE USE – Do not use synthetic web tie downs if the webbing has excessive wear, is damaged, abraded or cut. Do not use if the hardware is damaged or defective. Do not use if there are knots in the webbing. Do not use if the WLL markings are not visible.

PROTECT FROM SHARP EDGES – Always use corner protectors or edge protectors to protect the straps when they are exposed to corners or abrasive or hot surfaces.

STORAGE – Store synthetic web tie downs in a clean dry place out of direct sunlight when not in use. Avoid exposure to acids, alkalis or temperatures in excess of 194 degrees F.

NOT FOR LIFTING OR TOWING – Do not use synthetic web tie down straps for lifting, lowering, suspending, recovery or towing. Use only properly marked and rated lifting slings for lifting, lowering or suspending applications and properly marked and rated recovery or tow straps for recovery or towing applications.

MODIFICATION OR MISUSE – Any modification or misuse of Ancra products will result in voiding of warranty and liability responsibility of Ancra International.

WINCHES – Ancra cargo securement winches shall be installed, used and maintained in accordance with the information sheet provided with each winch. Ancra winches are designed to be used with Ancra winch bars inserted fully through the hole in the mandrel cap end. Do not use cheater bars or extenders on the Ancra winch bars.

WEBBING WRAPS – When using winch or ratchet straps, a minimum of two (2) and maximum of four (4) wraps of webbing shall be on the winch mandrel. Excessive wraps of webbing on the mandrel may reduce the working load limit (WLL) of the synthetic web tie down and may interfere with proper operation.

SECURE FOOTING – Before operating any synthetic web tie down assembly the user shall secure his footing to prevent slipping or falling. In adverse weather conditions, including freezing temperatures, additional caution should be exercised.

CAUTIONS AND WARNINGS – For the benefit of the user and the motoring public, each Ancra product is provided with instructions including cautions and warnings associated with its use. Failure to comply may result in personal injury, property damage or death.

RECOMMENDED OPERATING PRACTICES for SYNTHETIC WEB TIE DOWNS

These guidelines are not intended to replace proper training, experience and learned knowledge regarding proper tie down procedures.

SELECTION – Select a synthetic web tie down having suitable characteristics for the type of load, environment and attachment to vehicle anchor point. Fittings shall have the required shape and size to attach properly to the vehicle anchor points.

WORKING LOAD LIMIT – Identify the working load limit (WLL) marked on the synthetic web tie down by the manufacturer. If the required markings are illegible or missing, remove from service. Read all warnings and/or instructions provided by the manufacturer.

ANCHOR POINTS – Identify the working load limit (WLL) of the vehicle anchor points. If no rating is visible, contact the vehicle manufacturer for tie down instructions. The lesser-rated WLL, whether the anchor point or the synthetic web tie down, shall determine the WLL of the securement system.

NUMBER OF TIE DOWNS – Determine the proper number of synthetic web tie downs required based on the weight of the cargo, the type of commodity, the aggregate working load limit of the securement system and the length/weight ratio of the cargo being secured. Additionally, end users and enforcement personnel are required to know commodity-specific rules governing proper tie down determination as published by the Federal Motor Carrier Safety Administration Standard for Protection Against Shifting and Falling Cargo; Final Rule effective December 26, 2002.

OUT-OF-SERVICE CRITERIA (REPLACEMENT)

Synthetic web tie downs shall be removed from service if any of the following are visible:



Excessive abrasive wear



Melting or charring of the tie down, or weld splatter on the tie down



Chemical burns



Holes, tears, cuts, snags



Tear in webbing or fitting



Broken or worn stitching in load bearing sew patterns

INFORMED SOURCES

U.S. Department of Transportation Federal Highway Administration (FHWA)

Website: www.fhwa.dot.gov

California Highway Patrol (CHP) Title 13

Website: www.chp.ca.gov

Web Sling & Tie Down Association (WSTDA)

Website: www.wstda.com

Specialized Carriers & Rigging Association (SC&RA)

Website: www.scranet.org

Truck Trailer Manufacturing Association (TTMA)

Website: www.ttmanet.org

Canada

The Ministry of Transportation in each Province

Website: www.mto.gov.on.ca

Mexico

Dir. General de Transporte Terrestre SubDirector de Inspeccion del Transporte

GLOSSARY

Abrasion	The mechanical wearing of a surface from contact with other object.
Aggregate Working Load Limit	The summation of the Working Load Limit (WLL) of all tie downs used to secure an article of cargo.
Anchor Point	The location to which a tie down is attached to a vehicle or article of cargo. If the anchor point is inadequate to support the force of the tie down system, then the load rating of the tie down will be limited to the strength of the anchor point.
Breaking Strength	The tensile load in pounds or kilograms at which any part of the securement assembly fails.
Cargo	All articles or material carried by a vehicle, including those used in operation of the vehicle.
Design Factor	The ratio of the breaking strength to the Working Load Limit (WLL).
Direct Tie Down	A tie down that is attached directly to the cargo.
Elongation	The measurement of stretch at a specifically applied load, expressed as a percentage of the original length.
Fabrication Efficiency	The synthetic web tie down assembly break strength, as a percentage of the webbing strength prior to fabrication.
Indirect Tie Down	A tie down which passes over the cargo and is secured to the vehicle at both ends. Tension in the tie down increases the pressure of an article or stack of articles on the deck of the vehicle.
Keeper	A device used on a hook to prevent the hook from inadvertently releasing.
Length	The distance between extreme end bearing points of the synthetic web tie down assembly, including the fittings.
Lever Load Binder	A chain binder incorporating an overcenter locking action.
Proof Load Test	A non-destructive load test to some multiple of the working load limit.
Selvage	The woven or knitted edge of synthetic webbing.
Sew/Stitch Pattern	The pattern of the stitches used to sew the webbing together.
Shoring Bar	A structural bar placed transversely between the walls of a vehicle to prevent cargo from tipping or shifting.
Ultimate Test	A load test of a securement assembly tested to failure.
Warp	A longitudinal load bearing yarn in webbing.
Winch	A device for tensioning a webbing or wire rope tie down that is fitted with means to lock the initial tension.
Working Load Limit (WLL)	The maximum load a component or assembly should be subjected to during routine use.

INNOVATIVE TEAMWORK SOLUTIONS

- ▶ **When we start a project with you, we develop shared objectives based on your specific goals.**

We view your requirements from all angles. With over decades of industry experience, we don't automatically reach for the easy answers. The innovative solutions we've developed are a result of looking at each new project from a fresh perspective.

- ▶ We envision the global picture, and we sweat the details. Each part is tested and tested again against the highest standards of quality, reliability and durability.
- ▶ Through every step of the process, we work as a team with you. We continue to provide technical support after our products have been installed.

TRADE ASSOCIATIONS



Web Sling & Tie Down Association
(WSTDA)



British Columbia Trucking Association
(BCTA)



Technology & Maintenance Council
(TMC)



Truck Trailer Manufacturers Association
(TTMA)



Canadian Transportation Equipment
Association (CTEA/AETC)



Commercial Vehicle Safety Network
(CVSN)



Associated Wire Rope Fabricators
(AWRF)



Commercial Vehicle Safety Alliance
(CVSA)



Association of American Railroads
(AAR)



National Trailer Dealers Association
(NTDA)



National Association of Trailer
Manufacturers (NATM)



Heavy Duty Distributor Council
(HDDC)

STATE TRUCKING ASSOCIATIONS

- ▶ Arkansas Trucking Association
- ▶ Alabama Trucking Association
- ▶ Indiana Motor Truck Association
- ▶ Minnesota Trucking Association
- ▶ New Jersey Motor Truck Association
- ▶ Ohio Trucking Association
- ▶ Pennsylvania Motor Truck Association
- ▶ Texas Motor Transportation Association
- ▶ Tennessee Trucking Association
- ▶ Washington Trucking Association
- ▶ Wisconsin Motor Carrier Association

LITERATURE AVAILABLE BY REQUEST



Ankra International Aircraft Interiors & Cargo Fittings

This catalog provides a full selection of the very best aircraft fittings and components, all made in the U.S.A. by Ankra for over 25 years.

Request Catalog 402



Ankra International Cargo Restraint Catalog

Ankra showcases the most popular solutions for flatbed and interior van cargo restraints. A mini catalog of winches, straps, tie-offs, beams and bars.

Request Brochure 214A



Ankra International Lift-A-Deck II

Ankra's proprietary Lift-A-Deck decking systems enables optimum utilization of cargo space in vans and trailers.

Request Brochure B233A

GENERAL INFORMATION

INDEX BY PRODUCT NUMBER

10632-90	2" x 18" Fixed End Strap w/ 44587-10 Buckle & 40891-18 Flat Hook	37	20-EE2-9802X6	2" x 6' Eye/Eye 2 Ply Sling	68
10632-90-28	2" x 28' Adjustable End Strap w/ 40891-18 Flat Hook	37	20-EE2-9802X8	2" x 8' Eye/Eye 2 Ply Sling	68
10632-93	2" x 33" Fixed End Strap w/ 44587-10 Buckle & 43366-21 Chain Anchor	37	20-EE2-9802X10	2" x 10' Eye/Eye 2 Ply Sling	68
10632-93-28	2" x 28' Adjustable End Strap w/ 43366-21 Chain Anchor	37	20-EE2-9802X12	2" x 12' Eye/Eye 2 Ply Sling	68
10632-95	2" x 18" Fixed End Strap w/ 44587-10 Buckle & 43120-13 Wire Hook	37	20-EE2-9802X16	2" x 16' Eye/Eye 2 Ply Sling	68
10632-95-28	2" x 28' Adjustable End Strap w/ 43120-13 Wire Hook	37	20-EE2-9802X20	2" x 20' Eye/Eye 2 Ply Sling	68
10633-90	3" x 18" Fixed End Strap w/ 48965-10 Buckle & 41766-18 Flat Hook	37	20-EE2-9802X30	2" x 30' Eye/Eye 2 Ply Sling	68
10633-90-28	3" x 28' Adjustable End Strap w/ 41766-18 Flat Hook	37	20-EE2-9803X10	3" x 10' Eye/Eye 2 Ply Sling	68
10633-92	3" x 33" Fixed End Strap w/ 48965-10 Buckle & 43366-14 Chain Anchor	37	20-EE2-9803X12	3" x 12' Eye/Eye 2 Ply Sling	68
10633-92-28	3" x 28' Adjustable End Strap w/ 43366-14 Chain Anchor	37	20-EE2-9803X16	3" x 16' Eye/Eye 2 Ply Sling	68
10634-90	4" x 18" Fixed End Strap w/ 49349-10 Buckle & 41766-18 Flat Hook	37	20-EE2-9803X20	3" x 20' Eye/Eye 2 Ply Sling	68
10634-90-28	4" x 28' Adjustable End Strap w/ 41766-18 Flat Hook	37	20-EE2-9804X6	4" x 6' Eye/Eye 2 Ply Sling	68
10634-91	4" x 33" Fixed End Strap w/ 49349-10 Buckle & 43366-14 Chain Anchor	37	20-EE2-9804X8	4" x 8' Eye/Eye 2 Ply Sling	68
10634-91-28	4" x 28' Adjustable End Strap w/ 43366-14 Chain Anchor	37	20-EE2-9804X10	4" x 10' Eye/Eye 2 Ply Sling	68
10634-93	4" x 20" Fixed End Strap w/ 49349-10 Buckle & 43120-20 Wire Hook	37	20-EE2-9804X12	4" x 12' Eye/Eye 2 Ply Sling	68
10634-93-28	4" x 28' Adjustable End Strap w/ 43120-20 Wire Hook	37	20-EE2-9804X16	4" x 16' Eye/Eye 2 Ply Sling	68
10751-10	Garment Rope 1/4" x 8'	51	20-EE2-9804X20	4" x 20' Eye/Eye 2 Ply Sling	68
20-EE1-9801X3	1" x 3' Eye/Eye 1 Ply Sling	67	20-ENR1X3	1" x 3' Purple Endless Round Sling	66
20-EE1-9801X4	1" x 4' Eye/Eye 1 Ply Sling	67	20-ENR1X4	1" x 4' Purple Endless Round Sling	66
20-EE1-9801X6	1" x 6' Eye/Eye 1 Ply Sling	67	20-ENR1X6	1" x 6' Purple Endless Round Sling	66
20-EE1-9801X10	1" x 10' Eye/Eye 1 Ply Sling	67	20-ENR1X8	1" x 8' Purple Endless Round Sling	66
20-EE1-9802X3	2" x 3' Eye/Eye 1 Ply Sling	67	20-ENR1X12	1" x 12' Purple Endless Round Sling	66
20-EE1-9802X4	2" x 4' Eye/Eye 1 Ply Sling	67	20-ENR2X3	2" x 3' Green Endless Round Sling	66
20-EE1-9802X6	2" x 6' Eye/Eye 1 Ply Sling	67	20-ENR2X4	2" x 4' Green Endless Round Sling	66
20-EE1-9802X10	2" x 10' Eye/Eye 1 Ply Sling	67	20-ENR2X8	2" x 8' Green Endless Round Sling	66
20-EE1-9802X12	2" x 12' Eye/Eye 1 Ply Sling	67	20-ENR2X12	2" x 12' Green Endless Round Sling	66
20-EE1-9802X14	2" x 14' Eye/Eye 1 Ply Sling	67	20-ENR2X20	2" x 20' Green Endless Round Sling	66
20-EE2-9801X4	1" x 4' Eye/Eye 2 Ply Sling	68	20-ENR3X3	3" x 3' Yellow Endless Round Sling	66
20-EE2-9801X8	1" x 8' Eye/Eye 2 Ply Sling	68	20-ENR3X4	3" x 4' Yellow Endless Round Sling	66
20-EE2-9802X3	2" x 3' Eye/Eye 2 Ply Sling	68	20-ENR3X8	3" x 8' Yellow Endless Round Sling	66
20-EE2-9802X4	2" x 4' Eye/Eye 2 Ply Sling	68	20-ENR3X12	3" x 12' Yellow Endless Round Sling	66
			20-ENR3X20	3" x 20' Yellow Endless Round Sling	66
			20-ENR4X10	4" x 10' Tan Endless Round Sling	66
			20-ENR4X16	4" x 16' Tan Endless Round Sling	66
			20-ENR5X4	5" x 5' Red Endless Round Sling	66
			20-ENR5X6	5" x 6' Red Endless Round Sling	66
			20-ENR5X12	5" x 12' Red Endless Round Sling	66
			20-ENR5X20	5" x 20' Red Endless Round Sling	66
			20-ENR7X6	7" x 7' Blue Endless Round Sling	66
			30AS33-BK	2" x 33" Black Axle Strap w/ Sleeve	63
			30ATB	Adjustable Tire Bonnet	64
			30RT	Double Adjustable Tire Bonnet	64
			40023-12	Wire Hook, Wide - 2" - 833 lb. WLL	78
			40024-10	Wire Hook, Narrow - 1" - 1,000 lb. WLL	78
			40024-12	Wire Hook, Narrow - 2" - 833 lb. WLL	78
			40025-10	D-Ring - 1" - 1,666 lb. WLL	80
			40025-12	D-Ring - 2" - 1,666 lb. WLL	80

INDEX BY PRODUCT NUMBER

40044-10	Flat Hook w/ Keeper - 1" - 1,166 lb. WLL	79	40849-12	Series F Track (Galvanized) 10', 1" Holes Canada	49
40065-10	Flat Hook - 1" - 333 lb. WLL	79	40849-14	Series F Track (Galvanized) 10', 1.62" Hole Spacing.	49
40065-12	Flat Hook, Vinyl - 1" - 333 lb. WLL	79	40880-15	Cam Buckle - 2" - 833 lb. WLL Replaces 40880-19	77
40084-14	Snap Hook - 2" - 2,766 lb. WLL	80	40880-22	Cam Buckle - 1" - 600 lb. WLL	77
40316-12	Wire Hook, Narrow - 1" - 166 lb. WLL	78	40891-18	Flat Hook - 2" - 3,333 lb. WLL	79
40340-27	Single Stud Track Fitting - 1,333 lbs. Vertical WLL	88	40921-10	Beam Socket.	51
40386-10	Rope Tie Off - Series E (3 piece End Fitting) 1,000 lb. WLL	54	40921-11	Beam Socket Heavy-Duty	51
40386-11	Rope Tie Off - Series E (Spring Actuated Fitting) 1,333 lb. WLL	54	40978-11	Delta Ring - 2" - 3,333 lb. WLL	80
40386-12	Rope Tie Off - Series F - 500 lb. WLL	54	40980-11	Track Fitting Series F - 500 lb. WLL	82
40386-13	Rope Tie Off - Series F - 500 lb. WLL (Canada)	54	40980-13	Track Fitting Series F - 500 lb. WLL (Canada)	82
40467-33-144	Heavy-Duty Aircraft Track 12'	88	40985-05-12	Web Protector - Cordura Sleeve - 12" Long.	16
40602-10	Series E Strap Assy - 3-pc. End - 12'	56	40985-05-RL	Web Protector - Cordura Sleeve - 100 Yd. Roll	16
40602-11	Series E Strap Assy - 3-pc. End - 16'	56	41030-12	Cam Buckle - 1" - 166 lb. WLL Replaces 41030-10	77
40602-12	Series E Strap Assy - 3-pc. End - 20'	56	41048-10	Ankra Red Motorcycle Strap - 1" x 5.5'	70
40602-17	Series E Strap Assy - 1-pc. End - 12'	56	41048-23	Ankra Red Motorcycle Strap - 1" x 13'	70
40602-18	Series E Strap Assy - 1-pc. End - 16'	56	41313-12	S Hook, Plated - 1" - 400 lb. WLL	78
40602-19	Series E Strap Assy - 1-pc. End - 20'	56	41313-13	S Hook, Vinyl - 1" - 400 lb. WLL	78
40602-20	Series F Strap Assembly - Cam Buckle - 12'	56	41313-19	S Hook, Vinyl - 1" - 600 lbs. WLL	78
40602-21	Series F Strap Assembly - Cam Buckle - 16'	56	41325-10	Slat Hook - 1,000 lb. WLL	82
40602-22	Series F Strap Assembly - Cam Buckle - 20'	56	41409-13	Series E End Fitting (3 Piece) 1,000 lb. WLL	82
40602-97	Plate Trailer Strap Assembly w/ Wire Hooks - Cam Buckle - 12'	57	41516-11	Corner Protector - 2" - Aluminum.	16
40602-98	Plate Trailer Strap Assembly w/ Wire Hooks - Cam Buckle - 16'	57	41631-12	Delta Ring - 4" - 6,666 lb. WLL	80
40602-99	Plate Trailer Strap Assembly w/ Wire Hooks - Cam Buckle - 20'	57	41632-17-BULK-CUT	3" Yellow Polyester Latex Treated Webbing	87
40602-100	LAD II Logistics Strap w/ Single Stud Fitting - Cam Buckle - 12'	45	41632-19-BULK-CUT	2" Red Polyester Latex Treated Webbing	87
40602-101	LAD II Logistics Strap w/ Single Stud Fitting - Cam Buckle - 16'	45	41632-24-BULK-CUT	3" Blue Polyester Latex Treated Webbing	87
40602-102	LAD II Logistics Strap w/ Single Stud Fitting - Cam Buckle - 20'	45	41632-26-BULK-CUT	2" Blue Polyester Lated Treated Webbing	87
40602-103	Series F Strap Assembly - Cam Buckle - 12' - Canada	56	41632-31-BULK-CUT	2" Yellow Polyester Latex Treated Webbing	87
40602-104	Series F Strap Assembly - Cam Buckle - 16' - Canada	56	41645-10	Roller Buckle - 2"-500 lbs. WLL	77
40602-105	Series F Strap Assembly - Cam Buckle - 20' - Canada	56	41659-10-27	2" x 27' Winch Strap w/ 40891-18 Flat Hook	29
40758-11	Snap Hook, Twisted - 2" - 3,333 lb. WLL	80	41659-10-30	2" x 30' Winch Strap w/ 40891-18 Flat Hook	29
40758-13	Snap Hook - 2" - 3,333 lb. WLL	80	41659-11-27	2" x 27' Winch Strap w/ 40978-11 Delta Ring	29
40838-10	Series E Vertical Track (Gray) 10'	48	41659-11-30	2" x 30' Winch Strap w/ 40978-11 Delta Ring	29
40838-11	Series E Vertical Track (Galvanized) 10'	48	41659-13-27	2" x 27' Winch Strap w/ 43120-13 Wire Hook	29
			41659-13-30	2" x 30' Winch Strap w/ 43120-13 Wire Hook	29
			41659-15-27	2" x 27' Winch Strap w/ 43366-21 Chain Anchor	29
			41659-15-30	2" x 30' Winch Strap w/ 43366-21 Chain Anchor	29
			41659-16-30	2" x 30' Winch Strap w/o Hardware	29
			41659-90-27	2" x 27' ANCR A X-TREME Winch Strap w/ 40891-18 Flat Hook	26
			41659-90-30	2" x 30' ANCR A X-TREME Winch Strap w/ 40891-18 Flat Hook	26

GENERAL INFORMATION

INDEX BY PRODUCT NUMBER

41659-92-30	2" x 30' ANCRA X-TREME Winch Strap w/ 43120-13 Wire Hook	26	43099-10	Flat Hook - 2" - 1,666 lb. WLL	79
41659-93-30	2" x 30' ANCRA X-TREME Winch Strap w/ 43366-21 Chain Anchor	26	43120-11	Wire Hook, Narrow - 2" - 1,666 lb. WLL	78
41659-94-30	2" x 30' ANCRA X-TREME Winch Strap w/o Hardware	26	43120-13	Wire Hook, Narrow - 2" - 3,333 lb. WLL	78
41660-10-27	3" x 27' Winch Strap w/ 41766-18 Flat Hook	30	43120-19	Wire Hook, Narrow - 1.75" - 500 lb. WLL	78
41660-10-30	3" x 30' Winch Strap w/ 41766-18 Flat Hook	30	43120-20	Wire Hook, Narrow - 3" - 7,333 lb. WLL	78
41660-14-27	3" x 27' Winch Strap w/ 43366-14 Chain Anchor	30	43320-32	Ratchet Buckle - 1" - 1,455 lb. WLL	74
41660-14-30	3" x 30' Winch Strap w/ 43366-14 Chain Anchor	30	43365-12	Grab Hook Assembly, Unplated - 5,400 lb. WLL	84
41660-17-30	3" x 30' Winch Strap w/o Hardware	30	43366-14	Chain Anchor w/ Delta Ring - 5,400 lb. WLL	83
41660-18-27	3" x 27' Winch Strap w/ 43120-20 Wire Hook	30	43366-21	5/16" Chain Anchor w/ Delta Ring - 3,333 lbs. WLL	83
41660-18-30	3" x 30' Winch Strap w/ 43120-20 Wire Hook	30	43488-20	Combo Winch - Side Mount - Low Profile	6
41660-90-30	3" x 30' ANCRA X-TREME Winch Strap w/ 41766-18 Flat Hook	27	43546-10	Gutter Hook - 1" - 250 lb. WLL	79
41660-93-30	3" x 30' ANCRA X-TREME Winch Strap w/ 43366-14 Chain Anchors	27	43563-10	Web Winch - Bottom Mount - Std.	2
41660-95-30	3" x 30' ANCRA X-TREME Winch Strap w/o Hardware	27	43564-12	Web Winch - Bottom Mount - Std. Storable Portable w/ 2SS.	2
41681-10	Combo Winch - Bottom Mount - Std.	6	43564-14	Web Winch - Bottom Mount - Std. Portable w/ 2SS.	2
41691-10	Web Winch - Frameless	3	43564-16	Web Winch - Side Mount - Low Profile Portable w/ 2SS.	2
41696-10	Cable Winch - End Mount - RH	6	43565-127	Web Winch - Bottom Mount - Storable C Track Slider w/ 7mm Frame	3
41696-11	Cable Winch - End Mount - LH	6	43565-12-SG	Web Winch - Bottom Mount - Deep Storable C Track Slider - Zinc Plated	2
41766-18	Flat Hook - 3" - 5,400 LB. WLL	79	43565-137	Web Winch - Bottom Mount - C Track Slider - Double Cap w/ 7mm Frame	3
41766-19	Flat Hook - 3" - 5,400 lb.WLL w/ Keeper	79	43565-147	Web Winch - Bottom Mount - Storable C Track Slider w/ 7mm Frame	3
41808-14	Ratchet Buckle - 1 3/4" - 2,000 lb. WLL	74	43565-157	Web Winch - Bottom Mount - Std. C Track Slider w/ 7mm Frame	3
41820-10-RL	1" Red Nylon Webbing	87	43565-15-SG	Web Winch - Bottom Mount - Std. C Track Slider - Silver Galvanized	3
41820-14-RL	1" Blue Nylon Webbing	87	43573-10	Web Winch - Bottom Mount - Std. Storable	2
41820-15-RL	1" Black Nylon Webbing	87	43573-11	Web Winch - Bottom Mount - Std. Storable 2" Spool	2
42012-12 HD	Series F Hook - 800 lb. WLL	82	43573-12	Web Winch - Bottom Mount - Std. Storable 3" Spool	2
42098-11	Corner Protector - 3" - Rubber	16	43573-13	Web Winch - Bottom Mount - Std. Storable 4" Spool	2
42098-12	Corner Protector - 4" - Rubber	16	43579-20	Web Winch - Side Mount - Low Profile	3
42195-11	Cam Buckle - 1" - 500 lb. WLL Replaces 42195-10	77	43627-13	Replacement Channel Assembly (Al. Beam)	51
42313-10	Winch Bar - Std. Painted.	12	43638-50	Decking/Shoring Beam Series E - 85.7" - 96.6" Long	50
42313-12	Winch Bar - Combination Box End Painted Silver & Yellow	12	43638-51	Decking/Shoring Beam Series E - 91.9" - 102.9" Long	50
42313-17	Winch Bar - Std. Chrome	12	43781-145	Long Foot Assembly (2 x 4)	52
42313-19	Winch Bar - Combination Chrome	12	43781-155	Short Foot Assembly (2 x 4)	52
42357-11	Winch Track - 6' Steel.	10	43781-16	Long Foot Assembly (4 x 4)	52
42357-12	Winch Track - 12' Steel.	10			
42357-21	Winch Track - 6' Aluminum	10			
42816-18	Overcenter Buckle - 1" - 600 lb. WLL	76			
42948-10	Series A Horizontal Track (Gray) 10'	49			
43044-10	Snap Hook - 1" - 1,666 lb. WLL	80			

INDEX BY PRODUCT NUMBER

43781-17	Short Foot Assembly (4 x 4)	52	43797-19-BULK-CUT	4" Blue Polyester Latex Treated Webbing	87
43782-15	Cargo Sta - Standard - 89.75" to 104.5" Long	52	43797-23-BULK-CUT	4" Red Polyester Latex Treated Webbing	87
43795-10-27	4" x 27' Winch Strap w/ 41766-18 Flat Hook	30	43797-34-BULK-CUT	4" Green Polyester Latex Treated Webbing	87
43795-10-30	4" x 30' Winch Strap w/ 41766-18 Flat Hook	30	43797-36-RL	4" Yellow Polyester Latex Treated Webbing	87
43795-10-35	4" x 35' Winch Strap w/ 41766-18 Flat Hook	30	43887-10	Mini Ratchet Strap - 1"x 16'- Display Packaged	70
43795-10-40	4" x 40' Winch Strap w/ 41766-18 Flat Hook	30	43887-11	Mini Ratchet Strap - 1"x 20'- Display Packaged	70
43795-10-50	4" x 50' Winch Strap w/ 41766-18 Flat Hook	30	43908-10	Combo Winch - Recessed Box	6
43795-11-27	4" x 27' Winch Strap w/ 41631-12 Delta Ring	30	43986-10	Corner Protector - 4" - Black Plastic	16
43795-11-30	4" x 30' Winch Strap w/ 41631-12 Delta Ring	30	43991-10	Hoop Set - Cargo Sta	52
43795-11-35	4" x 35' Winch Strap w/ 41631-12 Delta Ring	30	43997-10	Combo Winch - Leg Mount - Low Profile	6
43795-11-40	4" x 40' Winch Strap w/ 41631-12 Delta Ring	30	44102-11	H-2 Hook	13
43795-11-50	4" x 50' Winch Strap w/ 41631-12 Delta Ring	30	44122-10	Corner Iron Hook	13
43795-13-30	4" x 30' Winch Strap w/ Half Twisted Loop	30	44232-10	Ratchet Buckle - 1" - 400 lb. WLL	74
43795-13-45	4" x 45' Winch Strap w/ Half Twisted Loop	30	44258-13	Ratchet Buckle - 2" - 1,500 lb. WLL - Low Profile	75
43795-13-50	4" x 50' Winch Strap w/ Half Twisted Loop	30	44340-11	Strap Assy - 1" - Ratchet Buckle - 10' w/ Wire Hooks	70
43795-13-65	4" x 65' Winch Strap w/ Half Twisted Loop	30	44466-10	Combo Winch - 2" Web	6
43795-13-75	4" x 75' Winch Strap w/ Half Twisted Loop	30	44557-10	Ancra Lash R/B Strap - 1" x 15'- Bulk - 500 lb. WLL	70
43795-14-27	4" x 27' Winch Strap w/ 43365-12 Grab Hook	30	44587-10	Ratchet Buckle - 2" - 3,666 lb. WLL - Long Wide Handle	75
43795-14-30	4" x 30' Winch Strap w/ 43365-12 Grab Hook	30	44627-11	Ratchet Buckle - 2" - 3,333 lb. WLL - Standard Handle	75
43795-15-27	4" x 27' Winch Strap w/ 43366-14 Chain Anchor	31	44639-12	Overcenter Buckle - 1 3/4" - 1,666 lb. WLL	76
43795-15-30	4" x 30' Winch Strap w/ 43366-14 Chain Anchor	31	45143-20	Basket Strap for Tires 7"W x 20"H	63
43795-19-30	4" x 30' Winch Strap w/o Hardware	31	45143-22	Basket Strap for Tires 8"W x 24"H	63
43795-40-30	4" x 30' Winch Strap w/ 41766-18 Flat Hook - Blue Webbing	31	45228-10	Rave Hook - 1,167 lb. WLL	78
43795-60-30	4" x 30' Winch Strap w/ 41766-18 Flat Hook - Red Webbing	31	45515-10	Cluster Hook (RTJ)	84
43795-90-27	4" x 27' ANCRA X-TREME Winch Strap w/ 41766-18 Flat Hook	28	45545-15	Pan Fitting w/ Black Trim Collar	54
43795-90-30	4" x 30' ANCRA X-TREME Winch Strap w/ 41766-18 Flat Hook	28	45801-10	Web Winder	13
43795-90-40	4" x 40' ANCRA X-TREME Winch Strap w/ 41766-18 Flat Hook	28	45849-13	Recessed Pan Fitting 1,666 lb. WLL	54
43795-91-27	4" x 27' ANCRA X-TREME Winch Strap w/ 41631-12 Delta Ring	28	45867-12	Garment Beam - 96"	51
43795-91-30	4" x 30' ANCRA X-TREME Winch Strap w/ 41631-12 Delta Ring	28	45867-13	Garment Beam - 102"	51
43795-91-40	4" x 40' ANCRA X-TREME Winch Strap w/ 41631-12 Delta Ring	28	45880-10	G70 Chain - 5/16" Bulk 4,700 lbs. WLL 400' Barrel	19
43795-92-30	4" x 30' ANCRA X-TREME Winch Strap w/o Hardware	28	45880-11	G70 Chain - 3/8" Bulk 6,600 lbs. WLL 200' Barrel	19
43795-93-30	4" x 30' ANCRA X-TREME Winch Strap w/ Half Twist	28	45880-12	G70 Chain - 1/4" Bulk 3,150 lbs. WLL 400' Barrel	19
43795-95-30	4" x 30' ANCRA X-TREME Winch Strap w/ 43366-14 Chain Anchor	28	45880-13	G70 Chain - 1/2" Bulk 11,300 lbs. WLL 100' Barrel	19
43797-18-BULK-CUT	4" Gray Polyester Latex Treated Webbing	87	45881-10-16	G70 Chain Assy - 5/16" x 16' w/ Clevis Hooks 4,700 lbs. WLL	19
			45881-10-16-SP	G70 Chain Assy - 5/16" x 16' w/ Clevis Hooks 4,700 lbs. WLL - In Pail	20
			45881-10-20	G70 Chain Assy - 5/16" x 20' w/ Clevis Hooks 4,700 lbs. WLL	19

GENERAL INFORMATION

INDEX BY PRODUCT NUMBER

45881-10-20-SP	G70 Chain Assy - 5/16" x 20' w/ Clevis Hooks 4,700 lbs. WLL - In Pail	20	45982-10	2" x 27' Ratchet Strap w/ 40891-18 Flat Hooks	34
45881-10-25	G70 Chain Assy - 5/16" x 25' w/ Clevis Hooks 4,700 lbs. WLL	19	45982-10-27-WK	2" x 27' Ratchet Strap w/ 40891-18 Flat Hooks, w/ Web Keeper Buckle.	36
45881-10-25-SP	G70 Chain Assy - 5/16" x 25' w/ Clevis Hooks 4,700 lbs. WLL - In Pail	20	45982-11	2" x 30' Ratchet Strap w/ 40891-18 Flat Hooks	34
45881-11-16	G70 Chain Assy - 3/8" x 16' w/ Clevis Hooks 6,600 lbs. WLL	19	45982-11-30-WK	2" x 30' Ratchet Strap w/ 40891-18 Flat Hooks, w/ Web Keeper Buckle.	36
45881-11-16-SP	G70 Chain Assy - 3/8" x 16' w/ Clevis Hooks 6,600 lbs. WLL - In Pail	20	45982-15	2" x 27' Ratchet Strap w/ 43366-21 Chain Anchors	34
45881-11-20	G70 Chain Assy - 3/8" x 20' w/ Clevis Hooks 6,600 lbs. WLL	19	45982-19	2" x 27' Ratchet Strap w/ 40758-11 Snap Hooks	34
45881-11-20-SP	G70 Chain Assy - 3/8" x 20' w/ Clevis Hooks 6,600 lbs. WLL - In Pail	20	45982-34	2" x 30' Ratchet Strap w/ 43366-21 Chain Anchors	34
45881-11-25	G70 Chain Assy - 3/8" x 25' w/ Clevis Hooks 6,600 lbs. WLL	19	45982-36	2" x 30' Ratchet Strap w/ 40758-11 Snap Hooks	34
45881-11-25-SP	G70 Chain Assy - 3/8" x 25' w/ Clevis Hooks 6,600 lbs. WLL - In Pail	20	45982-42	2" x 27' Ratchet Strap w/ 43120-13 Wire Hooks	34
45881-13-20	G70 Chain Assy - 1/2" x 20' w/ Clevis Hooks 11,300 lbs. WLL	19	45982-42-27-WK	2" x 27' Ratchet Strap w/ 43120-13 Wire Hooks, w/ Web Keeper Buckle.	36
45881-13-25	G70 Chain Assy - 1/2" x 25' w/ Clevis Hooks 11,300 lbs. WLL	19	45982-43	2" x 30' Ratchet Strap w/ 43120-13 Wire Hooks	34
45943-10	Chain Load Binder - 5/16" Lever 5,400 lbs. WLL	24	45982-43-30-WK	2" x 30' Ratchet Strap w/ 43120-13 Wire Hooks, w/ Web Keeper Buckle.	36
45943-10-HD	Chain Load Binder, Heavy-Duty - 5/16" Lever 5,400 lbs. WLL	24	45982-90-27	2" x 27' Ratchet Strap w/ 40891-18 Flat Hooks	32
45943-11	Chain Load Binder - 3/8" Lever 9,200 lbs. WLL	24	45982-90-27-WK	2" x 27' Ratchet Strap w/ 40891-18 Flat Hooks, w/ Web Keeper Buckle.	36
45943-12	Chain Load Binder - 1/4" Lever 2,500 lbs. WLL	24	45982-90-30	2" x 30' Ratchet Strap w/ 40891-18 Flat Hooks	32
45943-13	Chain Load Binder - 1/2" Lever 13,000 lbs. WLL	24	45982-90-30-WK	2" x 30' Ratchet Strap w/ 40891-18 Flat Hooks, w/ Web Keeper Buckle.	36
45943-14	Recoilless Chain Load Binder - 5/16" Lever 5,400 lbs. WLL	24	45982-93-30	2" x 30' Ratchet Strap w/ 43366-21 Chain Anchors	32
45943-20	Chain Load Binder - 5/16" Ratchet 5,400 lbs. WLL	25	45982-95-27	2" x 27' Ratchet Strap w/ 43120-13 Wire Hooks	32
45943-20-HD	Chain Load Binder, Heavy-Duty - 5/16" Ratchet 5,400 lbs. WLL	25	45982-95-27-WK	2" x 27' Ratchet Strap w/ 43120-13 Wire Hooks, w/ Web Keeper Buckle.	36
45943-21	Chain Load Binder - 3/8" Ratchet 9,200 lbs. WLL	25	45982-95-30	2" x 30' Ratchet Strap w/ 43120-13 Wire Hooks	32
45943-23	Chain Load Binder - 1/2" Ratchet 13,000 lbs. WLL	25	45982-95-30-WK	2" x 30' Ratchet Strap w/ 43120-13 Wire Hooks, w/ Web Keeper Buckle.	36
45946-10	5/16" Clevis Hook 4,700 lbs. WLL	21, 84	47105-11	Ratchet Buckle - 2" - 3,666 lb. WLL - Short Wide Handle	75
45946-11	3/8" Clevis Hook 6,600 lbs. WLL	21, 84	47200-60-BULK-CUT	2" Gray Polyester Webbing	87
45946-12	1/4" Clevis Hook 3,150 lbs. WLL	21, 84	47200-61-BULK-CUT	2" Yellow Polyester Webbing	87
45946-13	1/2 in. Clevis Hook 11,300 lbs. WLL	21, 84	47200-62-BULK-CUT	2" Blue Polyester Webbing	87
45951-12	Flat Latch Repair Kit	51			

INDEX BY PRODUCT NUMBER

47200-64-BULK-CUT	2" Red Polyester Webbing	87	48253-21	Plate Trailer Cam Strap w/ Wire Hook and E Fitting 20'	57
47235-10	Series F Channel - 10' (1" Hole Spacing)	49	48253-22	Plate Trailer Cam Strap w/ F Fitting and E Fitting 12'	57
47235-15	Series F Channel - 7 1/2' (1" Hole Spacing)	49	48253-23	Plate Trailer Cam Strap w/ F Fitting and E Fitting 16'	57
47556-11	Double Stud Fitting - 1,666 lbs. WLL	88	48253-24	Plate Trailer Cam Strap w/ F Fitting and E Fitting 20'	57
47608-21	Series E Track Fitting - 1,333 lbs. WLL	82	48407-10	Economy Cargo Sta 87"- 102"- Square Feet	52
47640-31	Lashing Winch - 3,333 lbs. w/ Double Hex Drive	7, 64	48485-10	Single Replacement Cleat	62
47670-10	Hoop Set - Decking Beam	50	48487-24	2" x 140" Auto Hauler Winch Strap	62
47772-12	Series E Track Fitting w/ Round Ring - 1,000 lb. WLL	54, 83	48496-11	Lashing Winch - 2,500 lbs. w/ Double Hex Drive	7, 64
47800-10	Overcenter Buckle - 1 3/4" - 1,666 lb. WLL	76	48672-13	Series E Ratchet Strap - 1-pc. End - 12'	58
47934-11	Wheel Dolly Strap 2" x 86"	63	48672-14	Series E Ratchet Strap - 1-pc. End - 16'	58
47935-11	Wheel Dolly Strap w/ S Hooks	63	48672-15	Series E Ratchet Strap - 1-pc. End - 20'	58
47935-12	Wheel Dolly Strap w/ Spring E Fittings	63	48672-16	LAD Ratchet Strap w/ Double Stud Fitting 12'	45
47944-10	Round Ring - 2"- 900 lb. WLL	80	48672-17	LAD Ratchet Strap w/ Double Stud Fitting 16'	45
47970-10	2" x 27' Ratchet Strap w/ 40891-18 Flat Hooks	34	48672-18	LAD Ratchet Strap w/ Double Stud Fitting 20'	45
47970-11	2" x 30' Ratchet Strap w/ 40891-18 Flat Hooks	34	48672-22	Plate Trailer Ratchet Strap Assy w/ Wire Hooks 12'	58
47971-10	2" x 27' Ratchet Strap w/ 40891-18 Flat Hooks	34	48672-23	Plate Trailer Ratchet Strap Assy w/ Wire Hooks 16'	58
47971-11	2" x 30' Ratchet Strap w/ 40891-18 Flat Hooks	34	48672-24	Plate Trailer Ratchet Strap Assy w/ Wire Hooks 20'	58
48101-10	Web Winch - 3-Bar - Low Profile	5	48672-33	Series E TLR Ratchet Strap - 1-pc. End - 12'	55
48101-10-SG	Web Winch - 3-Bar - Low Profile Silver Galvanized	5	48672-34	Series E TLR Ratchet Strap - 1-pc. End - 16'	55
48101-14	Web Winch - 3-Bar - Standard	5	48672-35	Series E TLR Ratchet Strap - 1-pc. End - 20'	55
48101-16-SG	Web Winch - 3-Bar - Standard Silver Galvanized	5	48770-10	Ratchet Buckle - 1" - 500 lb. WLL	74
48101-177	Web Winch - 3-Bar - Standard C Track Slider	5	48783-10	Web Winch - Bottom Mount - Double Cap	2
48117-21-120.00	Series E Horizontal Track - 10' (Galvanized)	48	48904-10	Bolt Plate, 2", 30 degree, Clear Zinc Plated	81
48117-21-60.00	Series E Horizontal Track - 5' (Galvanized)	48	48922-10	2 x 18" Fixed End Strap w/ 40891-18 Flat Hook & Loop	37
48117-25-120.00	Series E Horizontal Track - 10' (Gray)	48	48922-11	3 x 18" Fixed End Strap w/ 41766-18 Flat Hook & Loop	38
48117-25-60.00	Series E Horizontal Track - 5' (Gray)	48	48922-12	4 x 18" Strap w/ 41766-18 Flat Hook & Loop	38
48117-32-120.00	Series E Horizontal Track - 10' Black Powdercoat	48	48922-13	2 x 18" Fixed End Strap w/ 43120-13 Wire Hook & Loop	37
48253-13	Plate Trailer Ratchet Strap w/ Wire Hook and E Fitting 12'	58	48922-15	4 x 18" Strap w/ 43120-20 Narrow Hook & Loop	38
48253-14	Plate Trailer Ratchet Strap w/ Wire Hook and E Fitting 16'	58	48922-16	2" Fixed End Strap w/ 43366-21 Chain Anchor & Loop	37
48253-15	Plate Trailer Ratchet Strap w/ Wire Hook and E Fitting 20'	58	48922-17	3 x 33" Strap w/ 43366-12 Chain Anchor & Loop	38
48253-16	Plate Trailer Ratchet Strap w/ F Fitting and E Fitting 12'	58	48922-18	4 x 33" Strap w/ 43366-14 Chain Anchor & Loop	38
48253-17	Plate Trailer Ratchet Strap w/ F Fitting and E Fitting 16'	58			
48253-18	Plate Trailer Ratchet Strap w/ F Fitting and E Fitting 20'	58			
48253-19	Plate Trailer Cam Strap w/ Wire Hook and E Fitting 12'	57			
48253-20	Plate Trailer Cam Strap w/ Wire Hook and E Fitting 16'	57			

GENERAL INFORMATION

INDEX BY PRODUCT NUMBER

48922-20	3 x 33" Strap w/ 43365-12 Grab Hook & Loop	38	49205-26	Heavy-Duty Jack Bar One-Piece - Galvanized - Bolt-on Feet - 85" - 114"	53
48965-10	Ratchet Buckle - 3" - 7,333 lb. WLL	76	49205-27	Heavy-Duty Jack Bar One-Piece Galvanized w/ Hoop Bolt-on Feet 85" - 114"	53
48968-11	Roll-Off Container Hook - 5,400 lb. WLL	79	49205-28	Heavy-Duty Jack Bar One-Piece Galvanized w/ Hoop Bolt-on Feet 86" - 104"	53
48987-20	3" x 27' Ratchet Strap w/ 41766-18 Flat Hooks - 5,400 lbs. WLL	35	49205-31	Universal Jack Bar 51" to 114"	53
48987-21	3" x 30' Ratchet Strap w/ 41766-18 Flat Hooks - 5,400 lbs. WLL	35	49207-127	Winch Double L Slider Storable - w/ 7mm Frame	4
48987-24	3" x 27' Ratchet Strap w/ 43366-12 Chain Anchors - 5,400 lbs. WLL	35	49207-127-ZP	Winch Double L Slider Storable - w/ 7mm Frame Zinc Plated	4
48987-25	3" x 30' Ratchet Strap w/ 43366-12 Chain Anchors - 5,400 lbs. WLL	35	49207-137	Winch Double L Slider Standard - w/ 7mm Frame	4
48987-28	3" x 27' Ratchet Strap w/ 43120-20 Wire Hooks - 5,400 lbs. WLL	35	49207-137-ZP	Winch Double L Slider Standard - w/ 7mm Frame Zinc Plated	4
48987-29	3" x 30' Ratchet Strap w/ 43120-20 Wire Hooks - 5,400 lbs. WLL	35	49207-187	Winch Double L Slider Low Profile w/ 7mm Frame	4
48987-90-27	3" x 27' ANCRA X-TREME Ratchet Strap w/ 41766-18 Flat Hooks	32	49207-207	3-Bar Double L Slider Winch w/ 7mm Frame	5
48987-90-30	3" x 30' ANCRA X-TREME Ratchet Strap w/ 41766-18 Flat Hooks	32	49207-207-ZP	3-Bar Double L Slider Winch w/ 7mm Frame Zinc Plated	5
48987-92-27	3" x 27' ANCRA X-TREME Ratchet Strap w/ 43366-14 Chain Anchors	32	49211-10	Rubber Rope Hooks - 100-pc. Bag	17
48987-92-30	3" x 30' ANCRA X-TREME Ratchet Strap w/ 43366-14 Chain Anchors	32	49242-10-120	Winch Track - 10' Aluminum Double L	10
49015-18	18" Door Pull Strap	54	49246-10-BP	Winch Std Utility Trailer Track Slider w/ Clip	4
49015-24	24" Door Pull Strap	54	49288-10	TrackStar - Accessory Mounting Kit (8" Track & Hardware)	71
49015-36	36" Door Pull Strap	54	49313-13	Series L Track (Galvanized) 10', 1" Notched Holes	49
49020-20	6' Auto Tie Down Strap w/ Snap Hooks	62	49344-10	Coil Rack - Light Duty	15
49020-21	8' Auto Tie Down Strap w/ Snap Hooks	62	49344-12	Coil Rack - Heavy-Duty	15
49020-22	12' Auto Tie Down Strap w/ Snap Hooks	62	49345-10	Floor Chain Tie Down - Welded	25
49021-20	Series E HD Ratchet Buckle Strap - 12'	58	49346-10	4" x 27' Ratchet Strap w/ 41766-18 Flat Hooks - 5,400 lbs. WLL	35
49021-21	Series E HD Ratchet Buckle Strap - 16'	58	49346-11	4" x 30' Ratchet Strap w/ 41766-18 Flat Hooks - 5,400 lbs. WLL	35
49021-22	Series E HD Ratchet Buckle Strap - 20'	58	49346-12	4" x 27' Ratchet Strap w/ Narrow Wire Hooks - 6,600 lbs. WLL	35
49021-30	Series E HD TLR Ratchet Buckle Strap - 12'	55	49346-13	4" x 30' Ratchet Strap w/ Narrow Wire Hooks - 6,600 lbs. WLL	35
49021-31	Series E HD TLR Ratchet Buckle Strap - 16'	55	49346-14	4" x 27' Ratchet Strap w/ 43366-14 Chain Anchor - 5,400 lbs. WLL	35
49021-32	Series E HD TLR Ratchet Buckle Strap - 20'	55	49346-15	4" x 30' Ratchet Strap w/ 43366-14 Chain Anchor - 5,400 lbs. WLL	35
49023-20	Auto Tie Down - Series E w/ RTJ Hooks - 6'	63	49346-90-27	4" x 27' Ratchet Strap w/ 41766-18 Flat Hooks	33
49023-21	Auto Tie Down - Series E w/ RTJ Hooks - 8'	63	49346-90-30	4" x 30' Ratchet Strap w/ 41766-18 Flat Hooks	33
49023-22	Auto Tie Down - Series E w/ RTJ Hooks - 12'	63			
49025-20	Electronic Strap 12'	57			
49025-21	Electronic Strap 16'	57			
49025-22	Electronic Strap 20'	57			
49039-50	HD Series E Beam Assy - 96"	50			
49039-51	HD Series E Beam Assy - 102"	50			
49039-52	HD Series E Beam Assy - 106"	50			
49205-25	Heavy-Duty Jack Bar One-Piece - Galvanized - Bolt-on Feet - 85" - 104"	53			

INDEX BY PRODUCT NUMBER

49346-91-27	4" x 27' Ratchet Strap w/ 43366-14 Chain Anchors	33	49347-40	3" x 18" Strap w/ 43365-12 Grab Hook & Buckle	38
49346-91-30	4" x 30' Ratchet Strap w/ 43366-14 Chain Anchors	33	49347-41	3" x 25' Strap w/ 43365-12 Grab Hook.	38
49346-93-27	4" x 27' Ratchet Strap w/ 43120-13 Wire Hooks.	33	49347-42	3" x 28' Strap w/ 43365-12 Grab Hook.	38
49346-93-30	4" x 30' Ratchet Strap w/ 43120-13 Wire Hooks.	33	49348-11	Bar Keep Cargo Bar Holder	54
49347-10	2" x 18" Fixed End Strap w/ 40891-18 Flat Hook & Ratchet	37	49349-10	Ratchet Buckle - 4" - 8,000 lb. WLL	76
49347-11	2" x 25' Strap w/ 40891-10 Flat Hook.	37	49359-10	Series A Horizontal Track Aluminum.	49
49347-12	2" x 28' Strap w/ 40891-10 Flat Hook.	37	49360-13	Decking/Shoring Beam Steel Series E - 92.1" - 102.9" Long	50
49347-13	3" x 18" Strap w/ 41766-18 Flat Hook & Ratchet	38	49368-10	Strap Assy - 1" - Ratchet Buckle - 15' w/ Vinyl S Hooks, 4-pack	70
49347-14	3" x 25' Strap w/ 41766-18 Flat Hook - 15,000 lb.	38	49368-11	Strap Assy - 1" - Cam Buckle - 6' w/ Vinyl S Hooks, 4-pack	70
49347-15	3" x 28' Strap w/ 41766-18 Flat Hook - 15,000 lb.	38	49368-12	Strap Assy - 2 Cam, 2 Ratchet w/ Vinyl S Hooks, 4-pack	70
49347-16	4" x 18" Strap w/ 41766-18 Flat Hook & Ratchet	38	49371-10	Stake Pocket Anchor	54
49347-17	4" x 25' Strap w/ 41766-18 Flat Hook - 15,000 lb.	38	49377-10	Corner Protector - Steel for Chain	16
49347-18	4" x 28' Strap w/ 41766-18 Flat Hook - 15,000 lb.	38	49377-11	Rubber Coated Steel Corner Protector.	16
49347-19	2" x 18" Fixed End Strap w/ 43120-13 Wire Hook & Buckle	37	49382-10	Transmat 30" x 42" Section	54
49347-20	2" x 25' Adjustable End w/ 43120-13 Wire Hook	37	49384-12	Track Stop	42
49347-21	2" x 28' Adjustable End w/ 43120-13 Wire Hook	37	49400-10	Jack Bar Component Kit - Red Handle	52
49347-25	4" x 18" Strap w/ 43120-20 Narrow Hook & Buckle	38	49400-11	Jack Bar Component Kit - Black Handle	52
49347-26	4" x 25' Strap w/ 43120-20 Narrow Hook.	38	49410-13	Ratchet Buckle - 2" - 3,666 lb. WLL - TLR.	75
49347-27	4" x 28' Strap w/ 43120-20 Narrow Hook.	38	49414-15	LAD Beam Standard - 95.1" - 105.6"	41
49347-28	2" x 33" Fixed End Strap w/ 43366-21 Chain Anchor & Ratchet.	37	49414-15-RT	Replacement Tube for 49414-15 Standard LAD Beam.	42
49347-29	2" x 25' Strap w/ 43366-21 Chain Anchor	37	49414-19	LAD Beam Heavy-Duty - 95.2 - 105.6	41
49347-30	2" x 28' Strap w/ 43366-21 Chain Anchor	37	49414-19-RT	Replacement Tube for 49414-19 Heavy-Duty LAD Beam.	41
49347-31	3" x 33" Strap w/ 43366-12 Chain Anchor & Buckle	38	49414-21	Aftermarket Beam Standard - 97.3" - 108.8"	43
49347-32	3" x 25' Strap w/ 43366-12 Chain Anchor	38	49414-21-RT	Replacement Tube for 49414-21	43
49347-33	3" x 28' Strap w/ 43366-12 Chain Anchor	38	49439-10	Shoring Bar, F Series - Round	51
49347-34	4" x 33" Strap w/ 43366-14 Chain Anchor & Buckle	38	49439-11	Shoring Bar, F Series - Round (1" Hole Track).	51
49347-35	4" x 25' Strap w/ 43366-14 Chain Anchor	38	49439-20	Shoring Bar, F Series - Square	51
49347-36	4" x 28' Strap w/ 43366-14 Chain Anchor	38	49439-21	Shoring Bar, F Series - Square (1" Hole Track).	51
			49443-10	Housing Assembly (w/ Trigger, Set Screw, Rack & Lever)	52
			49445-12	Beam Release Bar	42
			49454-11	Rubber Rope - 3/8" Solid Core - 150' Roll	17
			49454-13	Rubber Rope - 7/16" Solid Core - 150' Roll	17
			49526-10	4" x 5' Strap w/ Hook for Roll-Off Containers	31
			49526-11	4" x 5' Strap w/ Sewn Loop End for Roll-Off Containers	31
			49526-90	4" x 5' ANCRA X-TREME Strap w/ Hook for Roll-Off Containers	31
			49526-91	4" x 5' ANCRA X-TREME Strap w/ Sewn Loop for Roll-Off Containers.	31

GENERAL INFORMATION

INDEX BY PRODUCT NUMBER

49527-10	GlideLock Slider Bracket - For Double L Track	15	49896-11	1/2" Forged Ring Assy w/ Weld-on Clip	13
49542-10	E Fitting w/ D-Ring	54, 83	49897-10	5/8" Forged Ring Assy w/ Weld-on Clip	13
49562-17-72.00	LAD Narrow Single Track	44	49898-10	3/4" Forged Ring Assy w/ Weld-on Clip	13
49577-10	Chain Corner Protector	16	49899-10	1" Forged Ring Assy w/ Weld-on Clip	13
49583-10	Floor Chain Tie Down - Bolt-on	25	49913-10	Tarp Protector	16
49584-10	Plastic Corner Protector	16	49914-10	Swivel J Idler Fitting - 3,333 lb. WLL	83
49603-10	TrackStar Wheelchock	71	49914-11	Swivel J Idler Fitting Low Profile - 3,333 lb. WLL	83
49706-10	Winch Standard Wilson Track Slider w/ Clip	5	49917-10	Bolt Plate, 1" 45 degree	81
49706-11	Winch Low Profile Wilson Track Slider w/ Clip	5	49917-11	Bolt Plate, 1" Flat	81
49715-10	Ratchet Buckle - 2"- 1,500 lb. WLL - TLR	75	49968-10	Bolt Plate, 2" 45 degree	81
49716-10	Porta Winch	8	50013-31	Screw Pin Anchor Shackle - Galvanized, 5/16", 1,500 lbs. WLL	22, 85
49716-11	Porta Winch Offset	8	50013-38	Screw Pin Anchor Shackle - Galvanized, 3/8", 2,000 lbs. WLL	22, 85
49717-10	Porta Anchor	8	50013-44	Screw Pin Anchor Shackle - Galvanized, 7/16", 3,000 lbs. WLL	22, 85
49717-11	Porta Anchor Offset	8	50013-50	Screw Pin Anchor Shackle - Galvanized, 1/2", 4,000 lbs. WLL	22, 85
49723-10	Silvercap Overdrive Ratcheting Cap	11	50013-63	Screw Pin Anchor Shackle - Galvanized, 5/8", 6,500 lbs. WLL	22, 85
49756-10	Steel Corner Protector	16	50013-75	Screw Pin Anchor Shackle - Galvanized, 3/4", 9,500 lbs. WLL	22, 85
49768-10	Sliding Double L Hook	13	50014-50	Clevis Pin Anchor Shackle - Galvanized, 1/2", 4,000 lbs. WLL	22, 85
49770-10	Waste Container J Hook - 5,100 lb. WLL	79	50014-63	Clevis Pin Anchor Shackle - Galvanized, 5/8", 6,500 lbs. WLL	22, 85
49789-10-120.00	Winch Track - 10' Aluminum Double L Low Profile	10	50015-10	ERGO 360 Winch Bar - Standard	12
49811-20L	Low Profile Foot and Channel Assembly	42	50015-20	ERGO 360 Winch Bar - Combination	12
49828-10-30	1/4" x 30' Cable Assembly w/ Chain Anchor	11	50015-21	ERGO 360 Winch Bar - Combination Box End	12
49828-10-32	1/4" x 32' Cable Assembly w/ Chain Anchor	11	50016-25	Quick Links - Zinc Plated, 1/4", 880 lbs. WLL	22, 85
49828-11-30	5/16" x 30' Cable Assembly w/ Chain Anchor	11	50016-31	Quick Links - Zinc Plated, 5/16", 1,760 lbs. WLL	22, 85
49828-11-32	5/16" x 32' Cable Assembly w/ Chain Anchor	11	50016-38	Quick Links - Zinc Plated, 3/8", 2,200 lbs. WLL	22, 85
49828-12-30	7/32" x 30' Cable Assembly w/ Chain Anchor	11	50017-10	Twin Clevis G70 - Zinc Plated, 5/16", 4,700 lbs. WLL	23, 86
49828-12-32	7/32" x 32' Cable Assembly w/ Chain Anchor	11	50017-11	Twin Clevis G70 - Zinc Plated, 3/8", 6,600 lbs. WLL	23, 86
49834-10	3 Bar Adjuster - 2"- 1,000 lb. WLL	77	50017-12	Twin Clevis G70 - Zinc Plated, 7/16", 11,300 lbs. WLL	23, 86
49880-12	12 Ton Bottle Jack w/ 2-Pc. Handle	89	50019-10	Slip Hooks G70 - Zinc Plated - No Latch, 1/4", 3,150 lbs. WLL	23, 86
49880-20	20 Ton bottle Jack w/ 2-Pc. Handle	89	50019-11	Slip Hooks G70 - Zinc Plated - No Latch, 5/16", 4,700 lbs. WLL	23, 86
49893-10	18" x 18" Safety Flag & Wooden Dowel	14	50019-12	Slip Hooks G70 - Zinc Plated - No Latch, 3/8", 6,600 lbs. WLL	23, 86
49893-11	18" x 18" Cotton Flag w/ Steel Rod	14			
49893-12	18" x 18" Red Flag w/ Grommets	14			
49893-13	18" x 18" PVC Coated Orange Flag & Wooden Dowel	14			
49893-14	18" x 18" PVC Coated Orange Flag w/ Grommets	14			
49894-10	18" x 84" Wide Oversized Load Banner w/ 4 Ropes	14			
49894-11	18" x 84" Wide Oversized Load Banner w/ 2 Ropes	14			
49894-12	14" x 72" Wide Oversized Load Banner w/ 4 Ropes	14			
49894-13	18" x 84" Oversized Load Mesh Banner	14			
49894-14	18" x 84" Wide Load Mesh Banner	14			
49895-10	12" x 96" Canadian D Sign w/ 8 Grommets	14			
49896-10	1/2" Forged Ring Assy w/ Bolt-on Clip	13			

INDEX BY PRODUCT NUMBER

50019-13	Slip Hooks G70 - Zinc Plated - No Latch, 1/2", 11,300 lbs. WLL	23, 86	50115-10	Series E Track Fitting - Heavy-Duty w/ Round Ring 2,000 lb. WLL	54, 82
50019-20	Slip Hooks G70 - Zinc Plated - w/ Safety Latch, 1/4", 3,150 lbs. WLL	23, 86	50115-11	Series E Track Fitting - Heavy-Duty w/ D-Ring 2,000 lb. WLL	54, 82
50019-21	Slip Hooks G70 - Zinc Plated - w/ Safety Latch, 5/16", 4,700 lbs. WLL	23, 86	50117-10	Lever Binder Locking Clip	25
50019-22	Slip Hooks G70 - Zinc Plated - w/ Safety Latch, 3/8", 6,600 lbs. WLL	23, 86	50140-10	EZ Binder Lever Load Binder	24
50019-23	Slip Hooks G70 - Zinc Plated - w/ Safety Latch, 1/2", 11,300 lbs. WLL	23, 86	50158-10	Series E Wide Top Decking Beam - 92.9" - 103.8"	50
50024-10	Tarp Hook	13	50179-10	2" x 102" Auto Hauler Ratchet Strap w/ Wire Hooks	62
50037-10	Ratchet Buckle - 2" - 3,666 lb. WLL - Web Keeper LWH.	75	50179-11	2" x 102" Auto Hauler Ratchet Strap w/ Low Profile Swivel J Hooks	62
50055-10	Beam Release Bar Holder	42	50186-10	Wide Top Aftermarket Beam - 97.2" - 108.8"	43
50058-18-72.00	LAD Flanged Single Track	44	50186-10-RT	Replacement Tube for 50186-10	43
50072-14-72.00	LAD Flanged Double Track	45	50188-10	Foot and Channel Assy for Aftermarket Beams	43
50080-11	Wide Top LAD Beam Assembly - 95.1" - 105.6"	41	50191-10	Heavy-Duty Aftermarket Beam - 97.3" - 108.8"	43
50080-11-RT	Replacement Tube for 50080-11	42	50191-10-RT	Replacement Tube for 50191-10	43
50089-12	X-TREME Corner Guards - 12" x 8" x 8" - Made In The USA	17	50192-14-72.00	LAD Standard Single Track	44
50089-24	X-TREME Corner Guards - 24" x 8" x 8" - Made In The USA	17	50193-30-72.00	Heavy-Duty Beveled Aircraft Style Track 72"	88
50089-36	X-TREME Corner Guards - 36" x 8" x 8" - Made In The USA	17	50194-100	Low Profile Allen Sleeve Nut and Bolt Kit for Beams	42, 43, 51
50089-48	X-TREME Corner Guards - 48" x 8" x 8" - Made In The USA	17	50199-10	Cargo Net for Short Bed Pickups	72
50090-31	5/16" x 67.5", WLL 4,700 lbs., Towed Machine Load Limit 16,100 lbs.	20	50199-11	Cargo Net for Long Bed Pickups	72
50090-38	3/8" x 69.0", WLL 6,600 lbs., Towed Machine Load Limit 20,200 lbs.	20	52210GL	Goldline EPDM Tarp Ties, 10" - 50 per Box	18
50090-50	1/2" x 70.0", WLL 11,300 lbs, Towed Machine Load Limit 40,500 lbs.	20	52210SE	Silverline Elite EPDM Tarp Ties, 10" - 50 per Box	18
50091-31	5/16" - G70 Clevis Hook w/ Keeper - WLL 4,700 lbs.	21, 84	52210	Silverline Rubber Tarp Ties, 10" - 50 per Box	18
50091-38	3/8" - G70 Clevis Hook w/ Keeper - WLL 6,600 lbs.	21, 84	52215GL	Goldline EPDM Tarp Ties, 15" - 50 per Box	18
50091-50	1/2" - G70 Clevis Hook w/ Keeper - WLL 11,300 lbs.	21, 84	52215SE	Silverline Elite EPDM Tarp Ties, 15" - 50 per Box	18
50092-10	EZ Winder Web Winder	13	52215	Silverline Rubber Tarp Ties, 15" - 50 per Box	18
500-C8-RD	2" x 8' Red Ratchet Strap w/ Twisted Snap Hook	63	52221GL	Goldline EPDM Tarp Ties, 21" - 50 per Box	18
50105-10	Poly Deck Board for LAD System for 16" Beam Center.	46	52221SE	Silverline Elite EPDM Tarp Ties, 21" - 50 per Box	18
50105-11	Poly Deck Board for LAD System for 24" Beam Center.	46	52221	Silverline Rubber Tarp Ties, 21" - 50 per Box	18
			52231GL	Goldline EPDM Tarp Ties, 31" - 50 per Box	18
			52231SE	Silverline Elite EPDM Tarp Ties, 31" - 50 per Box	18

INDEX BY PRODUCT NUMBER

52231	Silverline Rubber Tarp Ties, 31"- 50 per Box	18
52241GL	Goldline EPDM Tarp Ties, 41"- 50 per Box	18
52241SE	Silverline Elite G4EPDM Tarp Ties, 41"- 50 per Box	18
52241	Silverline Rubber Tarp Ties, 41"- 50 per Box	18
95001	1" x 8' Cam Straps w/ Vinyl-Coated S Hooks, 2-pack	70
95002	1" x 10' Ratchet Straps Vinyl-Coated S Hooks, 2-pack	71
95003	1" x 6' Retractable Ratchet Straps w/ Vinyl Coated S Hooks, 2-pack	71
95004	1" x 8' Cam Straps w/ Vinyl-Coated S Hooks, 4-pack	71
95005	1" x 10' Ratchet Straps w/ Vinyl-Coated S Hooks, 4-pack	71
95006	Two 1" Cam Straps & Two 1" Ratchet Straps w/ Vinyl-Coated S Hooks, 4-pack	71
95007	1" x 12' Endless Ratchet Straps, 2-pack	71

INDEX BY PRODUCT NAME

Adjuster, 3-Bar Slide	77	Clevis Hooks	21, 84	Jacks, Bottle	89
Anchor, Chain	83	Clevis, Twin	23, 86	Load Binder	24, 25
Auto Tie Downs	62, 63, 64	Coil Racks	15	Lift-A-Deck II	40, 41–45
Banners, Safety	14	Corner Protectors	16, 17	Lift-A-Deck II Straps	45
Bar, Beam Release	42	Forged D-Rings	13	Lift-A-Deck Poly Deck Board	46
Bars, Cargo Sta	52	Decking Beam Hoops	50	Lifting Slings	66, 67, 68
Bars, Jack	53	Decking/Shoring Beams	41, 43, 50	Links, Quick	22, 85
Bars, Shoring	51	Dolly Straps	63	Locking Clip, Lever Binder	25
Bars, Winch	12	Door Pull Straps	54	Merchandising Aids	90
Beam, Foot & Channel Assembly	41, 42, 51	Electronic Restraint Straps	57	Mini Ratchet Strap	70
Beam Release Bar	42	ERGO 360 Winch Bars	12	Nets, Cargo	72
Beam Release Bar Holder	42	EZ Binder	24	Nets, Custom	59
Beam Replacement Tube	42	EZ Winder	13	Overcenter Buckles	76
Beam Sockets	51	F Series - Shoring Bar	51	Pan Fittings	54
Beam, Garment	51	Fittings, Pan	54	Poly Deck Board, LAD	46
Beams, Decking/Shoring	41, 43, 50, 51	Fittings, Track	82, 83, 88,	Plate Trailer Straps	57, 58
Binders, Chain Load	24, 25	Flag, Safety	14	Plates, Bolt	81
Binder, Ratchet	25	Flat Hooks	79	PortaAnchor	8
Binder, Recoilless	24	Floor Chain Tie Down	25	PortaWinch	8
Bolt Plates	81	Friction Mat	54	Protectors, Corner	16, 17
Bottle Jacks	89	Garment Beam	51	Protector, Tarp	16
Buckle, Roller	77	Garment Rope	51	Protectors, Web	16
Buckles, Cam	77	GlideLock	15	Ratchet Buckle Strap	
Buckles, Overcenter	76	Goldline EPDM Tarp Ties	18	Replacements	37, 38
Buckles, Ratchet	74, 75, 76	Grab Hook Assembly	84	Ratchet Buckle Strap, Series E	55, 58
Cable Assemblies	11	Holder, Cargo Bar	54	Ratchet Strap	
Cam Buckle Strap		Hook, Clevis	21, 84	Assemblies	32–38, 58, 62, 63, 70
Assemblies	45, 56, 57, 70, 71	Hook, Container	79	Ratchet Strap Assy, Web Keeper	36
Cam Buckles	77	Hook, Corner Iron	13	Ratchet Strap, Mini	70
Cargo Bar Holder	54	Hook, Double L Track Slider	13	Ratchet Buckles	74, 75, 76
Cargo Nets	72	Hook, Grab	84	Ratcheting Cap, OverDrive	11
Cargo Sta	52	Hook, H-2	13	Retract-A-Roll II	47
Cargo Sta Replacements	52	Hook, H-2	13	Rings	80
Cargo Sta, Hoop Set	52	Hook, H-2	13	Rings, Delta	80
Chain	19, 20	Hook, H-2	13	Roll-On/Roll-Off Container Straps	31
Chain Anchor	83	Hook, H-2	13	Roller Buckle	77
Chain Assemblies	19, 20	Hook, H-2	13	Rope Tie Offs	54
Chain		Hook, H-2	13	Rope, Rubber	17
Attachments	21, 22, 23, 83, 84, 85, 86	Hook, H-2	13	RTJ Cluster Hook	84
Chain Binder, Lever	24	Hook, H-2	13	Rubber Rope	17
Chain Binder, Ratchet	25	Hook, H-2	13	Rubber Rope Hook	17
Chain Binder, Recoilless	24	Hook, H-2	13	Series A Track	49
Chain Binder, Safety Clip	25	Hook, H-2	13	Series E Heavy-Duty Strap	56
Chain		Hook, H-2	13	Series E Ratchet Buckle Strap	55, 58
Hardware	21, 22, 23, 83, 84, 85, 86	Hook, H-2	13	Series E Track	48
Channel Assembly,		Hook, H-2	13	Series E Transit Strap	63
Replacement	42, 43, 51	Hook, H-2	13	Series F Channel Track	49

INDEX BY PRODUCT NAME

Series F Track	49	Track Fittings	54, 82, 83, 88
Shackles	22, 85	Track, Heavy-Duty	88
Shoring Bar - F Series	51	Track, Series A	49
Silverline Elite EPDM Tarp Ties	18	Track, Series E	48
Silverline Tarp Ties	18	Track, Series F	49
Slings, Eye to Eye Web	67, 68	Track, Series F Channel	49
Slings, Round	66	Track Stop	42
Slip Hooks	21, 84, 86	Trackstar Accessory Mounting Kit	71
SilverCap OverDrive Ratcheting Cap	11	Trackstar WheelChock	71
Snap Hooks	80	Transmat	54
Socket, Beam	51	Truck & Trailer Fittings (pan, anchor)	54
Stake Pocket Anchor	54	Utility Strap	70
Strap, Ancra Lash	70	Web Protectors	16
Strap, Ratchet		Web Winder	13
Assembly	32- 38, 58, 62, 63, 70	Webbing	87
Strap, Cam Buckle		WheelChock	71
Assembly	45, 56, 57, 70, 71	Winch Bars	12
Strap, Lift-A-Deck II Assemblies	45	Winch Straps	26, 27, 28, 29, 30, 31, 62
Strap, Mini Ratchet	70	Winch Track	10
Strap, Motorcycle	70	Winches Web	2, 3, 4, 5, 7
Strap, Series E	56	Winch, Cable	6
Strap, Series E Transit	63	Winches, Combination	6
Straps, Cam Buckle	45, 56, 57, 70, 71	Winches, Lashing	7, 64
Straps, Container	31	Winches, PortaWinch, PortaAnchor	8
Straps, Door Pull	54	Winches, Sliders	3, 4, 5
Straps, Electronic	57	Winder, Web	13
Straps, Plate Trailer	57, 58	Wire Hooks	78
Straps, Ratchet		Winches, 3-Bar	5
Buckle	32-38, 58, 62, 63, 70	X-TREME Guard Corner Protector	17
Straps, Series F	56	X-TREME Winch Strap,	
Straps, Tension Limiting Ratchet	55	Assemblies	26, 27, 28, 31, 32, 33, 36
Straps, Transit w/ RTJ Hooks	63		
Straps, Utility	70, 71		
Straps, Winch	26, 27, 28, 29, 30, 31		
Tarp Protector	16		
Tarp Ties	18		
Tension Limiting Ratchet Assemblies	55		
Tie Downs, Auto	62, 63		
Tie Downs, Cam Buckle Packaged	70, 71		
Tie Downs, Combo Packs	70, 71		
Tie Downs, Floor Chain	25		
Tie Downs, Ratcheting Packaged	70, 71		
Tie Offs	54		
Ties, Tarp	18		
Tire Bonnets	64		
Track, Lift-A-Deck II	44, 45		
Track, Aircraft	88		



CARGO SYSTEMS DIVISION HEADQUARTERS

Ancra Cincinnati

2685 Circleport Drive, Erlanger, KY 41018
Phone: 1-859-371-7272
Phone Toll Free (U.S.): 1-800-233-5138
Phone Toll Free (Canada): 1-800-929-2627

Fax: 1-859-371-4367
Fax Toll Free: 1-800-347-2627
E-mail: cargo-sales@ancra.com

WAREHOUSE / SHIPPING FACILITIES

Ancra Cincinnati

Erlanger, KY 41018

Pacific Northwest

Accord Distributors
9822 47th Avenue SW, Lakewood, WA 98449

Southwest

301 VZ County Road 1117, Grand Saline, TX 75140

Ancra Canada

520 Beard Lane, Suite A
Woodstock, Ontario N4S 7W3
Phone: 1-519-937-9170
Phone Toll Free: 1-866-962-0055
Fax: 1-519-602-0980
Fax Toll Free: 1-866-792-0058
E-mail: cargo-salescanada@ancra.com



CARGO SYSTEMS DIVISION HEADQUARTERS

Ancra Cincinnati

2685 Circleport Drive, Erlanger, KY 41018

Phone: 1-859-371-7272

Phone Toll Free (U.S.): 1-800-233-5138

Phone Toll Free (Canada): 1-800-929-2627

Fax: 1-859-371-4367

Fax Toll Free: 1-800-347-2627

E-mail: cargo-sales@ancra.com