

## TABLE DES MATIÈRES TABLE OF CONTENTS

<b>Identification des filets / Thread identification</b> .....	<b>I</b>
<b>Guide visuel / Visual guide</b> .....	<b>page II</b>
<b>NPTF (pipe thread)</b> .....	<b>page 1</b>
<b>NPSM (pipe swivel)</b> .....	<b>page 5</b>
<b>JIC (37° flare)</b> .....	<b>page 8</b>
<b>BSPP</b> .....	<b>page 29</b>
<b>Métrique / Metric</b> .....	<b>page 37</b>
<b>ORFS (o'ring face)</b> .....	<b>page 42</b>
<b>ORB (o'ring boss)</b> .....	<b>page 48</b>
<b>Adaptateur tube / Adapter tube</b> .....	<b>page 51</b>
<b>SAE 45 (45° flare)</b> .....	<b>page 56</b>
<b>Compression / Flareless</b> .....	<b>page 57</b>
<b>Métrique compression / Flareless metric</b> .....	<b>page 58</b>
<b>Jointts tournants droits / Inline swivels</b> .....	<b>page 60</b>
<b>Jointts tournants 90° / 90° swivels</b> .....	<b>page 61</b>
<b>Jointts d'étanchéité et écrous / O'rings and nuts</b> .....	<b>page 66</b>
<b>Ensembles / Kits</b> .....	<b>page 69</b>

## IDENTIFICATION DES FILETS / THREAD IDENTIFICATION

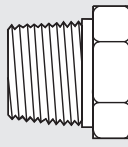

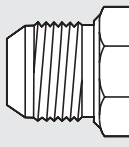
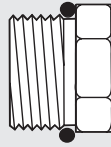
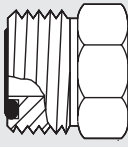
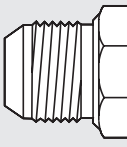
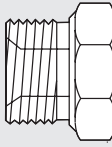







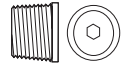



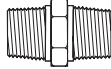
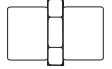

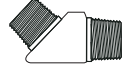
						
Dimension Size	NPTF PIPE	JIC 37° Flare	O'ring boss	O'ring face	SAE 45° Flare	BSPP
1/8	0.400 1/8-27	0.313 5/16-24	0.313 5/16-24	-----	0.313 5/16-24	0.370 1/8-28
3/16	-----	0.375 3/8-24	0.375 3/8-24	-----	0.375 3/8-24	-----
1/4	0.530 1/4-18	0.438 7/16-20	0.438 7/16-20	0.563 9/16-18	0.438 7/16-20	0.510 1/4-19
5/16	-----	0.500 1/2-20	0.500 1/2-20	-----	0.500 1/2-20	-----
3/8	0.675 3/8-18	0.563 9/16-18	0.563 9/16-18	0.688 11/16-16	0.625 5/8-18	0.645 3/8-19
1/2	0.825 1/2-14	0.750 3/4-16	0.750 3/4-16	0.813 13/16-16	0.750 3/4-16	0.825 1/2-14
5/8	-----	0.875 7/8-14	0.875 7/8-14	1.000 1-14	0.875 7/8-14	0.895 5/8-14
3/4	1.040 3/4-14	1.063 1 1/16-12	1.063 1 1/16-12	1.188 1 3/16-12	1.063 1 1/16-14	1.040 3/4-14
7/8	-----	1.188 1 3/16-12	1.188 1 3/16-12	-----	-----	-----
1	1.300 1-11 1/2	1.313 1 5/16-12	1.313 1 5/16-12	1.438 1 7/16-12	-----	1.300 1-11
1 1/4	1.650 1 1/4-11 1/2	1.625 1 5/8-12	1.625 1 5/8-12	1.688 1 11/16-12	-----	1.640 1 1/4-11
1 1/2	1.885 1 1/2-11 1/2	1.875 1 7/8-12	1.875 1 7/8-12	2.000 2-12	-----	1.880 1 1/2-11
2	2.360 2-11 1/2	2.500 2 1/2-12	2.500 2 1/2-12	-----	-----	2.340 2-11

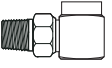
## MÉTRIQUE / METRIC

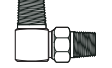
LÉGÈRE LIGHT		LOURDE HEAVY	
Tube	Filetage Thread	Tube	Filetage Thread
6MM	M12X1.5	6MM	M14X1.5
8MM	M14X1.5	8MM	M16X1.5
10MM	M16X1.5	10MM	M18X1.5
12MM	M18X1.5	12MM	M20X1.5
15MM	M22X1.5	14MM	M22X1.5
18MM	M26X1.5	16MM	M24X1.5
22MM	M30X2.0	20MM	M30X2.0
28MM	M36X2.0	25MM	M36X2.0
35MM	M45X2.0	30MM	M42X2.0
42MM	M52X2.0	38MM	M52X2.0

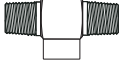

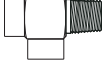

# NPTF (PIPE THREAD)

## NPTF-NPTF

 <b>24ST</b> Plug hex. head M-NPTF page 1	 <b>24SR</b> Plug hex. socket M-NPTF page 1	 <b>25SP</b> Plug square head M-NPTF page 1	 <b>24SF</b> Plug F-NPTF page 1	 <b>24SB</b> M-NPTF F-NPTF page 1	 <b>24SG</b> F-NPTF M-NPTF page 2	 <b>24SA</b> M-NPTF M-NPTF page 2	 <b>24SJ</b> F-NPTF F-NPTF page 2
 <b>25TG</b> M-NPTF F-NPTF page 2	 <b>25TA</b> M-NPTF M-NPTF page 3	 <b>25TJ</b> F-NPTF F-NPTF page 3	 <b>25UG</b> M-NPTF F-NPTF page 3	 <b>25UGSW</b> M-NPTF swivel F-NPTF page 3	 <b>25UJ</b> F-NPTF F-NPTF page 3	 <b>25UA</b> M-NPTF M-NPTF page 3	 <b>25UASW</b> M-NPTF M-NPTF swivel page 4
 <b>25VC</b> TE F-M-F NPTF page 4	 <b>25VJ</b> TE F-F-F NPTF page 4	 <b>25VG</b> TE M-F-M NPTF page 4	 <b>25VT</b> TE F-M-M NPTF page 4	 <b>25VK</b> TE F-F-M NPTF page 4	 <b>25VA</b> TE M-M-M NPTF page 5	 <b>25WJ</b> Cross F-F-F-F NPTF page 5	

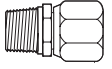
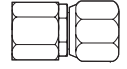
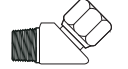
# NPSM (PIPE SWIVEL)

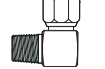
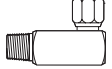
## NPSM-NPTF

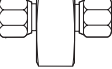
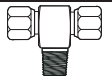
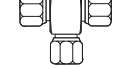











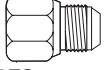
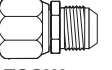
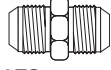
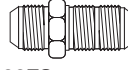

 <b>60SA-61SA</b> M-NPTF F-NPSM swivel page 5	 <b>60SG</b> F-NPTF F-NPSM swivel page 5	 <b>60TA</b> M-NPTF F-NPSM swivel page 6	 <b>60TG</b> F-NPTF F-NPSM swivel page 6	 <b>60UA</b> M-NPTF F-NPSM swivel page 6	 <b>60UC</b> M-NPTF long F-NPSM swivel page 6	 <b>60UG</b> F-NPTF F-NPSM swivel page 7	 <b>60VH</b> TE-F-F-F F-NPTF/F-NPSM swivel page 7
 <b>60VC</b> TE-F-M-F M-NPTF/F-NPSM swivel page 7	 <b>60VJ</b> TE-F-F-F F-NPSM swivel page 7						

## NPSM-ORB

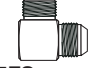
 <b>60SB</b> M-ORB F-NPSM swivel page 7	 <b>60TB</b> M-ORB F-NPSM swivel page 8	 <b>60UB</b> M-ORB F-NPSM swivel page 8					
--	--	--	--	--	--	--	--



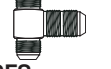
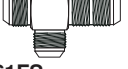
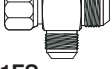
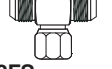



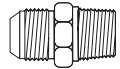
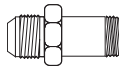
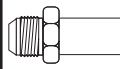
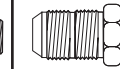
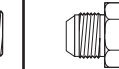
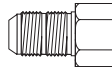

# JIC (37° FLARE)

## JIC-JIC

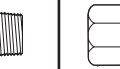
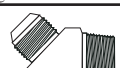
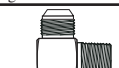
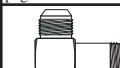
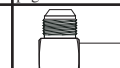
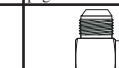

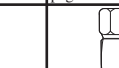
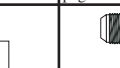
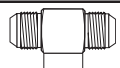
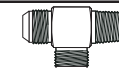
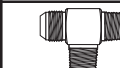
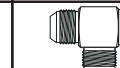

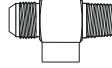

 <b>830FS</b> Plug F-JIC page 8	 <b>839FS</b> Plug M-JIC page 8	 <b>840FS</b> Sleeve JIC page 9	 <b>841FS</b> Nut JIC page 9	 <b>883FS</b> F-JIC solid M-JIC page 9	 <b>883FSSW</b> F-JIC swivel M-JIC page 10	 <b>842FS</b> M-JIC M-JIC page 10	 <b>832FS</b> M-JIC M-JIC bulkhead page 10
 <b>880FS</b> F-JIC swivel F-JIC swivel page 10	 <b>856FS</b> M-JIC M-JIC page 11	 <b>854BHFS</b> M-JIC M-JIC bulkhead page 11	 <b>889FS</b> F-JIC swivel M-JIC page 11	 <b>855FS</b> M-JIC M-JIC page 11	 <b>855BHFS</b> M-JIC M-JIC bulkhead page 11	 <b>879FS</b> F-JIC swivel M-JIC page 11	 <b>875FS</b> F-JIC swivel F-JIC swivel page 12
 <b>844FS</b> TE M-M-M JIC page 12	 <b>870FS</b> TE M-M-M M-JIC bulkhead page 12	 <b>861FS</b> TE M-M-M M-JIC bulkhead page 12	 <b>871FS</b> TE F-M-M M-JIC / F-JIC swivel page 12	 <b>872FS</b> TE M-F-M M-JIC / F-JIC swivel page 13	 <b>873FS</b> TE F-F-F F-JIC swivel page 13	 <b>852FS</b> Cross M-JIC page 13	

# JIC (37° FLARE)

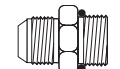
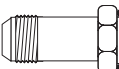
## JIC-NPTF

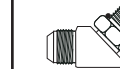
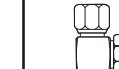
 <b>848FS</b> M-JIC M-NPTF page 13	 <b>848LFS</b> M-JIC M-NPTF long page 14	 <b>848LLFS</b> M-JIC M-NPTF X-long page 14	 <b>848BHFS</b> M-JIC bulkhead M-NPTF page 14	 <b>846FS</b> M-JIC F-NPTF page 14	 <b>847FS</b> M-JIC bulkhead F-NPTF page 15	 <b>881FS</b> F-JIC swivel M-NPTF page 15	 <b>882FS</b> F-JIC swivel F-NPTF page 15
 <b>854FS</b> M-JIC M-NPTF page 15	 <b>849FS</b> M-JIC M-NPTF page 16	 <b>849LFS</b> M-JIC M-NPTF long page 16	 <b>849LLFS</b> M-JIC M-NPTF X-long page 16	 <b>850FS</b> M-JIC F-NPTF page 17	 <b>878FS</b> F-JIC swivel M-NPTF page 17	 <b>877FS</b> F-JIC swivel F-NPTF page 17	 <b>845FS</b> TE M-M-M M-JIC / M-NPTF page 17
 <b>858FS</b> TE M-F-M M-JIC / F-NPTF page 18	 <b>851FS</b> TE M-M-M M-JIC / M-NPTF page 18	 <b>853FS</b> TE M-M-M M-JIC / M-NPTF page 18	 <b>857FS</b> TE M-M-F M-JIC / F-NPTF page 18	 <b>860FS</b> TE M-M-F M-JIC / (M/F)-NPTF page 18	 <b>859FS</b> TE M-F-M M-JIC / (M/F)-NPTF page 19	 <b>862FS</b> TE F-M-F M-JIC / F-NPTF page 19	 <b>863FS</b> TE M-F-F M-JIC / F-NPTF page 19

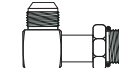
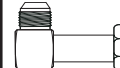
## JIC-ORB

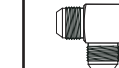
 <b>848FSO</b> M-JIC M-ORB page 19	 <b>848LFSO</b> M-JIC M-ORB long page 20	 <b>881FSO</b> F-JIC swivel M-ORB page 20	 <b>854FSO</b> M-JIC M-ORB page 20	 <b>878FSO</b> F-JIC swivel M-ORB page 20
 <b>849FSO</b> M-JIC M-ORB page 21	 <b>849LFSO</b> M-JIC M-ORB long page 21	 <b>849LLFSO</b> M-JIC M-ORB X-long page 21	 <b>845FSO</b> TE M-M-M M-JIC / M-ORB page 21	 <b>851FSO</b> TE M-M-M M-JIC / M-ORB page 22

## JIC-INV.

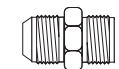
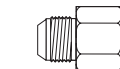
 <b>848FSV</b> M-JIC M-inverted flare page 22	 <b>846FSV</b> M-JIC F-inverted flare page 22



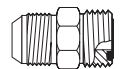
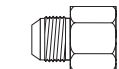
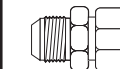
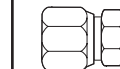





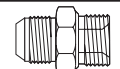
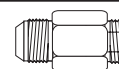
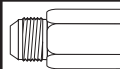
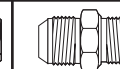

## JIC-ORFS

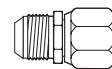
 <b>848TTJ</b> M-JIC M-ORFS page 22	 <b>846TTJ</b> M-JIC F-ORFS solid page 22	 <b>846TTJSW</b> M-JIC F-ORFS swivel page 22	 <b>881TTJ</b> F-JIC swivel M-ORFS page 23
--	--	---	---

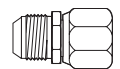
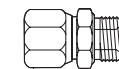
## JIC-BANJO

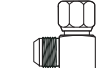

 <b>848FSBJ</b> M-JIC Banjo page 23		
--	--	--

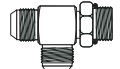
## JIC-BSPP

 <b>848FSB</b> M-JIC M-BSPP page 23	 <b>848FSBL</b> M-JIC M-BSPP long page 23	 <b>848FSBLL</b> M-JIC M-BSPP X-long page 24	 <b>848FSJ</b> M-JIC M-JIS page 24	 <b>846FSB</b> M-JIC F-BSPP solid page 24	 <b>846FSBSW</b> M-JIC F-BSPP swivel page 24	 <b>846FSJ</b> M-JIC F-JIS page 24	 <b>846FSH</b> M-JIC F-BSPP flat-face solid page 24
 <b>846FSHSW</b> M-JIC F-BSPP flat-face swivel page 25	 <b>881FSB</b> F-JIC swivel M-BSPP page 25	 <b>882FSB</b> F-JIC swivel F-BSPP swivel page 25	 <b>854FSB</b> M-JIC M-BSPP adj. page 25	 <b>849FSB</b> M-JIC M-BSPP adj. page 25	 <b>850FSB</b> M-JIC F-BSPP swivel page 25	 <b>878FSB</b> F-JIC swivel M-BSPP page 26	 <b>845FSB</b> TE M-M-M M-JIC / M-BSPP adj. page 26
 <b>851FSB</b> TE M-M-M M-JIC / M-BSPP adj. page 26							

# JIC (37° FLARE)

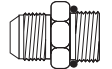
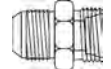
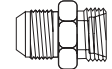
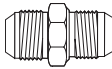
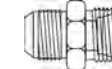
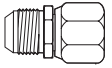
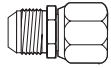
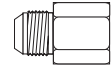
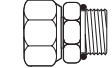
## JIC-METRIC





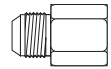
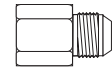





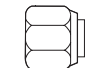
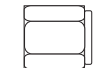

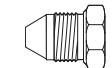

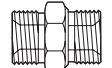
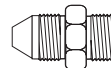
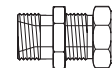
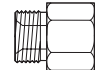
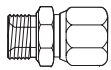
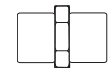
 <b>848FSM</b> (port only) M-JIC M-METRIC page 26	 <b>848FSML</b> (port and tube) M-JIC M-METRIC light (P.26)	 <b>848FSMH</b> (port and tube) M-JIC M-METRIC heavy(P.27)	 <b>848FSK</b> M-JIC M-KOMATSU page 27	 <b>848FSKB</b> M-JIC M-KOBELCO page 27
 <b>846FSML</b> M-JIC F-METRIC swivel light page 27	 <b>846FSMH</b> M-JIC F-METRIC swivel heavy page 28	 <b>846FSK</b> M-JIC F-KOMATSU page 28	 <b>881FSM</b> F-JIC swivel M-METRIC page 28	 <b>849FSM</b> M-JIC M-METRIC adj. page 28

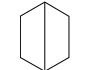
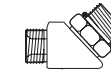
## JIC-SAE45

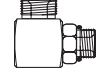
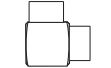
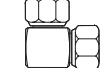
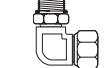
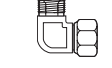
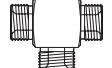

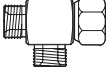
 <b>835FS</b> M-JIC F-SAE45 solid page 28	 <b>836FS</b> F-JIC solid M-SAE45 page 29
--	--

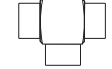
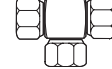
# BSPP

## BSPP-BSPP

 <b>630FS</b> Plug F-BSPP swivel page 29	 <b>630FSJ</b> Plug F-JIS page 29	 <b>639FS</b> Plug M-BSPP hex. head page 29	 <b>639FSJ</b> Plug M-JIS page 29	 <b>639FSR</b> Plug M-BSPP hex. socket page 29	 <b>642FS</b> M-BSPP M-BSPP page 30	 <b>642FSJ</b> M-JIS M-JIS page 30	 <b>632FS</b> M-BSPP M-BSPP bulkhead page 30
 <b>683FS</b> M-BSPP F-BSPP solid page 30	 <b>683FSSW</b> M-BSPP F-BSPP swivel page 31	 <b>680FS</b> F-BSPP solid F-BSPP solid page 31	 <b>680FSSW</b> F-BSPP swivel F-BSPP swivel page 31	 <b>698FS</b> BSPP flat-face Sealing seat page 32	 <b>699FS</b> BSPP-JIS Sealing seat page 32	 <b>656FSA</b> M-BSPP M-BSPP adj. page 32	 <b>655FS</b> M-BSPP M-BSPP page 32
 <b>655FSA</b> M-BSPP M-BSPP adj. page 32	 <b>674FS</b> F-BSPP solid F-BSPP solid page 32	 <b>675FS</b> F-BSPP swivel F-BSPP swivel page 33	 <b>679FS</b> M-BSPP adj. F-BSPP swivel page 33	 <b>679FSB</b> M-BSPP F-BSPP swivel page 33	 <b>644FS</b> TE M-M-M M-BSPP page 33	 <b>670FS</b> TE M-M-M M-BSPP/M-BSPP adj. page 33	 <b>661FS</b> TE M-M-M M-BSPP/M-BSPP adj. page 33
 <b>671FS</b> TE M-M-F M-BSPP/F-BSPP swivel page 34	 <b>672FS</b> TE M-F-M M-BSPP/F-BSPP swivel page 34	 <b>673FS</b> TE F-F-F F-BSPP solid page 34	 <b>673FSSW</b> TE F-F-F F-BSPP swivel page 34	 <b>677FS</b> TE M-F-F M-BSPP/F-BSPP swivel page 34			

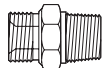
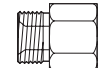
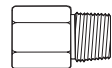
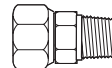
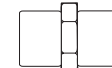

## BSPP-NPTF

 <b>648FS</b> M-BSPP M-NPTF page 34	 <b>646FS</b> M-BSPP F-NPTF page 35	 <b>681FS</b> F-BSPP solid M-NPTF page 35	 <b>681FSSW</b> F-BSPP swivel M-NPTF page 35	 <b>682FS</b> F-BSPP solid F-NPTF page 35	 <b>649FS</b> M-BSPP M-NPTF page 36		
--	--	--	---	--	--	--	--

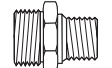
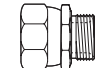
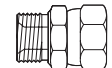
## BSPP-METRIC

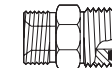
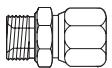

 <b>648FSM</b> M-BSPP M-METRIC page 36	 <b>681FSM</b> F-BSPP swivel M-METRIC page 36	 <b>646FSM</b> M-BSPP F-METRIC swivel page 36
---	--	--

## BSPP-ORFS

 <b>648TT</b> M-BSPP M-ORFS page 36	 <b>646TT</b> M-BSPP F-ORFS swivel page 36	 <b>649TT</b> M-BSPP adj. M-ORFS page 37
--	---	---













# BSPP

## BSPP-ORB



 <b>648FSO</b> M-BSPP M-ORB page 37	 <b>646FSO</b> M-BSPP F-ORB page 37	 <b>681FSO</b> F-BSPP solid F-ORB page 37					
--	--	--	--	--	--	--	--

# METRIC



## METRIC-METRIC

 <b>630FSM</b> Plug F-METRIC page 37	 <b>639FSM</b> Plug M-METRIC page 38	 <b>639FSMR</b> Plug M-METRIC socket page 38	 <b>639FSMO</b> Plug M-METRIC o'ring page 38	 <b>630FSK</b> Plug F-Komatsu page 39	 <b>639FSK</b> Plug M-Komatsu page 39	 <b>642FSM</b> M-METRIC M-METRIC page 39	 <b>642FSK</b> M-Komatsu M-Komatsu page 39
 <b>680FSM</b> F-METRIC swivel F-METRIC swivel page 39	 <b>683FSML</b> M-METRIC F-METRIC swivel light page 39	 <b>683FSMH</b> M-METRIC F-METRIC swivel heavy page 40	 <b>683FSMS</b> M-METRIC F-METRIC solid page 40				

## METRIC-ORB

 <b>626FSO</b> M-METRIC F-ORB page 40	 <b>623FSO</b> F-METRIC solid F-ORB page 40	
---	---	--

## METRIC-ORFS

















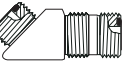

 <b>618TT</b> M-METRIC M-ORFS page 40	 <b>619TT</b> M-METRIC adj. M-ORFS page 41		
---	--	--	--

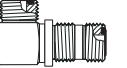
## METRIC-NPTF

 <b>626FS</b> M-METRIC F-NPTF page 41	 <b>622FS</b> F-METRIC solid M-NPTF page 41	 <b>628FS</b> M-METRIC M-NPTF page 41					
--	--	--	--	--	--	--	--





# ORFS (O'RING FACE)

## ORFS-ORFS



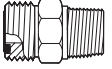
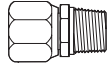
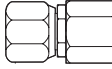

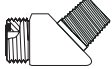

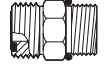
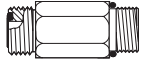

 <b>841TT</b> Nut ORFS page 42	 <b>883TT</b> (2 pieces) F-ORFS swivel M-ORFS page 42	 <b>883TTR</b> F-ORFS solid M-ORFS page 42	 <b>830TT</b> Plug F-ORFS page 42	 <b>839TT</b> Plug M-ORFS page 42	 <b>842TT</b> M-ORFS M-ORFS page 42	 <b>832TT</b> M-ORFS M-ORFS bulkhead page 43	 <b>880TT</b> F-ORFS swivel F-ORFS swivel page 43
 <b>889TT</b> M-ORFS F-ORFS swivel page 43	 <b>854BH TT</b> M-ORFS M-ORFS bulkhead page 43	 <b>855TT</b> M-ORFS M-ORFS page 43	 <b>855BH TT</b> M-ORFS M-ORFS bulkhead page 44	 <b>879TT</b> M-ORFS F-ORFS swivel page 44	 <b>844TT</b> TE M-M-M M-ORFS page 44	 <b>870TT</b> TE M-M-M M-ORFS bulkhead page 44	 <b>861TT</b> TE M-M-M M-ORFS bulkhead page 44
 <b>871TT</b> TE F-M-M M-ORFS / F-ORFS swivel page 44	 <b>872TT</b> TE M-F-M M-ORFS / F-ORFS swivel page 45	 <b>852TT</b> Cross M-ORFS page 45					

# ORFS (O'RING FACE)

## ORFS-NPTF







 <b>848TT</b> M-ORFS M-NPTF page 45	 <b>881TT</b> F-ORFS swivel M-NPTF page 45	 <b>882TT</b> F-ORFS swivel F-NPTF page 45	 <b>846TT</b> M-ORFS F-NPTF page 46	 <b>854TT</b> M-ORFS M-NPTF page 46	 <b>849TT</b> M-ORFS M-NPTF page 46		
--	---	---	--	--	--	--	--

## ORFS-ORB

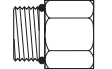



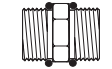

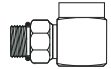
 <b>848TTO</b> M-ORFS M-ORB page 46	 <b>848LTTO</b> M-ORFS M-ORB long page 47	 <b>846TTO</b> M-ORFS F-ORB page 47	 <b>881TTO</b> F-ORFS swivel M-ORB page 47	 <b>854TTO</b> M-ORFS M-ORB adj. page 47	 <b>878TTO</b> F-ORFS swivel M-ORB adj. page 47	 <b>849TTO</b> M-ORFS M-ORB adj. page 48	 <b>845TTO</b> TE M-M-M M-ORFS / M-ORB adj. page 48
 <b>851TTO</b> TE M-M-M M-ORFS / M-ORB adj. page 48							

# ORB (O'RING BOSS)

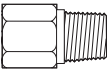
## ORB-ORB

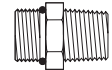

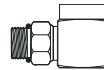
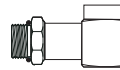
 <b>719FSO</b> M-ORB F-ORB page 48	 <b>721FSO</b> Plug M-ORB hex. head page 49	 <b>723FSO</b> Plug M-ORB hex. socket page 49	 <b>780FSO</b> F-ORB F-ORB page 49	 <b>742FSO</b> M-ORB M-ORB page 49	 <b>755FSO</b> M-ORB adj. M-ORB adj. page 49	 <b>779FSO</b> M-ORB adj. F-ORB page 49	
---	--	--	---	---	---	--	--

## ORB-NPTF

 <b>728FSO</b> F-ORB M-NPTF page 50	 <b>726FSO</b> F-ORB F-NPTF page 50	 <b>722FSO</b> M-ORB M-NPTF page 50	 <b>720FSO</b> M-ORB F-NPTF page 50	 <b>725FSO</b> M-ORB adj. F-NPTF page 51	 <b>725LFSO</b> M-ORB adj. long F-NPTF page 51	 <b>729FSO</b> M-ORB adj. M-NPTF page 51	
--	--	--	--	---	---	---	--

# ADAPTER TUBE

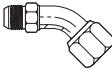
## JIC-JIC







 <b>63TA</b> M-JIC F-JIC swivel page 51	 <b>63UA</b> M-JIC F-JIC swivel page 51	 <b>63UC</b> M-JIC F-JIC swivel page 51					
--	--	--	--	--	--	--	--

## JIC-BSPP

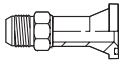
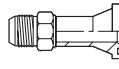
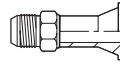
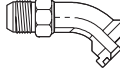
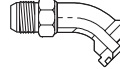
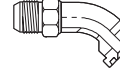
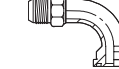
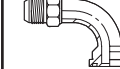

 <b>61TA</b> M-JIC F-BSPP swivel page 52	 <b>61UA</b> M-JIC F-BSPP swivel page 52						
---	---	--	--	--	--	--	--

# ADAPTER TUBE

## JIC-FLANGE

 <b>63SB</b> M-JIC FLANGE (code 61) page 52	 <b>63SE</b> M-JIC FLANGE (code 61 HD) page 52	 <b>63SF</b> M-JIC FLANGE (code 62) page 52	 <b>63TB</b> M-JIC FLANGE (code 61) page 53	 <b>63TE</b> M-JIC FLANGE (code 61 HD) page 53	 <b>63TF</b> M-JIC FLANGE (code 62) page 53	 <b>63UB</b> M-JIC FLANGE (code 61) page 53	 <b>63UE</b> M-JIC FLANGE (code 61 HD) page 53
 <b>63UF</b> M-JIC FLANGE (code 62) page 54	 <b>PA</b> Split flange Code 61 page 54	 <b>PH</b> Split flange Code 62 page 54	 <b>PA77</b> O'ring flange 90 duro page 67	 <b>PA77V</b> O'ring flange Viton page 67			

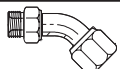

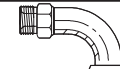
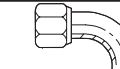

## BSPP-BSPP

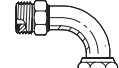
 <b>62TA</b> M-BSPP F-BSPP swivel page 54	 <b>62TD</b> F-BSPP swivel F-BSPP swivel page 54	 <b>62UA</b> M-BSPP F-BSPP swivel page 55	 <b>62UD</b> F-BSPP swivel F-BSPP swivel page 55				
--	---	--	---	--	--	--	--

## ORFS-ORFS

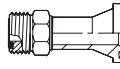
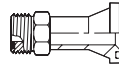
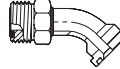
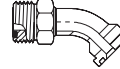
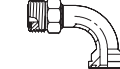
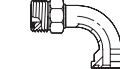

 <b>64TA</b> M-ORFS F-ORFS swivel page 55	 <b>64UA</b> M-ORFS F-ORFS swivel page 55	 <b>64UC</b> M-ORFS F-ORFS swivel long page 55					
---	---	--	--	--	--	--	--

## ORFS-FLANGE

 <b>64SB</b> M-ORFS FLANGE (code 61) page 55	 <b>64SF</b> M-ORFS FLANGE (code 62) page 56	 <b>64TB</b> M-ORFS FLANGE (code 61) page 56	 <b>64TF</b> M-ORFS FLANGE (code 62) page 56	 <b>64UB</b> M-ORFS FLANGE (code 61) page 56	 <b>64UF</b> M-ORFS FLANGE (code 62) page 56		
 <b>PA</b> Split flange Code 61 page 54	 <b>PH</b> Split flange Code 62 page 54	 <b>PA77</b> O'ring flange 90 duro page 67	 <b>PA77V</b> O'ring flange Viton page 67				



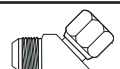



# SAE 45 (45° FLARE)

## SAE45-SAE45



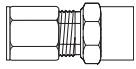
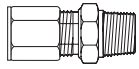
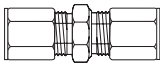

 <b>589FS</b> M-SAE45 F-SAE45 swivel page 56	 <b>579FS</b> M-SAE45 F-SAE45 swivel page 57						
---	---	--	--	--	--	--	--



## FLARELESS (COMPRESSION)

 <b>1960FS</b> Tube sleeve page 57	 <b>1961FS</b> Tube nut page 57	 <b>1946FS</b> Tube F-NPTF page 57	 <b>1948FS</b> Tube M-NPTF page 57	 <b>1942FS</b> Tube Tube page 57	 <b>1954FS</b> Tube M-NPTF page 58	 <b>1949FS</b> Tube M-NPTF page 58	 <b>1955FS</b> Tube Tube page 58
--	---	---	---	---	---	---	---

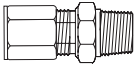
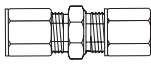





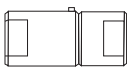
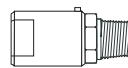
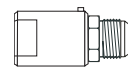
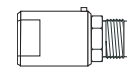
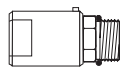
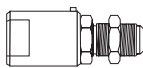
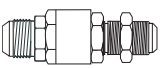
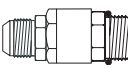
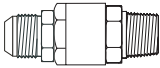
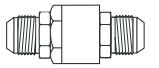
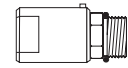



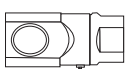
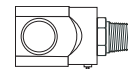
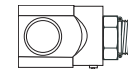
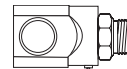
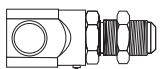
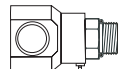

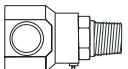
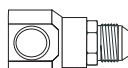
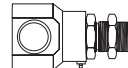
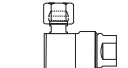
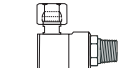
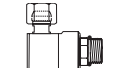
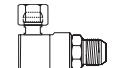
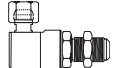
## FLARELESS METRIC (COMPRESSION)

 <b>1960FSM</b> Tube sleeve page 58	 <b>1961FSM</b> Tube nut page 58	 <b>1946FSM</b> Tube M-NPTF page 59	 <b>1942FSM</b> Tube Tube page 59	 <b>1949FSM</b> Tube M-NPTF page 59	 <b>1955FSM</b> Tube Tube page 59		
---	--	--	--	--	--	--	--

















## INLINE HYDRAULIC SWIVELS

 <b>59SP</b> F-NPTF F-NPTF page 60	 <b>59SS</b> F-NPTF M-NPTF page 60	 <b>59SL</b> F-NPTF M-JIC page 60	 <b>59SX</b> F-JIC M-JIC page 60	 <b>59ST</b> F-NPTF M-ORB page 60	 <b>59SXBH</b> F-JIC M-JIC bulkhead page 60	 <b>59SJBH</b> M-JIC M-JIC bulkhead page 61	 <b>59SB</b> M-JIC M-ORB page 61
 <b>59SA</b> M-JIC M-NPTF page 61	 <b>59SJ</b> M-JIC M-JIC page 61	 <b>59SZ</b> F-JIC M-ORB page 61					

## 90° HYDRAULIC SWIVELS

 <b>59UP</b> F-NPTF F-NPTF 90° page 61	 <b>59US</b> F-NPTF M-NPTF 90° page 62	 <b>59UT</b> F-NPTF M-ORB 90° page 62	 <b>59UL</b> F-NPTF M-JIC 90° page 62	 <b>59ULBH</b> F-NPTF M-JIC bulkhead 90° page 62	 <b>59UR</b> F-ORB M-ORB 90° page 62	 <b>59UO</b> F-ORB F-NPTF 90° page 62	 <b>59UQ</b> F-ORB M-NPTF 90° page 63
 <b>59UI</b> F-ORB M-JIC 90° page 63	 <b>59UIBH</b> F-ORB M-JIC bulkhead 90° page 63	 <b>59UE</b> F-NPSM F-NPTF 90° page 63	 <b>59UC</b> F-NPSM M-NPTF 90° page 63	 <b>59UD</b> F-NPSM M-ORB 90° page 63	 <b>59UK</b> F-NPSM M-JIC 90° page 64	 <b>59UKBH</b> F-NPSM M-JIC bulkhead 90° page 64	 <b>59UH</b> M-JIC F-NPTF 90° page 64
 <b>59UA</b> M-JIC M-NPTF 90° page 64	 <b>59UB</b> M-JIC M-ORB 90° page 64	 <b>59UJ</b> M-JIC M-JIC 90° page 64	 <b>59UJBH</b> M-JIC M-JIC bulkhead 90° page 65	 <b>59UF</b> M-NPTF F-NPTF 90° page 65	 <b>59UG</b> M-NPTF M-NPTF 90° page 65	 <b>59UV</b> M-NPTF M-ORB 90° page 65	 <b>59UN</b> M-NPTF M-JIC 90° page 65
 <b>59UNBH</b> M-NPTF M-JIC bulkhead 90° page 65							

## O'RINGS AND NUTS

 <b>711FSO</b> Nut bulkhead JIC-ORB page 66	 <b>711TTO</b> Nut bulkhead ORFS page 66	 <b>711BPO</b> Nut bulkhead BSPP page 66	 <b>710FSO</b> O'ring boss ORB page 66	 <b>710FSM</b> O'ring boss Metric page 66	 <b>710TTO</b> O'ring face ORFS page 66	 <b>710ORO</b> O'ring (retainer) BSPP page 67	 <b>710ORM</b> O'ring (retainer) Metric page 67
 <b>PA77</b> O'ring flange PA-PH (90 duro) page 67	 <b>PA77V</b> O'ring flange PA-PH (viton) page 67	 <b>710RRO</b> Retainer ring BSPP page 67	 <b>710RRM</b> Retainer ring Metric page 68	 <b>710BSB</b> Bonded seal BSPP page 68	 <b>710BSM</b> Bonded seal Metric page 68	 <b>712BSP</b> Copper washer BSPP page 68	 <b>712MET</b> Copper washer Metric page 68

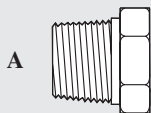
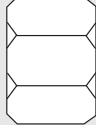
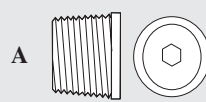
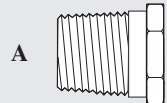
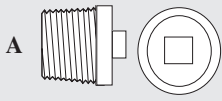
 <b>24ST</b> <b>Bouchon mâle NPTF tête hexagone</b> <b>Hexagone head NPTF male plug</b>		 <b>24SF</b> <b>Bouchon femelle NPTF</b> <b>NPTF female plug</b>		
Numéro Part number	A (")	Numéro Part number	A (")	
24ST02	1/8	24SF02	1/8	
24ST04	1/4	24SF04	1/4	
24ST06	3/8	24SF06	3/8	
24ST08	1/2	24SF08	1/2	
24ST12	3/4	24SF12	3/4	
24ST16	1			
24ST20	1-1/4			
24ST24	1-1/2			
24ST32	2			
 <b>24SR</b> <b>Bouchon mâle NPTF type Allen</b> <b>Allen type NPTF male plug</b>		 <b>24SB</b> <b>Mâle NPTF / Femelle NPTF</b> <b>Male NPTF / Female NPTF</b>		
Numéro Part number	A (")	Numéro Part number	A (")	B (")
24SR01	1/16	24SB04X02	1/4	1/8
24SR02	1/8	24SB06X02	3/8	1/8
24SR04	1/4	24SB06X04	3/8	1/4
24SR06	3/8	24SB08X02	1/2	1/8
24SR08	1/2	24SB08X04	1/2	1/4
24SR12	3/4	24SB08X06	1/2	3/8
24SR16	1	24SB12X02	3/4	1/8
24SR20	1-1/4	24SB12X04	3/4	1/4
24SR24	1-1/2	24SB12X06	3/4	3/8
24SR32	2	24SB12X08	3/4	1/2
		24SB16X04	1	1/4
		24SB16X06	1	3/8
		24SB16X08	1	1/2
		24SB16X12	1	3/4
		24SB20X08	1-1/4	1/2
		24SB20X12	1-1/4	3/4
		24SB20X16	1-1/4	1
		24SB24X12	1-1/2	3/4
		24SB24X16	1-1/2	1
		24SB24X20	1-1/2	1-1/4
		24SB32X12	2	3/4
		24SB32X16	2	1
		24SB32X20	2	1-1/4
		24SB32X24	2	1-1/2
 <b>25SP</b> <b>Bouchon mâle NPTF tête carrée</b> <b>Square head NPTF male plug</b>				
Numéro Part number	A (")			
25SP02	1/8			
25SP04	1/4			
25SP06	3/8			
25SP08	1/2			
25SP12	3/4			
25SP16	1			
25SP20	1-1/4			

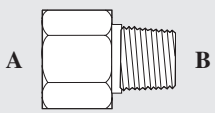
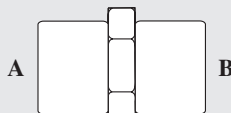
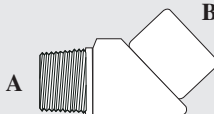
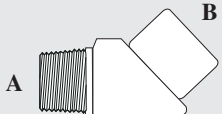
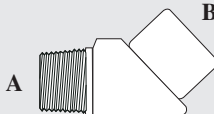
			Numéro Part number	A (")	B (")			
<b>24SG</b> <b>Femelle NPTF / Mâle NPTF</b> <b>Female NPTF / Male NPTF</b>			24SA16X12	1	3/4			
			24SA16X16	1	1			
			24SA20X12	1-1/4	3/4			
			24SA20X16	1-1/4	1			
			24SA20X20	1-1/4	1-1/4			
			24SA24X12	1-1/2	3/4			
			24SA24X16	1-1/2	1			
			24SA24X20	1-1/2	1-1/4			
			24SA24X24	1-1/2	1-1/2			
			24SA32X32	2	2			
						<b>24SJ</b> <b>Femelle NPTF / Femelle NPTF</b> <b>Female NPTF / Female NPTF</b>		
			Numéro Part number	A (")	B (")	Numéro Part number	A (")	B (")
			24SG02X02	1/8	1/8	24SJ02X02	1/8	1/8
			24SG04X02	1/4	1/8	24SJ04X02	1/4	1/8
24SG04X04	1/4	1/4	24SJ04X04	1/4	1/4			
24SG06X02	3/8	1/8	24SJ06X02	3/8	1/8			
24SG06X04	3/8	1/4	24SJ06X04	3/8	1/4			
24SG06X06	3/8	3/8	24SJ06X06	3/8	3/8			
24SG08X02	1/2	1/8	24SJ08X04	1/2	1/4			
24SG08X04	1/2	1/4	24SJ08X06	1/2	3/8			
24SG08X06	1/2	3/8	24SJ08X08	1/2	1/2			
24SG08X08	1/2	1/2	24SJ12X08	3/4	1/2			
24SG12X04	3/4	1/4	24SJ12X12	3/4	3/4			
24SG12X06	3/4	3/8	24SJ16X12	1	3/4			
24SG12X08	3/4	1/2	24SJ16X16	1	1			
24SG16X06	1	3/8	24SJ20X20	1-1/4	1-1/4			
24SG16X08	1	1/2	24SJ24X24	1-1/2	1-1/2			
24SG16X12	1	3/4	24SJ32X32	2	2			
24SG16X16	1	1						
24SG20X16	1-1/4	1	<b>25TG</b> <b>Mâle NPTF / Femelle NPTF</b> <b>Male NPTF / Female NPTF</b>					
24SG20X20	1-1/4	1-1/4	Numéro Part number	A (")	B (")			
24SG24X20	1-1/2	1-1/4	25TG02X02	1/8	1/8			
24SG24X24	1-1/2	1-1/2	25TG04X04	1/4	1/4			
24SG32X24	2	1-1/2	25TG06X06	3/8	3/8			
			25TG08X08	1/2	1/2			
<b>24SA</b> <b>Mâle NPTF / Mâle NPTF</b> <b>Male NPTF / Male NPTF</b>			25TG12X12	3/4	3/4			
Numéro Part number	A (")	B (")	25TG16X16	1	1			
24SA02X02	1/8	1/8	25TG20X20	1-1/4	1-1/4			
24SA04X02	1/4	1/8	25TG24X24	1-1/2	1-1/2			
24SA04X04	1/4	1/4	25TG32X32	2	2			
24SA06X02	3/8	1/8						
24SA06X04	3/8	1/4	<b>25TG</b> <b>Mâle NPTF / Femelle NPTF</b> <b>Male NPTF / Female NPTF</b>					
24SA06X06	3/8	3/8	Numéro Part number	A (")	B (")			
24SA08X04	1/2	1/4	25TG02X02	1/8	1/8			
24SA08X06	1/2	3/8	25TG04X04	1/4	1/4			
24SA08X08	1/2	1/2	25TG06X06	3/8	3/8			
24SA12X06	3/4	3/8	25TG08X08	1/2	1/2			
24SA12X08	3/4	1/2	25TG12X12	3/4	3/4			
24SA12X12	3/4	3/4	25TG16X16	1	1			
24SA16X08	1	1/2	25TG20X20	1-1/4	1-1/4			

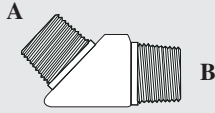
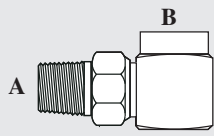
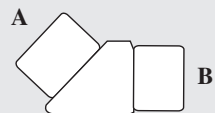
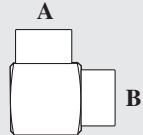
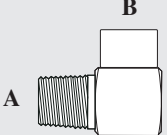
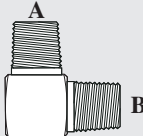
 <b>25TA</b> <b>Mâle NPTF / Mâle NPTF</b> <b>Male NPTF / Male NPTF</b>			Numéro Part number	A (")	B (")			
			25UG20X20	1-1/4	1-1/4			
			25UG24X24	1-1/2	1-1/2			
			25UG32X32	2	2			
 <b>25UGSW</b> <b>Mâle NPTF tournant / Femelle NPTF</b> <b>Male NPTF swivel / Female NPTF</b>			Numéro Part number	A (")	B (")			
			25UGSW04X04	1/4	1/4			
			25UGSW06X06	3/8	3/8			
			25UGSW08X08	1/2	1/2			
			25UGSW12X12	3/4	3/4			
			25UGSW16X16	1	1			
			 <b>25TJ</b> <b>Femelle NPTF / Femelle NPTF</b> <b>Female NPTF / Female NPTF</b>			Numéro Part number	A (")	B (")
						25TJ04X04	1/4	1/4
25TJ06X06	3/8	3/8						
25TJ08X08	1/2	1/2						
25TJ12X12	3/4	3/4						
25TJ16X16	1	1						
 <b>25UJ</b> <b>Femelle NPTF / Femelle NPTF</b> <b>Female NPTF / Female NPTF</b>			Numéro Part number	A (")	B (")			
			25UJ02X02	1/8	1/8			
			25UJ04X02	1/4	1/8			
			25UJ04X04	1/4	1/4			
			25UJ06X04	3/8	1/4			
			25UJ06X06	3/8	3/8			
			25UJ08X06	1/2	3/8			
			25UJ08X08	1/2	1/2			
			25UJ12X08	3/4	1/2			
			25UJ12X12	3/4	3/4			
			25UJ16X12	1	3/4			
			25UJ16X16	1	1			
 <b>25UG</b> <b>Mâle NPTF / Femelle NPTF</b> <b>Male NPTF / Female NPTF</b>			Numéro Part number	A (")	B (")			
			25UG02X02	1/8	1/8			
			25UG02X04	1/8	1/4			
			25UG04X02	1/4	1/8			
			25UG04X04	1/4	1/4			
			25UG04X06	1/4	3/8			
			25UG06X04	3/8	1/4			
			25UG06X06	3/8	3/8			
			25UG06X08	3/8	1/2			
			25UG08X06	1/2	3/8			
			25UG08X08	1/2	1/2			
			25UG08X12	1/2	3/4			
			25UG12X08	3/4	1/2			
			25UG12X12	3/4	3/4			
			25UG12X16	3/4	1			
			25UG16X16	1	1			
			 <b>25UA</b> <b>Mâle NPTF / Mâle NPTF</b> <b>Male NPTF / Male NPTF</b>			Numéro Part number	A (")	B (")
						25UA02X02	1/8	1/8
25UA04X02	1/4	1/8						

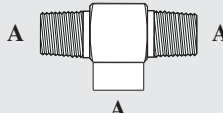
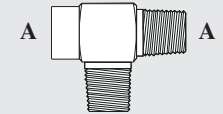
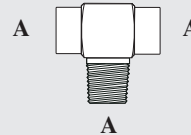
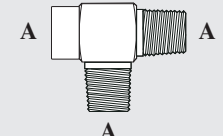
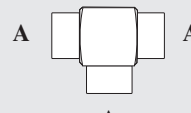
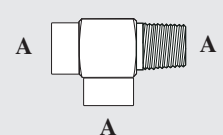
Numéro Part number	A (")	B (")	Numéro Part number	A (")
25UA04X04	1/4	1/4	25VJ06	3/8
25UA06X04	3/8	1/4	25VJ08	1/2
25UA06X06	3/8	3/8	25VJ12	3/4
25UA08X06	1/2	3/8	25VJ16	1
25UA08X08	1/2	1/2	25VJ20	1-1/4
25UA12X08	3/4	1/2	25VJ24	1-1/2
25UA12X12	3/4	3/4	25VJ32	2
25UA16X12	1	3/4		
25UA16X16	1	1		
25UA20X20	1-1/4	1-1/4	<b>25VG</b> Mâle NPTF / Femelle NPTF / Mâle NPTF Male NPTF / Female NPTF / Male NPTF	
25UA24X24	1-1/2	1-1/2		
 <b>25UASW</b> Mâle NPTF / Mâle NPTF tournant Male NPTF / Male NPTF swivel			Numéro Part number	A (")
			25VG02	1/8
25UASW04X04	1/4	1/4	25VG04	1/4
25UASW06X06	3/8	3/8	25VG06	3/8
25UASW08X08	1/2	1/2	25VG08	1/2
25UASW12X12	3/4	3/4	25VG12	3/4
 <b>25VC</b> Femelle NPTF / Mâle NPTF / Femelle NPTF Female NPTF / Male NPTF / Female NPTF			25VG16	1
			 <b>25VT</b> Femelle NPTF / Mâle NPTF / Mâle NPTF Female NPTF / Male NPTF / Male NPTF	
25VC02	1/8	25VT02		
25VC04	1/4	25VT04	1/4	
25VC06	3/8	25VT06	3/8	
25VC08	1/2	25VT08	1/2	
25VC12	3/4	25VT12	3/4	
25VC16	1	25VT16	1	
25VC20	1-1/4	25VT20	1-1/4	
25VC24	1-1/2	25VT24	1-1/2	
 <b>25VJ</b> Femelle NPTF / Femelle NPTF / Femelle NPTF Female NPTF / Female NPTF / Female NPTF			 <b>25VK</b> Femelle NPTF / Femelle NPTF / Mâle NPTF Female NPTF / Female NPTF / Male NPTF	
25VJ02	1/8	25VK02	1/8	
25VJ04	1/4	25VK04	1/4	
		25VK06	3/8	
		25VK08	1/2	

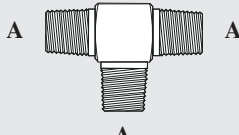
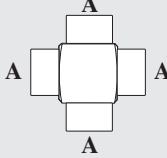
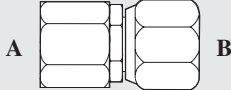
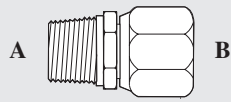
Numéro Part number	A (")		Numéro Part number	A (")	B (")						
25VK12	3/4		60SA04X06	1/4	3/8						
25VK16	1		60SA04X08	1/4	1/2						
25VK20	1-1/4		60SA06X04	3/8	1/4						
25VK24	1-1/2		60SA06X06	3/8	3/8						
 <b>25VA</b> Mâle NPTF / Mâle NPTF / Mâle NPTF Male NPTF / Male NPTF / Male NPTF			60SA06X08	3/8	1/2						
			60SA08X04	1/2	1/4						
			60SA08X06	1/2	3/8						
			60SA08X08	1/2	1/2						
			60SA08X12	1/2	3/4						
			60SA12X08	3/4	1/2						
			60SA12X12	3/4	3/4						
			60SA12X16	3/4	1						
			60SA16X12	1	3/4						
			60SA16X16	1	1						
			60SA16X20	1	1-1/4						
			60SA20X16	1-1/4	1						
			60SA20X20	1-1/4	1-1/4						
			60SA24X24	1-1/2	1-1/2						
60SA32X32	2	2									
 <b>25WJ</b> Croix femelle NPTF Cross female NPTF			 <b>60SG</b> Femelle NPTF / Femelle NPSM tournant Female NPTF / Female NPSM swivel								
						Numéro Part number	A (")		Numéro Part number	A (")	B (")
						25WJ02	1/8		60SG02X02	1/8	1/8
						25WJ04	1/4		60SG04X04	1/4	1/4
						25WJ06	3/8		60SG04X06	1/4	3/8
						25WJ08	1/2		60SG04X08	1/4	1/2
						25WJ12	3/4		60SG06X04	3/8	1/4
						25WJ16	1		60SG06X06	3/8	3/8
						25WJ20	1-1/4		60SG06X08	3/8	1/2
						25WJ24	1-1/2		60SG08X04	1/2	1/4
						25WJ32	2		60SG08X06	1/2	3/8
						<b>NPSM (pipe swivel)</b>					
						 <b>60SA</b> <b>61SA (Restriction / Restricted orifice)</b> Mâle NPTF / Femelle NPSM tournant Male NPTF / Female NPSM swivel			60SG08X08	1/2	1/2
									60SG12X12	3/4	3/4
60SG12X16	3/4	1									
60SG16X12	1	3/4									
60SG16X16	1	1									
60SG20X20	1-1/4	1-1/4									
60SG24X24	1-1/2	1-1/2									
60SG32X32	2	2									
Numéro Part number	A (")	B (")									
60SA02X02	1/8	1/8									
60SA02X04	1/8	1/4									
60SA04X02	1/4	1/8									
60SA04X04	1/4	1/4									

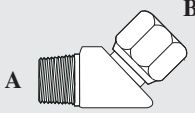
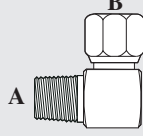
					
<b>60TA</b> Mâle NPTF / Femelle NPSM tournant Male NPTF / Female NPSM swivel			<b>60UA</b> Mâle NPTF / Femelle NPSM tournant Male NPTF / Female NPSM swivel		
Numéro Part number	A (")	B (")	Numéro Part number	A (")	B (")
60TA02X02	1/8	1/8	60UA02X02	1/8	1/8
60TA02X04	1/8	1/4	60UA02X04	1/8	1/4
60TA04X04	1/4	1/4	60UA04X02	1/4	1/8
60TA04X06	1/4	3/8	60UA04X04	1/4	1/4
60TA06X06	3/8	3/8	60UA04X06	1/4	3/8
60TA06X08	3/8	1/2	60UA04X08	1/4	1/2
60TA08X06	1/2	3/8	60UA06X04	3/8	1/4
60TA08X08	1/2	1/2	60UA06X06	3/8	3/8
60TA08X12	1/2	3/4	60UA06X08	3/8	1/2
60TA12X08	3/4	1/2	60UA08X04	1/2	1/4
60TA12X12	3/4	3/4	60UA08X06	1/2	3/8
60TA12X16	3/4	1	60UA08X08	1/2	1/2
60TA16X12	1	3/4	60UA08X12	1/2	3/4
60TA16X16	1	1	60UA12X06	3/4	3/8
60TA16X20	1	1-1/4	60UA12X08	3/4	1/2
60TA20X16	1-1/4	1	60UA12X12	3/4	3/4
60TA20X20	1-1/4	1-1/4	60UA12X16	3/4	1
60TA24X24	1-1/2	1-1/2	60UA16X08	1	1/2
60TA32X32	2	2	60UA16X12	1	3/4
			60UA16X16	1	1
			60UA16X20	1	1-1/4
			60UA20X16	1-1/4	1
			60UA20X20	1-1/4	1-1/4
			60UA24X24	1-1/2	1-1/2
			60UA32X32	2	2

					
<b>60TG</b> Femelle NPTF / Femelle NPSM tournant Female NPTF / Female NPSM swivel			<b>60UC</b> Mâle NPTF long / Femelle NPSM tournant Male NPTF long / Female NPSM swivel		
Numéro Part number	A (")	B (")	Numéro Part number	A (")	B (")
60TG02X02	1/8	1/8	60UC02X02	1/8	1/8
60TG02X04	1/8	1/4	60UC04X04	1/4	1/4
60TG04X04	1/4	1/4	60UC06X06	3/8	3/8
60TG06X04	3/8	1/4	60UC08X08	1/2	1/2
60TG06X06	3/8	3/8	60UC12X12	3/4	3/4
60TG08X06	1/2	3/8	60UC16X16	1	1
60TG08X08	1/2	1/2			
60TG12X08	3/4	1/2			
60TG12X12	3/4	3/4			
60TG16X12	1	3/4			
60TG16X16	1	1			
60TG20X20	1-1/4	1-1/4			
60TG24X24	1-1/2	1-1/2			
60TG32X32	2	2			

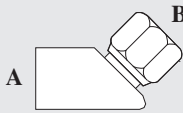
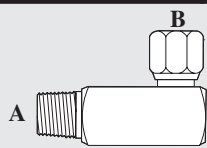

 <p><b>60UG</b>  <b>Femelle NPTF / Femelle NPSM tournant</b>  <b>Female NPTF / Female NPSM swivel</b></p>			Numéro Part number	A (")	B (")			
			60VC12X12	3/4	3/4			
			60VC16X16	1	1			
			60VC20X20	1-1/4	1-1/4			
 <p><b>60VJ</b>  <b>Femelle NPSM tourn. / Fem. NPSM tourn. / Fem. NPSM tourn.</b>  <b>Female NPSM swiv. / Female NPSM swiv. / Female NPSM swiv.</b></p>			Numéro Part number	A (")				
			60VJ02	1/8				
			60VJ04	1/4				
			60VJ06	3/8				
			60VJ08	1/2				
			60VJ12	3/4				
			60VJ16	1				
			60VJ20	1-1/4				
			 <p><b>60VH</b>  <b>Femelle NPSM tourn. / Femelle NPTF / Femelle NPSM tourn.</b>  <b>Female NPSM swivel / Female NPTF / Female NPSM swivel</b></p>			Numéro Part number	A (")	B (")
						60VH02X02	1/8	1/8
60VH04X04	1/4	1/4						
60VH06X06	3/8	3/8						
60VH08X08	1/2	1/2						
60VH12X08	3/4	1/2						
60VH12X12	3/4	3/4						
60VH16X16	1	1						
60VH20X20	1-1/4	1-1/4						
 <p><b>60SB</b>  <b>Mâle o'ring boss / Femelle NPSM tournant</b>  <b>Male o'ring boss / Female NPSM swivel</b></p>						Numéro Part number	A (")	B (")
			60SB04X02	1/4	1/8	710FSO04		
			60SB04X04	1/4	1/4	710FSO04		
			60SB04X06	1/4	3/8	710FSO04		
			60SB05X04	5/16	1/4	710FSO05		
			60SB06X04	3/8	1/4	710FSO06		
			60SB06X06	3/8	3/8	710FSO06		
			60SB06X08	3/8	1/2	710FSO06		
			60SB08X04	1/2	1/4	710FSO08		
			60SB08X06	1/2	3/8	710FSO08		
			60SB08X08	1/2	1/2	710FSO08		
			60SB08X12	1/2	3/4	710FSO08		
			60SB10X06	5/8	3/8	710FSO10		
			60SB10X08	5/8	1/2	710FSO10		
			60SB10X12	5/8	3/4	710FSO10		
			60SB12X08	3/4	1/2	710FSO12		
			60SB12X12	3/4	3/4	710FSO12		
			60SB14X12	7/8	3/4	710FSO14		
60SB16X12	1	3/4	710FSO16					
60SB16X16	1	1	710FSO16					
60SB20X16	1-1/4	1	710FSO20					
60SB20X20	1-1/4	1-1/4	710FSO20					
60SB24X24	1-1/2	1-1/2	710FSO24					
60SB32X32	2	2	710FSO32					
 <p><b>60VC</b>  <b>Femelle NPSM tourn. / Mâle NPTF / Femelle NPSM tourn.</b>  <b>Female NPSM swivel / Male NPTF / Female NPSM swivel</b></p>			Numéro Part number	A (")	B (")			
			60VC02X02	1/8	1/8			
			60VC04X04	1/4	1/4			
			60VC06X06	3/8	3/8			
			60VC06X08	3/8	1/2			
			60VC08X06	1/2	3/8			
			60VC08X08	1/2	1/2			
			60VC12X08	3/4	1/2			

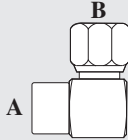
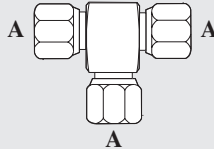
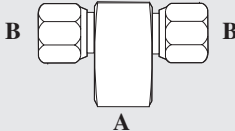
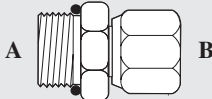
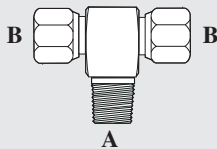
 <b>60TB</b> <b>Mâle o'ring boss / Femelle NPSM tournant</b> <b>Male o'ring boss / Female NPSM swivel</b>				Numéro Part number	A (")	B (")	O'ring
				60UB20X20	1-1/4	1-1/4	710FSO20
60UB24X24	1-1/2	1-1/2	710FSO24				
60UB32X32	2	2	710FSO32				

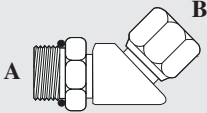

<b>JIC (37° flare)</b>			
 <b>830FS</b> <b>Bouchon femelle JIC</b> <b>Female JIC plug</b>			
Numéro Part number	A (")		
830FS02	1/8		
830FS03	3/16		
830FS04	1/4		
830FS05	5/16		
830FS06	3/8		
830FS08	1/2		
830FS10	5/8		
830FS12	3/4		
830FS14	7/8		
830FS16	1		
830FS20	1-1/4		
830FS24	1-1/2		
830FS32	2		

 <b>60UB</b> <b>Mâle o'ring boss / Femelle NPSM tournant</b> <b>Male o'ring boss / Female NPSM swivel</b>			
60TB04X04	1/4	1/4	710FSO04
60TB04X06	1/4	3/8	710FSO04
60TB06X04	3/8	1/4	710FSO06
60TB06X06	3/8	3/8	710FSO06
60TB06X08	3/8	1/2	710FSO06
60TB08X06	1/2	3/8	710FSO08
60TB08X08	1/2	1/2	710FSO08
60TB08X12	1/2	3/4	710FSO08
60TB10X06	5/8	3/8	710FSO10
60TB10X08	5/8	1/2	710FSO10
60TB10X12	5/8	3/4	710FSO10
60TB12X08	3/4	1/2	710FSO12
60TB12X12	3/4	3/4	710FSO12
60TB12X16	3/4	1	710FSO12
60TB16X16	1	1	710FSO16
60TB20X20	1-1/4	1-1/4	710FSO20
60TB24X24	1-1/2	1-1/2	710FSO24

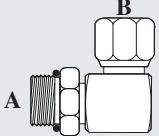

 <b>839FS</b> <b>Bouchon mâle JIC</b> <b>Male JIC plug</b>			
Numéro Part number	A (")		
839FS02	1/8		
839FS03	3/16		
839FS04	1/4		
839FS05	5/16		
839FS06	3/8		
839FS08	1/2		
839FS10	5/8		
839FS12	3/4		
839FS14	7/8		
839FS16	1		
839FS20	1-1/4		
839FS24	1-1/2		
839FS32	2		

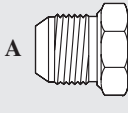
				
<b>840FS</b> <b>Bague JIC</b> <b>Sleeve JIC</b>		<b>883FS</b> <b>Femelle JIC fixe / Mâle JIC</b> <b>Female JIC solid / Male JIC</b>		
Numéro Part number	A (")	Numéro Part number	A (")	B (")
840FS02	1/8	883FS04X06	1/4	3/8
840FS03	3/16	883FS05X04	5/16	1/4
840FS04	1/4	883FS06X04	3/8	1/4
840FS05	5/16	883FS06X05	3/8	5/16
840FS06	3/8	883FS06X08	3/8	1/2
840FS08	1/2	883FS08X04	1/2	1/4
840FS10	5/8	883FS08X05	1/2	5/16
840FS12	3/4	883FS08X06	1/2	3/8
840FS14	7/8	883FS08X10	1/2	5/8
840FS16	1	883FS08X12	1/2	3/4
840FS20	1-1/4	883FS10X04	5/8	1/4
840FS24	1-1/2	883FS10X06	5/8	3/8
840FS32	2	883FS10X08	5/8	1/2
		883FS10X12	5/8	3/4
		883FS12X04	3/4	1/4
		883FS12X06	3/4	3/8
		883FS12X08	3/4	1/2
		883FS12X10	3/4	5/8
		883FS12X16	3/4	1
		883FS14X06	7/8	3/8
		883FS14X08	7/8	1/2
		883FS14X10	7/8	5/8
		883FS14X12	7/8	3/4
		883FS16X04	1	1/4
		883FS16X06	1	3/8
		883FS16X08	1	1/2
		883FS16X12	1	3/4
		883FS16X14	1	7/8
		883FS16X20	1	1-1/4
		883FS20X08	1-1/4	1/2
		883FS20X12	1-1/4	3/4
		883FS20X16	1-1/4	1
		883FS20X24	1-1/4	1-1/2
		883FS24X12	1-1/2	3/4
		883FS24X16	1-1/2	1
		883FS24X20	1-1/2	1-1/4
		883FS32X24	2	1-1/2

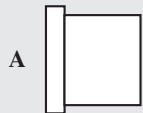
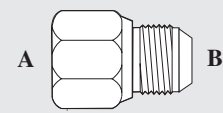

	
<b>841FS</b> <b>Écrou JIC</b> <b>Nut JIC</b>	
Numéro Part number	A (")
841FS02	1/8
841FS03	3/16
841FS04	1/4
841FS05	5/16
841FS06	3/8
841FS08	1/2
841FS10	5/8
841FS12	3/4
841FS14	7/8
841FS16	1
841FS20	1-1/4
841FS24	1-1/2
841FS32	2

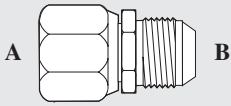
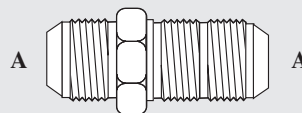
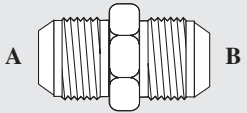
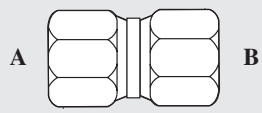
			Numéro Part number	A (")	B (")
<b>883FSSW</b> Femelle JIC tournant / Mâle JIC Female JIC swivel / Male JIC			842FS12X12	3/4	3/4
			842FS14X12	7/8	3/4
			842FS14X14	7/8	7/8
			842FS16X08	1	1/2
			842FS16X10	1	5/8
			842FS16X12	1	3/4
			842FS16X14	1	7/8
			842FS16X16	1	1
			842FS20X12	1-1/4	3/4
			842FS20X16	1-1/4	1
			842FS20X20	1-1/4	1-1/4
			842FS24X16	1-1/2	1
			842FS24X20	1-1/2	1-1/4
			842FS24X24	1-1/2	1-1/2
			842FS32X16	2	1
			842FS32X20	2	1-1/4
			842FS32X24	2	1-1/2
			842FS32X32	2	2
					
<b>832FS</b> Mâle JIC / Mâle JIC cloison Male JIC / Male JIC bulkhead					
			Numéro Part number	A (")	Écrou Nut
<b>842FS</b> Mâle JIC / Mâle JIC Male JIC / Male JIC			832FS04	1/4	711FSO04
			832FS05	5/16	711FSO05
			832FS06	3/8	711FSO06
			832FS08	1/2	711FSO08
			832FS10	5/8	711FSO10
			832FS12	3/4	711FSO12
			832FS16	1	711FSO16
			832FS20	1-1/4	711FSO20
			832FS24	1-1/2	711FSO24
					
<b>880FS</b> Femelle JIC tournant / Femelle JIC tournant Female JIC swivel / Female JIC swivel					
Numéro Part number			A (")	B (")	
			880FS04X04	1/4	1/4
			880FS05X05	5/16	5/16
			880FS06X06	3/8	3/8
			880FS08X08	1/2	1/2
			880FS10X10	5/8	5/8
			880FS12X12	3/4	3/4
			880FS16X16	1	1

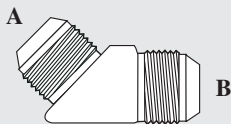
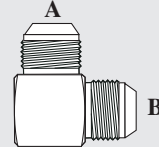
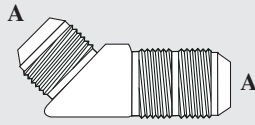
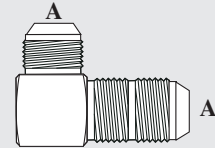
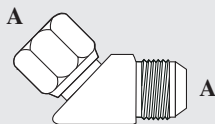
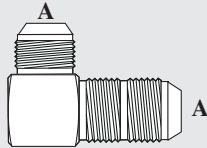
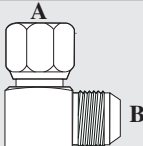
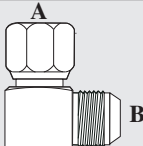
								
<b>856FS</b> Mâle JIC / Mâle JIC Male JIC / Male JIC			<b>855FS</b> Mâle JIC / Mâle JIC Male JIC / Male JIC					
Numéro Part number	A (")	B (")	Numéro Part number	A (")	B (")			
856FS04X04	1/4	1/4	855FS04X04	1/4	1/4			
856FS06X06	3/8	3/8	855FS05X05	5/16	5/16			
856FS08X08	1/2	1/2	855FS06X06	3/8	3/8			
856FS10X10	5/8	5/8	855FS06X04	3/8	1/4			
856FS12X12	3/4	3/4	855FS08X06	1/2	3/8			
								
<b>854BHFS</b> Mâle JIC / Mâle JIC cloison Male JIC / Male JIC bulkhead								
Numéro Part number	A (")	Écrou Nut						
854BHFS04	1/4	711FSO04						
854BHFS05	5/16	711FSO05						
854BHFS06	3/8	711FSO06						
854BHFS08	1/2	711FSO08						
854BHFS10	5/8	711FSO10						
854BHFS12	3/4	711FSO12						
854BHFS16	1	711FSO16						
854BHFS20	1-1/4	711FSO20						
								
<b>889FS</b> Femelle JIC tournant / Mâle JIC Female JIC swivel / Male JIC								
Numéro Part number	A (")	Écrou Nut						
855BHFS04	1/4	711FSO04						
855BHFS05	5/16	711FSO05						
855BHFS06	3/8	711FSO06						
855BHFS08	1/2	711FSO08						
855BHFS10	5/8	711FSO10						
855BHFS12	3/4	711FSO12						
855BHFS16	1	711FSO16						
855BHFS20	1-1/4	711FSO20						
								
<b>879FS</b> Femelle JIC tournant / Mâle JIC Female JIC swivel / Male JIC								
Numéro Part number	A (")	B (")						
879FS03X03	3/16	3/16						
879FS04X04	1/4	1/4						
879FS04X06	1/4	3/8						

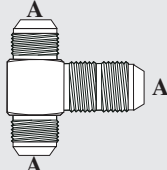
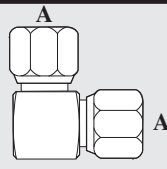
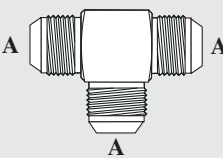
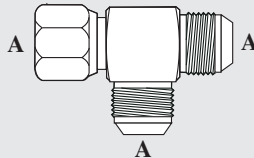
Numéro Part number	A (")	B (")			
879FS05X05	5/16	5/16	<b>870FS</b> Mâle JIC / Mâle JIC cloison / Mâle JIC Male JIC / Male JIC bulkhead / Male JIC		
879FS06X06	3/8	3/8			
879FS08X06	1/2	3/8			
879FS08X08	1/2	1/2			
879FS08X10	1/2	5/8			
879FS10X08	5/8	1/2			
879FS10X10	5/8	5/8			
879FS12X10	3/4	5/8			
879FS12X12	3/4	3/4			
879FS14X14	7/8	7/8			
879FS16X16	1	1			
879FS20X20	1-1/4	1-1/4			
879FS24X24	1-1/2	1-1/2			
879FS32X32	2	2			
					
<b>875FS</b> Femelle JIC tournant / Femelle JIC tournant Female JIC swivel / Female JIC swivel			<b>861FS</b> Mâle JIC / Mâle JIC / Mâle JIC cloison Male JIC / Male JIC / Male JIC bulkhead		
Numéro Part number	A (")	Numéro Part number		A (")	Écrou Nut
875FS04	1/4	861FS06	3/8	711FSO06	
875FS05	5/16	861FS08	1/2	711FSO08	
875FS06	3/8	861FS10	5/8	711FSO10	
875FS08	1/2	861FS12	3/4	711FSO12	
875FS10	5/8	861FS16	1	711FSO16	
875FS12	3/4				
875FS16	1				
					
<b>844FS</b> Mâle JIC / Mâle JIC / Mâle JIC Male JIC / Male JIC / Male JIC			<b>871FS</b> Femelle JIC tournant / Mâle JIC / Mâle JIC Female JIC swivel / Male JIC / Male JIC		
Numéro Part number	A (")	Numéro Part number	A (")		
844FS04	1/4	871FS04	1/4		
844FS05	5/16	871FS05	5/16		
844FS06	3/8	871FS06	3/8		
844FS08	1/2	871FS08	1/2		
844FS10	5/8	871FS10	5/8		
844FS12	3/4	871FS12	3/4		
844FS14	7/8	871FS16	1		
844FS16	1	871FS20	1-1/4		
844FS20	1-1/4	871FS24	1-1/2		
844FS24	1-1/2				
844FS32	2				

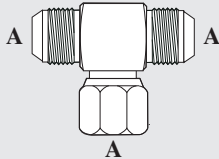
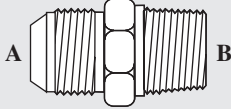
 <b>872FS</b> Mâle JIC / Femelle JIC tournant / Mâle JIC Male JIC / Female JIC swivel / Male JIC		 <b>848FS</b> Mâle JIC / Mâle NPTF Male JIC / Male NPTF		
Numéro Part number	A (")	Numéro Part number	A (")	B (")
872FS04	1/4	848FS02X02	1/8	1/8
872FS05	5/16	848FS03X02	3/16	1/8
872FS06	3/8	848FS04X02	1/4	1/8
872FS08	1/2	848FS04X04	1/4	1/4
872FS10	5/8	848FS04X06	1/4	3/8
872FS12	3/4	848FS04X08	1/4	1/2
872FS16	1	848FS05X02	5/16	1/8
872FS20	1-1/4	848FS05X04	5/16	1/4
872FS24	1-1/2	848FS05X06	5/16	3/8
		848FS05X08	5/16	1/2
		848FS06X02	3/8	1/8
		848FS06X04	3/8	1/4
		848FS06X06	3/8	3/8
		848FS06X08	3/8	1/2
		848FS06X12	3/8	3/4
		848FS08X02	1/2	1/8
		848FS08X04	1/2	1/4
		848FS08X06	1/2	3/8
		848FS08X08	1/2	1/2
		848FS08X12	1/2	3/4
		848FS08X16	1/2	1
		848FS10X04	5/8	1/4
		848FS10X06	5/8	3/8
		848FS10X08	5/8	1/2
		848FS10X12	5/8	3/4
		848FS10X16	5/8	1
		848FS12X06	3/4	3/8
		848FS12X08	3/4	1/2
		848FS12X12	3/4	3/4
		848FS12X16	3/4	1
		848FS12X20	3/4	1-1/4
		848FS12X24	3/4	1-1/2
		848FS14X12	7/8	3/4
		848FS16X08	1	1/2
		848FS16X12	1	3/4
		848FS16X16	1	1
		848FS16X20	1	1-1/4
		848FS16X24	1	1-1/2
		848FS20X12	1-1/4	3/4
		848FS20X16	1-1/4	1
		848FS20X20	1-1/4	1-1/4
		848FS20X24	1-1/4	1-1/2
		848FS24X16	1-1/2	1
		848FS24X20	1-1/2	1-1/4
		848FS24X24	1-1/2	1-1/2
		848FS24X32	1-1/2	2

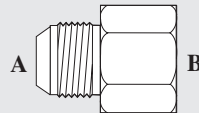
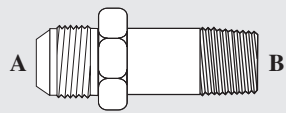
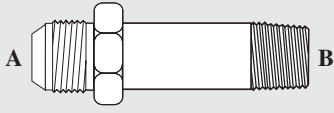
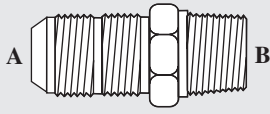

Numéro Part number	A (")	B (")				
848FS32X20	2	1-1/4				
848FS32X24	2	1-1/2				
848FS32X32	2	2				
			<b>846FS</b> <b>Mâle JIC / Femelle NPTF</b> <b>Male JIC / Female NPTF</b>			
Numéro Part number	A (")	B (")				
848LFS			846FS02X02	1/8	1/8	
<b>Mâle JIC / Mâle NPTF long</b>			846FS03X02	3/16	1/8	
<b>Male JIC / Male NPTF long</b>			846FS04X02	1/4	1/8	
Numéro Part number	A (")	B (")	846FS04X04	1/4	1/4	
848LFS04X02	1/4	1/8	846FS04X06	1/4	3/8	
848LFS04X04	1/4	1/4	846FS04X08	1/4	1/2	
848LFS06X06	3/8	3/8	846FS05X02	5/16	1/8	
848LFS08X08	1/2	1/2	846FS05X04	5/16	1/4	
848LFS12X12	3/4	3/4	846FS05X06	5/16	3/8	
			846FS06X02	3/8	1/8	
<b>848LLFS</b>			846FS06X04	3/8	1/4	
			<b>Mâle JIC / Mâle NPTF X-long</b>			846FS06X06
<b>Male JIC / Male NPTF X-long</b>			846FS06X08	3/8	1/2	
Numéro Part number	A (")	B (")	846FS08X04	1/2	1/4	
848LLFS04X02	1/4	1/8	846FS08X06	1/2	3/8	
848LLFS04X04	1/4	1/4	846FS08X08	1/2	1/2	
848LLFS06X04	3/8	1/4	846FS08X12	1/2	3/4	
848LLFS06X06	3/8	3/8	846FS10X06	5/8	3/8	
848LLFS08X08	1/2	1/2	846FS10X08	5/8	1/2	
848LLFS12X12	3/4	3/4	846FS10X12	5/8	3/4	
			846FS12X08	3/4	1/2	
<b>848BHFS</b>			846FS12X12	3/4	3/4	
			<b>Mâle JIC cloison / Mâle NPTF</b>			846FS12X16
<b>Male JIC bulkhead / Male NPTF</b>			846FS14X12	7/8	3/4	
Numéro Part number	A (")	B (")	Écrou Nut	846FS16X12	1	3/4
848BHFS04X02	1/4	1/8	711FSO04	846FS16X16	1	1
848BHFS04X04	1/4	1/4	711FSO04	846FS20X16	1-1/4	1
848BHFS06X04	3/8	1/4	711FSO06	846FS20X20	1-1/4	1-1/4
848BHFS06X06	3/8	3/8	711FSO06	846FS24X24	1-1/2	1-1/2
848BHFS08X06	1/2	3/8	711FSO08	846FS32X32	2	2
848BHFS08X08	1/2	3/8	711FSO08			
848BHFS08X08	1/2	1/2	711FSO08			
848BHFS10X08	5/8	1/2	711FSO10			
848BHFS12X12	3/4	3/4	711FSO12			
848BHFS16X16	1	1	711FSO16			
848BHFS20X20	1-1/4	1-1/4	711FSO20			
848BHFS24X24	1-1/2	1-1/2	711FSO24			

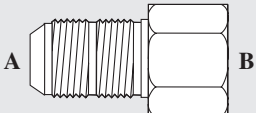
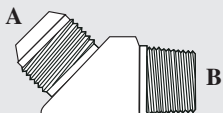
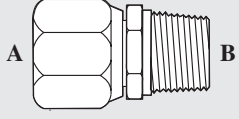
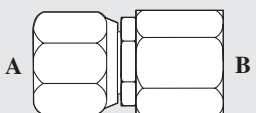

				Numéro Part number	A (")	B (")
<b>847FS</b>				882FS08X06	1/2	3/8
<b>Mâle JIC Cloison / Femelle NPTF</b>				882FS08X08	1/2	1/2
<b>Male JIC bulkhead / Female NPTF</b>				882FS10X08	5/8	1/2
Numéro Part number	A (")	B (")	Écrou Nut	882FS12X12	3/4	3/4
847FS04X02	1/4	1/8	711FSO04	882FS16X16	1	1
847FS04X04	1/4	1/4	711FSO04	882FS20X20	1-1/4	1-1/4
847FS06X04	3/8	1/4	711FSO06			
847FS08X06	1/2	3/8	711FSO08	<b>854FS</b>		
847FS10X08	5/8	1/2	711FSO10	<b>Mâle JIC / Mâle NPTF</b>		
847FS12X12	3/4	3/4	711FSO12	<b>Male JIC / Male NPTF</b>		
847FS16X16	1	1	711FSO16	Numéro Part number	A (")	B (")
				854FS02X02	1/8	1/8
<b>881FS</b>				854FS03X02	3/16	1/8
<b>Femelle JIC tournant / Mâle NPTF</b>				854FS04X02	1/4	1/8
<b>Female JIC swivel / Male NPTF</b>				854FS04X04	1/4	1/4
Numéro Part number	A (")	B (")		854FS04X06	1/4	3/8
881FS04X02	1/4	1/8		854FS05X02	5/16	1/8
881FS04X04	1/4	1/4		854FS05X04	5/16	1/4
881FS05X04	5/16	1/4		854FS06X02	3/8	1/8
881FS06X04	3/8	1/4		854FS06X04	3/8	1/4
881FS06X06	3/8	3/8		854FS06X06	3/8	3/8
881FS08X06	1/2	3/8		854FS06X08	3/8	1/2
881FS08X08	1/2	1/2		854FS08X04	1/2	1/4
881FS10X06	5/8	3/8		854FS08X06	1/2	3/8
881FS10X08	5/8	1/2		854FS08X08	1/2	1/2
881FS12X08	3/4	1/2		854FS08X12	1/2	3/4
881FS12X12	3/4	3/4		854FS10X06	5/8	3/8
881FS16X12	1	3/4		854FS10X08	5/8	1/2
881FS16X16	1	1		854FS10X12	5/8	3/4
881FS20X20	1-1/4	1-1/4		854FS12X08	3/4	1/2
				854FS12X12	3/4	3/4
<b>882FS</b>				854FS12X16	3/4	1
<b>Femelle JIC tournant / Femelle NPTF</b>				854FS14X12	7/8	3/4
<b>Female JIC swivel / Female NPTF</b>				854FS16X08	1	1/2
Numéro Part number	A (")	B (")		854FS16X12	1	3/4
882FS04X02	1/4	1/8		854FS16X16	1	1
882FS04X04	1/4	1/4		854FS16X20	1	1-1/4
882FS06X04	3/8	1/4		854FS20X16	1-1/4	1
882FS06X06	3/8	3/8		854FS20X20	1-1/4	1-1/4
882FS06X08	3/8	1/2		854FS24X24	1-1/2	1-1/2
				854FS32X32	2	2

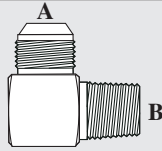
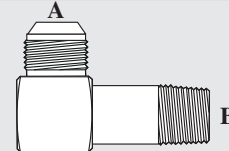
**849FS**
**Mâle JIC / Mâle NPTF**  
**Male JIC / Male NPTF**

**849LFS**
**Mâle JIC / Mâle NPTF long**  
**Male JIC / Male NPTF long**

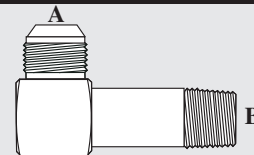
Numéro Part number	A (")	B (")	Numéro Part number	A (")	B (")
849FS02X02	1/8	1/8	849LFS04X02	1/4	1/8
849FS03X02	3/16	1/8	849LFS04X04	1/4	1/4
849FS04X02	1/4	1/8	849LFS05X02	5/16	1/8
849FS04X04	1/4	1/4	849LFS05X04	5/16	1/4
849FS04X06	1/4	3/8	849LFS06X04	3/8	1/4
849FS04X08	1/4	1/2	849LFS06X06	3/8	3/8
849SF05X02	5/16	1/8	849LFS08X06	1/2	3/8
849FS05X04	5/16	1/4	849LFS08X08	1/2	1/2
849FS05X06	5/16	3/8	849LFS10X08	5/8	1/2
849FS06X02	3/8	1/8	849LFS12X12	3/4	3/4
849FS06X04	3/8	1/4	849LFS16X12	1	3/4
849FS06X06	3/8	3/8	849LFS16X16	1	1
849FS06X08	3/8	1/2	849LFS20X20	1-1/4	1-1/4
849FS06X12	3/8	3/4			
849FS08X04	1/2	1/4			
849FS08X06	1/2	3/8			
849FS08X08	1/2	1/2			
849FS08X12	1/2	3/4			
849FS08X16	1/2	1			
849FS10X06	5/8	3/8			
849FS10X08	5/8	1/2			
849FS10X12	5/8	3/4			
849FS12X06	3/4	3/8			
849FS12X08	3/4	1/2			
849FS12X12	3/4	3/4			
849FS12X16	3/4	1			
849FS12X20	3/4	1-1/4			
849FS14X12	7/8	3/4			
849FS16X08	1	1/2			
849FS16X12	1	3/4			
849FS16X16	1	1			
849FS16X20	1	1-1/4			
849FS16X24	1	1-1/2			
849FS20X12	1-1/4	3/4			
849FS20X16	1-1/4	1			
849FS20X20	1-1/4	1-1/4			
849FS20X24	1-1/4	1-1/2			
849FS24X16	1-1/2	1			
849FS24X20	1-1/2	1-1/4			
849FS24X24	1-1/2	1-1/2			
849FS32X24	2	1-1/2			
849FS32X32	2	2			

**849LLFS**
**Mâle JIC / Mâle NPTF X-long**  
**Male JIC / Male NPTF X-long**

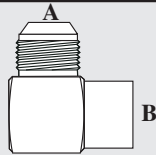
Numéro Part number	A (")	B (")
849LLFS04X02	1/4	1/8
849LLFS04X04	1/4	1/4
849LLFS05X02	5/16	1/8
849LLFS05X04	5/16	1/4
849LLFS06X04	3/8	1/4
849LLFS06X06	3/8	3/8
849LLFS08X06	1/2	3/8
849LLFS08X08	1/2	1/2
849LLFS10X08	5/8	1/2
849LLFS12X08	3/4	1/2
849LLFS12X12	3/4	3/4
849LLFS16X12	1	3/4
849LLFS16X16	1	1
849LLFS20X20	1-1/4	1-1/4

**850FS**
**Mâle JIC / Femelle NPTF**  
**Male JIC / Female NPTF**

Numéro Part number	A (")	B (")
850FS04X02	1/4	1/8
850FS04X04	1/4	1/4
850FS04X06	1/4	3/8
850FS04X08	1/4	1/2
850FS05X02	5/16	1/8
850FS05X04	5/16	1/4
850FS06X02	3/8	1/8
850FS06X04	3/8	1/4
850FS06X06	3/8	3/8
850FS06X08	3/8	1/2
850FS08X04	1/2	1/4
850FS08X06	1/2	3/8
850FS08X08	1/2	1/2
850FS10X08	5/8	1/2
850FS10X12	5/8	3/4
850FS12X08	3/4	1/2
850FS12X12	3/4	3/4
850FS12X16	3/4	1
850FS14X12	7/8	3/4
850FS16X16	1	1
850FS20X20	1-1/4	1-1/4
850FS24X24	1-1/2	1-1/2
850FS32X32	2	2

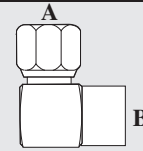
**877FS**
**Femelle JIC tournant / Femelle NPTF**  
**Female JIC swivel / Female NPTF**

Numéro Part number	A (")	B (")
877FS04X04	1/4	1/4
877FS06X04	3/8	1/4
877FS06X06	3/8	3/8
877FS08X06	1/2	3/8
877FS10X08	5/8	1/2
877FS12X12	3/4	3/4

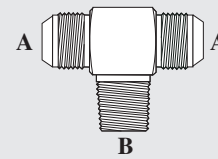
**845FS**
**Mâle JIC / Mâle NPTF / Mâle JIC**  
**Male JIC / Male NPTF / Male JIC**

Numéro Part number	A (")	B (")
845FS04X02	1/4	1/8
845FS04X04	1/4	1/4
845FS04X06	1/4	3/8
845FS05X02	5/16	1/8
845FS05X04	5/16	1/4
845FS06X04	3/8	1/4
845FS06X06	3/8	3/8
845FS06X08	3/8	1/2
845FS08X06	1/2	3/8
845FS08X08	1/2	1/2
845FS10X06	5/8	3/8
845FS10X08	5/8	1/2
845FS10X12	5/8	3/4
845FS12X12	3/4	3/4
845FS16X12	1	3/4
845FS16X16	1	1
845FS20X20	1-1/4	1-1/4
845FS24X24	1-1/2	1-1/2
845FS32X32	2	2

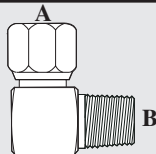
**878FS**
**Femelle JIC tournant / Mâle NPTF**  
**Female JIC swivel / Male NPTF**

Numéro Part number	A (")	B (")
878FS04X02	1/4	1/8
878FS04X04	1/4	1/4
878FS06X04	3/8	1/4
878FS06X06	3/8	3/8
878FS06X08	3/8	1/2
878FS08X06	1/2	3/8
878FS08X08	1/2	1/2
878FS10X08	5/8	1/2
878FS12X12	3/4	3/4
878FS16X16	1	1
878FS20X20	1-1/4	1-1/4

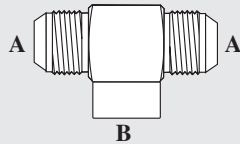
**858FS**
**Mâle JIC / Femelle NPTF / Mâle JIC**  
**Male JIC / Female NPTF / Male JIC**

Numéro Part number	A (")	B (")
858FS02X02	1/8	1/8
858FS04X02	1/4	1/8
858FS04X04	1/4	1/4
858FS05X02	5/16	1/8
858FS06X04	3/8	1/4
858FS06X06	3/8	3/8
858FS08X06	1/2	3/8
858FS08X08	1/2	1/2
858FS10X08	5/8	1/2
858FS12X08	3/4	1/2
858FS12X12	3/4	3/4
858FS14X12	7/8	3/4
858FS16X16	1	1
858FS20X20	1-1/4	1-1/4
858FS24X24	1-1/2	1-1/2
858FS32X32	2	2

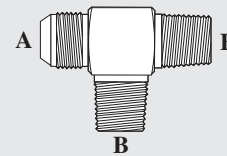
**853FS**
**Mâle JIC / Mâle NPTF / Mâle NPTF**  
**Male JIC / Male NPTF / Male NPTF**

Numéro Part number	A (")	B (")
853FS04X02	1/4	1/8
853FS06X04	3/8	1/4
853FS08X06	1/2	3/8
853FS10X08	5/8	1/2
853FS12X12	3/4	3/4

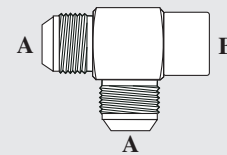
**857FS**
**Mâle JIC / Mâle JIC / Femelle NPTF**  
**Male JIC / Male JIC / Female NPTF**

Numéro Part number	A (")	B (")
857FS04X02	1/4	1/8
857FS04X04	1/4	1/4
857FS06X04	3/8	1/4
857FS06X06	3/8	3/8
857FS08X06	1/2	3/8
857FS08X08	1/2	1/2
857FS10X08	5/8	1/2
857FS12X12	3/4	3/4
857FS16X16	1	1

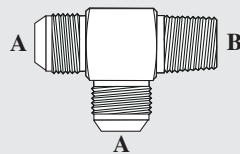

**851FS**
**Mâle JIC / Mâle JIC / Mâle NPTF**  
**Male JIC / Male JIC / Male NPTF**

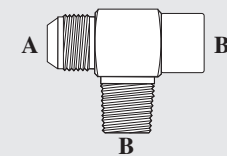
Numéro Part number	A (")	B (")
851FS04X02	1/4	1/8
851FS04X04	1/4	1/4
851FS05X02	5/16	1/8
851FS05X04	5/16	1/4
851FS06X04	3/8	1/4
851FS06X06	3/8	3/8
851FS08X06	1/2	3/8
851FS08X08	1/2	1/2
851FS08X12	1/2	3/4
851FS10X08	5/8	1/2
851FS10X12	5/8	3/4
851FS12X08	3/4	1/2
851FS12X12	3/4	3/4
851FS14X12	7/8	3/4
851FS16X16	1	1
851FS20X20	1-1/4	1-1/4
851FS24X24	1-1/2	1-1/2

**860FS**
**Mâle JIC / Mâle NPTF / Femelle NPTF**  
**Male JIC / Male NPTF / Female NPTF**

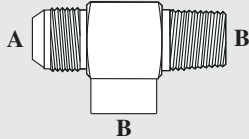
Numéro Part number	A (")	B (")
860FS04X02	1/4	1/8
860FS06X04	3/8	1/4
860FS08X06	1/2	3/8
860FS10X08	5/8	1/2
860FS12X12	3/4	3/4
860FS16X16	1	1
860FS20X20	1-1/4	1-1/4

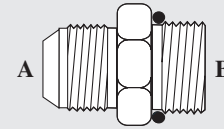

**859FS**

 Mâle JIC / Femelle NPTF / Mâle NPTF  
 Male JIC / Female NPTF / Male NPTF

**848FSO**

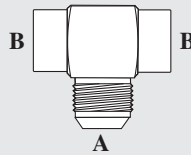
 Mâle JIC / Mâle o'ring boss  
 Male JIC / Male o'ring boss

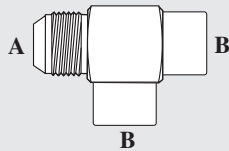
Numéro Part number	A (")	B (")	Numéro Part number	A (")	B (")	O'ring
859FS04X02	1/4	1/8	848FSO02X02	1/8	1/8	710FSO02
859FS06X04	3/8	1/4	848FSO03X03	3/16	3/16	710FSO03
859FS06X06	3/8	3/8	848FSO04X03	1/4	3/16	710FSO03
859FS08X06	1/2	3/8	848FSO04X04	1/4	1/4	710FSO04
859FS10X08	5/8	1/2	848FSO04X05	1/4	5/16	710FSO05
859FS12X12	3/4	3/4	848FSO04X06	1/4	3/8	710FSO06
859FS16X16	1	1	848FSO04X08	1/4	1/2	710FSO08
859FS20X20	1-1/4	1-1/4	848FSO05X04	5/16	1/4	710FSO04
859FS24X24	1-1/2	1-1/2	848FSO05X05	5/16	5/16	710FSO05
			848FSO05X06	5/16	3/8	710FSO06
			848FSO05X08	5/16	1/2	710FSO08
			848FSO05X10	5/16	5/8	710FSO10
			848FSO06X04	3/8	1/4	710FSO04
			848FSO06X05	3/8	5/16	710FSO05
			848FSO06X06	3/8	3/8	710FSO06
			848FSO06X08	3/8	1/2	710FSO08
			848FSO06X10	3/8	5/8	710FSO10
			848FSO06X12	3/8	3/4	710FSO12
			848FSO08X04	1/2	1/4	710FSO04
			848FSO08X05	1/2	5/16	710FSO05
			848FSO08X06	1/2	3/8	710FSO06
			848FSO08X08	1/2	1/2	710FSO08
			848FSO08X10	1/2	5/8	710FSO10
			848FSO08X12	1/2	3/4	710FSO12
			848FSO08X16	1/2	1	710FSO16
			848FSO10X04	5/8	1/4	710FSO04
			848FSO10X06	5/8	3/8	710FSO06
			848FSO10X08	5/8	1/2	710FSO08
			848FSO10X10	5/8	5/8	710FSO10
			848FSO10X12	5/8	3/4	710FSO12
			848FSO10X16	5/8	1	710FSO16
			848FSO12X08	3/4	1/2	710FSO08
			848FSO12X10	3/4	5/8	710FSO10
			848FSO12X12	3/4	3/4	710FSO12
			848FSO12X14	3/4	7/8	710FSO14
			848FSO12X16	3/4	1	710FSO16
			848FSO12X20	3/4	1-1/4	710FSO20
			848FSO14X12	7/8	3/4	710FSO12
			848FSO14X14	7/8	7/8	710FSO14
			848FSO14X16	7/8	1	710FSO16
			848FSO16X06	1	3/8	710FSO06
			848FSO16X08	1	1/2	710FSO08
			848FSO16X10	1	5/8	710FSO10
			848FSO16X12	1	3/4	710FSO12
			848FSO16X14	1	7/8	710FSO14
			848FSO16X16	1	1	710FSO16

**862FS**

 Femelle NPTF / Mâle JIC / Femelle NPTF  
 Female NPTF / Male JIC / Female NPTF

**863FS**

 Mâle JIC / Femelle NPTF / Femelle NPTF  
 Male JIC / Female NPTF / Female NPTF

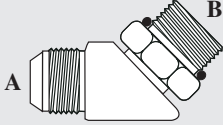
Numéro Part number	A (")	B (")	O'ring
848FSO16X20	1	1-1/4	710FSO20
848FSO16X24	1	1-1/2	710FSO24
848FSO20X12	1-1/4	3/4	710FSO12
848FSO20X16	1-1/4	1	710FSO16
848FSO20X20	1-1/4	1-1/4	710FSO20
848FSO20X24	1-1/4	1-1/2	710FSO24
848FSO24X16	1-1/2	1	710FSO16
848FSO24X20	1-1/2	1-1/4	710FSO20
848FSO24X24	1-1/2	1-1/2	710FSO24
848FSO24X32	1-1/2	2	710FSO32
848FSO32X32	2	2	710FSO32

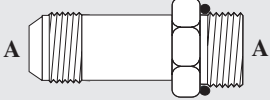

<b>854FSO</b> <b>Mâle JIC / Mâle o'ring boss</b> <b>Male JIC / Male o'ring boss</b>			
Numéro Part number	A (")	B (")	O'ring
854FSO02X02	1/8	1/8	710FSO02
854FSO04X04	1/4	1/4	710FSO04
854FSO04X06	1/4	3/8	710FSO06
854FSO05X05	5/16	5/16	710FSO05
854FSO05X06	5/16	3/8	710FSO06
854FSO06X04	3/8	1/4	710FSO04
854FSO06X05	3/8	5/16	710FSO05
854FSO06X06	3/8	3/8	710FSO06
854FSO06X08	3/8	1/2	710FSO08
854FSO08X06	1/2	3/8	710FSO06
854FSO08X08	1/2	1/2	710FSO08
854FSO08X10	1/2	5/8	710FSO10
854FSO08X12	1/2	3/4	710FSO12
854FSO10X08	5/8	1/2	710FSO08
854FSO10X10	5/8	5/8	710FSO10
854FSO10X12	5/8	3/4	710FSO12
854FSO12X08	3/4	1/2	710FSO08
854FSO12X10	3/4	5/8	710FSO10
854FSO12X12	3/4	3/4	710FSO12
854FSO12X16	3/4	1	710FSO16
854FSO14X14	7/8	7/8	710FSO14
854FSO16X12	1	3/4	710FSO12
854FSO16X16	1	1	710FSO16
854FSO16X20	1	1-1/4	710FSO20
854FSO20X16	1-1/4	1	710FSO16
854FSO20X20	1-1/4	1-1/4	710FSO20
854FSO24X24	1-1/2	1-1/2	710FSO24



<b>848LFSO</b> <b>Mâle JIC / Mâle o'ring boss long</b> <b>Male JIC / Male o'ring boss long</b>		
Numéro Part number	A (")	O'ring
848LFSO04	1/4	710FSO04
848LFSO06	3/8	710FSO06
848LFSO08	1/2	710FSO08
848LFSO10	5/8	710FSO10
848LFSO12	3/4	710FSO12
848LFSO16	1	710FSO16

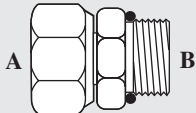

<b>881FSO</b> <b>Femelle JIC tournant / Mâle o'ring boss</b> <b>Female JIC swivel / Male o'ring boss</b>			
Numéro Part number	A (")	B (")	O'ring
881FSO04X04	1/4	1/4	710FSO04
881FSO06X06	3/8	3/8	710FSO06
881FSO06X08	3/8	1/2	710FSO08
881FSO08X06	1/2	3/8	710FSO06
881FSO08X08	1/2	1/2	710FSO08
881FSO10X10	5/8	5/8	710FSO10
881FSO12X12	3/4	3/4	710FSO12
881FSO16X16	1	1	710FSO16
881FSO20X20	1-1/4	1-1/4	710FSO20

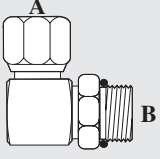

<b>878FSO</b> <b>Femelle JIC tournant / Mâle o'ring boss</b> <b>Female JIC swivel / Male o'ring boss</b>			
Numéro Part number	A (")	B (")	O'ring
878FSO06X06	3/8	3/8	710FSO06
878FSO08X08	1/2	1/2	710FSO08
878FSO10X10	5/8	5/8	710FSO10
878FSO12X12	3/4	3/4	710FSO12
878FSO16X16	1	1	710FSO16

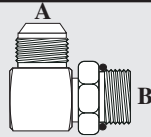
**849FSO**
**Mâle JIC / Mâle o'ring boss**  
**Male JIC / Male o'ring boss**

Numéro Part number	A (")	B (")	O'ring
849FSO04X02	1/4	1/8	710FSO02
849FSO04X04	1/4	1/4	710FSO04
849FSO04X05	1/4	5/16	710FSO05
849FSO04X06	1/4	3/8	710FSO06
849FSO04X08	1/4	1/2	710FSO08
849FSO05X04	5/16	1/4	710FSO04
849FSO05X05	5/16	5/16	710FSO05
849FSO05X06	5/16	3/8	710FSO06
849FSO05X08	5/16	1/2	710FSO08
849FSO06X04	3/8	1/4	710FSO04
849FSO06X05	3/8	5/16	710FSO05
849FSO06X06	3/8	3/8	710FSO06
849FSO06X08	3/8	1/2	710FSO08
849FSO06X10	3/8	5/8	710FSO10
849FSO06X12	3/8	3/4	710FSO12
849FSO08X04	1/2	1/4	710FSO04
849FSO08X06	1/2	3/8	710FSO06
849FSO08X08	1/2	1/2	710FSO08
849FSO08X10	1/2	5/8	710FSO10
849FSO08X12	1/2	3/4	710FSO12
849FSO08X16	1/2	1	710FSO16
849FSO10X06	5/8	3/8	710FSO06
849FSO10X08	5/8	1/2	710FSO08
849FSO10X10	5/8	5/8	710FSO10
849FSO10X12	5/8	3/4	710FSO12
849FSO12X06	3/4	3/8	710FSO06
849FSO12X08	3/4	1/2	710FSO08
849FSO12X10	3/4	5/8	710FSO10
849FSO12X12	3/4	3/4	710FSO12
849FSO12X16	3/4	1	710FSO16
849FSO12X20	3/4	1-1/4	710FSO20
849FSO14X14	7/8	7/8	710FSO14
849FSO14X16	7/8	1	710FSO16
849FSO16X08	1	1/2	710FSO08
849FSO16X10	1	5/8	710FSO10
849FSO16X12	1	3/4	710FSO12
849FSO16X14	1	7/8	710FSO14
849FSO16X16	1	1	710FSO16
849FSO16X20	1	1-1/4	710FSO20
849FSO20X12	1-1/4	3/4	710FSO12
849FSO20X16	1-1/4	1	710FSO16
849FSO20X20	1-1/4	1-1/4	710FSO20
849FSO20X24	1-1/4	1-1/2	710FSO24
849FSO24X20	1-1/2	1-1/4	710FSO20
849FSO24X24	1-1/2	1-1/2	710FSO24
849FSO32X32	2	2	710FSO32

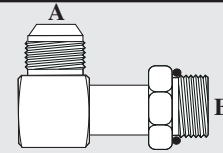
**849LFSO**
**Mâle JIC / Mâle o'ring boss long**  
**Male JIC / Male o'ring boss long**

Numéro Part number	A (")	B (")	O'ring
849LFSO04X04	1/4	1/4	710FSO04
849LFSO06X06	3/8	3/8	710FSO06
849LFSO08X08	1/2	1/2	710FSO08
849LFSO10X10	5/8	5/8	710FSO10
849LFSO12X12	3/4	3/4	710FSO12
849LFSO16X16	1	1	710FSO16
849LFSO20X20	1-1/4	1-1/4	710FSO20

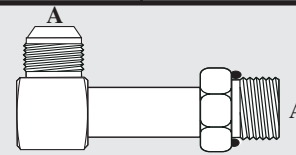

**849LLFSO**
**Mâle JIC / Mâle o'ring boss X-long**  
**Male JIC / Male o'ring boss X-long**

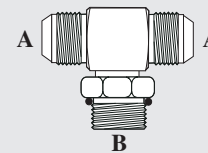
Numéro Part number	A (")	O'ring
849LLFSO04	1/4	710FSO04
849LLFSO06	3/8	710FSO06
849LLFSO08	1/2	710FSO08
849LLFSO10	5/8	710FSO10
849LLFSO12	3/4	710FSO12
849LLFSO16	1	710FSO16
849LLFSO20	1-1/4	710FSO20

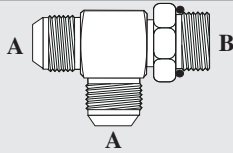

**845FSO**
**Mâle JIC / Mâle o'ring boss / Mâle JIC**  
**Male JIC / Male o'ring boss / Male JIC**

Numéro Part number	A (")	B (")	O'ring
845FSO04X04	1/4	1/4	710FSO04
845FSO05X05	5/16	5/16	710FSO05
845FSO06X06	3/8	3/8	710FSO06
845FSO08X08	1/2	1/2	710FSO08
845FSO10X08	5/8	1/2	710FSO08
845FSO10X10	5/8	5/8	710FSO10
845FSO12X08	3/4	1/2	710FSO08
845FSO12X12	3/4	3/4	710FSO12
845FSO14X14	7/8	7/8	710FSO14
845FSO16X16	1	1	710FSO16
845FSO20X20	1-1/4	1-1/4	710FSO20
845FSO24X24	1-1/2	1-1/2	710FSO24



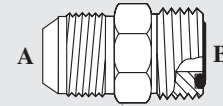

**851FSO**
**Mâle JIC / Mâle JIC / Mâle o'ring boss**  
**Male JIC / Male JIC / Male o'ring boss**

Numéro Part number	A (")	B (")	O'ring
851FSO04X04	1/4	1/4	710FSO04
851FSO05X05	5/16	5/16	710FSO05
851FSO06X04	3/8	1/4	710FSO04
851FSO06X06	3/8	3/8	710FSO06
851FSO08X08	1/2	1/2	710FSO08
851FSO10X10	5/8	5/8	710FSO10
851FSO12X12	3/4	3/4	710FSO12
851FSO14X14	7/8	7/8	710FSO14
851FSO16X16	1	1	710FSO16
851FSO20X20	1-1/4	1-1/4	710FSO20
851FSO24X24	1-1/2	1-1/2	710FSO24

**848TTJ**
**Mâle JIC / Mâle o'ring face**  
**Male JIC / Male o'ring face**

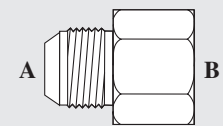
Numéro Part number	A (")	B (")	O'ring
848TTJ04X04	1/4	1/4	710TTO04
848TTJ06X06	3/8	3/8	710TTO06
848TTJ08X08	1/2	1/2	710TTO08
848TTJ10X10	5/8	5/8	710TTO10
848TTJ12X12	3/4	3/4	710TTO12
848TTJ16X16	1	1	710TTO16

**846TTJ**
**Mâle JIC / Femelle o'ring face fixe**  
**Male JIC / Female o'ring face solid**

Numéro Part number	A (")	B (")
846TTJ04X04	1/4	1/4
846TTJ06X04	3/8	1/4
846TTJ06X06	3/8	3/8
846TTJ08X06	1/2	3/8
846TTJ08X08	1/2	1/2
846TTJ10X08	5/8	1/2
846TTJ10X10	5/8	5/8
846TTJ10X12	5/8	3/4
846TTJ12X12	3/4	3/4
846TTJ12X16	3/4	1
846TTJ16X16	1	1
846TTJ20X20	1-1/4	1-1/4

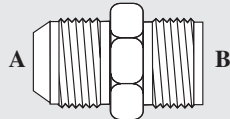
**848FSV**
**Mâle JIC / Mâle cône inversé**  
**Male JIC / Male inverted flare**

Numéro Part number	A (")	B (")
848FSV03X04	3/16	1/4
848FSV04X03	1/4	3/16
848FSV04X04	1/4	1/4
848FSV04X05	1/4	5/16
848FSV06X04	3/8	1/4
848FSV06X05	3/8	5/16
848FSV08X06	1/2	3/8

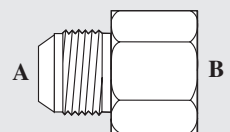

**846FSV**
**Mâle JIC / Femelle cône inversé**  
**Male JIC / Female inverted flare**

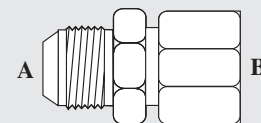
Numéro Part number	A (")	B (")
846FSV04X03	1/4	3/16
846FSV04X04	1/4	1/4
846FSV06X06	3/8	3/8

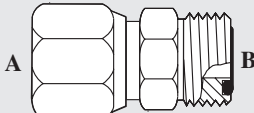
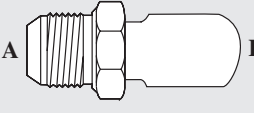
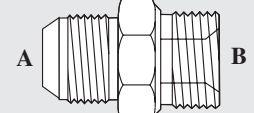
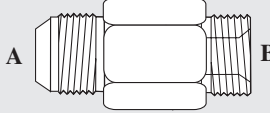

**846TTJSW**
**Mâle JIC / Femelle o'ring face tournant**  
**Male JIC / Female o'ring face swivel**

Numéro Part number	A (")	B (")
846TTJSW0404	1/4	1/4
846TTJSW0606	3/8	3/8
846TTJSW0808	1/2	1/2
846TTJSW1010	5/8	5/8
846TTJSW1212	3/4	3/4
846TTJSW1616	1	1

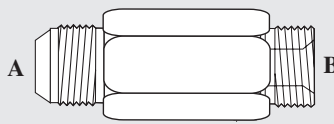
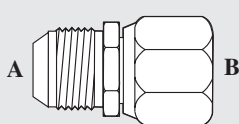
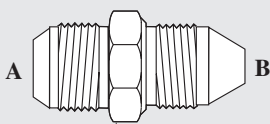
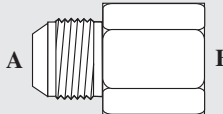
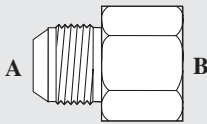
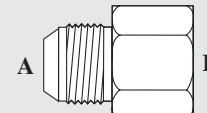

 <b>881TTJ</b> Femelle JIC tournant / Mâle o'ring face Female JIC swivel / Male o'ring face				Numéro Part number	A (")	B (")	Joint d'étanchéité Bonded seal	
				848FSB05X04	5/16	1/4	710BSB04	
				848FSB05X06	5/16	3/8	710BSB06	
				848FSB05X08	5/16	1/2	710BSB08	
				848FSB06X02	3/8	1/8	710BSB02	
				848FSB06X04	3/8	1/4	710BSB04	
				848FSB06X06	3/8	3/8	710BSB06	
				848FSB06X08	3/8	1/2	710BSB08	
				848FSB06X10	3/8	5/8	710BSB10	
				848FSB08X04	1/2	1/4	710BSB04	
				848FSB08X06	1/2	3/8	710BSB06	
				848FSB08X08	1/2	1/2	710BSB08	
				848FSB08X10	1/2	5/8	710BSB10	
				848FSB08X12	1/2	3/4	710BSB12	
				848FSB08X16	1/2	1	710BSB16	
				848FSB10X04	5/8	1/4	710BSB04	
				848FSB10X06	5/8	3/8	710BSB06	
				848FSB10X08	5/8	1/2	710BSB08	
				848FSB10X10	5/8	5/8	710BSB10	
				848FSB10X12	5/8	3/4	710BSB12	
				848FSB12X06	3/4	3/8	710BSB06	
				848FSB12X08	3/4	1/2	710BSB08	
				848FSB12X10	3/4	5/8	710BSB10	
				848FSB12X12	3/4	3/4	710BSB12	
				848FSB12X16	3/4	1	710BSB16	
				848FSB12X20	3/4	1-1/4	710BSB20	
				848FSB14X16	7/8	1	710BSB16	
				848FSB16X08	1	1/2	710BSB08	
				848FSB16X12	1	3/4	710BSB12	
				848FSB16X16	1	1	710BSB16	
				848FSB16X20	1	1-1/4	710BSB20	
				848FSB16X24	1	1-1/2	710BSB24	
				848FSB20X12	1-1/4	3/4	710BSB12	
				848FSB20X16	1-1/4	1	710BSB16	
				848FSB20X20	1-1/4	1-1/4	710BSB20	
				848FSB20X24	1-1/4	1-1/2	710BSB24	
				848FSB20X32	1-1/4	2	710BSB32	
				848FSB24X20	1-1/2	1-1/4	710BSB20	
				848FSB24X24	1-1/2	1-1/2	710BSB24	
				848FSB24X32	1-1/2	2	710BSB32	
				848FSB32X32	2	2	710BSB32	
 <b>848FSBJ</b> Mâle JIC / Banjo Male JIC / Banjo				Numéro Part number	A (")	B	Boulon Bolt	Rondelle Copper washer
				848FSBJ04X04	1/4	1/4BSPP	BJ04	712BSP04
				848FSBJ04X06	1/4	3/8BSPP	BJ06	712BSP06
				848FSBJ04X08	1/4	8 mm	BJM08	712MET08
				848FSBJ04X10	1/4	10 mm	BJM10	712MET10
				848FSBJ04X12	1/4	12 mm	BJM12	712MET12
				848FSBJ04X14	1/4	14 mm	BJM14	712MET14
				848FSBJ06X04	3/8	1/4BSPP	BJ04	712BSP04
				848FSBJ06X06	3/8	3/8BSPP	BJ06	712BSP06
				848FSBJ06X12	3/8	12 mm	BJM12	712MET12
				848FSBJ06X14	3/8	14 mm	BJM14	712MET14
				848FSBJ08X08	1/2	1/2BSPP	BJ08	712BSP08
				848FSBJ08X14	1/2	14 mm	BJM14	712MET14
				848FSBJ08X16	1/2	16 mm	BJM16	712MET16
				848FSBJ10X10	5/8	5/8BSPP	BJ10	712BSP10
				848FSBJ12X12	3/4	3/4BSPP	BJ12	712BSP12
 <b>848FSB</b> Mâle JIC / Mâle BSPP Male JIC / Male BSPP				Numéro Part number	A (")	B (")	Joint d'étanchéité Bonded seal	
				848FSB04X02	1/4	1/8	710BSB02	
				848FSB04X04	1/4	1/4	710BSB04	
				848FSB04X06	1/4	3/8	710BSB06	
				848FSB04X08	1/4	1/2	710BSB08	
				848FSB05X02	5/16	1/8	710BSB02	
 <b>848FSBL</b> Mâle JIC / Mâle BSPP long Male JIC / Male BSPP long				Numéro Part number	A (")	B (")	Joint d'étanchéité Bonded seal	
				848FSBL04X04	1/4	1/4	710BSB04	
				848FSBL06X04	3/8	1/4	710BSB04	
				848FSBL06X06	3/8	3/8	710BSB06	
				848FSBL08X06	1/2	3/8	710BSB06	
				848FSBL10X08	5/8	1/2	710BSB08	

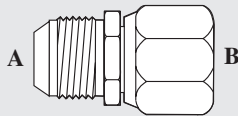
										
<b>848FSBLL</b> <b>Mâle JIC / Mâle BSPP X-long</b> <b>Male JIC / Male BSPP X-long</b>				<b>846FSBSW</b> <b>Mâle JIC / Femelle BSPP tournant</b> <b>Male JIC /Female BSPP swivel</b>						
Numéro Part number	A (")	B (")	Joint d'étanchéité Bonded seal	Numéro Part number	A (")	B (")				
848FSBLL0404	1/4	1/4	710BSB04	846FSBSW0404	1/4	1/4				
848FSBLL0604	3/8	1/4	710BSB04	846FSBSW0406	1/4	3/8				
848FSBLL0606	3/8	3/8	710BSB06	846FSBSW0606	3/8	3/8				
848FSBLL0608	3/8	1/2	710BSB08	846FSBSW0608	3/8	1/2				
848FSBLL0806	1/2	3/8	710BSB06	846FSBSW0806	1/2	3/8				
848FSBLL0808	1/2	1/2	710BSB08	846FSBSW0808	1/2	1/2				
848FSBLL1208	3/4	1/2	710BSB08	846FSBSW0812	1/2	3/4				
848FSBLL1210	3/4	5/8	710BSB10	846FSBSW1008	5/8	1/2				
848FSBLL1212	3/4	3/4	710BSB12	846FSBSW1212	3/4	3/4				
				846FSBSW1216			3/4	1		
				846FSBSW1616			1	1		
				846FSBSW2020			1-1/4	1-1/4		
				846FSBSW2424			1-1/2	1-1/2		
				846FSBSW3232			2	2		
								<b>846FSJ</b> <b>Mâle JIC / Femelle JIS</b> <b>Male JIC /Female JIS</b>		
				Numéro Part number	A (")	B (")	Numéro Part number	A (")	B (")	
				848FSJ04X02	1/4	1/8	846FSJ04X02	1/4	1/8	
				848FSJ04X04	1/4	1/4	846FSJ04X04	1/4	1/4	
				848FSJ06X06	3/8	3/8	846FSJ06X06	3/8	3/8	
848FSJ08X08	1/2	1/2	846FSJ08X08	1/2	1/2					
				846FSJ12X12			3/4	3/4		
								<b>846FSH</b> <b>Mâle JIC / Femelle BSPP plat fixe</b> <b>Male JIC /Female BSPP flat face solid</b>		
				Numéro Part number	A (")	B (")	Numéro Part number	A (")	B (")	
				846FSB04X04	1/4	1/4	846FSH06X06	3/8	3/8	
				846FSB06X04	3/8	1/4	846FSH06X08	3/8	1/2	
				846FSB06X06	3/8	3/8	846FSH08X08	1/2	1/2	
846FSB08X06	1/2	3/8	846FSH08X10	1/2	5/8					
846FSB08X08	1/2	1/2	846FSH08X12	1/2	3/4					
846FSB12X12	3/4	3/4	846FSH10X08	5/8	1/2					
846FSB16X16	1	1	846FSH10X12	5/8	3/4					
846FSB20X20	1-1/4	1-1/4	846FSH12X12	3/4	3/4					
846FSB24X24	1-1/2	1-1/2								

**846FHSWSW**
**Mâle JIC / Femelle BSPP plat tournant**  
**Male JIC / Female BSPP flat face swivel**

Numéro Part number	A (")	B (")
846FHSWSW0608	3/8	1/2
846FHSWSW0808	1/2	1/2
846FHSWSW0812	1/2	3/4
846FHSWSW1212	3/4	3/4

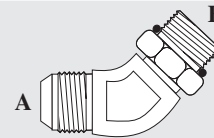
**854FSB**
**Mâle JIC / Mâle BSPP ajustable**  
**Male JIC / Male BSPP adjustable**

Numéro Part number	A (")	B (")	Joint d'étanchéité Bonded seal
854FSB04X04	1/4	1/4	710BSB04
854FSB06X04	3/8	1/4	710BSB04
854FSB06X06	3/8	3/8	710BSB06
854FSB06X08	3/8	1/2	710BSB08
854FSB08X06	1/2	3/8	710BSB06
854FSB08X08	1/2	1/2	710BSB08
854FSB12X12	3/4	3/4	710BSB12
854FSB16X16	1	1	710BSB16

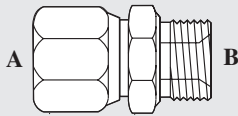
**881FSB**
**Femelle JIC tournant / Mâle BSPP**  
**Female JIC swivel / Male BSPP**

Numéro Part number	A (")	B (")	Joint d'étanchéité Bonded seal
881FSB04X02	1/4	1/8	710BSB02
881FSB04X04	1/4	1/4	710BSB04
881FSB04X06	1/4	3/8	710BSB06
881FSB06X04	3/8	1/4	710BSB04
881FSB06X06	3/8	3/8	710BSB06
881FSB06X08	3/8	1/2	710BSB08
881FSB08X06	1/2	3/8	710BSB06
881FSB08X08	1/2	1/2	710BSB08
881FSB10X08	5/8	1/2	710BSB08
881FSB10X10	5/8	5/8	710BSB10
881FSB12X12	3/4	3/4	710BSB12
881FSB16X16	1	1	710BSB16
881FSB20X20	1-1/4	1-1/4	710BSB20
881FSB24X24	1-1/2	1-1/2	710BSB24
881FSB32X32	2	2	710BSB32

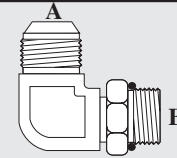
**849FSB**
**Mâle JIC / Mâle BSPP ajustable**  
**Male JIC / Male BSPP adjustable**

Numéro Part number	A (")	B (")	Joint d'étanchéité Bonded seal
849FSB04X02	1/4	1/8	710BSB02
849FSB04X04	1/4	1/4	710BSB04
849FSB06X04	3/8	1/4	710BSB04
849FSB06X06	3/8	3/8	710BSB06
849FSB06X08	3/8	1/2	710BSB08
849FSB08X06	1/2	3/8	710BSB06
849FSB08X08	1/2	1/2	710BSB08
849FSB08X12	1/2	3/4	710BSB12
849FSB10X06	5/8	3/8	710BSB06
849FSB10X08	5/8	1/2	710BSB08
849FSB10X12	5/8	3/4	710BSB12
849FSB12X08	3/4	1/2	710BSB08
849FSB12X12	3/4	3/4	710BSB12
849FSB12X16	3/4	1	710BSB16
849FSB16X12	1	3/4	710BSB12
849FSB16X16	1	1	710BSB16

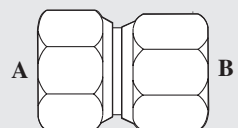
**882FSB**
**Femelle JIC tournant / Femelle BSPP tournant**  
**Female JIC swivel / Female BSPP swivel**

Numéro Part number	A (")	B (")
882FSB06X06	3/8	3/8
882FSB06X08	3/8	1/2
882FSB08X06	1/2	3/8
882FSB08X08	1/2	1/2
882FSB12X12	3/4	3/4

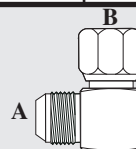
**850FSB**
**Mâle JIC / Femelle BSPP tournant**  
**Male JIC / Female BSPP swivel**

Numéro Part number	A (")	B (")
850FSB06X06	3/8	3/8
850FSB08X06	1/2	3/8
850FSB08X08	1/2	1/2
850FSB12X12	3/4	3/4

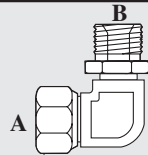
**878FSB**
**Femelle JIC tournant / Mâle BSPP**  
**Female JIC swivel / Male BSPP**

Numéro Part number	A (")	B (")	Joint d'étanchéité Bonded seal
878FSB04X04	1/4	1/4	710BSB04
878FSB06X04	3/8	1/4	710BSB04
878FSB06X06	3/8	3/8	710BSB06
878FSB06X08	3/8	1/2	710BSB08
878FSB08X06	1/2	3/8	710BSB06
878FSB08X08	1/2	1/2	710BSB08
878FSB10X08	5/8	1/2	710BSB08
878FSB10X10	5/8	5/8	710BSB10
878FSB12X12	3/4	3/4	710BSB12

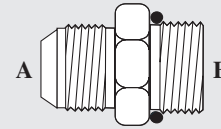
**848FSM**
**Mâle JIC / Mâle métrique (port seulement)**  
**Male JIC / Male metric (port only)**

Numéro Part number	A (")	B (mm)	Joint d'étanchéité Bonded seal
848FSM04X10	1/4	M10X1.0	710BSM10
848FSM04X12	1/4	M12X1.5	710BSM12
848FSM04X14	1/4	M14X1.5	710BSM14
848FSM05X12	5/16	M12X1.5	710BSM12
848FSM05X16	5/16	M16X1.5	710BSM16
848FSM06X12	3/8	M12X1.5	710BSM12
848FSM06X14	3/8	M14X1.5	710BSM14
848FSM06X16	3/8	M16X1.5	710BSM16
848FSM08X14	1/2	M14X1.5	710BSM14
848FSM08X16	1/2	M16X1.5	710BSM16
848FSM08X18	1/2	M18X1.5	710BSM18
848FSM08X22	1/2	M22X1.5	710BSM22
848FSM10X18	5/8	M18X1.5	710BSM18
848FSM10X20	5/8	M20X1.5	710BSM20
848FSM10X22	5/8	M22X1.5	710BSM22
848FSM12X22	3/4	M22X1.5	710BSM22
848FSM12X26	3/4	M26X1.5	710BSM26
848FSM12X27	3/4	M27X2.0	710BSM27
848FSM14X26	7/8	M26X1.5	710BSM26
848FSM16X27	1	M27X2.0	710BSM27
848FSM16X33	1	M33X2.0	710BSM33
848FSM20X33	1-1/4	M33X2.0	710BSM33
848FSM20X42	1-1/4	M42X2.0	710BSM42
848FSM24X48	1-1/2	M48X1.5	710BSM48

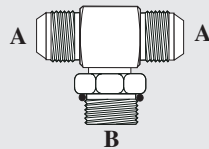

**845FSB**
**Mâle JIC / Mâle BSPP ajustable / Mâle JIC**  
**Male JIC / Male BSPP adjustable / Male JIC**

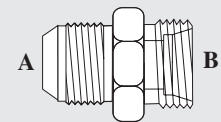
Numéro Part number	A (")	B (")	Joint d'étanchéité Bonded seal
845FSB04X04	1/4	1/4	710BSB04
845FSB05X04	5/16	1/4	710BSB04
845FSB06X04	3/8	1/4	710BSB04
845FSB06X06	3/8	3/8	710BSB06
845FSB08X06	1/2	3/8	710BSB06
845FSB10X08	5/8	1/2	710BSB08
845FSB12X12	3/4	3/4	710BSB12
845FSB16X16	1	1	710BSB16

**848FSML**
**Mâle JIC / Mâle métrique (port et tube) série légère**  
**Male JIC / Male metric (port and tube) light**
**851FSB**
**Mâle JIC / Mâle JIC / Mâle BSPP ajustable**  
**Male JIC / Male JIC / Male BSPP adjustable**

Numéro Part number	A (")	B (")	Joint d'étanchéité Bonded seal
851FSB04X04	1/4	1/4	710BSB04
851FSB05X04	5/16	1/4	710BSB04
851FSB06X04	3/8	1/4	710BSB06
851FSB06X06	3/8	3/8	710BSB08
851FSB08X06	1/2	3/8	710BSB06
851FSB08X08	1/2	1/2	710BSB08
851FSB10X08	5/8	1/2	710BSB08
851FSB12X12	3/4	3/4	710BSB10
851FSB16X16	1	1	710BSB12

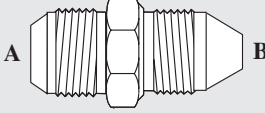
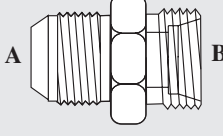
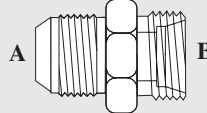
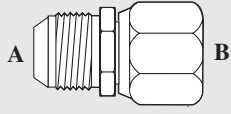
Numéro Part number	A (")	B (mm)	Tube mm	Joint d'étanchéité Bonded seal
848FSML4810	1/4	M8X1.0	4	710BSM08
848FSML48125	1/4	M8X1.25	----	710BSM08
848FSML41010	1/4	M10X1.0	6	710BSM10
848FSML41012	1/4	M10X1.25	----	710BSM10
848FSML41015	1/4	M10X1.5	----	710BSM10
848FSML41210	1/4	M12X1.0	8	710BSM12
848FSML41215	1/4	M12X1.5	6	710BSM12
848FSML04X14	1/4	M14X1.5	8	710BSM14
848FSML05X12	5/16	M12X1.5	6	710BSM12
848FSML05X14	5/16	M14X1.5	8	710BSM14
848FSML05X16	5/16	M16X1.5	10	710BSM16
848FSML61210	3/8	M12X1.0	8	710BSM12

Numéro Part number	A (")	B (mm)	Tube mm	Joint d'étanchéité Bonded seal	Numéro Part number	A (")	B (mm)	Tube mm	Joint d'étanchéité Bonded seal																																																																																																														
848FSML61212	3/8	M12X1.25	----	710BSM12	848FSMH16X42	1	M42X2.0	30	710BSM42																																																																																																														
848FSML06X14	3/8	M14X1.5	8	710BSM14	848FSMH20X52	1-1/4	M52X2.0	38	710BSM52																																																																																																														
848FSML06X16	3/8	M16X1.5	10	710BSM16	848FSMH24X52	1-1/2	M52X2.0	38	710BSM52																																																																																																														
848FSML06X18	3/8	M18X1.5	12	710BSM18	 <p><b>848FSK</b>  <b>Mâle JIC / Mâle Komatsu</b>  <b>Male JIC / Male Komatsu</b></p> <table border="1"> <thead> <tr> <th>Numéro Part number</th> <th>A (")</th> <th>B (mm)</th> </tr> </thead> <tbody> <tr> <td>848FSK04X14</td> <td>1/4</td> <td>M14X1.5</td> </tr> <tr> <td>848FSK06X18</td> <td>3/8</td> <td>M18X1.5</td> </tr> <tr> <td>848FSK08X22</td> <td>1/2</td> <td>M22X1.5</td> </tr> <tr> <td>848FSK10X24</td> <td>5/8</td> <td>M24X1.5</td> </tr> <tr> <td>848FSK12X30</td> <td>3/4</td> <td>M30X1.5</td> </tr> <tr> <td>848FSK16X33</td> <td>1</td> <td>M33X1.5</td> </tr> </tbody> </table>					Numéro Part number	A (")	B (mm)	848FSK04X14	1/4	M14X1.5	848FSK06X18	3/8	M18X1.5	848FSK08X22	1/2	M22X1.5	848FSK10X24	5/8	M24X1.5	848FSK12X30	3/4	M30X1.5	848FSK16X33	1	M33X1.5																																																																																									
Numéro Part number	A (")	B (mm)																																																																																																																					
848FSK04X14	1/4	M14X1.5																																																																																																																					
848FSK06X18	3/8	M18X1.5																																																																																																																					
848FSK08X22	1/2	M22X1.5																																																																																																																					
848FSK10X24	5/8	M24X1.5																																																																																																																					
848FSK12X30	3/4	M30X1.5																																																																																																																					
848FSK16X33	1	M33X1.5																																																																																																																					
848FSML08X16	1/2	M16X1.5	10	710BSM16																																																																																																																			
848FSML08X18	1/2	M18X1.5	12	710BSM18																																																																																																																			
848FSML08X22	1/2	M22X1.5	15	710BSM22																																																																																																																			
848FSML10X18	5/8	M18X1.5	12	710BSM18																																																																																																																			
848FSML10X22	5/8	M22X1.5	15	710BSM22																																																																																																																			
848FSML10X26	5/8	M26X1.5	18	710BSM26																																																																																																																			
848FSML12X22	3/4	M22X1.5	15	710BSM22																																																																																																																			
848FSML12X24	3/4	M24X1.5	18	710BSM24																																																																																																																			
848FSML12X26	3/4	M26X1.5	18	710BSM26																																																																																																																			
848FSML12301	3/4	M30X1.5	22	710BSM30																																																																																																																			
848FSML12302	3/4	M30X2.0	22	710BSM30																																																																																																																			
848FSML16X30	1	M30X1.5	22	710BSM30																																																																																																																			
848FSML16X36	1	M36X2.0	28	710BSM36																																																																																																																			
848FSML20X45	1-1/4	M45X2.0	35	710BSM45																																																																																																																			
848FSML20X52	1-1/4	M52X2.0	42	710BSM52																																																																																																																			
848FSML24X45	1-1/2	M45X2.0	----	710BSM45																																																																																																																			
848FSML24X52	1-1/2	52X2.0	42	710BSM52																																																																																																																			
 <p><b>848FSMH</b>  <b>Mâle JIC / Male métrique (port et tube) série lourde</b>  <b>Male JIC / Male metric (port and tube) heavy</b></p> <table border="1"> <thead> <tr> <th>Numéro Part number</th> <th>A (")</th> <th>B (mm)</th> <th>Tube mm</th> <th>Joint d'étanchéité Bonded seal</th> </tr> </thead> <tbody> <tr> <td>848FSMH04X14</td> <td>1/4</td> <td>M14X1.5</td> <td>6</td> <td>710BSM14</td> </tr> <tr> <td>848FSMH04X16</td> <td>1/4</td> <td>M16X1.5</td> <td>8</td> <td>710BSM16</td> </tr> <tr> <td>848FSMH04X18</td> <td>1/4</td> <td>M18X1.5</td> <td>10</td> <td>710BSM18</td> </tr> <tr> <td>848FSMH05X16</td> <td>5/16</td> <td>M16X1.5</td> <td>8</td> <td>710BSM16</td> </tr> <tr> <td>848FSMH05X18</td> <td>5/16</td> <td>M18X1.5</td> <td>10</td> <td>710BSM18</td> </tr> <tr> <td>848FSMH06X16</td> <td>3/8</td> <td>M16X1.5</td> <td>8</td> <td>710BSM16</td> </tr> <tr> <td>848FSMH06X18</td> <td>3/8</td> <td>M18X1.5</td> <td>10</td> <td>710BSM18</td> </tr> <tr> <td>848FSMH06X20</td> <td>3/8</td> <td>M20X1.5</td> <td>12</td> <td>710BSM20</td> </tr> <tr> <td>848FSMH06X22</td> <td>3/8</td> <td>M22X1.5</td> <td>14</td> <td>710BSM22</td> </tr> <tr> <td>848FSMH08X18</td> <td>1/2</td> <td>M18X1.5</td> <td>10</td> <td>710BSM18</td> </tr> <tr> <td>848FSMH08X20</td> <td>1/2</td> <td>M20X1.5</td> <td>12</td> <td>710BSM20</td> </tr> <tr> <td>848FSMH08X22</td> <td>1/2</td> <td>M22X1.5</td> <td>14</td> <td>710BSM22</td> </tr> <tr> <td>848FSMH08X24</td> <td>1/2</td> <td>M24X1.5</td> <td>16</td> <td>710BSM24</td> </tr> <tr> <td>848FSMH10X20</td> <td>5/8</td> <td>M20X1.5</td> <td>12</td> <td>710BSM20</td> </tr> <tr> <td>848FSMH10X24</td> <td>5/8</td> <td>M24X1.5</td> <td>16</td> <td>710BSM24</td> </tr> <tr> <td>848FSMH10X30</td> <td>5/8</td> <td>M30X2.0</td> <td>20</td> <td>710BSM30</td> </tr> <tr> <td>848FSMH10X36</td> <td>5/8</td> <td>M36X2.0</td> <td>25</td> <td>710BSM36</td> </tr> <tr> <td>848FSMH12X24</td> <td>3/4</td> <td>M24X1.5</td> <td>16</td> <td>710BSM24</td> </tr> <tr> <td>848FSMH12X30</td> <td>3/4</td> <td>M30X2.0</td> <td>20</td> <td>710BSM30</td> </tr> <tr> <td>848FSMH12X36</td> <td>3/4</td> <td>M36X2.0</td> <td>25</td> <td>710BSM36</td> </tr> <tr> <td>848FSMH16X30</td> <td>1</td> <td>M30X2.0</td> <td>20</td> <td>710BSM30</td> </tr> <tr> <td>848FSMH16X36</td> <td>1</td> <td>M36X2.0</td> <td>25</td> <td>710BSM36</td> </tr> </tbody> </table>					Numéro Part number	A (")	B (mm)	Tube mm	Joint d'étanchéité Bonded seal	848FSMH04X14	1/4	M14X1.5	6	710BSM14	848FSMH04X16	1/4	M16X1.5	8	710BSM16	848FSMH04X18	1/4	M18X1.5	10	710BSM18	848FSMH05X16	5/16	M16X1.5	8	710BSM16	848FSMH05X18	5/16	M18X1.5	10	710BSM18	848FSMH06X16	3/8	M16X1.5	8	710BSM16	848FSMH06X18	3/8	M18X1.5	10	710BSM18	848FSMH06X20	3/8	M20X1.5	12	710BSM20	848FSMH06X22	3/8	M22X1.5	14	710BSM22	848FSMH08X18	1/2	M18X1.5	10	710BSM18	848FSMH08X20	1/2	M20X1.5	12	710BSM20	848FSMH08X22	1/2	M22X1.5	14	710BSM22	848FSMH08X24	1/2	M24X1.5	16	710BSM24	848FSMH10X20	5/8	M20X1.5	12	710BSM20	848FSMH10X24	5/8	M24X1.5	16	710BSM24	848FSMH10X30	5/8	M30X2.0	20	710BSM30	848FSMH10X36	5/8	M36X2.0	25	710BSM36	848FSMH12X24	3/4	M24X1.5	16	710BSM24	848FSMH12X30	3/4	M30X2.0	20	710BSM30	848FSMH12X36	3/4	M36X2.0	25	710BSM36	848FSMH16X30	1	M30X2.0	20	710BSM30	848FSMH16X36	1	M36X2.0	25	710BSM36
					Numéro Part number	A (")	B (mm)	Tube mm	Joint d'étanchéité Bonded seal																																																																																																														
					848FSMH04X14	1/4	M14X1.5	6	710BSM14																																																																																																														
					848FSMH04X16	1/4	M16X1.5	8	710BSM16																																																																																																														
					848FSMH04X18	1/4	M18X1.5	10	710BSM18																																																																																																														
848FSMH05X16	5/16	M16X1.5	8	710BSM16																																																																																																																			
848FSMH05X18	5/16	M18X1.5	10	710BSM18																																																																																																																			
848FSMH06X16	3/8	M16X1.5	8	710BSM16																																																																																																																			
848FSMH06X18	3/8	M18X1.5	10	710BSM18																																																																																																																			
848FSMH06X20	3/8	M20X1.5	12	710BSM20																																																																																																																			
848FSMH06X22	3/8	M22X1.5	14	710BSM22																																																																																																																			
848FSMH08X18	1/2	M18X1.5	10	710BSM18																																																																																																																			
848FSMH08X20	1/2	M20X1.5	12	710BSM20																																																																																																																			
848FSMH08X22	1/2	M22X1.5	14	710BSM22																																																																																																																			
848FSMH08X24	1/2	M24X1.5	16	710BSM24																																																																																																																			
848FSMH10X20	5/8	M20X1.5	12	710BSM20																																																																																																																			
848FSMH10X24	5/8	M24X1.5	16	710BSM24																																																																																																																			
848FSMH10X30	5/8	M30X2.0	20	710BSM30																																																																																																																			
848FSMH10X36	5/8	M36X2.0	25	710BSM36																																																																																																																			
848FSMH12X24	3/4	M24X1.5	16	710BSM24																																																																																																																			
848FSMH12X30	3/4	M30X2.0	20	710BSM30																																																																																																																			
848FSMH12X36	3/4	M36X2.0	25	710BSM36																																																																																																																			
848FSMH16X30	1	M30X2.0	20	710BSM30																																																																																																																			
848FSMH16X36	1	M36X2.0	25	710BSM36																																																																																																																			
 <p><b>848FSKB</b>  <b>Mâle JIC / Mâle Kobelco</b>  <b>Male JIC / Male Kobelco</b></p> <table border="1"> <thead> <tr> <th>Numéro Part number</th> <th>A (")</th> <th>B (mm)</th> <th>Tube (mm)</th> </tr> </thead> <tbody> <tr> <td>848FSKB12X36</td> <td>3/4</td> <td>M36X1.5</td> <td>28</td> </tr> <tr> <td>848FSKB16X36</td> <td>1</td> <td>M36X1.5</td> <td>28</td> </tr> <tr> <td>848FSKB16X45</td> <td>1</td> <td>M45X1.5</td> <td>35</td> </tr> <tr> <td>848FSKB20X45</td> <td>1-1/4</td> <td>M45X1.5</td> <td>35</td> </tr> </tbody> </table>					Numéro Part number	A (")	B (mm)	Tube (mm)	848FSKB12X36	3/4	M36X1.5	28	848FSKB16X36	1	M36X1.5	28	848FSKB16X45	1	M45X1.5	35	848FSKB20X45	1-1/4	M45X1.5	35																																																																																															
					Numéro Part number	A (")	B (mm)	Tube (mm)																																																																																																															
					848FSKB12X36	3/4	M36X1.5	28																																																																																																															
					848FSKB16X36	1	M36X1.5	28																																																																																																															
					848FSKB16X45	1	M45X1.5	35																																																																																																															
848FSKB20X45	1-1/4	M45X1.5	35																																																																																																																				
 <p><b>846FSML</b>  <b>Mâle JIC / Femelle métrique tournant (série légère)</b>  <b>Male JIC / Female metric swivel (light)</b></p> <table border="1"> <thead> <tr> <th>Numéro Part number</th> <th>A (")</th> <th>B (mm)</th> <th>Tube (mm)</th> </tr> </thead> <tbody> <tr> <td>846FSML04X12</td> <td>1/4</td> <td>M12X1.5</td> <td>06</td> </tr> <tr> <td>846FSML04X14</td> <td>1/4</td> <td>M14X1.5</td> <td>08</td> </tr> <tr> <td>846FSML05X14</td> <td>5/16</td> <td>M14X1.5</td> <td>08</td> </tr> <tr> <td>846FSML05X16</td> <td>5/16</td> <td>M16X1.5</td> <td>10</td> </tr> <tr> <td>846FSML06X14</td> <td>3/8</td> <td>M14X1.5</td> <td>08</td> </tr> <tr> <td>846FSML06X16</td> <td>3/8</td> <td>M16X1.5</td> <td>10</td> </tr> <tr> <td>846FSML06X18</td> <td>3/8</td> <td>M18X1.5</td> <td>12</td> </tr> <tr> <td>846FSML08X18</td> <td>1/2</td> <td>M18X1.5</td> <td>12</td> </tr> <tr> <td>846FSML08X22</td> <td>1/2</td> <td>M22X1.5</td> <td>15</td> </tr> <tr> <td>846FSML10X22</td> <td>5/8</td> <td>M22X1.5</td> <td>15</td> </tr> </tbody> </table>					Numéro Part number	A (")	B (mm)	Tube (mm)	846FSML04X12	1/4	M12X1.5	06	846FSML04X14	1/4	M14X1.5	08	846FSML05X14	5/16	M14X1.5	08	846FSML05X16	5/16	M16X1.5	10	846FSML06X14	3/8	M14X1.5	08	846FSML06X16	3/8	M16X1.5	10	846FSML06X18	3/8	M18X1.5	12	846FSML08X18	1/2	M18X1.5	12	846FSML08X22	1/2	M22X1.5	15	846FSML10X22	5/8	M22X1.5	15																																																																							
					Numéro Part number	A (")	B (mm)	Tube (mm)																																																																																																															
					846FSML04X12	1/4	M12X1.5	06																																																																																																															
					846FSML04X14	1/4	M14X1.5	08																																																																																																															
					846FSML05X14	5/16	M14X1.5	08																																																																																																															
					846FSML05X16	5/16	M16X1.5	10																																																																																																															
					846FSML06X14	3/8	M14X1.5	08																																																																																																															
					846FSML06X16	3/8	M16X1.5	10																																																																																																															
					846FSML06X18	3/8	M18X1.5	12																																																																																																															
					846FSML08X18	1/2	M18X1.5	12																																																																																																															
					846FSML08X22	1/2	M22X1.5	15																																																																																																															
					846FSML10X22	5/8	M22X1.5	15																																																																																																															



Numéro Part number	A (")	B (mm)	Tube (mm)
846FSML10X26	5/8	M26X1.5	18
846FSML12X26	3/4	M26X1.5	18
846FSML12X30	3/4	M30X2.0	22

  

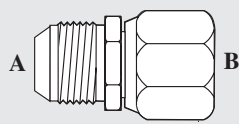

**846FSMH**  
 Mâle JIC / Femelle métrique tournant (série lourde)  
 Male JIC / Female metric swivel (heavy)

Numéro Part number	A (")	B (mm)	Tube (mm)
846FSMH04X16	1/4	M16X1.5	08
846FSMH04X18	1/4	M18X1.5	10
846FSMH05X16	5/16	M16X1.5	08
846FSMH05X18	5/16	M18X1.5	10
846FSMH06X18	3/8	M18X1.5	10
846FSMH06X20	3/8	M20X1.5	12
846FSMH06X22	3/8	M22X1.5	14
846FSMH08X22	1/2	M22X1.5	14
846FSMH10X22	5/8	M22X1.5	14
846FSMH10X30	5/8	M30X2.0	20
846FSMH10X36	5/8	M36X2.0	25
846FSMH12X24	3/4	M24X1.5	16
846FSMH12X30	3/4	M30X2.0	20
846FSMH16X30	1	M30X2.0	20

  

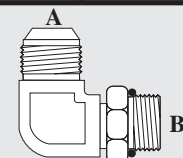

**849FSM**  
 Mâle JIC / Mâle métrique ajustable  
 Male JIC / Male metric adjustable

Numéro Part number	A (")	B (mm)	Joint d'étanchéité Bonded seal
881FSM05X12	5/16	M12X1.5	710BSM12
881FSM06X14	3/8	M14X1.5	710BSM14
881FSM06X16	3/8	M16X1.5	710BSM16
881FSM06X18	3/8	M18X1.5	710BSM18
881FSM06X20	3/8	M20X1.5	710BSM20
881FSM06X22	3/8	M22X1.5	710BSM22
881FSM08X16	1/2	M16X1.5	710BSM16
881FSM08X18	1/2	M18X1.5	710BSM18
881FSM08X20	1/2	M20X1.5	710BSM20
881FSM08X22	1/2	M22X1.5	710BSM22
881FSM10X16	5/8	M16X1.5	710BSM16
881FSM10X18	5/8	M18X1.5	710BSM18
881FSM10X20	5/8	M20X1.5	710BSM20
881FSM10X22	5/8	M22X1.5	710BSM22

  

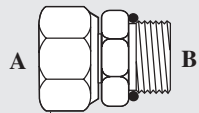

**846FSK**  
 Mâle JIC / Femelle Komatsu  
 male JIC / Female Komatsu



Numéro Part number	A (")	B (mm)
846FSK04X14	1/4	M14X1.5
846FSK06X18	3/8	M18X1.5
846FSK08X22	1/2	M22X1.5
846FSK10X24	5/8	M24X1.5
846FSK12X30	3/4	M30X1.5

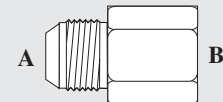

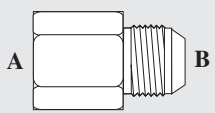
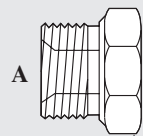
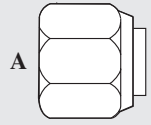
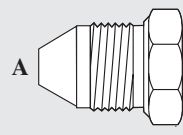

**835FS**  
 Mâle JIC / Femelle SAE 45 fixe  
 Male JIC / Female SAE 45 solid

Numéro Part number	A (")	B (")
835FS06X06	3/8	3/8

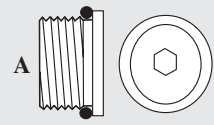
				
<b>836FS</b> <b>Femelle JIC fixe / Mâle SAE 45</b> <b>Female JIC solid / Male SAE 45</b>			<b>639FS</b> <b>Bouchon mâle BSPP</b> <b>BSPP male plug</b>	
Numéro Part number	A (")	B (")	Numéro Part number	A (")
836FS06X06	3/8	3/8	639FS02	1/8
<b>BSPP</b>			639FS04	1/4
			639FS06	3/8
<b>630FS</b> <b>Bouchon femelle BSPP tournant</b> <b>BSPP female plug swivel</b>			639FS08	1/2
Numéro Part number	A (")		639FS10	5/8
630FS02	1/8		639FS12	3/4
630FS04	1/4		639FS16	1
630FS06	3/8		639FS20	1-1/4
630FS08	1/2		639FS24	1-1/2
630FS10	5/8		639FS32	2
630FS12	3/4			
630FS16	1		<b>639FSJ</b> <b>Bouchon mâle JIS</b> <b>JIS male plug</b>	
630FS20	1-1/4		Numéro Part number	A (")
630FS24	1-1/2		639FSJ02	1/8
630FS32	2		639FSJ04	1/4
			639FSJ06	3/8
<b>630FSJ</b> <b>Bouchon femelle JIS</b> <b>JIS female plug</b>			639FSJ08	1/2
Numéro Part number	A (")		639FSJ12	3/4
630FSJ02	1/8			
630FSJ04	1/4		<b>639FSR</b> <b>Bouchon mâle BSPP (type Allen screw)</b> <b>BSPP male plug (Allen screw type)</b>	
630FSJ06	3/8		Numéro Part number	A (")
630FSJ08	1/2		639FSR02	1/8
630FSJ12	3/4		639FSR04	1/4
630FSJ16	1		639FSR06	3/8
			639FSR08	1/2
			639FSR12	3/4
			639FSR16	1
			639FSR20	1-1/4
			639FSR24	1-1/2

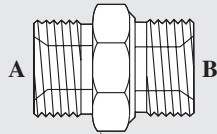
**642FS**
**Mâle BSPP / Mâle BSPP**  
**Male BSPP / Male BSPP**

Numéro Part number	A (")	B (")	Joint d'étanchéité Bonded seal
642FS02X02	1/8	1/8	710BSB02
642FS04X02	1/4	1/8	710BSB02
642FS04X04	1/4	1/4	710BSB04
642FS06X02	3/8	1/8	710BSB02
642FS06X04	3/8	1/4	710BSB04
642FS06X06	3/8	3/8	710BSB06
642FS08X04	1/2	1/4	710BSB04
642FS08X06	1/2	3/8	710BSB06
642FS08X08	1/2	1/2	710BSB08
642FS10X06	5/8	3/8	710BSB06
642FS10X08	5/8	1/2	710BSB08
642FS10X10	5/8	5/8	710BSB10
642FS12X06	3/4	3/8	710BSB06
642FS12X08	3/4	1/2	710BSB08
642FS12X10	3/4	5/8	710BSB10
642FS12X12	3/4	3/4	710BSB12
642FS16X06	1	3/8	710BSB06
642FS16X08	1	1/2	710BSB08
642FS16X10	1	5/8	710BSB10
642FS16X12	1	3/4	710BSB12
642FS16X16	1	1	710BSB16
642FS20X12	1-1/4	3/4	710BSB12
642FS20X16	1-1/4	1	710BSB16
642FS20X20	1-1/4	1-1/4	710BSB20
642FS24X16	1-1/2	1	710BSB16
642FS24X20	1-1/2	1-1/4	710BSB20
642FS24X24	1-1/2	1-1/2	710BSB24
642FS32X16	2	1	710BSB16
642FS32X20	2	1-1/4	710BSB20
642FS32X24	2	1-1/2	710BSB24
642FS32X32	2	2	710BSB32

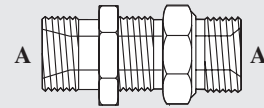
**632FS**
**Mâle BSPP / Mâle BSPP cloison**  
**Male BSPP / Male BSPP bulkhead**

Numéro Part number	A (")	Écrou Nut
632FS04	1/4	711BPO04
632FS06	3/8	711BPO06
632FS08	1/2	711BPO08
632FS10	5/8	711BPO10
632FS12	3/4	711BPO12
632FS16	1	711BPO16
632FS20	1-1/4	711BPO20

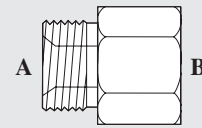

**683FS**
**Mâle BSPP / Femelle BSPP fixe**  
**Male BSPP / Female BSPP solid**

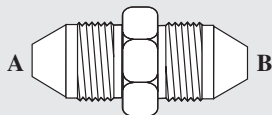
Numéro Part number	A (")	B (")
683FS02X04	1/8	1/4
683FS02X06	1/8	3/8
683FS04X02	1/4	1/8
683FS04X06	1/4	3/8
683FS04X12	1/4	3/4
683FS06X02	3/8	1/8
683FS06X04	3/8	1/4
683FS06X06	3/8	3/8
683FS06X08	3/8	1/2
683FS08X02	1/2	1/8
683FS08X04	1/2	1/4
683FS08X06	1/2	3/8
683FS08X12	1/2	3/4
683FS08X16	1/2	1
683FS08X20	1/2	1-1/4
683FS12X04	3/4	1/4
683FS12X06	3/4	3/8
683FS12X08	3/4	1/2
683FS12X16	3/4	1
683FS12X20	3/4	1-1/4
683FS12X24	3/4	1-1/2
683FS16X04	1	1/4
683FS16X06	1	3/8
683FS16X08	1	1/2
683FS16X12	1	3/4
683FS16X20	1	1-1/4
683FS16X24	1	1-1/2
683FS20X08	1-1/4	1/2
683FS20X12	1-1/4	3/4

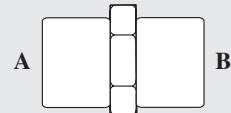
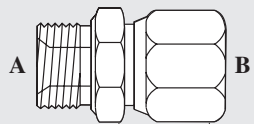
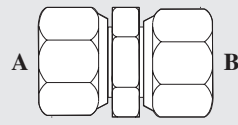

**642FSJ**
**Mâle JIS / Mâle JIS**  
**Male JIS / Male JIS**

Numéro Part number	A (")	B (")
642FSJ02X02	1/8	1/8
642FSJ04X04	1/4	1/4
642FSJ06X06	3/8	3/8
642FSJ08X08	1/2	1/2
642FSJ12X12	3/4	3/4

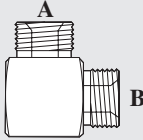
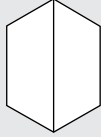
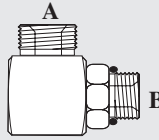
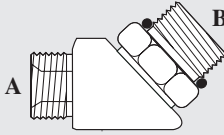
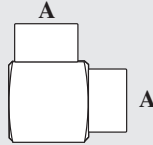

Numéro Part number	A (")	B (")				
683FS20X16	1-1/4	1	<b>680FS</b> <b>Femelle BSPP fixe / Femelle BSPP fixe</b> <b>Female BSPP solid / Female BSPP solid</b>			
683FS20X24	1-1/4	1-1/2				
683FS24X08	1-1/2	1/2				
683FS24X12	1-1/2	3/4				
683FS24X16	1-1/2	1				
683FS24X20	1-1/2	1-1/4				
			Numéro Part number	A (")	B (")	
<b>683FSSW</b> <b>Mâle BSPP / Femelle BSPP tournant</b> <b>Male BSPP / Female BSPP swivel</b>			680FS02X02	1/8	1/8	
			680FS04X02	1/4	1/8	
			680FS04X04	1/4	1/4	
			680FS06X04	3/8	1/4	
			680FS06X06	3/8	3/8	
			680FS08X06	1/2	3/8	
			680FS08X08	1/2	1/2	
			680FS10X08	5/8	1/2	
			680FS10X10	5/8	5/8	
			680FS12X08	3/4	1/2	
			680FS12X12	3/4	3/4	
			680FS16X12	1	3/4	
			680FS16X16	1	1	
			680FS20X20	1-1/4	1-1/4	
			680FS24X24	1-1/2	1-1/2	
Numéro Part number	A (")	Joint d'étanchéité Bonded seal	B (")			
				<b>680FSSW</b> <b>Femelle BSPP tournant / Femelle BSPP tournant</b> <b>Female BSPP swivel / Female BSPP swivel</b>		
				Numéro Part number	A (")	B (")
683FSSW02X02	1/8	710BSB02	1/8	680FSSW02X02	1/8	1/8
683FSSW02X04	1/8	710BSB02	1/4	680FSSW04X04	1/4	1/4
683FSSW04X02	1/4	710BSB04	1/8	680FSSW06X04	3/8	1/4
683FSSW04X04	1/4	710BSB04	1/4	680FSSW06X06	3/8	3/8
683FSSW04X06	1/4	710BSB04	3/8	680FSSW08X04	1/2	1/4
683FSSW04X08	1/4	710BSB04	1/2	680FSSW08X06	1/2	3/8
683FSSW06X04	3/8	710BSB06	1/4	680FSSW08X08	1/2	1/2
683FSSW06X06	3/8	710BSB06	3/8	680FSSW10X08	5/8	1/2
683FSSW06X08	3/8	710BSB06	1/2	680FSSW10X10	5/8	5/8
683FSSW06X12	3/8	710BSB06	3/4	680FSSW12X08	3/4	1/2
683FSSW08X04	1/2	710BSB08	1/4	680FSSW12X10	3/4	3/4
683FSSW08X06	1/2	710BSB08	3/8	680FSSW12X12	3/4	3/4
683FSSW08X08	1/2	710BSB08	1/2	680FSSW12X16	3/4	1
683FSSW08X10	1/2	710BSB08	5/8	680FSSW12X20	3/4	1-1/4
683FSSW08X12	1/2	710BSB08	3/4	680FSSW16X08	1	1/2
683FSSW08X16	1/2	710BSB08	1	680FSSW16X10	1	5/8
683FSSW10X08	5/8	710BSB10	1/2	680FSSW16X12	1	3/4
683FSSW10X10	5/8	710BSB10	5/8	680FSSW20X20	1-1/4	1/2
683FSSW10X12	5/8	710BSB10	3/4	680FSSW20X16	1-1/4	1
683FSSW12X06	3/4	710BSB12	3/8	680FSSW20X24	1-1/4	1-1/4
683FSSW12X08	3/4	710BSB12	1/2	683FSSW24X20	1-1/2	1-1/4
683FSSW12X10	3/4	710BSB12	5/8	683FSSW24X24	1-1/2	1-1/2
683FSSW12X12	3/4	710BSB12	3/4	683FSSW24X32	1-1/2	2
683FSSW12X16	3/4	710BSB12	1	683FSSW32X24	2	1-1/2
683FSSW12X20	3/4	710BSB12	1-1/4	683FSSW32X32	2	2
683FSSW16X08	1	710BSB16	1/2			
683FSSW16X10	1	710BSB16	5/8			
683FSSW16X12	1	710BSB16	3/4			
683FSSW16X16	1	710BSB16	1			
683FSSW16X20	1	710BSB16	1-1/4			

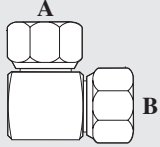
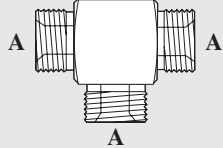
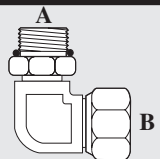
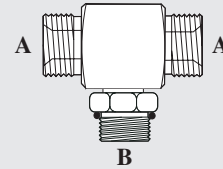
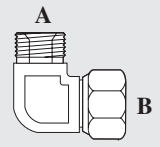
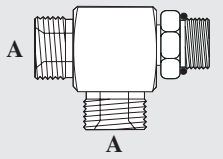
																																															
<b>698FS</b> <b>Siège BSPP face plate</b> <b>BSPP flat face sealing seat</b>		<b>655FS</b> <b>Mâle BSPP / Mâle BSPP</b> <b>Male BSPP / Male BSPP</b>																																													
<table border="1"> <thead> <tr> <th>Numéro Part number</th> <th>Dimension Size</th> </tr> </thead> <tbody> <tr> <td>698FS06</td> <td>3/8</td> </tr> <tr> <td>698FS08</td> <td>1/2</td> </tr> <tr> <td>698FS12</td> <td>3/4</td> </tr> </tbody> </table>	Numéro Part number	Dimension Size	698FS06	3/8	698FS08	1/2	698FS12	3/4	<table border="1"> <thead> <tr> <th>Numéro Part number</th> <th>A (")</th> <th>B (")</th> </tr> </thead> <tbody> <tr> <td>655FS02X02</td> <td>1/8</td> <td>1/8</td> </tr> <tr> <td>655FS04X04</td> <td>1/4</td> <td>1/4</td> </tr> <tr> <td>655FS06X04</td> <td>3/8</td> <td>1/4</td> </tr> <tr> <td>655FS06X06</td> <td>3/8</td> <td>3/8</td> </tr> <tr> <td>655FS08X06</td> <td>1/2</td> <td>3/8</td> </tr> <tr> <td>655FS08X08</td> <td>1/2</td> <td>1/2</td> </tr> <tr> <td>655FS10X10</td> <td>5/8</td> <td>5/8</td> </tr> <tr> <td>655FS12X12</td> <td>3/4</td> <td>3/4</td> </tr> <tr> <td>655FS16X16</td> <td>1</td> <td>1</td> </tr> </tbody> </table>			Numéro Part number	A (")	B (")	655FS02X02	1/8	1/8	655FS04X04	1/4	1/4	655FS06X04	3/8	1/4	655FS06X06	3/8	3/8	655FS08X06	1/2	3/8	655FS08X08	1/2	1/2	655FS10X10	5/8	5/8	655FS12X12	3/4	3/4	655FS16X16	1	1						
Numéro Part number	Dimension Size																																														
698FS06	3/8																																														
698FS08	1/2																																														
698FS12	3/4																																														
Numéro Part number	A (")	B (")																																													
655FS02X02	1/8	1/8																																													
655FS04X04	1/4	1/4																																													
655FS06X04	3/8	1/4																																													
655FS06X06	3/8	3/8																																													
655FS08X06	1/2	3/8																																													
655FS08X08	1/2	1/2																																													
655FS10X10	5/8	5/8																																													
655FS12X12	3/4	3/4																																													
655FS16X16	1	1																																													
																																															
<b>699FS</b> <b>Siège BSPP-JIS</b> <b>BSPP-JIS sealing seat</b>		<b>655FSA</b> <b>Mâle BSPP / Mâle BSPP ajustable</b> <b>Male BSPP / Male BSPP adjustable</b>																																													
<table border="1"> <thead> <tr> <th>Numéro Part number</th> <th>Dimension Size</th> </tr> </thead> <tbody> <tr> <td>699FS04</td> <td>1/4</td> </tr> <tr> <td>699FS06</td> <td>3/8</td> </tr> <tr> <td>699FS08</td> <td>1/2</td> </tr> <tr> <td>699FS12</td> <td>3/4</td> </tr> <tr> <td>699FS16</td> <td>1</td> </tr> </tbody> </table>	Numéro Part number	Dimension Size	699FS04	1/4	699FS06	3/8	699FS08	1/2	699FS12	3/4	699FS16	1	<table border="1"> <thead> <tr> <th>Numéro Part number</th> <th>A (")</th> <th>B (")</th> <th>Joint d'étanchéité Bonded seal</th> </tr> </thead> <tbody> <tr> <td>655FSA04X04</td> <td>1/4</td> <td>1/4</td> <td>710BSB04</td> </tr> <tr> <td>655FSA06X06</td> <td>3/8</td> <td>3/8</td> <td>710BSB06</td> </tr> <tr> <td>655FSA08X08</td> <td>1/2</td> <td>1/2</td> <td>710BSB08</td> </tr> <tr> <td>655FSA12X12</td> <td>3/4</td> <td>3/4</td> <td>710BSB12</td> </tr> </tbody> </table>			Numéro Part number	A (")	B (")	Joint d'étanchéité Bonded seal	655FSA04X04	1/4	1/4	710BSB04	655FSA06X06	3/8	3/8	710BSB06	655FSA08X08	1/2	1/2	710BSB08	655FSA12X12	3/4	3/4	710BSB12												
Numéro Part number	Dimension Size																																														
699FS04	1/4																																														
699FS06	3/8																																														
699FS08	1/2																																														
699FS12	3/4																																														
699FS16	1																																														
Numéro Part number	A (")	B (")	Joint d'étanchéité Bonded seal																																												
655FSA04X04	1/4	1/4	710BSB04																																												
655FSA06X06	3/8	3/8	710BSB06																																												
655FSA08X08	1/2	1/2	710BSB08																																												
655FSA12X12	3/4	3/4	710BSB12																																												
																																															
<b>656FSA</b> <b>Mâle BSPP / Mâle BSPP ajustable</b> <b>Male BSPP / Male BSPP adjustable</b>		<b>674FS</b> <b>Femelle BSPP fixe / Femelle BSPP fixe</b> <b>Female BSPP solid / Female BSPP solid</b>																																													
<table border="1"> <thead> <tr> <th>Numéro Part number</th> <th>A (")</th> <th>B (")</th> <th>Joint d'étanchéité Bonded seal</th> </tr> </thead> <tbody> <tr> <td>656FSA04X04</td> <td>1/4</td> <td>1/4</td> <td>710BSB04</td> </tr> <tr> <td>656FSA06X04</td> <td>3/8</td> <td>1/4</td> <td>710BSB04</td> </tr> <tr> <td>656FSA06X06</td> <td>3/8</td> <td>3/8</td> <td>710BSB06</td> </tr> <tr> <td>656FSA08X06</td> <td>1/2</td> <td>3/8</td> <td>710BSB06</td> </tr> <tr> <td>656FSA08X08</td> <td>1/2</td> <td>1/2</td> <td>710BSB08</td> </tr> <tr> <td>656FSA12X12</td> <td>3/4</td> <td>3/4</td> <td>710BSB12</td> </tr> <tr> <td>656FSA16X16</td> <td>1</td> <td>1</td> <td>710BSB16</td> </tr> </tbody> </table>	Numéro Part number	A (")	B (")	Joint d'étanchéité Bonded seal	656FSA04X04	1/4	1/4	710BSB04	656FSA06X04	3/8	1/4	710BSB04	656FSA06X06	3/8	3/8	710BSB06	656FSA08X06	1/2	3/8	710BSB06	656FSA08X08	1/2	1/2	710BSB08	656FSA12X12	3/4	3/4	710BSB12	656FSA16X16	1	1	710BSB16	<table border="1"> <thead> <tr> <th>Numéro Part number</th> <th>A (")</th> </tr> </thead> <tbody> <tr> <td>674FS04</td> <td>1/4</td> </tr> <tr> <td>674FS06</td> <td>3/8</td> </tr> <tr> <td>674FS08</td> <td>1/2</td> </tr> <tr> <td>674FS12</td> <td>3/4</td> </tr> <tr> <td>674FS16</td> <td>1</td> </tr> </tbody> </table>			Numéro Part number	A (")	674FS04	1/4	674FS06	3/8	674FS08	1/2	674FS12	3/4	674FS16	1
Numéro Part number	A (")	B (")	Joint d'étanchéité Bonded seal																																												
656FSA04X04	1/4	1/4	710BSB04																																												
656FSA06X04	3/8	1/4	710BSB04																																												
656FSA06X06	3/8	3/8	710BSB06																																												
656FSA08X06	1/2	3/8	710BSB06																																												
656FSA08X08	1/2	1/2	710BSB08																																												
656FSA12X12	3/4	3/4	710BSB12																																												
656FSA16X16	1	1	710BSB16																																												
Numéro Part number	A (")																																														
674FS04	1/4																																														
674FS06	3/8																																														
674FS08	1/2																																														
674FS12	3/4																																														
674FS16	1																																														

							
<b>675FS</b> <b>Femelle BSPP tournant / Femelle BSPP tournant</b> <b>Female BSPP swivel / Female BSPP swivel</b>				<b>644FS</b> <b>Mâle BSPP / Mâle BSPP / Mâle BSPP</b> <b>Male BSPP / Male BSPP / Male BSPP</b>			
Numéro Part number	A (")	B (")		Numéro Part number	A (")	Joint d'étanchéité Bonded seal	
675FS04X04	1/4	1/4		644FS04	1/4	710BSB04	
675FS06X06	3/8	3/8		644FS06	3/8	710BSB06	
675FS08X08	1/2	1/2		644FS08	1/2	710BSB08	
675FS10X10	5/8	5/8		644FS10	5/8	710BSB10	
675FS12X12	3/4	3/4		644FS12	3/4	710BSB12	
675FS16X16	1	1		644FS16	1	710BSB16	
							
<b>679FS</b> <b>Mâle BSPP ajustable / Femelle BSPP tournant</b> <b>Male BSPP adjustable / Female BSPP swivel</b>				<b>670FS</b> <b>Mâle BSPP / Mâle BSPP ajustable / Mâle BSPP</b> <b>Male BSPP / Male BSPP adjustable / Male BSPP</b>			
Numéro Part number	A (")	Joint d'étanchéité Bonded seal	B (")	Numéro Part number	A (")	B (")	Joint d'étanchéité Bonded seal
679FS04X04	1/4	710BSB04	1/4	670FS04X04	1/4	1/4	710BSB04
679FS06X06	3/8	710BSB06	3/8	670FS06X04	3/8	1/4	710BSB04
679FS08X08	1/2	710BSB08	1/2	670FS06X06	3/8	3/8	710BSB06
679FS10X10	5/8	710BSB10	5/8	670FS08X06	1/2	3/8	710BSB06
679FS12X12	3/4	710BSB12	3/4	670FS08X08	1/2	1/2	710BSB08
679FS16X16	1	710BSB16	1	670FS12X12	3/4	3/4	710BSB12
							
<b>679FSB</b> <b>Mâle BSPP / Femelle BSPP tournant</b> <b>Male BSPP / Female BSPP swivel</b>				<b>661FS</b> <b>Mâle BSPP / Mâle BSPP / Mâle BSPP ajustable</b> <b>Male BSPP / Male BSPP / Male BSPP adjustable</b>			
Numéro Part number	A (")	Joint d'étanchéité Bonded seal	B (")	Numéro Part number	A (")	B (")	Joint d'étanchéité Bonded seal
679FSB02X02	1/8	710BSB02	1/8	661FS04X04	1/4	1/4	710BSB04
679FSB04X04	1/4	710BSB04	1/4	661FS06X04	3/8	1/4	710BSB04
679FSB04X06	1/4	710BSB04	3/8	661FS06X06	3/8	3/8	710BSB06
679FSB06X04	3/8	710BSB06	1/4	661FS08X06	1/2	3/8	710BSB06
679FSB06X06	3/8	710BSB06	3/8	661FS08X08	1/2	1/2	710BSB08
679FSB06X08	3/8	710BSB06	1/2	661FS12X12	3/4	3/4	710BSB12
679FSB08X06	1/2	710BSB08	3/8				
679FSB08X08	1/2	710BSB08	1/2				
679FSB10X10	5/8	710BSB10	5/8				
679FSB12X12	3/4	710BSB12	3/4				
679FSB16X12	1	710BSB16	3/4				
679FSB16X16	1	710BSB16	1				
679FSB20X20	1-1/4	710BSB20	1-1/4				
679FSB24X24	1-1/2	710BSB24	1-1/2				
679FSB32X32	2	710BSB32	2				

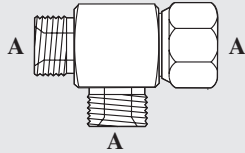
**671FS**
**Mâle BSPP / Mâle BSPP / Femelle BSPP tournant**  
**Male BSPP / Male BSPP / Female BSPP swivel**

Numéro Part number	A (")	Joint d'étanchéité Bonded seal
671FS04	1/4	710BSB04
671FS06	3/8	710BSB06
671FS08	1/2	710BSB08
671FS10	5/8	710BSB10
671FS12	3/4	710BSB12
671FS16	1	710BSB16

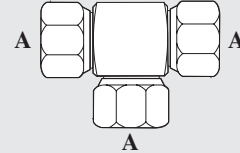
**673FSSW**
**Femelle BSPP tourn./Femelle BSPP tourn./Femelle BSPP tourn.**  
**Female BSPP swivel/Female BSPP swivel/Female BSPP swivel**

Numéro Part number	A (")
673FSSW02	1/8
673FSSW04	1/4
673FSSW06	3/8
673FSSW08	1/2
673FSSW10	5/8
673FSSW12	3/4
673FSSW16	1
673FSSW20	1-1/4
673FSSW24	1-1/2
673FSSW32	2

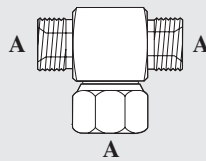
**672FS**
**Mâle BSPP / Femelle BSPP tournant / Mâle BSPP**  
**Male BSPP / Female BSPP swivel / Male BSPP**

Numéro Part number	A (")	Joint d'étanchéité Bonded seal
672FS02	1/8	710BSB02
672FS04	1/4	710BSB04
672FS06	3/8	710BSB06
672FS08	1/2	710BSB08
672FS10	5/8	710BSB10
672FS12	3/4	710BSB12
672FS16	1	710BSB16
672FS20	1-1/4	710BSB20

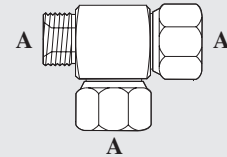
**677FS**
**Mâle BSPP / Femelle BSPP tournant / Femelle BSPP tournant**  
**Male BSPP / Female BSPP swivel / Female BSPP swivel**

Numéro Part number	A (")	Joint d'étanchéité Bonded seal
677FS04	1/4	710BSB04
677FS06	3/8	710BSB06
677FS08	1/2	710BSB08
677FS10	5/8	710BSB10
677FS12	3/4	710BSB12
677FS16	1	710BSB16

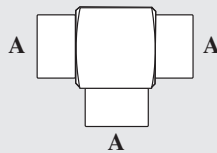

**673FS**
**Femelle BSPP fixe / Femelle BSPP fixe / Femelle BSPP fixe**  
**Female BSPP solid / Female BSPP solid / Female BSPP solid**

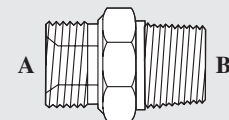
Numéro Part number	A (")
673FS02	1/8
673FS04	1/4
673FS06	3/8
673FS08	1/2
673FS12	3/4
673FS16	1

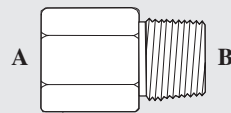
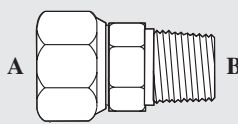
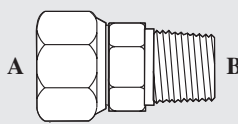
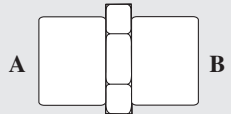
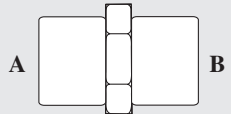

**648FS**
**Mâle BSPP / Mâle NPTF**  
**Male BSPP / Male NPTF**

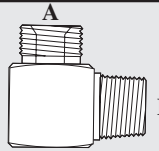
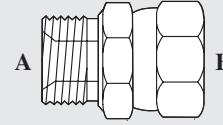
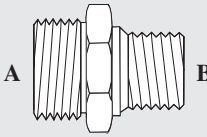
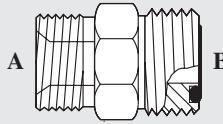
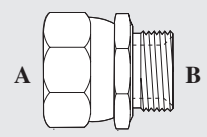
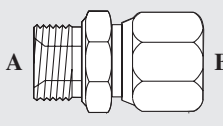
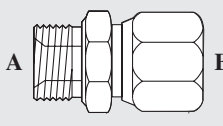
Numéro Part number	A (")	Joint d'étanchéité Bonded seal	B (")
648FS02X02	1/8	710BSB02	1/8
648FS02X04	1/8	710BSB02	1/4
648FS04X02	1/4	710BSB04	1/8
648FS04X04	1/4	710BSB04	1/4
648FS04X06	1/4	710BSB04	3/8
648FS04X08	1/4	710BSB04	1/2
648FS06X02	3/8	710BSB06	1/8
648FS06X04	3/8	710BSB06	1/4
648FS06X06	3/8	710BSB06	3/8
648FS06X08	3/8	710BSB06	1/2

Numéro Part number	A (")	Joint d'étanchéité Bonded seal	B (")			
648FS06X12	3/8	710BSB06	3/4	<b>681FS</b> <b>Femelle BSPP fixe / Mâle NPTF</b> <b>Female BSPP solid / Male NPTF</b>		
648FS06X16	3/8	710BSB06	1			
648FS08X04	1/2	710BSB08	1/4			
648FS08X06	1/2	710BSB08	3/8			
648FS08X08	1/2	710BSB08	1/2			
648FS08X12	1/2	710BSB08	3/4			
648FS08X16	1/2	710BSB08	1			
648FS10X08	5/8	710BSB10	1/2			
648FS10X12	5/8	710BSB10	3/4			
648FS12X04	3/4	710BSB12	1/4			
648FS12X06	3/4	710BSB12	3/8			
648FS12X08	3/4	710BSB12	1/2			
648FS12X12	3/4	710BSB12	3/4			
648FS12X16	3/4	710BSB12	1			
648FS16X08	1	710BSB16	1/2			
648FS16X12	1	710BSB16	3/4			
648FS16X16	1	710BSB16	1			
648FS16X20	1	710BSB16	1-1/4			
648FS20X16	1-1/4	710BSB20	1			
648FS20X20	1-1/4	710BSB20	1-1/4			
648FS20X24	1-1/4	710BSB20	1-1/2			
648FS24X16	1-1/2	710BSB24	1			
648FS24X20	1-1/2	710BSB24	1-1/4			
648FS24X24	1-1/2	710BSB24	1-1/2			
648FS24X32	1-1/2	710BSB24	2			
648FS32X20	2	710BSB32	1-1/4			
648FS32X24	2	710BSB32	1-1/2			
648FS32X32	2	710BSB32	2			
				<b>646FS</b> <b>Mâle BSPP / Femelle NPTF</b> <b>Male BSPP / Female NPTF</b>		
Numéro Part number	A (")	Joint d'étanchéité Bonded seal	B (")			
681FS04X04	1/4		1/4	<b>681FSSW</b> <b>Femelle BSPP tournant / Mâle NPTF</b> <b>Female BSPP swivel / Male NPTF</b>		
681FS06X04	3/8		1/4			
681FS06X06	3/8		3/8			
681FS08X06	1/2		3/8			
681FS08X08	1/2		1/2			
681FS12X08	3/4		1/2			
681FS12X12	3/4		3/4			
681FS12X16	3/4		1			
681FS12X12	3/4		3/4			
681FSSW02X02	1/8		1/8			
681FSSW04X04	1/4		1/4			
681FSSW04X06	1/4		3/8			
681FSSW06X06	3/8		3/8			
681FSSW06X08	3/8		1/2			
681FSSW08X06	1/2		3/8			
681FSSW08X08	1/2		1/2			
681FSSW08X12	1/2		3/4			
681FSSW12X12	3/4		3/4			
681FSSW12X16	3/4		1			
681FSSW16X16	1		1			
				<b>682FS</b> <b>Femelle BSPP fixe / Femelle NPTF</b> <b>Female BSPP solid / Female NPTF</b>		
Numéro Part number	A (")	Joint d'étanchéité Bonded seal	B (")			
646FS02X02	1/8	710BSB02	1/8	<b>682FS</b> <b>Femelle BSPP fixe / Femelle NPTF</b> <b>Female BSPP solid / Female NPTF</b>		
646FS02X04	1/8	710BSB02	1/4			
646FS04X04	1/4	710BSB04	1/4			
646FS04X06	1/4	710BSB04	3/8			
646FS06X04	3/8	710BSB06	1/4			
646FS06X06	3/8	710BSB06	3/8			
646FS08X06	1/2	710BSB08	3/8			
646FS08X08	1/2	710BSB08	1/2			
646FS12X12	3/4	710BSB12	3/4			
646FS16X08	1	710BSB16	1/2			
646FS16X16	1	710BSB16	1			
646FS20X16	1-1/4	710BSB20	1			
646FS20X20	1-1/4	710BSB20	1-1/4			
646FS24X20	1-1/2	710BSB24	1-1/4			
646FS24X24	1-1/2	710BSB24	1-1/2			
682FS02X02	1/8		1/8			
682FS04X04	1/4		1/4			
682FS06X06	3/8		3/8			
682FS08X08	1/2		1/2			
682FS12X12	3/4		3/4			
682FS16X16	1		1			
682FS20X20	1-1/4		1-1/4			
682FS24X24	1-1/2		1-1/2			
682FS32X32	2		2			

													
<b>649FS</b> <b>Mâle BSPP / Mâle NPTF</b> <b>Male BSPP / Male NPTF</b>				<b>646FSM</b> <b>Mâle BSPP / Femelle métrique tournant</b> <b>Male BSPP / Female metric swivel</b>									
Numéro Part number	A (")	Joint d'étanchéité Bonded seal	B (")	Numéro Part number	A (")	Joint d'étanchéité Bonded seal	B (mm)	Tube mm					
649FS04X04	1/4	710BSB04	1/4	646FSM04X14	1/4	710BSB04	M14X1.5	8					
649FS06X06	3/8	710BSB06	3/8	646FSM08X18	1/2	710BSB08	M18X1.5	12					
649FS08X08	1/2	710BSB08	1/2	646FSM08X20	1/2	710BSB08	M20X1.5	12					
649FS12X12	3/4	710BSB12	3/4	646FSM08X24	1/2	710BSB08	M24X1.5	16					
				646FSM12X26	3/4	710BSB12	M26X1.5	18					
				646FSM16X30	1	710BSB16	M30X2.0	22					
				646FSM20X45	1-1/4	710BSB20	M45X2.0	35					
				646FSM24X52	1-1/2	710BSB24	M52X2.0	42					
									<b>648TT</b> <b>Mâle BSPP / Mâle o'ring face</b> <b>Male BSPP / Male o'ring face</b>				
				Numéro Part number	A (")	B (mm)	Joint d'étanchéité Bonded seal	Numéro Part number	A (")	Joint d'étanchéité Bonded seal	B (")	O'ring	
				648FSM04X12	1/4	M12X1.5	710BSM12	648TT04X04	1/4	710BSB04	1/4	710TTO04	
648FSM04X14	1/4	M14X1.5	710BSM14	648TT04X06	1/4	710BSB04	3/8	710TTO06					
648FSM04X16	1/4	M16X1.5	710BSM16	648TT06X06	3/8	710BSB06	3/8	710TTO06					
648FSM06X12	3/8	M12X1.5	710BSM12	648TT06X08	3/8	710BSB06	1/2	710TTO08					
648FSM06X14	3/8	M14X1.5	710BSM14	648TT08X08	1/2	710BSB08	1/2	710TTO08					
648FSM06X16	3/8	M16X1.5	710BSM16	648TT08X10	1/2	710BSB08	5/8	710TTO10					
648FSM06X18	3/8	M18X1.5	710BSM18	648TT12X12	3/4	710BSB12	3/4	710TTO12					
648FSM08X16	1/2	M16X1.5	710BSM16	648TT20X20	1-1/4	710BSB20	1-1/4	710TTO20					
648FSM08X18	1/2	M18X1.5	710BSM18	648TT24X24	1-1/2	710BSB24	1-1/2	710TTO24					
648FSM08X22	1/2	M22X1.5	710BSM22										
648FSM10X26	5/8	M26X1.5	710BSM26										
648FSM12X30	3/4	M30X1.5	710BSM30										
648FSM16X38	1	M38X1.5	710BSM38										
									<b>646TT</b> <b>Mâle BSPP / Femelle o'ring face tournant</b> <b>Male BSPP / Female o'ring face swivel</b>				
									Numéro Part number	A (")	Joint d'étanchéité Bonded seal	B (")	
681FSM06X16	3/8	M16X1.5	710BSM16						646TT04X04	1/4	710BSB04	1/4	
681FSM06X18	3/8	M18X1.5	710BSM18	646TT04X06	1/4	710BSB04	3/8						
681FSM08X18	1/2	M18X1.5	710BSM18	646TT06X06	3/8	710BSB06	3/8						
681FSM12X26	3/4	M26X1.5	710BSM26	646TT06X08	3/8	710BSB06	1/2						
				646TT08X08	1/2	710BSB08	1/2						
				646TT08X10	1/2	710BSB08	5/8						
				646TT12X12	3/4	710BSB12	3/4						
				646TT16X16	1	710BSB16	1						
				646TT20X16	1-1/4	710BSB20	1						
				646TT20X20	1-1/4	710BSB20	1-1/4						

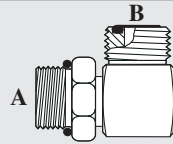

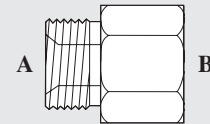

**649TT**
**Mâle BSPP ajustable / Mâle o'ring face**  
**Male BSPP adjustable / Male o'ring face**

Numéro Part number	A (")	Joint d'étanchéité Bonded seal	B (")
649TT02X04	1/8	710BSB02	1/4
649TT04X04	1/4	710BSB04	1/4
649TT04X06	1/4	710BSB04	3/8
649TT04X08	1/4	710BSB04	1/2
649TT06X06	3/8	710BSB06	3/8
649TT06X08	3/8	710BSB06	1/2
649TT08X06	1/2	710BSB08	3/8
649TT08X08	1/2	710BSB08	1/2
649TT08X10	1/2	710BSB08	5/8
649TT08X12	1/2	710BSB08	3/4
649TT12X12	3/4	710BSB12	3/4
649TT12X16	3/4	710BSB12	1
649TT16X12	1	710BSB16	3/4
649TT16X16	1	710BSB16	1
649TT20X16	1-1/4	710BSB20	1
649TT20X20	1-1/4	710BSB20	1-1/4
649TT24X24	1-1/2	710BSB24	1-1/2

**646FSO**
**Mâle BSPP / Femelle o'ring boss**  
**Male BSPP / Female o'ring boss**

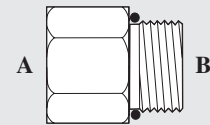
Numéro Part number	A (")	Joint d'étanchéité Bonded seal	B (")
646FSO02X04	1/8	710BSB02	1/4
646FSO04X04	1/4	710BSB04	1/4
646FSO04X06	1/4	710BSB04	3/8
646FSO06X06	3/8	710BSB06	3/8
646FSO06X08	3/8	710BSB06	1/2
646FSO08X08	1/2	710BSB08	1/2
646FSO08X10	1/2	710BSB08	5/8
646FSO12X12	3/4	710BSB12	3/4
646FSO16X16	1	710BSB16	1
646FSO20X20	1-1/4	710BSB20	1-1/4
646FSO20X24	1-1/4	710BSB20	1-1/2
646FSO24X24	1-1/2	710BSB24	1-1/2

**681FSO**
**Femelle BSPP fixe / Mâle o'ring boss**  
**Female BSPP solid / Male o'ring boss**

Numéro Part number	A (")	B (")	O'ring
681FSO02X04	1/8	1/4	710FSO04
681FSO04X04	1/4	1/4	710FSO04
681FSO04X06	1/4	3/8	710FSO06
681FSO06X06	3/8	3/8	710FSO06
681FSO08X08	1/2	1/2	710FSO08
681FSO20X12	1-1/4	3/4	710FSO12

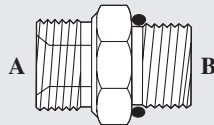
**648FSO**
**Mâle BSPP / Mâle o'ring boss**  
**Male BSPP / Male o'ring boss**

Numéro Part number	A (")	Joint d'étanchéité Bonded seal	B (")	O'ring
648FSO04X04	1/4	710BSB04	1/4	710FSO04
648FSO04X06	1/4	710BSB04	3/8	710FSO06
648FSO04X08	1/4	710BSB04	1/2	710FSO08
648FSO06X04	3/8	710BSB06	1/4	710FSO04
648FSO06X06	3/8	710BSB06	3/8	710FSO06
648FSO06X08	3/8	710BSB06	1/2	710FSO08
648FSO06X10	3/8	710BSB06	5/8	710FSO10
648FSO08X06	1/2	710BSB08	3/8	710FSO06
648FSO08X08	1/2	710BSB08	1/2	710FSO08
648FSO08X10	1/2	710BSB08	5/8	710FSO10
648FSO08X12	1/2	710BSB08	3/4	710FSO12
648FSO12X08	3/4	710BSB12	1/2	710FSO08
648FSO12X10	3/4	710BSB12	5/8	710FSO10
648FSO12X12	3/4	710BSB12	3/4	710FSO12
648FSO12X16	3/4	710BSB12	1	710FSO16
648FSO16X12	1	710BSB16	3/4	710FSO12
648FSO16X16	1	710BSB16	1	710FSO16
648FSO16X20	1	710BSB16	1-1/4	710FSO20
648FSO20X20	1-1/4	710BSB20	1-1/4	710FSO20

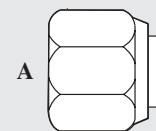
**MÉTRIQUE - METRIC**

**630FSM**
**Bouchon femelle métrique**  
**Metric female plug**

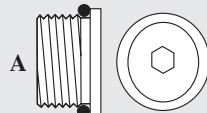
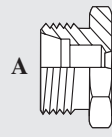
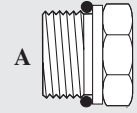
Numéro Part number	Tube (mm)	A (mm)
630FSM06X12	6	M12X1.5
630FSM06X14	6	M14X1.5
630FSM08X14	8	M14X1.5
630FSM08X16	8	M16X1.5
630FSM10X16	10	M16X1.5
630FSM10X18	10	M18X1.5
630FSM12X18	12	M18X1.5
630FSM12X20	12	M20X1.5

Numéro Part number	Tube (mm)	A (mm)																																																
630FSM14X22	14	M22X1.5	<b>639FSMR</b> <b>Bouchon mâle métrique (type Allen screw)</b> <b>Metric male plug (Allen screw type)</b>																																															
630FSM15X22	15	M22X1.5																																																
630FSM16X24	16	M24X1.5																																																
630FSM18X26	18	M26X1.5																																																
630FSM20X30	20	M30X2.0																																																
630FSM22X30	22	M30X2.0																																																
630FSM25X36	25	M36X2.0																																																
630FSM28X36	28	M36X2.0																																																
630FSM30X42	30	M42X2.0																																																
630FSM35X45	35	M45X2.0																																																
630FSM38X52	38	M52X2.0																																																
630FSM42X52	42	M52X2.0																																																
						<table border="1"> <thead> <tr> <th>Numéro Part number</th> <th colspan="2">A (mm)</th> </tr> </thead> <tbody> <tr> <td>639FSMR10</td> <td colspan="2">M10X1.0</td> </tr> <tr> <td>639FSMR12</td> <td colspan="2">M12X1.5</td> </tr> <tr> <td>639FSMR14</td> <td colspan="2">M14X1.5</td> </tr> <tr> <td>639FSMR16</td> <td colspan="2">M16X1.5</td> </tr> <tr> <td>639FSMR18</td> <td colspan="2">M18X1.5</td> </tr> <tr> <td>639FSMR20</td> <td colspan="2">M20X1.5</td> </tr> <tr> <td>639FSMR22</td> <td colspan="2">M22X1.5</td> </tr> <tr> <td>639FSMR26</td> <td colspan="2">M26X1.5</td> </tr> <tr> <td>639FSMR27</td> <td colspan="2">M27X2.0</td> </tr> <tr> <td>639FSMR30</td> <td colspan="2">M30X2.0</td> </tr> <tr> <td>639FSMR33</td> <td colspan="2">M33X2.0</td> </tr> <tr> <td>639FSMR36</td> <td colspan="2">M36X2.0</td> </tr> <tr> <td>639FSMR42</td> <td colspan="2">M42X2.0</td> </tr> </tbody> </table>			Numéro Part number	A (mm)		639FSMR10	M10X1.0		639FSMR12	M12X1.5		639FSMR14	M14X1.5		639FSMR16	M16X1.5		639FSMR18	M18X1.5		639FSMR20	M20X1.5		639FSMR22	M22X1.5		639FSMR26	M26X1.5		639FSMR27	M27X2.0		639FSMR30	M30X2.0		639FSMR33	M33X2.0		639FSMR36	M36X2.0		639FSMR42	M42X2.0	
Numéro Part number	A (mm)																																																	
639FSMR10	M10X1.0																																																	
639FSMR12	M12X1.5																																																	
639FSMR14	M14X1.5																																																	
639FSMR16	M16X1.5																																																	
639FSMR18	M18X1.5																																																	
639FSMR20	M20X1.5																																																	
639FSMR22	M22X1.5																																																	
639FSMR26	M26X1.5																																																	
639FSMR27	M27X2.0																																																	
639FSMR30	M30X2.0																																																	
639FSMR33	M33X2.0																																																	
639FSMR36	M36X2.0																																																	
639FSMR42	M42X2.0																																																	
Numéro Part number	Tube (mm)	A (mm)																																																
639FSM06X12	6	M12X1.5	<b>639FSMO</b> <b>Bouchon mâle o'ring boss métrique</b> <b>O'ring boss metric male plug</b>																																															
639FSM06X14	6	M14X1.5																																																
639FSM08X14	8	M14X1.5																																																
639FSM08X16	8	M16X1.5																																																
639FSM10X1.0	----	M10X1.0																																																
639FSM10X16	10	M16X1.5																																																
639FSM10X18	10	M18X1.5																																																
639FSM12X18	12	M18X1.5																																																
639FSM12X20	12	M20X1.5																																																
639FSM14X22	14	M22X1.5																																																
639FSM15X22	15	M22X1.5																																																
639FSM16X24	16	M24X1.5																																																
639FSM18X26	18	M26X1.5																																																
639FSM20X30	20	M30X2.0																																																
639FSM22X30	22	M30X2.0																																																
639FSM25X36	25	M36X2.0																																																
639FSM28X36	28	M36X2.0																																																
639FSM30X42	30	M42X2.0																																																
639FSM35X45	35	M45X2.0																																																
639FSM38X52	38	M52X2.0																																																
639FSM42X52	42	M52X2.0																																																
<table border="1"> <thead> <tr> <th>Numéro Part number</th> <th>A (mm)</th> <th>O'ring</th> </tr> </thead> <tbody> <tr> <td>639FSMO08</td> <td>M8X1.0</td> <td>710FSM08</td> </tr> <tr> <td>639FSMO10</td> <td>M10X1.0</td> <td>710FSM10</td> </tr> <tr> <td>639FSMO12</td> <td>M12X1.5</td> <td>710FSM12</td> </tr> <tr> <td>639FSMO14</td> <td>M14X1.5</td> <td>710FSM14</td> </tr> <tr> <td>639FSMO16</td> <td>M16X1.5</td> <td>710FSM16</td> </tr> <tr> <td>639FSMO18</td> <td>M18X1.5</td> <td>710FSM18</td> </tr> <tr> <td>639FSMO22</td> <td>M22X1.5</td> <td>710FSM22</td> </tr> <tr> <td>639FSMO27</td> <td>M27X2.0</td> <td>710FSM27</td> </tr> <tr> <td>639FSMO30</td> <td>M30X2.0</td> <td>710FSM30</td> </tr> <tr> <td>639FSMO33</td> <td>M33X2.0</td> <td>710FSM33</td> </tr> <tr> <td>639FSMO42</td> <td>M42X2.0</td> <td>710FSM42</td> </tr> <tr> <td>639FSMO48</td> <td>M48X2.0</td> <td>710FSM48</td> </tr> <tr> <td>639FSMO60</td> <td>M60X2.0</td> <td>710FSM60</td> </tr> </tbody> </table>						Numéro Part number	A (mm)	O'ring	639FSMO08	M8X1.0	710FSM08	639FSMO10	M10X1.0	710FSM10	639FSMO12	M12X1.5	710FSM12	639FSMO14	M14X1.5	710FSM14	639FSMO16	M16X1.5	710FSM16	639FSMO18	M18X1.5	710FSM18	639FSMO22	M22X1.5	710FSM22	639FSMO27	M27X2.0	710FSM27	639FSMO30	M30X2.0	710FSM30	639FSMO33	M33X2.0	710FSM33	639FSMO42	M42X2.0	710FSM42	639FSMO48	M48X2.0	710FSM48	639FSMO60	M60X2.0	710FSM60			
Numéro Part number	A (mm)	O'ring																																																
639FSMO08	M8X1.0	710FSM08																																																
639FSMO10	M10X1.0	710FSM10																																																
639FSMO12	M12X1.5	710FSM12																																																
639FSMO14	M14X1.5	710FSM14																																																
639FSMO16	M16X1.5	710FSM16																																																
639FSMO18	M18X1.5	710FSM18																																																
639FSMO22	M22X1.5	710FSM22																																																
639FSMO27	M27X2.0	710FSM27																																																
639FSMO30	M30X2.0	710FSM30																																																
639FSMO33	M33X2.0	710FSM33																																																
639FSMO42	M42X2.0	710FSM42																																																
639FSMO48	M48X2.0	710FSM48																																																
639FSMO60	M60X2.0	710FSM60																																																

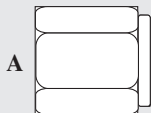
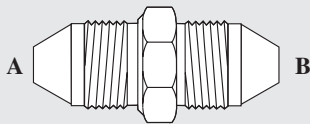
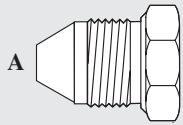
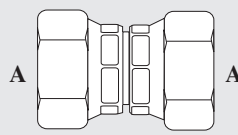
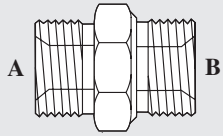
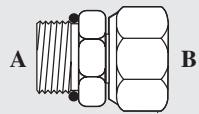
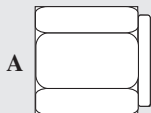
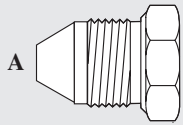
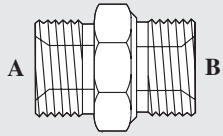
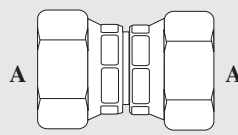
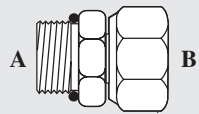
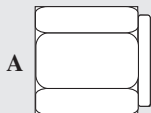
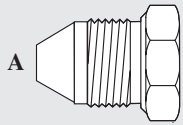
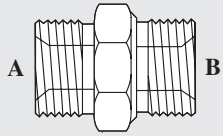
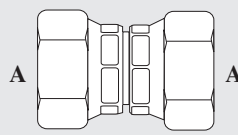
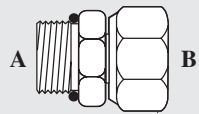
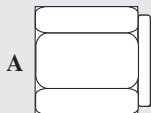
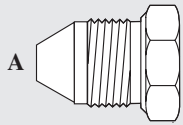
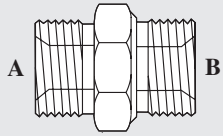
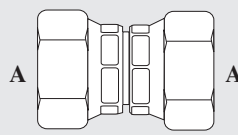
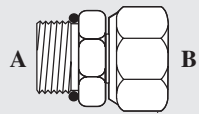
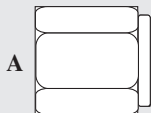
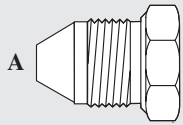
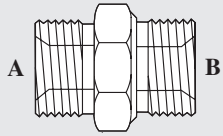
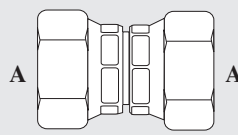
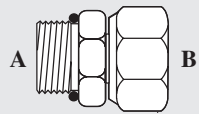

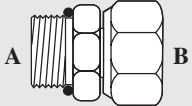
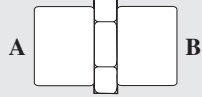
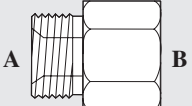
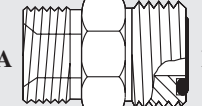
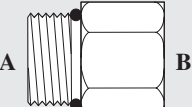
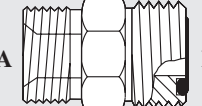
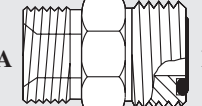
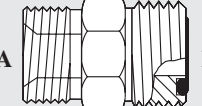
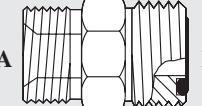
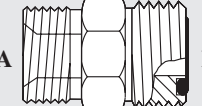
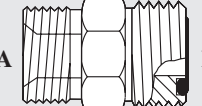
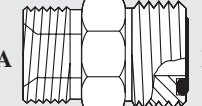
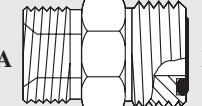
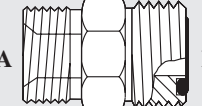
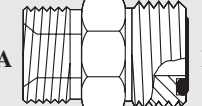
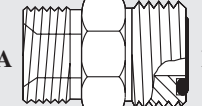
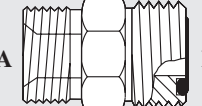
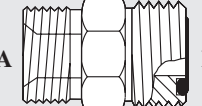
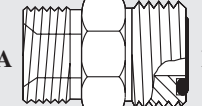
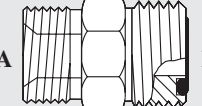
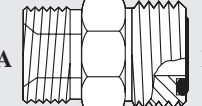
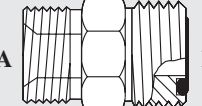
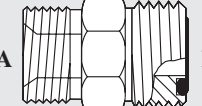
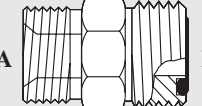
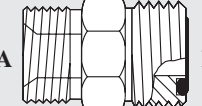
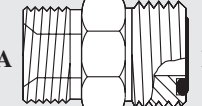
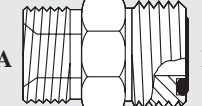
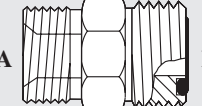
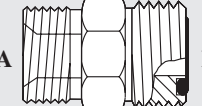
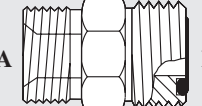
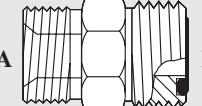
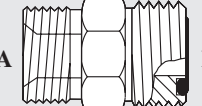
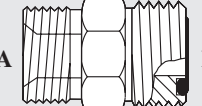
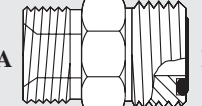
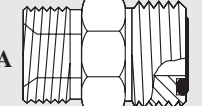
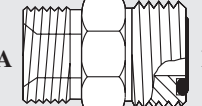
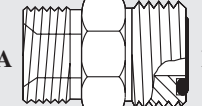
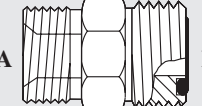
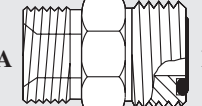
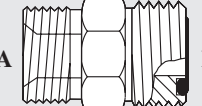
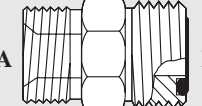
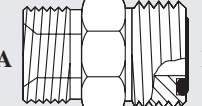

 <p><b>630FSK</b>  <b>Bouchon femelle Komatsu</b>  <b>Komatsu female plug</b></p>				Numéro Part number	A (mm)	B (mm)	Joint d'étanchéité Bonded seal
				642FSM24X24	M24X1.5	M24X1.5	710BSM24
				642FSM26X18	M26X1.5	M18X1.5	710BSM18
				642FSM26X22	M26X1.5	M22X1.5	710BSM22
				642FSM26X26	M26X1.5	M26X1.5	710BSM26
 <p><b>642FSK</b>  <b>Mâle Komatsu / Mâle Komatsu</b>  <b>Male Komatsu / Male Komatsu</b></p>				Numéro Part number	A (mm)	B (mm)	
 <p><b>639FSK</b>  <b>Bouchon mâle Komatsu</b>  <b>Komatsu male plug</b></p>				Numéro Part number	A (mm)		
 <p><b>680FSM</b>  <b>Femelle métrique tournant / Femelle métrique tournant</b>  <b>Female metric swivel / Female metric swivel</b></p>				Numéro Part number	A (mm)	Tube (mm)	
 <p><b>642FSM</b>  <b>Mâle métrique / Mâle métrique</b>  <b>Male metric / Male metric</b></p>				Numéro Part number	A (mm)	Tube (mm)	
 <p><b>683FSML</b>  <b>Mâle métrique / Femelle métrique tournant (légère)</b>  <b>Male metric / Female metric swivel (light)</b></p>				Numéro Part number	A (mm)	B (mm)	Tube (mm)
 <p><b>630FSK</b>  <b>Bouchon femelle Komatsu</b>  <b>Komatsu female plug</b></p>				Numéro Part number	A (mm)		
 <p><b>639FSK</b>  <b>Bouchon mâle Komatsu</b>  <b>Komatsu male plug</b></p>				Numéro Part number	A (mm)		
 <p><b>642FSM</b>  <b>Mâle métrique / Mâle métrique</b>  <b>Male metric / Male metric</b></p>				Numéro Part number	A (mm)	B (mm)	Joint d'étanchéité Bonded seal
642FSM10X10	M10X1.5	M10X1.5	710BSM10				
642FSM12X10	M12X1.5	M10X1.5	710BSM10				
642FSM12X12	M12X1.5	M12X1.5	710BSM12				
642FSM14X12	M14X1.5	M12X1.5	710BSM12				
642FSM14X14	M14X1.5	M14X1.5	710BSM14				
642FSM16X12	M16X1.5	M12X1.5	710BSM12				
642FSM16X14	M16X1.5	M14X1.5	710BSM14				
642FSM16X16	M16X1.5	M16X1.5	710BSM16				
642FSM18X16	M18X1.5	M16X1.5	710BSM16				
642FSM18X18	M18X1.5	M18X1.5	710BSM18				
642FSM20X18	M20X1.5	M18X1.5	710BSM18				
642FSM22X18	M22X1.5	M18X1.5	710BSM18				
642FSM22X22	M22X1.5	M22X1.5	710BSM22				
642FSM24X22	M24X1.5	M22X1.5	710BSM22				
 <p><b>680FSM</b>  <b>Femelle métrique tournant / Femelle métrique tournant</b>  <b>Female metric swivel / Female metric swivel</b></p>				Numéro Part number	A (mm)	Tube (mm)	
 <p><b>683FSML</b>  <b>Mâle métrique / Femelle métrique tournant (légère)</b>  <b>Male metric / Female metric swivel (light)</b></p>				Numéro Part number	A (mm)	B (mm)	Tube (mm)
 <p><b>630FSK</b>  <b>Bouchon femelle Komatsu</b>  <b>Komatsu female plug</b></p>				Numéro Part number	A (mm)		
 <p><b>639FSK</b>  <b>Bouchon mâle Komatsu</b>  <b>Komatsu male plug</b></p>				Numéro Part number	A (mm)		
 <p><b>642FSM</b>  <b>Mâle métrique / Mâle métrique</b>  <b>Male metric / Male metric</b></p>				Numéro Part number	A (mm)	Tube (mm)	
 <p><b>680FSM</b>  <b>Femelle métrique tournant / Femelle métrique tournant</b>  <b>Female metric swivel / Female metric swivel</b></p>				Numéro Part number	A (mm)	Tube (mm)	
 <p><b>683FSML</b>  <b>Mâle métrique / Femelle métrique tournant (légère)</b>  <b>Male metric / Female metric swivel (light)</b></p>				Numéro Part number	A (mm)	B (mm)	Tube (mm)
 <p><b>630FSK</b>  <b>Bouchon femelle Komatsu</b>  <b>Komatsu female plug</b></p>				Numéro Part number	A (mm)		
 <p><b>639FSK</b>  <b>Bouchon mâle Komatsu</b>  <b>Komatsu male plug</b></p>				Numéro Part number	A (mm)		
 <p><b>642FSM</b>  <b>Mâle métrique / Mâle métrique</b>  <b>Male metric / Male metric</b></p>				Numéro Part number	A (mm)	Tube (mm)	
 <p><b>680FSM</b>  <b>Femelle métrique tournant / Femelle métrique tournant</b>  <b>Female metric swivel / Female metric swivel</b></p>				Numéro Part number	A (mm)	Tube (mm)	
 <p><b>683FSML</b>  <b>Mâle métrique / Femelle métrique tournant (légère)</b>  <b>Male metric / Female metric swivel (light)</b></p>				Numéro Part number	A (mm)	B (mm)	Tube (mm)
 <p><b>630FSK</b>  <b>Bouchon femelle Komatsu</b>  <b>Komatsu female plug</b></p>				Numéro Part number	A (mm)		
 <p><b>639FSK</b>  <b>Bouchon mâle Komatsu</b>  <b>Komatsu male plug</b></p>				Numéro Part number	A (mm)		
 <p><b>642FSM</b>  <b>Mâle métrique / Mâle métrique</b>  <b>Male metric / Male metric</b></p>				Numéro Part number	A (mm)	Tube (mm)	
 <p><b>680FSM</b>  <b>Femelle métrique tournant / Femelle métrique tournant</b>  <b>Female metric swivel / Female metric swivel</b></p>				Numéro Part number	A (mm)	Tube (mm)	
 <p><b>683FSML</b>  <b>Mâle métrique / Femelle métrique tournant (légère)</b>  <b>Male metric / Female metric swivel (light)</b></p>				Numéro Part number	A (mm)	B (mm)	Tube (mm)

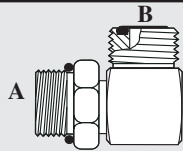
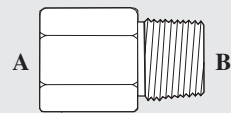
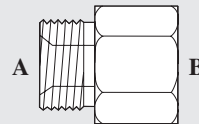
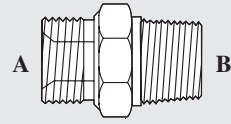
 <p><b>683FSMH</b>  <b>Mâle métrique / Femelle métrique tournant (lourde)</b>  <b>Male metric / Female metric swivel (heavy)</b></p>				Numéro Part number	A (mm)	Joint d'étanchéité Bonded seal	B (")	
				626FSO22X10	M22X1.5	710BSM22	5/8	
				626FSO26X12	M26X1.5	710BSM26	3/4	
				626FSO30X16	M30X2.0	710BSM30	1	
 <p><b>623FSO</b>  <b>Femelle métrique fixe / Femelle o'ring boss</b>  <b>Female metric solid / Female o'ring boss</b></p>				Numéro Part number	A (mm)	B (")		
 <p><b>683FSMS</b>  <b>Mâle métrique / Femelle métrique fixe</b>  <b>Male metric / Female metric solid</b></p>				623FSO20X08	M20X1.5	1/2		
 <p><b>618TT</b>  <b>Mâle métrique (légère) / Mâle o'ring face</b>  <b>Male metric (light) / Male o'ring face</b></p>				623FSO22X08	M22X1.5	1/2		
 <p><b>626FSO</b>  <b>Mâle métrique / Femelle o'ring boss</b>  <b>Male metric / Female o'ring boss</b></p>				623FSO24X08	M24X1.5	1/2		
 <p><b>618TT</b>  <b>Mâle métrique (légère) / Mâle o'ring face</b>  <b>Male metric (light) / Male o'ring face</b></p>				623FSO26X10	M26X1.5	5/8		
 <p><b>626FSO</b>  <b>Mâle métrique / Femelle o'ring boss</b>  <b>Male metric / Female o'ring boss</b></p>				623FSO30X12	M30X2.0	3/4		
 <p><b>618TT</b>  <b>Mâle métrique (légère) / Mâle o'ring face</b>  <b>Male metric (light) / Male o'ring face</b></p>				Numéro Part number	A (mm)	Tube mm	B (")	
 <p><b>618TT</b>  <b>Mâle métrique (légère) / Mâle o'ring face</b>  <b>Male metric (light) / Male o'ring face</b></p>				683FSMS08X06	M8X1.0	710BSM08	M6X1.0	1/4
 <p><b>618TT</b>  <b>Mâle métrique (légère) / Mâle o'ring face</b>  <b>Male metric (light) / Male o'ring face</b></p>				683FSMS10X08	M10X1.0	710BSM10	M8X1.0	1/4
 <p><b>618TT</b>  <b>Mâle métrique (légère) / Mâle o'ring face</b>  <b>Male metric (light) / Male o'ring face</b></p>				683FSMS14X10	M14X1.5	710BSM14	M10X1.0	3/8
 <p><b>618TT</b>  <b>Mâle métrique (légère) / Mâle o'ring face</b>  <b>Male metric (light) / Male o'ring face</b></p>				683FSMS16X12	M16X1.5	710BSM16	M12X1.5	3/8
 <p><b>618TT</b>  <b>Mâle métrique (légère) / Mâle o'ring face</b>  <b>Male metric (light) / Male o'ring face</b></p>				683FSMS18X14	M18X1.5	710BSM18	M14X1.5	3/8
 <p><b>618TT</b>  <b>Mâle métrique (légère) / Mâle o'ring face</b>  <b>Male metric (light) / Male o'ring face</b></p>				683FSMS20X16	M20X1.5	710BSM20	M16X1.5	1/2
 <p><b>618TT</b>  <b>Mâle métrique (légère) / Mâle o'ring face</b>  <b>Male metric (light) / Male o'ring face</b></p>				683FSMS22X18	M22X1.5	710BSM22	M18X1.5	1/2
 <p><b>618TT</b>  <b>Mâle métrique (légère) / Mâle o'ring face</b>  <b>Male metric (light) / Male o'ring face</b></p>				683FSMS24X20	M24X1.5	710BSM24	M20X1.5	3/4
 <p><b>618TT</b>  <b>Mâle métrique (légère) / Mâle o'ring face</b>  <b>Male metric (light) / Male o'ring face</b></p>				683FSMS26X22	M26X1.5	710BSM26	M22X1.5	3/4
 <p><b>618TT</b>  <b>Mâle métrique (légère) / Mâle o'ring face</b>  <b>Male metric (light) / Male o'ring face</b></p>				683FSMS30X26	M30X1.5	710BSM30	M26X1.5	3/4
 <p><b>618TT</b>  <b>Mâle métrique (légère) / Mâle o'ring face</b>  <b>Male metric (light) / Male o'ring face</b></p>				618TT12X04	M12X1.5	6	1/4	
 <p><b>618TT</b>  <b>Mâle métrique (légère) / Mâle o'ring face</b>  <b>Male metric (light) / Male o'ring face</b></p>				618TT14X04	M14X1.5	8	1/4	
 <p><b>618TT</b>  <b>Mâle métrique (légère) / Mâle o'ring face</b>  <b>Male metric (light) / Male o'ring face</b></p>				618TT14X06	M14X1.5	8	3/8	
 <p><b>618TT</b>  <b>Mâle métrique (légère) / Mâle o'ring face</b>  <b>Male metric (light) / Male o'ring face</b></p>				618TT16X08	M16X1.5	10	1/2	
 <p><b>618TT</b>  <b>Mâle métrique (légère) / Mâle o'ring face</b>  <b>Male metric (light) / Male o'ring face</b></p>				618TT18X06	M18X1.5	12	3/8	
 <p><b>618TT</b>  <b>Mâle métrique (légère) / Mâle o'ring face</b>  <b>Male metric (light) / Male o'ring face</b></p>				618TT18X08	M18X1.5	12	1/2	
 <p><b>618TT</b>  <b>Mâle métrique (légère) / Mâle o'ring face</b>  <b>Male metric (light) / Male o'ring face</b></p>				618TT18X12	M18X1.5	12	3/4	
 <p><b>618TT</b>  <b>Mâle métrique (légère) / Mâle o'ring face</b>  <b>Male metric (light) / Male o'ring face</b></p>				618TT22X08	M22X1.5	15	1/2	
 <p><b>618TT</b>  <b>Mâle métrique (légère) / Mâle o'ring face</b>  <b>Male metric (light) / Male o'ring face</b></p>				618TT22X12	M22X1.5	15	3/4	
 <p><b>618TT</b>  <b>Mâle métrique (légère) / Mâle o'ring face</b>  <b>Male metric (light) / Male o'ring face</b></p>				618TT26X12	M26X1.5	18	3/4	
 <p><b>618TT</b>  <b>Mâle métrique (légère) / Mâle o'ring face</b>  <b>Male metric (light) / Male o'ring face</b></p>				618TT27X12	M27X2.0	----	3/4	
 <p><b>618TT</b>  <b>Mâle métrique (légère) / Mâle o'ring face</b>  <b>Male metric (light) / Male o'ring face</b></p>				618TT30X12	M30X2.0	22	3/4	
 <p><b>618TT</b>  <b>Mâle métrique (légère) / Mâle o'ring face</b>  <b>Male metric (light) / Male o'ring face</b></p>				618TT30X16	M30X2.0	22	1	
 <p><b>618TT</b>  <b>Mâle métrique (légère) / Mâle o'ring face</b>  <b>Male metric (light) / Male o'ring face</b></p>				Numéro Part number	A (mm)	Joint d'étanchéité Bonded seal	B (")	
 <p><b>618TT</b>  <b>Mâle métrique (légère) / Mâle o'ring face</b>  <b>Male metric (light) / Male o'ring face</b></p>				626FSO08X04	M8X1.0	710BSM08	1/4	
 <p><b>618TT</b>  <b>Mâle métrique (légère) / Mâle o'ring face</b>  <b>Male metric (light) / Male o'ring face</b></p>				626FSO10X04	M10X1.0	710BSM10	1/4	
 <p><b>618TT</b>  <b>Mâle métrique (légère) / Mâle o'ring face</b>  <b>Male metric (light) / Male o'ring face</b></p>				626FSO12X04	M12X1.0	710BSM12	1/4	
 <p><b>618TT</b>  <b>Mâle métrique (légère) / Mâle o'ring face</b>  <b>Male metric (light) / Male o'ring face</b></p>				626FSO12X06	M12X1.0	710BSM12	3/8	
 <p><b>618TT</b>  <b>Mâle métrique (légère) / Mâle o'ring face</b>  <b>Male metric (light) / Male o'ring face</b></p>				626FSO14X06	M14X1.5	710BSM14	3/8	
 <p><b>618TT</b>  <b>Mâle métrique (légère) / Mâle o'ring face</b>  <b>Male metric (light) / Male o'ring face</b></p>				626FSO16X06	M16X1.5	710BSM16	3/8	
 <p><b>618TT</b>  <b>Mâle métrique (légère) / Mâle o'ring face</b>  <b>Male metric (light) / Male o'ring face</b></p>				626FSO16X08	M16X1.5	710BSM16	1/2	
 <p><b>618TT</b>  <b>Mâle métrique (légère) / Mâle o'ring face</b>  <b>Male metric (light) / Male o'ring face</b></p>				626FSO18X08	M18X1.5	710BSM18	1/2	
 <p><b>618TT</b>  <b>Mâle métrique (légère) / Mâle o'ring face</b>  <b>Male metric (light) / Male o'ring face</b></p>				626FSO20X08	M20X1.5	710BSM20	1/2	
 <p><b>618TT</b>  <b>Mâle métrique (légère) / Mâle o'ring face</b>  <b>Male metric (light) / Male o'ring face</b></p>				626FSO22X06	M22X1.5	710BSM22	3/8	

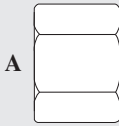
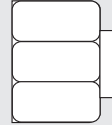
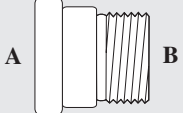
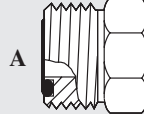
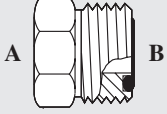
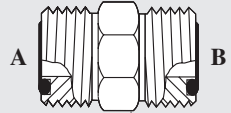
															
<b>619TT</b> <b>Mâle métrique ajustable / Mâle o'ring face</b> <b>Male metric adjustable / Male o'ring face</b>				<b>622FS</b> <b>Femelle métrique fixe / Mâle NPTF</b> <b>Female metric solid / Male NPTF</b>											
Numéro Part number	A (mm)	Joint d'étanchéité Bonded seal	B (")	Numéro Part number	A (mm)	B (")									
619TT10X04	M10X1.0	710BSM10	1/4	622FS06X02	M6X1.0	1/8									
619TT12X04	M12X1.5	710BSM12	1/4	622FS08X02	M8X1.0	1/8									
619TT14X06	M14X1.5	710BSM14	3/8	622FS1010X02	M10X1.0	1/8									
619TT16X06	M16X1.5	710BSM16	3/8	622FS1012X02	M10X1.25	1/8									
619TT16X08	M16X1.5	710BSM16	1/2	622FS1015X02	M10X1.5	1/8									
619TT18X08	M18X1.5	710BSM18	1/2	622FS1210X02	M12X1.0	1/8									
619TT18X10	M18X1.5	710BSM18	5/8	622FS1215X02	M12X1.5	1/8									
619TT22X10	M22X1.5	710BSM22	5/8	622FS14X06	M14X1.5	3/8									
619TT27X12	M27X2.0	710SBM27	3/4	622FS14X08	M14X1.5	1/2									
619TT33X16	M33X2.0	710BSM33	1	622FS16X04	M16X1.5	1/4									
															
								<b>626FS</b> <b>Mâle métrique / Femelle NPTF</b> <b>Male metric / Female NPTF</b>				<b>628FS</b> <b>Mâle métrique / Mâle NPTF</b> <b>Male metric / Male NPTF</b>			
								Numéro Part number	A (mm)	Joint d'étanchéité Bonded seal	B (")	Numéro Part number	A (mm)	Bonded seal	B (")
								626FS08X02	M8X1.0	710BSM08	1/8	628FS12X02	M12X1.5	710BSM12	1/8
								626FS10X02	M10X1.0	710BSM10	1/8	628FS16X06	M16X1.5	710BSM16	3/8
								626FS12X04	M12X1.5	710BSM12	1/4	628FS18X06	M18X1.5	710BSM18	3/8
								626FS14X04	M14X1.5	710BSM14	1/4	628FS20X08	M20X1.5	710BSM20	1/2
								626FS16X06	M16X1.5	710BSM16	3/8	628FS22X08	M22X1.5	710BSM22	1/2
								626FS16X08	M16X1.5	710BSM16	1/2	628FS26X08	M26X1.5	710BSM26	1/2
								626FS18X06	M18X1.5	710BSM18	3/8	628FS26X12	M26X1.5	710BSM26	3/4
								626FS18X08	M18X1.5	710BSM18	1/2	628FS30X12	M30X2.0	710BSM30	3/4
								626FS22X06	M22X1.5	710BSM22	3/8	628FS30X16	M30X2.0	710BSM30	1
								626FS22X08	M22X1.5	710BSM22	1/2				
								626FS22X12	M22X1.5	710BSM22	3/4				
626FS24X12	M24X1.5	710BSM24	3/4												
626FS26X12	M26X1.5	710BSM26	3/4												
626FS27X12	M27X2.0	710BSM27	3/4												

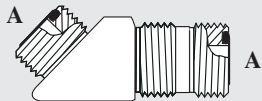
<b>ORFS (O'RING FACE)</b>					Numéro Part number	A (")	B (")	O'ring	
					883TTR16X20	1	1-1/4	710TTO20	
					883TTR16X24	1	1-1/2	710TTO24	
					883TTR20X24	1-1/4	1-1/2	710TTO24	
									
<b>841TT</b> Écrou o'ring face O'ring face nut					<b>830TT</b> Bouchon femelle o'ring face O'ring face female plug				
Numéro Part number	A (")				Numéro Part number	A (")			
841TT06	3/8				830TT04	1/4			
841TT08	1/2				830TT06	3/8			
841TT10	5/8				830TT08	1/2			
841TT12	3/4				830TT10	5/8			
841TT16	1				830TT12	3/4			
830TT16	1				830TT16	1			
830TT20	1-1/4				830TT20	1-1/4			
830TT24	1-1/2				830TT24	1-1/2			
									
<b>883TT</b> Femelle o'ring face tournant / Mâle o'ring face Female o'ring face swivel / Male o'ring face					<b>839TT</b> Bouchon mâle o'ring face Male o'ring face plug				
Numéro Part number	A (")	Écrou Nut	B (")	O'ring	Numéro Part number	A (")			
883TT08X04	1/2	841TT08	1/4	710TTO04	839TT04	1/4			
883TT08X06	1/2	841TT08	3/8	710TTO06	839TT06	3/8			
883TT10X04	5/8	841TT10	1/4	710TTO04	839TT08	1/2			
883TT10X06	5/8	841TT10	3/8	710TTO06	839TT10	5/8			
883TT10X08	5/8	841TT10	1/2	710TTO08	839TT12	3/4			
883TT12X08	3/4	841TT12	1/2	710TTO08	839TT16	1			
883TT16X08	1	841TT16	1/2	710TTO08	839TT20	1-1/4			
883TT16X10	1	841TT16	5/8	710TTO10	839TT24	1-1/2			
883TT20X16	1-1/4	841TT20	1	710TTO16					
									
<b>883TTR</b> Femelle o'ring face fixe/ Mâle o'ring face Female o'ring face solid / Male o'ring face					<b>842TT</b> Mâle o'ring face / Mâle o'ring face Male o'ring face / Male o'ring face				
Numéro Part number	A (")	B (")	O'ring		Numéro Part number	A (")	O'ring	B (")	O'ring
883TTR04X06	1/4	3/8	710TTO06		842TT04X04	1/4	710TTO04	1/4	710TTO04
883TTR06X08	3/8	1/2	710TTO08		842TT06X04	3/8	710TTO06	1/4	710TTO04
883TTR06X10	3/8	5/8	710TTO10		842TT06X06	3/8	710TTO06	3/8	710TTO06
883TTR08X10	1/2	5/8	710TTO10		842TT08X06	1/2	710TTO08	3/8	710TTO06
883TTR08X12	1/2	3/4	710TTO12		842TT08X08	1/2	710TTO08	1/2	710TTO08
883TTR08X16	1/2	1	710TTO16						
883TTR10X12	5/8	3/4	710TTO12						
883TTR10X16	5/8	1	710TTO16						
883TTR12X16	3/4	1	710TTO16						
883TTR12X20	3/4	1-1/4	710TTO20						

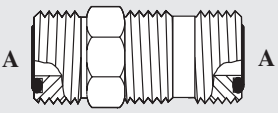
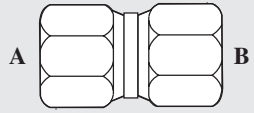
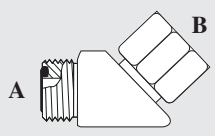
Numéro Part number	A (")	O'ring	B (")	O'ring	Numéro Part number	A (")	O'ring	B (")																																																												
842TT10X08	5/8	710TTO10	1/2	710TTO08	889TT08X08	1/2	710TTO08	1/2																																																												
842TT10X10	5/8	710TTO10	5/8	710TTO10	889TT10X10	5/8	710TTO10	5/8																																																												
842TT12X08	3/4	710TTO12	1/2	710TTO08	889TT12X12	3/4	710TTO12	3/4																																																												
842TT12X10	3/4	710TTO12	5/8	710TTO10	889TT16X16	1	710TTO16	1																																																												
842TT12X12	3/4	710TTO12	3/4	710TTO12	889TT20X20	1-1/4	710TTO20	1-1/4																																																												
842TT16X12	1	710TTO16	3/4	710TTO12																																																																
842TT16X16	1	710TTO16	1	710TTO16																																																																
842TT20X20	1-1/4	710TTO20	1-1/4	710TTO20																																																																
842TT24X24	1-1/2	710TTO24	1-1/2	710TTO24																																																																
					<b>854BHTT</b> <b>Mâle o'ring face / Mâle o'ring face cloison</b> <b>Male o'ring face / Male o'ring face bulkhead</b>																																																															
					Numéro Part number	A (")	O'ring	Écrou Nut																																																												
<b>832TT</b> <b>Mâle o'ring face / Mâle o'ring face cloison</b> <b>Male o'ring face / Male o'ring face bulkhead</b>					854BHTT04	1/4	710TTO04	711TTO04																																																												
					854BHTT06	3/8	710TTO06	711TTO06																																																												
<table border="1"> <thead> <tr> <th>Numéro Part number</th> <th>A (")</th> <th>O'ring</th> <th>Écrou Nut</th> </tr> </thead> <tbody> <tr> <td>832TT04</td> <td>1/4</td> <td>710TTO04</td> <td>711TTO04</td> </tr> <tr> <td>832TT06</td> <td>3/8</td> <td>710TTO06</td> <td>711TTO06</td> </tr> <tr> <td>832TT08</td> <td>1/2</td> <td>710TTO08</td> <td>711TTO08</td> </tr> <tr> <td>832TT10</td> <td>5/8</td> <td>710TTO10</td> <td>711TTO10</td> </tr> <tr> <td>832TT12</td> <td>3/4</td> <td>710TTO12</td> <td>711TTO12</td> </tr> <tr> <td>832TT16</td> <td>1</td> <td>710TTO16</td> <td>711TTO16</td> </tr> <tr> <td>832TT20</td> <td>1-1/4</td> <td>710TTO20</td> <td>711TTO20</td> </tr> <tr> <td>832TT24</td> <td>1-1/2</td> <td>710TTO24</td> <td>711TTO24</td> </tr> </tbody> </table>					Numéro Part number	A (")	O'ring	Écrou Nut	832TT04	1/4	710TTO04	711TTO04	832TT06	3/8	710TTO06	711TTO06	832TT08	1/2	710TTO08	711TTO08	832TT10	5/8	710TTO10	711TTO10	832TT12	3/4	710TTO12	711TTO12	832TT16	1	710TTO16	711TTO16	832TT20	1-1/4	710TTO20	711TTO20	832TT24	1-1/2	710TTO24	711TTO24	854BHTT08	1/2	710TTO08	711TTO08																								
					Numéro Part number	A (")	O'ring	Écrou Nut																																																												
832TT04	1/4	710TTO04	711TTO04																																																																	
832TT06	3/8	710TTO06	711TTO06																																																																	
832TT08	1/2	710TTO08	711TTO08																																																																	
832TT10	5/8	710TTO10	711TTO10																																																																	
832TT12	3/4	710TTO12	711TTO12																																																																	
832TT16	1	710TTO16	711TTO16																																																																	
832TT20	1-1/4	710TTO20	711TTO20																																																																	
832TT24	1-1/2	710TTO24	711TTO24																																																																	
					854BHTT10	5/8	710TTO10	711TTO10																																																												
					854BHTT12	3/4	710TTO12	711TTO12																																																												
<b>855TT</b> <b>Mâle o'ring face / Mâle o'ring face</b> <b>Male o'ring face / Male o'ring face</b>					854BHTT16	1	710TTO16	711TTO16																																																												
					854BHTT20	1-1/4	710TTO20	711TTO20																																																												
<table border="1"> <thead> <tr> <th>Numéro Part number</th> <th>A (")</th> <th>O'ring</th> <th>B (")</th> <th>O'ring</th> </tr> </thead> <tbody> <tr> <td>855TT04X04</td> <td>1/4</td> <td>710TTO04</td> <td>1/4</td> <td>710TTO04</td> </tr> <tr> <td>855TT06X04</td> <td>3/8</td> <td>710TTO06</td> <td>1/4</td> <td>710TTO04</td> </tr> <tr> <td>855TT06X06</td> <td>3/8</td> <td>710TTO06</td> <td>3/8</td> <td>710TTO06</td> </tr> <tr> <td>855TT08X04</td> <td>1/2</td> <td>710TTO08</td> <td>1/4</td> <td>710TTO04</td> </tr> <tr> <td>855TT08X06</td> <td>1/2</td> <td>710TTO08</td> <td>3/8</td> <td>710TTO06</td> </tr> <tr> <td>855TT08X08</td> <td>1/2</td> <td>710TTO08</td> <td>1/2</td> <td>710TTO08</td> </tr> <tr> <td>855TT10X10</td> <td>5/8</td> <td>710TTO10</td> <td>5/8</td> <td>710TTO10</td> </tr> <tr> <td>855TT12X12</td> <td>3/4</td> <td>710TTO12</td> <td>3/4</td> <td>710TTO12</td> </tr> <tr> <td>855TT16X16</td> <td>1</td> <td>710TTO16</td> <td>1</td> <td>710TTO16</td> </tr> <tr> <td>855TT20X20</td> <td>1-1/4</td> <td>710TTO20</td> <td>1-1/4</td> <td>710TTO20</td> </tr> <tr> <td>855TT24X24</td> <td>1-1/2</td> <td>710TTO24</td> <td>1-1/2</td> <td>710TTO24</td> </tr> </tbody> </table>					Numéro Part number	A (")	O'ring	B (")	O'ring	855TT04X04	1/4	710TTO04	1/4	710TTO04	855TT06X04	3/8	710TTO06	1/4	710TTO04	855TT06X06	3/8	710TTO06	3/8	710TTO06	855TT08X04	1/2	710TTO08	1/4	710TTO04	855TT08X06	1/2	710TTO08	3/8	710TTO06	855TT08X08	1/2	710TTO08	1/2	710TTO08	855TT10X10	5/8	710TTO10	5/8	710TTO10	855TT12X12	3/4	710TTO12	3/4	710TTO12	855TT16X16	1	710TTO16	1	710TTO16	855TT20X20	1-1/4	710TTO20	1-1/4	710TTO20	855TT24X24	1-1/2	710TTO24	1-1/2	710TTO24	854BHTT24	1-1/2	710TTO24	711TTO24
					Numéro Part number	A (")	O'ring	B (")	O'ring																																																											
855TT04X04	1/4	710TTO04	1/4	710TTO04																																																																
855TT06X04	3/8	710TTO06	1/4	710TTO04																																																																
855TT06X06	3/8	710TTO06	3/8	710TTO06																																																																
855TT08X04	1/2	710TTO08	1/4	710TTO04																																																																
855TT08X06	1/2	710TTO08	3/8	710TTO06																																																																
855TT08X08	1/2	710TTO08	1/2	710TTO08																																																																
855TT10X10	5/8	710TTO10	5/8	710TTO10																																																																
855TT12X12	3/4	710TTO12	3/4	710TTO12																																																																
855TT16X16	1	710TTO16	1	710TTO16																																																																
855TT20X20	1-1/4	710TTO20	1-1/4	710TTO20																																																																
855TT24X24	1-1/2	710TTO24	1-1/2	710TTO24																																																																
					<b>889TT</b> <b>Mâle o'ring face / Femelle o'ring face tournant</b> <b>Male o'ring face / Female o'ring face swivel</b>																																																															
					Numéro Part number	A (")	O'ring	B (")																																																												
<table border="1"> <thead> <tr> <th>Numéro Part number</th> <th>A (")</th> <th>O'ring</th> <th>B (")</th> </tr> </thead> <tbody> <tr> <td>880TT04X04</td> <td>1/4</td> <td></td> <td>1/4</td> </tr> <tr> <td>880TT06X06</td> <td>3/8</td> <td></td> <td>3/8</td> </tr> <tr> <td>880TT08X08</td> <td>1/2</td> <td></td> <td>1/2</td> </tr> <tr> <td>880TT12X12</td> <td>3/4</td> <td></td> <td>3/4</td> </tr> <tr> <td>880TT16X16</td> <td>1</td> <td></td> <td>1</td> </tr> </tbody> </table>					Numéro Part number	A (")	O'ring	B (")	880TT04X04	1/4		1/4	880TT06X06	3/8		3/8	880TT08X08	1/2		1/2	880TT12X12	3/4		3/4	880TT16X16	1		1	889TT04X04	1/4	710TTO04	1/4																																				
					Numéro Part number	A (")	O'ring	B (")																																																												
880TT04X04	1/4		1/4																																																																	
880TT06X06	3/8		3/8																																																																	
880TT08X08	1/2		1/2																																																																	
880TT12X12	3/4		3/4																																																																	
880TT16X16	1		1																																																																	
<table border="1"> <thead> <tr> <th>Numéro Part number</th> <th>A (")</th> <th>O'ring</th> <th>B (")</th> </tr> </thead> <tbody> <tr> <td>889TT04X04</td> <td>1/4</td> <td>710TTO04</td> <td>1/4</td> </tr> <tr> <td>889TT06X06</td> <td>3/8</td> <td>710TTO06</td> <td>3/8</td> </tr> </tbody> </table>					Numéro Part number	A (")	O'ring	B (")	889TT04X04	1/4	710TTO04	1/4	889TT06X06	3/8	710TTO06	3/8	889TT06X06	3/8	710TTO06	3/8																																																
					Numéro Part number	A (")	O'ring	B (")																																																												
889TT04X04	1/4	710TTO04	1/4																																																																	
889TT06X06	3/8	710TTO06	3/8																																																																	

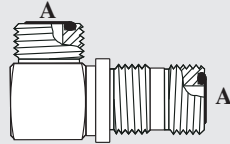
**855BH TT**

 Mâle o'ring face / Mâle o'ring face cloison  
 Male o'ring face / Male o'ring face bulkhead

Numéro Part number	A (")	O'ring	Écrou Nut
855BH TT04	1/4	710TTO04	711TTO04
855BH TT06	3/8	710TTO06	711TTO06
855BH TT08	1/2	710TTO08	711TTO08
855BH TT10	5/8	710TTO10	711TTO10
855BH TT12	3/4	710TTO12	711TTO12
855BH TT16	1	710TTO16	711TTO16
855BH TT20	1-1/4	710TTO20	711TTO20
855BH TT24	1-1/2	710TTO24	711TTO24

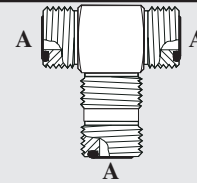
**870TT**

 Mâle o'ring face / Mâle o'ring face cloison / Mâle o'ring face  
 Male o'ring face / Male o'ring face bulkhead / Male o'ring face

Numéro Part number	A (")	O'ring	Écrou Nut
870TT04	1/4	710TTO04	711TTO04
870TT06	3/8	710TTO06	711TTO06
870TT08	1/2	710TTO08	711TTO08
870TT10	5/8	710TTO10	711TTO10
870TT12	3/4	710TTO12	711TTO12
870TT16	1	710TTO16	711TTO16
870TT20	1-1/4	710TTO20	711TTO20

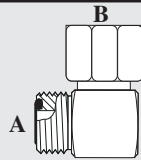
**879TT**

 Mâle o'ring face / Femelle o'ring face tournant  
 Male o'ring face / Female o'ring face swivel

Numéro Part number	A (")	O'ring	B (")
879TT04X04	1/4	710TTO04	1/4
879TT06X06	3/8	710TTO06	3/8
879TT08X08	1/2	710TTO08	1/2
879TT10X10	5/8	710TTO10	5/8
879TT12X12	3/4	710TTO12	3/4
879TT16X16	1	710TTO16	1
879TT20X20	1-1/4	710TTO20	1-1/4
879TT24X24	1-1/2	710TTO24	1-1/2

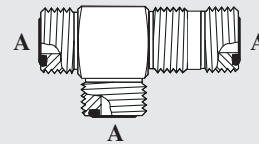
**861TT**

 Mâle o'ring face / Mâle o'ring face / Mâle o'ring face cloison  
 Male o'ring face / Male o'ring face / Male o'ring face bulkhead

Numéro Part number	A (")	O'ring	Écrou Nut
861TT04	1/4	710TTO04	711TTO04
861TT06	3/8	710TTO06	711TTO06
861TT08	1/2	710TTO08	711TTO08
861TT10	5/8	710TTO10	711TTO10
861TT12	3/4	710TTO12	711TTO12
861TT16	1	710TTO16	711TTO16
861TT20	1-1/4	710TTO20	711TTO20

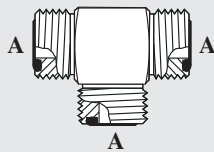
**844TT**

 Mâle o'ring face / Mâle o'ring face / Mâle o'ring face  
 Male o'ring face / Male o'ring face / Male o'ring face

Numéro Part number	A (")	O'ring
844TT04	1/4	710TTO04
844TT06	3/8	710TTO06
844TT08	1/2	710TTO08
844TT10	5/8	710TTO10
844TT12	3/4	710TTO12
844TT16	1	710TTO16
844TT20	1-1/4	710TTO20
844TT24	1-1/2	710TTO24

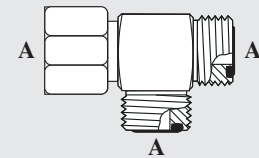

**871TT**

 Femelle o'ring face tournant/Mâle o'ring face/Mâle o'ring face  
 Female o'ring face swivel / Male o'ring face / Male o'ring face

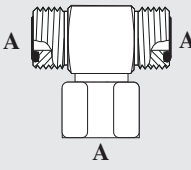
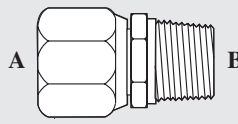
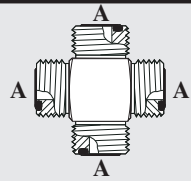
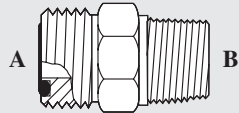
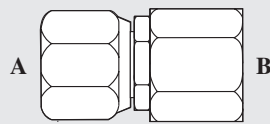
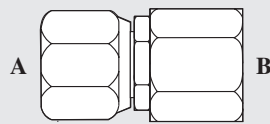
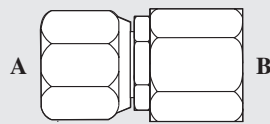
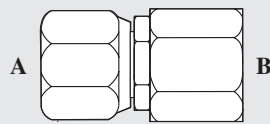
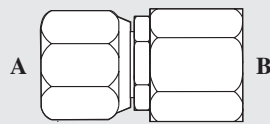
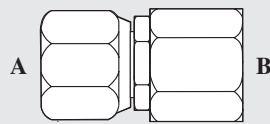
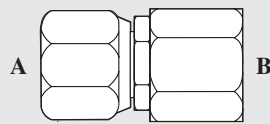
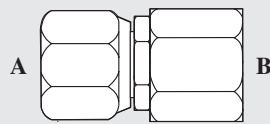
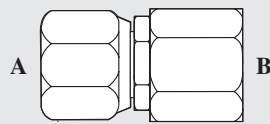
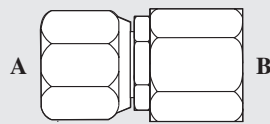
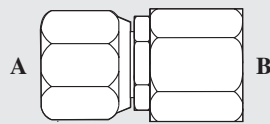
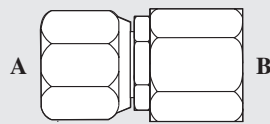
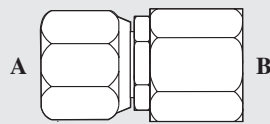
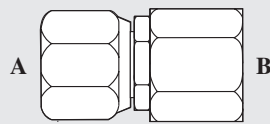
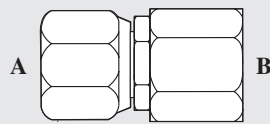
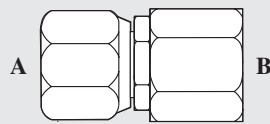
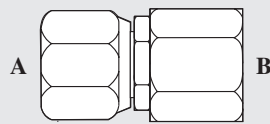
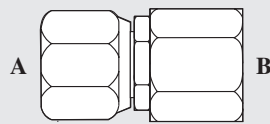
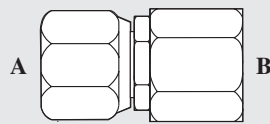
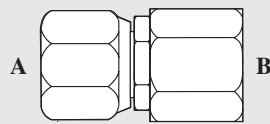
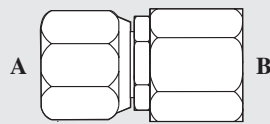
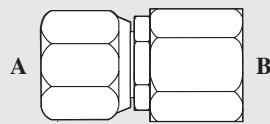
Numéro Part number	A (")	O'ring
871TT04	1/4	710TTO04
871TT06	3/8	710TTO06
871TT08	1/2	710TTO08
871TT10	5/8	710TTO10
871TT12	3/4	710TTO12
871TT16	1	710TTO16

 <p><b>872TT</b>            Mâle o'ring face/Femelle o'ring face tournant/Mâle o'ring face            Male o'ring face / Female o'ring face swivel / Male o'ring face</p>				Numéro Part number	A (")	O'ring	B (")
				848TT12X16	3/4	710TTO12	1
 <p><b>881TT</b>            Femelle o'ring face tournant / Mâle NPTF            Female o'ring face swivel / Male NPTF</p>				Numéro Part number	A (")	B (")	
				848TT16X12	1	710TTO16	3/4
 <p><b>852TT</b>            Croix mâle o'ring face            Cross male o'ring face</p>				Numéro Part number	A (")	O'ring	
				848TT16X16	1	710TTO16	1
 <p><b>848TT</b>            Mâle o'ring face / Mâle NPTF            Male o'ring face / Male NPTF</p>				Numéro Part number	A (")	O'ring	
				848TT20X16	1-1/4	710TTO20	1
 <p><b>882TT</b>            Femelle o'ring face tournant / Mâle NPTF            Female o'ring face swivel / Male NPTF</p>				Numéro Part number	A (")	B (")	
				848TT20X20	1-1/4	710TTO20	1-1/4
 <p><b>882TT</b>            Femelle o'ring face tournant / Mâle NPTF            Female o'ring face swivel / Male NPTF</p>				Numéro Part number	A (")	B (")	
				848TT24X24	1-1/2	710TTO24	1-1/2
 <p><b>882TT</b>            Femelle o'ring face tournant / Mâle NPTF            Female o'ring face swivel / Male NPTF</p>				Numéro Part number	A (")	B (")	
				852TT04	1/4	710TTO04	1/8
 <p><b>882TT</b>            Femelle o'ring face tournant / Mâle NPTF            Female o'ring face swivel / Male NPTF</p>				Numéro Part number	A (")	B (")	
				852TT06	3/8	710TTO06	1/4
 <p><b>882TT</b>            Femelle o'ring face tournant / Mâle NPTF            Female o'ring face swivel / Male NPTF</p>				Numéro Part number	A (")	B (")	
				852TT08	1/2	710TTO08	1/4
 <p><b>882TT</b>            Femelle o'ring face tournant / Mâle NPTF            Female o'ring face swivel / Male NPTF</p>				Numéro Part number	A (")	B (")	
				852TT10	5/8	710TTO10	3/8
 <p><b>882TT</b>            Femelle o'ring face tournant / Mâle NPTF            Female o'ring face swivel / Male NPTF</p>				Numéro Part number	A (")	B (")	
				852TT12	3/4	710TTO12	1/2
 <p><b>882TT</b>            Femelle o'ring face tournant / Mâle NPTF            Female o'ring face swivel / Male NPTF</p>				Numéro Part number	A (")	B (")	
				852TT16	1	710TTO16	1-1/4
 <p><b>882TT</b>            Femelle o'ring face tournant / Mâle NPTF            Female o'ring face swivel / Male NPTF</p>				Numéro Part number	A (")	B (")	
				848TT04X02	1/4	710TTO04	1/8
 <p><b>882TT</b>            Femelle o'ring face tournant / Mâle NPTF            Female o'ring face swivel / Male NPTF</p>				Numéro Part number	A (")	B (")	
				848TT04X04	1/4	710TTO04	1/4
 <p><b>882TT</b>            Femelle o'ring face tournant / Mâle NPTF            Female o'ring face swivel / Male NPTF</p>				Numéro Part number	A (")	B (")	
				848TT04X06	1/4	710TTO04	3/8
 <p><b>882TT</b>            Femelle o'ring face tournant / Mâle NPTF            Female o'ring face swivel / Male NPTF</p>				Numéro Part number	A (")	B (")	
				848TT04X08	1/4	710TTO04	1/2
 <p><b>882TT</b>            Femelle o'ring face tournant / Mâle NPTF            Female o'ring face swivel / Male NPTF</p>				Numéro Part number	A (")	B (")	
				848TT06X04	3/8	710TTO06	1/4
 <p><b>882TT</b>            Femelle o'ring face tournant / Mâle NPTF            Female o'ring face swivel / Male NPTF</p>				Numéro Part number	A (")	B (")	
				848TT06X06	3/8	710TTO06	3/8
 <p><b>882TT</b>            Femelle o'ring face tournant / Mâle NPTF            Female o'ring face swivel / Male NPTF</p>				Numéro Part number	A (")	B (")	
				848TT06X08	3/8	710TTO06	1/2
 <p><b>882TT</b>            Femelle o'ring face tournant / Mâle NPTF            Female o'ring face swivel / Male NPTF</p>				Numéro Part number	A (")	B (")	
				848TT08X04	1/2	710TTO08	1/4
 <p><b>882TT</b>            Femelle o'ring face tournant / Mâle NPTF            Female o'ring face swivel / Male NPTF</p>				Numéro Part number	A (")	B (")	
				848TT08X06	1/2	710TTO08	3/8
 <p><b>882TT</b>            Femelle o'ring face tournant / Mâle NPTF            Female o'ring face swivel / Male NPTF</p>				Numéro Part number	A (")	B (")	
				848TT08X08	1/2	710TTO08	1/2
 <p><b>882TT</b>            Femelle o'ring face tournant / Mâle NPTF            Female o'ring face swivel / Male NPTF</p>				Numéro Part number	A (")	B (")	
				848TT10X08	5/8	710TTO10	1/2
 <p><b>882TT</b>            Femelle o'ring face tournant / Mâle NPTF            Female o'ring face swivel / Male NPTF</p>				Numéro Part number	A (")	B (")	
				848TT10X12	5/8	710TTO10	3/4
 <p><b>882TT</b>            Femelle o'ring face tournant / Mâle NPTF            Female o'ring face swivel / Male NPTF</p>				Numéro Part number	A (")	B (")	
				848TT12X08	3/4	710TTO12	1/2
 <p><b>882TT</b>            Femelle o'ring face tournant / Mâle NPTF            Female o'ring face swivel / Male NPTF</p>				Numéro Part number	A (")	B (")	
				848TT12X12	3/4	710TTO12	3/4

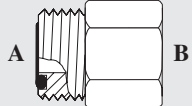
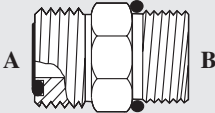
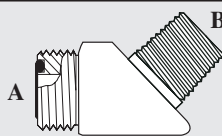
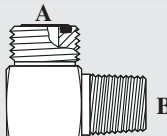

								
<b>846TT</b> Mâle o'ring face / Femelle NPTF Male o'ring face / Female NPTF				<b>848TTO</b> Mâle o'ring face / Mâle o'ring boss Male o'ring face / Male o'ring boss				
Numéro Part number	A (")	O'ring	B (")	Numéro Part number	A (")	O'ring	B (")	O'ring
				849TT06X06	3/8	710TTO06		
				849TT08X08	1/2	710TTO08		
				849TT10X08	5/8	710TTO10		
				849TT10X12	5/8	710TTO10		
				849TT12X12	3/4	710TTO12		
				849TT16X16	1	710TTO16		
846TT04X02	1/4	710TTO04	1/8	848TTO04X04	1/4	710TTO04	1/4	710FSO04
846TT04X04	1/4	710TTO04	1/4	848TTO04X06	1/4	710TTO04	3/8	710FSO06
846TT06X04	3/8	710TTO06	1/4	848TTO04X08	1/4	710TTO04	1/2	710FSO08
846TT06X06	3/8	710TTO06	3/8	848TTO06X04	3/8	710TTO06	1/4	710FSO04
846TT06X08	3/8	710TTO06	1/2	848TTO06X05	3/8	710TTO06	5/16	710FSO05
846TT08X06	1/2	710TTO08	3/8	848TTO06X06	3/8	710TTO06	3/8	710FSO06
846TT08X08	1/2	710TTO08	1/2	848TTO06X08	3/8	710TTO06	1/2	710FSO08
846TT08X12	1/2	710TTO08	3/4	848TTO06X10	3/8	710TTO06	5/8	710FSO10
846TT10X08	5/8	710TTO10	1/2	848TTO06X12	3/8	710TTO06	3/4	710FSO12
846TT12X08	3/4	710TTO12	1/2	848TTO08X06	1/2	710TTO08	3/8	710FSO06
846TT12X12	3/4	710TTO12	3/4	848TTO08X08	1/2	710TTO08	1/2	710FSO08
846TT16X16	1	710TTO16	1	848TTO08X10	1/2	710TTO08	5/8	710FSO10
846TT20X20	1-1/4	710TTO20	1-1/4	848TTO08X12	1/2	710TTO08	3/4	710FSO12
				848TTO10X08	5/8	710TTO10	1/2	710FSO08
				848TTO10X10	5/8	710TTO10	5/8	710FSO10
				848TTO10X12	5/8	710TTO10	3/4	710FSO12
				848TTO12X06	3/4	710TTO12	3/8	710FSO06
				848TTO12X08	3/4	710TTO12	1/2	710FSO08
				848TTO12X10	3/4	710TTO12	5/8	710FSO10
				848TTO12X12	3/4	710TTO12	3/4	710FSO12
				848TTO12X14	3/4	710TTO12	7/8	710FSO14
				848TTO12X16	3/4	710TTO12	1	710FSO16
				848TTO16X12	1	710TTO16	3/4	710FSO12
				848TTO16X16	1	710TTO16	1	710FSO16
				848TTO16X20	1	710TTO16	1-1/4	710FSO20
				848TTO20X16	1-1/4	710TTO20	1	710FSO16
				848TTO20X20	1-1/4	710TTO20	1-1/4	710FSO20
				848TTO20X24	1-1/4	710TTO20	1-1/2	710FSO24
				848TTO24X20	1-1/2	710TTO24	1-1/4	710FSO20
				848TTO24X24	1-1/2	710TTO24	1-1/2	710FSO24
								
<b>854TT</b> Mâle o'ring face / Mâle NPTF Male o'ring face / Male NPTF				<b>849TT</b> Mâle o'ring face / Mâle NPTF Male o'ring face / Male NPTF				
Numéro Part number	A (")	O'ring	B (")	Numéro Part number	A (")	O'ring	B (")	
854TT04X04	1/4	710TTO04	1/4	849TT04X04	1/4	710TTO04	1/4	
854TT04X06	1/4	710TTO04	3/8	849TT06X02	3/8	710TTO06	1/8	
854TT06X04	3/8	710TTO06	1/4					
854TT06X06	3/8	710TTO06	3/8					
854TT08X06	1/2	710TTO08	3/8					
854TT08X08	1/2	710TTO08	1/2					
854TT10X08	5/8	710TTO10	1/2					
854TT12X12	3/4	710TTO12	3/4					
854TT12X16	3/4	710TTO12	1					
854TT16X16	1	710TTO16	1					
854TT20X20	1-1/4	710TTO20	1-1/4					

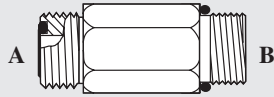

**848LTTO**

 Mâle o'ring face / Mâle o'ring boss long  
 Male o'ring face / Male o'ring boss long

Numéro Part number	A (")	O'ring	B (")	O'ring
848LTTO04X04	1/4	710TTO04	1/4	710FSO04
848LTTO06X06	3/8	710TTO06	3/8	710FSO06
848LTTO06X08	3/8	710TTO06	1/2	710FSO08
848LTTO08X08	1/2	710TTO08	1/2	710FSO08
848LTTO10X10	5/8	710TTO10	5/8	710FSO10
848LTTO12X12	3/4	710TTO12	3/4	710FSO12
848LTTO16X16	1	710TTO16	1	710FSO16
848LTTO20X20	1-1/4	710TTO20	1-1/4	710FSO20
848LTTO24X24	1-1/2	710TTO24	1-1/2	710FSO24

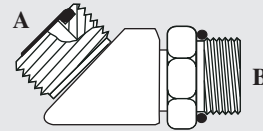
**854TTO**

 Mâle o'ring face / Mâle o'ring boss ajustable  
 Male o'ring face / Male o'ring boss adjustable

Numéro Part number	A (")	O'ring	B (")	O'ring
854TTO04X04	1/4	710TTO04	1/4	710FSO04
854TTO04X06	1/4	710TTO04	3/8	710FSO06
854TTO06X04	3/8	710TTO06	1/4	710FSO04
854TTO06X06	3/8	710TTO06	3/8	710FSO06
854TTO06X08	3/8	710TTO06	1/2	710FSO08
854TTO08X06	1/2	710TTO08	3/8	710FSO06
854TTO08X08	1/2	710TTO08	1/2	710FSO08
854TTO08X10	1/2	710TTO08	5/8	710FSO10
854TTO08X12	1/2	710TTO08	3/4	710FSO12
854TTO10X08	5/8	710TTO10	1/2	710FSO08
854TTO10X10	5/8	710TTO10	5/8	710FSO10
854TTO10X12	5/8	710TTO10	3/4	710FSO12
854TTO12X12	3/4	710TTO12	3/4	710FSO12
854TTO12X16	3/4	710TTO12	1	710FSO16
854TTO16X12	1	710TTO16	3/4	710FSO12
854TTO16X16	1	710TTO16	1	710FSO16
854TTO16X20	1	710TTO16	1-1/4	710FSO20
854TTO20X20	1-1/4	710TTO20	1-1/4	710FSO20
854TTO24X24	1-1/2	710TTO24	1-1/2	710FSO24

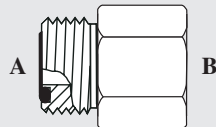
**846TTO**

 Mâle o'ring face / Femelle o'ring boss  
 Male o'ring face / Female o'ring boss

Numéro Part number	A (")	O'ring	B (")
846TTO06X06	3/8	710TTO06	3/8
846TTO08X08	1/2	710TTO08	1/2
846TTO12X12	3/4	710TTO12	3/4

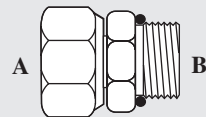
**881TTO**

 Femelle o'ring face tournant / Mâle o'ring boss  
 Female o'ring face swivel / Male o'ring boss

Numéro Part number	A (")	B (")	O'ring
881TTO04X04	1/4	1/4	710FSO04
881TTO04X12	1/4	3/4	710FSO12
881TTO06X06	3/8	3/8	710FSO06
881TTO06X12	3/8	3/4	710FSO12
881TTO08X08	1/2	1/2	710FSO08
881TTO08X10	1/2	5/8	710FSO10
881TTO10X10	5/8	5/8	710FSO10
881TTO12X12	3/4	3/4	710FSO12
881TTO16X12	1	3/4	710FSO12
881TTO16X16	1	1	710FSO16
881TTO20X20	1-1/4	1-1/4	710FSO20
881TTO24X24	1-1/2	1-1/2	710FSO24

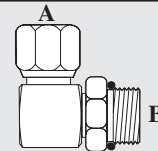

**878TTO**

 Femelle o'ring face tournant / Mâle o'ring boss ajustable  
 Female o'ring face swivel / Male o'ring boss adjustable

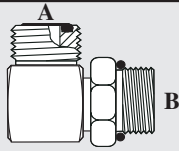
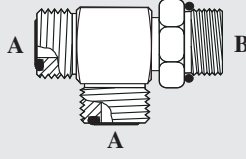
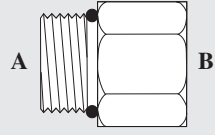
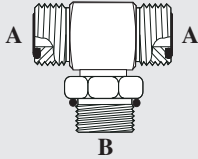
Numéro Part number	A (")	B (")	O'ring
878TTO04X04	1/4	1/4	710FSO04
878TTO06X06	3/8	3/8	710FSO06
878TTO08X08	1/2	1/2	710FSO08
878TTO10X10	5/8	5/8	710FSO10
878TTO12X12	3/4	3/4	710FSO12
878TTO16X16	1	1	710FSO16

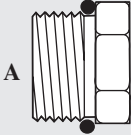
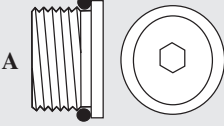
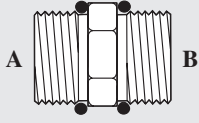
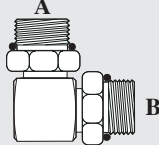
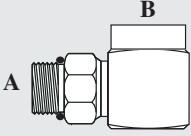
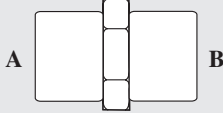
					Numéro Part number	A (")	O'ring	B (")	O'ring																																																																												
<b>849TTO</b>					845TTO20X20	1-1/4	710TTO20	1-1/4	710FSO20																																																																												
Mâle o'ring face / Mâle o'ring boss ajustable					845TTO24X24	1-1/2	710TTO24	1-1/2	710FSO24																																																																												
Male o'ring face / Male o'ring boss adjustable																																																																																					
<b>849TTO</b>					<b>851TTO</b>																																																																																
Mâle o'ring face / Mâle o'ring boss ajustable					Mâle o'ring face / Mâle o'ring face / Mâle o'ring boss ajustable																																																																																
Male o'ring face / Male o'ring boss adjustable					Male o'ring face / Male o'ring face / Male o'ring boss adjustable																																																																																
Numéro Part number	A (")	O'ring	B (")	O'ring	Numéro Part number	A (")	O'ring	B (")	O'ring																																																																												
849TTO04X04	1/4	710TTO04	1/4	710FSO04	851TTO04X04	1/4	710TTO04	1/4	710FSO04																																																																												
849TTO04X05	1/4	710TTO04	5/16	710FSO05	851TTO06X06	3/8	710TTO06	3/8	710FSO06																																																																												
849TTO04X06	1/4	710TTO04	3/8	710FSO06	851TTO08X08	1/2	710TTO08	1/2	710FSO08																																																																												
849TTO04X08	1/4	710TTO04	1/2	710FSO08	851TTO10X10	5/8	710TTO10	5/8	710FSO10																																																																												
849TTO06X04	3/8	710TTO06	1/4	710FSO04	851TTO12X12	3/4	710TTO12	3/4	710FSO12																																																																												
849TTO06X05	3/8	710TTO06	5/16	710FSO05	851TTO16X16	1	710TTO16	1	710FSO16																																																																												
849TTO06X06	3/8	710TTO06	3/8	710FSO06	<b>ORB (o'ring boss)</b>																																																																																
849TTO06X08	3/8	710TTO06	1/2	710FSO08																																																																																	
849TTO06X10	3/8	710TTO06	5/8	710FSO10																																																																																	
849TTO06X12	3/8	710TTO06	3/4	710FSO12	<b>719FSO</b>																																																																																
849TTO08X06	1/2	710TTO08	3/8	710FSO06	Mâle o'ring boss / Femelle o'ring boss																																																																																
849TTO08X08	1/2	710TTO08	1/2	710FSO08	Male o'ring boss / Female o'ring boss																																																																																
849TTO08X10	1/2	710TTO08	5/8	710FSO10	<table border="1"> <thead> <tr> <th>Numéro Part number</th> <th>A (")</th> <th>O'ring</th> <th>B (")</th> </tr> </thead> <tbody> <tr> <td>719FSO06X04</td> <td>3/8</td> <td>710FSO06</td> <td>1/4</td> </tr> <tr> <td>719FSO06X08</td> <td>3/8</td> <td>710FSO06</td> <td>1/2</td> </tr> <tr> <td>719FSO08X06</td> <td>1/2</td> <td>710FSO08</td> <td>3/8</td> </tr> <tr> <td>719FSO08X08</td> <td>1/2</td> <td>710FSO08</td> <td>1/2</td> </tr> <tr> <td>719FSO08X10</td> <td>1/2</td> <td>710FSO08</td> <td>5/8</td> </tr> <tr> <td>719FSO10X06</td> <td>5/8</td> <td>710FSO10</td> <td>3/8</td> </tr> <tr> <td>719FSO10X08</td> <td>5/8</td> <td>710FSO10</td> <td>1/2</td> </tr> <tr> <td>719FSO10X12</td> <td>5/8</td> <td>710FSO10</td> <td>3/4</td> </tr> <tr> <td>719FSO12X06</td> <td>3/4</td> <td>710FSO12</td> <td>3/8</td> </tr> <tr> <td>719FSO12X08</td> <td>3/4</td> <td>710FSO12</td> <td>1/2</td> </tr> <tr> <td>719FSO12X10</td> <td>3/4</td> <td>710FSO12</td> <td>5/8</td> </tr> <tr> <td>719FSO14X12</td> <td>7/8</td> <td>710FSO14</td> <td>3/4</td> </tr> <tr> <td>719FSO16X10</td> <td>1</td> <td>710FSO16</td> <td>5/8</td> </tr> <tr> <td>719FSO16X12</td> <td>1</td> <td>710FSO16</td> <td>3/4</td> </tr> <tr> <td>719FSO20X12</td> <td>1-1/4</td> <td>710FSO20</td> <td>3/4</td> </tr> <tr> <td>719FSO20X16</td> <td>1-1/4</td> <td>710FSO20</td> <td>1</td> </tr> <tr> <td>719FSO24X16</td> <td>1-1/2</td> <td>710FSO24</td> <td>1</td> </tr> <tr> <td>719FSO24X20</td> <td>1-1/2</td> <td>710FSO24</td> <td>1 1/4</td> </tr> </tbody> </table>					Numéro Part number	A (")	O'ring	B (")	719FSO06X04	3/8	710FSO06	1/4	719FSO06X08	3/8	710FSO06	1/2	719FSO08X06	1/2	710FSO08	3/8	719FSO08X08	1/2	710FSO08	1/2	719FSO08X10	1/2	710FSO08	5/8	719FSO10X06	5/8	710FSO10	3/8	719FSO10X08	5/8	710FSO10	1/2	719FSO10X12	5/8	710FSO10	3/4	719FSO12X06	3/4	710FSO12	3/8	719FSO12X08	3/4	710FSO12	1/2	719FSO12X10	3/4	710FSO12	5/8	719FSO14X12	7/8	710FSO14	3/4	719FSO16X10	1	710FSO16	5/8	719FSO16X12	1	710FSO16	3/4	719FSO20X12	1-1/4	710FSO20	3/4	719FSO20X16	1-1/4	710FSO20	1	719FSO24X16	1-1/2	710FSO24	1	719FSO24X20	1-1/2	710FSO24	1 1/4
Numéro Part number	A (")	O'ring	B (")																																																																																		
719FSO06X04	3/8	710FSO06	1/4																																																																																		
719FSO06X08	3/8	710FSO06	1/2																																																																																		
719FSO08X06	1/2	710FSO08	3/8																																																																																		
719FSO08X08	1/2	710FSO08	1/2																																																																																		
719FSO08X10	1/2	710FSO08	5/8																																																																																		
719FSO10X06	5/8	710FSO10	3/8																																																																																		
719FSO10X08	5/8	710FSO10	1/2																																																																																		
719FSO10X12	5/8	710FSO10	3/4																																																																																		
719FSO12X06	3/4	710FSO12	3/8																																																																																		
719FSO12X08	3/4	710FSO12	1/2																																																																																		
719FSO12X10	3/4	710FSO12	5/8																																																																																		
719FSO14X12	7/8	710FSO14	3/4																																																																																		
719FSO16X10	1	710FSO16	5/8																																																																																		
719FSO16X12	1	710FSO16	3/4																																																																																		
719FSO20X12	1-1/4	710FSO20	3/4																																																																																		
719FSO20X16	1-1/4	710FSO20	1																																																																																		
719FSO24X16	1-1/2	710FSO24	1																																																																																		
719FSO24X20	1-1/2	710FSO24	1 1/4																																																																																		
849TTO08X12	1/2	710TTO08	3/4	710FSO12																																																																																	
849TTO10X08	5/8	710TTO10	1/2	710FSO08	<b>845TTO</b>																																																																																
849TTO10X10	5/8	710TTO10	5/8	710FSO10	Mâle o'ring face / Mâle o'ring boss ajustable / Mâle o'ring face																																																																																
849TTO10X12	5/8	710TTO10	3/4	710FSO12	Male o'ring face / Male o'ring boss adjustable / Male o'ring face																																																																																
849TTO12X08	3/4	710TTO12	1/2	710FSO08	<table border="1"> <thead> <tr> <th>Numéro Part number</th> <th>A (")</th> <th>O'ring</th> <th>B (")</th> <th>O'ring</th> </tr> </thead> <tbody> <tr> <td>845TTO04X04</td> <td>1/4</td> <td>710TTO04</td> <td>1/4</td> <td>710FSO04</td> </tr> <tr> <td>845TTO06X06</td> <td>3/8</td> <td>710TTO06</td> <td>3/8</td> <td>710FSO06</td> </tr> <tr> <td>845TTO06X08</td> <td>3/8</td> <td>710TTO06</td> <td>1/2</td> <td>710FSO08</td> </tr> <tr> <td>845TTO08X08</td> <td>1/2</td> <td>710TTO08</td> <td>1/2</td> <td>710FSO08</td> </tr> <tr> <td>845TTO10X10</td> <td>5/8</td> <td>710TTO10</td> <td>5/8</td> <td>710FSO10</td> </tr> <tr> <td>845TTO12X10</td> <td>3/4</td> <td>710TTO12</td> <td>5/8</td> <td>710FSO10</td> </tr> <tr> <td>845TTO12X12</td> <td>3/4</td> <td>710TTO12</td> <td>3/4</td> <td>710FSO12</td> </tr> <tr> <td>845TTO16X16</td> <td>1</td> <td>710TTO16</td> <td>1</td> <td>710FSO16</td> </tr> </tbody> </table>					Numéro Part number	A (")	O'ring	B (")	O'ring	845TTO04X04	1/4	710TTO04	1/4	710FSO04	845TTO06X06	3/8	710TTO06	3/8	710FSO06	845TTO06X08	3/8	710TTO06	1/2	710FSO08	845TTO08X08	1/2	710TTO08	1/2	710FSO08	845TTO10X10	5/8	710TTO10	5/8	710FSO10	845TTO12X10	3/4	710TTO12	5/8	710FSO10	845TTO12X12	3/4	710TTO12	3/4	710FSO12	845TTO16X16	1	710TTO16	1	710FSO16																															
Numéro Part number	A (")	O'ring	B (")	O'ring																																																																																	
845TTO04X04	1/4	710TTO04	1/4	710FSO04																																																																																	
845TTO06X06	3/8	710TTO06	3/8	710FSO06																																																																																	
845TTO06X08	3/8	710TTO06	1/2	710FSO08																																																																																	
845TTO08X08	1/2	710TTO08	1/2	710FSO08																																																																																	
845TTO10X10	5/8	710TTO10	5/8	710FSO10																																																																																	
845TTO12X10	3/4	710TTO12	5/8	710FSO10																																																																																	
845TTO12X12	3/4	710TTO12	3/4	710FSO12																																																																																	
845TTO16X16	1	710TTO16	1	710FSO16																																																																																	
849TTO12X12	3/4	710TTO12	3/4	710FSO12																																																																																	
849TTO12X16	3/4	710TTO12	1	710FSO16																																																																																	
849TTO16X12	1	710TTO16	3/4	710FSO12																																																																																	
849TTO16X16	1	710TTO16	1	710FSO16																																																																																	
849TTO16X20	1	710TTO16	1-1/4	710FSO20																																																																																	
849TTO20X16	1-1/4	710TTO20	1	710FSO16																																																																																	
849TTO20X20	1-1/4	710TTO20	1-1/4	710FSO20																																																																																	
849TTO24X20	1-1/2	710TTO24	1-1/4	710FSO20																																																																																	
849TTO24X24	1-1/2	710TTO24	1-1/2	710FSO24																																																																																	

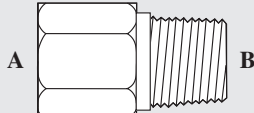
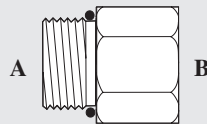
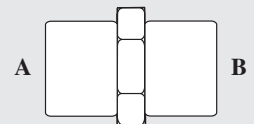
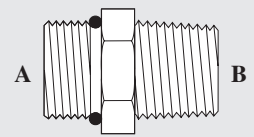
 <p><b>721FSO</b>  <b>Bouchon mâle o'ring boss tête hexagone</b>  <b>Hexagon head o'ring boss male plug</b></p>			Numéro Part number	A (")	B (")	
			780FSO04X06 780FSO06X06	1/4 3/8	3/8 3/8	
 <p><b>723FSO</b>  <b>Bouchon mâle o'ring boss type Allen</b>  <b>Allen type o'ring boss male plug</b></p>			 <p><b>742FSO</b>  <b>Mâle o'ring boss / Mâle o'ring boss</b>  <b>Male o'ring boss / Male o'ring boss</b></p>			
Numéro Part number	A (")	O'ring	Numéro Part number	A (")	B (")	O'ring
721FSO02 721FSO03 721FSO04 721FSO05 721FSO06 721FSO08 721FSO10 721FSO12 721FSO14 721FSO16 721FSO20 721FSO24 721FSO32	1/8 3/16 1/4 5/16 3/8 1/2 5/8 3/4 7/8 1 1-1/4 1-1/2 2	710FSO02 710FSO03 710FSO04 710FSO05 710FSO06 710FSO08 710FSO10 710FSO12 710FSO14 710FSO16 710FSO20 710FSO24 710FSO32	742FSO04X04 742FSO06X06 742FSO08X08 742FSO10X10 742FSO12X12 742FSO16X16 742FSO20X20 742FSO24X24	1/4 3/8 1/2 5/8 3/4 1 1-1/4 1-1/2	1/4 3/8 1/2 5/8 3/4 1 1-1/4 1-1/2	710FSO04 710FSO06 710FSO08 710FSO10 710FSO12 710FSO16 710FSO20 710FSO24
 <p><b>755FSO</b>  <b>Mâle o'ring boss / Mâle o'ring boss</b>  <b>Male o'ring boss / Male o'ring boss</b></p>			Numéro Part number	A (")	B (")	O'ring
 <p><b>779FSO</b>  <b>Mâle o'ring boss ajustable / Femelle o'ring boss</b>  <b>Male o'ring boss adjustable / Female o'ring boss</b></p>			Numéro Part number	A (")	O'ring	B (")
 <p><b>780FSO</b>  <b>Femelle o'ring boss / Femelle o'ring boss</b>  <b>Female o'ring boss / Female o'ring boss</b></p>			755FSO04X04 755FSO06X06 755FSO08X08 755FSO10X10 755FSO12X12 755FSO16X16 755FSO20X20 755FSO24X24	1/4 3/8 1/2 5/8 3/4 1 1-1/4 1-1/2	1/4 3/8 1/2 5/8 3/4 1 1-1/4 1-1/2	710FSO04 710FSO06 710FSO08 710FSO10 710FSO12 710FSO16 710FSO20 710FSO24
Numéro Part number	A (")	B (")	779FSO03X03 779FSO03X04 779FSO04X04 779FSO05X05 779FSO06X06 779FSO08X08	3/16 3/16 1/4 5/16 3/8 1/2	710FSO03 710FSO03 710FSO04 710FSO05 710FSO06 710FSO08	3/16 1/4 1/4 5/16 3/8 1/2
780FSO03X04 780FSO04X04	3/16 1/4	1/4 1/4				

				Numéro Part number	A (")	O'ring	B (")				
<b>728FSO</b> <b>Femelle o'ring boss / Mâle NPTF</b> <b>Female o'ring boss / Male NPTF</b>				722FSO12X08	3/4	710FSO12	1/2				
				722FSO12X12	3/4	710FSO12	3/4				
				722FSO16X16	1	710FSO16	1				
				722FSO20X20	1-1/4	710FSO20	1-1/4				
				722FSO24X24	1-1/2	710FSO24	1-1/2				
				722FSO32X32	2	710FSO32	2				
Numéro Part number	A (")	B (")									
728FSO04X02	1/4	1/8									
728FSO04X04	1/4	1/4									
728FSO05X02	5/16	1/8									
728FSO06X06	3/8	3/8									
728FSO06X08	3/8	1/2									
728FSO08X06	1/2	3/8									
728FSO08X08	1/2	1/2									
728FSO10X08	5/8	1/2									
728FSO12X12	3/4	3/4									
728FSO16X16	1	1									
728FSO20X20	1-1/4	1-1/4									
								Numéro Part number	A (")	O'ring	B (")
<b>726FSO</b> <b>Femelle o'ring boss / Femelle NPTF</b> <b>Female o'ring boss / Female NPTF</b>								720FSO04X02	1/4	710FSO04	1/8
				720FSO04X04	1/4	710FSO04	1/4				
				720FSO04X06	1/4	710FSO04	3/8				
				720FSO05X02	5/16	710FSO05	1/8				
				720FSO05X04	5/16	710FSO05	1/4				
				720FSO06X04	3/8	710FSO06	1/4				
				720FSO06X06	3/8	710FSO06	3/8				
				720FSO06X08	3/8	710FSO06	1/2				
				720FSO08X04	1/2	710FSO08	1/4				
				720FSO08X06	1/2	710FSO08	3/8				
				720FSO08X08	1/2	710FSO08	1/2				
				720FSO10X04	5/8	710FSO10	1/4				
				720FSO10X06	5/8	710FSO10	3/8				
				720FSO10X08	5/8	710FSO10	1/2				
				720FSO10X12	5/8	710FSO10	3/4				
				720FSO12X06	3/4	710FSO12	3/8				
				720FSO12X08	3/4	710FSO12	1/2				
				720FSO12X12	3/4	710FSO12	3/4				
				720FSO14X12	7/8	710FSO14	3/4				
				720FSO16X08	1	710FSO16	1/2				
720FSO16X12	1	710FSO16	3/4								
720FSO16X16	1	710FSO16	1								
720FSO16X20	1	710FSO16	1-1/4								
720FSO20X12	1-1/4	710FSO20	3/4								
720FSO20X16	1-1/4	710FSO20	1								
720FSO20X20	1-1/4	710FSO20	1-1/4								
720FSO24X16	1-1/2	710FSO24	1								
720FSO24X24	1-1/2	710FSO24	1-1/2								
720FSO32X32	2	710FSO32	2								
Numéro Part number	A (")	O'ring	B (")								
722FSO04X02	1/4	710FSO04	1/8								
722FSO04X04	1/4	710FSO04	1/4								
722FSO06X04	3/8	710FSO06	1/4								
722FSO06X06	3/8	710FSO06	3/8								
722FSO08X04	1/2	710FSO08	1/4								
722FSO08X06	1/2	710FSO08	3/8								
722FSO08X08	1/2	710FSO08	1/2								
722FSO08X12	1/2	710FSO08	3/4								
722FSO10X08	5/8	710FSO10	1/2								

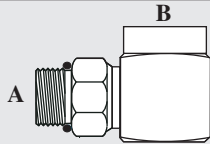
**725FSO**
**Mâle o'ring boss ajustable / Femelle NPTF**  
**Male o'ring boss adjustable / Female NPTF**

Numéro Part number	A (")	O'ring	B (")
725FSO04X02	1/4	710FSO04	1/8
725FSO04X04	1/4	710FSO04	1/4
725FSO05X02	5/16	710FSO05	1/8
725FSO08X06	1/2	710FSO08	3/8
725FSO08X08	1/2	710FSO08	1/2
725FSO12X12	3/4	710FSO12	3/4
725FSO16X16	1	710FSO16	1
725FSO20X20	1-1/4	710FSO20	1-1/4

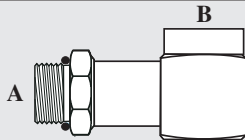
**725LFSO**
**Mâle o'ring boss ajustable long / Femelle NPTF**  
**Male o'ring boss adjustable long / Female NPTF**

Numéro Part number	A (")	O'ring	B (")
725LFSO08X06	1/2	710FSO08	3/8
725LFSO10X08	5/8	710FSO10	1/2
725LFSO12X12	3/4	710FSO12	3/4
725LFSO16X16	1	710FSO16	1

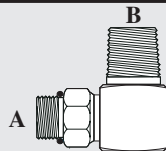
**729FSO**
**Mâle o'ring boss ajustable / Mâle NPTF**  
**Male o'ring boss adjustable / Male NPTF**

Numéro Part number	A (")	O'ring	B (")
729FSO04X04	1/4	710FSO04	1/4
729FSO06X04	3/8	710FSO06	1/4
729FSO06X06	3/8	710FSO06	3/8
729FSO08X08	1/2	710FSO08	1/2
729FSO12X12	3/4	710FSO12	3/4
729FSO16X16	1	710FSO16	1
729FSO20X20	1-1/4	710FSO20	1-1/4

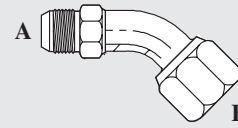
**ADAPTER TUBE**

**63TA**
**Mâle JIC / Femelle JIC tournant**  
**Male JIC / Female JIC swivel**

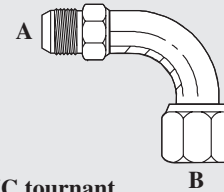
Numéro Part number	A (")	B (")
63TA04X04	1/4	1/4
63TA05X05	5/16	5/16
63TA06X06	3/8	3/8
63TA08X08	1/2	1/2
63TA10X10	5/8	5/8
63TA12X12	3/4	3/4
63TA16X16	1	1

**63UA**
**Mâle JIC / Femelle JIC tournant**  
**Male JIC / Female JIC swivel**

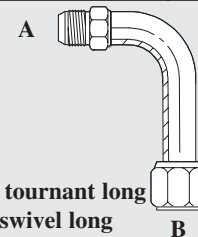
Numéro Part number	A (")	B (")
63UA04X04	1/4	1/4
63UA05X05	5/16	5/16
63UA06X06	3/8	3/8
63UA08X08	1/2	1/2
63UA10X10	5/8	5/8
63UA12X12	3/4	3/4
63UA16X16	1	1
63UA20X20	1-1/4	1-1/4
63UA24X24	1-1/2	1-1/2

**63UC**
**Mâle JIC / Femelle JIC tournant long**  
**Male JIC / Female JIC swivel long**

Numéro Part number	A (")	B (")
63UC04X04	1/4	1/4
63UC05X05	5/16	5/16
63UC06X06	3/8	3/8
63UC08X08	1/2	1/2
63UC10X10	5/8	5/8
63UC12X12	3/4	3/4
63UC16X16	1	1
63UC20X20	1-1/4	1-1/4

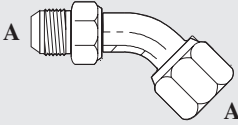
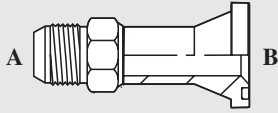
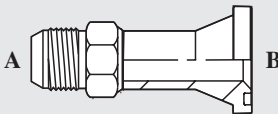
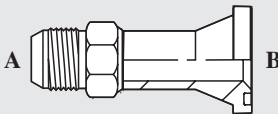
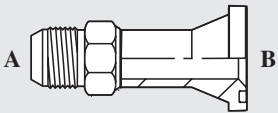
 <p><b>61TA</b>  <b>Mâle JIC / Femelle BSPP tournant</b>  <b>Male JIC / Female BSPP swivel</b></p>					Numéro Part number	A (")	B (")	O'ring	Bride Flange					
					63SB24X20	1-1/2	1-1/4	20PA77	20PA					
					63SB24X24	1-1/2	1-1/2	24PA77	24PA					
					63SB24X32	1-1/2	2	32PA77	32PA					
					63SB32X24	2	1-1/2	24PA77	24PA					
					63SB32X32	2	2	32PA77	32PA					
Numéro Part number					 <p><b>63SE</b>  <b>Mâle JIC / Bride (code 61 HD)</b>  <b>Male JIC / Flange (code 61 HD)</b></p>									
A (")														
61TA04	1/4													
61TA06	3/8													
61TA08	1/2													
61TA10	5/8													
61TA12	3/4													
61TA16	1													
 <p><b>61UA</b>  <b>Mâle JIC / Femelle BSPP tournant</b>  <b>Male JIC / Female BSPP swivel</b></p>					Numéro Part number	A (")	B (")	O'ring	Bride Flange					
					63SE12X12	3/4	3/4	12PA77	12PA					
					63SE12X16	3/4	1	16PA77	16PA					
					63SE16X16	1	1	16PA77	16PA					
					63SE16X20	1	1-1/4	20PA77	20PA					
					63SE20X20	1-1/4	1-1/4	20PA77	20PA					
63SE24X24	1-1/2	1-1/2	24PA77	24PA										
63SE32X32	2	2	32PA77	32PA										
Numéro Part number					 <p><b>63SF</b>  <b>Mâle JIC / Bride (code 62)</b>  <b>Male JIC / Flange (code 62)</b></p>									
										A (")				
										61UA04	1/4			
										61UA06	3/8			
										61UA08	1/2			
										61UA12	3/4			
61UA16	1													
 <p><b>63SB</b>  <b>Mâle JIC / Bride (code 61)</b>  <b>Male JIC / Flange (code 61)</b></p>					Numéro Part number	A (")	B (")	O'ring	Bride Flange					
					63SF08X08	1/2	1/2	08PA77	08PH					
					63SF12X12	3/4	3/4	12PA77	12PH					
					63SF12X16	3/4	1	16PA77	16PH					
					63SF16X12	1	3/4	12PA77	12PH					
					63SF16X16	1	1	16PA77	16PH					
63SF16X20	1	1-1/4	20PA77	20PH										
63SF16X24	1	1-1/2	24PA77	24PH										
63SF20X16	1-1/4	1	16PA77	16PH										
63SF20X20	1-1/4	1-1/4	20PA77	20PH										
63SF20X24	1-1/4	1-1/2	24PA77	24PH										
63SF24X20	1-1/2	1-1/4	20PA77	20PH										
63SF24X24	1-1/2	1-1/2	24PA77	24PH										
63SF32X32	2	2	32PA77	32PH										
Numéro Part number	A (")	B (")	O'ring	Bride Flange										
63SB08X08	1/2	1/2	08PA77	08PA										
63SB08X12	1/2	3/4	12PA77	12PA										
63SB12X12	3/4	3/4	12PA77	12PA										
63SB12X16	3/4	1	16PA77	16PA										
63SB12X20	3/4	1-1/4	20PA77	20PA										
63SB12X24	3/4	1-1/2	24PA77	24PA										
63SB16X12	1	3/4	12PA77	12PA										
63SB16X16	1	1	16PA77	16PA										
63SB16X20	1	1-1/4	20PA77	20PA										
63SB16X24	1	1-1/2	24PA77	24PA										
63SB20X16	1-1/4	1	16PA77	16PA										
63SB20X20	1-1/4	1-1/4	20PA77	20PA										
63SB20X24	1-1/4	1-1/2	24PA77	24PA										
63SB20X32	1-1/4	2	32PA77	32PA										
63SB24X16	1-1/2	1	16PA77	16PA										

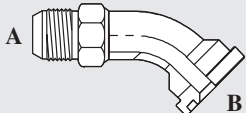
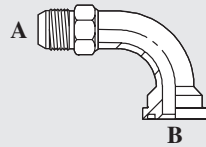
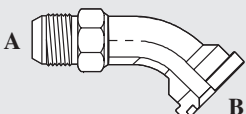
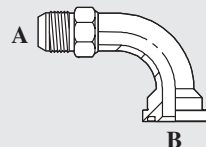
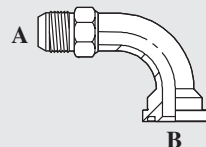
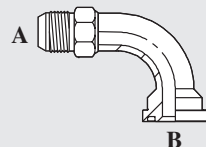

									
<b>63TB</b> Mâle JIC / Bride (code 61) Male JIC / Flange (code 61)					<b>63UB</b> Mâle JIC / Bride (code 61) Male JIC / Flange (code 61)				
Numéro Part number	A (")	B (")	O'ring	Bride Flange	Numéro Part number	A (")	B (")	O'ring	Bride Flange
63TF16X24	1	1-1/2	24PA77	24PH	63UB08X08	1/2	1/2	08PA77	08PA
63TF20X12	1-1/4	3/4	12PA77	12PH	63UB08X12	1/2	3/4	12PA77	12PA
63TF20X16	1-1/4	1	16PA77	16PH	63UB12X12	3/4	3/4	12PA77	12PA
63TF20X20	1-1/4	1-1/4	20PA77	20PH	63UB12X16	3/4	1	16PA77	16PA
63TF20X24	1-1/4	1-1/2	24PA77	24PH	63UB12X20	3/4	1-1/4	20PA77	20PA
63TF24X20	1-1/2	1-1/4	20PA77	20PH	63UB12X24	3/4	1-1/2	24PA77	24PA
63TF24X24	1-1/2	1-1/2	24PA77	24PH	63UB16X12	1	3/4	12PA77	12PA
63TF32X32	2	2	32PA77	32PH	63UB16X16	1	1	16PA77	16PA
63TB08X08	1/2	1/2	08PA77	08PA	63UB16X20	1	1-1/4	20PA77	20PA
63TB08X12	1/2	3/4	12PA77	12PA	63UB16X24	1	1-1/2	24PA77	24PA
63TB12X12	3/4	3/4	12PA77	12PA	63UB16X32	1	2	32PA77	32PA
63TB12X16	3/4	1	16PA77	16PA	63UB20X12	1-1/4	3/4	12PA77	12PA
63TB12X20	3/4	1-1/4	20PA77	20PA	63UB20X16	1-1/4	1	16PA77	16PA
63TB16X12	1	3/4	12PA77	12PA	63UB20X20	1-1/4	1-1/4	20PA77	20PA
63TB16X16	1	1	16PA77	16PA	63UB20X24	1-1/4	1-1/2	24PA77	24PA
63TB16X20	1	1-1/4	20PA77	20PA	63UB20X32	1-1/4	2	32PA77	32PA
63TB16X24	1	1-1/2	24PA77	24PA	63UB24X16	1-1/2	1	16PA77	16PA
63TB20X12	1-1/4	3/4	12PA77	12PA	63UB24X20	1-1/2	1-1/4	20PA77	20PA
63TB20X16	1-1/4	1	16PA77	16PA	63UB24X24	1-1/2	1-1/2	24PA77	24PA
63TB20X20	1-1/4	1-1/4	20PA77	20PA	63UB24X32	1-1/2	2	32PA77	32PA
63TB20X24	1-1/4	1-1/2	24PA77	24PA	63UB32X24	2	1-1/2	24PA77	24PA
63TB24X20	1-1/2	1-1/4	20PA77	20PA	63UB32X32	2	2	32PA77	32PA
63TB24X24	1-1/2	1-1/2	24PA77	24PA					
63TB32X32	2	2	32PA77	32PA					
									
<b>63TE</b> Mâle JIC / Bride (code 61 HD) Male JIC / Flange (code 61 HD)					<b>63UE</b> Mâle JIC / Bride (code 61 HD) Male JIC / Flange (code 61 HD)				
Numéro Part number	A (")	B (")	O'ring	Bride Flange	Numéro Part number	A (")	B (")	O'ring	Bride Flange
63TE12X12	3/4	3/4	12PA77	12PA	63UE12X12	3/4	3/4	12PA77	12PA
63TE16X16	1	1	16PA77	16PA	63UE12X16	3/4	1	16PA77	16PA
63TE16X20	1	1-1/4	20PA77	20PA	63UE16X16	1	1	16PA77	16PA
63TE20X20	1-1/4	1-1/4	20PA77	20PA	63UE16X20	1	1-1/4	20PA77	20PA
63TE24X24	1-1/2	1-1/2	24PA77	24PA					
									
<b>63TF</b> Mâle JIC / Bride (code 62) Male JIC / Flange (code 62)					<b>63UE</b> Mâle JIC / Bride (code 61 HD) Male JIC / Flange (code 61 HD)				
Numéro Part number	A (")	B (")	O'ring	Bride Flange	Numéro Part number	A (")	B (")	O'ring	Bride Flange
63TF08X08	1/2	1/2	08PA77	08PH	63UE12X12	3/4	3/4	12PA77	12PA
63TF12X12	3/4	3/4	12PA77	12PH	63UE12X16	3/4	1	16PA77	16PA
63TF12X16	3/4	1	16PA77	16PH	63UE16X16	1	1	16PA77	16PA
63TF16X16	1	1	16PA77	16PH	63UE16X20	1	1-1/4	20PA77	20PA
63TF16X20	1	1-1/4	20PA77	20PH					



Numéro Part number	A (")	B (")	O'ring	Bride Flange
63UE20X20	1-1/4	1-1/4	20PA77	20PA
63UE20X24	1-1/4	1-1/2	24PA77	24PA
63UE24X24	1-1/2	1-1/2	24PA77	24PA
63UE32X32	2	2	32PA77	32PA

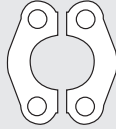

**63UF**  
**Mâle JIC / Bride (code 62)**  
**Male JIC / Flange (code 62)**

Numéro Part number	A (")	B (")	O'ring	Bride Flange
63UF08X08	1/2	1/2	08PA77	08PH
63UF12X12	3/4	3/4	12PA77	12PH
63UF12X16	3/4	1	16PA77	16PH
63UF12X20	3/4	1-1/4	20PA77	20PH
63UF16X12	1	3/4	12PA77	12PH
63UF16X16	1	1	16PA77	16PH
63UF16X20	1	1-1/4	20PA77	20PH
63UF16X24	1	1-1/2	24PA77	24PH
63UF20X16	1-1/4	1	16PA77	16PH
63UF20X20	1-1/4	1-1/4	20PA77	20PH
63UF20X24	1-1/4	1-1/2	24PA77	24PH
63UF24X16	1-1/2	1	16PA77	16PH
63UF24X20	1-1/2	1-1/4	20PA77	20PH
63UF24X24	1-1/2	1-1/2	24PA77	24PH
63UF24X32	1-1/2	2	32PA77	32PH
63UF32X32	2	2	32PA77	32PH

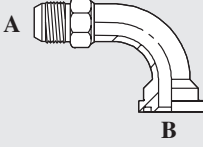

**PA**  
**Bride code 61**  
**Split flange code 61**

Numéro Part number	Dimension Size
08PA	1/2
12PA	3/4
16PA	1
20PA	1-1/4
24PA	1-1/2
32PA	2

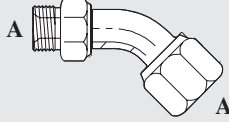

**PH**  
**Bride code 62**  
**Split flange code 62**

Numéro Part number	Dimension Size
08PH	1/2
12PH	3/4
16PH	1
20PH	1-1/4
24PH	1-1/2
32PH	2

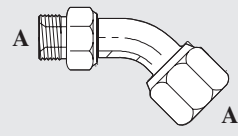

**62TA**  
**Mâle BSPP / Femelle BSPP tournant**  
**Male BSPP / Female BSPP swivel**

Numéro Part number	A (")
62TA04	1/4
62TA06	3/8
62TA08	1/2
62TA10	5/8
62TA12	3/4
62TA16	1
62TA20	1-1/4
62TA24	1-1/2
62TA32	2

  

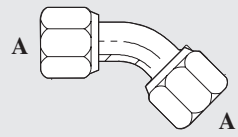

**62TD**  
**Femelle BSPP tournant / Femelle BSPP tournant**  
**Female BSPP swivel / Female BSPP swivel**

Numéro Part number	A (")
62TD04	1/4
62TD06	3/8
62TD08	1/2
62TD10	5/8
62TD12	3/4
62TD16	1
62TD20	1-1/4

					
<b>62UA</b> Mâle BSPP / Femelle BSPP tournant Male BSPP / Female BSPP swivel			<b>64UA</b> Mâle o'ring face / Femelle o'ring face tournant Male o'ring face / Female o'ring face swivel		
Numéro Part number	A (")		Numéro Part number	A (")	B (")
62UA04	1/4		64UA04X04	1/4	1/4
62UA06	3/8		64UA06X06	3/8	3/8
62UA08	1/2		64UA08X08	1/2	1/2
62UA10	5/8		64UA10X10	5/8	5/8
62UA12	3/4		64UA12X12	3/4	3/4
62UA16	1		64UA16X16	1	1
62UA20	1-1/4		64UA20X20	1-1/4	1-1/4
62UA24	1-1/2		64UA24X24	1-1/2	1-1/2
62UA32	2				
					
<b>62UD</b> Femelle BSPP tournant / Femelle BSPP tournant Female BSPP swivel / Female BSPP swivel			<b>64UC</b> Mâle o'ring face / Femelle o'ring face tournant long Male o'ring face / Female o'ring face swivel long		
Numéro Part number	A (")		Numéro Part number	A (")	B (")
62UD04	1/4		64UC04X04	1/4	1/4
62UD06	3/8		64UC06X06	3/8	3/8
62UD08	1/2		64UC08X08	1/2	1/2
62UD10	5/8		64UC12X12	3/4	3/4
62UD12	3/4		64UC16X16	1	1
62UD16	1		64UC20X20	1-1/4	1-1/4
62UD20	1-1/4				
62UD24	1-1/2				
					
<b>64TA</b> Mâle o'ring face / Femelle o'ring face tournant Male o'ring face / Female o'ring face swivel			<b>64SB</b> Mâle o'ring face / Bride code 61 Male o'ring face / Flange code 61		
Numéro Part number	A (")	B (")	Numéro Part number	A (")	B (")
64TA04X04	1/4	1/4	64SB10X10	5/8	5/8
64TA06X06	3/8	3/8	64SB10X12	5/8	3/4
64TA08X08	1/2	1/2	64SB12X12	3/4	3/4
64TA10X10	5/8	5/8	64SB12X16	3/4	1
64TA12X12	3/4	3/4	64SB16X12	1	3/4
64TA16X16	1	1	64SB16X16	1	1
64TA20X20	1-1/4	1-1/4	64SB16X20	1	1-1/4
			64SB16X24	1	1-1/2
			64SB20X16	1-1/4	1
			64SB20X20	1-1/4	1-1/4
			64SB20X24	1-1/4	1-1/2
			64SB24X20	1-1/2	1-1/4

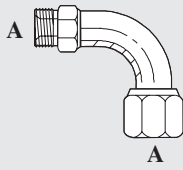
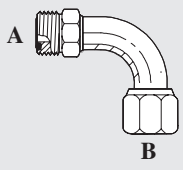
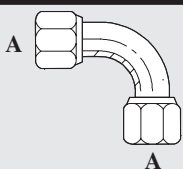
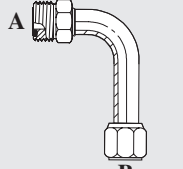
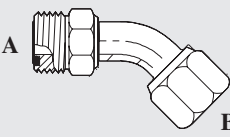
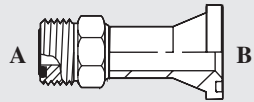
**64SF**

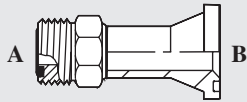
 Mâle o'ring face / Bride code 62  
 Male o'ring face / Flange code 62

Numéro Part number	A (")	B (")
64SF10X12	5/8	3/4
64SF12X12	3/4	3/4
64SF12X16	3/4	1
64SF16X12	1	3/4
64SF16X16	1	1
64SF16X20	1	1-1/4
64SF16X24	1	1-1/2
64SF20X16	1-1/4	1
64SF20X20	1-1/4	1-1/4
64SF20X24	1-1/4	1-1/2
64SF24X20	1-1/2	1-1/4

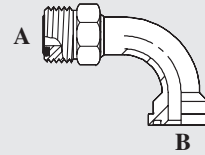
**64UB**

 Mâle o'ring face / Bride code 61  
 Male o'ring face / Flange code 61

Numéro Part number	A (")	B (")
64UB12X12	3/4	3/4
64UB12X16	3/4	1
64UB16X16	1	1
64UB16X20	1	1-1/4
64UB20X20	1-1/4	1-1/4
64UB20X24	1-1/4	1-1/2
64UB24X24	1-1/2	1-1/2

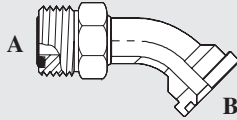
**64TB**

 Mâle o'ring face / Bride code 61  
 Male o'ring face / Flange code 61

Numéro Part number	A (")	B (")
64TB12X12	3/4	3/4
64TB12X16	3/4	1
64TB16X16	1	1
64TB16X20	1	1-1/4
64TB20X20	1-1/4	1-1/4
64TB20X24	1-1/4	1-1/2
64TB24X24	1-1/2	1-1/2

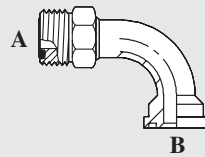
**64UF**

 Mâle o'ring face / Bride code 62  
 Male o'ring face / Flange code 62

Numéro Part number	A (")	B (")
64UF12X12	3/4	3/4
64UF12X16	3/4	1
64UF16X12	1	3/4
64UF16X16	1	1
64UF16X20	1	1-1/4
64UF16X24	1	1-1/2
64UF20X12	1-1/4	3/4
64UF20X16	1-1/4	1
64UF20X20	1-1/4	1-1/4
64UF20X24	1-1/4	1-1/2
64UF24X24	1-1/2	1-1/2

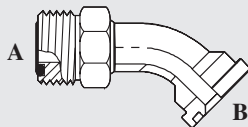
**64TF**

 Mâle o'ring face / Bride code 62  
 Male o'ring face / Flange code 62

Numéro Part number	A (")	B (")
64TF12X12	3/4	3/4
64TF16X16	1	1
64TF20X20	1-1/4	1-1/4

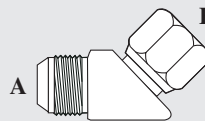
**SAE 45 (45° flare)**

**589FS**

 Mâle SAE45 / Femelle SAE45 tournant  
 Male SAE45 / Female SAE45 swivel

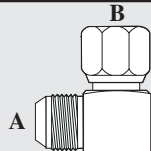
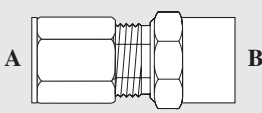
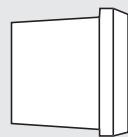
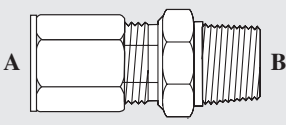
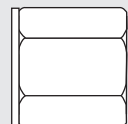
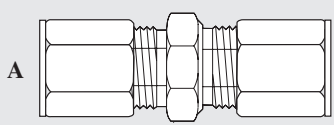
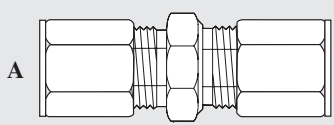
Numéro Part number	A (")	B (")
589FS06X06	3/8	3/8

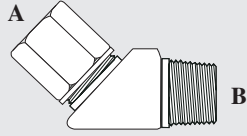
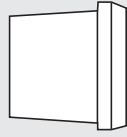
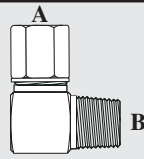
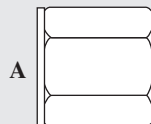
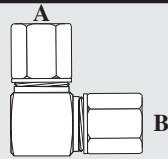
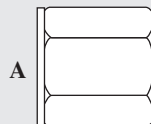
							
<b>579FS</b> Mâle SAE45 / Femelle SAE45 tournant Male SAE45 / Female SAE45 swivel			<b>1946FS</b> Tube / Femelle NPTF Tube / Female NPTF				
Numéro Part number	A (")	B (")	Numéro Part number	A (")	B (")	Écrou Nut	Bague Sleeve
579FS06X06	3/8	3/8	1946FS02X02	1/8	1/8	1961FS02	1960FS02
<b>FLARELESS (compression)</b>			1946FS04X04	1/4	1/4	1961FS04	1960FS04
			1946FS06X06	3/8	3/8	1961FS06	1960FS06
<b>1960FS</b> Bague Sleeve			1946FS08X08	1/2	1/2	1961FS08	1960FS08
Numéro Part number	Tube (")		1946FS12X12	3/4	3/4	1961FS12	1960FS12
1960FS02	1/8		1946FS16X16	1	1	1961FS16	1960FS16
1960FS03	3/16						
1960FS04	1/4		<b>1948FS</b> Tube / Mâle NPTF Tube / Male NPTF				
1960FS05	5/16		Numéro Part number	A (")	B (")	Écrou Nut	Bague Sleeve
1960FS06	3/8		1948FS02X02	1/8	1/8	1961FS02	1960FS02
1960FS08	1/2		1948FS04X02	1/4	1/8	1961FS04	1960FS04
1960FS10	5/8		1948FS04X04	1/4	1/4	1961FS04	1960FS04
1960FS12	3/4		1948FS06X04	3/8	1/4	1961FS06	1960FS06
1960FS14	7/8		1948FS06X06	3/8	3/8	1961FS06	1960FS06
1960FS16	1		1948FS08X06	1/2	3/8	1961FS08	1960FS08
			1948FS08X08	1/2	1/2	1961FS08	1960FS08
<b>1961FS</b> Écrou Nut			1948FS10X08	5/8	1/2	1961FS10	1960FS10
Numéro Part number	Tube (")		1948FS12X12	3/4	3/4	1961FS12	1960FS12
1961FS02	1/8		1948FS16X16	1	1	1961FS16	1960FS16
1961FS03	3/16						
1961FS04	1/4		<b>1942FS</b> Tube / Tube Tube / Tube				
1961FS05	5/16		Numéro Part number	A (")	B (")	Écrou Nut	Bague Sleeve
1961FS06	3/8		1942FS02X02	1/8	1/8	1961FS02	1960FS02
1961FS08	1/2		1942FS03X03	3/16	3/16	1961FS03	1960FS03
1961FS10	5/8		1942FS04X04	1/4	1/4	1961FS04	1960FS04
1961FS12	3/4		1942FS05X05	5/16	5/16	1961FS05	1960FS05
1961FS14	7/8		1942FS06X06	3/8	3/8	1961FS06	1960FS06
1961FS16	1		1942FS08X08	1/2	1/2	1961FS08	1960FS08
			1942FS10X10	5/8	5/8	1961FS10	1960FS10
<b>1942FS</b> Tube / Tube Tube / Tube			1942FS12X12	3/4	3/4	1961FS12	1960FS12
Numéro Part number	Tube (")		1942FS16X16	1	1	1961FS16	1960FS16
1942FS02X02	1/8						
1942FS03X03	3/16						
1942FS04X04	1/4						
1942FS05X05	5/16						
1942FS06X06	3/8						
1942FS08X08	1/2						
1942FS10X10	5/8						
1942FS12X12	3/4						
1942FS16X16	1						

 <b>1954FS</b> <b>Tube / Mâle NPTF</b> <b>Tube / Male NPTF</b>					<b>FLARELESS METRIC (compression)</b>		
Numéro Part number	A (")	B (")	Écrou Nut	Bague Sleeve	 <b>1960FSM</b> <b>Bague</b> <b>Sleeve</b>		
1954FS04X04	1/4	1/4	1961FS04	1960FS04	Numéro Part number	Tube (mm)	
1954FS06X04	3/8	1/4	1961FS06	1960FS06	1960FSM4LL	4mm	
1954FS08X06	1/2	3/8	1961FS08	1960FS08	1960FSM6LL	6mm	
1954FS10X08	5/8	1/2	1961FS10	1960FS10	1960FSM8LL	8mm	
1954FS12X12	3/4	3/4	1961FS12	1960FS12	1960FSM6LS	6mm	
1954FS16X16	1	1	1961FS16	1960FS16	1960FSM8LS	8mm	
 <b>1949FS</b> <b>Tube / Mâle NPTF</b> <b>Tube / Male NPTF</b>					 <b>1961FSM</b> <b>Écrou</b> <b>Nut</b>		
Numéro Part number	A (")	B (")	Écrou Nut	Bague Sleeve	Numéro Part number	Tube (mm)	
1949FS04X02	1/4	1/8	1961FS04	1960FS04	1960FSM10LS	10mm	
1949FS04X04	1/4	1/4	1961FS04	1960FS04	1960FSM12LS	12mm	
1949FS05X04	5/16	1/4	1961FS05	1960FS05	1960FSM15L	15mm	
1949FS06X06	3/8	3/8	1961FS06	1960FS06	1960FSM18L	18mm	
1949FS08X08	1/2	1/2	1961FS08	1960FS08	1960FSM22L	22mm	
1949FS10X08	5/8	1/2	1961FS10	1960FS10	1960FSM28L	28mm	
1949FS12X12	3/4	3/4	1961FS12	1960FS12	1960FSM35L	35mm	
1949FS16X16	1	1	1961FS16	1960FS16	1960FSM42L	42mm	
 <b>1955FS</b> <b>Tube / Tube</b> <b>Tube / Tube</b>					1960FSM14S	14mm	
Numéro Part number	A (")	B (")	Écrou Nut	Bague Sleeve	1960FSM16S	16mm	
1955FS04X04	1/4	1/4	1961FS04	1960FS04	1960FSM20S	20mm	
1955FS05X05	5/16	5/16	1961FS05	1960FS05	1960FSM25S	25mm	
1955FS06X06	3/8	3/8	1961FS06	1960FS06	1960FSM30S	30mm	
1955FS08X08	1/2	1/2	1961FS08	1960FS08	1960FSM38S	38mm	
1955FS10X10	5/8	5/8	1961FS10	1960FS10			
1955FS12X12	3/4	3/4	1961FS12	1960FS12	Numéro Part number	A (mm)	Tube (mm)
1955FS16X16	1	1	1961FS16	1960FS16	1961FSM4LL	M8X1.0	4mm
					1961FSM6LL	M10X1.0	6mm
					1961FSM8LL	M12X1.0	8mm
					1961FSM6L	M12X1.5	6mm
					1961FSM8L	M14X1.5	8mm
					1961FSM10L	M16X1.5	10mm
					1961FSM12L	M18X1.5	12mm
					1961FSM15L	M22X1.5	15mm
					1961FSM18L	M26X1.5	18mm
					1961FSM22L	M30X2.0	22mm
					1961FSM28L	M36X2.0	28mm
					1961FSM35L	M45X2.0	35mm
					1961FSM42L	M52X2.0	42mm
					1961FSM6S	M14X1.5	6mm
					1961FSM8S	M16X1.5	8mm

Numéro Part number	A (mm)	Tube (mm)		
1961FSM10S	M18X1.5	10mm		
1961FSM12S	M20X1.5	12mm		
1961FSM14S	M22X1.5	14mm		
1961FSM16S	M24X1.5	16mm		
1961FSM20S	M30X2.0	20mm		
1961FSM25S	M36X2.0	25mm		
1961FSM30S	M42X2.0	30mm		
1961FSM38S	M52X2.0	38mm		

  

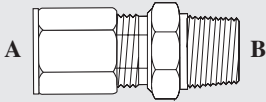

**1948FSM**  
**Tube / Mâle NPTF**  
**Tube / Male NPTF**

Numéro Part number	A (mm)	B (")	Écrou Nut	Bague Sleeve
1948FSM4LL02	4mm	1/8	1961FSM4LL	1960FSM4LL
1948FSM6LL02	6mm	1/8	1961FSM6LL	1960FSM6LL
1948FSM6L04	6mm	1/4	1961FSM6L	1960FSM6LS
1948FSM8L04	8mm	1/4	1961FSM8L	1960FSM8LS
1948FSM10L06	10mm	3/8	1961FSM10L	1960FSM10LS
1948FSM12L08	12mm	1/2	1961FSM12L	1960FSM12LS
1948FSM15L08	15mm	1/2	1961FSM15L	1960FSM15L
1948FSM6S04	6mm	1/4	1961FSM6S	1960FSM6LS
1948FSM8S04	8mm	1/4	1961FSM8S	1960FSM8LS
1948FSM10S04	10mm	1/4	1961FSM10S	1960FSM10LS
1948FSM12S06	12mm	3/8	1961FSM12S	1960FSM12LS
1948FSM14S08	14mm	1/2	1961FSM14S	1960FSM14S
1948FSM16S08	16mm	1/2	1961FSM16S	1960FSM16S

  

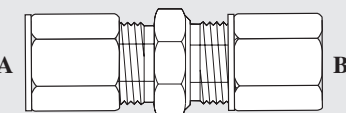

**1942FSM**  
**Tube / Tube**  
**Tube / Tube**

Numéro Part number	A (mm)	B (mm)	Écrou Nut	Bague Sleeve
1942FSM4LL	4mm	4mm	1961FSM4LL	1960FSM4LL
1942FSM6LL	6mm	6mm	1961FSM6LL	1960FSM6LL
1942FSM6L	6mm	6mm	1961FSM6L	1960FSM6LS
1942FSM8L	8mm	8mm	1961FSM8L	1960FSM8LS
1942FSM10L	10mm	10mm	1961FSM10L	1960FSM10LS
1942FSM12L	12mm	12mm	1961FSM12L	1960FSM12LS
1942FSM15L	15mm	15mm	1961FSM15L	1960FSM15L
1942FSM6S	6mm	6mm	1961FSM6S	1960FSM6LS
1942FSM8S	8mm	8mm	1961FSM8S	1960FSM8LS
1942FSM10S	10mm	10mm	1961FSM10S	1960FSM10LS
1942FSM12S	12mm	12mm	1961FSM12S	1960FSM12LS
1942FSM14S	14mm	14mm	1961FSM14S	1960FSM14S
1942FSM16S	16mm	16mm	1961FSM16S	1960FSM16S

  

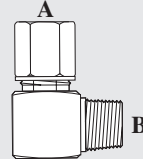

**1949FSM**  
**Tube / Mâle NPTF**  
**Tube / Male NPTF**

Numéro Part number	A (mm)	B (")	Écrou Nut	Bague Sleeve
1949FSM4LL02	4mm	1/8	1961FSM4LL	1960FSM4LL
1949FSM6LL02	6mm	1/8	1961FSM6LL	1960FSM6LL
1949FSM6L02	6mm	1/8	1961FSM6L	1960FSM6LS
1949FSM8L04	8mm	1/4	1961FSM8L	1960FSM8LS
1949FSM10L04	10mm	1/4	1961FSM10L	1960FSM10LS
1949FSM12L06	12mm	3/8	1961FSM12L	1960FSM12LS
1949FSM15L08	15mm	1/2	1961FSM15L	1960FSM15L
1949FSM6S04	6mm	1/4	1961FSM6S	1960FSM6LS
1949FSM8S04	8mm	1/4	1961FSM8S	1960FSM8LS
1949FSM10S06	10mm	3/8	1961FSM10S	1960FSM10LS
1949FSM12S06	12mm	3/8	1961FSM12S	1960FSM12LS
1949FSM14S08	14mm	1/2	1961FSM14S	1960FSM14S
1949FSM16S08	16mm	1/2	1961FSM16S	1960FSM16S

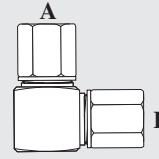

**1955FSM**  
**Tube / Tube**  
**Tube / Tube**

Numéro Part number	A (mm)	B (mm)	Écrou Nut	Bague Sleeve
1955FSM4LL	4mm	4mm	1961FSM4LL	1960FSM4LL
1955FSM6LL	6mm	6mm	1961FSM6LL	1960FSM6LL
1955FSM6L	6mm	6mm	1961FSM6L	1960FSM6LS
1955FSM8L	8mm	8mm	1961FSM8L	1960FSM8LS
1955FSM10L	10mm	10mm	1961FSM10L	1960FSM10LS
1955FSM12L	12mm	12mm	1961FSM12L	1960FSM12LS
1955FSM15L	15mm	15mm	1961FSM15L	1960FSM15L
1955FSM6S	6mm	6mm	1961FSM6S	1960FSM6LS
1955FSM8S	8mm	8mm	1961FSM8S	1960FSM8LS
1955FSM10S	10mm	10mm	1961FSM10S	1960FSM10LS
1955FSM12S	12mm	12mm	1961FSM12S	1960FSM12LS
1955FSM14S	14mm	14mm	1961FSM14S	1960FSM14S
1955FSM16S	16mm	16mm	1961FSM16S	1960FSM16S

**SWIVEL**

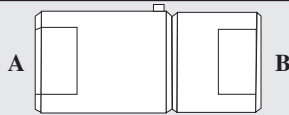
**59SP**
**Femelle NPTF / Femelle NPTF**  
**Female NPTF / Female NPTF**

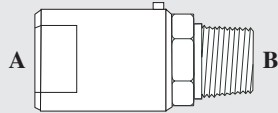
Numéro Part number	PSI	A (")	B (")	Ensemble Repair kit
59SP02X02	5000	1/8	1/8	59SKSS02
59SP04X04	5000	1/4	1/4	59SKSS04
59SP06X06	5000	3/8	3/8	59SKSS08
59SP08X08	5000	1/2	1/2	59SKSS08
59SP12X12	4500	3/4	3/4	59SKSS12
59SP16X16	4000	1	1	59SKSS16
59SP20X20	4000	1 1/4	1 1/4	59SKSS20
59SP24X24	4000	1 1/2	1 1/2	59SKSS24
59SP32X32	3000	2	2	59SKSS32

**59SS**
**Femelle NPTF / Mâle NPTF**  
**Female NPTF / Male NPTF**

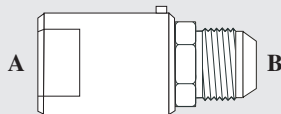
Numéro Part number	PSI	A (")	B (")	Ensemble Repair kit
59SS02X02	5000	1/8	1/8	59SKSS02
59SS04X04	5000	1/4	1/4	59SKSS04
59SS06X06	5000	3/8	3/8	59SKSS08
59SS08X08	5000	1/2	1/2	59SKSS08
59SS12X12	4500	3/4	3/4	59SKSS12
59SS16X16	4000	1	1	59SKSS16
59SS20X20	4000	1 1/4	1 1/4	59SKSS20
59SS24X24	4000	1 1/2	1 1/2	59SKSS24
59SS32X32	3000	2	2	59SKSS32

**59SL**
**Femelle NPTF / Mâle JIC**  
**Female NPTF / Male JIC**

Numéro Part number	PSI	A (")	B (")	Ensemble Repair kit
59SL04X06	5000	1/4	3/8	59SKSS04
59SL06X08	5000	3/8	1/2	59SKSS08
59SL08X08	5000	1/2	1/2	59SKSS08
59SL08X10	5000	1/2	5/8	59SKSS08
59SL12X12	4500	3/4	3/4	59SKSS12
59SL16X16	4000	1	1	59SKSS16
59SL20X20	4000	1 1/4	1 1/4	59SKSS20
59SL24X24	4000	1 1/2	1 1/2	59SKSS24

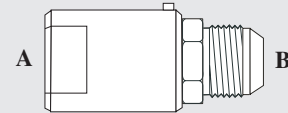
**59SX**
**Femelle JIC / Mâle JIC**  
**Female JIC / Male JIC**

Numéro Part number	PSI	A (")	B (")	Ensemble Repair kit
59SX04X04	5000	1/4	1/4	59SKSS04
59SX06X06	5000	3/8	3/8	59SKSS04
59SX08X08	5000	1/2	1/2	59SKSS08
59SX10X10	5000	5/8	5/8	59SKSS08
59SX12X12	4500	3/4	3/4	59SKSS12
59SX16X16	4000	1	1	59SKSS16
59SX20X20	4000	1 1/4	1 1/4	59SKSS20
59SX24X24	4000	1 1/2	1 1/2	59SKSS24

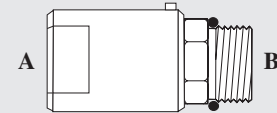

**59ST**
**Femelle NPTF / Mâle o'ring boss**  
**Female NPTF / Male o'ring boss**

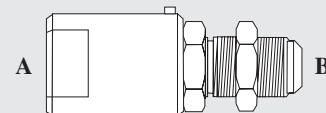
Numéro Part number	PSI	A (")	B (")	Ensemble Repair kit
59ST04X06	5000	1/4	3/8	59SKSS04
59ST06X08	5000	3/8	1/2	59SKSS08
59ST08X08	5000	1/2	1/2	59SKSS08
59ST08X10	5000	1/2	5/8	59SKSS08
59ST12X12	4500	3/4	3/4	59SKSS12
59ST16X16	4000	1	1	59SKSS16
59ST20X20	4000	1 1/4	1 1/4	59SKSS20
59ST24X24	4000	1 1/2	1 1/2	59SKSS24

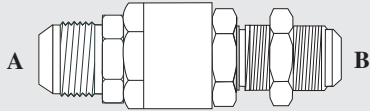

**59SXBH**
**Femelle JIC / Mâle JIC cloison**  
**Female JIC / Male JIC bulkhead**

Numéro Part number	PSI	A (")	B (")	Ensemble Repair kit
59SXBH08X08	5000	1/2	1/2	59SKSS08
59SXBH10X10	5000	5/8	5/8	59SKSS08
59SXBH12X12	4500	3/4	3/4	59SKSS12
59SXBH16X16	4000	1	1	59SKSS16
59SXBH20X20	4000	1 1/4	1 1/4	59SKSS20



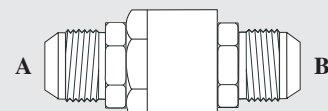

**59SJBH**
**Mâle JIC / Mâle JIC cloison**  
**Male JIC / Male JIC bulkhead**

Numéro Part number	PSI	A (")	B (")	Ensemble Repair kit
59SJBH08X08	5000	1/2	1/2	59SKSS08
59SJBH10X10	5000	5/8	5/8	59SKSS08
59SJBH12X12	4500	3/4	3/4	59SKSS12
59SJBH16X16	4000	1	1	59SKSS16
59SJBH20X20	4000	1 1/4	1 1/4	59SKSS20

**59SJ**
**Mâle JIC / Mâle JIC**  
**Male JIC / Male JIC**

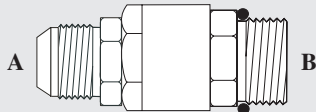
Numéro Part number	PSI	A (")	B (")	Ensemble Repair kit
59SJ04X04	5000	1/4	1/4	59SKSS04
59SJ06X06	5000	3/8	3/8	59SKSS04
59SJ08X08	5000	1/2	1/2	59SKSS08
59SJ10X10	5000	5/8	5/8	59SKSS08
59SJ12X12	4500	3/4	3/4	59SKSS12
59SJ16X16	4000	1	1	59SKSS16
59SJ20X20	4000	1 1/4	1 1/4	59SKSS20
59SJ24X24	4000	1 1/2	1 1/2	59SKSS24

**59SB**
**Mâle JIC / Mâle o'ring boss**  
**Male JIC / Male o'ring boss**

Numéro Part number	PSI	A (")	B (")	Ensemble Repair kit
59SB04X04	5000	1/4	1/4	59SKSS04
59SB06X06	5000	3/8	3/8	59SKSS04
59SB08X08	5000	1/2	1/2	59SKSS08
59SB08X10	5000	1/2	5/8	59SKSS08
59SB10X10	5000	5/8	5/8	59SKSS08
59SB12X12	4500	3/4	3/4	59SKSS12
59SB16X16	4000	1	1	59SKSS16
59SB20X20	4000	1 1/4	1 1/4	59SKSS20
59SB24X24	4000	1 1/2	1 1/2	59SKSS24

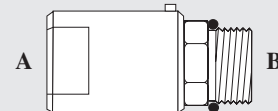
**59SZ**
**Femelle JIC / Mâle o'ring boss**  
**Female JIC / Male o'ring boss**

Numéro Part number	PSI	A (")	B (")	Ensemble Repair kit
59SZ06X06	5000	3/8	3/8	59SKSS04
59SZ08X08	5000	1/2	1/2	59SKSS08
59SZ10X10	5000	5/8	5/8	59SKSS08
59SZ12X12	4500	3/4	3/4	59SKSS12
59SZ16X16	4000	1	1	59SKSS16
59SZ20X20	4000	1 1/4	1 1/4	59SKSS20
59SZ24X24	4000	1 1/2	1 1/2	59SKSS24

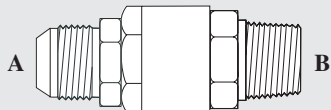

**59SA**
**Mâle JIC / Mâle NPTF**  
**Male JIC / Male NPTF**

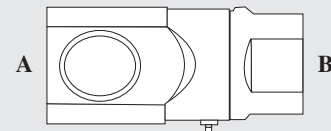
Numéro Part number	PSI	A (")	B (")	Ensemble Repair kit
59SA06X04	5000	3/8	1/4	59SKSS04
59SA06X06	5000	3/8	3/8	59SKSS04
59SA08X06	5000	1/2	3/8	59SKSS08
59SA08X08	5000	1/2	1/2	59SKSS08
59SA10X06	5000	5/8	3/8	59SKSS08
59SA10X08	5000	5/8	1/2	59SKSS08
59SA12X12	4500	3/4	3/4	59SKSS12
59SA16X16	4000	1	1	59SKSS16
59SA20X20	4000	1 1/4	1 1/4	59SKSS20
59SA24X24	4000	1 1/2	1 1/2	59SKSS24

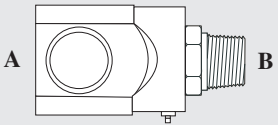
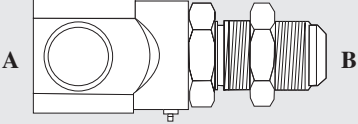
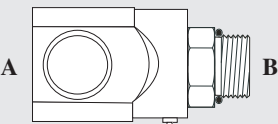
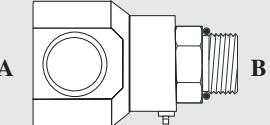
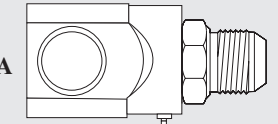
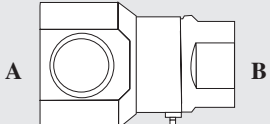

**59UP**
**Femelle NPTF / Femelle NPTF**  
**Female NPTF / Female NPTF**

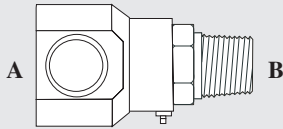
Numéro Part number	PSI	A (")	B (")	Ensemble Repair kit
59UP02X02	5000	1/8	1/8	59SKSS02
59UP04X04	5000	1/4	1/4	59SKSS04
59UP06X06	5000	3/8	3/8	59SKSS08
59UP08X08	5000	1/2	1/2	59SKSS08
59UP12X12	4500	3/4	3/4	59SKSS12
59UP16X16	4000	1	1	59SKSS16
59UP20X20	4000	1 1/4	1 1/4	59SKSS20
59UP24X24	4000	1 1/2	1 1/2	59SKSS24
59UP32X32	3000	2	2	59SKSS32

 <p><b>59US</b>                      Femelle NPTF / Mâle NPTF                      Female NPTF / Male NPTF</p>					Numéro Part number	PSI	A (")	B (")	Ensemble Repair kit					
					59UL12X12	4500	3/4	3/4	59SKSS12					
					59UL16X16	4000	1	1	59SKSS16					
					59UL20X20	4000	1 1/4	1 1/4	59SKSS20					
					59UL24X24	4000	1 1/2	1 1/2	59SKSS24					
 <p><b>59ULBH</b>                      Femelle NPTF / Mâle JIC cloison                      Female NPTF / Male JIC bulkhead</p>					Numéro Part number	PSI	A (")	B (")	Ensemble Repair kit					
					59ULBH06X08	5000	3/8	1/2	59SKSS08					
					59ULBH08X08	5000	1/2	1/2	59SKSS08					
					59ULBH06X10	5000	3/8	5/8	59SKSS08					
					59ULBH08X10	5000	1/2	5/8	59SKSS08					
					59ULBH12X12	4500	3/4	3/4	59SKSS12					
					59ULBH16X16	4000	1	1	59SKSS16					
					59ULBH20X20	4000	1 1/4	1 1/4	59SKSS20					
					 <p><b>59UT</b>                      Femelle NPTF / Mâle o'ring boss                      Female NPTF / Male o'ring boss</p>					Numéro Part number	PSI	A (")	B (")	Ensemble Repair kit
										59UT04X04	5000	1/4	1/4	59SKSS04
										59UT04X06	5000	1/4	3/8	59SKSS04
										59UT06X08	5000	3/8	1/2	59SKSS08
										59UT06X10	5000	3/8	5/8	59SKSS08
59UT08X08	5000	1/2	1/2	59SKSS08										
59UT08X10	5000	1/2	5/8	59SKSS08										
59UT12X12	4500	3/4	3/4	59SKSS12										
59UT16X16	4000	1	1	59SKSS16										
59UT20X20	4000	1 1/4	1 1/4	59SKSS20										
59UT24X24	4000	1 1/2	1 1/2	59SKSS24										
 <p><b>59UR</b>                      Femelle o'ring boss / Mâle o'ring boss                      Female o'ring boss / Male o'ring boss</p>										Numéro Part number	PSI	A (")	B (")	Ensemble Repair kit
										59UR06X04	5000	3/8	1/4	59SKSS04
					59UR06X06	5000	3/8	3/8	59SKSS04					
					59UR08X08	5000	1/2	1/2	59SKSS08					
					59UR08X10	5000	1/2	5/8	59SKSS08					
					59UR12X12	4500	3/4	3/4	59SKSS12					
					59UR16X16	4000	1	1	59SKSS16					
					59UR20X20	4000	1 1/4	1 1/4	59SKSS20					
					 <p><b>59UL</b>                      Femelle NPTF / Mâle JIC                      Female NPTF / Male JIC</p>					Numéro Part number	PSI	A (")	B (")	Ensemble Repair kit
										59UL04X04	5000	1/4	1/4	59SKSS04
										59UL04X06	5000	1/4	3/8	59SKSS04
										59UL06X08	5000	3/8	1/2	59SKSS08
										59UL06X10	5000	3/8	5/8	59SKSS08
59UL08X08	5000	1/2	1/2	59SKSS08										
59UL08X10	5000	1/2	5/8	59SKSS08										
 <p><b>59UO</b>                      Femelle o'ring boss / Femelle NPTF                      Female o'ring boss / Female NPTF</p>										Numéro Part number	PSI	A (")	B (")	Ensemble Repair kit
										59UO06X04	5000	3/8	1/4	59SKSS04
										59UO08X06	5000	1/2	3/8	59SKSS08
					59UO08X08	5000	1/2	1/2	59SKSS08					
					59UO12X12	4500	3/4	3/4	59SKSS12					
					59UO16X16	4000	1	1	59SKSS16					
					59UO20X20	4000	1 1/4	1 1/4	59SKSS20					

**59UQ**
**Femelle o'ring boss / Mâle NPTF**  
**Female o'ring boss / Male NPTF**

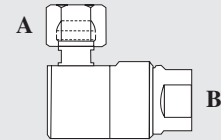
Numéro Part number	PSI	A (")	B (")	Ensemble Repair kit
59UQ06X04	5000	3/8	1/4	59SKSS04
59UQ06X06	5000	3/8	3/8	59SKSS04
59UQ08X06	5000	1/2	3/8	59SKSS08
59UQ08X08	5000	1/2	1/2	59SKSS08
59UQ12X12	4500	3/4	3/4	59SKSS12
59UQ16X16	4000	1	1	59SKSS16
59UQ20X20	4000	1 1/4	1 1/4	59SKSS20

**59UE**
**Femelle NPSM tournant / Femelle NPTF**  
**Female NPSM swivel / Female NPTF**

Numéro Part number	PSI	A (")	B (")	Ensemble Repair kit
59UE04X04	5000	1/4	1/4	59SKSS04
59UE06X04	5000	3/8	1/4	59SKSS04
59UE06X06	5000	3/8	3/8	59SKSS08
59UE08X08	5000	1/2	1/2	59SKSS08
59UE12X12	4500	3/4	3/4	59SKSS12
59UE16X16	4000	1	1	59SKSS16
59UE20X20	4000	1 1/4	1 1/4	59SKSS20
59UE24X24	4000	1 1/2	1 1/2	59SKSS24

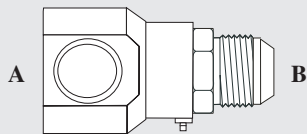
**59UI**
**Femelle o'ring boss / Mâle JIC**  
**Female o'ring boss / Male JIC**

Numéro Part number	PSI	A (")	B (")	Ensemble Repair kit
59UI06X04	5000	3/8	1/4	59SKSS04
59UI06X06	5000	3/8	3/8	59SKSS04
59UI08X08	5000	1/2	1/2	59SKSS08
59UI08X10	5000	1/2	5/8	59SKSS08
59UI12X12	4500	3/4	3/4	59SKSS12
59UI16X16	4000	1	1	59SKSS16
59UI20X20	4000	1 1/4	1 1/4	59SKSS20

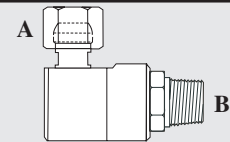
**59UC**
**Femelle NPSM tournant / Mâle NPTF**  
**Female NPSM swivel / Male NPTF**

Numéro Part number	PSI	A (")	B (")	Ensemble Repair kit
59UC04X04	5000	1/4	1/4	59SKSS04
59UC04X06	5000	1/4	3/8	59SKSS04
59UC06X04	5000	3/8	1/4	59SKSS04
59UC06X06	5000	3/8	3/8	59SKSS08
59UC08X08	5000	1/2	1/2	59SKSS08
59UC12X12	4500	3/4	3/4	59SKSS12
59UC16X16	4000	1	1	59SKSS16
59UC20X20	4000	1 1/4	1 1/4	59SKSS20
59UC24X24	4000	1 1/2	1 1/2	59SKSS24

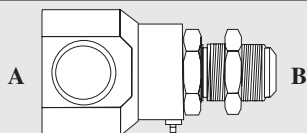

**59UIBH**
**Femelle o'ring boss / Mâle JIC cloison**  
**Female o'ring boss / Male JIC bulkhead**

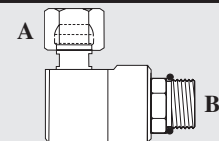
Numéro Part number	PSI	A (")	B (")	Ensemble Repair kit
59UIBH08X08	5000	1/2	1/2	59SKSS08
59UIBH08X10	5000	1/2	5/8	59SKSS08
59UIBH12X12	4500	3/4	3/4	59SKSS12
59UIBH16X16	4000	1	1	59SKSS16
59UIBH20X20	4000	1 1/4	1 1/4	59SKSS20

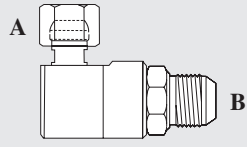
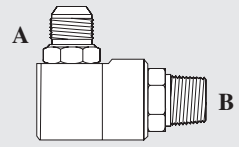
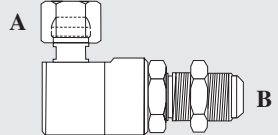
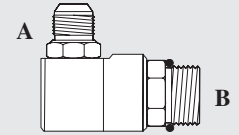
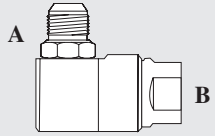
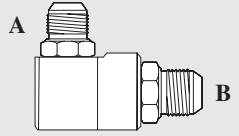

**59UD**
**Femelle NPSM tournant / Mâle o'ring boss**  
**Female NPSM swivel / Male o'ring boss**

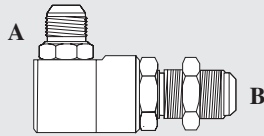
Numéro Part number	PSI	A (")	B (")	Ensemble Repair kit
59UD04X04	5000	1/4	1/4	59SKSS04
59UD04X06	5000	1/4	3/8	59SKSS04
59UD06X06	5000	3/8	3/8	59SKSS04
59UD06X08	5000	3/8	1/2	59SKSS08
59UD08X08	5000	1/2	1/2	59SKSS08
59UD08X10	5000	1/2	5/8	59SKSS08
59UD12X12	4500	3/4	3/4	59SKSS12
59UD16X16	4000	1	1	59SKSS16
59UD20X20	4000	1 1/4	1 1/4	59SKSS20
59UD24X24	4000	1 1/2	1 1/2	59SKSS24

									
<b>59UK</b> <b>Femelle NPSM tournant / Mâle JIC</b> <b>Female NPSM swivel / Male JIC</b>					<b>59UA</b> <b>Mâle JIC / Mâle NPTF</b> <b>Male JIC / Male NPTF</b>				
Numéro Part number	PSI	A (")	B (")	Ensemble Repair kit	Numéro Part number	PSI	A (")	B (")	Ensemble Repair kit
59UK04X04	5000	1/4	1/4	59SKSS04	59UA04X04	5000	1/4	1/4	59SKSS04
59UK04X06	5000	1/4	3/8	59SKSS04	59UA06X04	5000	3/8	1/4	59SKSS04
59UK06X06	5000	3/8	3/8	59SKSS04	59UA06X06	5000	3/8	3/8	59SKSS04
59UK06X08	5000	3/8	1/2	59SKSS08	59UA08X06	5000	1/2	3/8	59SKSS08
59UK08X08	5000	1/2	1/2	59SKSS08	59UA08X08	5000	1/2	1/2	59SKSS08
59UK08X10	5000	1/2	5/8	59SKSS08	59UA10X08	5000	5/8	1/2	59SKSS08
59UK12X12	4500	3/4	3/4	59SKSS12	59UA12X12	4500	3/4	3/4	59SKSS12
59UK16X16	4000	1	1	59SKSS16	59UA16X16	4000	1	1	59SKSS16
59UK20X20	4000	1 1/4	1 1/4	59SKSS20	59UA20X20	4000	1 1/4	1 1/4	59SKSS20
59UK24X24	4000	1 1/2	1 1/2	59SKSS24	59UA24X24	4000	1 1/2	1 1/2	59SKSS24
									
<b>59UKBH</b> <b>Femelle NPSM tournant / Mâle JIC cloison</b> <b>Female NPSM swivel / Male JIC cloison</b>					<b>59UB</b> <b>Mâle JIC / Mâle o'ring boss</b> <b>Male JIC / Male o'ring boss</b>				
Numéro Part number	PSI	A (")	B (")	Ensemble Repair kit	Numéro Part number	PSI	A (")	B (")	Ensemble Repair kit
59UKBH06X08	5000	3/8	1/2	59SKSS08	59UB04X04	5000	1/4	1/4	59SKSS04
59UKBH08X08	5000	1/2	1/2	59SKSS08	59UB06X06	5000	3/8	3/8	59SKSS04
59UKBH08X10	5000	1/2	5/8	59SKSS08	59UB08X08	5000	1/2	1/2	59SKSS08
59UKBH12X12	4500	3/4	3/4	59SKSS12	59UB10X10	5000	5/8	5/8	59SKSS08
59UKBH16X16	4000	1	1	59SKSS16	59UB12X12	4500	3/4	3/4	59SKSS12
59UKBH20X20	4000	1 1/4	1 1/4	59SKSS20	59UB16X16	4000	1	1	59SKSS16
					59UB20X20	4000	1 1/4	1 1/4	59SKSS20
					59UB24X24	4000	1 1/2	1 1/2	59SKSS24
									
<b>59UH</b> <b>Mâle JIC / Femelle NPTF</b> <b>Male JIC / Female NPTF</b>					<b>59UJ</b> <b>Mâle JIC / Mâle JIC</b> <b>Male JIC / Male JIC</b>				
Numéro Part number	PSI	A (")	B (")	Ensemble Repair kit	Numéro Part number	PSI	A (")	B (")	Ensemble Repair kit
59UH04X04	5000	1/4	1/4	59SKSS04	59UJ04X04	5000	1/4	1/4	59SKSS04
59UH06X04	5000	3/8	1/4	59SKSS04	59UJ06X06	5000	3/8	3/8	59SKSS06
59UH06X06	5000	3/8	3/8	59SKSS08	59UJ08X08	5000	1/2	1/2	59SKSS08
59UH08X06	5000	1/2	3/8	59SKSS08	59UJ10X10	5000	5/8	5/8	59SKSS08
59UH08X08	5000	1/2	1/2	59SKSS08	59UJ12X12	4500	3/4	3/4	59SKSS12
59UH10X08	5000	5/8	1/2	59SKSS08	59UJ16X16	4000	1	1	59SKSS16
59UH12X12	4500	3/4	3/4	59SKSS12	59UJ20X20	4000	1 1/4	1 1/4	59SKSS20
59UH16X16	4000	1	1	59SKSS16	59UJ24X24	4000	1 1/2	1 1/2	59SKSS24
59UH20X20	4000	1 1/4	1 1/4	59SKSS20					
59UH24X24	4000	1 1/2	1 1/2	59SKSS24					

**59UJBH**
**Mâle JIC / Mâle JIC cloison**  
**Male JIC / Male JIC bulkhead**

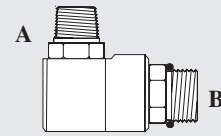
Numéro Part number	PSI	A (")	B (")	Ensemble Repair kit
59UJBH08X08	5000	1/2	1/2	59SKSS08
59UJBH10X10	5000	5/8	5/8	59SKSS08
59UJBH12X12	4500	3/4	3/4	59SKSS12
59UJBH16X16	4000	1	1	59SKSS16
59UJBH20X20	4000	1 1/4	1 1/4	59SKSS20

**59UV**
**Mâle NPTF / Mâle o'ring boss**  
**Male NPTF / Male o'ring boss**

Numéro Part number	PSI	A (")	B (")	Ensemble Repair kit
59UV04X04	5000	1/4	1/4	59SKSS04
59UV04X06	5000	1/4	3/8	59SKSS04
59UV06X06	5000	3/8	3/8	59SKSS04
59UV06X08	5000	3/8	1/2	59SKSS08
59UV06X10	5000	3/8	5/8	59SKSS08
59UV08X08	5000	1/2	1/2	59SKSS08
59UV08X10	5000	1/2	5/8	59SKSS08
59UV12X12	4500	3/4	3/4	59SKSS12
59UV16X16	4000	1	1	59SKSS16
59UV20X20	4000	1 1/4	1 1/4	59SKSS20
59UV24X24	4000	1 1/2	1 1/2	59SKSS24

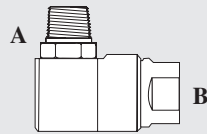
**59UF**
**Mâle NPTF / Femelle NPTF**  
**Male NPTF / Female NPTF**

Numéro Part number	PSI	A (")	B (")	Ensemble Repair kit
59UF04X04	5000	1/4	1/4	59SKSS04
59UF06X06	5000	3/8	3/8	59SKSS08
59UF06X08	5000	3/8	1/2	59SKSS08
59UF08X06	5000	1/2	3/8	59SKSS08
59UF08X08	5000	1/2	1/2	59SKSS08
59UF12X12	4500	3/4	3/4	59SKSS12
59UF16X16	4000	1	1	59SKSS16
59UF20X20	4000	1 1/4	1 1/4	59SKSS20
59UF24X24	4000	1 1/2	1 1/2	59SKSS24

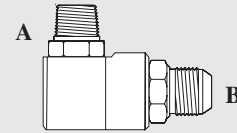
**59UN**
**Mâle NPTF / Mâle JIC**  
**Male NPTF / Male JIC**



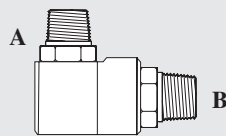

Numéro Part number	PSI	A (")	B (")	Ensemble Repair kit
59UN04X04	5000	1/4	1/4	59SKSS04
59UN04X06	5000	1/4	3/8	59SKSS04
59UN06X06	5000	3/8	3/8	59SKSS04
59UN06X08	5000	3/8	1/2	59SKSS08
59UN06X10	5000	3/8	5/8	59SKSS08
59UN08X08	5000	1/2	1/2	59SKSS08
59UN08X10	5000	1/2	5/8	59SKSS08
59UN12X12	4500	3/4	3/4	59SKSS12
59UN16X16	4000	1	1	59SKSS16
59UN20X20	4000	1 1/4	1 1/4	59SKSS20
59UN24X24	4000	1 1/2	1 1/2	59SKSS24

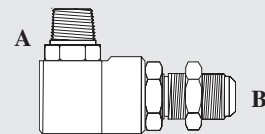
**59UG**
**Mâle NPTF / Mâle NPTF**  
**Male NPTF / Male NPTF**

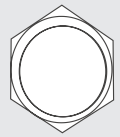
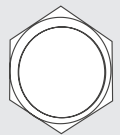

Numéro Part number	PSI	A (")	B (")	Ensemble Repair kit
59UG04X04	5000	1/4	1/4	59SKSS04
59UG06X04	5000	3/8	1/4	59SKSS04
59UG06X06	5000	3/8	3/8	59SKSS08
59UG06X08	5000	3/8	1/2	59SKSS08
59UG08X06	5000	1/2	3/8	59SKSS08
59UG08X08	5000	1/2	1/2	59SKSS08
59UG12X12	4500	3/4	3/4	59SKSS12
59UG16X16	4000	1	1	59SKSS16
59UG20X20	4000	1 1/4	1 1/4	59SKSS20
59UG24X24	4000	1 1/2	1 1/2	59SKSS24

**59UNBH**
**Mâle NPTF / Mâle JIC cloison**  
**Male NPTF / Male JIC bulkhead**





Numéro Part number	PSI	A (")	B (")	Ensemble Repair kit
59UNBH06X08	5000	3/8	1/2	59SKSS08
59UNBH08X08	5000	1/2	1/2	59SKSS08
59UNBH08X10	5000	1/2	5/8	59SKSS08
59UNBH12X12	4500	3/4	3/4	59SKSS12
59UNBH16X16	4000	1	1	59SKSS16
59UNBH20X20	4000	1 1/4	1 1/4	59SKSS20

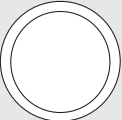

O'RING AND NUT	
	
<b>711FSO</b> Écrou cloison JIC-o'ring boss JIC-o'ring boss bulkhead nut	
Numéro Part number	Dimension Size
711FSO04	1/4
711FSO05	5/16
711FSO06	3/8
711FSO08	1/2
711FSO10	5/8
711FSO12	3/4
711FSO16	1
711FSO20	1-1/4
711FSO24	1-1/2
	
<b>711TTO</b> Écrou cloison o'ring face O'ring face bulkhead nut	
Numéro Part number	Dimension Size
711TTO04	1/4
711TTO06	3/8
711TTO08	1/2
711TTO10	5/8
711TTO12	3/4
711TTO16	1
711TTO20	1-1/4
711TTO24	1-1/2
	
<b>710FSO</b> O'ring ORB (o'ring boss)	
Numéro Part number	Dimension Size
710FSO01	1/16
710FSO02	1/8
710FSO03	3/16
710FSO04	1/4
710FSO05	5/16
710FSO06	3/8
710FSO07	7/16
710FSO08	1/2
710FSO10	5/8
710FSO12	3/4
710FSO14	7/8
710FSO16	1
710FSO20	1-1/4
710FSO24	1-1/2
710FSO32	2
	
<b>710FSM</b> O'ring (o'ring boss métrique) O'ring (metric o'ring boss)	
Numéro Part number	Dimension Size
710FSM08	8mm
710FSM10	10mm
710FSM12	12mm
710FSM14	14mm
710FSM16	16mm
710FSM18	18mm
	
<b>711BPO</b> Écrou cloison BSPP BSPP bulkhead nut	
Numéro Part number	Dimension Size
711BPO02	1/8
711BPO04	1/4
711BPO06	3/8
711BPO08	1/2
711BPO10	5/8
711BPO12	3/4
711BPO16	1
711BPO20	1-1/4
711BPO24	1-1/2
	
<b>710TTO</b> O'ring (o'ring face)	
Numéro Part number	Dimension Size
710TTO02	1/8
710TTO04	1/4
710TTO06	3/8
710TTO08	1/2
710TTO10	5/8

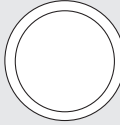
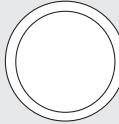

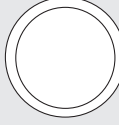
<table border="1"> <thead> <tr> <th>Numéro Part number</th> <th>Dimension Size</th> </tr> </thead> <tbody> <tr> <td>710TTO12</td> <td>3/4</td> </tr> <tr> <td>710TTO16</td> <td>1</td> </tr> <tr> <td>710TTO20</td> <td>1-1/4</td> </tr> <tr> <td>710TTO24</td> <td>1-1/2</td> </tr> </tbody> </table>	Numéro Part number	Dimension Size	710TTO12	3/4	710TTO16	1	710TTO20	1-1/4	710TTO24	1-1/2	 <p><b>PA77</b> O'ring bride PA-PH PA-PH flange o'ring</p> <table border="1"> <thead> <tr> <th>Numéro Part number</th> <th>Dimension Size</th> </tr> </thead> <tbody> <tr> <td>08PA77</td> <td>1/2</td> </tr> <tr> <td>12PA77</td> <td>3/4</td> </tr> <tr> <td>16PA77</td> <td>1</td> </tr> <tr> <td>20PA77</td> <td>1-1/4</td> </tr> <tr> <td>24PA77</td> <td>1-1/2</td> </tr> <tr> <td>32PA77</td> <td>2</td> </tr> </tbody> </table>	Numéro Part number	Dimension Size	08PA77	1/2	12PA77	3/4	16PA77	1	20PA77	1-1/4	24PA77	1-1/2	32PA77	2																										
Numéro Part number	Dimension Size																																																		
710TTO12	3/4																																																		
710TTO16	1																																																		
710TTO20	1-1/4																																																		
710TTO24	1-1/2																																																		
Numéro Part number	Dimension Size																																																		
08PA77	1/2																																																		
12PA77	3/4																																																		
16PA77	1																																																		
20PA77	1-1/4																																																		
24PA77	1-1/2																																																		
32PA77	2																																																		
<p><b>710ORO</b> O'ring pour bague de retenue BSPP BSPP retainer ring o'ring</p> <table border="1"> <thead> <tr> <th>Numéro Part number</th> <th>Dimension Size</th> </tr> </thead> <tbody> <tr> <td>710ORO02</td> <td>1/8</td> </tr> <tr> <td>710ORO04</td> <td>1/4</td> </tr> <tr> <td>710ORO06</td> <td>3/8</td> </tr> <tr> <td>710ORO08</td> <td>1/2</td> </tr> <tr> <td>710ORO10</td> <td>5/8</td> </tr> <tr> <td>710ORO12</td> <td>3/4</td> </tr> <tr> <td>710ORO16</td> <td>1</td> </tr> <tr> <td>710ORO20</td> <td>1-1/4</td> </tr> <tr> <td>710ORO24</td> <td>1-1/2</td> </tr> </tbody> </table>	Numéro Part number	Dimension Size	710ORO02	1/8	710ORO04	1/4	710ORO06	3/8	710ORO08	1/2	710ORO10	5/8	710ORO12	3/4	710ORO16	1	710ORO20	1-1/4	710ORO24	1-1/2	 <p><b>PA77V</b> O'ring bride PA-PH (viton) PA-PH flange o'ring (viton)</p> <table border="1"> <thead> <tr> <th>Numéro Part number</th> <th>Dimension Size</th> </tr> </thead> <tbody> <tr> <td>08PA77V</td> <td>1/2</td> </tr> <tr> <td>12PA77V</td> <td>3/4</td> </tr> <tr> <td>16PA77V</td> <td>1</td> </tr> <tr> <td>20PA77V</td> <td>1-1/4</td> </tr> <tr> <td>24PA77V</td> <td>1-1/2</td> </tr> <tr> <td>32PA77V</td> <td>2</td> </tr> </tbody> </table>	Numéro Part number	Dimension Size	08PA77V	1/2	12PA77V	3/4	16PA77V	1	20PA77V	1-1/4	24PA77V	1-1/2	32PA77V	2																
Numéro Part number	Dimension Size																																																		
710ORO02	1/8																																																		
710ORO04	1/4																																																		
710ORO06	3/8																																																		
710ORO08	1/2																																																		
710ORO10	5/8																																																		
710ORO12	3/4																																																		
710ORO16	1																																																		
710ORO20	1-1/4																																																		
710ORO24	1-1/2																																																		
Numéro Part number	Dimension Size																																																		
08PA77V	1/2																																																		
12PA77V	3/4																																																		
16PA77V	1																																																		
20PA77V	1-1/4																																																		
24PA77V	1-1/2																																																		
32PA77V	2																																																		
 <p><b>710ORM</b> O'ring pour bague de retenue métrique Metric retainer ring o'ring</p> <table border="1"> <thead> <tr> <th>Numéro Part number</th> <th>Dimension Size</th> </tr> </thead> <tbody> <tr> <td>710ORM08</td> <td>8mm</td> </tr> <tr> <td>710ORM10</td> <td>10mm</td> </tr> <tr> <td>710ORM12</td> <td>12mm</td> </tr> <tr> <td>710ORM14</td> <td>14mm</td> </tr> <tr> <td>710ORM16</td> <td>16mm</td> </tr> <tr> <td>710ORM18</td> <td>18mm</td> </tr> <tr> <td>710ORM20</td> <td>20mm</td> </tr> <tr> <td>710ORM22</td> <td>22mm</td> </tr> <tr> <td>710ORM24</td> <td>24mm</td> </tr> <tr> <td>710ORM26</td> <td>26mm</td> </tr> <tr> <td>710ORM27</td> <td>27mm</td> </tr> <tr> <td>710ORM30</td> <td>30mm</td> </tr> <tr> <td>710ORM33</td> <td>33mm</td> </tr> <tr> <td>710ORM36</td> <td>36mm</td> </tr> </tbody> </table>	Numéro Part number	Dimension Size	710ORM08	8mm	710ORM10	10mm	710ORM12	12mm	710ORM14	14mm	710ORM16	16mm	710ORM18	18mm	710ORM20	20mm	710ORM22	22mm	710ORM24	24mm	710ORM26	26mm	710ORM27	27mm	710ORM30	30mm	710ORM33	33mm	710ORM36	36mm	 <p><b>710RRO</b> Bague de retenue BSPP BSPP retainer ring</p> <table border="1"> <thead> <tr> <th>Numéro Part number</th> <th>Dimension Size</th> </tr> </thead> <tbody> <tr> <td>710RRO02</td> <td>1/8</td> </tr> <tr> <td>710RRO04</td> <td>1/4</td> </tr> <tr> <td>710RRO06</td> <td>3/8</td> </tr> <tr> <td>710RRO08</td> <td>1/2</td> </tr> <tr> <td>710RRO10</td> <td>5/8</td> </tr> <tr> <td>710RRO12</td> <td>3/4</td> </tr> <tr> <td>710RRO16</td> <td>1</td> </tr> <tr> <td>710RRO20</td> <td>1-1/4</td> </tr> <tr> <td>710RRO24</td> <td>1-1/2</td> </tr> </tbody> </table>	Numéro Part number	Dimension Size	710RRO02	1/8	710RRO04	1/4	710RRO06	3/8	710RRO08	1/2	710RRO10	5/8	710RRO12	3/4	710RRO16	1	710RRO20	1-1/4	710RRO24	1-1/2
Numéro Part number	Dimension Size																																																		
710ORM08	8mm																																																		
710ORM10	10mm																																																		
710ORM12	12mm																																																		
710ORM14	14mm																																																		
710ORM16	16mm																																																		
710ORM18	18mm																																																		
710ORM20	20mm																																																		
710ORM22	22mm																																																		
710ORM24	24mm																																																		
710ORM26	26mm																																																		
710ORM27	27mm																																																		
710ORM30	30mm																																																		
710ORM33	33mm																																																		
710ORM36	36mm																																																		
Numéro Part number	Dimension Size																																																		
710RRO02	1/8																																																		
710RRO04	1/4																																																		
710RRO06	3/8																																																		
710RRO08	1/2																																																		
710RRO10	5/8																																																		
710RRO12	3/4																																																		
710RRO16	1																																																		
710RRO20	1-1/4																																																		
710RRO24	1-1/2																																																		



 <b>710RRM</b> Bague de retenue métrique Metric retainer ring		Numéro Part number	Dimension Size
		710BSM10 710BSM12 710BSM14 710BSM16 710BSM18 710BSM20 710BSM22 710BSM24 710BSM26 710BSM27 710BSM30 710BSM33 710BSM36 710BSM42 710BSM52	10mm 12mm 14mm 16mm 18mm 20mm 22mm 24mm 26mm 27mm 30mm 33mm 36mm 42mm 52mm
Numéro Part number	Dimension Size	 <b>712BSP</b> Rondelle de cuivre BSPP BSPP copper washer	
710RRM08 710RRM10 710RRM12 710RRM14 710RRM16 710RRM18 710RRM20 710RRM22 710RRM24 710RRM26 710RRM27 710RRM30 710RRM33 710RRM36	8mm 10mm 12mm 14mm 16mm 18mm 20mm 22mm 24mm 26mm 27mm 30mm 33mm 36mm		
 <b>710BSB</b> Joint étanche BSPP Bonded seal BSPP		Numéro Part number	Dimension Size
		712BSP02 712BSP04 712BSP06 712BSP08 712BSP10 712BSP12 712BSP16 712BSP20 712BSP24 712BSP32	1/8 1/4 3/8 1/2 5/8 3/4 1 1-1/4 1-1/2 2
Numéro Part number	Dimension Size	 <b>712MET</b> Rondelle de cuivre métrique Metric copper washer	
710BSB02 710BSB04 710BSB06 710BSB08 710BSB10 710BSB12 710BSB16 710BSB20 710BSB24 710BSB32	1/8 1/4 3/8 1/2 5/8 3/4 1 1-1/4 1-1/2 2		
 <b>710BSM</b> Joint étanche métrique Bonded seal metric		Numéro Part number	Dimension Size
		712MET08 712MET10 712MET12 712MET14 712MET16 712MET18 712MET22 712MET26	8mm 10mm 12mm 14mm 16mm 18mm 22mm 26mm
Numéro Part number	Dimension Size	710BSM06 710BSM08	
		6mm 8mm	

 <b>KITSEAL</b> Ensembles de joints étanches O'ring kit		Numéro Part number																			
		<table border="1"> <thead> <tr> <th>Numéro Part number</th> <th>Description</th> </tr> </thead> <tbody> <tr> <td>KITSEAL1</td> <td>Bonded seal (157 pcs)</td> </tr> <tr> <td>KITSEAL2</td> <td>O'ring et / and retaining ring (100 pcs)</td> </tr> <tr> <td>KITSEAL3</td> <td>O'ring boss et / and o'ring face (175 pcs)</td> </tr> </tbody> </table>		Numéro Part number	Description	KITSEAL1	Bonded seal (157 pcs)	KITSEAL2	O'ring et / and retaining ring (100 pcs)	KITSEAL3	O'ring boss et / and o'ring face (175 pcs)										
Numéro Part number	Description																				
KITSEAL1	Bonded seal (157 pcs)																				
KITSEAL2	O'ring et / and retaining ring (100 pcs)																				
KITSEAL3	O'ring boss et / and o'ring face (175 pcs)																				
 <b>PA</b> Bride (code 61) Flange (code 61)																					
<table border="1"> <thead> <tr> <th>Numéro Part number</th> <th>Dimension (" Size ("</th> </tr> </thead> <tbody> <tr> <td>08PA</td> <td>1/2</td> </tr> <tr> <td>12PA</td> <td>3/4</td> </tr> <tr> <td>16PA</td> <td>1</td> </tr> <tr> <td>20PA</td> <td>1-1/4</td> </tr> <tr> <td>24PA</td> <td>1-1/2</td> </tr> <tr> <td>32PA</td> <td>2</td> </tr> </tbody> </table>		Numéro Part number	Dimension (" Size ("	08PA	1/2	12PA	3/4	16PA	1	20PA	1-1/4	24PA	1-1/2	32PA	2						
Numéro Part number	Dimension (" Size ("																				
08PA	1/2																				
12PA	3/4																				
16PA	1																				
20PA	1-1/4																				
24PA	1-1/2																				
32PA	2																				
 <b>PH</b> Bride (code 62) Flange (code 62)																					
<table border="1"> <thead> <tr> <th>Numéro Part number</th> <th>Dimension (" Size ("</th> </tr> </thead> <tbody> <tr> <td>08PH</td> <td>1/2</td> </tr> <tr> <td>12PH</td> <td>3/4</td> </tr> <tr> <td>16PH</td> <td>1</td> </tr> <tr> <td>20PH</td> <td>1-1/4</td> </tr> <tr> <td>24PH</td> <td>1-1/2</td> </tr> <tr> <td>32PH</td> <td>2</td> </tr> </tbody> </table>		Numéro Part number	Dimension (" Size ("	08PH	1/2	12PH	3/4	16PH	1	20PH	1-1/4	24PH	1-1/2	32PH	2	<table border="1"> <thead> <tr> <th colspan="2">Numéro Part number</th> </tr> </thead> <tbody> <tr> <td colspan="2"></td> </tr> </tbody> </table>		Numéro Part number			
Numéro Part number	Dimension (" Size ("																				
08PH	1/2																				
12PH	3/4																				
16PH	1																				
20PH	1-1/4																				
24PH	1-1/2																				
32PH	2																				
Numéro Part number																					

## INDEX

# PIÈCE PART #	PAGE	# PIÈCE PART #	PAGE	# PIÈCE PART #	PAGE
1942FS	57	59UD	63	632FS	30
1942FSM	59	59UE	63	639FS	29
1946FS	57	59UF	65	639FSJ	29
1948FS	57	59UG	65	639FSK	39
1948FSM	59	59UH	64	639FSM	38
1949FS	58	59UI	63	639FSMO	38
1949FSM	59	59UIBH	63	639FSMR	38
1954FS	58	59UJ	64	639FSR	29
1955FS	58	59UJBH	65	63SB	52
1955FSM	59	59UK	64	63SE	52
1960FS	57	59UKBH	64	63SF	52
1960FSM	58	59UL	62	63TA	51
1961FS	57	59ULBH	62	63TB	53
1961FSM	58	59UN	65	63TE	53
24SA	2	59UNBH	65	63TF	53
24SB	1	59UO	62	63UA	51
24SF	1	59UP	61	63UB	53
24SG	2	59UQ	63	63UC	51
24SJ	2	59UR	62	63UE	53
24SR	1	59US	62	63UF	54
24ST	1	59UT	62	642FS	30
25SP	1	59UV	65	642FSJ	30
25TA	3	60SA	5	642FSK	39
25TG	2	60SB	7	642FSM	39
25TJ	3	60SG	5	644FS	33
25UA	3	60TA	6	646FS	35
25UASW	4	60TB	8	646FSM	36
25UG	3	60TG	6	646FSO	37
25UGSW	3	60UA	6	646TT	36
25UJ	3	60UB	8	648FS	34
25VA	5	60UC	6	648FSM	36
25VC	4	60UG	7	648FSO	37
25VG	4	60VC	7	648TT	36
25VJ	4	60VH	7	649FS	36
25VK	4	60VJ	7	649TT	37
25VT	4	618TT	40	64SB	55
25WJ	5	619TT	41	64SF	56
579FS	57	61SA	5	64TA	55
589FS	56	61TA	52	64TB	56
59SA	61	61UA	52	64TF	56
59SB	61	622FS	41	64UA	55
59SJ	61	623FSO	40	64UB	56
59SJBH	61	626FS	41	64UC	55
59SL	60	626FSO	40	64UF	56
59SP	60	628FS	41	655FS	32
59SS	60	62TA	54	655FSA	32
59ST	60	62TD	54	656FSA	32
59SX	60	62UA	55	661FS	33
59SXBH	60	62UD	55	670FS	33
59SZ	61	630FS	29	671FS	34
59UA	64	630FSJ	29	672FS	34
59UB	64	630FSK	39	673FS	34
59UC	63	630FSM	37	673FSSW	34

## INDEX

# PIÈCE PART #	PAGE	# PIÈCE PART #	PAGE	# PIÈCE PART #	PAGE
674FS	32	836FS	29	849FSO	21
675FS	33	839FS	8	849LFS	16
677FS	34	839TT	42	849LFSO	21
679FS	33	840FS	9	849LLFS	16
679FSB	33	841FS	9	849LLFSO	21
680FS	31	841TT	42	849TT	46
680FSM	39	842FS	10	849TTO	48
680FSSW	31	842TT	42	850FS	17
681FS	35	844FS	12	850FSB	25
681FSM	36	844TT	44	851FS	18
681FSO	37	845FS	17	851FSB	26
681FSSW	35	845FSB	26	851FSO	22
682FS	35	845FSO	21	851TTO	48
683FS	30	845TTO	48	852FS	13
683FSMH	40	846FS	14	852TT	45
683FSML	39	846FSB	24	853FS	18
683FSMS	40	846FSBSW	24	854BHFS	11
683FSSW	31	846FSH	24	854BHTT	43
698FS	32	846FSHSW	25	854FS	15
699FS	32	846FSJ	24	854FSB	25
710BSB	68	846FSK	28	854FSO	20
710BSM	68	846FSMH	28	854TT	46
710FSM	66	846FSML	27	854TTO	47
710FSO	66	846FSV	22	855BHFS	11
710ORM	67	846TT	46	855BHTT	44
710ORO	67	846TTJ	22	855FS	11
710RRM	68	846TTJSW	22	855TT	43
710RRO	67	846TTO	47	856FS	11
710TTO	66	847FS	15	857FS	18
711BPO	66	848BHFS	14	858FS	18
711FSO	66	848FS	13	859FS	19
711TTO	66	848FSB	23	860FS	18
712BSP	68	848FSBJ	23	861FS	12
712MET	68	848FSBL	23	861TT	44
719FSO	48	848FSBLL	24	862FS	19
720FSO	50	848FSJ	24	863FS	19
721FSO	49	848FSK	27	870FS	12
722FSO	50	848FSKB	27	870TT	44
723FSO	49	848FSM	26	871FS	12
725FSO	51	848FSMH	27	871TT	44
725LFSO	51	848FSML	26	872FS	13
726FSO	50	848FSO	19	872TT	45
728FSO	50	848FSV	22	873FS	13
729FSO	51	848LFS	14	875FS	12
742FSO	49	848LFSO	20	877FS	17
755FSO	49	848LLFS	14	878FS	17
779FSO	49	848LTTO	47	878FSB	26
780FSO	49	848TT	45	878FSO	20
830FS	8	848TTJ	22	878TTO	47
830TT	42	848TTO	46	879FS	11
832FS	10	849FS	16	879TT	44
832TT	43	849FSB	25	880FS	10
835FS	28	849FSM	28	880TT	43

## INDEX

# PIÈCE PART #	PAGE	# PIÈCE PART #	PAGE	# PIÈCE PART #	PAGE
881FS	15				
881FSB	25				
881FSM	28				
881FSO	20				
881TT	45				
881TTJ	23				
881TTO	47				
882FS	15				
882FSB	25				
882TT	45				
883FS	9				
883FSSW	10				
883TT	42				
883TTR	42				
889FS	11				
889TT	43				
KITSEAL	69				
PA	54 et 69				
PA77	67				
PA77V	67				
PH	54 et 69				