



**VELVAC**®  
*In the Passing Lane Since 1934*

## QUALITY DRIVEN COMPONENTS SINCE 1934



### WHATEVER YOU DRIVE, WE'VE GOT YOU COVERED.

Velvac products support a wide range of medium and heavy duty commercial vehicles, from Class 8 over the road haulers to RVs, buses, fire trucks, ambulances, walk-in vans, refuse and fleet vehicles.

Our mission is to improve driver safety and well being by offering superior products and solutions that fully satisfy our customers needs, making us better, faster and easier to do business with.

Our ability to design and produce cost effective, differentiated vision systems and components to automotive quality and appearance levels sets us apart from other companies in the industry, keeping us... *in the passing lane.*

### HELPFUL HINTS

*Throughout this catalog, there are many useful tips and tricks to assist you in selecting the right products for your vehicle, as well as ensuring that you're compliant with important specifications and regulations.*

**NOTE: Part numbers listed in RED are NEW!**

### THE VELVAC STORY

The Vacuum Power Equipment Company opened for business in 1934, beginning a long tradition of quality manufacturing and focused customer service. In 1940 the corporate name was changed to "Velvac" to encompass its popular *Velvet Vacuum Brakes* brand. Today, our product line has expanded considerably to over 4,500 vehicle components.

As a leading supplier to the heavy truck aftermarket, medium and heavy duty truck OEMs, recreational vehicle and specialty vehicle markets, Velvac continually upgrades and expands its operations. Consistently improving our quality systems helps us exceed our customers' expectations while developing and manufacturing innovative new products that remain in front of an ever-changing market place.

We strive to make doing business with us easy. Experienced, friendly customer and technical solutions personnel team up with knowledgeable sales staff to answer questions and simplify your ordering process. Our B2B website allows customers access to account information 24/7, including order tracking details and order upload capabilities. EDI, data file transfers, advanced ship notices and a host of other services round out the technological support Velvac provides to meet a wide variety of customer requirements.

Velvac is a TS 16949 and ISO 14001 certified, multi-national company with corporate offices and primary warehouse in New Berlin, Wisconsin and a full-line manufacturing and assembly facility in Reynosa, Mexico. Well-stocked remote warehouses strategically located in California, Texas and Ontario, Canada ensure fast delivery of popular items anywhere in North America.



New Berlin headquarters



Reynosa facility

- Founded in 1934
- Leading supplier of heavy truck aftermarket products
- TS 16949 & ISO 14001 certified
- LIKE us on Facebook   
[facebook.com/velvacinc](https://facebook.com/velvacinc)



Call the Velvac Sales Team: **800.783.8871** [sales@velvac.com](mailto:sales@velvac.com)

## TABLE OF CONTENTS

### MIRRORS

All Makes	M2-31
West Coast	M2-10
Convex Mirrors	M11-13
Convex Mirror Heads	M14-17
Mirror Accessories	M18-19
Safety Mirrors	M20
Wide Angle Mirrors	M21-22
Class A, RV, Bus & Truck	M23-24
Hood Mount Mirrors	M25-27
Rear Cross View Mirrors	M28-29
Walk-In Mirrors	M29
Van & Cab Chassis Mirrors	M30
Truck & Trailer Mirrors	M31
Caterpillar	M32
E-One	M33-34
Ferrara	M35-36
Ford	M37-50
Freightliner	M51-60
GM	M61-68
GMC	M69
Hino	M70-73
HME	M74-75
International	M76-105
Kenworth	M105
KME	M106-109
Peterbilt	M110
Pierce	M111-114
Seagrave	M115-118
Spartan	M119-120
Sprinter	M121
Sutphen	M122-123
USPS	M124
Volvo	M125-127
Western Star	M127
2020 Mirror Replacement Parts	M128-129
Brackets, Clamps & Accessories	M130-132

### VISION SYSTEMS

Camera Systems	V2
Cameras	V3-5
Monitors	V6-7
Cables	V7
Camera Kits	V8
DVR Systems	V9-10
5th Wheel Dual Camera	V11
Aero Cam Vision System	V12-13
Road-iQ Vision System	V14-16

### HOSE SUPPORT

Hose & Cable Support Accessories	H2-3
Pogo Sticks	H3-4

### AIR PRODUCTS

Gladhands	A2-4
Air Brake Hose & Tubing	A5-7
Air/Electrical Assemblies	A7
Coiled Nylon Tubing	A8
Glacier Air Lines	A9
Air Brake Hose & Tubing	A10
Air Brake Valves	A11-17
Air Accessory Valves	A17-23
Pressure Switches & Indicators	A24
Air Tank Accessories	A25-26
Slack Adjusters	A26
Tanks, Brake Chambers & Diaphragms	A27
Air Cylinder Control Valves	A28-29
Air Cylinders	A29-31
Air Cylinder Tailgate Lock Kits	A32
Lift Axel & Suspension Valves	A33-34

### ELECTRICAL PRODUCTS

Cable & Plug Assemblies	E2
7-Way Coiled Cable Assemblies	E3
Electrical Plugs	E4
Plug Adapters & Accessories	E5
Electrical Sockets & Accessories	E6-7
Electrical Cable	E8
Battery Cable	E9
Battery Lugs	E10
Battery Terminals	E11-13
Switches & Solenoids	E14-18
Relays	E18
Signal Flashers	E19
Circuit Breakers	E20
Fuses & Accessories	E21-23
Terminals & Connectors	E24-30
Primary Wire & Accessories	E31-32
Heat-Shrink Tubing	E33-34
Tie Straps, Grommets & Wire Clips	E34-35
Shop Tools & Accessories	E36-37

### FITTINGS & HARDWARE

Push-Lock Air Brake Fittings	FH2-4
Brass Push-Lock Air Brake Fittings	FH4-5
Nylon Air Brake Tube Fittings	FH5-7
Air Brake Compression Fittings	FH7-8
Re-usable Air Hose Fittings	FH8-9
Clamping Studs	FH10
Discharge Hose Fittings	FH10
Fuller Trans. Compression Fittings	FH11
Inverted Flare Fittings	FH11
Pipe Fittings	FH12-13
SAE 45° Fittings	FH14-15
Truck & Trailer Repair Kits	FH15-16
Fitting Assortments	FH17-18
Hose Clamps & Coolant Valves	FH19-23
Clevis & Clevis Pins	FH24-25

### FUEL SYSTEMS

Aluminum Non-Locking Fuel Caps	F2-3
Gas/Diesel Fuel Caps	F4
Replacement Parts for Caps	F5
Anti-Siphon Tubes	F5
Fuel Tank Valves	F6
Return Flow Splitters	F6
Diesel Fuel Valves	F6
Electric Fuel Tank Selector Valves	F7
Fuel Tank Safety Vents	F7
Fuel Tank Valves	F8
Adapter Kits	F8

### BACK-UP ALARMS

Horn Style Alarms	B2
Speaker Style Alarms	B3
Back-up Alarms & Warning Devices	B4

### ACCESSORIES

Wiper Blades	AC2-3
Tarp Straps	AC3
Emergency Triangle	AC4
King Pin Lock	AC4
Mechanics Wire	AC4
Document Holders	AC5
Radiator Caps	AC6-7
Conspicuity Tape	AC7

### RETAIL MERCHANDISING

Displays with Product	
Assortments	R2-4
Fittings Display Racks	R5-6
Bucket & Counter Boxes	R6-7
Hose Clamp & Air Hose Racks	R7-8
Floor Displays	R9
Floor Displays & Racks	R10

### INDEX

Index Section	X1-19
---------------	-------

#### NOTE:

The information and photographs in this catalog are believed to be accurate and factual as of the print date. Velvac assumes no responsibility for information that may be incorrect or has changed since press time. Product specifications and offerings subject to change without notice.



## What's your Road-iQ?

Create your own Wi-Fi hot spot and record up to seven cameras!

**VideoData Server**  
Smarter. Safer. Connected. **VDS**  
6 Channel + 1 VideoData Server System

The open road will never be the same with the introduction of Velvac's **Road-iQ VideoData Server** — the most innovative connected vehicle technology available today. Adding Wi-Fi, reducing blind spots, enhancing safety, while providing peace-of-mind. Now *that is smart!*



road-iq.com



Call the Velvac Sales Team: **800.783.8871** sales@velvac.com



**OUR PARTS PUT YOU IN THE PASSING LANE**

# MIRRORS

## **See clearly.**

A combination of quality, styling and performance make Velvac mirrors the benchmark for medium and heavy duty commercial, recreational and specialty vehicles. Our mirrors reduce blind spots and provide clear views of passing lanes, making you a safer, more efficient driver.

- **West coast and mini-LEM mirrors**
- **Blind spot, accessory, chassis mirrors**
- **OEM replacement mirrors**



## ALL MAKES

### West Coast Mirrors

- Velvac's 2010 west coast mirror offers the widest viewing area available!
- Larger glass 2010 mirrors feature over 106 square inch viewing area
- Designed to fit any standard 17½" span loop
- Replaceable ⅛" FSC mirror glass
- 4 amp, temperature-controlled heating element provides quick, even defrosting and prevents mirror glass from overheating
- Polished 300 series stainless steel outer shell and heavy-duty ABS plastic inner housing combine to ensure durability and good looks
- Optional marker light provides additional safety by indicating the widest point of the vehicle to oncoming drivers
- Mounting hardware included



- Remote models also include a momentary motor switch

### Remote 2010 Mirror Features

- Heavy-duty, 1.5 RPM motor for fast, smooth adjustments
- Sealed motor housing for protection against moisture and contaminants
- Automatic slip clutch for manual adjustments without gear damage
- Interchangeable wire harness allows for convenient retro-fitting



### Mirrors with 10' Wire Harness and Heater Switch

Left Part #	Right Part #	M/R	Heat	Light
708209	708210	Manual	•	-
708211	708212	Remote	•	-
708369	708368	Remote	•	•

### Mirrors without Harness or Switches

Left Part #	Right Part #	M/R	Heat
708209-4	-	Manual	•
708211-4	708212-4	Remote	•

### Replacement Parts

Part #	Description
709309	Heated glass w/ bezel
709329	Motor
747386	Lighted heater switch
747387	Momentary motor switch
747451	4 Conductor harness, 124"



Call the Velvac Sales Team: **800.783.8871** sales@velvac.com



## 7" x 16" V-back Mirrors

- Popular V-back design available in three different versions to meet any requirement or price point
- Over 96 square inches of viewing area
- Comes as stainless steel or painted versions, all with 5/16" hardware



### Good

- Cost effective mirror for high replacement application
- Gasket surrounds silvered glass for durability and edge shock protection
- Glass not replaceable
- Standard painted finish
- Plated hardware
- Individually packaged in display box



### Better

- Cost effective version of OEM mirror
- Gasket surrounds silvered glass for durability and edge shock protection
- Front surface chrome glass used on heated mirrors
- Replaceable glass
- Housing is powder coated to meet OEM requirements
- Plated hardware
- Individually packaged in display box



### Best

- Popular replacement mirror for several OE applications
- HD support bands and gasket surround the front surface chrome glass for added strength and durability
- Replaceable glass
- Housing is powder coated to meet OEM requirements
- All stainless steel hardware
- Individually packaged

Part #	Color	Heat
705114	Black	-
705115	Black	•
705116	White	-
705112	Stainless steel	-
705113	Stainless steel	•

Part #	Color	Heat
708001	Black	-
708005	Stainless steel	-
708008	Stainless steel	•

Part #	Color	Heat
708020	White	-
708022	Stainless steel	-
708046	Stainless steel	•

### Flat Glass Kit

Part #	Heat
702044	-
702045	•

### Flat Glass Kit

Part #	Heat
702042	-
702047	•



# MIRRORS

## ALL MAKES

### West Coast Mirrors

- Designed with 1/8" silvered glass and 5/16" - 18 plated hardware. Mounting fasteners are included
- All west coast mirrors are packaged in a display box except the economy angle back mirrors



Angle back round corner - full flat or split glass

Angle back square corner

### Angle Back - Round Corner

Part #	Size	Description	Color	Flat Glass / Convex Glass Area (in <sup>2</sup> )
705333	7" x 16"	Standard glass	Stainless steel	93
705335	7" x 16"	Heated glass	Stainless steel	93
708331	7" x 16"	Heated w/ marker light	Stainless steel	93
705334	7" x 16"	Split glass	Stainless steel	64 Flat / 36 Convex

### Angle Back - Square Corner

Part #	Size	Description	Color	Flat Glass / Convex Glass Area (in <sup>2</sup> )
708526	7" x 16"	Standard glass	Stainless steel	99
708525	7" x 16"	Heated glass	Stainless steel	99
705332	7" x 16"	Heated w/ marker light	Stainless steel	99
705108	6 1/2" x 16"	Heated w/ marker light	Stainless steel	84

### Pillow Back

Part #	Size	Description	Color	Flat Glass / Convex Glass Area (in <sup>2</sup> )
705101	6 1/2" x 16"	Standard glass	Black	81
705102	6 1/2" x 16"	Standard glass	Stainless steel	81
705103	6 1/2" x 16"	Standard glass	White	81



Call the Velvac Sales Team: **800.783.8871** [sales@velvac.com](mailto:sales@velvac.com)

© VELVAC INC. • 2405 South Calhoun Road • New Berlin, WI 53151-2709 • Toll Free: 800.783.8871 • Fax: 262.786.4101

#### Rib Back

Part #	Size	Description	Color	Flat Glass / Convex Glass Area (in <sup>2</sup> )
705104	6½" x 16"	Standard glass	Black	88
705117	6½" x 16"	Heated glass	Black	88
705105	6½" x 16"	Standard glass	White	88

#### Aluminum Economy Angle Back

Part #	Size	Description	Color	Flat Glass / Convex Glass Area (in <sup>2</sup> )
705038 <sup>1</sup>	6"w x 16"h	Standard glass	Aluminum	94
705107 <sup>1</sup>	6"w x 16"h	Split glass	Aluminum	66 Flat / 21 Convex
705111 <sup>2</sup>	6"w x 16"h	Standard glass	Aluminum	94

#### NOTES

<sup>1</sup> Includes black plastic end caps

<sup>2</sup> Includes heavy duty metal end caps



*Pillow back*



*Rib back*

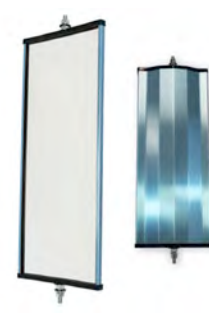

*Aluminum economy angle back - full flat or split glass*

# MIRRORS

## ALL MAKES

### West Coast Mirrors



- 5/16-18 UNC Thread both ends

#### Head Size

7¼"w x 15⅞"h x 3"d

#### Accessories

- **Maker Light Kit**

Model 421 | Part # V614210001

#### NOTES

**M/R** Manual / remote

#### Flat Glass Head Head adjustable

Model	Part #	Glass Size	Side	Color	M/R	Heat	Light
438	V514380014	6⅞"w x 16"h	Right	Stainless	Remote	•	•
438	V514380013	6⅞"w x 16"h	Left	Stainless	Remote	•	•
438	V514380012	6⅞"w x 16"h	Right	Stainless	Remote	•	-
438	V514380011	6⅞"w x 16"h	Left	Stainless	Remote	•	-
438	V514380008	6⅞"w x 16"h	Right	Stainless	Manual	•	•
438	V514380007	6⅞"w x 16"h	Left	Stainless	Manual	•	•
438	V514380006	6⅞"w x 16"h	Right	Stainless	Manual	•	-
438	V514380005	6⅞"w x 16"h	Left	Stainless	Manual	•	-
438	V514380004	6⅞"w x 16"h	Right	Stainless	Manual	-	•
438	V514380003	6⅞"w x 16"h	Left	Stainless	Manual	-	•
438	V514380001	6⅞"w x 16"h	Both	Stainless	Manual	-	-

#### Flat Glass Kit

Model	Part #	Glass Size	Side	Color	M/R	Heat
438	V154382117	6⅞"w x 16"h	Both	Black	Remote	•



Call the Velvac Sales Team: **800.783.8871** sales@velvac.com

© VELVAC INC. • 2405 South Calhoun Road • New Berlin, WI 53151-2709 • Toll Free: 800.783.8871 • Fax: 262.786.4101



### West Coast Mirrors



- 1- 1 $\frac{1}{8}$ " tube

#### Head Size

7 $\frac{5}{16}$ "w x 16 $\frac{3}{8}$ "h x 4 $\frac{5}{8}$ "d

#### Accessories

- **CB Bracket Parts Kit**  
Model 409 | Part # [V614090029](#)
- **Head Clamp & Screws Kit**  
Model 405 | Part # [V624059999](#)

**Flat Glass Housing** Head adjustable. Order glass to make complete head

Model	Part #	Glass Size	Side	Color	M/R	Heat	Light
409	<a href="#">V614090024</a>	6 $\frac{3}{4}$ "w x 15 $\frac{7}{8}$ "h	Right	Chrome	Remote	•	-
409	<a href="#">V614090023</a>	6 $\frac{3}{4}$ "w x 15 $\frac{7}{8}$ "h	Left	Chrome	Remote	•	-
409	<a href="#">V614090022</a>	6 $\frac{3}{4}$ "w x 15 $\frac{7}{8}$ "h	Both	Chrome	Manual	•	-
409	<a href="#">V614090021</a>	6 $\frac{3}{4}$ "w x 15 $\frac{7}{8}$ "h	Both	Chrome	Manual	-	-
409	<a href="#">V614090033</a>	6 $\frac{3}{4}$ "w x 15 $\frac{7}{8}$ "h	Right	Black	Remote	•	-
409	<a href="#">V614090032</a>	6 $\frac{3}{4}$ "w x 15 $\frac{7}{8}$ "h	Left	Black	Remote	•	-
409	<a href="#">V614090031</a>	6 $\frac{3}{4}$ "w x 15 $\frac{7}{8}$ "h	Both	Black	Manual	•	-
409	<a href="#">V614090030</a>	6 $\frac{3}{4}$ "w x 15 $\frac{7}{8}$ "h	Both	Black	Manual	-	-
409	<a href="#">V614090028</a>	6 $\frac{3}{4}$ "w x 15 $\frac{7}{8}$ "h	Right	Gray	Remote	•	-
409	<a href="#">V614090027</a>	6 $\frac{3}{4}$ "w x 15 $\frac{7}{8}$ "h	Left	Gray	Remote	•	-
409	<a href="#">V614090026</a>	6 $\frac{3}{4}$ "w x 15 $\frac{7}{8}$ "h	Both	Gray	Manual	•	-
409	<a href="#">V614090025</a>	6 $\frac{3}{4}$ "w x 15 $\frac{7}{8}$ "h	Both	Gray	Manual	-	-

#### Flat Glass Kit

Model	Part #	Glass Size	Side	Color	M/R	Heat
383	<a href="#">V153832107</a>	6 $\frac{3}{4}$ "w x 15 $\frac{7}{8}$ "h	Both	Black	Both	•
383	<a href="#">V153832003</a>	6 $\frac{3}{4}$ "w x 15 $\frac{7}{8}$ "h	Both	Gray	Both	•
383	<a href="#">V153832000</a>	6 $\frac{3}{4}$ "w x 15 $\frac{7}{8}$ "h	Both	Gray	Both	-

#### Flat Mirror Actuators

Model	Part #	Side
409	<a href="#">V084090002</a>	Right
409	<a href="#">V084090001</a>	Left

#### NOTES

**M/R** Manual / remote

**NOTE: Part numbers listed in RED are NEW!**

# MIRRORS

## ALL MAKES

### West Coast Mirrors



- 1- 1 1/8" tube

#### Head Size

8 1/16" w x 15 1/16" h x 5 1/4" d

#### Accessories

- **Marker Light Kit w/ Bezel**  
Model 427 | Part # [V114272001](#)
- **Head Clamp & Screws Kit**  
Model 400 | Part # [V614000010](#)

#### NOTES

**M/R** Manual / remote

<sup>1</sup> Chrome backcover with black housing

<sup>2</sup> Chrome backcover with chrome housing

### Flat Glass Head Glass adjustable

Model	Part #	Glass Size	Side	Color	M/R	Heat	Light
427	<a href="#">V514271108<sup>1</sup></a>	7 1/4" w x 14 1/4" h	Right	Chrome	Remote	•	•
427	<a href="#">V514271107<sup>1</sup></a>	7 1/4" w x 14 1/4" h	Left	Chrome	Remote	•	•
427	<a href="#">V514271008<sup>1</sup></a>	7 1/4" w x 14 1/4" h	Right	Chrome	Manual	•	•
427	<a href="#">V514271007<sup>1</sup></a>	7 1/4" w x 14 1/4" h	Left	Chrome	Manual	•	•
427	<a href="#">V514271006<sup>1</sup></a>	7 1/4" w x 14 1/4" h	Right	Chrome	Manual	-	-
427	<a href="#">V514271005<sup>1</sup></a>	7 1/4" w x 14 1/4" h	Left	Chrome	Manual	-	-
427	<a href="#">V514270018<sup>2</sup></a>	7 1/4" w x 14 1/4" h	Right	Chrome	Remote	•	•
427	<a href="#">V514270017<sup>2</sup></a>	7 1/4" w x 14 1/4" h	Left	Chrome	Remote	•	•
427	<a href="#">V514270016<sup>2</sup></a>	7 1/4" w x 14 1/4" h	Right	Chrome	Remote	•	-
427	<a href="#">V514270015<sup>2</sup></a>	7 1/4" w x 14 1/4" h	Left	Chrome	Remote	•	-
427	<a href="#">V514270019<sup>2</sup></a>	7 1/4" w x 14 1/4" h	Both	Chrome	Manual	-	-
427	<a href="#">V514270104</a>	7 1/4" w x 14 1/4" h	Right	Black	Remote	•	•
427	<a href="#">V514270103</a>	7 1/4" w x 14 1/4" h	Left	Black	Remote	•	•
427	<a href="#">V514270122</a>	7 1/4" w x 14 1/4" h	Right	Black	Remote	•	-
427	<a href="#">V514270121</a>	7 1/4" w x 14 1/4" h	Left	Black	Remote	•	-
427	<a href="#">V514270004</a>	7 1/4" w x 14 1/4" h	Right	Black	Manual	•	•
427	<a href="#">V514270003</a>	7 1/4" w x 14 1/4" h	Left	Black	Manual	•	•
427	<a href="#">V514270014</a>	7 1/4" w x 14 1/4" h	Right	Black	Manual	•	-
427	<a href="#">V514270013</a>	7 1/4" w x 14 1/4" h	Left	Black	Manual	•	-
427	<a href="#">V514270002</a>	7 1/4" w x 14 1/4" h	Right	Black	Manual	-	-
427	<a href="#">V514270001</a>	7 1/4" w x 14 1/4" h	Left	Black	Manual	-	-



Call the Velvac Sales Team: **800.783.8871** [sales@velvac.com](mailto:sales@velvac.com)

© VELVAC INC. • 2405 South Calhoun Road • New Berlin, WI 53151-2709 • Toll Free: 800.783.8871 • Fax: 262.786.4101

#### Flat Glass Kit

Model	Part #	Glass Size	Side	Color	M/R	Heat
427	V154270011	7¼"w x 14¼"h	Both	Black	Manual / Remote	•
427	V154270010	7¼"w x 14¼"h	Both	Black	Manual / Remote	-
427	V614270004 <sup>3</sup>	7¼"w x 14¼"h	Right	Black	Manual / Remote	•
427	V614270005 <sup>3</sup>	7¼"w x 14¼"h	Left	Black	Manual / Remote	•
427	V614270002 <sup>3</sup>	7¼"w x 14¼"h	Right	Black	Manual / Remote	-
427	V614270003 <sup>3</sup>	7¼"w x 14¼"h	Left	Black	Manual / Remote	-

#### Mirror Cover

Model	Part #	Side	Color	Light
427	V134271009 <sup>4</sup>	Both	Chrome	•
427	V134271008	Both	Chrome	-
427	V614271007 <sup>4,5</sup>	Both	Chrome	•
427	V134271001 <sup>4</sup>	Both	Black	•
427	V134271000	Both	Black	-
427	V614270006 <sup>4,5</sup>	Both	Black	•

#### NOTES

<sup>3</sup> Includes housing

<sup>4</sup> Furnished with punched holes

<sup>5</sup> Kit furnished with marker light

#### Flat Mirror Actuator

Model	Part #	Side
427	V084270006	Both

**NOTE: Part numbers listed in RED are NEW!**



# MIRRORS

## ALL MAKES

### West Coast Mirrors



- Fits 1- 1 $\frac{1}{8}$ " tube

#### Head Size

8 $\frac{13}{16}$ "w x 19"h x 5 $\frac{1}{4}$ "d

#### Accessories

- **Head Clamp & Screws Kit**  
Model 400 | Part # **V614000010**

#### NOTES

<sup>1</sup> Furnished with heated flat and convex glass

<sup>2</sup> Flat glass only

**M/R** Manual / remote

### Split Glass Mirror Head Glass adjustable

Model	Part #	Glass Size	Side	Color	M/R	Heat	Light
549	V515492230 <sup>1</sup>	7 $\frac{5}{8}$ "w x 10 $\frac{7}{8}$ "h	Both	Black	Remote <sup>2</sup>	•	-
549	V515492210 <sup>1</sup>	7 $\frac{5}{8}$ "w x 10 $\frac{7}{8}$ "h	Both	Black	Manual	•	-
549	V515492110	7 $\frac{5}{8}$ "w x 10 $\frac{7}{8}$ "h	Both	Black	Manual	-	-

### Flat Glass Kit

Model	Part #	Glass Size	Side	Color	M/R	Heat
549	V155492121	7 $\frac{5}{8}$ "w x 10 $\frac{7}{8}$ "h	Both	Black	Both	•
549	V155492110	7 $\frac{5}{8}$ "w x 10 $\frac{7}{8}$ "h	Both	Black	Both	-

### Mirror Cover

Model	Part #	Side	Color	Light
549	V115490001	Both	Black	-

### Convex Glass Kit

Model	Part #	Glass Size	Side	Color	M/R	Heat
549	V155492151	7 $\frac{3}{4}$ "w x 6 $\frac{1}{2}$ "h	Both	Black	Both	•
549	V155492150	7 $\frac{3}{4}$ "w x 6 $\frac{1}{2}$ "h	Both	Black	Both	-

### Flat Mirror Actuator

Model	Part #	Side
480	V084803997	Both



Call the Velvac Sales Team: **800.783.8871** [sales@velvac.com](mailto:sales@velvac.com)

© VELVAC INC. • 2405 South Calhoun Road • New Berlin, WI 53151-2709 • Toll Free: 800.783.8871 • Fax: 262.786.4101



### Blind Spot Convex Mirrors

#### DuraBall® Convex

- Velvac's DuraBall® mirror and pivot system features a HD nylon inner and outer ball with stainless bolt and locking "L" bracket for easy mounting and operation
- Heavy gauge stainless steel or powder coated galvanized steel construction protects mirrors against corrosion
- Rolled edge on 5" and 8½" diameter mirrors - outer gasket on 6" diameter mirrors
- Available in popular 10", 8½", 6" and 5" diameters with several lens options. The 8½" is also available with center mount or offset mount
- DuraBall mirrors guaranteed against shell cracking and breaking for 5 years
- Mirrors other than wide view include mounting "L" bracket or tube bracket, mounting hardware and display box



5" diameter



8½" diameter



8½" diameter



Wide view  
8½" diameter



Wide view  
10" diameter

#### Three Screw and Specialty Convex Mirror

- Three screw ball stud offers secure mounting and easy adjustment
- Available in high luster stainless steel, chrome plated steel or painted steel finishes
- 8½", 7½", 6" and 5" diameters with standard convex and heated options. The 8½" and 7½" are also available either center mount or offset mount
- Includes mounting "L" bracket, mounting hardware and comes in a display box
- 708558 convex features high luster chrome plated stainless steel shell and heavy duty nylon ball stud; bracket not included



7½" diameter



7½" diameter



8½" diameter



8½" diameter  
chrome plated  
stainless

**NOTE: Part numbers listed in RED are NEW!**

# MIRRORS

## ALL MAKES

### Blind Spot Convex Mirrors

Continued

Description	ROC
10" Wide view	8½"
8½" Wide view	5½"
6" DuraBall	14"
5" DuraBall	10"
All other convex	13"

#### Helpful hint:

Mirror head diameter and ROC (radius of curvature) help determine field of view coverage and image size provided by the convex mirror. Wide view convex mirrors are typically used for front and rear cross view applications where a wide field of view is desired. Standard convex mirrors are used for viewing targeted blind spots or passing lanes around the vehicle



5" and 6"  
diameter

#### NOTES

<sup>1</sup> For heavy duty nylon ball stud see page M11

<sup>2</sup> Stainless steel tube bracket and clamp kit 723057 also shown on page M130

Plexiglas® is shatter resistant

DuraBall®, Eyeball® and K-10® are registered trademarks of Velvac, Inc. Plexiglas® is a registered trademark of Evonik Industries

Description	DuraBall Convex Lens			Three Screw and Specialty Lens	
	Standard Glass	Heated Glass	Wide View Convex	Standard Glass	Heated Glass
<b>10" Center Mount</b>					
Stainless Steel	-	-	709218 (Plexiglas®)	-	-
Black	-	-	709216	-	-
White	-	-	709217	-	-
Post Office White	-	-	709226	-	-
<b>8½" Center Mount</b>					
Stainless Steel	708441	708453	708448	708501	708559
Black	708442	-	708449	708503	-
White	-	-	708450	-	-
Post Office White	-	-	708463	-	-
Chrome	-	-	-	708556	-
Chrome Plated Stainless	-	-	-	708558 <sup>1</sup>	-
<b>8½" Offset Mount</b>					
Stainless Steel	708444	708457	-	708502	708560
Black	708446	-	-	708504	-
Chrome	-	-	-	708557	-
<b>7½" Center Mount</b>					
Stainless Steel	-	-	-	708508	-
Black	-	-	-	708510	-
Chrome	-	-	-	708554	-
<b>7½" Offset Mount</b>					
Stainless Steel	-	-	-	708509	-
Black	-	-	-	708511	-
Chrome	-	-	-	708555	-
<b>6" Center Mount</b>					
Stainless Steel	708478	-	-	708515	-
Stainless Steel w/ Tube Bracket <sup>2</sup>	708476	-	-	-	-
Black	708479	-	-	708516	-
Chrome	-	-	-	708553	-
<b>5" Center Mount</b>					
Stainless Steel	-	-	-	708520	-
Stainless Steel - Flat Glass	708473	-	-	708514	-
Black	-	-	-	708521	-
Black - Flat Glass	-	-	-	708513	-
Chrome	-	-	-	708552	-
Chrome ABS	-	-	-	708551	-



Call the Velvac Sales Team: **800.783.8871** sales@velvac.com

© VELVAC INC. • 2405 South Calhoun Road • New Berlin, WI 53151-2709 • Toll Free: 800.783.8871 • Fax: 262.786.4101

### Standard K-10 Convex Lens

#### Convex Glass Head

Part #	Color	Diameter	ROC
708602	Stainless steel	10"	13"
708615	Black ABS	10"	13"
708601	Stainless steel - center mount	8.5"	13"
708609	Stainless steel - offset mount	8.5"	13"

#### Convex Glass Kit

Part #	Diameter	ROC
702149	10"	13"
702148	8.5"	13"

### Eyeball Convex Lens

#### Convex Glass Head

Part #	Color	Diameter	ROC
708605	Stainless steel	10"	8.5"
708604	Black ABS	10"	8.5"
708608	Stainless steel	8.5"	5.5"
708610	Black ABS	8.5"	5.5"
708606	Black	8.5"	5.5"
708603	Black ABS	6"	5.5"

#### Convex Glass Kit

Part #	Diameter	ROC
702159	10"	8.5"
702158	8.5"	5.5"

### 8" Polypropylene Convex Mirrors

Part #	Color
723103	Post Office White
723104	Black

#### NOTES

For replaceable front crossview for USPS LLV and CRV, see page M124

### Blind Spot Convex Mirrors



Back view  
Eyeball convex

- Provides outstanding views of troublesome and dangerous blind spots around the vehicle
- Choose from 10", 8½" and 6" diameter in stainless steel, powder coat steel or ABS plastic with standard K-10 convex and Eyeball® convex lens options
- HD inner and outer nylon ball stud with stainless steel mounting hardware for durable, smooth and long lasting operation
- Use as a supplement to west coast mirrors, side blind spots or front and rear cross view applications
- Heavy duty outer gasket protects mirrors from edge shock and allows mirror lens to be easily replaced



8"  
Polypropylene  
convex mirror

- 12" radius of curvature
- Light weight one piece non-corrosive plastic shell
- Adjustable stud mount ball socket
- 5/16" mounting hardware included

**NOTE: Part numbers listed in RED are NEW!**

## ALL MAKES

### Convex Mirror Heads



- Fits 1- 1 1/8" tube

#### Convex Head Size

8" w x 7 1/16" h x 5 3/8" d

#### Accessories

- **Head Clamp & Screws Kit**  
Model 400 | Part # **V614000010**

#### NOTES

**M/R** Manual / remote

### Convex Glass Housing Glass adjustable. Order glass to make complete head

Model	Part #	Glass Size	Side	Color	M/R	Heat	Light
458	V144580001	7 3/4" w x 7 3/8" h	Both	Black	Manual	-	-

### Convex Glass Kit

Model	Part #	Glass Size	Side	Color	M/R	Heat
458	V154580003	7 3/4" w x 7 3/8" h	Both	Black	Manual	-

### Convex Mirror Cover

Model	Part #	Side	Color	Light
458	V134580001	Both	Black	-



- Fits 9/16 - 3/4" tube

#### Convex Head Size

7 7/8" w x 6 1/8" h x 3 3/4" d

#### NOTES

**M/R** Manual / remote

### Convex Glass Head Head adjustable

Model	Part #	Glass Size	Side	Color	M/R	Heat	Light
260	V562601127	7 1/2" w x 5 5/8" h	Both	Black	Manual	-	-



Call the Velvac Sales Team: **800.783.8871** [sales@velvac.com](mailto:sales@velvac.com)

© VELVAC INC. • 2405 South Calhoun Road • New Berlin, WI 53151-2709 • Toll Free: 800.783.8871 • Fax: 262.786.4101



**ALL MAKES**

## Convex Mirror Heads



- Fits 1- 1 1/8" tube

### Convex Head Size

7 1/4"w x 7 1/4"h x 3"d

### NOTES

**M/R** Manual / remote

### Convex Glass Head Head adjustable

Model	Part #	Glass Size	Side	Color	M/R	Heat	Light
388	V563882218	6 3/4"w x 6 3/4"h	Both	Chrome	Manual	•	-
388	V563882208	6 3/4"w x 6 3/4"h	Both	Chrome	Manual	-	-

### Convex Glass Kit

Model	Part #	Glass Size	Side	Color	M/R	Heat
388	V153882117	6 3/4"w x 6 3/4"h	Both	Black	Manual	•
388	V153882213	6 3/4"w x 6 3/4"h	Both	Gray	Manual	•

**NOTE: Part numbers listed in RED are NEW!**

# MIRRORS

## ALL MAKES

### Convex Mirror Heads



- Fits 1- 1 1/8" tube

#### Convex Head Size

7 1/4"w x 7 1/4"h x 5 1/8"d

#### Accessories

- **Mirror Head Clamp**  
Model 387 | Part # [V113870510B](#)
- **Head Clamp & Screws Kit**  
Model 405 | Part # [V624059999](#)

#### NOTES

**M/R** Manual / remote

### Convex Glass Housing Head adjustable. Order glass to make complete head

Model	Part #	Glass Size	Side	Color	M/R	Heat	Light
409	<a href="#">V614090018</a>	6 3/4"w x 6 3/4"h	Both	Chrome	Manual	•	-
409	<a href="#">V614090017</a>	6 3/4"w x 6 3/4"h	Both	Chrome	Manual	-	-
409	<a href="#">V614090035</a>	6 3/4"w x 6 3/4"h	Both	Black	Manual	•	-
409	<a href="#">V614090034</a>	6 3/4"w x 6 3/4"h	Both	Black	Manual	-	-
409	<a href="#">V614090020</a>	6 3/4"w x 6 3/4"h	Both	Gray	Manual	•	-
409	<a href="#">V614090019</a>	6 3/4"w x 6 3/4"h	Both	Gray	Manual	-	-

### Convex Glass Kit

Model	Part #	Glass Size	Side	Color	M/R	Heat
388	<a href="#">V153882117</a>	6 3/4"w x 6 3/4"h	Both	Black	Manual	•
388	<a href="#">V153882120</a>	6 3/4"w x 6 3/4"h	Both	Black	Manual	-
388	<a href="#">V153882213</a>	6 3/4"w x 6 3/4"h	Both	Gray	Manual	•
388	<a href="#">V153882210</a>	6 3/4"w x 6 3/4"h	Both	Gray	Manual	-



Call the Velvac Sales Team: **800.783.8871** [sales@velvac.com](mailto:sales@velvac.com)

© VELVAC INC. • 2405 South Calhoun Road • New Berlin, WI 53151-2709 • Toll Free: 800.783.8871 • Fax: 262.786.4101

### Convex Mirror Heads



- Fits 1- 1 1/8" tube

#### Convex Head Size

8 7/16" w x 6 5/8" h x 4 1/2" d

#### Accessories

- **Head Clamp & Screws Kit**  
Model 400 | Part # V614000010

#### NOTES

**M/R** Manual / remote

<sup>1</sup> Chrome backcover with black housing

<sup>2</sup> Chrome backcover with chrome housing

<sup>3</sup> Furnished with turn signal

<sup>4</sup> Includes housing

### Convex Glass Head *Glass adjustable*

Model	Part #	Glass Size	Side	Color	M/R	Heat	Light
428	V564281005 <sup>1</sup>	7 3/4" w x 5 3/4" h	Both	Chrome	Manual	-	-
428	V564281014 <sup>2</sup>	7 3/4" w x 5 3/4" h	Both	Chrome	Manual	•	-
428	V564281015 <sup>2,3</sup>	7 3/4" w x 5 3/4" h	Both	Chrome	Manual	•	-
428	V564281013 <sup>2</sup>	7 3/4" w x 5 3/4" h	Both	Chrome	Manual	-	-
428	V564281002	7 3/4" w x 5 3/4" h	Both	Black	Manual	•	-
428	V564281001	7 3/4" w x 5 3/4" h	Both	Black	Manual	-	-

### Convex Glass Kit

Model	Part #	Glass Size	Side	Color	M/R	Heat
428	V154280002	7 3/4" w x 5 3/4" h	Both	Black	Manual	•
428	V154280003 <sup>3</sup>	7 3/4" w x 5 3/4" h	Both	Black	Manual	•
428	V154280001	7 3/4" w x 5 3/4" h	Both	Black	Manual	-
428	V614280008 <sup>4</sup>	7 3/4" w x 5 3/4" h	Both	Black	Manual	-

### Convex Mirror Cover

Model	Part #	Side	Color	Light
428	V134281015	Both	Chrome	-
428	V134281011	Both	Black	-

**NOTE: Part numbers listed in RED are NEW!**

# MIRRORS

## ALL MAKES

### Accessory Mirrors

#### Over Door Convex Mirror



- Mounts above exterior passenger side window for greater blind spot visibility
- Used as an accessory mirror on heavy trucks for better viewing directly below "peek-a-boo" window
- 4" x 8" convex mirror, 12" ROC
- Assembly includes stainless steel mirror head with mounting bracket

Part #	Description
715198	Over door convex mirror

#### Long Arm Over Door Convex Mirror



- Over 1" longer than standard over door mirrors
- All stainless steel construction and hardware

Part #	Description
716872	Over door convex mirror

#### Interior Rearview Mirror



- Glass measures 9"w x 2"h
- Day/night feature reduces night driving glare
- Dual ball joint adjustment
- Textured black housing
- Mounting pad and adhesive sold separately as mirror mounting kit
- Rear view mirror will fit on flange type mounting pads up to .90" wide

Part #	Description
723095	Rear view mirror
723097	Mirror mounting kit

#### Universal Strap-On/Off Mirror



- Universal design fits either driver or passenger side mirrors on most vehicles
- Durable black mirror quickly and securely straps to existing mirror for extended view around wide loads
- No tools required

Part #	Description
715203	Strap-on towing mirror 5" x 7½" mirror head

The Wedge™ is a trademark of Velvac, Inc

#### 7½" X 10½" Center Bracket Flat Glass Mirror Heads



- Over 63 sq. in. viewing area
- ⅛" FSC glass
- Rolled edge design holds glass and gasket securely in place
- Mirror glass not replaceable

Part #	Description
709002	Stainless steel
709006	Stainless / heated
709275	Flat black
709276	White

#### HHR Spotter Mirror



- Reduce blind spots on GM HHR
- Mounts directly to OE side mirrors\*
- Lower portion of flat glass is open for passing lane viewing
- Size is approx 2½" x 3¼" with 7.3 sq. in. viewing area and 8½" ROC

Part #	Description
718394-5	Pair - right & left side

\* Other applications include van, pickup and SUV mirrors



Call the Velvac Sales Team: **800.783.8871** sales@velvac.com

© VELVAC INC. • 2405 South Calhoun Road • New Berlin, WI 53151-2709 • Toll Free: 800.783.8871 • Fax: 262.786.4101

### Accessory Mirrors

#### The Wedge™ Stick-On Convex Mirror



- Unique wedge design provides more usable viewing area/larger image size than conventional stick on mirrors
- Universal design permits use on both driver and passenger mirrors
- Black plastic shell with rounded corners gives mirror a "built-in" look
- 3¼" overall size with 8½ ROC
- Mounts easily and securely using attached adhesive pad

Part #	Description
723068	Wedge stick-on mirror
723068-6	50 Pack wedge mirror

#### Stick-On Convex Spot Mirrors



- Lightweight aluminum shell
- Mount easily and securely using attached adhesive pad
- Attractive packaging displays easily on pegboards or wire display racks (See Retail section for wire display rack Part No. 091256)

Part #	Description	ROC
723050	2" Round	4½"
723060	3" Round	4½"
723065	3¾" Round	4½"
723075	4" x 5½" Rectangle	8½"

#### Convex Fork Lift Mirror



- Mirror used on many OEM fork lift applications
- 4½"w x 7½"h overall size
- Acrylic spherical convex lens provides wide view and resists cracking or breaking
- Durable black textured ABS mirror back with black PVC outer gasket
- ⅜" plated mounting stud, nut and washer
- Individually boxed

Part #	Description
708611	Convex fork lift mirror

#### Convex Look Down Mirror



#### Bracket Mount Convex Head Size

11⅜"w x 6⅞"h x 2⅞"d

**Bracket Hole Location**  
**Width Between Holes:** 3⅛"  
**Hole Size:** 1¼"

#### NOTES

**M/R** Manual / remote

<sup>1</sup> Furnished with black arm, chrome back cover, black bezel and black holder

<sup>2</sup> Furnished with black arm, black back cover, black bezel and black holder

<sup>3</sup> Includes bezel

#### Convex Look Down Mirror

Model	Part #	Glass Size	Color	M/R	Heat	Light
360	V593605228 <sup>1</sup>	10⅝"w x 6¼"h	Chrome	Manual	-	-
360	V593601152 <sup>2</sup>	10⅝"w x 6¼"h	Black	Manual	-	-

#### Convex Glass Kit

Model	Part #	Glass Size	Side	Color	M/R	Heat
360	V613600001 <sup>3</sup>	10⅝"w x 6¼"h	Both	Black	Manual	-



## ALL MAKES

### Safety Mirrors

- Provides a bright distortion-free view of an entire area, allowing in-plant vehicles and/or personnel to move safely through the facility
- All hemisphere mirrors include mounting clips for attaching to drop ceiling "T" bars. Pendulum style installation kit can be ordered for corner hanging applications

#### Helpful hint

Mirror diameter in inches should be equal to viewing distance in feet. (For example, a 16" mirror should be used for viewing 16' away.) If mirror is to be used for security, a larger diameter is recommended because of image clarity

### 180° Hemisphere Mirror

- For use in a 3-way "T" corridor and other wide-angle viewing

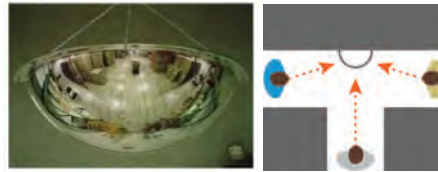

### 360° Hemisphere Mirror

- Can be suspended from ceiling to see blind corners

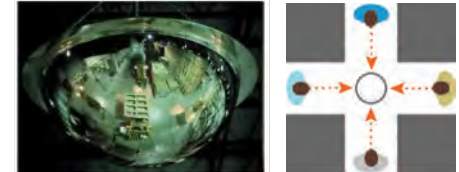

180° View	360° View	Diameter	Ceiling Height
730209	-	18"	Up to 8'
730210	730201	24"	8' to 10'
730212	-	30"	10' to 12'
-	730202	36"	12' to 15'

### K-10 Observation Window



- Clear polycarbonate bubble window - 360° viewing
- Permits easy viewing of high stress areas before or without entering

Part #	Size
702157	18" x 1/4" x 6"

### Installation Kits

Part #	Description
730195	Pendulum style installation kit

K-10 Hemisphere® is a registered trademark of Velvac, Inc

### Oblong Indoor Mirror

- Bright distortion-free images allow excellent safety vision and traffic control as well as quality inspection viewing of assembly lines or machinery production areas



Part #	Diameter
730126*	24" x 16"

\*Custom for off-road equipment

Heavy duty full round outdoor ABS mirror back



### Heavy Duty Full Round Outdoor / Indoor Full Round Mirror

- *Outdoor:* perfect for safety and security. Installation in blind alleys, loading docks, parking ramps or garages. Includes ABS back and hardware for swivel mounting
- *Indoor:* ideal for detailed observation where employees and equipment meet. Includes hardware and swivel for mounting



Part #	Dia.	Application
730104	18"	Outdoor
730105	24"	Outdoor
730122	30"	Outdoor



Call the Velvac Sales Team: **800.783.8871** sales@velvac.com

© VELVAC INC. • 2405 South Calhoun Road • New Berlin, WI 53151-2709 • Toll Free: 800.783.8871 • Fax: 262.786.4101

### Wide Angle Mirrors

#### Stud Mount Mirror Heads



- Center mount wide angle mirror heads feature Velvac's DuraBall nylon ball stud for superior strength and durability (see page M11 for DuraBall information)
- 5/16" - 18 mounting stud. Use with mounting clamp 704068 on page M131
- 1/8" replaceable FSC glass on flat glass models; 1/8" silvered glass on convex glass

#### 6 1/2" x 6" Convex Glass

- Viewing area 32 sq. in.
- 21" ROC



#### 6 1/2" x 10" Flat Glass

- Viewing area 55 sq. in.



#### Shatter Resistant 6 1/2" x 10" Convex Glass

- Viewing area 55 sq. in.
- 40" ROC; shatter resistant backing on glass



Color	6 1/2" x 6" Convex Glass			6 1/2" x 10" Flat Glass			Shatter Resistant 6 1/2" x 10" Convex Glass		
	Part #	Glass #	Gasket #	Part #	Glass #	Gasket #	Part #	Glass #	Gasket #
Stainless	708156	702023	703006	708181	702076	703008	708198-5	702098-5	703008
White	-	-	-	-	-	-	708176-5	702098-5	703007
Ford White	704280	702023	703005	704268	702076	703007	-	-	-
Black	-	-	-	-	-	-	708197-5	702098-5	703008

# MIRRORS

## ALL MAKES

### Wide Angle Mirrors

#### Side Mount Angle Mirror Heads



#### 6½" x 6" Flat Glass

- Viewing area 32 sq. in.



#### 6½" x 6" Convex Glass

- Viewing area 32 sq. in.
- 21" ROC



- The original Velvac wide angle mirror head is used on walk-in van, cutaway van, cab chassis and a variety of other applications
- 5/16" - 18 threaded mounting port for a clean, easy installation. Use with mounting clamp 704068 on page M131
- 1/8" replaceable FSC glass on all flat glass models except UPS brown which is silvered. All convex glass is silvered glass

#### 6½" x 10" Flat Glass

- Viewing area 55 sq. in.

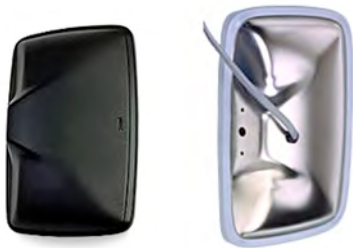

	6½" x 6" Flat Glass			6½" x 10" Flat Glass			6½" x 6" Convex		
Color	Part #	Glass #	Gasket #	Part #	Glass #	Gasket #	Part #	Glass #	Gasket #
<b>Steel</b>									
Stainless	704093	702051	703005	704091	702076	703007	704095	702023	703005
Stainless <sup>1</sup>	-	-	-	704325	702076	703007	704315	704335	703005
White	704078	702051	703005	704032	702076	703007	704077	702023	703005
<b>Plastic</b>									
White	704178-5	702051	703101	704132-5	702076	703102	704177-5	702057	703101
PO White	-	-	-	704122	702076	703102	704120	704121	703101
UPS Brown	704158	702051	703103	704154	702076	703104	704155	702057	703103
Black	704159	-	703103	704152-5	702076	703104	704153-5	702057	703103

NOTES  
<sup>1</sup> Heated



Call the Velvac Sales Team: **800.783.8871** sales@velvac.com

© VELVAC INC. • 2405 South Calhoun Road • New Berlin, WI 53151-2709 • Toll Free: 800.783.8871 • Fax: 262.786.4101

### Class A RV, Bus and Truck Mirrors

- Velvac's line of side mount and corner mount mirrors are designed with a focus on safety, quality and styling. Typical applications include Class A motorhomes, motorcoach, fire truck and rescue vehicles. Produced from high quality materials, these mirrors can be configured to meet specific customer and application requirements

#### Available Features/Options

- Deluxe, V-MAX™ or V-MAX III™ mirror heads
- Top Hat™ add-on convex for Deluxe head
- Chrome plated or powder coated finish

- Easily replaceable manual or heated remote glass
- Lower marker lamp on arm or signal arrow in the flat glass
- Lower LEM camera with LED marker lamp

#### Model 2025 Mirror System

- Mirror system mounts to the flat side of the vehicle, allowing the mirror to be viewed through the side window



Shown with Deluxe head

#### Revolution™ Mirror System

- Mirror base pivot system mounts to flat side of vehicle and allows mirror to be folded forward or back for vehicle storage



Shown with V-MAX™ head

#### Model 2030 Mirror System

- Corner mounting base available with 9", 10", 11", 12" or 15" radius. Contact Velvac for custom applications
- Mirror arm lengths available from 10", 12", 14" or 17". This allows mirrors to be viewed through the windshield or side windows



Shown with Deluxe head and add-on Top Hat™ convex

#### Top Hat Add-On Convex Mirror

Part #	Color
715372	Black
715373	White
715374	Chrome

- Installs easily on top of Deluxe head for added visibility of blind spots or other vision targets
- Fits on either driver side or passenger side mirror

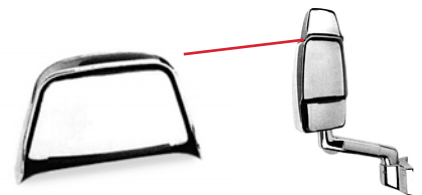

Deluxe Revolution™, V-Max™, V-MaxIII™ and Top Hat™ are trademarks of Velvac, Inc.

#### NOTES

Top Hat fits either driver side or passenger side  
All heads shown are heated remote flat glass

Camera not included with replacement LEM heads  
See RV make/model information at [www.velvac.com](http://www.velvac.com) by clicking Where to Buy / Order RV Mirrors

# MIRRORS

## ALL MAKES

### Class A RV, Bus and Truck Mirrors

Continued

#### Mirror Heads



Deluxe



V-MAX



V-MAX III



V-MAX III with LEM

Mirror Head	Flat Glass		Lower Convex Glass			Upper Convex Glass		
	Square Inch	Size	Square Inch	Size	Radius	Square Inch	Size	Radius
Deluxe	62.3	8" x 8"	30	8" x 4"	12"	N/A	N/A	N/A
V-MAX	98.7	8" x 13"	30	8" x 4"	21"	N/A	N/A	N/A
V-MAX III	72.5	8" x 9"	30	8" x 4"	21"	26.4	8" x 3.3"	21"
Top Hat	N/A	N/A	N/A	N/A	N/A	17.8	6" x 3.5"	12.5"

#### Mirror Heads

Deluxe	V-MAX	V-MAX III	V-MAX LEM 2025 Base	V-MAX LEM 2030 Base	V-MAX III LEM 2030 Base	Side	Color
714590	714946	-	-	-	-	Right	White
714589	714947	-	-	-	-	Left	White
714582	714944	717192	716208	716190	716154	Right	Black
714581	714945	717193	716207	716189	716155	Left	Black
714608	714942	717180	716206	716188	716152	Right	Chrome
714607	714943	717179	716205	716187	716153	Left	Chrome

#### Glass Kits

Deluxe	V-MAX	V-MAX III	V-MAX LEM 2025 Base	V-MAX LEM 2030 Base	V-MAX III LEM 2030 Base	Description
709448	709450	709732	709450	709450	709732	Heated flat right or left
709674	709624	709702	709624	709624	709702	Heated flat with blinker RS
709673	709623	709701	709623	709623	709701	Heated flat with blinker LS
709449	709650	709650	709650	709650	709650	Lower convex RS/LS
-	-	709733	-	-	709733	Upper convex glass
709589	709651	709651	709651	709651	709651	Lower convex housing RS/LS

#### NOTES

**RS** Right side

**LS** Left side



Call the Velvac Sales Team: **800.783.8871** [sales@velvac.com](mailto:sales@velvac.com)

© VELVAC INC. • 2405 South Calhoun Road • New Berlin, WI 53151-2709 • Toll Free: 800.783.8871 • Fax: 262.786.4101



### Hood Mount Mirrors

#### Velvac's Mod Pod™ and K-10 Version-2 Hood Mount Assemblies

**Helpful hint:**

The popular Velvac Mod Pod and K-10 Version-2 (V-2) mirror systems incorporate a lock down feature that offers superior stability and easy adjustments. To position the mirror, simply loosen the set screw with a 5/32" allen wrench, lift and rotate the mirror arm into proper viewing or fold back position then retighten the set screw. Precision gears set at 12 degree intervals ensures a perfect view every time!

- Aerodynamic design features corrosion resistant stainless steel tubing brackets with chrome-plated die cast mounting base for long lasting attractive appearance
- (4) 1/4" - 20 mounting studs are factory assembled to the base for easy installation on either conventional or COE trucks
- Velvac Mod Pod mirror kits features Velvac's 8 1/2" DuraBall with nylon ball joint system, guaranteed for five years against cracking or breaking (see page M11 and M12 for details)
- K-10 V-2 mirror kits feature an 8 1/2" Eyeball convex mirror (see page M13 for details)

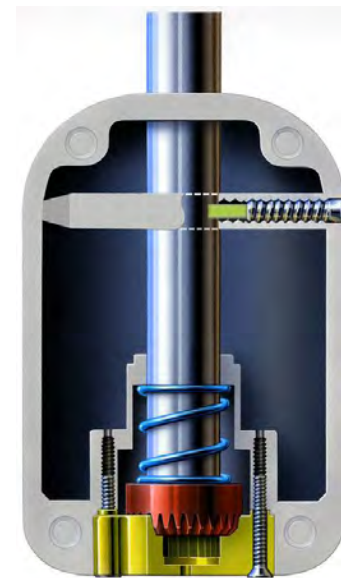

Mod Pod™ is a trademark of Velvac, Inc

	Velvac			K-10		
	Bracket Only #	Kit w/ 8 1/2" DuraBall Convex #	Kit w/ 8 1/2" DuraBall Wide View #	Bracket Only #	Kit w/ 8 1/2" Eyeball Mirror #	Kit w/ 8 1/2" K-10 Convex #
<b>Universal Adjustable</b>						
Kit with Bent & Straight Arms	714622	714620	714621	-	-	-
Kit with Straight Arm Only	-	-	-	714646	-	-
Kit with Bent Arm Only	-	-	-	714647	716915	716914
<b>Fixed Arm Dual View</b>						
Right Side	714630	714626	714628	714648	716913	-
Left Side	714631	714627	714629	715529	716922	-
<b>Fixed Arm Side View</b>						
Lane Change	714625	714623	714624	-	-	-
K-10 Slant Arm	-	-	-	714649	716917	716916
K-10 Angle Arm	-	-	-	715620	716919	716918



Bent arm



Straight arm



Fixed arm dual view



Lane change



Slant arm



Angle arm

# MIRRORS

## ALL MAKES

### Hood Mount Mirrors

- Velvac offers a full line of standard and short arm adjustable tripod mirror models to meet the needs of any vehicle or application

### Aero-Bell™ Tripod

- Stylized single piece chrome plated ABS bells and molded nylon clamps help conceal hardware, giving the mirror a clean, aerodynamic appearance
- Corrosion resistant materials eliminate rust

### Velvac Tripod

- All stainless steel construction and hardware
- Standard tripod for use on traditional hood styles; use short tripod for slope nosed vehicles with shorter hoods

### Value Tripod

- All stainless steel construction with plated hardware
- Adjustable tripod fits most hood / fender applications

	Aero-Bell Tripod	Velvac Tripod	Value Tripod
Tubing Braces	Stainless steel	Stainless steel	Stainless steel
Convex Mirror Head	8½" Stainless steel DuraBall	8½" Stainless steel DuraBall	8½" Stainless steel three screw
Mounting Bells	Molded/chrome plate ABS	Stainless steel	Stainless steel
Tube Clamps	Molded black nylon	Stainless steel	Stainless steel
Hardware	Stainless steel	Stainless steel	Plated
Packaging	Display box	Display box	Plain box

	Aero-Bell Tripod		Velvac Tripod		Value Tripod	
Standard Tripod	Part #	Dim "A"	Part #	Dim "A"	Part #	Dim "A"
Mirror & Bracket Kit	715150	21" to 32¾"	713444	21" to 32¾"	715779	26" to 35"
Bracket Only	-	-	713445	-	715778	-
Short Tripod						
Mirror & Bracket Kit	715148	17½" to 24½"	714721	17½" to 24½"	717845	17½" to 26"
Bracket Only	-	-	714720	-	717844	-

Aero-Bell™ is a trademark of Velvac, Inc



#### NOTES

See Make section of this catalog for specific applications



Aero-Bell tripod



Velvac tripod



Call the Velvac Sales Team: **800.783.8871** sales@velvac.com

© VELVAC INC. • 2405 South Calhoun Road • New Berlin, WI 53151-2709 • Toll Free: 800.783.8871 • Fax: 262.786.4101

### Hood Mount Mirrors



- Fender Mount

#### Side Support Range

11 $\frac{7}{16}$ " to 15 $\frac{5}{16}$ "

#### Main Support Range

17 $\frac{3}{4}$ " to 26 $\frac{3}{8}$ "

#### NOTES

**M/R** Manual / remote

See Make section of this catalog for specific applications

<sup>1</sup> Convex spot mirror with tripod assembly, fender mount

<sup>2</sup> Mirror only, fender mount

#### Fender Bracket Assembly

Model	Part #	Side	Color	Material	Heat
445	V594450100 <sup>1</sup>	Both	Stainless	Stainless	-

#### Convex Glass Head

Model	Part #	Glass Size	Side	Color	M/R	Heat	Light
445	V564450350 <sup>2</sup>	8"	Both	Stainless	Manual	-	-

## ALL MAKES

### Rear Cross View Mirror Systems

#### Walk-In Van Bodies

Kit #	Bracket Only #	Color	Head	Rear Door Style	Panel Mount
712644	712642	White	Velvac	A or C	Rear standard
712643	712641	Stainless steel	Velvac	A or C	Rear standard
716906	712647	Stainless steel	K-10	A or C	Rear standard
716907	713752	Stainless steel	K-10	A or C	Rear breakaway
716903	715101	Stainless steel	K-10	D	Side
716902	715101	Stainless steel w/ black ABS	K-10	D	Side

#### Rear Van Door Styles



Roll-up narrow



Roll-up full



Hinged narrow



Hinged full

- Universal mounting bracket fits walk-in vans and vehicles with flat mounting surfaces
- Kits include mirror head, reinforced 3/4" O.D. tubing arm, heavy-duty mounting brackets and stainless steel hardware
- Assemblies include either a 10" Velvac wide view convex or a 10" K-10 Eyeball roll-up narrow convex mirror

#### Panel Mount Styles



Rear standard



Rear breakaway



Side mount

### RVX™/Corner Rotator



- Designed to easily mount to structural rear corner of walk-in van or high cube bodies. Fits on 90° corner with up to 1 1/2" radius
- Includes factory assembled spring loaded bracket with Velvac 10" wide view or K-10 Eyeball convex mirror head
- Mirrors are designed to fold away and rotate

Kit #	Bracket Only #	Color	Head	Rear Door Style
715213	-	White	Velvac	A, B or C
715212	-	Stainless steel	Velvac	A, B or C
716901	714403	Stainless steel	K-10	A, B or C
716900	714403	Stainless steel w/ black ABS head	K-10	A, B or C

RVX™ is a trademark of Velvac, Inc



Call the Velvac Sales Team: **800.783.8871** sales@velvac.com

© VELVAC INC. • 2405 South Calhoun Road • New Berlin, WI 53151-2709 • Toll Free: 800.783.8871 • Fax: 262.786.4101

### Rear Cross View Mirror Systems



#### Straight Van Chassis

Kit #	Bracket Only #	Color	Head
716929	-	White	K-10
712640	712638	Stainless steel	Velvac

#### Vehicle:

Dodge and older GM and Ford Vans

- Kits include mirror head, bracket and stainless steel mounting hardware
- Assemblies include either a Velvac 8½" wide view convex or an 8½" K-10 Eyeball convex mirror

#### NOTES

See Make section of this catalog for specific applications

### Walk-In Van Mirrors



Fixed custom



Universal adjustable loop

- Universal mirrors include an adjustable loop mounting bracket that will fit most walk-in van applications
- Fixed custom mirrors include a fixed loop bracket for specific mounting applications
- All mirrors include 6½"w x 10"h upper flat glass head and 6½"w x 6"h lower convex

Part #	Application	Description	Color	Mounting Centers	Loop Leg Length
<b>Universal</b>					
721090	Various	Complete pair	Stainless steel	22" to 36.5"	8"
721092	Various	Loop and brackets	Stainless steel	22" to 36.5"	8"
<b>Fixed Custom</b>					
712323	Grumman (Morgan) Utilimaster	Complete pair	Stainless steel	30.57"	10.5"
713404	Utilimaster	Complete pair	Stainless steel	33.33"	11.69"
724007	Various	Complete pair	Stainless steel	30.37"	10.42"
724008	Various	Complete pair	Stainless steel	33"	8"
727067	Various	Complete pair	Stainless steel	33"	8"



## ALL MAKES

### Van and Cab Chassis Mirrors



Retractable



Non Retractable

### Universal Van and Pick-Up Truck

Part #	Color	Bracket Style	Body Type Width
714673	Stainless steel	Retractable	Straight van
714675	Stainless steel	Non retractable	96" Cutaway

#### Vehicle:

Ford E Van, GM G Van and Dodge Ram Van

Part #	Color	Bracket Style	Body Type Width
714672	Stainless steel	Retractable	Pick-up
714674	Stainless steel	Non retractable	96" Cab chassis

#### Vehicle:

Older model GM Silverado, Ford F Series and Dodge Ram Truck

### Universal Low Mount Mirror System and Accessories

- Low mount mirror kit includes stainless steel bracket system, solid stainless steel elbow and 7½" x 10½" mirror head
- Wide angle conversion kit includes 6½" x 6" convex and stainless steel tube support for blind spot viewing
- Mirror heads provide over 63 square inches of flat viewing area (See page M18 for more information)



Low mount mirror kit



712245

Part #	Description	Color
712479	Low mount mirror kit: bracket, head elbow - pair	Stainless steel
748216	Replacement elbow	Stainless steel
712245	Wide angle conversion kit - one side	Stainless steel



Call the Velvac Sales Team: **800.783.8871** sales@velvac.com

© VELVAC INC. • 2405 South Calhoun Road • New Berlin, WI 53151-2709 • Toll Free: 800.783.8871 • Fax: 262.786.4101



### Truck and Tractor Mirrors

- Versatile head and loop assembly for flat side mounting on fire trucks and other specialty vehicles
- Bracket mounting span of 31 1/2" x 8.18" from body leg length
- All stainless steel construction with preset pivot breakaway system

Part #	Description	Color	Upper Head	Lower Head
713760	Complete pair	Stainless steel	8" x 16" Remote heated west coast mirror	6 1/2" x 6" Convex
713769	Complete pair	Stainless steel	7" x 16" OE V-back west coast mirror	6 1/2" x 6" Convex
713759	Replacement loop bracket, mounting feet and hardware	Stainless steel	N/A	N/A

#### NOTES

See page M2 for more information on remote mirror head

See page M3 for OE V-back West Coast

### Universal Bracket Kit and Head/Loop System

- Universal stainless steel bracket kit is fully adjustable to fit a variety of conventional straight truck and tractor doors; it extends out a maximum of 20" from door
- Use head and loop assemblies in combination with universal bracket kit to produce a complete major system for conventional truck and tractors; loop span is 17.56"

- All kits shown below are packaged as pairs. Loop and clamp kits include both short clamps for use with split wide angle heads and long clamps for west coast heads



West coast<sup>2</sup>



Split head<sup>1</sup>

Conventional tractor bracket kit

Part #	Description	Color	Upper Head	Lower Head
700064	Universal conventional tractor bracket kit	Stainless steel	N/A	N/A
701001	Head and loop - split head	White	6 1/2" x 10"	6 1/2" x 6"
701006	Head and loop - split head	Stainless steel	6 1/2" x 10"	6 1/2" x 6"
701050	Head and loop - west coast	White	7" x 16"	N/A
701054	Head and loop - west coast	Stainless steel	7" x 16"	N/A
701071	Loop and clamp kit	White	N/A	N/A
701072	Loop and clamp kit	Stainless steel	N/A	N/A

#### NOTES

<sup>1</sup> See page M21 and M22 for replacement mirror heads

<sup>2</sup> See page M4 and M5 for replacement mirror heads

# MIRRORS

## MIRROR AND SERVICE PARTS FOR SPECIFIC VEHICLE APPLICATIONS

Velvac now offers a wide variety of mirrors and parts for specific applications including:

- Complete assemblies
- Replacement heads and covers
- Brackets
- Glass kits

**NOTE**

Not all parts on vehicle models are available



## CATERPILLAR

### 461 System | CT660



**Vehicle:**

CT660 (2011-Present)

- Fits 1 1/8" tube

**Head Size**

8 1/8" w x 20 5/16" h x 5" d

**NOTES**

<sup>1</sup> Furnished with cable assembly without turn signal

<sup>2</sup> Furnished with cable assembly for turn signal

Bracket, head and glass not available. Contact OE to purchase.

### Flat Mirror Actuators

Model	Part #	O.E.M.	Side
461	V614610002 <sup>1</sup>	2609911C91	Both
461	V614610003 <sup>2</sup>	2609912C91	Both



Call the Velvac Sales Team: **800.783.8871** [sales@velvac.com](mailto:sales@velvac.com)

© VELVAC INC. • 2405 South Calhoun Road • New Berlin, WI 53151-2709 • Toll Free: 800.783.8871 • Fax: 262.786.4101

Cyclone® & Typhoon® Aerials, Custom Chassis, Custom Pumps, Rescue  
| **407 System**



### Vehicle:

Cyclone® & Typhoon® Aerials,  
Custom Chassis, Custom Pumps,  
Rescue (2004-Present)

- Fits 1-1/8" tube

### Head Size

8 1/16" w x 15 1/16" h x 5 1/4" d

### Accessories

- **Marker Light Kit w/ Bezel**  
Model 427 | Part # **V114272001**
- **Head Clamp & Screws Kit**  
Model 400 | Part # **V614000010**
- **2-Mirror Switch**  
Part # **V083200233**  
(OEM 687993)

### NOTES

**M/R** Manual / remote

<sup>1</sup> Furnished with wiring harness for flat remote, flat/convex heat, marker light and turn signal

<sup>2</sup> Chrome backcover with chrome housing

- For Commercial Pumps, Tankers, Emax, Tradition™, Watermaster™ and Rescue consult specific make/model section of this catalog.

### Side Mount Bracket

Model	Part #	Dimension "A"	Dimension "B"	Side	Color	Material
407	<b>V584070500<sup>1</sup></b>	31 3/4"	8 7/16"	Both	Stainless	Stainless

- Dimension A: Distance between upper and lower bracket holder mounting holes
- Dimension B: Distance between the outside edge of the mirror bracket and the mounting surface

### Flat Glass Head *Glass adjustable*

Model	Part #	Glass Size	Side	Color	M/R	Heat	Light
427	<b>V514270018<sup>2</sup></b>	7 1/4" w x 14 1/4" h	Right	Chrome	Remote	•	•
427	<b>V514270017<sup>2</sup></b>	7 1/4" w x 14 1/4" h	Left	Chrome	Remote	•	•

### Flat Glass Kit

Model	Part #	O.E.M.	Glass Size	Side	Color	M/R	Heat
427	<b>V154270011</b>	687992003	7 1/2" w x 14 1/4" h	Both	Black	Both	•

**NOTE: Part numbers listed in RED are NEW!**

## E-ONE

### 407 System

Continued

#### Mirror Cover

Model	Part #	Side	Color	Light
427	V134271009 <sup>3</sup>	Both	Chrome	•
427	V614271007 <sup>3,4</sup>	Both	Chrome	•

#### Convex Glass Head *Glass adjustable*

Model	Part #	Glass Size	Side	Color	M/R	Heat	Light
428	V564281015 <sup>5,6</sup>	7 <sup>3</sup> / <sub>4</sub> " x 5 <sup>3</sup> / <sub>4</sub> "	Both	Chrome	Manual	•	-

#### Convex Glass Kit

Model	Part #	O.E.M.	Glass Size	Side	Color	M/R	Heat
428	V154280003 <sup>5</sup>	687992004	7 <sup>3</sup> / <sub>4</sub> " x 5 <sup>3</sup> / <sub>4</sub> "	Both	Black	Manual	•

#### Convex Mirror Cover

Model	Part #	Side	Color	Light
428	V134281015	Both	Chrome	-

#### NOTES

<sup>3</sup> Furnished with punched holes

<sup>4</sup> Kit furnished with marker light

<sup>5</sup> Furnished with turn signal

<sup>6</sup> Chrome backcover with chrome housing

#### Flat Mirror Actuator

Model	Part #	Side
427	V084270006	Both



Call the Velvac Sales Team: **800.783.8871** [sales@velvac.com](mailto:sales@velvac.com)

© VELVAC INC. • 2405 South Calhoun Road • New Berlin, WI 53151-2709 • Toll Free: 800.783.8871 • Fax: 262.786.4101



## FERRARA FIRE APPARATUS

FD-100, HD-57, HD-77, HD-107, LP-102 Ladders. Mid & Rear Mount Platforms. Ember, Igniter, Infer-, Intruder 2, Ultra Pumpers. Custom Tankers. Heavy Rescues. Type I Wildland | **407 System**



### Vehicle:

FD-100, HD-57, HD-77, HD-107, LP-102 Ladders. Mid & Rear Mount Platforms. Ember, Igniter, Infer-, Intruder 2, Ultra Pumpers. Custom Tankers. Heavy Rescues. Type I Wildland (2006-Present)

- Fits 1-1/8" tube

### Head Size

8 1/16" w x 15 1/16" h x 5 1/4" d

### NOTES

**M/R** Manual / remote

<sup>1</sup> Furnished less electrical harness. Contact Velvac for specific part numbers and availability

<sup>2</sup> Chrome backcover with chrome housing

- For Commercial 2/4 Door Pumpers, Tankers, Medium Rescue and Wildlands Type III, consult specific vehicle make/model section of this catalog.

### Side Mount Bracket

Model	Part #	Dimension "A"	Dimension "B"	Side	Color	Material
407	V584070330 <sup>1</sup>	35"	8 7/16"	Both	Stainless	Stainless
407	V584070340 <sup>1</sup>	35"	6 7/16"	Both	Stainless	Stainless

- Dimension A: Distance between upper and lower bracket holder mounting holes
- Dimension B: Distance between the outside edge of the mirror bracket and the mounting surface

### Flat Glass Head Glass adjustable

Model	Part #	O.E.M.	Glass Size	Side	Color	M/R	Heat	Light
427	V514270016 <sup>2</sup>	-	7 1/4" w x 14 1/4" h	Right	Chrome	Remote	•	-
427	V514270015 <sup>2</sup>	-	7 1/4" w x 14 1/4" h	Left	Chrome	Remote	•	-
427	V514270122	DS514270122	7 1/4" w x 14 1/4" h	Right	Black	Remote	•	-
427	V514270121	DS514270121	7 1/4" w x 14 1/4" h	Left	Black	Remote	•	-

### Flat Glass Kit

Model	Part #	O.E.M.	Glass Size	Side	Color	M/R	Heat
427	V154270011	101445027	7 1/4" w x 14 1/4" h	Both	Black	Both	•

**NOTE: Part numbers listed in RED are NEW!**

## FERRARA FIRE APPARATUS

### 407 System

Continued

#### Mirror Cover

Model	Part #	O.E.M.	Side	Color	Light
427	V134271008	-	Both	Chrome	-
427	V134271000	DS134271000 101445029	Both	Black	-

#### Accessories

- **Head Clamp & Screws Kit**  
Model 400 | Part # V614000010

#### NOTES

<sup>2</sup> Chrome backcover with chrome housing

#### Convex Glass Head Glass adjustable

Model	Part #	O.E.M.	Glass Size	Side	Color	M/R	Heat	Light
428	V564281014 <sup>2</sup>	-	7¾"w x 5¾"h	Both	Chrome	Manual	•	-
428	V564281002	DS564281002	7¾"w x 5¾"h	Both	Black	Manual	•	-

#### Convex Glass Kit

Model	Part #	O.E.M.	Glass Size	Side	Color	M/R	Heat
428	V154280002	101445028	7¾"w x 5¾"h	Both	Black	Manual	•

#### Convex Mirror Cover

Model	Part #	O.E.M.	Side	Color	Light
428	V134281015	-	Both	Chrome	-
428	V134281011	DS134281011	Both	Black	-

#### Flat Mirror Actuator

Model	Part #	Side
427	V084270006	Both



Call the Velvac Sales Team: **800.783.8871** [sales@velvac.com](mailto:sales@velvac.com)

© VELVAC INC. • 2405 South Calhoun Road • New Berlin, WI 53151-2709 • Toll Free: 800.783.8871 • Fax: 262.786.4101

## FORD & GM 2020 VAN AND CAB CHASSIS MIRRORS

- Velvac's 2020 and 2020XG family of mirrors feature OE fit and styling, and provide outstanding visibility of passing lanes and blind spots around the vehicle, making them the industry standard for wide body cutaway van and truck cab chassis applications. These mirrors mount directly to the OE sail area on the door for clean and easy installation. The modular design allows a single mirror style to be used across multiple van and truck platforms, making them perfect for all OE and fleet applications. In addition to the original 2020 mirrors, Velvac now offers a new 2020 Mini-LEM system with integrated camera options and our new 2020XG, the next generation in wide body mirror technology



Standard



Deluxe

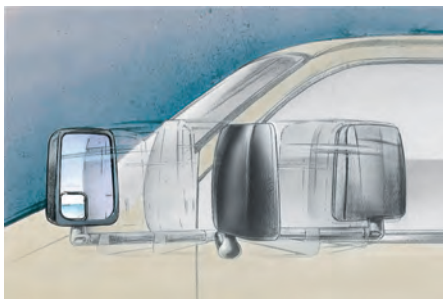

Unique pivot design



### Model 2020 Mirror System

- Model 2020 mirrors are designed specifically for wide body applications such as high cube cutaway vans, rental trucks, Class C RV's and ambulances. The fixed length arms are designed to position the mirror beyond the body providing the driver with an unobstructed view of blind spots and passing lanes around the vehicle. These versatile mirrors are available in several body widths and finishes as well as manual or heated remote glass
- Mirrors available for 86", 96" and 102" wide bodies
- Die cast arms and bases are e-coated and powder coated for corrosion resistance
- Available in black, white and black base/arm with chrome head
- Two mirror head options:
  - Standard head with lower wedge convex
  - Deluxe head with full width lower convex
- Fold away feature allows mirrors to fold forward and back for easy vehicle storage and protection against impact

### Model 2020 Mini-LEM Mirror System

- Velvac has added the exclusive pre-positioned lower camera option to the 2020 mirror, providing even greater coverage of the blind spot areas around the vehicle. These mirrors are available with either a black and white CCD camera or the featured CMOS color camera for even greater clarity and object detection
- Camera image is reversed to provide a picture in the same orientation as the mirror image for seamless observation of blind spots and passing lanes
- CMOS color camera with infrared LED's provide greater image definition, truer colors and anti-blooming technology, allowing drivers to quickly identify objects in a variety of light conditions
- Systems can be designed to integrate with back-up cameras for complete vehicle blind spot coverage. See [Vision Systems](#) section for more information on Velvac's back-up cameras and CMOS camera technology



Mini-LEM Camera

2020 Mini-LEM with turn signal option in flat glass

**NOTE: Part numbers listed in RED are NEW!**

## FORD & GM 2020XG VAN AND CAB CHASSIS MIRRORS

### Model 2020XG Mirror Systems

- A combination of styling, quality and performance make the 2020XG the new benchmark for wide body mirror systems. The fully integrated arm, base and mirror head look stylish, and together reduce vibration and provide large, clear views of the blind spots and passing lanes. Since these mirrors are designed specifically for 96" and 102" wide bodies, they provide a complete vision solution with no compromising



### Style/Value

- Fully integrated base, arm and mirror head for a clean OE look
- "Swept back" design prepositions the mirror in the optimal location; no head adjustment necessary
- Stylized mirror base fits directly in the OE "sail area" mounting holes
- Rigid design for better stability and image clarity
- Easily replaceable mirror head, glass and arm components help reduce downtime and service costs

### Quality

- Die cast aluminum mounting base and upper arm are e-coated and powder coated for corrosion protection
- OEM-approved plastic mirror shell and lower arm deliver durability and UV resistance
- Pivot system allows the mirror to be folded forward or back upon impact and returned easily to the normal driving position

### Increased safety

- Advanced vibration dampening in mirror head keeps image steady even on rough road surfaces
- 63 sq. in. flat glass and 29½ sq. in. convex glass with 18" ROC provides great visibility of the passing lanes and blind spots around the vehicle

### Field of View Coverage

- Field of view diagram below shows the superior vision and blind spot coverage provided by Velvac 2020 and 2020XG mirrors relative to typical OE mirrors used on a wide body applications. Velvac's 2020 and 2020XG mirrors can help to reduce blind spots and provide visibility of multiple passing lanes around the vehicle leading to better driving decisions and the reduction of costly accidents

### Helpful hint:

Most cutaway van and cab chassis OE mirrors are not designed for body widths that extend beyond 96 & 102 inches. Misuse of these narrow OE mirrors leads to obstructed views and dangerous blind spots and may not fully meet all DOT mirror requirements based on these applications. Be confident that your wide body vehicle meets or exceeds FMVSS 111 requirements for Rear View Mirrors with Velvac's mirrors

Field of View Comparison

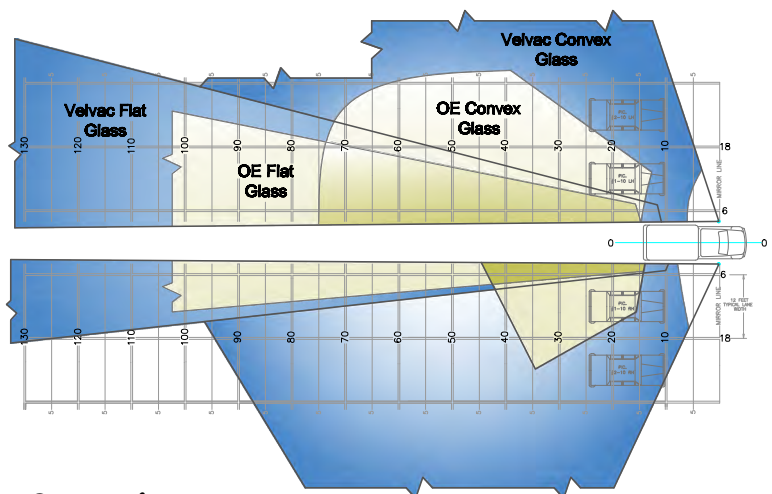

### Field of View Comparison

OV coverage: Velvac (blue), OE (green)

Information shown above represents a typical vision pattern when using Velvac 2020 or 2020XG mirrors compared to a typical OE option mirror



Call the Velvac Sales Team: **800.783.8871** sales@velvac.com

E-Series Cutaway Van | **2020 System**



Standard



Deluxe

- **Flat Glass**

Standard 57 sq. in.  
Deluxe 62 sq. in

- **Convex Glass**

Standard wedge 10 sq. in. | 8" ROC  
Deluxe full 30 sq. in. | 12" ROC

**Vehicle:**

E-Series Cutaway Van Mirrors  
(2003-Present)

### 86" Body Width

Model	Pair Part #	Left Side #	Right Side #	Color	Head	Flat Glass	Convex Glass	Options
2020	715401	715403	715402	Black	Standard	Manual	-	-
2020	715419	715421	715420	Black	Standard	Heat / Remote	-	-
2020	715410	715411	715412	White	Standard	Manual	-	-
2020	715428	715429	715430	White	Standard	Heat / Remote	-	-

### 96" Body Width

Model	Pair Part #	Left Side #	Right Side #	Color	Head	Flat Glass	Convex Glass	Options
2020	715404	715405	715406	Black	Standard	Manual	-	-
2020	715422	715423	715424	Black	Standard	Heat / Remote	-	-
2020	715455	715457	715456	Black	Standard	Heat / Remote	-	Light
2020	715449	715451	715450	Black	Deluxe	Manual	Manual	-
2020	715437	715439	715438	Black	Deluxe	Heat / Remote	Heat / Manual	Light
2020	715413	715415	715414	White	Standard	Manual	-	-
2020	715431	715433	715432	White	Standard	Heat / Remote	-	-
2020	715443	715445	715444	White	Deluxe	Heat / Remote	H/M	Light

### 102" Body Width

Model	Pair Part #	Left Side #	Right Side #	Color	Head	Flat Glass	Convex Glass	Options
2020	715407	715409	715408	Black	Standard	Manual	-	-
2020	715425	715427	715426	Black	Standard	Heat / Remote	-	-
2020	715458	715459	715460	Black	Standard	Heat / Remote	-	Light
2020	715452	715453	715454	Black	Deluxe	Manual	Manual	-
2020	715440	715441	715442	Black	Deluxe	Heat / Remote	Heat / Manual	Light
2020	715416	715417	715418	White	Standard	Manual	-	-
2020	715434	715435	715436	White	Standard	Heat / Remote	-	-
2020	715446	715447	715448	White	Deluxe	Heat / Remote	Heat / Manual	Light

**NOTES**

**Light** Lighted arm

\*All remote mirror PAIRS include switches and wire harnesses. These items are NOT included when remote mirrors are sold as sides

Pre-2003 mirror service parts can be found on [www.velvac.com](http://www.velvac.com) by searching with a keyword "1992-2002 Ford"



# MIRRORS

## FORD

### 2020 Mini-LEM System w/ Color Camera | E-Series Cutaway Van



- **Flat Glass**  
62 sq. in
- **Convex Glass**  
30 sq. in. | 12" ROC

#### Vehicle:

E-Series Cutaway Van Mirrors  
(2003-Present)

#### 96" Body Width

Model	Pair Part #	Left Side #	Right Side #	Color	Head	Flat Glass	Convex Glass	Options
2020	719311	719313	719312	Black	Deluxe	Manual	Manual	-
2020	719317	719319	719318	Black	Deluxe	Heat / Remote	Heat / Manual	-
2020	719326	719327	719328	Black	Deluxe	Heat / Remote	Heat / Manual	Light
2020	719335	719337	719336	Black	Deluxe	Heat / Remote	Heat / Manual	Signal
2020	719344	719345	719346	Black	Deluxe	Heat / Remote	Heat / Manual	Signal / Light
2020	719314	719315	719316	White	Deluxe	Manual	Manual	-
2020	719320	719321	719322	White	Deluxe	Heat / Remote	Heat / Manual	-
2020	719329	719331	719330	White	Deluxe	Heat / Remote	Heat / Manual	Light
2020	719338	719339	719340	White	Deluxe	Heat / Remote	Heat / Manual	Signal
2020	719347	719349	719348	White	Deluxe	Heat / Remote	Heat / Manual	Signal / Light
2020	719323	719325	719324	Chrome	Deluxe	Heat / Remote	Heat / Manual	-
2020	719332	719333	719334	Chrome	Deluxe	Heat / Remote	Heat / Manual	Light
2020	719341	719343	719342	Chrome	Deluxe	Heat / Remote	Heat / Manual	Signal
2020	719350	719351	719352	Chrome	Deluxe	Heat / Remote	Heat / Manual	Signal / Light

#### 102" Body Width

Model	Pair Part #	Left Side #	Right Side #	Color	Head	Flat Glass	Convex Glass	Options
2020	719353	719355	719354	Black	Deluxe	Manual	Manual	-
2020	-	719361	719360	Black	Deluxe	Heat / Remote	Heat / Manual	-
2020	719368	719369	719370	Black	Deluxe	Heat / Remote	Heat / Manual	Light
2020	719379	719381	719380	Black	Deluxe	Heat / Remote	Heat / Manual	Signal
2020	719388	719389	719390	Black	Deluxe	Heat / Remote	Heat / Manual	Signal / Light
2020	719356	719357	719358	White	Deluxe	Manual	Manual	-
2020	719362	719363	719364	White	Deluxe	Heat / Remote	Heat / Manual	-
2020	719371	719373	719372	White	Deluxe	Heat / Remote	Heat / Manual	Light
2020	719382	719383	719384	White	Deluxe	Heat / Remote	Heat / Manual	Signal
2020	719391	719393	719392	White	Deluxe	Heat / Remote	Heat / Manual	Signal / Light
2020	719365	719367	719366	Chrome	Deluxe	Heat / Remote	Heat / Manual	-
2020	719374	719375	719376	Chrome	Deluxe	Heat / Remote	Heat / Manual	Light
2020	719385	719387	719386	Chrome	Deluxe	Heat / Remote	Heat / Manual	Signal
2020	719394	719395	719396	Chrome	Deluxe	Heat / Remote	Heat / Manual	Signal / Light

#### NOTES

**Light** Lighted arm  
**Signal** Signal arrow in glass

\*All remote mirror PAIRS include switches and wire harnesses. These items are NOT included when remote mirrors are sold as sides

Pre-2003 mirror service parts can be found on [www.velvac.com](http://www.velvac.com) by searching with a keyword "1992-2002 Ford"



Call the Velvac Sales Team: **800.783.8871** [sales@velvac.com](mailto:sales@velvac.com)

© VELVAC INC. • 2405 South Calhoun Road • New Berlin, WI 53151-2709 • Toll Free: 800.783.8871 • Fax: 262.786.4101

**E-Series Cutaway Van | 2020XG System**

**Vehicle:**

 E-Series Cutaway Van Mirrors  
(2003-Present)

- **Flat Glass**  
64 sq. in
- **Convex Glass**  
29 sq. in. | 18" ROC

**96" Body Width**

Model	Pair Part #	Left Side #	Right Side #	Color	Flat Glass	Convex Glass	Options
2020XG	715899	715901	715900	Black	Manual	Manual	-
2020XG	715905	715907	715906	Black	Heat / Remote	Heat / Manual	-
2020XG	716346	716347	716348	Black	Heat / Remote	Heat / Manual	Light
2020XG	716343	716345	716344	Black	Heat / Remote	Heat / Manual	Signal
2020XG	715902	715903	715904	White	Manual	Manual	-
2020XG	715908	715909	715910	White	Heat / Remote	Heat / Manual	-
2020XG	716382	716383	716384	White	Heat / Remote	Heat / Manual	Light
2020XG	716379	716381	716380	White	Heat / Remote	Heat / Manual	Signal
2020XG	715953	715955	715954	Chrome	Heat / Remote	Heat / Manual	-
2020XG	716414	716415	716416	Chrome	Heat / Remote	Heat / Manual	Light
2020XG	716411	716413	716412	Chrome	Heat / Remote	Heat / Manual	Signal

**102" Body Width**

Model	Pair Part #	Left Side #	Right Side #	Color	Flat Glass	Convex Glass	Options
2020XG	715923	715925	715924	Black	Manual	Manual	-
2020XG	715929	715931	715930	Black	Heat / Remote	Heat / Manual	-
2020XG	716322	716323	716324	Black	Heat / Remote	Heat / Manual	Light
2020XG	716319	716321	716320	Black	Heat / Remote	Heat / Manual	Signal
2020XG	715926	715927	715928	White	Manual	Manual	-
2020XG	715932	715933	715934	White	Heat / Remote	Heat / Manual	-
2020XG	716370	716371	716372	White	Heat / Remote	Heat / Manual	Light
2020XG	716367	716369	716368	White	Heat / Remote	Heat / Manual	Signal
2020XG	715971	715973	715972	Chrome	Heat / Remote	Heat / Manual	-
2020XG	716394	716395	716396	Chrome	Heat / Remote	Heat / Manual	Light
2020XG	716391	716393	716392	Chrome	Heat / Remote	Heat / Manual	Signal

**NOTES**
**Light** Lighted head

**Signal** Signal arrow in glass

**Chrome** Chrome head with black arm and base

\*All remote mirror PAIRS include switches and wire harnesses. These items are NOT included when remote mirrors are sold as sides

Pre-2003 mirror service parts can be found on [www.velvac.com](http://www.velvac.com) by searching with a keyword "1992-2002 Ford"

# MIRRORS

## FORD

### 2020XG System | Ford F Series



#### Vehicle:

Ford F Series

- **Flat Glass**  
64 sq. in
- **Convex Glass**  
29 sq. in. | 18" ROC

#### 96" Body Width

Model	Pair Part #	Left Side #	Right Side #	Color	Head	Flat Glass	Convex Glass	Options
2020XG	716355	716357	716356	Black	Deluxe	Manual	Manual	-
2020XG	716358	716359	716360	Black	Deluxe	Heat / Remote	Heat / Manual	-
2020XG	716364	716365	716366	Black	Deluxe	Heat / Remote	Heat / Manual	Light
2020XG	716361	716363	716362	Black	Deluxe	Heat / Remote	Heat / Manual	Signal
2020XG	716423	716425	716424	Chrome	Deluxe	Heat / Remote	Heat / Manual	-
2020XG	716429	716431	716430	Chrome	Deluxe	Heat / Remote	Heat / Manual	Light
2020XG	716426	716427	716428	Chrome	Deluxe	Heat / Remote	Heat / Manual	Signal

#### 102" Body Width

Model	Pair Part #	Left Side #	Right Side #	Color	Head	Flat Glass	Convex Glass	Options
2020XG	716331	716333	716332	Black	Deluxe	Manual	Manual	-
2020XG	716334	716335	716336	Black	Deluxe	Heat / Remote	Heat / Manual	-
2020XG	716340	716341	716342	Black	Deluxe	Heat / Remote	Heat / Manual	Light
2020XG	716337	716339	716338	Black	Deluxe	Heat / Remote	Heat / Manual	Signal
2020XG	716402	716403	716404	Chrome	Deluxe	Heat / Remote	Heat / Manual	-
2020XG	716408	716409	716410	Chrome	Deluxe	Heat / Remote	Heat / Manual	Light
2020XG	716405	716407	716406	Chrome	Deluxe	Heat / Remote	Heat / Manual	Signal

#### NOTES

**Light** Lighted head

**Signal** Signal arrow in glass

**Chrome** Chrome head with black arm and base

\*All remote mirror PAIRS include switches and wire harnesses. These items are NOT included when remote mirrors are sold as sides

Pre-2003 mirror service parts can be found on [www.velvac.com](http://www.velvac.com) by searching with a keyword "1992-2002 Ford"



Call the Velvac Sales Team: **800.783.8871** [sales@velvac.com](mailto:sales@velvac.com)

© VELVAC INC. • 2405 South Calhoun Road • New Berlin, WI 53151-2709 • Toll Free: 800.783.8871 • Fax: 262.786.4101

E-Series Cutaway Van | **2020XG Mini-LEM System**

**Vehicle:**

 E-Series Cutaway Van Mirrors  
(2003-Present)

- **Flat Glass**  
64 sq. in
- **Convex Glass**  
29 sq. in. | 18" ROC

**96" Body Width**

Model	Pair Part #	Left Side #	Right Side #	Color	Head	Flat Glass	Convex Glass	Options
2020XG	717516	717517	717518	Black	Deluxe	Heat / Remote	Heat / Manual	-
2020XG	717523	717525	717524	Black	Deluxe	Heat / Remote	Heat / Manual	Signal
2020XG	718612	718613	718614	White	Deluxe	Heat / Remote	Heat / Manual	-
2020XG	717541	717543	717542	Chrome	Deluxe	Heat / Remote	Heat / Manual	-
2020XG	717544	717545	717546	Chrome	Deluxe	Heat / Remote	Heat / Manual	Signal

**102" Body Width**

Model	Pair Part #	Left Side #	Right Side #	Color	Head	Flat Glass	Convex Glass	Options
2020XG	717504	717505	717506	Black	Deluxe	Heat / Remote	Heat / Manual	-
2020XG	717526	717527	717528	Black	Deluxe	Heat / Remote	Heat / Manual	Signal
2020XG	718615	718617	718616	White	Deluxe	Heat / Remote	Heat / Manual	-
2020XG	717507	717509	717508	Chrome	Deluxe	Heat / Remote	Heat / Manual	-
2020XG	717547	717549	717548	Chrome	Deluxe	Heat / Remote	Heat / Manual	Signal

**NOTES**

**Signal** Signal arrow in glass

**Chrome** Chrome head with black arm and base

\*All remote mirror PAIRS include switches and wire harnesses. These items are NOT included when remote mirrors are sold as sides

Pre-2003 mirror service parts can be found on [www.velvac.com](http://www.velvac.com) by searching with a keyword "1992-2002 Ford"

# MIRRORS

## FORD

### 2020XG Mini-LEM System | Ford F Series



#### Vehicle:

Ford F Series

- **Flat Glass**  
64 sq. in
- **Convex Glass**  
29 sq. in. | 18" ROC

#### 96" Body Width

Model	Pair Part #	Left Side #	Right Side #	Color	Head	Flat Glass	Convex Glass	Options
2020XG	717586	717587	717588	Black	Deluxe	Heat / Remote	Heat / Manual	-
2020XG	717589	717591	717590	Black	Deluxe	Heat / Remote	Heat / Manual	Signal
2020XG	717598	717599	717600	Chrome	Deluxe	Heat / Remote	Heat / Manual	-
2020XG	717601	717603	717602	Chrome	Deluxe	Heat / Remote	Heat / Manual	Signal

#### 102" Body Width

Model	Pair Part #	Left Side #	Right Side #	Color	Head	Flat Glass	Convex Glass	Options
2020XG	717592	717593	717594	Black	Deluxe	Heat / Remote	Heat / Manual	-
2020XG	717595	717597	717596	Black	Deluxe	Heat / Remote	Heat / Manual	Signal
2020XG	717607	717609	717608	Chrome	Deluxe	Heat / Remote	Heat / Manual	Signal

#### NOTES

**Signal** Signal arrow in glass

**Chrome** Chrome head with black arm and base

\*All remote mirror PAIRS include switches and wire harnesses. These items are NOT included when remote mirrors are sold as sides

Pre-2003 mirror service parts can be found on [www.velvac.com](http://www.velvac.com) by searching with a keyword "1992-2002 Ford"



Call the Velvac Sales Team: **800.783.8871** [sales@velvac.com](mailto:sales@velvac.com)

© VELVAC INC. • 2405 South Calhoun Road • New Berlin, WI 53151-2709 • Toll Free: 800.783.8871 • Fax: 262.786.4101



### Ford F450 - F550 | 2020XG System w/ OAT



#### Vehicle:

Ford F450 - F550 Series

- **Flat Glass**  
64 sq. in
- **Convex Glass**  
29 sq. in. | 18" ROC

#### 96" Body Width

Model	Pair Part #	Left Side #	Right Side #	Color	Head	Flat Glass	Convex Glass	Options
2020XG	717379	717381	717380	Black	Deluxe	Manual	Manual	-
2020XG	717181	717183	717182	Black	Deluxe	Heat / Remote	Heat / Manual	-
2020XG	717174	717175	717176	Black	Deluxe	Heat / Remote	Heat / Manual	Light
2020XG	717513	717515	717514	Chrome	Deluxe	Heat / Remote	Heat / Manual	-

#### 102" Body Width

Model	Pair Part #	Left Side #	Right Side #	Color	Head	Flat Glass	Convex Glass	Options
2020XG	717382	717383	717384	Black	Deluxe	Manual	Manual	-
2020XG	717187	717189	717188	Black	Deluxe	Heat / Remote	Heat / Manual	-
2020XG	717184	717185	717186	Black	Deluxe	Heat / Remote	Heat / Manual	Light
2020XG	717501	717503	717502	Chrome	Deluxe	Heat / Remote	Heat / Manual	-

#### NOTES

**Light** Lighted arm

\*All remote mirror PAIRS include switches and harnesses - except new mirrors with OAT

\*\* New mirrors with OAT (outside air temperature) connect directly to OE harness and are controlled by Ford heat, power and light controls for fast and easy installation

### Ford F450 - F550 | 2020XG Mini LEM System w/ OAT



#### Vehicle:

Ford F450 - F550 Series

- **Flat Glass**  
64 sq. in
- **Convex Glass**  
29 sq. in. | 18" ROC

#### 102" Body Width

Model	Pair Part #	Left Side #	Right Side #	Color	Head	Flat Glass	Convex Glass	Options
2020XG	717866	717867	717868	Chrome	Deluxe	Heat / Remote	Heat / Manual	-

#### NOTES

\*All remote mirror PAIRS include switches and harnesses - except new mirrors with OAT

\*\* New mirrors with OAT (outside air temperature) connect directly to OE harness and are controlled by Ford heat, power and light controls for fast and easy installation

# MIRRORS

## FORD

### 2020 System | Ford F Series



Standard



Deluxe

#### Vehicle:

Ford F Series

- **Flat Glass**

Standard 57 sq. in.

Deluxe 62 sq. in

- **Convex Glass**

Standard wedge 10 sq. in. | 8" ROC

Deluxe full 30 sq. in. | 12" ROC

#### 86" Body Width

Model	Pair Part #	Left Side #	Right Side #	Color	Head	Flat Glass	Convex Glass	Options
2020	715141	715154	715153	Black	Standard	Manual	-	-

#### 96" Body Width

Model	Pair Part #	Left Side #	Right Side #	Color	Head	Flat Glass	Convex Glass	Options
2020	714527	714529	714528	Black	Standard	Manual	-	-
2020	714533	714535	714534	Black	Standard	Heat / Remote	-	-
2020	714539	714541	714540	Black	Standard	Heat / Remote	-	Light
2020	714515	714517	714516	Black	Deluxe	Manual	Manual	-
2020	714521	714523	714522	Black	Deluxe	Heat / Remote	Heat / Manual	Light
2020	715859	715861	715860	Chrome	Deluxe	Heat / Remote	Heat / Manual	Light

#### 102" Body Width

Model	Pair Part #	Left Side #	Right Side #	Color	Head	Flat Glass	Convex Glass	Options
2020	714530	714531	714532	Black	Standard	Manual	-	-
2020	714536	714537	714538	Black	Standard	Heat / Remote	-	-
2020	714542	714543	714544	Black	Standard	Heat / Remote	-	Light
2020	714518	714519	714520	Black	Deluxe	Manual	Manual	-
2020	714524	714525	714526	Black	Deluxe	Heat / Remote	Heat / Manual	Light
2020	715131	715133	715132	White	Deluxe	Heat / Remote	Heat / Manual	Light

#### NOTES

**Light** Lighted arm

\*All remote mirror PAIRS include switches and harnesses



Call the Velvac Sales Team: **800.783.8871** [sales@velvac.com](mailto:sales@velvac.com)

© VELVAC INC. • 2405 South Calhoun Road • New Berlin, WI 53151-2709 • Toll Free: 800.783.8871 • Fax: 262.786.4101

### Ford E Van | 2020SS Shuttle Mirror System



Superstar



Deluxe mirror head w/ mini LEM



#### Vehicle:

Ford E Van

- **Flat Glass**

Superstar 51½ sq in

Deluxe 63.3 sq in

- **Convex Glass**

Superstar 23½ sq. in.

Deluxe 30 sq. in.

#### 96" Body Width

Model	Pair Part #	Left Side #	Right Side #	Head	Flat Glass	Convex Glass	Options
2020SS	728730	728731	728732	Superstar	Manual	Manual	-
2020SS	728733	728735	728734	Deluxe	Manual	Manual	-
2020SS	728736	728737	728738	Deluxe	Heat / Remote	Heat	-
2020SS	728739	728741	728740	Deluxe	Heat / Remote	Heat	Light
2020SS	728742	728743	728744	Deluxe	Heat / Remote	Heat	Signal
2020SS	728745	728747	728746	Deluxe	Heat / Remote	Heat / Remote	-
2020SS	728748	728749	728750	Deluxe	Heat / Remote	Heat / Remote	Light
2020SS	728751	728753	728752	Deluxe	Heat / Remote	Heat / Remote	Signal

#### 102" Body Width

Model	Pair Part #	Left Side #	Right Side #	Head	Flat Glass	Convex Glass	Options
2020SS	728754	728755	728756	Superstar	Manual	Manual	-
2020SS	728757	728759	728758	Deluxe	Manual	Manual	-
2020SS	728766	728767	728768	Deluxe	Heat / Remote	Heat	-

### 2020SS Shuttle Mini LEM System

#### 96" Body Width

Model	Pair Part #	Left Side #	Right Side #	Head	Flat Glass	Convex Glass	Options
2020SS	728769	728771	728770	Deluxe	Manual	Manual	-
2020SS	728772	728773	728774	Deluxe	Heat / Remote	Heat	-
2020SS	728775	728777	728776	Deluxe	Heat / Remote	Heat / Remote	-

#### 102" Body Width

Model	Pair Part #	Left Side #	Right Side #	Head	Flat Glass	Convex Glass	Options
2020SS	728778	728779	728780	Deluxe	Heat / Remote	Heat	-

#### NOTES

**Light** Lighted arm

**Signal** Signal arrow in glass

**NOTE: Part numbers listed in RED are NEW!**

# MIRRORS

## FORD

### 408 System | LCF L45, L55



#### Vehicle:

LCF L45, L55 (2004-2009)

- Fits 1 - 1 1/8" tube

#### Flat Head Size

7 1/4" w x 12 3/8" h x 3 1/2" d

#### Convex Head Size

8 7/8" w x 6 7/8" h x 4 1/8" d

#### Accessories

- **Head Clamp & Screw Kit**

Model 405 | Part # **V624059999**  
(OEM 2507274C1)

#### NOTES

**M/R** Manual / remote

<sup>1</sup> Includes bezel kit

Bracket not available. Contact OE to purchase.

#### Flat Glass Head Head adjustable

Model	Part #	O.E.M.	Glass Size	Side	Color	M/R	Heat	Light
408	V514080002	2588800C2	6 3/4" w x 12" h	Both	Black	Manual	-	-

#### Flat Glass Kit

Model	Part #	O.E.M.	Glass Size	Side	Color	M/R	Heat
408	V614080001 <sup>1</sup>	25589155C1 25589155C2	6 3/4" w x 12" h	Both	Black	Manual	-

#### Convex Glass Head Head adjustable

Model	Part #	O.E.M.	Glass Size	Side	Color	M/R	Heat	Light
408	V564080002	2588801C2	8 1/8" w x 6 1/8" h	Both	Black	Manual	-	-

#### Convex Glass Kit

Model	Part #	O.E.M.	Glass Size	Side	Color	M/R	Heat
408	V614080002 <sup>1</sup>	2589156C91	8 1/8" w x 6 1/8" h	Both	Black	Manual	•



Call the Velvac Sales Team: **800.783.8871** sales@velvac.com

© VELVAC INC. • 2405 South Calhoun Road • New Berlin, WI 53151-2709 • Toll Free: 800.783.8871 • Fax: 262.786.4101



### Ford E-Van | Rear Cross View Mirror System

#### Straight Van Chassis

Kit #	Bracket Only #	Color	Head
713120	713118	White	Velvac
713121	713119	Stainless steel	Velvac
716908	713204	Stainless steel	K-10

#### Vehicle:

Ford E-Van (1992-Present)

- Kits include mirror head, bracket and stainless steel mounting hardware
- Assemblies include either a Velvac 8½" wide view convex or an 8½" K-10 Eyeball convex mirror

### Ford E-Van, Ford F Series | Van and Cab Chassis System

#### Straight Van

#### Vehicle:

Ford E-Van (1992-Present)

Part #	Color	Bracket Style	Body Type
713104	Stainless steel	Retractable	Straight van

#### Wide Body Cutaway Van

Part #	Color	Bracket Style	Body Type
713113	Stainless steel	Non retractable	96" Cutaway
713114	White	Non retractable	96" Cutaway

#### Wide Body

#### Vehicle:

Ford F Series (1980-1997)

Part #	Color	Bracket Style	Body Type
713407	Stainless steel	Retractable	Cab chassis



713104



713113,  
713114



713407

**NOTE: Part numbers listed in RED are NEW!**



## FORD

### Door / Fender Mirror System | Ford E-Van



#### Vehicle:

Ford E-Van (1992-Present)

- Complete kit includes one door mount head / bracket and one fender mount head / bracket
- All stainless steel construction

Pair Part #	Description
713154	Door / fender - complete pair

### West Coast System | F650/ F750



#### Vehicle:

F650 / F750 (Up to 2015)

#### NOTES

**M/R** Manual / remote

Order head and bracket to make complete mirror system

#### Bracket Assembly

Part #	Side
719267	Left
719268	Right



#### West Coast Head

Part #	Glass Size	Side	Color	M/R	Heat	Light
705148	7"w x 16"h	Both	Stainless steel	-	•	•
705150	7"w x 16"h	Both	Stainless steel	Manual	-	-

#### Convex Glass Head

Part #	Glass Size	Side	Color	M/R	Heat	Light
708685	8½"	Both	Stainless steel	-	-	-



Call the Velvac Sales Team: **800.783.8871** [sales@velvac.com](mailto:sales@velvac.com)

© VELVAC INC. • 2405 South Calhoun Road • New Berlin, WI 53151-2709 • Toll Free: 800.783.8871 • Fax: 262.786.4101

Columbia, Century, FLD | **Hood Mount Mirrors**

### Aero-Bell™ Tripod

- Stylized single piece chrome plated ABS bells and molded nylon clamps help conceal hardware giving the mirror a clean, aerodynamic appearance
- Corrosion resistant materials eliminate rust

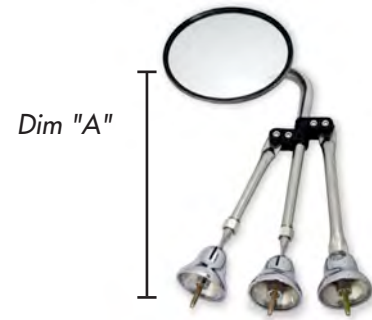

tubing Brace	Convex Mirror Head	Mounting Bells	Tube Clamps	Hardware	Packaging
Stainless steel	8½" Stainless steel DuraBall	Molded/chrome plate ABS	Molded black nylon	Stainless steel	Display box

### Fixed Arm Mirror/Bracket

Part #	Dim A
715168	20.35"

#### Vehicle:

Columbia and Century

### Fixed Arm Mirror/Bracket

Part #	Dim A
715166	23.55"

#### Vehicle:

FLD

Aero-Bell™ is a trademark of Velvac, Inc

## FREIGHTLINER

384 System | Century



### Vehicle:

Century (1995-2003)

- Fits 1 1/8" tube

### Head Size

9 1/16" w x 23 5/8" h x 5 3/8" d

### Accessories

- **CB Antenna Holder**

Model 384 | Part # **V083840200**  
(OEM MEK083840200L)

- **Replacement CB Harness**

Model 384 | Part # **V093841100**  
(OEM MEK093841100)

- **RAMI CB Insulator Kit**

Model 387 | Part # **V613871900**  
(OEM MEK613871900)

### NOTES

<sup>1</sup> Single actuator, horizontal movement only

<sup>2</sup> Single actuator, vertical movement only

Bracket, head and glass not available.  
Contact OE to purchase.

### Flat Mirror Actuators

Model	Part #	O.E.M.	Side
384	V613846012 <sup>1</sup>	MEK613846012	Both
384	V613846022 <sup>2</sup>	MEK613846022	Both



Call the Velvac Sales Team: **800.783.8871** sales@velvac.com

© VELVAC INC. • 2405 South Calhoun Road • New Berlin, WI 53151-2709 • Toll Free: 800.783.8871 • Fax: 262.786.4101



### Vehicle:

Columbia (1999-2002)

- Fits 1 - 1 1/8" tube

### Flat Head Size

7 5/16" w x 16 3/8" h x 4 5/8" d

### Convex Head Size

7 1/4" w x 7 1/4" h x 5 1/8" d

### Accessories

- **CB Bracket Parts Kit**

Model 409 | Part # **V614090029**  
(OEM MEK614090029)

- **RAMI CB Insulator Kit**

Model 387 | Part # **V613871900**  
(OEM MEK613871900)

- **Head Clamp & Screw Kit**

Model 405 | Part # **V624059999**  
(OEM MEK624059999)

### NOTES

**M/R** Manual / remote

Bracket not available. Contact OE to purchase.

**Flat Glass Housing** Head adjustable. Order glass to make complete head

Model	Part #	O.E.M.	Glass Size	Side	Color	M/R	Heat <sup>2</sup>	Light
409	V614090024	A2254884005	6 3/4" w x 15 7/8" h	Right	Chrome	Remote <sup>1</sup>	•	-
409	V614090023	A2254884004	6 3/4" w x 15 7/8" h	Left	Chrome	Remote <sup>1</sup>	•	-
409	V614090022	A2254884002 A2254884003	6 3/4" w x 15 7/8" h	Both	Chrome	Manual	•	-
409	V614090021	A2254884001	6 3/4" w x 15 7/8" h	Both	Chrome	Manual	-	-
409	V614090033	A2254884012	6 3/4" w x 15 7/8" h	Right	Black	Remote <sup>1</sup>	•	-
409	V614090032	A2254884013	6 3/4" w x 15 7/8" h	Left	Black	Remote <sup>1</sup>	•	-
409	V614090031	A2254884014	6 3/4" w x 15 7/8" h	Both	Black	Manual	•	-
409	V614090030	A2254884015	6 3/4" w x 15 7/8" h	Both	Black	Manual	-	-
409	V614090028	A2254884011	6 3/4" w x 15 7/8" h	Right	Gray	Remote <sup>1</sup>	•	-
409	V614090027	A2254884010	6 3/4" w x 15 7/8" h	Left	Gray	Remote <sup>1</sup>	•	-
409	V614090026	A2254884009	6 3/4" w x 15 7/8" h	Both	Gray	Manual	•	-
409	V614090025	A2254884007	6 3/4" w x 15 7/8" h	Both	Gray	Manual	-	-

### Flat Glass Kit

Model	Part #	O.E.M.	Glass Size	Side	Color	M/R	Heat
383	V153832107	A2254882002	6 3/4" w x 15 7/8" h	Both	Black	Both	•
383	V153832003	A2254882001	6 3/4" w x 15 7/8" h	Both	Gray	Both	•

<sup>1</sup> Flat glass only

<sup>2</sup> Flat and convex glass are heated

**NOTE: Part numbers listed in RED are NEW!**

## FREIGHTLINER

### 409 System

Continued

**Convex Glass Housing** Head adjustable. Order glass to make complete head

Model	Part #	O.E.M.	Glass Size	Side	Color	M/R	Heat	Light
409	V614090018	A2254885003	6¾"w x 6¾"h	Both	Chrome	Manual	•	-
409	V614090017	A2254885001	6¾"w x 6¾"h	Both	Chrome	Manual	-	-
409	V614090035	A2254885013	6¾"w x 6¾"h	Both	Black	Manual	•	-
409	V614090034	A2254885012	6¾"w x 6¾"h	Both	Black	Manual	-	-
409	V614090020	A2254885009	6¾"w x 6¾"h	Both	Gray	Manual	•	-
409	V614090019	A2254885007	6¾"w x 6¾"h	Both	Gray	Manual	-	-

### Convex Glass Kit

Model	Part #	O.E.M.	Glass Size	Side	Color	M/R	Heat
388	V153882117	A2251339002 A2254883002	6¾"w x 6¾"h	Both	Black	Manual	•
388	V153882120	-	6¾"w x 6¾"h	Both	Black	Manual	-
388	V153882213	A2254883001	6¾"w x 6¾"h	Both	Gray	Manual	•
388	V153882210	A2251339000	6¾"w x 6¾"h	Both	Gray	Manual	-

### Flat Mirror Actuators

Model	Part #	O.E.M.	Side
409	V084090002	MEK084090002	Right
409	V084090001	MEK084090001	Left



Call the Velvac Sales Team: **800.783.8871** [sales@velvac.com](mailto:sales@velvac.com)

© VELVAC INC. • 2405 South Calhoun Road • New Berlin, WI 53151-2709 • Toll Free: 800.783.8871 • Fax: 262.786.4101

Columbia | **410 System**



### Vehicle:

Columbia (2003-2006)

- Fits 1 1/8" tube

### Flat Head Size

7 13/16" w x 16 3/4" h x 4 3/4" d

### Convex Head Size

7 13/16" w x 8 7/16" h x 5 3/8" d

### Accessories

- **RAMI CB Insulator Kit**  
Model 387 | Part # **V613871900**  
(OEM MEK613871900)
- **Head Clamp & Screw Kit**  
Model 405 | Part # **V624059999**  
(OEM MEK624059999)

### NOTES

**M/R** Manual / remote

Bracket and head not available. Contact OE to purchase.

### Flat Glass Kit

Model	Part #	O.E.M.	Glass Size	Side	Color	M/R	Heat
414	<b>V154148002</b>	A2258516001	6 7/8" w x 15 3/4" h	Both	Black	Both	•
414	<b>V154148001</b>	A2258516000	6 7/8" w x 15 3/4" h	Both	Black	Both	-

### Convex Glass Kit

Model	Part #	O.E.M.	Glass Size	Side	Color	M/R	Heat
415	<b>V154158002</b>	A2259713001	7 1/2" w x 7" h	Both	Black	Manual	•
415	<b>V154158001</b>	A2259713000	7 1/2" w x 7" h	Both	Black	Manual	-

### Flat Mirror Actuators

Model	Part #	O.E.M.	Side
414	<b>V084143112</b>	MEK084143112	Right
414	<b>V084143012</b>	MEK084143012	Left

**NOTE: Part numbers listed in RED are NEW!**



# MIRRORS

## FREIGHTLINER

### 433 System | Condor



#### Vehicle:

Condor (2005-2007)

- Fits 1 - 1 1/8" tube

#### Flat Head Size

7 13/16" w x 16 3/4" h x 4 3/4" d

#### Convex Head Size

7 13/16" w x 8 7/16" h x 5 3/8" d

#### Accessories

##### • CB Kit

Model 433 | Part # **V614330001**  
(OEM MEK614330001)

##### • Head Clamp & Screw Kit

Model 405 | Part # **V624059999**  
(OEM MEK624059999)

#### NOTES

**M/R** Manual / remote

Bracket and head not available. Contact OE to purchase.

#### Flat Glass Kit

Model	Part #	O.E.M.	Glass Size	Side	Color	M/R	Heat
414	V154148002	A2258516001	6 7/8" w x 15 3/4" h	Both	Black	Both	•
414	V154148001	A2258516000	6 7/8" w x 15 3/4" h	Both	Black	Both	-

#### Convex Glass Kit

Model	Part #	O.E.M.	Glass Size	Side	Color	M/R	Heat
415	V154158002	A2259713001	7 1/2" w x 7" h	Both	Black	Manual	•
415	V154158001	A2259713000	7 1/2" w x 7" h	Both	Black	Manual	-

#### Flat Mirror Actuators

Model	Part #	O.E.M.	Side
414	V084143112	MEK084143112	Right
414	V084143012	MEK084143012	Left



Call the Velvac Sales Team: **800.783.8871** sales@velvac.com

© VELVAC INC. • 2405 South Calhoun Road • New Berlin, WI 53151-2709 • Toll Free: 800.783.8871 • Fax: 262.786.4101

M2 106, M2 106V, 108SD, M2 112, M2 112V, M2 114SD | **414 System**



### Vehicle:

M2 106, M2 106V, 108SD,  
M2 112, M2 112V, M2 114SD  
(2003-Present)

- Fits 1 1/8" tube

### Flat Head Size

7 13/16" w x 16 3/4" h x 4 3/4" d

### Convex Head Size

7 13/16" w x 8 7/16" h x 5 3/8" d

### NOTES

**M/R** Manual / remote

Bracket and head not available. Contact  
OE to purchase.

### Flat Glass Kit

Model	Part #	O.E.M.	Glass Size	Side	Color	M/R	Heat
414	V154148002	A2258516001	6 7/8" w x 15 3/4" h	Both	Black	Both	•
414	V154148001	A2258516000	6 7/8" w x 15 3/4" h	Both	Black	Both	-

### Convex Glass Kit

Model	Part #	O.E.M.	Glass Size	Side	Color	M/R	Heat
415	V154158002	A2259713001	7 1/2" w x 7" h	Both	Black	Manual	•
415	V154158001	A2259713000	7 1/2" w x 7" h	Both	Black	Manual	-

### Flat Mirror Actuators

Model	Part #	O.E.M.	Side
414	V084143112	MEK084143112	Right
414	V084143012	MEK084143012	Left

### Accessories

- **Marker Light Assembly - Amber**  
Model 401 | Part # V084010001  
(OEM MEK084010001)
- **Marker Light Bezel**  
Model 414 | Part # V084142400
- **RAMI CB Insulator Kit**  
Model 387 | Part # V613871900  
(OEM MEK613871900)
- **Head Clamp & Screw Kit**  
Model 405 | Part # V624059999  
(OEM MEK624059999)

**NOTE: Part numbers listed in RED are NEW!**

# MIRRORS

## FREIGHTLINER

### 382 System | Sterling



#### Vehicle:

Sterling (2002-2009)

- Fits 1 1/8" tube

#### Flat Head Size

7 3/16"w x 16 3/4"h x 4 3/4"d

#### Convex Head Size

7 3/16"w x 8 7/16"h x 5 3/8"d

#### Accessories

- **RAMI CB Insulator Kit**  
Model 387 | Part # [V613871900](#)  
(OEM MEK613871900)
- **Head Clamp & Screw Kit**  
Model 405 | Part # [V624059999](#)  
(OEM MEK624059999)

#### NOTES

**M/R** Manual / remote

Bracket and head not available. Contact OE to purchase.

#### Flat Glass Kit

Model	Part #	O.E.M.	Glass Size	Side	Color	M/R	Heat
414	<a href="#">V154148002</a>	A2258516001	6 7/8"w x 15 3/4"h	Both	Black	Both	•

#### Convex Glass Kit

Model	Part #	O.E.M.	Glass Size	Side	Color	M/R	Heat
415	<a href="#">V154158002</a>	A2259713001	7 1/2"w x 7"h	Both	Black	Manual	•
415	<a href="#">V154158001</a>	A2259713000	7 1/2"w x 7"h	Both	Black	Manual	-

#### Flat Mirror Actuators

Model	Part #	O.E.M.	Side
414	<a href="#">V084143112</a>	MEK084143112	Right
414	<a href="#">V084143012</a>	MEK084143012	Left



Call the Velvac Sales Team: **800.783.8871** [sales@velvac.com](mailto:sales@velvac.com)

© VELVAC INC. • 2405 South Calhoun Road • New Berlin, WI 53151-2709 • Toll Free: 800.783.8871 • Fax: 262.786.4101

Various | **Look Down Mirrors**

**Vehicle:**

Various (2003-Present)

**Bracket Mount**

**Convex Head Size**

11<sup>3</sup>/<sub>16</sub>"w x 6<sup>7</sup>/<sub>8</sub>"h x 2<sup>7</sup>/<sub>16</sub>"d

**Bracket Hole Location**

**Width Between Holes:**

3<sup>15</sup>/<sub>16</sub>"

**Hole Size:** 1<sup>1</sup>/<sub>64</sub>"



NOTES

**M/R** Manual / remote

<sup>1</sup> Furnished with black arm, chrome back cover, black bezel and black holder

<sup>2</sup> Furnished with black arm, black back cover, black bezel and black holder

<sup>3</sup> Furnished with gray arm, gray back cover, gray bezel and gray holder

<sup>4</sup> Includes bezel kit

**Convex Look Down Mirror**

Model	Part #	O.E.M.	Glass Size	Side	Color	M/R	Heat	Light
360	V593605228 <sup>1</sup>	A2248560003	10 <sup>5</sup> / <sub>8</sub> "w x 6 <sup>1</sup> / <sub>4</sub> "h	Right	Chrome	Manual	-	-
360	V593601152 <sup>2</sup>	A2248560000	10 <sup>5</sup> / <sub>8</sub> "w x 6 <sup>1</sup> / <sub>4</sub> "h	Right	Black	Manual	-	-
360	V593601428 <sup>3</sup>	A2248560002	10 <sup>5</sup> / <sub>8</sub> "w x 6 <sup>1</sup> / <sub>4</sub> "h	Right	Gray	Manual	-	-

**Convex Glass Kit**

Model	Part #	O.E.M.	Glass Size	Side	Color	M/R	Heat
360	V613600001 <sup>4</sup>	MEK613600001F	10 <sup>5</sup> / <sub>8</sub> "w x 6 <sup>1</sup> / <sub>4</sub> "h	Both	Black	Manual	-
360	V613600002 <sup>4</sup>	MEK613600002	10 <sup>5</sup> / <sub>8</sub> "w x 6 <sup>1</sup> / <sub>4</sub> "h	Both	Gray	Manual	-

**NOTE: Part numbers listed in RED are NEW!**

# MIRRORS

## FREIGHTLINER

### Look Down Mirrors | Various

Continued



#### Vehicle:

Various (2003-Present)

#### Bracket Mount

#### Convex Head Size

11<sup>1</sup>/<sub>16</sub>"w x 6<sup>3</sup>/<sub>4</sub>"h x 2<sup>5</sup>/<sub>8</sub>"d

#### Bracket Hole Location

#### Width Between Holes:

3<sup>15</sup>/<sub>16</sub>" or 2<sup>3</sup>/<sub>4</sub>"

#### Hole Size: 1<sup>1</sup>/<sub>64</sub>"

#### NOTES

**M/R** Manual / remote

<sup>1</sup> Furnished with black mounting bracket, black housing and stainless steel shroud

<sup>2</sup> Furnished with black mounting bracket and black housing

<sup>3</sup> Furnished with gray mounting bracket and gray housing

### Convex Look Down Mirror

Model	Part #	O.E.M.	Glass Size	Side	Color	M/R	Heat	Light
412	V594121261 <sup>1</sup>	A2258773002	10 <sup>3</sup> / <sub>4</sub> "w x 6 <sup>3</sup> / <sub>8</sub> "h	Right	Stainless	Manual	-	-
412	V594121161 <sup>2</sup>	A2258773000	10 <sup>3</sup> / <sub>4</sub> "w x 6 <sup>3</sup> / <sub>8</sub> "h	Right	Black	Manual	-	-
412	V594121461 <sup>3</sup>	A2258773001	10 <sup>3</sup> / <sub>4</sub> "w x 6 <sup>3</sup> / <sub>8</sub> "h	Right	Gray	Manual	-	-

### Fender Mount Mirrors | Various



#### Vehicle:

Various

- Fender Mount

#### Side Support Range

11<sup>7</sup>/<sub>16</sub>" to 15<sup>5</sup>/<sub>16</sub>"

#### Main Support Range

17<sup>3</sup>/<sub>4</sub>" to 26<sup>3</sup>/<sub>8</sub>"

#### NOTES

**M/R** Manual / remote

<sup>1</sup> Convex spot mirror with tripod assembly, fender mount

<sup>2</sup> Mirror only, fender mount

### Fender Bracket Assembly

Model	Part #	O.E.M.	Side	Color	Material	Heat
445	V594450100 <sup>1</sup>	A2259733000	Both	Stainless	Stainless	-

### Convex Glass Head

Model	Part #	O.E.M.	Glass Size	Side	Color	M/R	Heat	Light
445	V564450350 <sup>2</sup>	MEK564450350	8"	Both	Stainless	Manual	-	-



Call the Velvac Sales Team: **800.783.8871** sales@velvac.com

© VELVAC INC. • 2405 South Calhoun Road • New Berlin, WI 53151-2709 • Toll Free: 800.783.8871 • Fax: 262.786.4101

GM Cutaway Van | **2020 System**



Standard

Deluxe

### 78" Body Width

- **Flat Glass**  
Standard 57 sq. in.  
Deluxe 62 sq. in.
- **Convex Glass**  
Standard wedge 10 sq. in. | 8" ROC  
Deluxe full 30 sq. in. | 12" ROC

**NOTE: See pages M37 & M38 for product information**

### Vehicle:

GM Cutaway Van Mirrors



Model	Pair Part #	Left Side #	Right Side #	Color	Head	Flat Glass	Convex Glass	Options
2020	718389-5	718391-5	718390-5	Black	Deluxe	Manual	Manual	-

### 86" Body Width

Model	Pair Part #	Left Side #	Right Side #	Color	Head	Flat Glass	Convex Glass	Options
2020	714601	714603	714602	Black	Standard	Manual	-	-
2020	714604	714605	714606	Black	Standard	Heat / Remote	-	-
2020	714591	714593	714592	Black	Deluxe	Manual	Manual	-

### 96" Body Width

Model	Pair Part #	Left Side #	Right Side #	Color	Head	Flat Glass	Convex Glass	Options
2020	714557	714559	714558	Black	Standard	Manual	-	-
2020	714563	714565	714564	Black	Standard	Heat / Remote	-	-
2020	714569	714571	714570	Black	Standard	Heat / Remote	-	Light
2020	714545	714547	714546	Black	Deluxe	Manual	Manual	-
2020	714551	714553	714552	Black	Deluxe	Heat / Remote	Heat / Manual	Light
2020	714916	714917	714918	White	Standard	Heat / Remote	-	-
2020	714910	714911	714912	White	Standard	Manual	-	-
2020	714904	714905	714906	White	Deluxe	Heat / Remote	Heat / Manual	Light

### 102" Body Width

Model	Pair Part #	Left Side #	Right Side #	Color	Head	Flat Glass	Convex Glass	Options
2020	714560	714561	714562	Black	Standard	Manual	-	-
2020	714566	714567	714568	Black	Standard	Heat / Remote	-	-
2020	714572	714573	714574	Black	Standard	Heat / Remote	-	Light
2020	714548	714549	714550	Black	Deluxe	Manual	Manual	-
2020	714554	714555	714556	Black	Deluxe	Heat / Remote	Heat / Manual	Light
2020	714913	714915	714914	White	Standard	Manual	-	-
2020	714919	714921	714920	White	Standard	Heat / Remote	-	-
2020	714907	714909	714908	White	Deluxe	Heat / Remote	Heat / Manual	Light

NOTES  
**Light** Lighted arm

\*All remote mirror PAIRS include switches and wire harnesses. These items are NOT included when remote mirrors are sold as sides

NOTE: GMC Silverado mirror assemblies can be found on [www.velvac.com](http://www.velvac.com) by searching with a keyword "Silverado"

**NOTE: Part numbers listed in RED are NEW!**



# MIRRORS

**GM**

## 2020 Mini LEM System | GM Cutaway Van



- **Flat Glass**  
62 sq. in
- **Convex Glass**  
30 sq. in. | 12" ROC

**Vehicle:**

GM Cutaway Van Mirrors

### 96" Body Width

Model	Pair Part #	Left Side #	Right Side #	Color	Head	Flat Glass	Convex Glass	Options
2020	719397	719399	719398	Black	Deluxe	Manual	Manual	-
2020	719403	719405	719404	Black	Deluxe	Heat / Remote	Heat / Manual	-
2020	719412	719413	719414	Black	Deluxe	Heat / Remote	Heat / Manual	Light
2020	719421	719423	719422	Black	Deluxe	Heat / Remote	Heat / Manual	Signal
2020	719430	719431	719432	Black	Deluxe	Heat / Remote	Heat / Manual	Signal / Light
2020	719400	719401	719402	White	Deluxe	Manual	Manual	-
2020	719406	719407	719408	White	Deluxe	Heat / Remote	Heat / Manual	-
2020	719415	719417	719416	White	Deluxe	Heat / Remote	Heat / Manual	Light
2020	719424	719425	719426	White	Deluxe	Heat / Remote	Heat / Manual	Signal
2020	719433	719435	719434	White	Deluxe	Heat / Remote	Heat / Manual	Signal / Light
2020	719409	719411	719410	Chrome	Deluxe	Heat / Remote	Heat / Manual	-
2020	719418	719419	719420	Chrome	Deluxe	Heat / Remote	Heat / Manual	Light
2020	719427	719429	719428	Chrome	Deluxe	Heat / Remote	Heat / Manual	Signal
2020	719436	719437	719438	Chrome	Deluxe	Heat / Remote	Heat / Manual	Signal / Light

### 102" Body Width

Model	Pair Part #	Left Side #	Right Side #	Color	Head	Flat Glass	Convex Glass	Options
2020	719439	719441	719440	Black	Deluxe	Manual	Manual	-
2020	719445	719447	719446	Black	Deluxe	Heat / Remote	Heat / Manual	-
2020	719454	719455	719456	Black	Deluxe	Heat / Remote	Heat / Manual	Light
2020	719463	719465	719464	Black	Deluxe	Heat / Remote	Heat / Manual	Signal
2020	719472	719474	719473	Black	Deluxe	Heat / Remote	Heat / Manual	Signal / Light
2020	719442	719443	719444	White	Deluxe	Manual	Manual	-
2020	719448	719449	719450	White	Deluxe	Heat / Remote	Heat / Manual	-
2020	719457	719459	719458	White	Deluxe	Heat / Remote	Heat / Manual	Light
2020	719466	719467	719468	White	Deluxe	Heat / Remote	Heat / Manual	Signal
2020	719475	719477	719476	White	Deluxe	Heat / Remote	Heat / Manual	Signal / Light
2020	719451	719453	719452	Chrome	Deluxe	Heat / Remote	Heat / Manual	-
2020	719460	719461	719462	Chrome	Deluxe	Heat / Remote	Heat / Manual	Light
2020	719469	719471	719470	Chrome	Deluxe	Heat / Remote	Heat / Manual	Signal
2020	719478	719479	719480	Chrome	Deluxe	Heat / Remote	Heat / Manual	Signal / Light

**NOTES**

**Light** Lighted arm  
**Signal** Signal arrow in glass

\*All remote mirror PAIRS include switches and wire harnesses. These items are NOT included when remote mirrors are sold as sides



Call the Velvac Sales Team: **800.783.8871** sales@velvac.com

© VELVAC INC. • 2405 South Calhoun Road • New Berlin, WI 53151-2709 • Toll Free: 800.783.8871 • Fax: 262.786.4101

## GM Cutaway Van | 2020XG System



### Vehicle:

GM Cutaway Van Mirrors

- **Flat Glass**  
64 sq. in
- **Convex Glass**  
29 sq. in. | 18" ROC

### 96" Body Width

Model	Pair Part #	Left Side #	Right Side #	Color	Flat Glass	Convex Glass	Options
2020XG	715911	715913	715912	Black	Manual	Manual	-
2020XG	715917	715919	715918	Black	Heat / Remote	Heat / Manual	-
2020XG	716352	716353	716354	Black	Heat / Remote	Heat / Manual	Light
2020XG	716349	716351	716350	Black	Heat / Remote	Heat / Manual	Signal
2020XG	715914	715915	715916	White	Manual	Manual	-
2020XG	715920	715921	715922	White	Heat / Remote	Heat / Manual	-
2020XG	716388	716389	716390	White	Heat / Remote	Heat / Manual	Light
2020XG	716385	716387	716386	White	Heat / Remote	Heat / Manual	Signal
2020XG	715962	715963	715964	Chrome	Heat / Remote	Heat / Manual	-
2020XG	716420	716421	716422	Chrome	Heat / Remote	Heat / Manual	Light
2020XG	716417	716419	716418	Chrome	Heat / Remote	Heat / Manual	Signal

### 102" Body Width

Model	Pair Part #	Left Side #	Right Side #	Color	Flat Glass	Convex Glass	Options
2020XG	715935	715937	715936	Black	Manual	Manual	-
2020XG	715941	715943	715942	Black	Heat / Remote	Heat / Manual	-
2020XG	716328	716329	716330	Black	Heat / Remote	Heat / Manual	Light
2020XG	716325	716327	716326	Black	Heat / Remote	Heat / Manual	Signal
2020XG	715938	715939	715940	White	Manual	Manual	-
2020XG	715944	715945	715946	White	Heat / Remote	Heat / Manual	-
2020XG	716376	716377	716378	White	Heat / Remote	Heat / Manual	Light
2020XG	716373	716375	716374	White	Heat / Remote	Heat / Manual	Signal
2020XG	715980	715981	715982	Chrome	Heat / Remote	Heat / Manual	-
2020XG	716435	716437	716436	Chrome	Heat / Remote	Heat / Manual	Light
2020XG	716397	716399	716398	Chrome	Heat / Remote	Heat / Manual	Signal

#### NOTES

**Light** Lighted head

**Signal** Signal arrow in glass

**Chrome** Chrome head with black arm and base

\*All remote mirror PAIRS include switches and wire harnesses. These items are NOT included when remote mirrors are sold as sides

NOTE: GMC Silverado mirror assemblies can be found on [www.velvac.com](http://www.velvac.com) by searching with a keyword "Silverado"

# MIRRORS

**GM**

## 2020XG System for GM Cut w/ 8D8 Option | GM Cutaway Van



### Vehicle:

GM Cutaway Van Mirrors

- **Flat Glass**  
64 sq. in
- **Convex Glass**  
29 sq. in. | 18" ROC
- Mirrors connect directly to OE door harness and are controlled by OE switches, making installation fast and easy

### 96" Body Width

Model	Pair Part #	Left Side #	Right Side #	Color	Head	Flat Glass	Convex Glass	Options
2020XG	718416	718417	718418	Black	Deluxe	Heat / Remote	Heat / Manual	-
2020XG	718419	718421	718420	Black	Deluxe	Heat / Remote	Heat / Manual	Light
2020XG	718422	718423	718424	Black	Deluxe	Heat / Remote	Heat / Manual	Signal
2020XG	718434	718435	718436	Chrome	Deluxe	Heat / Remote	Heat / Manual	-
2020XG	718437	718439	718438	Chrome	Deluxe	Heat / Remote	Heat / Manual	Light
2020XG	718440	718441	718442	Chrome	Deluxe	Heat / Remote	Heat / Manual	Signal

### 102" Body Width

Model	Pair Part #	Left Side #	Right Side #	Color	Head	Flat Glass	Convex Glass	Options
2020XG	718425	718427	718426	Black	Deluxe	Heat / Remote	Heat / Manual	-
2020XG	718428	718429	718430	Black	Deluxe	Heat / Remote	Heat / Manual	Light
2020XG	718431	718433	718432	Black	Deluxe	Heat / Remote	Heat / Manual	Signal
2020XG	718443	718445	718444	Chrome	Deluxe	Heat / Remote	Heat / Manual	-
2020XG	718446	718447	718448	Chrome	Deluxe	Heat / Remote	Heat / Manual	Light
2020XG	718449	718451	718450	Chrome	Deluxe	Heat / Remote	Heat / Manual	Signal

#### NOTES

**Light** Lighted arm

**Signal** Signal arrow in glass

Mirrors shown above are used on GM cutaway van chassis with 8D8 option. This option provides OE door harness and control switches with the chassis. Velvac switch and harness not included, and are not required for installation



Call the Velvac Sales Team: **800.783.8871** [sales@velvac.com](mailto:sales@velvac.com)

© VELVAC INC. • 2405 South Calhoun Road • New Berlin, WI 53151-2709 • Toll Free: 800.783.8871 • Fax: 262.786.4101

## GM Cutaway Van | 2020XG Mini-LEM System



### Vehicle:

GM Cutaway Van

- **Flat Glass**  
64 sq. in
- **Convex Glass**  
29 sq. in. | 18" ROC

### 96" Body Width

Model	Pair Part #	Left Side #	Right Side #	Color	Head	Flat Glass	Convex Glass	Options
2020XG	717550	717551	717552	Black	Deluxe	Heat / Remote	Heat / Manual	-
2020XG	717553	717555	717554	Black	Deluxe	Heat / Remote	Heat / Manual	Signal
2020XG	718618	718619	718620	White	Deluxe	Heat / Remote	Heat / Manual	-
2020XG	717574	717575	717576	Chrome	Deluxe	Heat / Remote	Heat / Manual	-
2020XG	717577	717579	717578	Chrome	Deluxe	Heat / Remote	Heat / Manual	Signal

### 102" Body Width

Model	Pair Part #	Left Side #	Right Side #	Color	Head	Flat Glass	Convex Glass	Options
2020XG	717556	717557	717558	Black	Deluxe	Heat / Remote	Heat / Manual	-
2020XG	717559	717561	717560	Black	Deluxe	Heat / Remote	Heat / Manual	Signal
2020XG	718621	718623	718622	White	Deluxe	Heat / Remote	Heat / Manual	-
2020XG	717580	717581	717582	Chrome	Deluxe	Heat / Remote	Heat / Manual	-
2020XG	717583	717585	717584	Chrome	Deluxe	Heat / Remote	Heat / Manual	Signal

#### NOTES

**Signal** Signal arrow in glass

**Chrome** Chrome head with black arm and base

\*All remote mirror PAIRS include switches and wire harnesses. These items are NOT included when remote mirrors are sold as sides

NOTE: GMC Silverado mirror assemblies can be found on [www.velvac.com](http://www.velvac.com) by searching with a keyword "Silverado"

# MIRRORS

**GM**

## 2020SS Shuttle Mirror System | GM G Van



Superstar



Deluxe mirror head w/ mini LEM



### Vehicle:

GM G Van

- **Flat Glass**

Superstar 51½ sq in

Deluxe 63.3 sq in

- **Convex Glass**

Superstar 23½ sq. in.

Deluxe 30 sq. in.

### NOTES

**Light** Lighted arm

**Signal** Signal arrow in glass

### 96" Body Width

Model	Pair Part #	Left Side #	Right Side #	Head	Flat Glass	Convex Glass	Options
2020SS	718730	718731	718732	Superstar	Manual	Manual	-
2020SS	718733	718735	718734	Deluxe	Manual	Manual	-
2020SS	718736	718737	718738	Deluxe	Heat / Remote	Heat	-
2020SS	718739	718741	718740	Deluxe	Heat / Remote	Heat	Light
2020SS	718742	718743	718744	Deluxe	Heat / Remote	Heat	Signal
2020SS	718745	718747	718746	Deluxe	Heat / Remote	Heat / Remote	-
2020SS	718748	718749	718750	Deluxe	Heat / Remote	Heat / Remote	Light
2020SS	718751	718753	718752	Deluxe	Heat / Remote	Heat / Remote	Signal

### 102" Body Width

Model	Pair Part #	Left Side #	Right Side #	Head	Flat Glass	Convex Glass	Options
2020SS	718754	718755	718756	Superstar	Manual	Manual	-
2020SS	718757	718759	718758	Deluxe	Manual	Manual	-
2020SS	718763	718765	718764	Deluxe	Heat / Remote	Heat	Light
2020SS	718766	718767	718768	Deluxe	Heat / Remote	Heat	-

## 2020SS Shuttle Mini LEM System

### 96" Body Width

Model	Pair Part #	Left Side #	Right Side #	Head	Flat Glass	Convex Glass	Options
2020SS	718769	718771	718770	Deluxe	Manual	Manual	-
2020SS	718772	718773	718774	Deluxe	Heat / Remote	Heat	-
2020SS	718775	718777	718776	Deluxe	Heat / Remote	Heat / Remote	-



Call the Velvac Sales Team: **800.783.8871** sales@velvac.com

© VELVAC INC. • 2405 South Calhoun Road • New Berlin, WI 53151-2709 • Toll Free: 800.783.8871 • Fax: 262.786.4101

## GM G Van, GM CK Truck | Van and Cab Chassis Mirrors

### Vehicle:

GM G Van (1997-Present)

### Straight Van

Part #	Color	Bracket	Body Type
713789	Stainless steel	Retractable	Straight van

### Wide Body Cutaway Van

Part #	Color	Bracket Style	Body Type
713785	White	Non retractable	96" Cutaway

### Vehicle:

GM CK Truck (1987-1998)

### Wide Body

Part #	Color	Bracket Style	Body Type
712908	Stainless steel	Retractable	96" Cab chassis



713789



713785



712908

**NOTE: Part numbers listed in RED are NEW!**



## GM

### Door / Fender Mirror System | GM G Van



Fender mount assembly



Door mount assembly

#### Vehicle:

GM G Van (1997-Present)

- Complete kit includes one door mount head / bracket and one fender mount head / bracket
- All stainless steel construction

Pair Part #	Description
713883	Door/fender - complete pair

### Rear Cross View Mirror Systems | GM G Van



#### Vehicle:

GM G Van (1997-Present)

- Kits include mirror head, bracket and stainless steel mounting hardware
- Assemblies include either a Velvac 8½" wide view convex or an 8½" K-10 Eyeball convex mirror

### Straight Van Chassis Applications

Kit #	Bracket Only #	Color	Head
713796	-	White	Velvac
713798	-	Stainless steel	Velvac
716909	713993	Stainless steel	K-10

### Camper Style | GM Low Mount Cab and Cutaway



#### Vehicle:

GM Low Mount Cab and Cutaway Mirror Systems

- Complete with ¾" - 16 x 2¼" mounting bolt and hardware

### Camper Style Mirror Head

Part #	Delbar Part #	Glass Size	Head Size	Material
716138-5	HR-1164	63 sq. in.	7½"w x 10½"h	Stainless steel



Call the Velvac Sales Team: **800.783.8871** [sales@velvac.com](mailto:sales@velvac.com)

© VELVAC INC. • 2405 South Calhoun Road • New Berlin, WI 53151-2709 • Toll Free: 800.783.8871 • Fax: 262.786.4101

## Canyon Pickup Truck | Colorado Canyon Pickup Mirrors

### Vehicle:

GMC Canyon Pickup Truck Chassis

Part #	Description
715885	Complete pair
715886	Right side mirror
715887	Left side mirror
715888	Right side mirror head w/ convex
715889	Left side mirror head w/ convex
723106	Right side convex
723107	Left side convex
702086	Flat glass kit

- Provides views around 78" bodies to increase driver safety with enhanced view of passing lanes and blind spots
- Large 11.10 square inch convex with 12½" ROC targets blind spots
- 56.62 square inch flat glass area
- Mirrors fold forward and back for easy storage
- Black finish for OE appearance



# MIRRORS

## HINO

**428 System** | 145, 165, 185, 238, 258ALP, 258LP, 268, 268A, 338, 338CT



### Vehicle:

145, 165, 185, 238, 258ALP,  
258LP, 268, 268A, 338, 338CT  
(2005-Present)

- Fits 1 - 1 1/8" tube

### Convex Head Size

8 7/16" w x 6 5/8" h x 4 1/2" d

### NOTES

**M/R** Manual / remote

Bracket not available. Contact OE to purchase.

<sup>1</sup> Chrome backcover with black housing

<sup>2</sup> Includes housing

### Convex Glass Head Glass adjustable

Model	Part #	O.E.M.	Glass Size	Side	Color	M/R	Heat	Light
428	V564281005 <sup>1</sup>	S8790E0033	7 3/4" w x 5 3/4" h	Both	Chrome	Manual	-	-
428	V564281001	S8790E0021	7 3/4" w x 5 3/4" h	Both	Black	Manual	-	-

### Convex Glass Kit

Model	Part #	O.E.M.	Glass Size	Side	Color	M/R	Heat
428	V154280001	87931E0010	7 3/4" w x 5 3/4" h	Both	Black	Manual	-
428	V614280008 <sup>2</sup>	S8702E0030	7 3/4" w x 5 3/4" h	Both	Black	Manual	-

### Convex Mirror Cover

Model	Part #	O.E.M.	Side	Color	Light
428	V134281015	S8791E0060	Both	Chrome	-
428	V134281011	S8791E0050	Both	Black	-

### Accessories

- **Head Clamp & Screw Kit**

Model 400 | Part # V614000010  
(OEM 87919E0101)



Call the Velvac Sales Team: **800.783.8871** sales@velvac.com

© VELVAC INC. • 2405 South Calhoun Road • New Berlin, WI 53151-2709 • Toll Free: 800.783.8871 • Fax: 262.786.4101

145, 165, 185, 238, 258ALP, 258LP, 268, 268A, 338, 338CT | **427 System**



### Vehicle:

145, 165, 185, 238, 258ALP, 258LP, 268, 268A, 338, 338CT (2005-Present)

- Fits 1 - 1 1/8" tube

### Head Size

8 1/16" w x 15 1/16" h x 5 1/4" d

### Accessories

- **Marker Light Kit w/ Bezel**  
Model 427 | Part # **V114272001**
- **Head Clamp & Screw Kit**  
Model 400 | Part # **V614000010**  
(OEM 87919E0101)

### NOTES

**M/R** Manual / remote

<sup>1</sup> Chrome backcover with black housing  
Bracket not available. Contact OE to purchase.

### Flat Glass Head Glass adjustable

Model	Part #	O.E.M.	Glass Size	Side	Color	M/R	Heat	Light
427	V514271108 <sup>1</sup>	87903E0260	7 1/4" w x 14 1/4" h	Right	Chrome	Remote	•	•
427	V514271107 <sup>1</sup>	87906E0170	7 1/4" w x 14 1/4" h	Left	Chrome	Remote	•	•
427	V514271008 <sup>1</sup>	87903E0043 87903E0042	7 1/4" w x 14 1/4" h	Right	Chrome	Manual	•	•
427	V514271007 <sup>1</sup>	87906E0043 87906E0042	7 1/4" w x 14 1/4" h	Left	Chrome	Manual	•	•
427	V514271006 <sup>1</sup>	87903E0103 87903E0102	7 1/4" w x 14 1/4" h	Right	Chrome	Manual	-	-
427	V514271005 <sup>1</sup>	87906E0063 87906E0062	7 1/4" w x 14 1/4" h	Left	Chrome	Manual	-	-
427	V514270104	87903E0250	7 1/4" w x 14 1/4" h	Right	Black	Remote	•	•
427	V514270103	87906E0160	7 1/4" w x 14 1/4" h	Left	Black	Remote	•	•
427	V514270004	87903E0030 87903E0031	7 1/4" w x 14 1/4" h	Right	Black	Manual	•	•
427	V514270003	87906E0030 87906E0031	7 1/4" w x 14 1/4" h	Left	Black	Manual	•	•
427	V514270014	879010W051	7 1/4" w x 14 1/4" h	Right	Black	Manual	•	-
427	V514270013	879060W010 879060W011	7 1/4" w x 14 1/4" h	Left	Black	Manual	•	-
427	V514270002	87903E0090 87903E0091	7 1/4" w x 14 1/4" h	Right	Black	Manual	-	-
427	V514270001	87906E0051	7 1/4" w x 14 1/4" h	Left	Black	Manual	-	-

**NOTE: Part numbers listed in RED are NEW!**

## HINO

### 427 System

Continued

#### Flat Glass Kit

Model	Part #	O.E.M.	Glass Size	Side	Color	M/R	Heat
427	V154270011	87961E0020	7¼"w x 14¼"h	Both	Black	Both	•
427	V154270010	87961E0010	7¼"w x 14¼"h	Both	Black	Both	-
427	V614270004 <sup>2</sup>	87903E0170 87903E0171	7¼"w x 14¼"h	Right	Black	Both	•
427	V614270005 <sup>2</sup>	87906E0110	7¼"w x 14¼"h	Left	Black	Both	•
427	V614270002 <sup>2</sup>	87903E0160 87903E0161	7¼"w x 14¼"h	Right	Black	Both	-
427	V614270003 <sup>2</sup>	87906E0100	7¼"w x 14¼"h	Left	Black	Both	-

#### Mirror Cover

Model	Part #	O.E.M.	Side	Light	Color
427	V134271009 <sup>3</sup>	-	Both	•	Chrome
427	V134271008	S8791E0030	Both	-	Chrome
427	V614271007 <sup>3,4</sup>	S8791E0040	Both	•	Chrome
427	V134271001 <sup>3</sup>	-	Both	•	Black
427	V134271000	S8791E0010	Both	-	Black
427	V614270006 <sup>3,4</sup>	S8791E0020	Both	•	Black

#### NOTES

<sup>2</sup> Includes housing

<sup>3</sup> Furnished with punched holes

<sup>4</sup> Furnished with marker light

#### Flat Mirror Actuator

Model	Part #	Side
427	V084270006	Both



Call the Velvac Sales Team: **800.783.8871** sales@velvac.com

© VELVAC INC. • 2405 South Calhoun Road • New Berlin, WI 53151-2709 • Toll Free: 800.783.8871 • Fax: 262.786.4101

Various | **260 System**



**Vehicle:**

Various (2005-2006)

- Fits  $\frac{9}{16}$ - $\frac{3}{4}$ " tube

**Convex Head Size**

$7\frac{7}{8}$ "w x  $6\frac{1}{8}$ "h x  $3\frac{3}{4}$ "d

NOTES

**M/R** Manual / remote

**Convex Glass Head** Head adjustable

Model	Part #	O.E.M.	Glass Size	Side	Color	M/R	Heat	Light
260	V562601127	S8790E0010	$7\frac{1}{2}$ "w x $5\frac{5}{8}$ "h	Both	Black	Manual	-	-

**NOTE: Part numbers listed in RED are NEW!**



# MIRRORS

## HME FIRE TRUCK CHASSIS GROUP

**407 System** | Custom Pumper, Tanker, Rescue. Platform. Scorpion™. Silverfox®



### Vehicle:

Custom Pumper, Tanker, Rescue. Platform. Scorpion™. Silverfox® (2004-Present)

- Fits 1- 1 1/8" tube

### Head Size

8 1/16" w x 15 1/16" h x 5 1/4" d

### NOTES

**M/R** Manual / remote

<sup>1</sup> Furnished less electrical harness. Contact Velvac for specific part numbers and availability

<sup>2</sup> Chrome backcover with chrome housing

- For Commercial Pumper, Tanker, Wolf, Wildland and Redfox, consult specific vehicle make/model section of this catalog.

### Side Mount Bracket

Model	Part #	Dimension "A"	Dimension "B"	Side	Color	Material
407	V584070310 <sup>1</sup>	31 3/4"	7 5/64"	Both	Stainless	Stainless

- Dimension A: Distance between upper and lower bracket holder mounting holes
- Dimension B: Distance between the outside edge of the mirror bracket and the mounting surface

### Flat Glass Head *Glass adjustable*

Model	Part #	Glass Size	Side	Color	M/R	Heat	Light
427	V514270016 <sup>2</sup>	7 1/4" w x 14 1/4" h	Right	Chrome	Remote	•	-
427	V514270015 <sup>2</sup>	7 1/4" w x 14 1/4" h	Left	Chrome	Remote	•	-

### Flat Glass Kit

Model	Part #	Glass Size	Side	Color	M/R	Heat
427	V154270011	7 1/4" w x 14 1/4" h	Both	Black	Both	•

### Mirror Cover

Model	Part #	Side	Color	Light
427	V134271008	Both	Chrome	-



Call the Velvac Sales Team: **800.783.8871** sales@velvac.com

© VELVAC INC. • 2405 South Calhoun Road • New Berlin, WI 53151-2709 • Toll Free: 800.783.8871 • Fax: 262.786.4101

## HME FIRE TRUCK CHASSIS GROUP

**407 System**  
Continued

### Convex Glass Head Glass adjustable

Model	Part #	Glass Size	Side	Color	M/R	Heat	Light
428	V564281014 <sup>2</sup>	7¾"w x 5¾"h	Both	Chrome	Manual	•	-
428	V564281015 <sup>2,3</sup>	7¾"w x 5¾"h	Both	Chrome	Manual	•	-

### Convex Glass Kit

Model	Part #	Glass Size	Side	Color	M/R	Heat
428	V154280002	7¾"w x 5¾"h	Both	Black	Manual	•
428	V154280003 <sup>3</sup>	7¾"w x 5¾"h	Both	Black	Manual	•

### Convex Mirror Cover

Model	Part #	Side	Color	Light
428	V134281015	Both	Chrome	-

### Flat Mirror Actuator

Model	Part #	Side
427	V084270006	Both

### Accessories

- **Head Clamp & Screws Kit**  
Model 400 | Part # V614000010
- **2-Mirror Switch**  
Part # V083200233  
(OEM 79885145)

### NOTES

- <sup>2</sup> Chrome backcover with chrome housing  
<sup>3</sup> Furnished with turn signal

**NOTE: Part numbers listed in RED are NEW!**

# MIRRORS

## INTERNATIONAL

**405 System** | **Standard Mirror** | DuraStar, WorkStar, TranStar



### Vehicle:

DuraStar 4100, 4200, 4200LP, 4300, 4300LP, 4400, 4400LP, 4700, 4700LP, 4700LPX, 4800, 4900, Hybrid, Mid-Cab. WorkStar 7300, 7400, 7500, 7600, 7700, Hybrid. TranStar 8100, 8100CH, 8200, 8500, 8600 (2002-Present)

- Fits 1 - 1 1/8" tube

### NOTES

- CB** Bracket assembly furnished with wiring harness for CB
- Look Down** Bracket assembly furnished with black look down mirror
- U/L** Bracket assembly furnished with wiring harness for heated flat (upper) and convex (lower) mirrors
- M/R** Manual / remote

### Bracket Assemblies

Model	Part #	O.E.M.	Side	Color	M/R	Heat	CB	Look Down	U/L
405	V584004001	2505274C3	Left	Black	Manual	-	-	-	-
405	V584004002	2505275C3	Right	Black	Manual	-	-	-	-
405	V584004004	2505278C3	Right	Black	Manual	-	-	•	-
405	V584004005	2505276C4	Left	Black	Manual	-	•	-	-
405	V584004006	2505277C4	Right	Black	Manual	-	•	-	-
405	V584005009	2589149C2	Left	Black	Manual	•	-	-	•
405	V584005010	2589150C2	Right	Black	Manual	•	-	-	•
405	V584005012	2589153C2	Right	Black	Manual	•	-	•	•
405	V584005013	2589151C2	Left	Black	Manual	•	•	-	•
405	V584005014	2589152C2	Right	Black	Manual	•	•	-	•
405	V584005016	2589154C2	Right	Black	Manual	•	•	•	•
405	V584004046	2595651C1	Right	Black	Remote	•	-	-	•
405	V584004048	2595652C1	Right	Black	Remote	•	-	•	•
405	V584004033	2589844C1	Left	Black	Remote	•	•	-	•
405	V584004034	2589847C1	Right	Black	Remote	•	•	-	•



Call the Velvac Sales Team: **800.783.8871** sales@velvac.com

© VELVAC INC. • 2405 South Calhoun Road • New Berlin, WI 53151-2709 • Toll Free: 800.783.8871 • Fax: 262.786.4101

### 405 System

Continued

#### Flat Glass Glass only

Model	Part #	O.E.M.	Glass Size	Side	Color	M/R	Heat
405	V404055800	2505814C2	7 <sup>5</sup> / <sub>8</sub> "w x 16 <sup>3</sup> / <sub>4</sub> "h	Both	n/a	Both	•
405	V404055700	2505813C2	7 <sup>5</sup> / <sub>8</sub> "w x 16 <sup>3</sup> / <sub>4</sub> "h	Both	n/a	Both	-

#### Convex Glass Glass only

Model	Part #	O.E.M.	Glass Size	Side	Color	M/R	Heat
406	V404065304	2505816C2	7 <sup>5</sup> / <sub>8</sub> "w x 7 <sup>5</sup> / <sub>8</sub> "h	Both	n/a	Manual	•
406	V404065204	2505815C2	7 <sup>5</sup> / <sub>8</sub> "w x 7 <sup>5</sup> / <sub>8</sub> "h	Both	n/a	Manual	-

#### Convex Look Down Mirror (Optional) No mirror holder provided

Model	Part #	O.E.M.	Glass Size	Side	Color	M/R	Heat	Light
360	V563600260	2506220C91 2506220C92	10 <sup>5</sup> / <sub>8</sub> "w x 6 <sup>1</sup> / <sub>4</sub> "h	Right	Chrome	Manual	-	-
360	V563600160	-	10 <sup>5</sup> / <sub>8</sub> "w x 6 <sup>1</sup> / <sub>4</sub> "h	Right	Black	Manual	-	-

#### Flat Head Size

8<sup>3</sup>/<sub>16</sub>"w x 17<sup>3</sup>/<sub>8</sub>"h x 4<sup>3</sup>/<sub>8</sub>"d

#### Convex Head Size

8<sup>1</sup>/<sub>8</sub>"w x 8<sup>1</sup>/<sub>8</sub>"h x 4<sup>9</sup>/<sub>16</sub>"d

#### Accessories

- **Head Clamp & Screw Kit**  
Model 405 | Part # V624059999  
(OEM 2507274C1)

**NOTE: Part numbers listed in RED are NEW!**

# MIRRORS

## INTERNATIONAL

**400 System | Premium Mirror | DuraStar, WorkStar, TranStar**



### Vehicle:

DuraStar 4100, 4200, 4200LP, 4300, 4300LP, 4400, 4400LP, 4700, 4700LP, 4700LPX, 4800, 4900, Hybrid, Mid-Cab. WorkStar 7300, 7400, 7500, 7600, 7700, Hybrid. TranStar 8100, 8100CH, 8200, 8500, 8600 (2002-Present)

- Fits 1 - 1 1/8" tube

### NOTES

- CB** Bracket assembly furnished with wiring harness for CB
- Look Down** Bracket assembly furnished with black or chrome look down mirror
- U** Bracket assembly furnished with wiring harness for lighted flat (upper) mirror
- U/L** Bracket assembly furnished with wiring harness for heated flat (upper) and convex (lower) mirrors

### 102 Inch Wide Bracket Assemblies

Model	Part #	O.E.M.	Side	Color	M/R	Heat	CB	Look Down	U	U/L
400	V584004025	2506299C3	Left	Black	Remote	•	-	-	•	•
400	V584004026	2505324C3	Right	Black	Remote	•	-	-	•	•
400	V584004028	2505811C3	Right	Black	Remote	•	-	Black	•	•
400	V584004029	2506300C4	Left	Black	Remote	•	•	-	•	•
400	V584004030	2505302C4	Right	Black	Remote	•	•	-	•	•
400	V584004032	2505812C3	Right	Black	Remote	•	•	Black	•	•
400	V584004501	2505320C3	Left	Stainless	Manual	-	-	-	-	-
400	V584004502	2505321C3	Right	Stainless	Manual	-	-	-	-	-
400	V584004504	2505301C3	Right	Stainless	Manual	-	-	Chrome	-	-
400	V584004505	2505296C4	Left	Stainless	Manual	-	•	-	-	-
400	V584004506	2505298C4	Right	Stainless	Manual	-	•	-	-	-
400	V584004509	2509017C3	Left	Stainless	Manual	•	-	-	•	•
400	V584004526	2599424C1	Right	Stainless	Manual	•	-	-	•	•
400	V584004528	2599423C1	Right	Stainless	Manual	•	-	Chrome	•	•
400	V584004513	2505304C4	Left	Stainless	Manual	•	•	-	•	•
400	V584004530	2599426C1	Right	Stainless	Manual	•	•	-	•	•
400	V584004532	2599427C1	Right	Stainless	Manual	•	•	Chrome	•	•
400	V584004517	2505325C3	Left	Stainless	Remote	•	-	-	•	•
400	V584004518	2505326C3	Right	Stainless	Remote	•	-	-	•	•
400	V584004520	2505303C3	Right	Stainless	Remote	•	-	Chrome	•	•
400	V584004521	2506298C4	Left	Stainless	Remote	•	•	-	•	•
400	V584004522	2505305C4	Right	Stainless	Remote	•	•	-	•	•
400	V584004524	2505810C3	Right	Stainless	Remote	•	•	Chrome	•	•

**M/R** Manual / remote



Call the Velvac Sales Team: **800.783.8871** sales@velvac.com

© VELVAC INC. • 2405 South Calhoun Road • New Berlin, WI 53151-2709 • Toll Free: 800.783.8871 • Fax: 262.786.4101

#### 96 Inch Wide Bracket Assemblies

Model	Part #	O.E.M.	Side	Color	M/R	Heat	U	U/L
400	V584004535	2596626C1	Left	Stainless	Remote	•	•	•
400	V584004536	2589850C1	Right	Stainless	Remote	•	•	•

#### Flat Glass Kit

Model	Part #	O.E.M.	Glass Size	Side	Color	M/R	Heat
400	V154003107	2505818C1 2505818C2	7¼"w x 14⅞"h	Both	Black	Both	•
400	V154003100	2505817C1 2505817C2	7¼"w x 14⅞"h	Both	Black	Both	-

#### Convex Glass Kit

Model	Part #	O.E.M.	Glass Size	Side	Color	M/R	Heat
400	V154003117	2505820C1 2505820C2 2505820C3	7"w x 6⅜"h	Both	Black	Manual	•
400	V154003110	2505819C1 2505819C2	7"w x 6⅜"h	Both	Black	Manual	-
400	V154004002 <sup>1</sup>	2594622C91	7"w x 6⅜"h	Right	Black	Manual	•
400	V154004001 <sup>1</sup>	2594621C91	7"w x 6⅜"h	Left	Black	Manual	•

#### Flat Mirror Actuators

Model	Part #	O.E.M.	Side
400	V094002590 <sup>2</sup>	2592422C1	Both
425	V094252591 <sup>3</sup>	2595653C1	Both

#### Head Size

8¾"w x 24¾"h x 5⅜"d

#### NOTES

- <sup>1</sup> Furnished with turn signal
- <sup>2</sup> Furnished with cable assembly without turn signal
- <sup>5</sup> Furnished with cable assembly for turn signal

#### Convex Look Down Mirror (Optional) No mirror holder provided

Model	Part #	O.E.M.	Glass Size	Side	Color	M/R	Heat	Light
360	V563600260	2506220C91 2506220C92	10⅝"w x 6¼"h	Right	Chrome	Manual	-	-
360	V563600160	-	10⅝"w x 6¼"h	Right	Black	Manual	-	-

#### Accessories

- **CB Antenna Holder Assembly**  
Model 400 | Part # V084002002  
(OEM 2506242C92)
- **Replacement CB Harness**  
Model 400 | Part # V084000100  
(OEM 2506241C91)
- **Head Clamp & Screw Kit**  
Model 400 | Part # V614000010  
(OEM 2506236C91)

**NOTE: Part numbers listed in RED are NEW!**



# MIRRORS

## INTERNATIONAL

**466 System | Universal Mirror | DuraStar, WorkStar, TranStar**



### Vehicle:

DuraStar 4100, 4200, 4200LP, 4300, 4300LP, 4400, 4400LP, 4700, 4700LP, 4700LPX, 4800, 4900, Hybrid, Mid-Cab. WorkStar 7300, 7400, 7500, 7600, 7700, Hybrid. TranStar 8100, 8100CH, 8200, 8500, 8600 (2015-Present)

- Fits 1 - 1 1/8" tube

### NOTES

- CB** Bracket assembly furnished with wiring harness for CB
- Look Down** Bracket assembly furnished with black or chrome look down mirror
- U** Bracket assembly furnished with wiring harness for lighted flat (upper) mirror
- U/L** Bracket assembly furnished with wiring harness for heated flat (upper) mirror and convex (lower) mirror
- AAT** Bracket assembly furnished with wiring harness for AAT sensor

### Bracket Assemblies

Model	Part #	O.E.M.	Side	Color	M/R	Heat	CB	Look Down	U	U/L	AAT
466	V584660019	2514650C1	Left	Stainless	Remote	•	•	-	•	•	•
466	V584660120	2514652C1	Right	Stainless	Remote	•	•	Chrome	•	•	-
466	V584660020	2514651C1	Right	Stainless	Remote	•	•	-	•	•	-
466	V584660017	2514647C1	Left	Stainless	Remote	•	-	-	•	•	•
466	V584660118	2514649C1	Right	Stainless	Remote	•	-	Chrome	•	•	-
466	V584660018	2514648C1	Right	Stainless	Remote	•	-	-	•	•	-
466	V584660009	2514408C1	Left	Black	Remote	•	•	-	-	•	•
466	V584660110	2514645C1	Right	Black	Remote	•	•	Black	-	•	-
466	V584660010	2514409C1	Right	Black	Remote	•	•	-	-	•	-
466	V584660007	2514405C1	Left	Black	Remote	•	-	-	-	•	•
466	V584660108	2514407C1	Right	Black	Remote	•	-	Black	-	•	-
466	V584660008	2514406C1	Right	Black	Remote	•	-	-	-	•	-
466	V584660005	2514396C1	Left	Black	Manual	•	•	-	-	•	•
466	V584660106	2514398C1	Right	Black	Manual	•	•	Black	-	•	-
466	V584660006	2514397C1	Right	Black	Manual	•	•	-	-	•	-
466	V584660104	2514395C1	Right	Black	Manual	•	-	Black	-	•	-
466	V584660003	2514393C1	Left	Black	Manual	•	-	-	-	•	•
466	V584660004	2514394C1	Right	Black	Manual	•	-	-	-	•	-
466	V584660001	2514390C1	Left	Black	Manual	-	-	-	-	-	•
466	V584660102	2514392C1	Right	Black	Manual	-	-	Black	-	-	-
466	V584660023	2514654C1	Left	Black	Manual	-	-	-	-	-	-
466	V584660002	2514391C1	Right	Black	Manual	-	-	-	-	-	-

**M/R** Manual / remote



Call the Velvac Sales Team: **800.783.8871** sales@velvac.com

© VELVAC INC. • 2405 South Calhoun Road • New Berlin, WI 53151-2709 • Toll Free: 800.783.8871 • Fax: 262.786.4101

### 466 System Continued

#### Flat Glass Housing Head adjustable. Order glass to make complete head

Model	Part #	O.E.M.	Glass Size	Side	Color	M/R	Heat	Light
466	V614660009	2514663C91	7½"w x 14"h	Left	Chrome	Remote	•	•
466	V614660008	2514662C91	7½"w x 14"h	Right	Chrome	Remote	•	•
466	V614660007	2514661C91	7½"w x 14"h	Both	Chrome	Manual	-	-
466	V614660006	2514660C91	7½"w x 14"h	Both	Black	Remote	-	-
466	V614660005	2514659C91	7½"w x 14"h	Both	Black	Manual	-	-

#### Flat Glass Kit

Model	Part #	O.E.M.	Glass Size	Side	Color	M/R	Heat
466	V614660001	2514655C91	7½"w x 14"h	Both	n/a	Both	•

#### Convex Glass Housing Head adjustable. Order glass to make complete head

Model	Part #	O.E.M.	Glass Size	Side	Color	M/R	Heat	Light
466	V614660011	2514665C91	7¾"w x 6¾"h	Both	Chrome	Manual	•	-
466	V614660010	2514664C91	7¾"w x 6¾"h	Both	Black	Manual	•	-

#### Convex Glass Kit

Model	Part #	O.E.M.	Glass Size	Side	Color	M/R	Heat
466	V614660002	2514656C91	7¾"w x 6¾"h	Both	n/a	Both	•

#### Flat Mirror Actuator

Model	Part #	O.E.M.	Side
466	V614660004	2514658C91	Both

#### Flat Head Size

7⅞"w x 14⅜"h x 2¾"d

#### Convex Head Size

7¾"w x 7"h x 2¾"d

#### Convex Look Down Mirror (Optional) No mirror holder provided

Model	Part #	O.E.M.	Glass Size	Side	Color	M/R	Heat	Light
360	V563600260	2506220C91 2506220C92	10⅝"w x 6¼"h	Right	Chrome	Manual	-	-
360	V563600160	-	10⅝"w x 6¼"h	Right	Black	Manual	-	-

#### Accessories

##### • Marker Light Kit

Model 466 | Part # V614660003  
(OEM 2514657C91)

**NOTE: Part numbers listed in RED are NEW!**

# MIRRORS

## INTERNATIONAL

### 404 System | DuraStar



#### Vehicle:

DuraStar 4100, 4200, 4200LP, 4300, 4300LP, 4400, 4400LP, 4700, 4700LP, 4700LPX, 4800, 4900, Hybrid, Mid-Cab (2002-Present)

- 1 1/8" tube

#### Head Adjustable

- Convex head size: 7 1/4" w x 7 1/4" h x 3" d

#### Glass Adjustable

- Convex head size: 8 7/16" w x 6 5/8" h x 4 1/2" d

#### Fender Bracket Assembly *No head provided*

Model	Left Bracket #	Right Bracket #	Color	Material	Heat
404	V584049201	V584049202	Stainless	Stainless	-
404	V584049211	V584049212	Black	Steel	-

#### Accessories

- **Head Clamp & Screw Kit**  
Model 405 | Part # V624059999 (OEM 2507274C1)

#### Convex Glass Head *Head adjustable*

Model	Part #	O.E.M.	Glass size	Side	Color	M/R	Heat	Light
388	V563882208	2507272C1	6 3/4" w x 6 3/4" h	Both	Chrome	Manual	-	-
409	V564090013	-	6 3/4" w x 6 3/4" h	Both	Black	Manual	-	-

#### Convex Glass Head *Glass adjustable*

Model	Part #	Glass size	Side	Color	M/R	Heat	Light
428	V564281013 <sup>1</sup>	7 3/4" w x 5 3/4" h	Both	Chrome	Manual	-	-
428	V564281001	7 3/4" w x 5 3/4" h	Both	Black	Manual	-	-

#### Convex Glass Kit

Model	Part #	O.E.M.	Glass Size	Side	Color	M/R	Heat
388/409	V153882120	2507273C1	6 3/4" w x 6 3/4" h	Both	Black	Manual	-
428	V154280001	-	7 3/4" w x 5 3/4" h	Both	Black	Manual	-
428	V614280008 <sup>2</sup>	-	7 3/4" w x 5 3/4" h	Both	Black	Manual	-

#### Convex Mirror Cover

Model	Part #	Side	Color	Light
428	V134281015	Both	Chrome	-
428	V134281011	Both	Black	-

#### NOTES

**M/R** Manual / remote

\* Vertical bracket on Bracket Assembly is 3 13/16" longer (taller) than OEM standard bracket in order to accommodate either Head Adjustable or Glass Adjustable mirror options

<sup>1</sup> Chrome backcover with chrome housing

<sup>2</sup> Includes housing



Call the Velvac Sales Team: **800.783.8871** sales@velvac.com

© VELVAC INC. • 2405 South Calhoun Road • New Berlin, WI 53151-2709 • Toll Free: 800.783.8871 • Fax: 262.786.4101

LoneStar | **Standard Mirror** | **454 System**



### Vehicle:

LoneStar Daycab, Sleeper Cab,  
Harley (2008-Present)

- 5/16-18 UNC Thread both ends

### Flat Head Size

7¼"w x 15⅞"h x 3"d

### Convex Head Size

7¼"w x 7¼"h x 3"d

### Accessories

- **Marker Light Assembly**

Model 438 | Part # **V084380005**  
(OEM 2596753C91)

- **Marker Light Kit w/  
Chrome Bezel**

Model 438 | Part # **V614380005**  
(OEM 2602168C1)

### Flat Glass Mirror Housing Head adjustable. Order glass to make complete head

Model	Part #	O.E.M.	Glass Size	Side	Color	M/R	Heat	Light
438	<b>V514384544</b>	2598604C1	6⅞"w x 16"h	Right	Stainless	Remote	•	•
438	<b>V514384543</b>	2598606C1	6⅞"w x 16"h	Left	Stainless	Remote	•	•

### Flat Glass Kit

Model	Part #	O.E.M.	Glass Size	Side	Color	M/R	Heat
438	<b>V154382117</b>	2595727C1	6⅞"w x 16"h	Both	Black	Both	•

### Convex Glass Housing Head adjustable. Order glass to make complete head

Model	Part #	O.E.M.	Glass Size	Color	M/R	Heat	Light
388	<b>V563882218</b>	2598602C1	6¾"w x 6¾"h	Chrome	Manual	•	-

### Convex Glass Kit

Model	Part #	O.E.M.	Glass Size	Side	Color	M/R	Heat
388	<b>V153882117</b>	2598603C1	6¾"w x 6¾"h	Both	Black	Manual	•

### Convex Look Down Mirror (Optional) No mirror holder provided

Model	Part #	O.E.M.	Glass Size	Side	Color	M/R	Heat	Light
360	<b>V563600260</b>	2506220C91 2506220C92	10⅝"w x 6¼"h	Right	Chrome	Manual	-	-

### NOTES

**M/R** Manual / remote

Bracket not available. Contact OE to purchase.

**NOTE: Part numbers listed in RED are NEW!**

# MIRRORS

## INTERNATIONAL

425 System | Premium Mirror | LoneStar



### Head Size

9 1/8" w x 23 3/4" h x 6 1/8" d

### Vehicle:

LoneStar Daycab, Sleeper Cab,  
Harley (2008-Present)

- Fits 1 1/8" tube

### NOTES

- CB** Bracket assembly furnished with wiring harness for CB
- Look Down** Bracket assembly furnished with black or chrome look down mirror
- L** Bracket assembly furnished with wiring harness for convex (lower) mirror turn signal
- U** Bracket assembly furnished with wiring harness for lighted flat (upper) mirror
- U/L** Bracket assembly furnished with wiring harness for heated flat (upper) mirror and convex (lower) mirror
- M/R** Manual / remote

### Bracket Assemblies

Model	Part #	O.E.M.	Side	Color	M/R	Heat	CB	Look Down	L	U	U/L
425	V584004021	2505300C4	Left	Black	Manual	•	•	-	-	•	•
425	V584004630	2604799C1	Right	Black	Manual	•	•	-	-	•	•
425	V584004025	-	Left	Black	Remote	•	-	-	-	•	•
425	V584004026	2506299C3	Right	Black	Remote	•	-	-	-	•	•
425	V584004028	2505324C3	Right	Black	Remote	•	-	Black	-	•	•
425	V584004029	2505811C3	Left	Black	Remote	•	•	-	-	•	•
425	V584004030	2506300C4	Right	Black	Remote	•	•	-	-	•	•
425	V584004032	2505302C4	Right	Black	Remote	•	•	Black	-	•	•
425	V584004624	2505812C3	Right	Black	Remote	•	•	Chrome	-	•	•
425	V584004525	-	Left	Stainless	Manual	•	-	-	-	•	•
425	V584004526	2599424C1	Right	Stainless	Manual	•	-	-	-	•	•
425	V584004528	2599423C1	Right	Stainless	Manual	•	-	Chrome	-	•	•
425	V584004529	2599422C1	Left	Stainless	Manual	•	•	-	-	•	•
425	V584004530	2599426C1	Right	Stainless	Manual	•	•	-	-	•	•
425	V584004532	2599427C1	Right	Stainless	Manual	•	•	Chrome	-	•	•
425	V584004517	2505325C3	Left	Stainless	Remote	•	-	-	-	•	•
425	V584004518	2505326C3	Right	Stainless	Remote	•	-	-	-	•	•
425	V584004520	2505303C3	Right	Stainless	Remote	•	-	Chrome	-	•	•
425	V584004521	2506298C4	Left	Stainless	Remote	•	•	-	-	•	•
425	V584004522	2505305C4	Right	Stainless	Remote	•	•	-	-	•	•
425	V584250544	2595636C1	Right	Stainless	Remote	•	•	Black	-	•	•
425	V584004524	2505810C3	Right	Stainless	Remote	•	•	Chrome	-	•	•
425	V584250541	2595634C1	Left	Stainless	Remote	•	•	-	•	•	•
425	V584250542	2595635C1	Right	Stainless	Remote	•	•	-	•	•	•
425	V584250574	2595647C1	Right	Stainless	Remote	•	•	Black	•	•	•
425	V584250554	2595644C1	Right	Stainless	Remote	•	•	Chrome	•	•	•



Call the Velvac Sales Team: **800.783.8871** sales@velvac.com

© VELVAC INC. • 2405 South Calhoun Road • New Berlin, WI 53151-2709 • Toll Free: 800.783.8871 • Fax: 262.786.4101

#### Flat Glass Kit

Model	Part #	O.E.M.	Glass Size	Side	Color	M/R	Heat
400	V154003107	2505818C1 2505818C2	7¼"w x 14⅞"h	Both	Black	Both	•
400	V154003100	2505817C1 2505817C2	7¼"w x 14⅞"h	Both	Black	Both	-

#### Convex Glass Kit

Model	Part #	O.E.M.	Glass Size	Side	Color	Heat
400	V154003117	2505820C1 2505820C2 2505820C3	7"w x 6⅜"h	Both	Black	•
400	V154003110	2505819C1 2505819C2	7"w x 6⅜"h	Both	Black	-
400	V154004002 <sup>1</sup>	2594622C91	7"w x 6⅜"h	Right	Black	•
400	V154004001 <sup>1</sup>	2594621C91	7"w x 6⅜"h	Left	Black	•

#### Accessories

- **Clamp Kit, 3 EA**

Model 425 | Part # V614250010  
(OEM 2595657C91)

#### NOTES

<sup>1</sup> Furnished with turn signal

<sup>2</sup> Furnished with cable assembly for turn signal

<sup>3</sup> Furnished with cable assembly without turn signal

#### Flat Mirror Actuator

Model	Part #	O.E.M.	Side
425	V094252591 <sup>2</sup>	2595653C1	Both
425	V094002590 <sup>3</sup>	2592422C1	Both

#### Convex Look Down Mirror (Optional) No mirror holder provided

Model	Part #	O.E.M.	Glass Size	Side	Color	M/R	Heat	Light
360	V563600260	2506220C91 2506220C92	10⅝"w x 6¼"h	Right	Chrome	Manual	-	-
360	V563600160	-	10⅝"w x 6¼"h	Right	Black	Manual	-	-

**NOTE: Part numbers listed in RED are NEW!**



## INTERNATIONAL

420 System | Aero Mirror | PayStar



### Vehicle:

PayStar 5000, 5070, 5500, 5600, 5900SFA, 5900SBA, 9100, 9100i, 9200, 9200i, 9300, 9400, 9400i, 9600, 9700, 9800, 9900, 9900i, 9900ix (2005-Present)

- Fits 1 $\frac{1}{8}$ " tube

### Head Size

10 $\frac{1}{8}$ "w x 24 $\frac{1}{8}$ "h x 4 $\frac{1}{2}$ "d

### NOTES

Bracket, head and glass not available.  
Contact OE to purchase.

### Flat Mirror Actuator

Model	Part #	Side
420	V084200101	Both



Call the Velvac Sales Team: **800.783.8871** [sales@velvac.com](mailto:sales@velvac.com)

© VELVAC INC. • 2405 South Calhoun Road • New Berlin, WI 53151-2709 • Toll Free: 800.783.8871 • Fax: 262.786.4101



### Vehicle:

PayStar 5000, 5070, 5500, 5600, 5900SFA, 5900SBA. 9100, 9100i, 9200, 9200i, 9300, 9400, 9400i, 9600, 9700, 9800, 9900, 9900i, 9900ix (2004-Present)

- 5/16-18 UNC Thread both ends

### Flat Head Size

7¼" w x 15⅞" h x 3" d

### Accessories

- **Marker Light Kit**

Model 421 | Part # **V614210001**  
(OEM 2596752C91)

### Flat Glass Head Head adjustable

Model	Part #	O.E.M.	Glass Size	Side	Color	M/R	Heat	Light
438	V514380014 <sup>1</sup>	2503919C92	6⅞" w x 16" h	Right	Stainless	Remote	•	•
438	V514380013 <sup>1</sup>	2596749C91	6⅞" w x 16" h	Left	Stainless	Remote	•	•
438	V514380012 <sup>1</sup>	2503923C92	6⅞" w x 16" h	Right	Stainless	Remote	•	-
438	V514380011 <sup>1</sup>	2596747C91	6⅞" w x 16" h	Left	Stainless	Remote	•	-
438	V514380008	2596746C91	6⅞" w x 16" h	Right	Stainless	Manual	•	•
438	V514380007	2503920C92 2596745C91	6⅞" w x 16" h	Left	Stainless	Manual	•	•
438	V514380006	2503924C92	6⅞" w x 16" h	Right	Stainless	Manual	•	-
438	V514380005	2503925C92 2596743C91	6⅞" w x 16" h	Left	Stainless	Manual	•	-

### Flat Glass Kit

Model	Part #	O.E.M.	Glass Size	Side	Color	M/R	Heat
438	V154382117	2595727C1	6⅞" w x 16" h	Both	Black	Both	•

### 8" Convex Mirror Assemblies Head adjustable

Model	Part #	O.E.M.	Glass Size	Side	Color	M/R	Heat	Light
445	V564451101	2507752C3	8⅞"	Both	Stainless	Manual	-	-

### NOTES

**M/R** Manual / remote

<sup>1</sup> Two-way adjustment

Bracket not available. Contact OE to purchase.

**NOTE: Part numbers listed in RED are NEW!**

# MIRRORS

## INTERNATIONAL

405 System | Standard Mirror | ProStar



### Vehicle:

ProStar (2006-Present)

- Fits 1 - 1 1/8" tube

### Flat Head Size

8 3/16" w x 17 3/8" h x 4 3/8" d

### Convex Head Size

8 1/8" w x 8 1/8" h x 4 7/16" d

### NOTES

**CB** Bracket assembly furnished with wiring harness for CB

**Look Down** Bracket assembly furnished with black look down mirror

**U/L** Bracket assembly furnished with wiring harness for heated flat (upper) and convex (lower) mirrors

**M/R** Manual / remote

### Bracket Assemblies

Model	Part #	O.E.M.	Side	Color	M/R	Heat	CB	Look Down	U/L
405	V584004001	2505274C3	Left	Black	Manual	-	-	-	-
405	V584004002	2505275C3	Right	Black	Manual	-	-	-	-
405	V584004004	2505278C3	Right	Black	Manual	-	-	•	-
405	V584004005	2505276C4	Left	Black	Manual	-	•	-	-
405	V584004006	2505277C4	Right	Black	Manual	-	•	-	-
405	V584005009	2589149C2	Left	Black	Manual	•	-	-	•
405	V584005010	2589150C2	Right	Black	Manual	•	-	-	•
405	V584005012	2589153C2	Right	Black	Manual	•	-	•	•
405	V584005013	2589151C2	Left	Black	Manual	•	•	-	•
405	V584005014	2589152C2	Right	Black	Manual	•	•	-	•
405	V584005016	2589154C2	Right	Black	Manual	•	•	•	•
405	V584004046	2595651C1	Right	Black	Remote	•	-	-	•
405	V584004048	2595652C1	Right	Black	Remote	•	-	•	•
405	V584004033	2589844C1	Left	Black	Remote	•	•	-	•
405	V584004034	2589847C1	Right	Black	Remote	•	•	-	•



Call the Velvac Sales Team: **800.783.8871** sales@velvac.com

© VELVAC INC. • 2405 South Calhoun Road • New Berlin, WI 53151-2709 • Toll Free: 800.783.8871 • Fax: 262.786.4101

#### Flat Glass Glass only

Model	Part #	O.E.M.	Glass Size	Side	Color	M/R	Heat
405	V404055800	2505814C2	7 <sup>5</sup> / <sub>8</sub> " w x 16 <sup>3</sup> / <sub>4</sub> "h	Both	n/a	Both	•
405	V404055700	2505813C2	7 <sup>5</sup> / <sub>8</sub> " w x 16 <sup>3</sup> / <sub>4</sub> "h	Both	n/a	Both	-

#### Convex Glass Glass only

Model	Part #	O.E.M.	Glass Size	Side	Color	M/R	Heat
406	V404065304	2505816C2	7 <sup>5</sup> / <sub>8</sub> "w x 7 <sup>5</sup> / <sub>8</sub> "h	Both	n/a	Manual	•
406	V404065204	2505815C2	7 <sup>5</sup> / <sub>8</sub> "w x 7 <sup>5</sup> / <sub>8</sub> "h	Both	n/a	Manual	-

#### Convex Look Down Mirror (Optional) No mirror holder provided

Model	Part #	O.E.M.	Glass Size	Side	Color	M/R	Heat	Light
360	V563600260	2506220C91 2506220C92	10 <sup>5</sup> / <sub>8</sub> "w x 6 <sup>1</sup> / <sub>4</sub> "h	Right	Chrome	Manual	-	-
360	V563600160	-	10 <sup>5</sup> / <sub>8</sub> "w x 6 <sup>1</sup> / <sub>4</sub> "h	Right	Black	Manual	-	-

#### Accessories

- **Head Clamp & Screw Kit**  
Model 405 | Part # V624059999  
(OEM 2507274C1)

**NOTE: Part numbers listed in RED are NEW!**

# MIRRORS

## INTERNATIONAL

425 System | Premium Mirror | ProStar



### Vehicle:

ProStar (2006-Present)

- Fits 1 1/8" tube

### Head Size

9 1/8" w x 23 3/4" h x 6 1/8" d

### NOTES

- CB** Bracket assembly furnished with wiring harness for CB
- Look Down** Bracket assembly furnished with black or chrome look down mirror
- L** Bracket assembly furnished with wiring harness for convex (lower) mirror turn signal
- U** Bracket assembly furnished with wiring harness for lighted flat (upper) mirror
- U/L** Bracket assembly furnished with wiring harness for heated flat (upper) and convex (lower) mirrors
- M/R** Manual / remote

### Bracket Assemblies

Model	Part #	O.E.M.	Side	Color	M/R	Heat	CB	Look Down	L	U	U/L
425	V584004021	2505300C4	Left	Black	Manual	-	•	-	-	•	•
425	V584004630	2604799C1	Right	Black	Manual	-	•	-	-	•	•
425	V584004025	2506299C3	Left	Black	Remote	-	-	-	-	•	•
425	V584004026	2505324C3	Right	Black	Remote	-	-	-	-	•	•
425	V584004028	2505811C3	Right	Black	Remote	-	-	Black	-	•	•
425	V584004029	2506300C4	Left	Black	Remote	•	•	-	-	•	•
425	V584004030	2505302C4	Right	Black	Remote	•	•	-	-	•	•
425	V584004032	2505812C3	Right	Black	Remote	•	•	Black	-	•	•
425	V584004624	2604803C1	Right	Black	Remote	•	•	Chrome	-	•	•
425	V584004525	-	Left	Stainless	Manual	•	-	-	-	•	•
425	V584004526	2599424C1	Right	Stainless	Manual	•	-	-	-	•	•
425	V584004528	2599423C1	Right	Stainless	Manual	•	-	Chrome	-	•	•
425	V584004529	2599422C1	Left	Stainless	Manual	•	•	-	-	•	•
425	V584004530	2599426C1	Right	Stainless	Manual	•	•	-	-	•	•
425	V584004532	2599427C1	Right	Stainless	Manual	•	•	Chrome	-	•	•
425	V584004517	2505325C3	Left	Stainless	Remote	•	-	-	-	•	•
425	V584004518	2505326C3	Right	Stainless	Remote	•	-	-	-	•	•
425	V584004520	2505303C3	Right	Stainless	Remote	•	-	Chrome	-	•	•
425	V584004521	2506298C4	Left	Stainless	Remote	•	•	-	-	•	•
425	V584004522	2505305C4	Right	Stainless	Remote	•	•	-	-	•	•
425	V584250544	2595636C1	Right	Stainless	Remote	•	•	Black	-	•	•
425	V584004524	2505810C3	Right	Stainless	Remote	•	•	Chrome	-	•	•
425	V584250541	2595634C1	Left	Stainless	Remote	•	•	-	•	•	•
425	V584250542	2595635C1	Right	Stainless	Remote	•	•	-	•	•	•
425	V584250574	2595647C1	Right	Stainless	Remote	•	•	Black	•	•	•
425	V584250554	2595644C1	Right	Stainless	Remote	•	•	Chrome	•	•	•



Call the Velvac Sales Team: **800.783.8871** sales@velvac.com

© VELVAC INC. • 2405 South Calhoun Road • New Berlin, WI 53151-2709 • Toll Free: 800.783.8871 • Fax: 262.786.4101

#### Flat Glass Kit

Model	Part #	O.E.M.	Glass Size	Side	Color	M/R	Heat
400	V154003107	2505818C1 2505818C2	7¼" w x 14⅞"h	Both	Black	Both	•
400	V154003100	2505817C1 2505817C2	7¼" w x 14⅞"h	Both	Black	Both	-

#### Convex Glass Kit

Model	Part #	O.E.M.	Glass Size	Side	Color	M/R	Heat
400	V154003117	2505820C1 2505820C2 2505820C3	7" w x 6⅜"h	Both	Black	Manual	•
400	V154003110	2505819C1 2505819C2	7" w x 6⅜"h	Both	Black	Manual	-
400	V154004002 <sup>1</sup>	2594622C91	7" w x 6⅜"h	Right	Black	Manual	•
400	V154004001 <sup>1</sup>	2594621C91	7" w x 6⅜"h	Left	Black	Manual	•

#### Flat Mirror Actuator

Model	Part #	O.E.M.	Side
425	V094252591 <sup>2</sup>	2595653C1	Both
425	V094002590 <sup>3</sup>	2592422C1	Both

#### Accessories

##### • Clamp Kit, 3 EA

Model 425 | Part # V614250010  
(OEM 2595657C91)

#### Convex Look Down Mirror (Optional) No mirror holder provided

Model	Part #	O.E.M.	Glass Size	Side	Color	M/R	Heat	Light
360	V563600260	2506220C91 2506220C92	10⅝"w x 6¼"h	Right	Chrome	Manual	-	-
360	V563600160	-	10⅝"w x 6¼"h	Right	Black	Manual	-	-

#### NOTES

<sup>1</sup> Furnished with turn signal

<sup>2</sup> Furnished with cable assembly for turn signal

<sup>3</sup> Furnished with cable assembly without turn signal

**NOTE: Part numbers listed in RED are NEW!**



## INTERNATIONAL

### 466 System | Universal Mirror | ProStar



#### Vehicle:

ProStar (2015-Present)

- Fits 1 - 1 1/8" tube

#### Flat Head Size

7 7/8" w x 14 3/8" h x 2 3/4" d

#### Convex Head Size

7 3/4" w x 7" h x 2 3/4" d

#### Bracket Assemblies

Model	Part #	O.E.M.	Side	Color	M/R	Heat	CB	Look Down	U	U/L	AAT
466	V584660019	2514650C1	Left	Stainless	Remote	•	•	-	•	•	•
466	V584660120	2514652C1	Right	Stainless	Remote	•	•	Chrome	•	•	-
466	V584660020	2514651C1	Right	Stainless	Remote	•	•	-	•	•	-
466	V584660017	2514647C1	Left	Stainless	Remote	•	-	-	•	•	•
466	V584660118	2514649C1	Right	Stainless	Remote	•	-	Chrome	•	•	-
466	V584660018	2514648C1	Right	Stainless	Remote	•	-	-	•	•	-
466	V584660009	2514408C1	Left	Black	Remote	•	•	-	-	•	•
466	V584660110	2514645C1	Right	Black	Remote	•	•	Black	-	•	-
466	V584660010	2514409C1	Right	Black	Remote	•	•	-	-	•	-
466	V584660007	2514405C1	Left	Black	Remote	•	-	-	-	•	•
466	V584660108	2514407C1	Right	Black	Remote	•	-	Black	-	•	-
466	V584660008	2514406C1	Right	Black	Remote	•	-	-	-	•	-
466	V584660005	2514396C1	Left	Black	Manual	•	•	-	-	•	•
466	V584660106	2514398C1	Right	Black	Manual	•	•	Black	-	•	-
466	V584660006	2514397C1	Right	Black	Manual	•	•	-	-	•	-
466	V584660104	2514395C1	Right	Black	Manual	•	-	Black	-	•	-
466	V584660003	2514393C1	Left	Black	Manual	•	-	-	-	•	•
466	V584660004	2514394C1	Right	Black	Manual	•	-	-	-	•	-
466	V584660001	2514390C1	Left	Black	Manual	-	-	-	-	-	•
466	V584660102	2514392C1	Right	Black	Manual	-	-	Black	-	-	-
466	V584660023	2514654C1	Left	Black	Manual	-	-	-	-	-	-
466	V584660002	2514391C1	Right	Black	Manual	-	-	-	-	-	-



Call the Velvac Sales Team: **800.783.8871** sales@velvac.com

#### Flat Glass Housing Head adjustable. Order glass to make complete head

Model	Part #	O.E.M.	Glass Size	Side	Color	M/R	Heat	Light
466	V614660009	2514663C91	7½"w x 14"h	Left	Chrome	Remote	Both	•
466	V614660008	2514662C91	7½"w x 14"h	Right	Chrome	Remote	Both	•
466	V614660007	2514661C91	7½"w x 14"h	Both	Chrome	Manual	Both	-
466	V614660006	2514660C91	7½"w x 14"h	Both	Black	Remote	Both	-
466	V614660005	2514659C91	7½"w x 14"h	Both	Black	Manual	Both	-

#### Flat Glass Kit

Model	Part #	O.E.M.	Glass Size	Side	Color	M/R	Heat
466	V614660001	2514655C91	7½"w x 14" h	Both	n/a	Both	•

#### Convex Glass Housing Head adjustable. Order glass to make complete head

Model	Part #	O.E.M.	Glass Size	Color	M/R	Heat	Light
466	V614660011	2514665C91	7¾"w x 6¾"h	Chrome	Manual	•	-
466	V614660010	2514664C91	7¾"w x 6¾"h	Black	Manual	•	-

#### Convex Glass Kit

Model	Part #	O.E.M.	Glass Size	Side	Color	M/R	Heat
466	V614660002	2514656C91	7¾"w x 6¾"h	Both	n/a	Manual	•

#### Flat Mirror Actuator

Model	Part #	O.E.M.	Side
466	V614660004	2514658C91	Both

#### Accessories

- **Marker Light Kit**  
Model 466 | Part # V614660003  
(OEM 2514657C91)

#### Convex Look Down Mirror (Optional) No mirror holder provided

Model	Part #	O.E.M.	Glass Size	Color	M/R	Heat	Light
360	V563600260	2506220C91 2506220C92	10⅝"w x 6¼"h	Chrome	Manual	-	-
360	V563600160	-	10⅝"w x 6¼"h	Black	Manual	-	-

#### NOTES

- CB** Bracket assembly furnished with wiring harness for CB
- Look Down** Bracket assembly furnished with black or chrome look down mirror
- U** Bracket assembly furnished with wiring harness for lighted flat (upper) mirror
- U/L** Bracket assembly furnished with wiring harness for heated flat (upper) and convex (lower) mirrors
- AAT** Bracket assembly furnished with wiring harness for AAT sensor
- M/R** Manual / remote

**NOTE: Part numbers listed in RED are NEW!**

# MIRRORS

## INTERNATIONAL

### 404 System | ProStar



Head Adjustable

Glass Adjustable

Bracket Assembly

#### Vehicle:

ProStar (2006-Present)

- 1½" tube

#### Head Adjustable

- Convex head size:  
7¼" w x 7¼" h x 3" d
- Mirror size: 6¾" w x 6¾" h

#### Glass Adjustable

- Convex head size:  
8⅞" w x 6⅝" h x 4½" d
- Mirror size: 7¾" w x 5¾" h

#### Accessories

- **Head Clamp & Screw Kit**

Model 405 | Part # V624059999  
(OEM 2507274C1)

#### Fender Bracket Assembly *No head provided*

Model	Left Bracket #	Right Bracket #	Color	Material	Heat
404	V584049001	V584049002	Stainless	Stainless	-
404	V584049011	V584049012	Black	Steel	-

#### Convex Glass Head *Head adjustable*

Model	Part #	O.E.M.	Glass Size	Side	Color	M/R	Heat	Light
388	V563882208	2507272C1	6¾" w x 6¾" h	Both	Chrome	Manual	-	-
409	V564090013	-	6¾" w x 6¾" h	Both	Black	Manual	-	-

#### Convex Glass Head *Glass adjustable*

Model	Part #	Glass Size	Side	Color	M/R	Heat	Light
428	V564281013 <sup>1</sup>	7¾" w x 5¾" h	Both	Chrome	Manual	-	-
428	V564281001	7¾" w x 5¾" h	Both	Black	Manual	-	-

#### Convex Glass Kit

Model	Part #	O.E.M.	Glass Size	Side	Color	M/R	Heat
388/409	V153882120	2507273C1	6¾" w x 6¾" h	Both	Black	Manual	-
428	V154280001	-	7¾" w x 5¾" h	Both	Black	Manual	-
428	V614280008 <sup>2</sup>	-	7¾" w x 5¾" h	Both	Black	Manual	-

#### Convex Mirror Cover

Model	Part #	Side	Color	Light
428	V134281015	Both	Chrome	-
428	V134281011	Both	Black	-

#### NOTES

**M/R** Manual / remote

\*Vertical bracket on Bracket Assembly is 1 9/16" longer (taller) than OEM standard bracket, in order to accommodate either Head Adjustable or Glass Adjustable mirror options

<sup>1</sup> Chrome backcover with chrome housing

<sup>2</sup> Includes housing



Call the Velvac Sales Team: **800.783.8871** sales@velvac.com

© VELVAC INC. • 2405 South Calhoun Road • New Berlin, WI 53151-2709 • Toll Free: 800.783.8871 • Fax: 262.786.4101

S-Series | **West Coast Mirrors**



International plug

**Vehicle:**

S-series and other trucks

**Housing Size**

- 7" x 16" aluminum head
- Order 713198 loop and bracket kit separately

**West Coast Mirror Head**

Part #	Fletridge Part #	Navistar Part #	Cham-Cal Part #	Side	Heat
708335	MIR4070	1657021C91 1657048C91	20000	Both	-
708336	MIR4071	1667899C91	20090	Right	•
708337	MIR4074	1669515C91	20080	Left	•

**Loop and Bracket Assembly**

Part #	Description
713198	Loop and bracket assembly

**NOTE: Part numbers listed in RED are NEW!**

# MIRRORS

## INTERNATIONAL

405 System | Standard Mirror | TerraStar



### Vehicle:

TerraStar Class 4/5 (2010-Present)

- Fits 1 - 1 1/8" tube

### Flat Head Size

8 3/16" w x 17 3/8" h x 4 3/8" d

### Convex Head Size

8 1/8" w x 8 1/8" h x 4 7/16" d

### NOTES

**CB** Bracket assembly furnished with wiring harness for CB

**Look Down** Bracket assembly furnished with black look down mirror

**U/L** Bracket assembly furnished with wiring harness for heated flat (upper) and convex (lower) mirrors

**M/R** Manual / remote

### Bracket Assemblies

Model	Part #	O.E.M.	Side	Color	M/R	Heat	CB	Look Down	U/L
405	V584004001	2505274C3	Left	Black	Manual	-	-	-	-
405	V584004002	2505275C3	Right	Black	Manual	-	-	-	-
405	V584004004	2505278C3	Right	Black	Manual	-	-	•	-
405	V584004005	2505276C4	Left	Black	Manual	-	•	-	-
405	V584004006	2505277C4	Right	Black	Manual	-	•	-	-
405	V584005009	2589149C2	Left	Black	Manual	•	-	-	•
405	V584005010	2589150C2	Right	Black	Manual	•	-	-	•
405	V584005012	2589153C2	Right	Black	Manual	•	-	•	•
405	V584005013	2589151C2	Left	Black	Manual	•	•	-	•
405	V584005014	2589152C2	Right	Black	Manual	•	•	-	•
405	V584005016	2589154C2	Right	Black	Manual	•	•	•	•
405	V584004046	2595651C1	Right	Black	Remote	•	-	-	•
405	V584004048	2595652C1	Right	Black	Remote	•	-	•	•
405	V584004033	2589844C1	Left	Black	Remote	•	•	-	•
405	V584004034	2589847C1	Right	Black	Remote	•	•	-	•



Call the Velvac Sales Team: **800.783.8871** sales@velvac.com

© VELVAC INC. • 2405 South Calhoun Road • New Berlin, WI 53151-2709 • Toll Free: 800.783.8871 • Fax: 262.786.4101

#### Flat Glass Kit *Glass only*

Model	Part #	O.E.M.	Glass Size	Side	Color	M/R	Heat
405	V404055800	2505814C2	7 <sup>5</sup> / <sub>8</sub> " w x 16 <sup>3</sup> / <sub>4</sub> "h	Both	n/a	Both	•
405	V404055700	2505813C2	7 <sup>5</sup> / <sub>8</sub> " w x 16 <sup>3</sup> / <sub>4</sub> "h	Both	n/a	Both	-

#### Convex Glass Kit *Glass only*

Model	Part #	O.E.M.	Glass Size	Side	Color	M/R	Heat
406	V404065304	2505816C2	7 <sup>5</sup> / <sub>8</sub> " w x 7 <sup>5</sup> / <sub>8</sub> "h	Both	n/a	Manual	•
406	V404065204	2505815C2	7 <sup>5</sup> / <sub>8</sub> " w x 7 <sup>5</sup> / <sub>8</sub> "h	Both	n/a	Manual	-

#### Convex Look Down Mirror (Optional) *No mirror holder provided*

Model	Part #	O.E.M.	Glass Size	Side	Color	M/R	Heat	Light
360	V563600260	2506220C91 2506220C92	10 <sup>5</sup> / <sub>8</sub> " w x 6 <sup>1</sup> / <sub>4</sub> "h	Right	Chrome	Manual	-	-
360	V563600160	-	10 <sup>5</sup> / <sub>8</sub> " w x 6 <sup>1</sup> / <sub>4</sub> "h	Right	Black	Manual	-	-

#### Accessories

- **Head Clamp & Screw Kit**

Model 405 | Part # V624059999  
(OEM 2507274C1)

**NOTE: Part numbers listed in RED are NEW!**



## INTERNATIONAL

463 System | Standard Mirror | TerraStar



### Vehicle:

TerraStar Class 4/5 (2010-Present)

- Fits 1 - 1 1/8" tube

### Flat Head Size

7 1/4"w x 12 3/8"h x 3 1/2"d

### Convex Head Size

8 7/8"w x 6 7/8"h x 4 1/8"d

### Accessories

- **Head Clamp & Screw Kit**

Model 405 | Part # **V624059999**  
(OEM 2507274C1)

### NOTES

**M/R** Manual / remote

### Bracket Assemblies

Model	Part #	O.E.M.	Side	Color	M/R	Heat
463	V584004001	2505274C3	Left	Black	Manual	-
463	V584004002	2505275C3	Right	Black	Manual	-

### Flat Glass Head Head adjustable

Model	Part #	O.E.M.	Glass Size	Side	Color	M/R	Heat	Light
408	V514080002	2588800C2	6 3/4"w x 12"h	Both	Black	Manual	-	-

### Convex Glass Head Head adjustable

Model	Part #	O.E.M.	Glass Size	Side	Color	M/R	Heat	Light
408	V564080002	2588801C2	8"w x 6"h	Both	Black	Manual	-	-



Call the Velvac Sales Team: **800.783.8871** sales@velvac.com

TerraStar | Premium Mirror | 400 System



### Vehicle:

TerraStar Class 4/5 (2010-Present)

- Fits 1 - 1 1/8" tube

### Head Size

8 3/4" w x 24 3/4" h x 5 3/8" d

### NOTES

- CB** Bracket assembly furnished with wiring harness for CB
- Look Down** Bracket assembly furnished with black or chrome look down mirror
- U** Bracket assembly furnished with wiring harness for lighted flat (upper) mirror
- U/L** Bracket assembly furnished with wiring harness for heated flat (upper) and convex (lower) mirrors
- M/R** Manual / remote

### 102 Inch Wide Bracket Assemblies

Model	Part #	O.E.M.	Side	Color	M/R	Heat	CB	Look Down	U	U/L
400	V584004025	2506299C3	Left	Black	Remote	•	-	-	•	•
400	V584004026	2505324C3	Right	Black	Remote	•	-	-	•	•
400	V584004028	2505811C3	Right	Black	Remote	•	-	Black	•	•
400	V584004029	2506300C4	Left	Black	Remote	•	•	-	•	•
400	V584004030	2505302C4	Right	Black	Remote	•	•	-	•	•
400	V584004032	2505812C3	Right	Black	Remote	•	•	Black	•	•
400	V584004501	2505320C3	Left	Stainless	Manual	-	-	-	-	-
400	V584004502	2505321C3	Right	Stainless	Manual	-	-	-	-	-
400	V584004504	2505301C3	Right	Stainless	Manual	-	-	Chrome	-	-
400	V584004505	2505296C4	Left	Stainless	Manual	-	•	-	-	-
400	V584004506	2505298C4	Right	Stainless	Manual	-	•	-	-	-
400	V584004509	2509017C3	Left	Stainless	Manual	•	-	-	•	•
400	V584004526	2599424C1	Right	Stainless	Manual	•	-	-	•	•
400	V584004528	2599423C1	Right	Stainless	Manual	•	-	Chrome	•	•
400	V584004513	2505304C4	Left	Stainless	Manual	•	•	-	•	•
400	V584004530	2599426C1	Right	Stainless	Manual	•	•	-	•	•
400	V584004532	2599427C1	Right	Stainless	Manual	•	•	Chrome	•	•
400	V584004517	2505325C3	Left	Stainless	Remote	•	-	-	•	•
400	V584004518	2505326C3	Right	Stainless	Remote	•	-	-	•	•
400	V584004520	2505303C3	Right	Stainless	Remote	•	-	Chrome	•	•
400	V584004521	2506298C4	Left	Stainless	Remote	•	•	-	•	•
400	V584004522	2505305C4	Right	Stainless	Remote	•	•	-	•	•
400	V584004524	2505810C3	Right	Stainless	Remote	•	•	Chrome	•	•

**NOTE: Part numbers listed in RED are NEW!**

## INTERNATIONAL

### 400 System

Continued

#### 96 Inch Wide Bracket Assemblies

Model	Part #	O.E.M.	Side	Color	M/R	Heat	U	U/L
400	V584004535	2596626C1	Left	Stainless	Remote	•	•	•
400	V584004536	2589850C1	Right	Stainless	Remote	•	•	•

#### Flat Glass Kit

Model	Part #	O.E.M.	Glass Size	Side	Color	M/R	Heat
400	V154003107	2505818C1 2505818C2	7¼"w x 14⅞"h	Both	Black	Both	•
400	V154003100	2505817C1 2505817C2	7¼"w x 14⅞"h	Both	Black	Both	-

#### Convex Glass Kit

Model	Part #	O.E.M.	Glass Size	Side	Color	M/R	Heat
400	V154003117	2505820C1 2505820C2 2505820C3	7"w x 6⅜"h	Both	Black	Manual	•
400	V154003110	2505819C1 2505819C2	7"w x 6⅜"h	Both	Black	Manual	-
400	V154004002 <sup>1</sup>	2594622C91	7"w x 6⅜"h	Right	Black	Manual	•
400	V154004001 <sup>1</sup>	2594621C91	7"w x 6⅜"h	Left	Black	Manual	•

#### Flat Mirror Actuators

Model	Part #	O.E.M.	Side
400	V094002590 <sup>2</sup>	2592422C1	Both
425	V094252591 <sup>3</sup>	2595653C1	Both

#### Accessories

- **CB Antenna Holder Assembly**

Model 400 | Part # V084002002  
(OEM 2506242C92)

- **Replacement CB Harness**

Model 400 | Part # V084000100  
(OEM 2506241C91)

#### Convex Look Down Mirror (Optional) *No mirror holder provided*

Model	Part #	O.E.M.	Glass Size	Side	Color	M/R	Heat	Light
360	V563600260	2506220C91 2506220C92	10⅝"w x 6¼"h	Right	Chrome	Manual	-	-
360	V563600160	-	10⅝"w x 6¼"h	Right	Black	Manual	-	-

- **Head Clamp & Screw Kit**

Model 400 | Part # V614000010  
(OEM 2506236C91)

#### NOTES

- <sup>1</sup> Furnished with turn signal
- <sup>2</sup> Furnished with cable assembly without turn signal
- <sup>3</sup> Furnished with cable assembly for turn signal



Call the Velvac Sales Team: **800.783.8871** sales@velvac.com

© VELVAC INC. • 2405 South Calhoun Road • New Berlin, WI 53151-2709 • Toll Free: 800.783.8871 • Fax: 262.786.4101

Premium Mirror | TerraStar



### Vehicle:

TerraStar Class 4/5 (2015-Present)

- Fits 1 - 1 1/8" tube

### Flat Head Size

7 7/8" w x 14 3/8" h x 2 3/4" d

### Convex Head Size

7 3/4" w x 7" h x 2 3/4" d

### Bracket Assemblies

Model	Part #	O.E.M.	Side	Color	M/R	Heat	CB	Look Down	U	U/L	AAT
466	V584660019	2514650C1	Left	Stainless	Remote	•	•	-	•	•	•
466	V584660120	2514652C1	Right	Stainless	Remote	•	•	Chrome	•	•	-
466	V584660020	2514651C1	Right	Stainless	Remote	•	•	-	•	•	-
466	V584660017	2514647C1	Left	Stainless	Remote	•	-	-	•	•	•
466	V584660118	2514649C1	Right	Stainless	Remote	•	-	Chrome	•	•	-
466	V584660018	2514648C1	Right	Stainless	Remote	•	-	-	•	•	-
466	V584660009	2514408C1	Left	Black	Remote	•	•	-	-	•	•
466	V584660110	2514645C1	Right	Black	Remote	•	•	Black	-	•	-
466	V584660010	2514409C1	Right	Black	Remote	•	•	-	-	•	-
466	V584660007	2514405C1	Left	Black	Remote	•	-	-	-	•	•
466	V584660108	2514407C1	Right	Black	Remote	•	-	Black	-	•	-
466	V584660008	2514406C1	Right	Black	Remote	•	-	-	-	•	-
466	V584660005	2514396C1	Left	Black	Manual	•	•	-	-	•	•
466	V584660106	2514398C1	Right	Black	Manual	•	•	Black	-	•	-
466	V584660006	2514397C1	Right	Black	Manual	•	•	-	-	•	-
466	V584660104	2514395C1	Right	Black	Manual	•	-	Black	-	•	-
466	V584660003	2514393C1	Left	Black	Manual	•	-	-	-	•	•
466	V584660004	2514394C1	Right	Black	Manual	•	-	-	-	•	-
466	V584660001	2514390C1	Left	Black	Manual	-	-	-	-	-	•
466	V584660102	2514392C1	Right	Black	Manual	-	-	Black	-	-	-
466	V584660023	2514654C1	Left	Black	Manual	-	-	-	-	-	-
466	V584660002	2514391C1	Right	Black	Manual	-	-	-	-	-	-

### NOTES

- CB** Bracket assembly furnished with wiring harness for CB
- Look Down** Bracket assembly furnished with black or chrome look down mirror
- U** Bracket assembly furnished with wiring harness lighted flat (upper) mirror

- U/L** Bracket assembly furnished with wiring harness for heated flat (upper) and convex (lower) mirrors
- AAT** Bracket assembly furnished with wiring harness for AAT sensor
- M/R** Manual / remote

**NOTE: Part numbers listed in RED are NEW!**

## INTERNATIONAL

### 466 System

Continued

#### Accessories

##### • Marker Light Kit

Model 466 | Part # V614660003  
(OEM 2514657C91)

#### Flat Glass Housing Head adjustable. Order glass to make complete head

Model	Part #	O.E.M.	Glass Size	Side	Color	M/R	Heat	Light
466	V614660009	2514663C91	7½"w x 14"h	Left	Chrome	Remote	Both	•
466	V614660008	2514662C91	7½"w x 14"h	Right	Chrome	Remote	Both	•
466	V614660007	2514661C91	7½"w x 14"h	Both	Chrome	Manual	Both	-
466	V614660006	2514660C91	7½"w x 14"h	Both	Black	Remote	Both	-
466	V614660005	2514659C91	7½"w x 14"h	Both	Black	Manual	Both	-

#### Flat Glass Kit

Model	Part #	O.E.M.	Glass Size	Side	Color	M/R	Heat
466	V614660001	2514655C91	7½"w x 14"h	Both	n/a	Both	•

#### Convex Glass Housing Head adjustable. Order glass to make complete head

Model	Part #	O.E.M.	Glass Size	Color	M/R	Heat	Light
466	V614660011	2514665C91	7¾"w x 6¾"h	Chrome	Manual	•	-
466	V614660010	2514664C91	7¾"w x 6¾"h	Black	Manual	•	-

#### Convex Glass Kit

Model	Part #	O.E.M.	Glass Size	Side	Color	M/R	Heat
466	V614660002	2514656C91	7¾"w x 6¾"h	Both	n/a	Manual	•

#### Flat Mirror Actuator

Model	Part #	O.E.M.	Side
466	V614660004	2514658C91	Both

#### Convex Look Down Mirror (Optional) No mirror holder provided

Model	Part #	O.E.M.	Glass Size	Side	Color	M/R	Heat	Light
360	V563600260	2506220C91 2506220C92	10⅝"w x 6¼"h	Right	Chrome	Manual	-	-
360	V563600160	-	10⅝"w x 6¼"h	Right	Black	Manual	-	-



Call the Velvac Sales Team: **800.783.8871** sales@velvac.com

© VELVAC INC. • 2405 South Calhoun Road • New Berlin, WI 53151-2709 • Toll Free: 800.783.8871 • Fax: 262.786.4101

### 404 System | TranStar



#### Vehicle:

TranStar 8100, 8100CH, 8200, 8500, 8600 (2002-Present)

- Fits 1 1/8" tube

#### Head Adjustable

- Convex head size: 7 1/4" w x 7 1/4" h x 3" d

#### Glass Adjustable

- Convex head size: 8 7/16" w x 6 5/8" h x 4 1/2" d

#### Accessories

##### • Head Clamp & Screw Kit

Model 405 | Part # **V624059999**  
(OEM 2507274C1)

#### Fender Bracket Assembly *No head provided*

Model	Left Bracket #	Right Bracket #	Color	Material	Heat
404	<b>V584049101</b>	<b>V584049102</b>	Stainless	Stainless	-
404	<b>V584049111</b>	<b>V584049112</b>	Black	Steel	-

#### Convex Glass Head *Head adjustable*

Model	Part #	O.E.M.	Glass Size	Side	Color	M/R	Heat	Light
388	<b>V563882208</b>	2507272C1	6 3/4" w x 6 3/4" h	Both	Chrome	Manual	-	-
409	<b>V564090013</b>	-	6 3/4" w x 6 3/4" h	Both	Black	Manual	-	-

#### Convex Glass Head *Glass adjustable*

Model	Part #	Glass Size	Side	Color	M/R	Heat	Light
428	<b>V564281013<sup>1</sup></b>	7 3/4" w x 5 3/4" h	Both	Chrome	Manual	-	-
428	<b>V564281001</b>	7 3/4" w x 5 3/4" h	Both	Black	Manual	-	-

#### Convex Glass Kit

Model	Part #	O.E.M.	Glass Size	Side	Color	M/R	Heat
388	<b>V153882120</b>	2507273C1	6 3/4" w x 6 3/4" h	Both	Black	Manual	-
428	<b>V154280001</b>	-	7 3/4" w x 5 3/4" h	Both	Black	Manual	-
428	<b>V614280008<sup>2</sup></b>	-	7 3/4" w x 5 3/4" h	Both	Black	Manual	-

#### Convex Mirror Cover

Model	Part #	Side	Color	Light
428	<b>V134281015</b>	Both	Chrome	-
428	<b>V134281011</b>	Both	Black	-

#### NOTES

**M/R** Manual / remote

\*Vertical bracket on Bracket Assembly is 1 15/16" longer (taller) than OEM standard bracket, in order to accommodate either Head Adjustable or Glass Adjustable mirror options

<sup>1</sup> Chrome backcover with chrome housing

<sup>2</sup> Includes housing

**NOTE: Part numbers listed in RED are NEW!**



# MIRRORS

## INTERNATIONAL

### 404 System | WorkStar

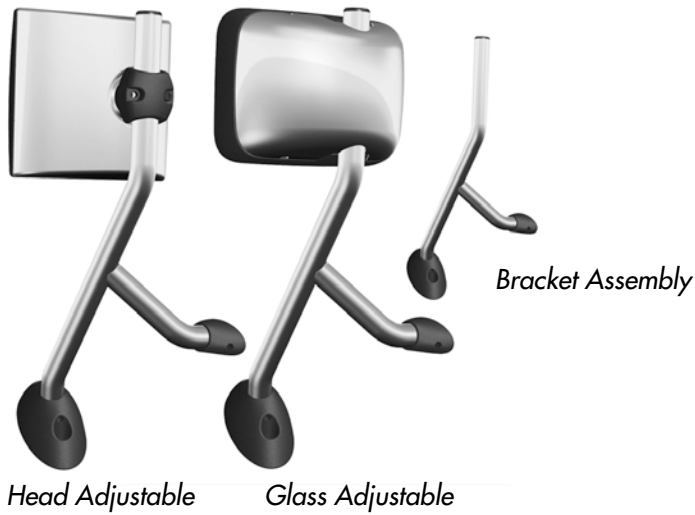

#### Vehicle:

WorkStar 7300, 7400, 7500, 7600, 7700, Hybrid (2002-Present)

- Fits 1 1/8" tube

#### Head Adjustable

- Convex head size:  
7 1/4" w x 7 1/4" h x 3" d

#### Glass Adjustable

- Convex head size:  
8 7/8" w x 6 5/8" h x 4 1/2" d

#### Accessories

- **Head Clamp & Screw Kit**

Model 405 | Part # **V624059999**  
(OEM 2507274C1)

#### Fender Bracket Assembly No head provided

Model	Left Bracket #	Right Bracket #	Color	Material	Heat
404	V584049301	V584049302	Stainless	Stainless	-
404	V584049311	V584049312	Black	Steel	-

#### Convex Glass Head Head adjustable

Model	Part #	O.E.M.	Glass Size	Side	Color	M/R	Heat	Light
388	V563882208	2507272C1	6 3/4" w x 6 3/4" h	Both	Chrome	Manual	-	-
409	V564090013	-	6 3/4" w x 6 3/4" h	Both	Black	Manual	-	-

#### Convex Glass Head Glass adjustable

Model	Part #	Glass Size	Side	Color	M/R	Heat	Light
428	V564281013 <sup>1</sup>	7 3/4" w x 5 3/4" h	Both	Chrome	Manual	-	-
428	V564281001	7 3/4" w x 5 3/4" h	Both	Black	Manual	-	-

#### Convex Glass Kit

Model	Part #	O.E.M.	Glass Size	Side	Color	M/R	Heat
388	V153882120	2507273C1	6 3/4" w x 6 3/4" h	Both	Black	Manual	-
428	V154280001	-	7 3/4" w x 5 3/4" h	Both	Black	Manual	-
428	V614280008 <sup>2</sup>	-	7 3/4" w x 5 3/4" h	Both	Black	Manual	-

#### Convex Mirror Cover

Model	Part #	Side	Color	Light
428	V134281015	Both	Chrome	-
428	V134281011	Both	Black	-

#### NOTES

**M/R** Manual / remote

\*Vertical bracket on Bracket Assembly is 2 1/16" longer (taller) than OEM standard bracket, in order to accommodate either Head Adjustable or Glass Adjustable mirror options

<sup>1</sup> Chrome backcover with chrome housing

<sup>2</sup> Includes housing



Call the Velvac Sales Team: **800.783.8871** sales@velvac.com

© VELVAC INC. • 2405 South Calhoun Road • New Berlin, WI 53151-2709 • Toll Free: 800.783.8871 • Fax: 262.786.4101

## INTERNATIONAL

Various | **Look Down Mirrors**



**Vehicle:**

Various (2001-2005)

**Bracket Mount**

**Convex Head Size**

11<sup>3</sup>/<sub>16</sub>"w x 6<sup>7</sup>/<sub>8</sub>"h x 2<sup>7</sup>/<sub>16</sub>"d

**Bracket Hole Location**

**Width Between Holes:**

3<sup>15</sup>/<sub>16</sub>"

**Hole Size:**

1<sup>1</sup>/<sub>64</sub>"

**NOTES**

**M/R** Manual / remote

<sup>1</sup> Furnished with black arm, chrome back cover, black bezel and black holder

<sup>2</sup> Furnished with black arm, black back cover, black bezel and black holder

<sup>3</sup> Includes bezel kit

**Convex Look Down Mirror**

Model	Part #	O.E.M.	Glass Size	Side	Color	M/R	Heat	Light
360	V593605228 <sup>1</sup>	3571502C2	10 <sup>5</sup> / <sub>8</sub> "w x 6 <sup>1</sup> / <sub>4</sub> "h	Right	Chrome	Manual	-	-
360	V593601152 <sup>2</sup>	3571501C1	10 <sup>5</sup> / <sub>8</sub> "w x 6 <sup>1</sup> / <sub>4</sub> "h	Right	Black	Manual	-	-

**Convex Glass Kit**

Model	Part #	O.E.M.	Glass Size	Side	Color	M/R	Heat
360	V613600001 <sup>3</sup>	2585911C1 2585911C2	10 <sup>5</sup> / <sub>8</sub> "w x 6 <sup>1</sup> / <sub>4</sub> "h	Both	Black	Manual	-

## KENWORTH

T680, T880 | **481 System**



**Vehicle:**

T680, T880 (2012-Present)

**Pedestal Mount**

**Head Size**

9"w x 21<sup>3</sup>/<sub>8</sub>"h

**NOTES**

Bracket, head and glass not available. Contact OE to purchase.

**Flat Mirror Actuator**

Model	Part #	O.E.M.	Side
480	V084803997	84803997	Both

**NOTE: Part numbers listed in RED are NEW!**

# MIRRORS

## KOVATCH MOBILE EQUIPMENT (KME)

**407 System** | Eliminator, Dryside Tanker. Heavy Duty Rescue. Challenger, Legacy, Rearmount Pumper. TDA, Midmount, Rearmount Ladder/Platform. Predator, Severe Service, Panther and Legacy

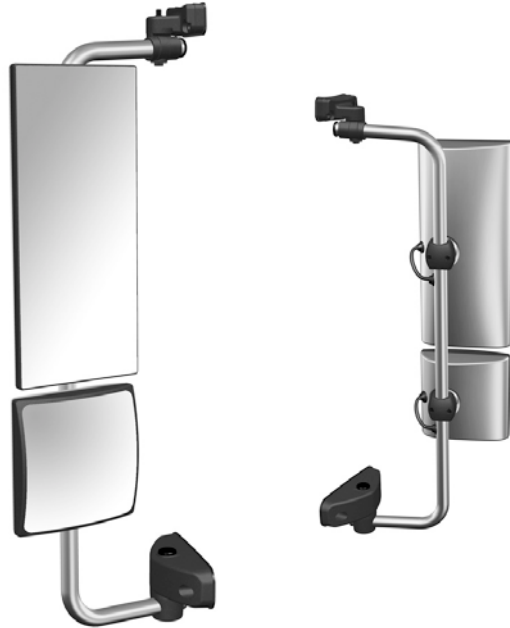

### Vehicle:

Eliminator, Dryside Tanker. Heavy Duty Rescue. Challenger, Legacy, Rearmount Pumper. TDA, Midmount, Rearmount Ladder/Platform. Predator, Severe Service, Panther and Legacy (2003-Present)

- Fits 1- 1 1/8" tube

### Flat Head Size

7 5/16" w x 16 3/8" h x 4 5/8" d

### Convex Head Size

7 1/4" w x 7 1/4" h x 5 1/8" d

### NOTES

**M/R** Manual / remote

<sup>1</sup> Furnished less electrical harness. Contact Velvac for specific part numbers and availability

- For Airport RIV, Commercial Chassis, Wetside, Elliptical, Wildland Interface, Ridgerunner, Specialty, and Medium Duty Rescue, consult specific vehicle make/model section of this catalog.

### Side Mount Bracket

Model	Part #	Dimension "A"	Dimension "B"	Side	Color	Material
407	V584070300 <sup>1</sup>	28 3/16"	7 6/34"	Both	Stainless	Stainless

- Dimension A: Distance between upper and lower bracket holder mounting holes
- Dimension B: Distance between the outside edge of the mirror bracket and the mounting surface

### Flat Glass Housing

Head adjustable. Order glass to make complete head

Model	Part #	Glass Size	Side	Color	M/R	Heat	Light
409	V514090029	6 3/4" w x 15 7/8" h	Right	Chrome	Remote	•	-
409	V514090028	6 3/4" w x 15 7/8" h	Left	Chrome	Remote	•	-

### Flat Glass Kit

Model	Part #	O.E.M.	Glass Size	Side	Color	M/R	Heat
383	V153832107	054627V007	6 3/4" w x 15 7/8" h	Both	Black	Both	•



Call the Velvac Sales Team: **800.783.8871** sales@velvac.com

© VELVAC INC. • 2405 South Calhoun Road • New Berlin, WI 53151-2709 • Toll Free: 800.783.8871 • Fax: 262.786.4101

## KOVATCH MOBILE EQUIPMENT (KME)

**407 System**  
Continued

### Convex Glass Head Head adjustable

Model	Part #	O.E.M.	Glass Size	Side	Color	M/R	Heat	Light
409	V564090025	K564090025	6¾"w x 6¾"h	Both	Chrome	Manual	•	-

### Convex Glass Kit

Model	Part #	O.E.M.	Glass Size	Side	Color	M/R	Heat
388	V153882117	054627V004	6¾"w x 6¾"h	Both	Black	Manual	•

### Flat Mirror Actuators

Model	Part #	Side
409	V084090002	Right
409	V084090001	Left

### Accessories

- **Mirror Head Clamp**  
Model 387 | Part # V113870510B  
(OEM 005881V177)
- **Head Clamp & Screws Kit**  
Model 405 | Part # V624059999
- **Wire Harness Kit**  
Model 387 | Part # V613871998
- **2-Mirror Switch**  
Part # V083200233  
(OEM 005881V178)

**NOTE: Part numbers listed in RED are NEW!**

# MIRRORS

## KOVATCH MOBILE EQUIPMENT (KME)

**407 System** | Eliminator, Dryside Tanker. Heavy Duty Rescue. Challenger, Legacy, Rearmount Pumper. TDA, Midmount, Rearmount Ladder/Platform. Predator, Severe Service, Panther and Legacy



### Vehicle:

Eliminator, Dryside Tanker. Heavy Duty Rescue. Challenger, Legacy, Rearmount Pumper. TDA, Midmount, Rearmount Ladder/Platform. Predator, Severe Service, Panther and Legacy (2003-Present)

- Fits 1- 1 1/8" tube

### Head Size

8 1/16" w x 15 1/16" h x 5 1/4" d

### NOTES

**M/R** Manual / remote

<sup>1</sup> Furnished less electrical harness. Contact Velvac for specific part numbers and availability

<sup>2</sup> Chrome backcover with chrome housing

- For Airport RIV, Commercial Chassis, Wetside, Elliptical, Wildland Interface, Ridgerunner, Specialty, and Medium Duty Rescue, consult specific vehicle make/model section of this catalog.

### Side Mount Bracket

Model	Part #	Dimension "A"	Dimension "B"	Side	Color	Material
407	V584070300 <sup>1</sup>	28 13/16"	7 63/64"	Both	Stainless	Stainless

- Dimension A: Distance between upper and lower bracket holder mounting holes
- Dimension B: Distance between the outside edge of the mirror bracket and the mounting surface

### Flat Glass Head Glass adjustable

Model	Part #	Glass Size	Side	Color	M/R	Heat	Light
427	V514270018 <sup>2</sup>	7 1/4" w x 14 1/4" h	Right	Chrome	Remote	•	•
427	V514270017 <sup>2</sup>	7 1/4" w x 14 1/4" h	Left	Chrome	Remote	•	•
427	V514270016 <sup>2</sup>	7 1/4" w x 14 1/4" h	Right	Chrome	Remote	•	-
427	V514270015 <sup>2</sup>	7 1/4" w x 14 1/4" h	Left	Chrome	Remote	•	-

### Flat Glass Kit

Model	Part #	O.E.M.	Glass Size	Side	Color	M/R	Heat
427	V154270011	005881V191 005881V231	7 1/4" w x 14 1/4" h	Both	Black	Both	•



Call the Velvac Sales Team: **800.783.8871** [sales@velvac.com](mailto:sales@velvac.com)

© VELVAC INC. • 2405 South Calhoun Road • New Berlin, WI 53151-2709 • Toll Free: 800.783.8871 • Fax: 262.786.4101

## KOVATCH MOBILE EQUIPMENT (KME)

**407 System**  
Continued

### Mirror Cover

Model	Part #	Side	Color	Light
427	V134271008	Both	Chrome	-
427	V134271009 <sup>3</sup>	Both	Chrome	•
427	V614271007 <sup>3,4</sup>	Both	Chrome	•

### Accessories

- **Marker Light Kit w/ Bezel**  
Model 427 | Part # V114272001
- **Head Clamp & Screws Kit**  
Model 400 | Part # V614000010
- **2-Mirror Switch**  
Part # V083200233  
(OEM 005881V178)

### Convex Glass Head Glass adjustable

Model	Part #	Glass Size	Side	Color	M/R	Heat	Light
428	V564281014 <sup>2</sup>	7¾"w x 5¾"h	Both	Chrome	Manual	•	-
428	V564281015 <sup>2,5</sup>	7¾"w x 5¾"h	Both	Chrome	Manual	•	-

### Convex Glass Kit

Model	Part #	O.E.M.	Glass Size	Side	Color	M/R	Heat
428	V154280002	-	7¾"w x 5¾"h	Both	Black	Manual	•
428	V154280003 <sup>5</sup>	005881V167	7¾"w x 5¾"h	Both	Black	Manual	•

### Convex Mirror Cover

Model	Part #	Side	Color	Light
428	V134281015	Both	Chrome	-

### Flat Mirror Actuator

Model	Part #	Side
427	V084270006	Both

### NOTES

- <sup>2</sup> Chrome backcover with chrome housing  
<sup>3</sup> Furnished with punched holes  
<sup>4</sup> Kit furnished with marker light  
<sup>5</sup> Furnished with turn signal

**NOTE: Part numbers listed in RED are NEW!**



# MIRRORS

## PETERBILT

480 System | 567, 579



### Vehicle:

567, 579 (2012-Present)

### Pedestal Mount Head Size

9 $\frac{3}{8}$ "w x 22 $\frac{5}{8}$ "h

### NOTES

Bracket, head and glass not available.  
Contact OE to purchase.

### Flat Mirror Actuator

Model	Part #	O.E.M.	Side
480	V084803997	84803997	Both



Call the Velvac Sales Team: **800.783.8871** [sales@velvac.com](mailto:sales@velvac.com)

© VELVAC INC. • 2405 South Calhoun Road • New Berlin, WI 53151-2709 • Toll Free: 800.783.8871 • Fax: 262.786.4101

## PIERCE MANUFACTURING

PUC Ariels, Pumpers, Rescues. Arrow XT™, Impel™, Quantum®, Saber®, Velocity®  
| **407 System**



### Vehicle:

PUC Ariels, Pumpers, Rescues.  
Arrow XT™, Impel™, Quantum®,  
Saber®, Velocity® (2003-Present)

- Fits 1- 1 1/8" tube

### Flat Head Size

7 5/16" w x 16 3/8" h x 4 5/8" d

### Convex Head Size

7 1/4" w x 7 1/4" h x 5 1/8" d

### NOTES

**M/R** Manual / remote

<sup>1</sup> Furnished less electrical harness. Contact Velvac for specific part numbers and availability

- For Commercial Pumpers, Tankers and Rescues, consult specific vehicle make/model section of this catalog

### Side Mount Bracket

Model	Part #	Dimension "A"	Dimension "B"	Side	Color	Material
407	V584070100 <sup>1</sup>	26 1/2"	9 27/32"	Both	Stainless	Stainless

- Dimension A: Distance between upper and lower bracket holder mounting holes
- Dimension B: Distance between the outside edge of the mirror bracket and the mounting surface

### Flat Glass Housing Head adjustable. Order glass to make complete head

Model	Part #	O.E.M.	Glass Size	Side	Color	M/R	Heat	Light
409	V514090029	1443302	6 3/4" w x 15 7/8" h	Right	Chrome	Remote	•	-
409	V514090028	1964877	6 3/4" w x 15 7/8" h	Left	Chrome	Remote	•	-

### Flat Glass Kit

Model	Part #	O.E.M.	Glass Size	Side	Color	M/R	Heat
383	V153832107	A2254882002	6 3/4" w x 15 7/8" h	Both	Black	Both	•

**NOTE: Part numbers listed in RED are NEW!**

## PIERCE MANUFACTURING

### 407 System

Continued

#### Convex Glass Head Head adjustable

Model	Part #	Glass Size	Side	Color	M/R	Heat	Light
409	V564090025	6¾"w x 6¾"h	Both	Chrome	Manual	•	•

#### Convex Glass Kit

Model	Part #	O.E.M.	Glass Size	Side	Color	M/R	Heat
388	V153882117	2122881	6¾"w x 6¾"h	Both	Black	Manual	•

#### Flat Mirror Actuators

Model	Part #	Side
409	V084090002	Right
409	V084090001	Left

#### Accessories

- **Mirror Head Clamp**  
Model 387 | Part # V113870510B
- **Head Clamp & Screws Kit**  
Model 405 | Part # V624059999
- **Wire Harness Kit**  
Model 387 | Part # V613871998
- **2-Mirror Switch**  
Part # V084022051



Call the Velvac Sales Team: **800.783.8871** [sales@velvac.com](mailto:sales@velvac.com)

## PIERCE MANUFACTURING

PUC Ariels, Pumpers, Rescues. Arrow XT™, Impel™, Quantum®, Saber®, Velocity®  
| **407 System**



### Vehicle:

PUC Ariels, Pumpers, Rescues.  
Arrow XT™, Impel™, Quantum®,  
Saber®, Velocity® (2003-Present)

- Fits 1- 1 1/8" tube

### Head Size

8 1/6" w x 15 1/6" h x 5 1/4" d

### NOTES

**M/R** Manual / remote

<sup>1</sup> Furnished less electrical harness. Contact Velvac for specific part numbers and availability

<sup>2</sup> Chrome backcover with chrome housing

- For Commercial Pumpers, Tankers and Rescues, consult specific vehicle make/model section of this catalog

### Side Mount Bracket

Model	Part #	Dimension "A"	Dimension "B"	Side	Color	Material
407	V584070100 <sup>1</sup>	26 1/2"	9 27/32"	Both	Stainless	Stainless

- Dimension A: Distance between upper and lower bracket holder mounting holes
- Dimension B: Distance between the outside edge of the mirror bracket and the mounting surface

### Flat Glass Head Glass adjustable

Model	Part #	Glass Size	Side	Color	M/R	Heat	Light
427	V514270018 <sup>2</sup>	7 1/4" w x 14 1/4" h	Right	Chrome	Remote	•	•
427	V514270017 <sup>2</sup>	7 1/4" w x 14 1/4" h	Left	Chrome	Remote	•	•
427	V514270016 <sup>2</sup>	7 1/4" w x 14 1/4" h	Right	Chrome	Remote	•	-
427	V514270015 <sup>2</sup>	7 1/4" w x 14 1/4" h	Left	Chrome	Remote	•	-

### Flat Glass Kit

Model	Part #	Glass Size	Side	Color	M/R	Heat
427	V154270011	7 1/4" w x 14 1/4" h	Both	Black	Both	•

**NOTE: Part numbers listed in RED are NEW!**

## PIERCE MANUFACTURING

### 407 System

Continued

#### Mirror Cover

Model	Part #	Side	Color	Light
427	V134271008	Both	Chrome	-
427	V134271009 <sup>3</sup>	Both	Chrome	•
427	V614271007 <sup>3,4</sup>	Both	Chrome	•

#### Convex Glass Head *Glass adjustable*

Model	Part #	Glass Size	Side	Color	M/R	Heat	Light
428	V564281014 <sup>2</sup>	7¾" w x 5¾" h	Both	Chrome	Manual	•	-

#### Convex Glass Kit

Model	Part #	Glass Size	Side	Color	M/R	Heat
428	V154280002	7¾" w x 5¾" h	Both	Black	Manual	•

#### Convex Mirror Cover

Model	Part #	Side	Color	Light
428	V134281015	Both	Chrome	-

#### Flat Mirror Actuator

Model	Part #	Side
427	V084270006	Both

#### Accessories

- **Marker Light Kit w/ Bezel**  
Model 427 | Part # V114272001
- **Head Clamp & Screws Kit**  
Model 400 | Part # V614000010
- **2-Mirror Switch**  
Part # V084022051  
(OEM 634860)

#### NOTES

- <sup>2</sup> Chrome backcover with chrome housing  
<sup>3</sup> Furnished with punched holes  
<sup>4</sup> Kit furnished with marker light



Call the Velvac Sales Team: **800.783.8871** sales@velvac.com

© VELVAC INC. • 2405 South Calhoun Road • New Berlin, WI 53151-2709 • Toll Free: 800.783.8871 • Fax: 262.786.4101

Marauder II, Attacker HD | **407 System**



### Vehicle:

Marauder II, Attacker HD  
(2004-Present)

- Fits 1-1 $\frac{1}{8}$ " tube

### Flat Head Size

7 $\frac{5}{16}$ "w x 16 $\frac{3}{8}$ "h x 4 $\frac{5}{8}$ "d

### Convex Head Size

7 $\frac{1}{4}$ "w x 7 $\frac{1}{4}$ "h x 5 $\frac{1}{8}$ "d

### NOTES

<sup>1</sup> Furnished less electrical harness. Contact Velvac for specific part numbers and availability

**M/R** Manual / remote

- For Commercial Optimum Series, consult specific vehicle make/model section of this catalog.

### Side Mount Bracket

Model	Part #	O.E.M.	Dimension "A"	Dimension "B"	Side	Color	Material
407	V584070100 <sup>1</sup>	S584070100	26 $\frac{1}{2}$ "	9 $\frac{27}{32}$ "	Both	Stainless	Stainless
407	V584070310 <sup>1</sup>	P3207000	31 $\frac{3}{4}$ "	7 $\frac{57}{64}$ "	Both	Stainless	Stainless
407	V584070320 <sup>1</sup>	S584070320	32 $\frac{2}{32}$ "	8 $\frac{7}{16}$ "	Both	Stainless	Stainless

- Dimension A: Distance between upper and lower bracket holder mounting holes
- Dimension B: Distance between the outside edge of the mirror bracket and the mounting surface

### Flat Glass Housing Head adjustable. Order glass to make complete head

Model	Part #	O.E.M.	Glass Size	Side	Color	M/R	Heat	Light
409	V514090029	P3206800	6 $\frac{3}{4}$ "w x 15 $\frac{7}{8}$ "h	Right	Chrome	Remote	•	-
409	V514090028	P3206700	6 $\frac{3}{4}$ "w x 15 $\frac{7}{8}$ "h	Left	Chrome	Remote	•	-

### Flat Glass Kit

Model	Part #	O.E.M.	Glass Size	Side	Color	M/R	Heat
383	V153832107	P1680051 P2178761	6 $\frac{3}{4}$ "w x 15 $\frac{7}{8}$ "h	Both	Black	Both	•

**NOTE: Part numbers listed in RED are NEW!**



## SEAGRAVE

### 407 System

Continued

#### Convex Glass Head Head adjustable

Model	Part #	O.E.M.	Glass Size	Side	Color	M/R	Heat	Light
409	V564090025	P3207100	6¾"w x 6¾"h	Both	Chrome	Manual	•	-

#### Convex Glass Kit

Model	Part #	O.E.M.	Glass Size	Side	Color	M/R	Heat
388	V153882117	P1680052 S153882117	6¾"w x 6¾"h	Both	Black	Manual	•

#### Flat Mirror Actuator

Model	Part #	O.E.M.	Side
409	V084090002	P2316501	Right
409	V084090001	-	Left

#### Accessories

- **Mirror Head Clamp**  
Model 387 | Part # V113870510B  
(OEM P3206600)
- **Head Clamp & Screws Kit**  
Model 405 | Part # V624059999
- **Wire Harness Kit**  
Model 387 | Part # V613871998
- **2-Mirror Switch**  
Part # V083200233  
(OEM P2005000)



Call the Velvac Sales Team: **800.783.8871** sales@velvac.com

© VELVAC INC. • 2405 South Calhoun Road • New Berlin, WI 53151-2709 • Toll Free: 800.783.8871 • Fax: 262.786.4101

Marauder II, Attacker HD | **407 System**



### Vehicle:

Marauder II, Attacker HD  
(2004-Present)

- Fits 1-1/8" tube

### Head Size

8 1/16" w x 15 1/16" h x 5 1/4" d

### NOTES

**M/R** Manual / remote

<sup>1</sup> Furnished with wiring harness for flat remote, flat/convex heat, marker light and turn signal

<sup>2</sup> Furnished less electrical harness. Contact Velvac for specific part numbers and availability

<sup>3</sup> Chrome backcover with chrome housing

<sup>4</sup> For use with bracket assembly V584070502

<sup>5</sup> For use with bracket assembly V584070310

- For Commercial Optimum Series, consult specific vehicle make/model section of this catalog.

### Side Mount Bracket

Model	Part #	O.E.M.	Dimension "A"	Dimension "B"	Side	Color	Material
407	V584070500 <sup>1</sup>	-	31 3/4"	8 7/16"	Both	Stainless	Stainless
407	V584070310 <sup>2</sup>	P3207000	31 3/4"	7 5/16"	Both	Stainless	Stainless

- Dimension A: Distance between upper and lower bracket holder mounting holes
- Dimension B: Distance between the outside edge of the mirror bracket and the mounting surface

### Flat Glass Head Glass adjustable

Model	Part #	Glass Size	Side	Color	M/R	Heat	Light
427	V514270018 <sup>3,4</sup>	7 1/4" w x 14 1/4" h	Right	Chrome	Remote	•	•
427	V514270017 <sup>3,4</sup>	7 1/4" w x 14 1/4" h	Left	Chrome	Remote	•	•
427	V514270016 <sup>3,5</sup>	7 1/4" w x 14 1/4" h	Right	Chrome	Remote	•	-
427	V514270015 <sup>3,5</sup>	7 1/4" w x 14 1/4" h	Left	Chrome	Remote	•	-

### Flat Glass Kit

Model	Part #	Glass Size	Side	Color	M/R	Heat
427	V154270011	7 1/4" w x 14 1/4" h	Both	Black	Both	•

**NOTE: Part numbers listed in RED are NEW!**

## SEAGRAVE

### 407 System

Continued

#### Mirror Cover

Model	Part #	Side	Color	Light
427	V134271009 <sup>6</sup>	Both	Chrome	•
427	V614271007 <sup>6,7</sup>	Both	Chrome	•
427	V134271008	Both	Chrome	-

#### Convex Glass Head *Glass adjustable*

Model	Part #	Glass Size	Side	Color	M/R	Heat	Light
428	V564281015 <sup>8,9</sup>	7¾"w x 5¾"h	Both	Chrome	Manual	•	-
428	V564281014 <sup>3,5</sup>	7¾"w x 5¾"h	Both	Chrome	Manual	•	-

#### Convex Glass Kit

Model	Part #	Glass Size	Side	Color	M/R	Heat
428	V154280003 <sup>8</sup>	7¾"w x 5¾"h	Both	Black	Manual	•
428	V154280002	7¾"w x 5¾"h	Both	Black	Manual	•

#### Convex Mirror Cover

Model	Part #	Side	Color	Light
428	V134281015	Both	Chrome	-

#### Flat Mirror Actuator

Model	Part #	Side
427	V084270006	Both

#### Accessories

- **Marker Light Kit w/ Bezel**  
Model 427 | Part # V114272001
- **Head Clamp & Screws Kit**  
Model 400 | Part # V614000010
- **2-Mirror Switch**  
Part # V083200233  
(OEM 2005000)

#### NOTES

- <sup>3</sup> Chrome backcover with chrome housing
- <sup>5</sup> For use with bracket assembly V584070310
- <sup>6</sup> Furnished with punched holes
- <sup>7</sup> Kit furnished with marker light
- <sup>8</sup> Furnished with turn signal
- <sup>9</sup> For use with bracket assembly V584070502



Call the Velvac Sales Team: **800.783.8871** sales@velvac.com

© VELVAC INC. • 2405 South Calhoun Road • New Berlin, WI 53151-2709 • Toll Free: 800.783.8871 • Fax: 262.786.4101

## SPARTAN CHASSIS

Gladiator®, Metro Star®, Metro Star® -X, Metro Star® - RT | **407 System**



### Vehicle:

Gladiator®, Metro Star®, Metro Star® -X, Metro Star® - RT  
(2004-Present)

- Fits 1- 1 1/8" tube

### Head Size

8 1/16" w x 15 1/16" h x 5 1/4" d

### NOTES

**M/R** Manual / remote

<sup>1</sup> Furnished with wiring harness for flat remote, flat/convex heat, marker light and turn signal

<sup>2</sup> Furnished less electrical harness. Contact Velvac for specific part numbers and availability

<sup>3</sup> Chrome backcover with chrome housing

<sup>4</sup> For use with bracket assembly V584070502

<sup>5</sup> For use with bracket assembly V584070310

<sup>6</sup> For use with bracket assembly V584070312

### Side Mount Bracket

Model	Part #	O.E.M.	Dimension "A"	Dimension "B"	Side	Color	Material
407	V584070500 <sup>1</sup>	-	31 3/4"	8 7/16"	Both	Stainless	Stainless
407	V584070310 <sup>2</sup>	P3207000	31 3/4"	7 57/64"	Both	Stainless	Stainless
407	V584070312 <sup>2</sup>	-	31 3/4"	7 57/64"	Both	Black	Steel

- Dimension A: Distance between upper and lower bracket holder mounting holes
- Dimension B: Distance between the outside edge of the mirror bracket and the mounting surface

### Flat Glass Head Glass adjustable

Model	Part #	Glass Size	Side	Color	M/R	Heat	Light
427	V514270018 <sup>3,4</sup>	7 1/4" w x 14 1/4" h	Right	Chrome	Remote	•	•
427	V514270017 <sup>3,4</sup>	7 1/4" w x 14 1/4" h	Left	Chrome	Remote	•	•
427	V514270016 <sup>3,5</sup>	7 1/4" w x 14 1/4" h	Right	Chrome	Remote	•	-
427	V514270015 <sup>3,5</sup>	7 1/4" w x 14 1/4" h	Left	Chrome	Remote	•	-
427	V514270122 <sup>6</sup>	7 1/4" w x 14 1/4" h	Right	Black	Remote	•	-
427	V514270121 <sup>6</sup>	7 1/4" w x 14 1/4" h	Left	Black	Remote	•	-

**NOTE: Part numbers listed in RED are NEW!**

## SPARTAN CHASSIS

### 407 System

Continued

#### Flat Glass Kit

Model	Part #	Glass Size	Side	Color	M/R	Heat
427	V154270011	7¼"w x 14¼"h	Both	Black	Both	•
427	V614270004 <sup>7</sup>	7¼"w x 14¼"h	Right	Black	Both	•
427	V614270005 <sup>7</sup>	7¼"w x 14¼"h	Left	Black	Both	•

#### Mirror Cover

Model	Part #	Side	Color	Light
427	V134271009 <sup>10</sup>	Both	Chrome	•
427	V614271007 <sup>8, 10</sup>	Both	Chrome	•
427	V134271008	Both	Chrome	-
427	V134271000	Both	Black	-

#### Accessories

- **Marker Light Kit w/ Bezel**  
Model 427 | Part # V114272001
- **Head Clamp & Screws Kit**  
Model 400 | Part # V614000010
- **2-Mirror Switch**  
Part # V083200233  
(OEM 0497RR8001)

#### Convex Glass Head Glass adjustable

Model	Part #	Glass Size	Side	Color	M/R	Heat	Light
428	V564281015 <sup>4, 9</sup>	7¾"w x 5¾"h	Both	Chrome	Manual	•	-
428	V564281014 <sup>3, 5</sup>	7¾"w x 5¾"h	Both	Chrome	Manual	•	-
428	V564281002 <sup>6</sup>	7¾"w x 5¾"h	Both	Black	Manual	•	-

#### Convex Glass Kit

Model	Part #	Glass Size	Side	Color	M/R	Heat
428	V154280003 <sup>9</sup>	7¾"w x 5¾"h	Both	Black	Manual	•
428	V154280002	7¾"w x 5¾"h	Both	Black	Manual	•

#### Convex Mirror Cover

Model	Part #	Side	Color	Light
428	V134281015	Both	Chrome	-
428	V134281011	Both	Black	-

#### NOTES

- <sup>3</sup> Chrome backcover with chrome housing
- <sup>4</sup> For use with bracket assembly V584070502
- <sup>5</sup> For use with bracket assembly V584070310
- <sup>6</sup> For use with bracket assembly V584070312
- <sup>7</sup> Flat glass kit with housing
- <sup>8</sup> Kit furnished with marker light
- <sup>9</sup> Furnished with turn signal
- <sup>10</sup> Furnished with punched holes

#### Flat Mirror Actuator

Model	Part #	Side
427	V084270006	Both



Call the Velvac Sales Team: **800.783.8871** sales@velvac.com

© VELVAC INC. • 2405 South Calhoun Road • New Berlin, WI 53151-2709 • Toll Free: 800.783.8871 • Fax: 262.786.4101

### Sprinter Vans | Straight Van Chassis Applications



**Vehicle:**

Sprinter Vans

- Kits include mirror head, bracket and stainless steel mounting hardware
- Assemblies include an 8½" K-10 Eyeball convex mirror

Kit #	Color
716902	Stainless bracket w/ black 10" ABS

### Sprinter Vans | Van and Cab Chassis Mirrors



**Vehicle:**

Sprinter Vans

- Powder coated loop and cast mounting ends fit directly into older OE mounting base (not included)
- Includes 6½" x 10" upper flat glass head and 6½" x 6" lower convex
- For use up to 86" wide body applications

Part #	Description	Color
715704	Complete pair	Black

**NOTE: Part numbers listed in RED are NEW!**



# MIRRORS

## SUTPHEN

**407 System** | Aerial Platforms, Aerial Ladders, Pumpers, Specialty, Wildland, Industrial



### Vehicle:

Aerial Platforms - SP70, SP95, SPH100, Remount. Aerial Ladders - SA75, SA100. Pumpers - Guardian, Monarch, Shield. Specialty - Heavy Rescue. Wildland - Type I. Industrial - SA|110, SP|112, Pumper (2004-Present)

- Fits 1- 1 1/8" tube

### Head Size

8 1/6" w x 15 1/6" h x 5 1/4" d

### NOTES

**M/R** Manual / remote

<sup>1</sup> Furnished less electrical harness. Contact Velvac for specific part numbers and availability

<sup>2</sup> Chrome backcover with chrome housing

- For Commercial Pumpers and Elliptical or Wetside Tankers, consult the specific vehicle make/model section of this catalog

### Side Mount Bracket w/ Modified Lower Holder

Model	Part #	Dimension "A"	Dimension "B"	Side	Color	Material
407	V584071300 <sup>1</sup>	28 1/6"	7 63/64"	Both	Stainless	Stainless

- Dimension A: Distance between upper and lower bracket holder mounting holes
- Dimension B: Distance between the outside edge of the mirror bracket and the mounting surface

### Flat Glass Head *Glass adjustable*

Model	Part #	O.E.M.	Glass Size	Side	Color	M/R	Heat	Light
427	V514270018 <sup>2</sup>	-	7 1/4" w x 14 1/4" h	Right	Chrome	Remote	•	•
427	V514270017 <sup>2</sup>	-	7 1/4" w x 14 1/4" h	Left	Chrome	Remote	•	•
427	V514270016 <sup>2</sup>	HC21Q23QX	7 1/4" w x 14 1/4" h	Right	Chrome	Remote	•	-
427	V514270015 <sup>2</sup>	-	7 1/4" w x 14 1/4" h	Left	Chrome	Remote	•	-
427	V514270019 <sup>2</sup>	-	7 1/4" w x 14 1/4" h	Both	Chrome	Manual	-	-



Call the Velvac Sales Team: **800.783.8871** sales@velvac.com

© VELVAC INC. • 2405 South Calhoun Road • New Berlin, WI 53151-2709 • Toll Free: 800.783.8871 • Fax: 262.786.4101

#### Flat Glass Kit

Model	Part #	Glass Size	Side	Color	M/R	Heat
427	V154270011	7¼"w x 14¼"h	Both	Black	Both	•
427	V154270010	7¼"w x 14¼"h	Both	Black	Both	-

#### Mirror Cover

Model	Part #	Side	Color	Light
427	V134271009 <sup>3</sup>	Both	Chrome	•
427	V134271008	Both	Chrome	-
427	V614271007 <sup>3,4</sup>	Both	Chrome	•

#### Accessories

- **Marker Light Kit w/ Bezel**  
Model 427 | Part # V114272001
- **Head Clamp & Screws Kit**  
Model 400 | Part # V614000010

#### Convex Glass Head Glass adjustable

Model	Part #	Glass Size	Side	Color	M/R	Heat	Light
428	V564281013 <sup>2</sup>	7¾"w x 5¾"h	Both	Chrome	Manual	-	-
428	V564281015 <sup>2,5</sup>	7¾"w x 5¾"h	Both	Chrome	Manual	•	-

#### Convex Glass Kit

Model	Part #	Glass Size	Side	Color	M/R	Heat
428	V154280001	7¾"w x 5¾"h	Both	Black	Manual	-
428	V614280008 <sup>6</sup>	7¾"w x 5¾"h	Both	Black	Manual	-
428	V154280003 <sup>5</sup>	7¾"w x 5¾"h	Both	Black	Manual	•

#### Convex Mirror Cover

Model	Part #	Side	Color	Light
428	V134281015	Both	Chrome	-

#### NOTES

- M/R** Manual / remote  
<sup>2</sup> Chrome backcover with chrome housing  
<sup>3</sup> Furnished with punched holes  
<sup>4</sup> Kit furnished with marker light  
<sup>5</sup> Furnished with turn signal  
<sup>6</sup> Includes housing

#### Flat Mirror Actuator

Model	Part #	Side
427	V084270006	Both

**NOTE: Part numbers listed in RED are NEW!**

## USPS

### United States Post Office Mirrors



- All USPS mirrors are manufactured to USPS OE requirements and are USPS White

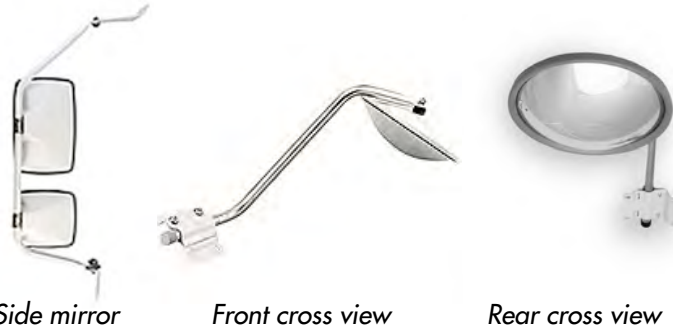

### Mirror and Bracket Kits

Part #	Body Type	Application	Dimension
712896	LLV	Right side	6½"w x 10"h
712897	LLV	Left side	6½"w x 10"h
712898	LLV	Front cross view	-
712900	LLV	Rear cross view	-
714782	CRV	Right side	6½"w x 10"h
714783	CRV	Left side	6½"w x 10"h
714784	CRV	Front cross view	-
714785	CRV	Rear cross view	-
714146	Ford Aerostar	Rear cross view	-
714147	Ford Windstar	Rear cross view	-
715786	Dodge Caravan	Rear cross view	-

### Replacement Main Head

Part #	Body Type	Application	Dimension
704122	LLV	Both side mirrors	6½"w x 10"h
704122	CRV	Both side mirrors	6½"w x 10"h

### Replacement Convex Head

Part #	Body Type	Application	Dimension
704120	LLV	Both side mirrors	6½"w x 6"h
723103	LLV	Front cross view	8" Diameter
709226	LLV	Rear cross view	10" Diameter
704120	CRV	Both side mirrors	6½"w x 6"h
723103	CRV	Front cross view	8" Diameter
709226	CRV	Rear cross view	10" Diameter
708463	Ford Aerostar	Rear cross view	8½" Diameter
708463	Ford Windstar	Rear cross view	8½" Diameter
708463	Dodge Caravan	Rear cross view	8½" Diameter



Call the Velvac Sales Team: **800.783.8871** [sales@velvac.com](mailto:sales@velvac.com)

**VOLVO**

Various | **360 System**



**Vehicle:**

Various (2003-2005)

**Bracket Mount  
Convex Head Size**

11<sup>3</sup>/<sub>16</sub>"w x 6<sup>7</sup>/<sub>8</sub>"h x 2<sup>7</sup>/<sub>16</sub>"d

**Bracket Hole Location  
Width Between Holes:**

3<sup>15</sup>/<sub>16</sub>"

**Hole Size:**

1<sup>1</sup>/<sub>64</sub>"

**Look Down Mirror** Furnished with black flip-out arm

Model	Part #	O.E.M.	Glass Size	Side	Color	M/R	Heat	Light
360	V593603121	3980815	10 <sup>5</sup> / <sub>8</sub> "x 6 <sup>5</sup> / <sub>8</sub> "	Right	Black	Manual	-	-

**VOLVO**

VNL, VNM | **372 System**



**Vehicle:**

VNL, VNM (1998-2005)

- Fits 20 mm tube

**Head Size**

9<sup>7</sup>/<sub>8</sub>"w x 26<sup>3</sup>/<sub>16</sub>"h x 4<sup>5</sup>/<sub>8</sub>"h

**Accessories**

- **Back Cover Plug Kit**  
Model 372 | Part # V613724110  
(OEM 3092008)
- **RAMI CB Insulator Kit**  
Model 387 | Part # V613871900

**Flat or Convex Mirror Actuator**

Model	Part #	O.E.M.	Side
372	V613720112	613720112	Both

**NOTES**

Bracket, head and glass not available.  
Contact OE to purchase.

**NOTE: Part numbers listed in RED are NEW!**

# MIRRORS

## VOLVO

### 412 System | Various



#### Vehicle:

Various (2005-Present)

#### Bracket Mount

#### Convex Head Size

11<sup>1</sup>/<sub>16</sub>"w x 6<sup>3</sup>/<sub>4</sub>"h x 2<sup>5</sup>/<sub>8</sub>"d

#### Bracket Hole Location

#### Width Between Holes:

3<sup>15</sup>/<sub>16</sub>" or 2<sup>3</sup>/<sub>4</sub>"

#### Hole Size:

1<sup>1</sup>/<sub>64</sub>"

**Look Down Mirror** *Furnished with fold-out arm*

Model	Part #	O.E.M.	Glass Size	Side	Color	M/R	Heat	Light
412	V594121171	20701698	10 <sup>3</sup> / <sub>4</sub> " x 6 <sup>1</sup> / <sub>4</sub> "	Right	Black	Manual	-	-

## VOLVO

### 472 System | VNM630, VNL 430, VNL 630, VNL 670, VNL 730, VNL 780, VNX 300, VNM200, VNM430



#### Vehicle:

VNM200, VNM430, VNM630, VNL 430, VNL 630, VNL 670, VNL 730, VNL 780, VNX 300 (2008-September 2011)

- Fits 1<sup>1</sup>/<sub>4</sub>" tube

#### Head Size

9<sup>7</sup>/<sub>8</sub>"w x 25<sup>3</sup>/<sub>8</sub>"h x 6<sup>5</sup>/<sub>8</sub>"h

#### Accessories

- **Standard CB Kit**

Model 472 | Part # **V614720004**  
(OEM 85108734)

- **Premium CB Kit**

Model 472 | Part # **V614720005**  
(OEM 85108735)

- **RAMI CB Insulator Kit**

Model 387 | Part # **V613871900**

#### Flat Mirror Actuator

Model	Part #	O.E.M.	Side
472	V614720001	85108732	Both

#### NOTES

Bracket, head and glass not available.  
Contact OE to purchase.



Call the Velvac Sales Team: **800.783.8871** [sales@velvac.com](mailto:sales@velvac.com)

© VELVAC INC. • 2405 South Calhoun Road • New Berlin, WI 53151-2709 • Toll Free: 800.783.8871 • Fax: 262.786.4101

VNM200, VNM430, VNM630, VNL 430, VNL 630, VNL 670, VNL 730, VNL 780, VNX 300  
| **473 System**



### Flat Mirror Actuator

Model	Part #	O.E.M.	Side
473	V614730023	85133991	Both

### Vehicle:

VNM200, VNM430, VNM630, VNL 430, VNL 630, VNL 670, VNL 730, VNL 780, VNX 300 (September 2011-Present)

- Fits 1 1/4" tube

### Head Size

9 7/8" w x 25 3/8" h x 6 5/8" h

### Accessories

- **Standard CB Kit**  
Model 472 | Part # V614720004 (OEM 85108734)
- **Premium CB Kit**  
Model 472 | Part # V614720005 (OEM 85108735)
- **RAMI CB Insulator Kit**  
Model 387 | Part # V613871900

### NOTES

Bracket, head and glass not available. Contact OE to purchase.

## WESTERN STAR

4900EX, 4900SB | **401 System**



### Flat Mirror Actuators

Model	Part #	Side
384	V083841400	Right
384	V083841300	Left

### Vehicle:

4900EX, 4900SB (2002-Present)

- Fits 1 1/8" tube

### Head Size

9 1/16" w x 23 5/8" h x 5 3/8" h

### Accessories

- **Marker Light Assembly - Amber**  
Model 401 | Part # V084010001 (OEM MEK084010001)
- **Marker Light Bezel**  
Model 414 | Part # V084142400
- **RAMI CB Insulator Kit**  
Model 387 | Part # V613871900 (OEM MEK613871900)

### NOTES

Bracket, head and glass not available. Contact OE to purchase.

**NOTE: Part numbers listed in RED are NEW!**



# MIRRORS

## 2020 MIRROR REPLACEMENT PARTS

### 2020 and 2020XG Mirror Replacement Parts



2020  
Standard  
head



2020  
Deluxe  
head



2020XG  
Mirror

Mirror Heads					GM Topkick - Kodiak		Ford & GM Van	
	2020 Deluxe Head		2020 Standard Head		2020XG Mirror			
	Right Side	Left Side	Right Side	Left Side	Right Side	Left Side	Right Side	Left Side
White manual	-	-	714576	714576	-	-	715988	715987
White H/R flat, manual convex	714590	714589	714578	714578	-	-	715992	715991
White H/R w/ lower marker lamp	-	-	-	-	-	-	716506	716507
Black manual	714580	714579	714575	714575	715986	715985	715986	715985
Black H/R flat, manual convex	714582	714581	714577	714577	716012	716011	715990	715989
Black H/R w/ lower marker lamp	-	-	-	-	-	-	716504	716505
Black H/R w/ signal arrow	716974	716973	-	-	-	-	716498	716499
Chrome H/R flat	714608	714607	-	-	-	-	715988	715997
Chrome H/R w/ lower marker lamp	-	-	-	-	-	-	716508	716509
Chrome H/R w/ signal arrow	716434	716433	-	-	-	-	716502	716503
Black 2015 replacement head <sup>3</sup>	-	-	714256	714256	-	-	-	-
White 2015 replacement head <sup>3</sup>	-	-	714258	714258	-	-	-	-
<b>Glass Kits</b>								
Manual flat glass <sup>1</sup>	-	-	709407	709407	-	-	-	-
Htd flat, manual and htd glass	709448	709448	709748	709748	716104	716103	716104	716103
Heated flat with signal arrow	709674	709673	-	-	709994	709995	709994	709995
Htd convex, manual and htd glass	709449	709449	-	-	709932	709931	716106	716105
Convex repair kit <sup>2</sup>	709589	709589	-	-	-	-	-	-
Wedge stick on convex	-	-	723068	723068	-	-	-	-
Flat glass retaining clip	-	-	-	-	709422	709422	709422	709422
Convex glass retaining clip	-	-	-	-	709855	709855	709855	709855

#### NOTES

**H/R** Heated remote

<sup>1</sup> Includes bezel and wedge convex

<sup>2</sup> Includes glass, inner housing, clip and actuator

<sup>3</sup> Model 2015 replacement head only; same head used for either side



Call the Velvac Sales Team: **800.783.8871** sales@velvac.com

© VELVAC INC. • 2405 South Calhoun Road • New Berlin, WI 53151-2709 • Toll Free: 800.783.8871 • Fax: 262.786.4101

## 2020 MIRROR REPLACEMENT PARTS

### 2020XG System for GM Cut w/ 8D8 Option Replacement Mirror Heads

**Vehicle:**

GM Cutaway Van Mirrors

Model	Left Side #	Right Side #	Color	Head	Flat Glass	Convex Glass	Options
2020XG	716011	716012	Black	Deluxe	Heat / Remote	Heat / Manual	-
2020XG	716521	716522	Black	Deluxe	Heat / Remote	Heat / Manual	Light
2020XG	716515	716516	Black	Deluxe	Heat / Remote	Heat / Manual	Signal
2020XG	716055	716056	Chrome	Deluxe	Heat / Remote	Heat / Manual	-
2020XG	716525	716526	Chrome	Deluxe	Heat / Remote	Heat / Manual	Light
2020XG	716519	716520	Chrome	Deluxe	Heat / Remote	Heat / Manual	Signal

### 2020 and 2020XG Mirror Replacement Accessories

**2020 Accessories**

- **Switch Kit Ford E Van**  
Model 2020 | Part # 747524
- **Switch Kit GM G Van and C 3500**  
Model 2020 | Part # 747632
- **Switch Kit Ford F Superduty 650-750**  
Model 2020 | Part # 747633
- **12' HR Wire Harness Pass Door to Driver Door**  
Model 2020 | Part # 748304
- **Marker Light Below Elbow**  
Model 2020 | Part # 747551
- **Cover Plate Kit for GMC Topkick**  
Model 2020 | Part # 709785  
(includes plate, gasket and hardware)

**Model 2020XG & 2020SS Accessories**

- **Switch Kit Ford E Van**  
Model 2020XG | Part # 747588
- **Switch Kit GM G Van and C 3500**  
Model 2020XG | Part # 747856
- **Switch Kit Ford F Superduty 650-750**  
Model 2020XG | Part # 747901
- **12' HR Wire Harness Pass Door to Driver Door**  
Model 2020XG | Part # 747863
- **Marker Light**  
Model 2020XG | Part # 709993

**2020XG & 2020SS Accessories**

- **Black 96" Arm Cover Kit\***  
Model 2020XG | Part # 716107
- **Black 102" Arm Cover Kit\***  
Model 2020XG | Part # 716113
- **Black 96" Arm Cover Kit\***  
Model 2020XG | Part # 716109
- **Black 102" Arm Cover Kit\***  
Model 2020XG | Part # 716115

\*Kit is for a pair, includes hardware



Arm covers



Light

Harness

Switch kit

**NOTE: Part numbers listed in RED are NEW!**

# MIRRORS

## BRACKETS, CLAMPS AND ACCESSORIES



### Clamp and Tubing Arm Kits for 6", 8" and 8½" Mirror Heads

- Ideal for adding an auxiliary spot mirror to existing loop or brace
- For ¾" O.D. tubing
- Plastic coated clamp for secure grip and damage resistance
- Overall length 6"

Part #	Description
723057	Stainless steel
748269	UPS brown powder coated galvanized steel



### Clamp and Tubing Arm Kit for 5" and 6" Plastic Mirror Heads

- Stainless steel formed tube arm
- Zinc plated steel clamp
- Ideal for adding an auxiliary spot mirror to existing loop or brace
- For ⅝" and ¾" O.D. tubing
- Overall length 5⅞"

Part #	Description
723049	Stainless steel tubing



### 6" Pivot Bolt Mounting Bracket

- Ideal for adding an auxiliary spot mirror below a west coast mirror head
- Stainless steel construction
- Overall length 4⅞"

Part #	Description
723055	For ⅝" and ¾" pivot bolts

### "L" Style Mounting Bracket



- Sturdy ⅛", 11 gauge construction
- Pivot hole accepts ⅝" and ¾" bolts
- Slotted hole provides additional mirror head adjustment
- Ideal for mounting Velvac DuraBall® convex and all other convex mirrors

Part #	Description
723100	Stainless steel

Replaces Velvac Part No. 723080

### Bracket Mount Mirror



- Attaches easily to west coast mirror bracket on any truck
- All stainless steel construction

Part #	Description
712648	Two arm bracket

Bracket and hardware ONLY - mirror head sold separately

### Adjustable Tubing Arms



- Universal adjustable support
- 10½" long threaded led with extension adjustment from 19" to 25"
- Threaded leg can be cut to reduce minimum overall length
- Available in stainless steel and powder-coated galvanized steel finishes

Part #	Description
747070	Stainless steel
747072	Black

### Fender Mount Extension Bracket



- Adjustable from 13½" to 17½"
- Bell mount base provides extra support
- Stainless steel construction
- Mounting hardware included

Part #	Description
723047	Fender mntd extension bracket

Bracket and hardware ONLY - mirror head sold separately

### Sleeve and Nut Kit



- For conventional and step van brace and adjustable bracket assemblies
- Brass sleeve and chrome nut

Part #	Description
748215	Sleeve and nut kit

### The Stabilizer Heavy-Duty Convex L-Bracket



- Unique two piece L-bracket developed in conjunction with major truck OEs
- Rigid stabilizer bracket improves image stability in convex spot mirror by reducing vibration
- Individually packaged

Part #	Description
723115	Stabilizer L-bracket



Call the Velvac Sales Team: **800.783.8871** sales@velvac.com

© VELVAC INC. • 2405 South Calhoun Road • New Berlin, WI 53151-2709 • Toll Free: 800.783.8871 • Fax: 262.786.4101

## BRACKETS, CLAMPS AND ACCESSORIES

### Nylon Clamp Kit for 3/4" O.D. Tubing



- Non-corrosive black nylon clamp
- Recessed fasteners provide a custom look
- Kit includes clamp and hardware

Part #	Description
748416	Clamp kit - Includes clamp and hardware for 3/4" O.D. tubing



### Tubing Brace Clamp Kit for 3/4" O.D. Tubing

- Used to support tubing arms on loop assemblies; not used for installing mirror heads
- Kit includes stainless steel clamp and mounting hardware

Part #	Description
748029	Tubing brace clamp kit for 3/4" O.D. tubing

### Flat Clamp Kit for 3/4" O.D. Tubing



- Used to mount West Coast mirror heads to 3/4" O.D. tubing - mounts on horizontal leg of loop
- Plastic coating for secure grip and damage resistance
- Kit includes stainless steel clamp and mounting hardware

Part #	Description
704066	Flat clamp kit for 3/4" O.D. tubing

### Clamp Kit for 1" O.D. Tubing



- Used to mount side and stud mount mirror heads to 1" O.D. tubing
- Plastic coating for secure grip and damage resistance
- Kit includes stainless steel clamp and mounting bolt

Part #	Description
704070	Clamp kit for 1" O.D. tubing

### Clamp Kit for 3/4" O.D. Tubing



- Used to mount side and stud mount mirror heads to 3/4" O.D. tubing
- Plastic coating for secure grip and mar resistance
- Kit includes stainless steel clamp and mounting bolt

Part #	Description
704068	Clamp kit for 3/4" O.D. tubing

### Clamp Kit for 5/8" O.D. Tubing



- Used to mount side and center mount mirror heads to 5/8" O.D. tubing
- Kit includes two-piece aluminum clamp and stainless steel mounting hardware

Part #	Description
704069	Clamp kit for 5/8" O.D. tubing

### Standard Mounting Cabfeet Kits

- Used on non-preset style loops
- Heavy-duty 90° bracket permits a variety of mounting applications
- Cabfeet mounting holes are 2" on center
- Available in stainless steel and powder coated galvanized steel finishes
- Kits include cabfeet and hardware to mount one pair of mirrors



Part #	Description
757015	Stainless steel
757016	White

### Twist Clamp Kit for 3/4" O.D. Tubing



- Used to mount West Coast mirror heads to 3/4" O.D. tubing - mounts on vertical leg of loop
- Plastic coating for secure grip and damage resistance
- Kit includes stainless steel clamp and mounting hardware

Part #	Description
704065	Twist clamp kit for 3/4" O.D. tubing



## BRACKETS, CLAMPS AND ACCESSORIES



### Non-Preset Pivot Kit

- Replacement kit for mirrors with Velvac non-preset pivot end and Velvac mirrors with standard pivot
- 5/16" - 18 x 1" stainless steel bolt
- Kit contains parts for one complete non-preset pivot end

Part #	Description
748012	Non-preset pivot kit



### Rubber Preset Pivot Kit

- Replacement kit for mirrors with Velvac rubber preset pivots and Velvac mirrors with rubber washer style preset
- 5/16" - 18 x 1 1/2" stainless steel bolt
- Kit contains parts for one complete preset pivot end

Part #	Description
748009	Rubber preset pivot kit

### Switch Kit for Heated Mirrors



- Dash mounted kit controls one to two heated mirror heads

Part #	Description
747053	Switch kit for heated mirror

### Clamp, Brace & Bracket Kit

- Ideal for adding auxiliary spot mirrors to existing loop or brace



### Spring Preset Pivot Kit

- Replacement kit for mirrors with standard Velvac spring preset systems and UPS walk-in vans with Velvac mirrors
- Use to upgrade mirrors with rubber washer preset to a spring preset for improved pivot action
- Stainless steel rivet plate extends life of loop and improves pivot action on mirrors with worn preset rivets
- 5/16" - 18 x 2" stainless steel bolt
- Kit contains parts for one complete spring preset pivot end

Part #	Description
712979	Spring preset pivot kit



### Preset Rivet Plate

- Designed for use on all Velvac preset loops except those with tension control stop preset as found in kit Part No. 748371
- Two stainless steel rivet plates extend life of loop and improve pivot action on mirrors with worn preset rivets
- Mounts easily between existing mirror loop and preset lock plate

Part #	Description
748377	Preset rivet plate kit



Part #	Description
723091	Clamp, tubing arm & L bracket



### Heavy-Duty Preset and Pivot Upgrade Kit

- Designed for use on all Velvac preset loops except those with tension control stop preset as found in kit Part No. 748371
- Improves pivot holding force on mirrors with large loops or large / heavy mirror head combinations
- Unique spring / washer combination retains pivot system torque to keep mirror in set viewing position until moved and provides superior detent action for foldaway applications
- Life cycle tested to over 50,000 pivot cycles
- Preset rivet plate fits over existing preset rivets to extend life of loop and improve cycle performance
- Easy retrofit - can be completed without taking mirror assembly off the vehicle
- 5/16" - 18 x 1 3/4" stainless steel pivot bolt and 5/16" - 18 x 2" stainless steel preset bolt
- Kit contains all upper and lower pivot hardware for one mirror assembly

Part #	Description
748355	Heavy-duty preset and pivot upgrade kit

\*Order one Part No. 748355 per side

#### Helpful hint:

Kit can be used to upgrade mirror loops with standard rubber or spring preset systems (similar to Part No. 748009 or 712979 detailed on this page)

Call the Velvac Sales Team: **800.783.8871** sales@velvac.com

**OUR PARTS PUT YOU IN THE PASSING LANE**

# VISION SYSTEMS

## The future is here.

Velvac has developed some of the most sophisticated vision systems in the industry. With the addition of both Road-iQ and 5th Wheel Dual Camera system to our line-up, you'll find that we're at the forefront in ensuring safety for drivers.

- Aero Cam
- Road-iQ
- 5th Wheel Dual Camera



Includes:





# VISION SYSTEMS

## CAMERA SYSTEMS

- Velvac offers a variety of camera systems and kits to increase safety and convenience
- Below camera placement can also be for straight trucks, RVs, buses and speciality vehicles

### Helpful hint:

Be mindful of the connection type. The connectors are one of two types: A and B, shown to the right. All pieces must be compatible or will require the use of an adaptor



4-pin  
'A' Connection



5-pin  
'B' Connection



Road-iQ  
System  
Page V14



Front View  
Camera  
Page V5



Interior  
Camera  
Page V5



Back-Up  
Camera  
Page V3

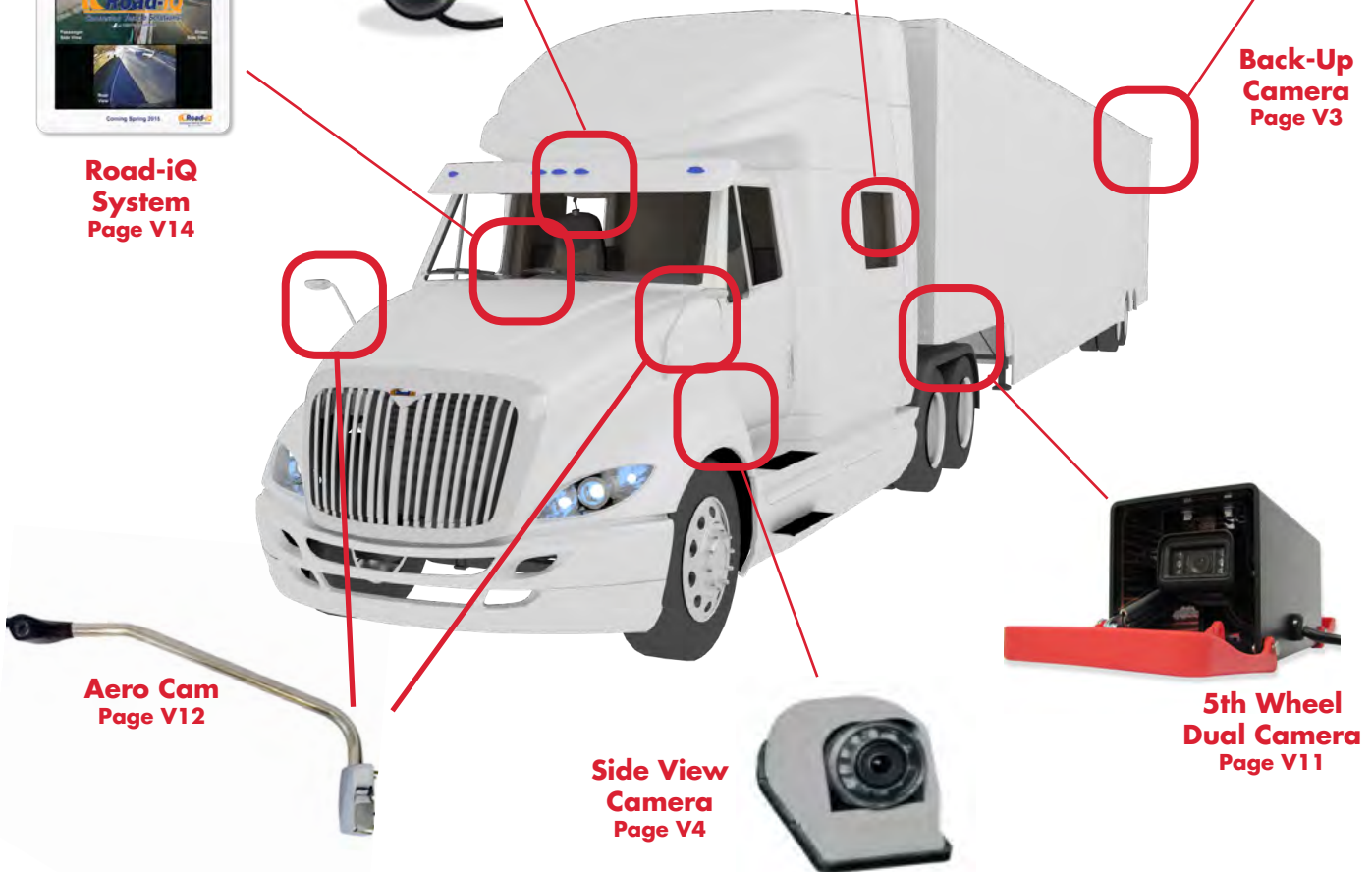

Aero Cam  
Page V12

Side View  
Camera  
Page V4

5th Wheel  
Dual Camera  
Page V11



Call the Velvac Sales Team: **800.783.8871** [sales@velvac.com](mailto:sales@velvac.com)

© VELVAC INC. • 2405 South Calhoun Road • New Berlin, WI 53151-2709 • Toll Free: 800.783.8871 • Fax: 262.786.4101

## CAMERAS

### Rear View Cameras

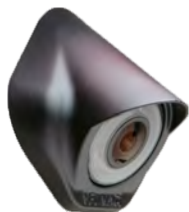

717973



710615

### Flush Mount Rear View Camera

Part #	FOV	Connector	IP Rating	Power
717973	120° H, 90° V	B	IP69K	12 VDC
710615	120° H, 90° V	A	IP69K	12 VDC

- Velvac offers a variety of rear view cameras including the exclusive flush mount back-up camera and adjustable back-up style



709912



710011



710523



710326

### Adjustable Rear View Camera

Part #	Housing	FOV	Connector	IP Rating	Power
709912	White	120° H, 90° V	A	IPX7	12 VDC
710523	Black	112° H, 80° V	A	IP69K	12 VDC
710011	Black	93° H, 70° V	A	IPX7	12 VDC
710326	Black	80° H, 60° V	B	IP69K	12 VDC

- Integrated flush mount provides clean appearance with no exposed wires or hardware
- Camera angle is preset to provide the optimum visibility with no needed adjustments
- LED low light enhancement
- CMOS technology reduces blooming
- Includes durable backing plate, gasket and mounting hardware

#### NOTES

- CMOS** Complimentary metal oxide semiconductor
- CCD** Charged couple device
- Blooming** Glare due to sunlight, headlight conditions, etc.

#### 709912, 710011, 710523

- Built-in microphone for enhanced safety with audio output (through the monitor) while backing up (710011, 710523)
- Waterproof housing
- LED low light enhancement
- CCD image technology (710523 uses CMOS technology)
- Aluminum bracket and stainless steel mounting hardware included

#### 710326

- LED low light enhancement
- CMOS technology reduces blooming
- Mounting bracket and hardware included

**NOTE: Part numbers listed in RED are NEW!**

## CAMERAS

### Side View Cameras

- Velvac offers both traditional mount side view cameras and hood mount Aero Cams, as well as side view CMOS cameras integrated into the Velvac 2020 Mini-LEM and V-MAX and V-MAX III LEM mirror systems (see page M37)



### Fixed Side Mount Cameras

- High resolution color
- Waterproof housing
- Cylindrical 3/4" through hole mount
- LED low light enhancement
- CMOS technology reduces blooming

Part #	Side	Housing	FOV	Connector	IP Rating	Power
709941	Left	Gray primer	95° H, 75° V	A	IPX7	12 VDC
709942	Right	Gray primer	95° H, 75° V	A	IPX7	12 VDC
709949	Left	Chrome	95° H, 75° V	A	IPX7	12 VDC
709948	Right	Chrome	95° H, 75° V	A	IPX7	12 VDC



### Aero Cams

- Blind spot elimination for trucks
- LED low light enhancement
- CMOS technology reduces blooming
- Aero Cam kit includes right and left side Aero Cams, cables and hardware

Pair #	Vehicle Model	FOV	Connector	IP Rating	Power
717971	Volvo VNL	81° H, 61° V	B	IP69K	12 VDC
717901	Volvo VNM	81° H, 61° V	B	IP69K	12 VDC
717878	Kenworth T700	81° H, 61° V	B	IP69K	12 VDC
717897	All other PACCAR vehicles	81° H, 61° V	B	IP69K	12 VDC
717953	Freightliner Cascadia	81° H, 61° V	B	IP69K	12 VDC

#### NOTES

For complete Aero Cam kits with monitors see page V12 - V13



Call the Velvac Sales Team: **800.783.8871** sales@velvac.com

## CAMERAS



### Rear & Side View Cameras

- Sleek design protects camera from dirt and contamination
- LED low light enhancement
- CMOS technology reduces blooming
- Mounting bracket and hardware included

Part #	FOV	Connector	IP Rating	Power
710325	80° H, 60° V	B	IP69K	12 VDC



### Front Facing Cameras

- High resolution color
- Waterproof housing
- Mounts on top or bottom of windshield
- CMOS technology reduces blooming

Part #	FOV	Connector	IP Rating	Power
717871	120° H, 90° V	B	IP69K	12 VDC



### Interior Cameras

- High resolution color
- LED low light enhancement
- CCD image technology
- Mounting hardware included

Part #	FOV	Connector	IP Rating	Power
710589	120° H, 90° V	B	N/A	12 VDC

#### NOTES

**CMOS** Complimentary metal oxide semiconductor

**CCD** Charged couple device

**NOTE: Part numbers listed in RED are NEW!**

## MONITORS

- Velvac's color 5.6" and 7" LCD monitors are designed for heavy duty and commercial truck applications - built and tested to withstand extreme road conditions such as vibrations, electrostatic discharge, humidity and temperature changes and to deliver high quality images to the driver
- 5.6" and 7" monitors include audio speaker with volume
- 5" monitor has full camera views
- 7" monitor has 8 different view modes; view 1 to 4 cameras at a time
- Velvac's 3.5" color monitor in a rear view mirror provides the ultimate in safety and convenience. The image is invisible while in drive and only activates when the camera trigger is engaged



709915



709916



709953



716314

### NOTES

<sup>1</sup> Requires the addition of mounting brackets shown on page V7

<sup>2</sup> Includes multi-image view modes: split screen (2-way), tri-view (3-way), and quad view (4-way); all other monitors have single screen viewing



710323



710324

Part #	Screen	Camera Inputs	Triggers	Mounting	Connector	Power
709915 <sup>1</sup>	5.6" Color LCD	2	2	4-hole amps pattern	A	12VDC
709916 <sup>1</sup>	7" Color LCD	3	3	4-hole amps pattern	A	12VDC
709953 <sup>1</sup>	7" Color LCD, Multi <sup>2</sup>	4	4 + 1 split	4-hole amps pattern	A	12VDC
716314	3.5" Color LCD	3	3	Universal windshield	A	12VDC
710323	5" Color LCD	3	3	Bracket included	B	12VDC
710324	7" Color LCD	4	4 + 1 split	Bracket included	B	12VDC

### Three Camera Controller

- Allows 716314 camera input monitor to be converted to accept (3) cameras simultaneously
- This controller allows different views to automatically engage based on triggers for left / right turn signals or reverse
- This flexible control box can be wired for full time viewing of the rear camera if needed



Part #	Description	Connector
716318	Three camera controller	A



Call the Velvac Sales Team: **800.783.8871** [sales@velvac.com](mailto:sales@velvac.com)



## MONITOR MOUNTS

Part #	Description
790563	4" Single knuckle monitor mount (4-hole amps pattern) bracket with thumbscrew
790564	6" Double knuckle monitor mount (4-hole amps pattern) bracket with thumbscrew
790576	Double knuckle monitor mount for 1" ball (4-hole amps pattern)
790605	Double knuckle monitor mount (T slot)



790563



790564



790576



790605

## CABLES

- Cables can be connected together to create various lengths
- Cable quantity and length will vary based on number of cameras and distance from camera to monitor
- Tractor to trailer camera cable kit includes all necessary straight and coiled cables to connect truck monitor to back up camera on top of trailer – the coiled cable is designed to safely span area between tractor and trailer

Part #	Description	Connector
747850	15' Camera to monitor cable	A
745243	15' Camera to monitor cable	B
747864	25' Camera to monitor cable	A
745244	25' Camera to monitor cable	B
747865	34' Camera to monitor cable	A
745245	35' Camera to monitor cable	B
747866	50' Camera to monitor cable	A
747867	75' Camera to monitor cable	A
745142	Camera splitter / Y-cable	B
745137	12" DVR adapter cable, B male / BNC	B
745138	12" DVR to camera cable	B
745252	Tractor to trailer camera cable kit*	B

\*Kit includes coiled cable assembly with plug connectors, mating sockets for truck and tractor, 33' of camera cable for routing to truck monitor and 65' of camera cable for routing to back of trailer / back up camera



'A' connector cable



'B' connector cable



Tractor to trailer camera cable

### Adaptor

- Use adaptor to connect A cameras to the B monitors (page V6)

Part #	Description	Connector
747894	Adaptor	A ---> B

**NOTE: Part numbers listed in RED are NEW!**



## CAMERA KITS

### Back-Up Camera Kits

- Velvac has assembled several back-up camera kits for convenience
- Contact Velvac for custom needs

Kit Part #	Camera	Monitor	Monitor Mount	Cables Included	Total Cable Length
709921	709912	709915	790563	1 - 34'	34'
709954	709912	709916	790563	1 - 34'	34'
719592	710325	710323	-	1 - 34'	34'
719593	710325	710323	-	2 - 25'	50'
719594	710325	710323	-	2 - 34'	68'
719595	710325	710324	-	1 - 34'	34'
719596	710325	710324	-	2 - 25'	50'
719597	710325	710324	-	2 - 34'	68'
719598	710326	710323	-	1 - 34'	34'
719599	710326	710323	-	2 - 25'	50'
719600	710326	710323	-	2 - 34'	68'
719601	710326	710324	-	1 - 34'	34'
719602	710326	710324	-	2 - 25'	50'
719603	710326	710324	-	2 - 34'	68'
719612*	710326	-	-	2 - 25'	50'

\*For use with PACCAR SmartNav and NavPlus systems



709912 Camera



710325 Camera



709915 Monitor



710323 Monitor



710326 Camera



790563 Monitor mount



709916 Monitor



710324 Monitor



Call the Velvac Sales Team: **800.783.8871** [sales@velvac.com](mailto:sales@velvac.com)

**Helpful hint:**

DVRs are compatible with B connector cameras and monitors. Build your own kit by selecting DVR, cable, and options such as memory and accessories

- DVRs are built specifically for the high vibration environments of commercial vehicles
- Durable, extruded aluminum chassis is compact and lightweight, and can be mounted in almost any position
- Hard drive resides in gel-coated isolation chassis to protect from vibration
- Shell designed to dissipate heat
- Quiet, clean, fanless design
- Integral heating coil automatically cycles on for short periods in extremely low temperatures
- Interfaces with vehicle J1939 network to pull critical performance data (e.g. fuel economy, idle time, etc.)
- Dual streaming Wi-Fi and 3G/4G capabilities
- Integrates seamlessly with Velvac's advanced vision systems, such as the Aero Cam system

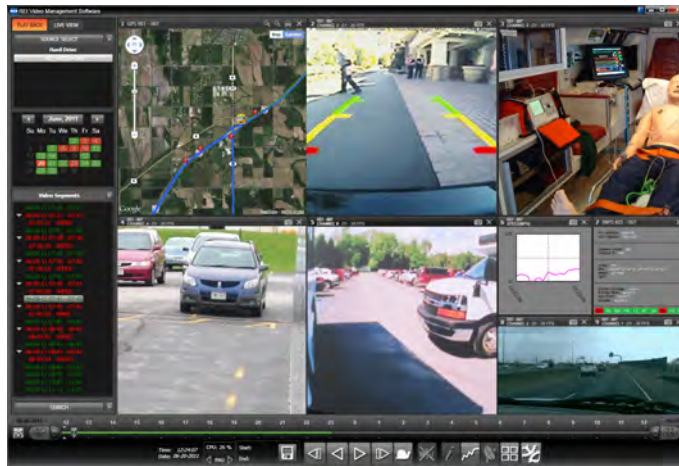

**DVR Kits**

Part #	Description
717770	SD40 DVR kit, w/ cable for 2 cameras
717771	HD420 DVR kit, w/ cable for 2 cameras
717772	HD800 DVR kit, w/ cable for 2 cameras
717773	SD40 DVR kit, w/ cable for 3 cameras
717774	HD420 DVR kit, w/ cable for 3 cameras
717775	HD800 DVR kit, w/ cable for 3 cameras
717776	SD40 DVR kit, w/ cable for 4 cameras
717777	HD420 DVR kit, w/ cable for 4 cameras
717778	HD800 DVR kit, w/ cable for 4 cameras

**DVR Only**

Part #	Description
710359	SD40 DVR, 4-channel
710360	HD420 DVR, 4-channel



SD40



HD420



HD800

**NOTE: Part numbers listed in RED are NEW!**

## DVR SYSTEMS

### DVR Power Cable

Part #	Description
710395	SD40 DVR, 4-chan
710396	HD420 DVR, 4-chan
710397	HD800 DVR, 8-chan
745139	SD DVR power cable, 16'
745140	HD DVR power cable, 16'

### DVR Memory

Part #	Description
710394	32GB SD card for HD series
710384	32GB SD card for SD40
710385	320GB hard drive
710386	500GB hard drive

### DVR Accessories

Part #	Description
710387	Accelerometer, for HD DVR's, 36" long
710388	Accelerometer, for SD DVR's, 36" long
710389	GPS antenna, for DVR's
710390	Wireless bridge kit
710391	Wire harness, J1939 for HD DVR's
710392	DVR cable, 8 sensor trigger wire 20'
710393	Event / alarm switch, w/ 20' cable

### SD40 DVR

- Connect up to 4 cameras - 60 fps at D1 resolution
- Lockable SD card slot utilizes professional grade 32GB SD card

### HD420 DVR

- Connect up to 4 cameras - 60 fps at D1 resolution
- Integral hard drive dampening
- Removable hard drive module with USB port
- USB auto download
- GPS compatible
- SD card backup for saving triggered events

### HD800 DVR

- Connect up to 8 cameras - 240 fps at D1 resolution
- Integral hard drive dampening
- Removable hard drive module with USB port
- USB auto download
- GPS compatible
- SD card backup for saving triggered events



**J1939 Network**  
Provides critical engine info: idle time, fuel economy, miles traveled, etc.



**GPS antenna**  
Provides route and speed information on the fleet



**Wireless bridge**  
Automatically download video once the vehicle enters the lot



Call the Velvac Sales Team: **800.783.8871** sales@velvac.com

## 5TH WHEEL DUAL CAMERA SYSTEM



The 5th Wheel Dual Camera System allows drivers to properly line up the king pin and fifth wheel, making coupling easier and preventing costly damage to the tractor or trailer

- Doors open automatically when vehicle is placed in reverse
- Dual cross hair cameras provide the driver with a clear view of king pin and fifth wheel alignment
- Heavy duty aluminum housing and reinforced molded doors help protect cameras from rain, snow and debris
- Integrated heating system allows for cold weather operation
- IR camera assists backing in low or no light conditions
- Mounting brackets are designed to fit a wide variety of vehicle applications
- Kits include dual camera, cables, hardware and installation information



### 5th Wheel Dual Camera Kit

Part #	Monitor	Mounting Bracket	Vehicle
710640	•	-	All
710640-1	•	•	All
710640-3	•	•	Kenworth
710640-4	•	•	Kenworth*
710651	-	-	All
710651-1	-	•	All
710651-3	-	•	Kenworth

### Service Parts

Part #	Description
710641	Camera enclosure
745241	Wire harness
710649	Control module
710324	7" Monitor
351108**	Mounting bracket
351109	Mounting bracket (Kenworth only)
745245	34' Camera cable

- Velvac offers kits with two different mounting brackets for easy installation
- Kenworth brackets are for use on Kenworth trucks only
- Universal bracket fits all other vehicle applications except for Paccar trucks\*\*

### NOTES

- \* Compatible with Kenworth drop wire option package 8700919
- \*\* Contact Velvac for information on Paccar mounting brackets

**NOTE: Part numbers listed in RED are NEW!**



# VISION SYSTEMS

## AERO CAM VISION SYSTEM

### Aero Cam Vision System

- Blind spot elimination system for heavy duty trucks
- The Velvac Aero Cam is a camera-based vision system that provides the driver with clear views of blind spots and passing lanes around the vehicle, resulting in improved safety and reduced potential for costly and dangerous accidents
- According to National Highway Transportation Safety Administration (NHTSA), depth perception and object recognition are the keys to safe vehicle operation. With an optimal 65° viewing angle, CMOS vision processor and camera positioned above the splash zone, the Aero Cam system clearly displays the most critical vision targets, allowing the driver to make faster and safer driving decisions. With its smaller profile in relation to conventional convex mirrors, the Aero Cam is also designed to reduce drag, resulting in improved vehicle aerodynamics, a major contributor to improving fuel economy and reducing fuel consumption



**Aero Cam Optimized  
65° Horizontal FOV**

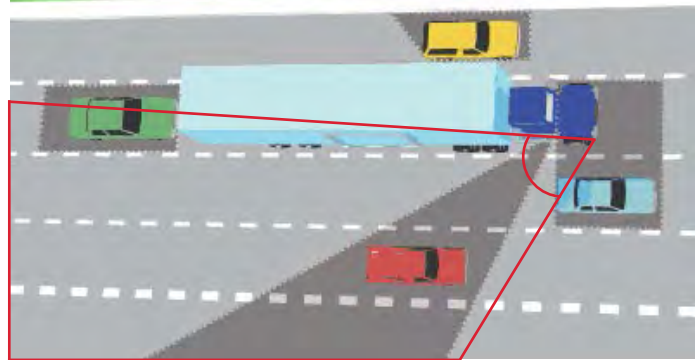

Custom kits for PACCAR and Volvo vehicles are designed for specific hood geometry and wire routing



1" OD stainless steel tubing arm can be rotated for fine camera angle adjustment. Also rotates upon impact to reduce the potential damage



Available with right side and left side dedicated dash mounted monitors as shown above



Call the Velvac Sales Team: **800.783.8871** [sales@velvac.com](mailto:sales@velvac.com)

© VELVAC INC. • 2405 South Calhoun Road • New Berlin, WI 53151-2709 • Toll Free: 800.783.8871 • Fax: 262.786.4101

## AERO CAM VISION SYSTEM

Vehicle Model	Pair #	Right Side #	Left Side #	5" Monitor	7" Monitor
Volvo VNL	717823	-	-	2	-
	717825	-	-	-	1
	717824	717826	717827	1	-
	-	717812	717811	Aero Cam Only	
Volvo VNM	717828	-	-	2	-
	717830	-	-	-	1
	717829	717832	717831	1	-
	-	717812	717811	Aero Cam Only	
Kenworth T700	717813	-	-	2	-
	717815	-	-	-	1
	717814	717816	717817	1	-
	-	717810	717809	Aero Cam Only	
Kenworth T700 w/ Nav	719547	719548	719549	-	-
	-	717810	717809	Aero Cam Only	
All other PACCAR vehicles	717818	-	-	2	-
	717820	-	-	-	1
	717819	717822	717821	1	-
	-	717810	717809	Aero Cam Only	
All other PACCAR vehicles w/ Nav	719550	719552	719551	-	-
	-	717810	717809	Aero Cam Only	

### Aero Cam Features

- Provides a clear view along the side of the truck and trailer to reduce blindspots and improve driver safety
- Optimized camera field of view provides better depth perception with less distortion: objects in blind spots appear larger and are easier to recognize on the color monitor
- Chrome plated aluminum mounting base with four hole mounting pattern for fast and easy installation. The same hole pattern as Velvac Pod and Mod Pod mirrors makes for easy retro-fits
- CMOS camera technology produces superior imaging and accurate colors even in extreme light conditions and harsh weather
  - » 40° to 85°C / -40° to 185°F
  - » Built-in anti-blooming protection to maintain visibility under sunlight, glare and headlight conditions
  - » Superior depth perception
  - » Vibrant colors and clarity
  - » Integrates seamlessly into the Kenworth NavPlus® and Peterbilt SmartNav™ monitors
- For a complete solution, a DVR or Road-iQ and additional cameras can be integrated for full coverage
- FOV: 65° Horizontal, 55° Vertical
- IP Rating: IP69K

- Pair include right and left side Aero Cams, monitor(s), cables and hardware
- Sides include right side or left side Aero Cams, monitor, cables and hardware
- Aero Cam Only is right side or left side Aero Cam only; no monitor or hardware is included



NavPlus with Image from Aero Cam



**NOTE: Part numbers listed in RED are NEW!**



# VISION SYSTEMS

## ROAD-IQ VISION SYSTEM



### Blind Spot Elimination

Cover blind spots in any driving conditions



### Video Recording

Capture all events from any camera



### Remote Video Surveillance

Check on your vehicle from anywhere



### 4G LTE Wi-Fi Hotspot

Stay connected with up to 8 devices



### Vehicle diagnostics

Easy-to-understand warnings help you avoid breakdowns

### • The VideoData Server (VDS)

- Relays real-time blind spots and internal views from up to 7 cameras to an iPad
- Records and saves up to 1 TB of driving footage and data for future playback
- Provides fault codes
- Displays vehicle gauges

### • The NetHub unlocks 4G LTE capability for added connectivity

- Recorded driving footage provides GPS location on map
- Provides fleet managers ability to track fleet assets
- Provides remote video access
- Allows up to 8 devices to connect to the Wi-Fi hotspot



Drive safer with multiple camera surround view

## SAFER. SMARTER. CONNECTED.



Connect any 6 cameras

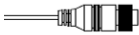

VDS connects cameras to iPad



NetHub provides Wi-Fi hotspot, 4G LTE and GPS



Record and view footage from the cab or remotely\*

### Helpful hint:

Follow the orange boxes for piecing together a kit



Call the Velvac Sales Team: **800.783.8871** sales@velvac.com

© VELVAC INC. • 2405 South Calhoun Road • New Berlin, WI 53151-2709 • Toll Free: 800.783.8871 • Fax: 262.786.4101



## ROAD-IQ VISION SYSTEM



1 Select the VDS and at least one vehicle harness for your application



VDS

- The VDS is the main component of the Road-iQ system
- It is responsible for the collection and management of videos, driver inputs and vehicle data for display, recording/playback and other notable events

### Road-iQ VDS Kit - Required

Part #	Description
250500	VDS kit

### Vehicle Harnesses - One required

Part #	Vehicle Connection Type	Length (ft)
210532	Bare	9.8
210512	OBDII	9.8
210517	OBDII RVC	9.8
210522	J1939	9.8
210527	J1939 RVC	9.8

- Bare harness for recording only
- Other harnesses give ability to receive communicative data such as vehicle diagnostics
- Use OBDII for lighter duty vehicles or Class C RVs; use J1939 for semi-trucks or Class A RVs

2 To access Road-iQ's Wi-Fi and remote diagnostic capabilities, purchase the NetHub (recommended)



NetHub

- The recommended NetHub allows for internet access, Verizon 4G LTE service and to output streaming video to a web portal
- USB ports allow for connection to the iPad
- Contains the 4G LTE modem, GPS, antennas, LED indicator, warning buzzer and SIM card slot
- Includes NetHub cable

### NetHub Kit - Recommended

Part #	Description
250501	NetHub kit

NetHub has cellular services. Contact Velvac for data packages



\*Compatible with iPad Pro, iPad Air 1, iPad Air 2, iPad Mini 2, iPad Mini 3, iPad Mini 4 and later versions

iPad sold separately

**NOTE: Part numbers listed in RED are NEW!**



## ROAD-IQ VISION SYSTEM



③ Select USB options, GPIO harness if trigger connection is needed and iPad mount and base/arm combo for the iPad (sold separately)

### GPIO Harness - Required for most vehicles

Part #	Description
210543	GPIO harness, 19.7 ft

Allows for diagnostics and signal triggers

### USB Recording Storage

Part #	Size
210304	128 GB
210312	256 GB
210307	512 GB

Contact Velvac for larger memory sizes such as MSATA and 1TB options

### iPad Mounts

Part #	Description	iPad
790626	Fit mount	iPad Air (no case)
790628	Locking mount	iPad Air (no case)
790633	Tite mount	iPad Air (w/ case)
790635	Locking mount	iPad Air (w/ case)
790627	Fit mount	iPad mini (no case)
790629	Locking mount	iPad mini (no case)
790632	Tite mount	iPad mini (w/ case)
790634	Locking mount	iPad mini (w/ case)

Mounts require use of base and arm

### iPad Mount Base & Arm

Part #	Description
790576	Medium base & arm (3.69")
790631	Long base & arm (6")

④ Select cameras and cables. Refer to pages V3-V7 for Velvac options



Monitor your vehicle's diagnostics

**NOTE:**  
The Road-iQ system is compatible with 'B' connectors or 'A' connectors with use of an adaptor. For compatible camera, monitor and cable options, see pages V3-V7



Call the Velvac Sales Team: **800.783.8871** sales@velvac.com

**OUR PARTS PUT YOU IN THE PASSING LANE**

# HOSE SUPPORT

## Hose and cable support accessories.

Velvac has the pogo sticks and suspenders you need to organize your hoses and cables to get maximum life from these vital components.

- Pogo sticks
- Springs & handles
- Hose & cable accessories



# HOSE SUPPORT

## HOSE AND CABLE SUPPORT ACCESSORIES



### Hose & Cable Suspenders

- Molded of durable rubber components which remain flexible to -40°F
- Will not stretch out or corrode like traditional steel support springs
- Reduce damage to cab body paint
- 3/4" diameter holes
- For use with hose brackets, pogo sticks and slide bars

Part #	Overall Length
580081	5"
580082	12"
580086	16"
580094	24"



### Slide Bar & Hose Suspender Kit

- Slide bar is 3/4" O.D. stainless steel tubing with 42-1/2" mounting centers
- Kit includes slide bar, 24" hose and cable suspender, nylon ring and zinc-plated steel "S" hook

Part #	Description
580066	Complete kit
580078	Replacement ring with "S" hook
580067	Replacement slide bar
580076	"S" hook



### Hose Holders & Separators

- ABS plastic construction

Part #	I.D.	Description
580037	3/8"	2 Hose separator
580038	3/8"	4 Hose separator
580039	1/2"	2 Hose separator
580040	1/2"	3 Hose separator
580041	1/2"	4 Hose separator



Replacement tracker bar kit

### Replacement Tracker Bar Kits

Tracker bar tender kits are designed to hold air lines and electrical cables to prevent kinks and abrasions during normal highway use.

#### KIT INCLUDES:

- *16" or 20" Spring*: plated for added corrosion resistance and double looped ends for additional strength
- *Snap clip*: rust resistant stainless steel which clips easily onto a tracker bar or pogo stick
- *3 Hose holder assembly*: neatly holds two air hoses and an electrical cable
- *Velvac woven mesh jacket*: protects spring from the elements while giving a clean look

Part #	Description
580111	Kit with 16" spring
580112	Kit with 20" spring
580107	Stainless steel snap clip



Call the Velvac Sales Team: **800.783.8871** [sales@velvac.com](mailto:sales@velvac.com)

© VELVAC INC. • 2405 South Calhoun Road • New Berlin, WI 53151-2709 • Toll Free: 800.783.8871 • Fax: 262.786.4101



# HOSE SUPPORT

## HOSE AND CABLE SUPPORT ACCESSORIES



### Hose Support Springs

- Springs support either air or vacuum lines
- Heat-treated and zinc plated spring steel construction provides corrosion resistance
- Double wire loop ends add extra strength

Part #	Description
038001	3/4" O.D. x 13" long
038003	1" O.D. x 13" long
038008	1-1/8" O.D. x 8" long
038005	1-1/8" O.D. x 28" long



### Grab Handles

- 3/4" O.D. heavy gauge stainless steel tubing
- 5/16" diameter mounting holes

Part #	Description	Grabbing Width
690021	12" Span	3"
690022	18" Span	2"
690023	24" Span	2"

NOTE: Span measurement taken between mounting holes

## POGO STICKS



Part #	Description	Size
581100	Zinc and yellow dichromate	24"
581100-5	Zinc and yellow dichromate w/ holder	24"
581101	Zinc and yellow dichromate	40"
581101-5	Zinc and yellow dichromate w/ holder	40"
581106	Zinc and yellow dichromate	50"
581106-5	Zinc and yellow dichromate w/ holder	50"
581102	Chrome	24"
581102-5	Chrome w/ holder	24"
581103	Chrome	40"
581103-5	Chrome w/ holder	40"
581107	Chrome	50"
581107-5	Chrome w/ holder	50"
581104	Stainless steel	24"
581104-5	Stainless steel w/ holder	24"
581105	Stainless steel	40"
581105-5	Stainless steel w/ holder	40"

NOTE: Part numbers listed in RED are NEW!



# HOSE SUPPORT

## POGO STICKS

- Durable, powder coated steel bodies provide excellent support for air, vacuum and electrical lines
- Snubber chain assembly helps prevent pogo stick from coming in contact with cab
- Heavy-duty, e-coated, oil-tempered steel springs can withstand 90° from vertical bends
- 5/8" - 11 stud and nut for extra support
- Heavy fabric hose holder strap included where pictured



Hose and cable suspender  
US Patent No. 4,358,082



*NO SNUBBER CHAIN  
for use only when  
pogo stick is at  
least 24" away  
from cab*

- Combines popular 40" pogo stick with 5" rubber hose and cable suspender
- Adapter kit retrofits 5" hose and cable suspender on existing pogo sticks and includes "S" hook and eyebolt hardware (9/32" hole is required for installation of eyebolt)

Part #	Description
581001	40" Pogo stick with snubber chain
581005	40" Pogo stick with gladhand holder and snubber chain
581006	Gladhand holder kit

Part #	Description
581011	40" Pogo stick
581015	40" Pogo stick with gladhand holder
581006	Gladhand holder kit

Part #	Description
581040	Pogo stick and hose suspender assembly with snubber chain
581038	Hose and cable adapter kit



Call the Velvac Sales Team: **800.783.8871** [sales@velvac.com](mailto:sales@velvac.com)

© VELVAC INC. • 2405 South Calhoun Road • New Berlin, WI 53151-2709 • Toll Free: 800.783.8871 • Fax: 262.786.4101

**OUR PARTS PUT YOU IN THE PASSING LANE**

# AIR

## High quality air components.

From gladhands to slack adjusters to seat valves, Velvac is your full system provider for critical and convenient air components for your commercial vehicle.

- Extensive line-up of air products
- TS-certified manufacturers
- Exceeds industry specifications



## GLADHANDS

### Iron Gladhands with Polyurethane Seals



- Solid, one-piece construction
- Service and emergency gladhand color-coated for easy identification
- Color-coded polyurethane seal
- Positive, spring loaded locking mechanism keeps gladhand properly positioned
- 1/2" FPT port
- Meets SAE J318 specs including breakaway requirement

**Lifetime guarantee covers both gladhands and seals!**

Part #	Description
035031	Universal gladhand w/ black polyurethane seal
035032	Emergency gladhand w/ red polyurethane seal
035033	Service gladhand w/ blue polyurethane seal

### Shutoff Gladhands

- Lightweight die cast aluminum bodies
- Clamp plates are color-coded for easy identification
- Polyurethane seal included
- 1/2" or 3/8" nylon air tube fitting
- Emergency gladhand with 1/4" - 18NPT port for pindle hook air line fitting
- Meets SAE J318 requirements



Part #	Description
035094	3/8" Service gladhand
035095	3/8" Emergency gladhand
035173	1/2" Service gladhand
035174	1/2" Emergency gladhand

### Premium Powder Coated Gladhand



- Available in service and emergency color coding
- Powder coated aluminum improves corrosion resistance
- Polyurethane seals improve resistance to oil and chemicals
- Bright color coding allows for easy brake line identification
- Stainless steel wear plates are resistant to corrosion and improve service life
- Meets SAE J318 requirements
- 1/2" FPT port

Part #	Description
035169	Powder coated service gladhand w/ polyurethane seal
035170	Powder coated emergency gladhand w/ polyurethane seal

### Shutoff Gladhands

- Lightweight die cast aluminum bodies
- Clamp plates are color-coded for easy identification
- Rubber seal included
- Includes mounting seal to prevent corrosion between gladhand and trailer
- Metal inner ball for increased wear ability
- Meets SAE J318 requirements
- 3/8" - 18 port



035152

Part #	Description
035152	Emergency shutoff
035151	Service shutoff

### 37° Bracket Mount Gladhand



- Lightweight die cast aluminum bodies
- Clamp plates are color-coded for easy identification
- Color-coded polyurethane seal included
- (2) 3/8" FPT ports (one plugged)
- (2) 11/32" diameter mounting holes
- Meets SAE J318 requirements

Part #	Description
035092	Service gladhand
035093	Emergency gladhand

### Aluminum Gladhands

- Velvac's most economical gladhand
- Clamp plates are color-coded for easy identification
- All include flat rubber coupling seal
- 1/2" FPT port
- Meets SAE J318 requirements



035038



035181



035180

Part #	Description
035038	Universal gladhand
035042	Emergency gladhand
035045	Service gladhand
035179	Aluminum emergency gladhand w/ screen filter
035180	Aluminum service gladhand w/ screen filter
035181	Aluminum emergency gladhand w/ guardian seal and flap
035182	Aluminum service gladhand w/ guardian seal and flap



Call the Velvac Sales Team: **800.783.8871** sales@velvac.com

### Pivoting Gladhands



- Spring loaded to safely swing out of the way when not in use
- Seals out contaminants when not in use
- 3/8" - 18 NPTF ports

Part #	Description
035167	Blue - service
035168	Red - emergency

### Polyurethane Gladhand Seals



- Color-coded seals will not crack or tear, reducing maintenance time and cost associated with rubber seal replacement
- Available in attractive display box with 25 sets of seals (set consists of 4 seals per bag, 2 red and 2 blue). See RETAIL section

Part #	Description
035009	Red polyurethane seals
035010	Blue polyurethane seals
035011	Black polyurethane seals
035012	Display box with seals

### "Pacifier" Gladhand Seal

- Reusable gladhand sealing device protects air lines from dust, debris and moisture



Part #	Description
035142	"Pacifier" gladhand seal

### Plated Aluminum Gladhands (with E-Coating)

- E-Coated aluminum gladhand body with a full face plate
- E-Coated aluminum improves corrosion resistance and provides better protection than typical zinc plating
- Service and emergency gladhands have a powder coated face plate for increased corrosion resistance
- Universal gladhand has a zinc plated face plate for increased corrosion resistance
- Rubber seal
- Meets SAE J318 requirements

- Color coded for easy hose identification
- Emergency is polarized to eliminate incorrect hose connections
- Cost saving angle mount eliminates the need for extra mounting hardware



Part #	Description	Replaces Haldex-Midland Number	Connection Thread
035143	Plated - service	11452	1/2" Pipe thread
035144	Plated - emergency	11451	1/2" Pipe thread
035145	Plated - universal	11450	1/2" Pipe thread
035146	Plated - 37° service	11444	3/8" Pipe thread
035147	Plated - 37° emergency	11440	3/8" Pipe thread

### Rubber Gladhand Seals



- Seals constructed of durable black Buna N compound
- "Guardian" seal with rubber flap and metal seal screen help protect air lines from debris

Part #	Description
035005	Standard seals
035007	Flat seals
035140	Seal screen
035141	Guardian seal with flap

Guardian™ is a trademark of Velvac, Inc

### Energy Suspension® Seals



- Could be the last seal you buy!
- Designed to fit all SAE approved gladhands
- Polyurethane seals improve resistance to oil and chemicals, increasing service life and decreasing down time
- Will not crack, dry out or tear like the conventional rubber seals
- Rated to -40°F
- 50 seals per bag

Part #	Description
035165	Blue service seal
035164	Red emergency seal
035166	Black universal seal

Energy Suspension® is a registered trademark of Energy Suspension

**NOTE: Part numbers listed in RED are NEW!**



## GLADHANDS

### Gladhand Seals with Built-in Screens



- Polyurethane seals with stainless steel screens built in
- Traps harmful contaminants before they can cause an air break system failure
- Keeps bugs out of the air lines
- Available in blue, black and red

Part #	Description
035175	Blue service seal with screen
035176	Red emergency service seal with screen
035177	Black universal service seal with screen

### Stow-A-Way™ Gladhand and Plug Holder



580042

- Holds gladhand and electrical hook ups at a 45° angle for easy insertion and extraction
- When properly placed, allows cable and air line storage with both feet firmly on the ground
- Designed for heavier ABS cables
- Standard mounting holes make it easy to replace older designs
- Glass-filled nylon, non-corrosive construction

Part #	Description
580042	Stow-A-Way gladhand & plug holder
580123	Stow-A-Way single plug holder & (2) gladhands

#### Helpful hint:

Improve leverage and reduce air hose kinks by using one of the two styles of gladhand grips

### Gladhand™ Gladhand Grips



035070



035178

- 1/2" NPTF
- Sold in pairs in an attractive display package with information header
- Part No. 035070 polyurethane style features a soft grip with a machined steel core
- Part No. 035178 solid aluminum style features an anodized body with a diamond knurl

Part #	Description
035070	(1) red and (1) blue polyurethane Gladhand™ grip with hardware
035178	(1) red and (1) blue solid aluminum gladhand grip, hardware not needed

### Gladhand Holder Kit



- Designed to mount on all Velvac pogo sticks
- Holds and seals gladhands when tractor is disconnected from trailer
- Durable zinc-plated steel construction
- Single gladhand holder can be mounted directly to cab using 5/16" bolt holes
- Kit includes two gladhand holders and mounting hardware

Part #	Description
581006	Gladhand holder kit
580009	Gladhand holder only

**NOTE: Part numbers listed in RED are NEW!**

### Dummy Coupling



035036



035100

- Durable zinc-plated steel construction for corrosion resistance
- 6-1/2" Coupling length
- 8-1/2" Chain Length, 18" cable

Part #	Description
035036	Vented dummy coupling
035037	Non-vented dummy coupling
035100	Dummy shut-off gladhand

### Glad-Lock™



- Rugged polypropylene gladhand lock helps prevent unwanted connections to tractors and trailers
- Universal design for use on many types of aluminum or iron gladhands
- Two keys furnished with each lock

Part #	Description
035150	Glad-Lock w/ matching keys
035150-6	Glad-Lock w/ random keys

### Line Identification Tags

- 22 gauge aluminum construction with bright red enamel lettering
- 7/8" diameter hole



Part #	Description
035025	Emergency tag
035026	Service tag

Gladhand™, Glad-Lock™ and Stow-A-Way™ are trademarks of Velvac, Inc



Call the Velvac Sales Team: **800.783.8871** sales@velvac.com

## AIR BRAKE HOSE AND TUBING

### Air Brake Hose

- Manufactured to a minimum burst pressure of 870 psi
- Conforms to SAE J1402 and DOT -106 standards
- Performs within an operating temperature range of -40° to +200°F



Part #	Hose I.D.	Hose O.D.	Coil Length
022011	3/8"	3/4"	50'
022011-7	3/8"	3/4"	250'
022047	1/2"	7/8"	50'
022047-7	1/2"	7/8"	250'

\*See pages FH8 & FH9 for applicable reusable fittings

### Slider Air Hose Assemblies with Spring Guard



Part #	Length	Tube O.D.	Tube I.D.
149119	72"	3/8"	3/8"
149120	96"	3/8"	3/8"
149121	108"	3/8"	3/8"
149122	102"	3/8"	3/8"
149123	120"	3/8"	3/8"
149124	102"	1/2"	3/8"
149125	108"	1/2"	3/8"

### Air Brake Hose Assemblies



- Brake hose assemblies meet SAEJ1402 requirements
- Fittings are permanently swaged

Length (Inches)	3/8" I.D. Hose 1/4" Ends One End Fixed One End Swivel	3/8" I.D. Hose 3/8" Ends One End Fixed One End Swivel	3/8" I.D. Hose 3/8" Ends Both Ends Swivel	1/2" I.D. Hose 3/8" Ends One End Fixed One End Swivel	1/2" I.D. Hose 3/8" Ends Both Ends Swivel	1/2" I.D. Hose 1/2" & 3/8" Ends, One End Fixed-1/2", One End Swivel-3/8"
9	147009	-	-	-	-	-
12	147012	-	-	148012	-	-
16	147016	-	-	148016	-	-
18	147018	146018	146518	148018	148518	149018
20	147020	146020	146520	148020	148520	149020
22	147022	146022	146522	148022	148522	-
24	147024	146024	146524	148024	148524	149024
26	147026	146026	146526	148026	148526	149026
28	147028	146028	146528	148028	148528	149028
30	147030	146030	146530	148030	148530	149030
32	147032	146032	146532	148032	148532	149032
34	147034	146034	146534	148034	148534	149034
36	147036	146036	146536	148036	148536	149036
38	147038	146038	146538	148038	148538	-
40	147040	146040	146540	148040	148540	-
42	147042	146042	146542	148042	148542	149042
44	147044	146044	146544	148044	148544	-
46	147046	146046	146546	148046	148546	149046
48	147048	146048	146548	148048	148548	149048
52	-	146052	-	-	-	-
54	147054	146054	146554	148054	148554	-
60	147060	146060	146560	148060	148560	149060
66	-	-	-	148066	-	-
72	147072	146072	146572	148072	148572	149072
84	-	146084	146584	148084	148584	-
96	-	-	146596	148096	148596	-



## AIR BRAKE HOSE AND TUBING

### Air Compressor Discharge Hose



- Stainless steel braided outer jacket
- Extruded inner Teflon® tube prevents carbon buildup
- Withstands extreme temperatures of -100° to +450°F

- Hose and reusable fittings can be assembled to produce air compressor discharge hose assemblies

\*See pages FH10 & FH11 for applicable reusable fittings

Part #	I.D.	O.D.	Coil Length	Recommended Working Pressure (psi)	Minimum Bursting Pressure (psi)	Minimum Bend Radius
142113	1/2"	5/8"	25'	1500	8500	6-1/2"
142113-7	1/2"	5/8"	100'	1500	8500	6-1/2"
142114	5/8"	3/4"	25'	1200	6000	7-3/4"

### Air Compressor Discharge Hose Assemblies



- 5/8" straight tube x 5/8" compression fitting
- Hose measures 5/8" O.D., 1/2" I.D.

Part #	Length
142118	18"
142124	24"
142130	30"
142136	36"
142148	48"



- 3/4" straight tube both ends
- Hose measures 3/4" O.D., 5/8" I.D.

Part #	Length
142436	36"



- 5/8" straight tube both ends
- Hose measures 5/8" O.D., 1/2" I.D.

Part #	Length
142324	24"
142336	36"

### Rubber Air Line Hose

- Tractor to trailer air line hose assembly
- Hose measures 3/8" O.D., 1/2" I.D.



- Female swivel both ends
- Hose measures 5/8" O.D., 1/2" I.D.

Part #	Length
142518	18"
142524	24"
142536	36"
142552	52"
142554	54"
142572	72"
142584	84"



- 5/8" compression fitting both ends
- Hose measures 5/8" O.D. 1/2" I.D.

Part #	Length
142618	18"
142624	24"

Part #	Description
140139	10' Black
140140	12' Black
140141	15' Black
140142	20' Black
140133	12' Blue
140135	15' Blue
140134	12' Red
140136	15' Red

Teflon® is a registered trademark of E.I. DuPont de Nemours and Co.



Call the Velvac Sales Team: **800.783.8871** sales@velvac.com

## AIR BRAKE HOSE AND TUBING

### Air Brake Hose Repair Fitting

- Kit for easy repair of 3/8" rubber air brake hose
- One package contains two fittings and one hex installation tool, all in a clamshell for retail display

- One package will repair two 3/8" rubber air brake hoses
- Male fittings feature pre-applied sealant
- Meets DOT 106 SAE J1402 requirements



### Trailer Nose Box Hose Assembly



- Fits conventional and recessed trailer nose boxes
- Manufactured with 3/8" I.D., SAE Type A four spiral air brake hose
- 1-1/2" swaged end fitting, 1-1/2" reusable end fitting with spring
- 5-3/4" length
- Assembly meets SAE J1402 and FMVSS 106 requirements

Part #	Fitting Size	Sloan #	Tectran #	Tramec #
500007	3/8"	431402	70-31402	31402
500008	1/2"	431403	70-31403	31403

### Nylon Tubing

- SAE Type A tubing is single wall extruded non-reinforced nylon
- SAE Type B tubing has seamless extruded nylon core with fiber reinforced protective nylon cover
- Can be used with either air brake or nylon tube fittings
- 150 psi maximum working pressure
- Withstands temperatures of -40° to +200°F
- Tubing meets SAE J844 and FMVSS 106 requirements



**For air brake systems only,  
NOT for fuel line applications**

Part #	Description
140079	Trailer nose box hose assembly

NOTE: Replacement fitting assembly with spring available - see Part No. 500019 on page FH9

NOTE See pages FH2-FH9 for applicable fittings  
\*Does not meet DOT or SAE specifications

Black Part #	Blue Part #	Green Part #	Red Part #	Yellow Part #	Tube O.D.	SAE Type	Coil Length
020062	020132	020142	-	-	1/8"	A	100'
020062-7	-	-	-	-	1/8"	A	1000'
020065	-	-	-	-	5/32"	A	100'
020066	-	-	-	-	3/16"	A	100'
020064	020134	020144	020154	020164	1/4"	A	100'
020064-6	020134-6	020144-6	020154-6	020164-6	1/4"	A	1000'
020052*	-	-	-	-	5/16"	A	100'
020053	020136	020146	020156	020166	3/8"	B	100'
020053-7	020136-7	020146-7	020156-7	020166-7	3/8"	B	500'
020055	020138	-	020158	020168	1/2"	B	100'
020055-7	020138-7	-	020158-7	020168-7	1/2"	B	500'
020057	-	020157	-	-	5/8"	B	100'
020057-7	-	-	-	-	5/8"	B	250'
020059	-	-	-	-	3/4"	B	100'
020059-7	-	-	-	-	3/4"	B	250'

**NOTE: Part numbers listed in RED are NEW!**

## AIR BRAKE HOSE AND TUBING

### Fifth Wheel Slider Coil



- Continuously returns to original shape
- Flexes from 10" to 54"
- Includes (2) 1/4" tube 1/4" MPT fittings
- Temp range from -40° to 208°F
- Max. pressure rating of 150 psi
- Meets SAE J844 requirements

Part #	Description
022028	Fifth wheel slider coil

### Cab Blower Kit

- Designed for truck cab or low pressure shop use
- Air hose rated at 200 psi max recommended operating pressure
- Kit includes 50' hose, economy air nozzle, tire inflator and gladhand



Part #	Description
149001	Cab blower kit - rubber
149002	Air blow gun



### Air Cab Blow Gun Kit

Kit includes:

- Pre-installed DOT nylon tube fittings
- SAE J844 coiled nylon tube that extends from 10" to 54"
- Two nozzle fittings and lever-type air gun



Part #	Description
149126	Air cab blow gun kit

### Tube Cutter

Part #	Description
090028	Nylon tube cutter

## 3-IN-1 AIR/ELECTRICAL ASSEMBLIES



Part #	Length
145110	10'
145112	12'
145115	15'
145120	20'

- Contains a service air line, emergency air line and an ABS power line (green)
- Enclosed in a heavy duty, beveled edge, spiral wrap
- The spiral wrap keeps the unit neat and compact and provides protective covering
- Air hose assemblies conforms to SAE J1402 / FMVSS 107
- ABS cable assembly conforms to SAE J2394 and the 7-way plug to SAE J560

## 4-IN-1 AIR/ELECTRICAL ASSEMBLIES



Part #	Length
145212	12'
145215	15'

- Contains a service air line, emergency air line, ABS power line (green) and ISO power line (yellow)
- Air hose assemblies conforms to SAE J1402 / FMVSS 107
- ABS cable assembly conforms to SAE J2394 and the 7-way plugs to SAE J560 and ISO 3731, respectively



Call the Velvac Sales Team: **800.783.8871** [sales@velvac.com](mailto:sales@velvac.com)

## COILED NYLON TUBING

### Coiled Nylon Tubing Assembly Kits

- Assemblies include permanently swaged 1/2" - 14 NPTF end fittings with heavy gauge spring for extra support



12' Assembly kit

- Each standard kit contains one emergency (red) and one service (blue) 1/2" O.D. nylon tubing assembly



15' and 20' Assembly kit

- Assemblies meet SAE J844 and FMVSS 106 requirements



15' Assembly kit with long lead

- 6" lead on both ends

Part #	Description
022002	Standard kit
022000	Kit with two extra 3/8" end fittings
022004	Emergency only
022009	Service only

- 12' lead on both ends

Part #	Length	Description
022025	15'	Standard kit
022026	15'	Emergency only
022027	15'	Service only
022030	20'	Standard kit
022031	20'	Emergency only
022032	20'	Service only

- One 40" lead, one 12" lead

Part #	Description
022001	Standard kit
022005	Emergency only
022008	Service only



**NOTE: Part numbers listed in RED are NEW!**



## GLACIER AIR LINES

### Glacier Air Coils

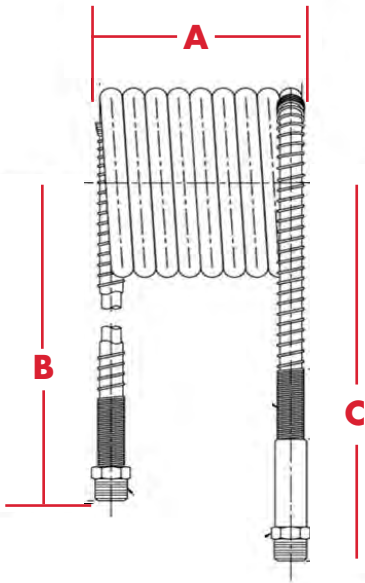

- Larger 5.5" coil O.D. prevents kinking and provides superior recoil and coil memory
- Meets or exceeds applicable requirements of SAE J844, J1131 and FMVSS 571.106
- Durable heavy duty jacketing means coils remain flexible at -85°F (-65°C)
- Permanently swaged 1/2-14 NPTF end fittings with thread sealer simplifies assembly
- 2.5" integrated brass handle allows for easier coupling and uncoupling of gladhands

Part #	Description	Working Length - A	Leg Length - B	Leg Length - C
022633	Glacier coil set			
022634	Red	12'	9.25"	11.5"
022635	Blue			
022636	Glacier coil set			
022637	Red	15'	9.25"	11.5"
022638	Blue			
022639	Glacier coil set			
022640	Red	15' Long lead	41.25"	11.5"
022641	Blue			
022642	Glacier coil set			
022643	Red	20'	9.25"	11.5"
022644	Blue			



Call the Velvac Sales Team: **800.783.8871** [sales@velvac.com](mailto:sales@velvac.com)

## AIR BRAKE VALVES

### Dash Control Valves (PP-1, PP-2, PP-3, PP-7, and PP-8 Styles)



- PP-1 Style
- Automatic pressure release at 40 psi
- 1/8" NPT supply port
- Knob and mounting nut sold separately (see page A12)



034015  
(as shown; top portion only is different)

- Direct replacement for Bendix 275250, 276462
- PP-2 Style
- Automatic pressure release at 40 psi
- 1/8" NPT supply port
- (2) 1/8" NPT delivery ports
- 1/8" NPT brake valve port
- Knob and mounting nut sold separately (see page A12)



034017



034018

- PP-3 Style
- Tripper exhausts at 30 psi and charges above 50 psi
- Plunger trips at 40 psi and charges manually
- 1/8" NPT supply port
- 1/4" NPT delivery port
- 1/4" NPT exhaust port
- Knob and mounting nut sold separately (see page A12)

Part #	Delivery Ports	Replaces
034013	(2) 1/8" NPT	Bendix 275175, 276566, 276567 & Midland KN20021
034015*	(2) 1/8" NPT	Bendix 279786, 281587
034014	(2) 1/4" NPT	Bendix 287417, 287600

Part #	Description
034016	Pressure balanced dash control valve



034080  
(as shown; top portion only is different)

- PP-7 style
- Automatic pressure release at 40 psi
- Non-override at 25 psi
- 1/8" NPT supply and control ports
- 1/4" NPT delivery port
- 1/4" threaded exhaust port on Part No. 034079
- Knob and mounting nut sold separately (see page A12)

Part #	Description	Replaces
034017	Automatic tripper dash control valve	Bendix 288746
034018*	Automatic tripper dash control valve	Bendix 279787

\*Remote controlled - 1/4" - 20 female thread for knob or cable

\*Remote controlled - 1/4" - 20 female thread for knob or cable



- Direct replacement for Bendix 287238 & Midland KN20035
- PP-8 style
- Automatic pressure release at 20 psi
- 1/8" NPT supply, delivery (2) and exhaust ports

Part #	Description
034019	Dash control valve

Part #	Shaft Diameter	Replaces
034051	3/8"	Bendix 288239, 288721 & Midland KN20025
034079	5/16"	Bendix 106113, 288241
034080*	1/2"	Bendix 288242

\*Remote controlled - 1/4" - 20 female thread for knob or cable

### Push-Pull Dash Control Valve

- Direct replacement for Midland KN20030, KN20031
- Automatic pressure release at 25-35 psi
- All ports 1/4" NPT
- 1/4" - 28 thread size



Part #	Description
034055	Dash control valve

**NOTE: Part numbers listed in RED are NEW!**



## AIR BRAKE VALVES

### Pressure Reducing Valve (RV-1 Style)

- Direct replacement for Bendix 283590
- Used where a constant set pressure lower than supply pressure is required
- Adjustable-factory preset at 70 psi
- 1/4" NPT supply and delivery ports



Part #	Description
034085	Pressure reducing valve

### Tractor Protection Valve (TP-3 Style)

- Direct replacement for Bendix 279000 & Midland KN34060
- 1/4" NPT tractor emergency port
- 3/8" NPT tractor service port
- 1/2" NPT trailer emergency and trailer service ports



Part #	Description
034068	Tractor protection valve

NOTE: Always use this valve in conjunction with a PP-1, PP-3 or PP-7 style dash control valve (see page A11)

### Knob and Pin Kits



034049



034054



034053



034050



034052

Part #	Description	Replaces
034049	Trailer air supply knob and pin kit for PP-7 style dash control valve	Bendix 290655 & Midland KN20900
034050	Parking brake knob and pin kit for PP-1 style dash control valves	Bendix 248433 & Midland KN20903
034052	Plain black knob and pin	Bendix 241866
034053	Pull to Park/Release parking brake knob and pin kit for PP-1, PP-2 and PP-3 style dash control valve	Bendix 240302
034054	Dash control valve mounting nut	Bendix 239357

NOTE: All knob kits include roll pin for securing valve

### Tractor Protection Valve (TP-5 Style)

- Direct replacement for Bendix 288605
- Formerly VM-2 style control valve manifold
- 3/8" NPT service and trailer / emergency supply ports (rear)
- 1/4" NPT stop light switch port
- 3/8" NPT trailer control port
- 1/2" NPT trailer service and trailer emergency supply ports



Part #	Description
034082	Tractor protection valve

### Dash Control Valve (MV-3 Style)

- Direct replacement for Bendix 065157, 800516
- Combination PP-1 and PP-7 valve
- 1/4" diameter horizontal mounting holes at 4-7/32" O.C.
- 1/4" diameter vertical mounting at 3" O.C. mounting holes



Part #	Description
034081	Dash control valve



Call the Velvac Sales Team: **800.783.8871** sales@velvac.com

## AIR BRAKE VALVES

### Modulating Relay Valve (R-7 Style)

- Direct replacement for Bendix 103081, 283932
- 3/8" NPT supply and (2) delivery ports
- 1/4" NPT control and balance ports
- Spring brake release pressure of 95 psi



Part #	Description
034023	Modulating relay valve

### Double Check Valve (DC-4 Style)

- Direct replacement for Bendix 278614 & Midland KN25060
- All ports 3/8" NPT
- May be mounted in any position



Part #	Description
034062	Double check valve

### Relay Valve

- Direct replacement for Midland KN28060
- 3/8" NPT control port
- (2) 1/2" NPT supply (reservoir) ports
- Crack pressure 4.6 psi
- (2) 3/8" delivery ports



Part #	Description
034059	Relay valve

### Relay Valves (R-6 Style)

- 1/4" NPT service port
- (4) 3/8" NPT delivery ports



Part #	Supply Port(s)	Replaces
034020	(1) 1/2" NPT	Bendix 279180, 280375
034021	(1) 3/4" NPT (in mounting flange) (1) 3/8" NPT	Bendix 279952

### Relay Valve (R-8 Style)

- Direct replacement for Bendix 286370, 286371
- 1/4" NPT service port
- (2) 3/4" NPT supply ports
- (2) 1/2" NPT, (1) 1/4" NPT delivery ports
- 1/8" NPT balance port located under exhaust cover
- Cracking pressure 3 psi



Part #	Description
034024	Relay valve

### Relay Valves (R-12 and R-14 Styles)



R-12 Style



R-14 Style 1/2" NPT



R-14 1/8" NPT balance port located under exhaust cover

Part #	Style	Supply Port(s)	Delivery Ports	Replaces
034025	R-12	1/2" NPT	Verticle (4) 1/2" NPT	Bendix 102166, 102626
034026	R-12	(2) 3/4" NPT	Horizontal (2) 1/2" NPT	Bendix 103009
034027	R-14	(2) 3/4" NPT	Horizontal (2) 1/2" NPT	Bendix 103010
034028	R-14	1/2" NPT	Verticle (4) 1/2" NPT	Bendix 103028

### Relay Valves (RG-2 Style)

- Fast, low cracking pressure - 5 psi
- 1/4" NPT control port



Part #	Reservoir Ports	Delivery Ports	Replaces
034056	(2) 3/8"	(2) 3/8"	Midland KN28500
034057	(1) 3/8", (1) 1/2"	(2) 3/8"	Midland KN28510
034058	(2) 1/2"	(2) 1/2"	Midland KN28520

## AIR BRAKE VALVES

### Relay Emergency Valve (RE-6 Style)

- Direct replacement for Bendix 281865
- 1/4" NPT service and emergency ports
- (1) 3/4" NPT, (1) 3/8" NPT supply ports
- (2) 3/8" NPT, (2) 1/4" NPT delivery ports



Part #	Description
034029	Relay emergency

### Multi-Function Trailer (RT-4 Style)

- Direct replacement for Midland KN26000
- 3/8" NPT trailer supply and control ports
- 1/2" NPT and 3/8" NPT reservoir ports
- (4) 3/8" NPT delivery ports
- PPV closing pressure at 55 psi



Part #	Description
034063	Multi-function trailer valve

### Relay Emergency Valves



034066

- 1/4" NPT delivery and service control ports
- 1/2" NPT supply port



034067

- 1/4" NPT service and emergency inlets
- (4) 3/8" NPT delivery ports
- 3/4" NPT reservoir
- Crack pressure 3 psi



034069  
(w/ratio feature)

- 1/4" NPT emergency and service ports
- (4) 3/8" NPT delivery ports
- 3/4" NPT reservoir port

Part #	Description	Replaces
034066	Relay emergency valve	Sealco A-1000
034067	Relay emergency valve	Midland KN30400 & Wagner A99036
034069	Relay emergency valve	Sealco 110200

### Air Governors (D-2 Style)

- Factory preset opening and closing pressures of 100 to 120 psi
- (6) 1/8" NPT ports and two mounting holes
- Mounting gasket and (4) 1/8" socket head pipe plugs included
- High temperature governor designed with high temperature withstanding O-rings
- Individually boxed



Part #	Description	Replaces
032131	Air governor	Bendix 275491 & Midland KN18530
034083	High temperature air governor	Bendix 284358 & Midland KN18534



Call the Velvac Sales Team: **800.783.8871** sales@velvac.com

## AIR BRAKE VALVES

### Foot Valves (E-3, E-6, and E-7 Styles)

- Direct replacement for Bendix 277863 & Midland KN22100
- E-3 style
- 1/2" NPT supply and delivery ports
- (2) 1/4" NPT auxiliary supply ports



- Direct replacement for Bendix 286171 & Midland KN22140 and KN22150
- E-6 style
- 3/8" NPT supply and delivery ports



### Spring Brake Valve (SR-1 Style)

- Direct replacement for Bendix 286364
- 1/4" NPT reservoir, control, supply and delivery ports
- 55 psi reservoir trip pressure
- Bracket mounted



Part #	Description
034038	Single circuit brake valve

Part #	Description
034039	Dual circuit brake valve

Part #	Description
034030	Spring brake valve



034040



034077

- E-7 Style
- Dual circuit valves
- 1/2" exhaust port with diaphragm
- Three mounting holes - firewall mounted
- O-rings included

### Trailer Spring Brake (SR-5 Style)

- Direct replacement for Bendix 065437
- 3/4" NPT reservoir mounting port
- 1/4" NPT service/spring brake reservoir, service, trailer supply and trailer service ports
- (4) 3/8" NPT delivery ports
- Anti-compounding



Part #	Side Ports	Rear Ports	Application	Replaces
034040	(2) 1/4" Supply	No threads	Ford	Bendix 284760
034077	(4) 1/4" Supply (4) 1/4" Delivery (Threaded)	1/8" Supply (2) 1/2" Supply (2) 1/2" Delivery	Navistar	Bendix 288383

### Trailer Spring Brake Valves (SR-2 and SR-4 Styles)



034031



034032



- SR-2 style valves
- 1/4" NPT service reservoir (2) and trailer supply ports
- (4) 3/8" NPT delivery ports
- 1/4" NPT trailer service port on Part No. 034031
- SR-4 style valves
- 1/4" NPT reservoir charging (2), trailer supply and trailer serviceports
- (4) 3/8" NPT delivery ports

Part #	Reservoir Port	Replaces
034031	1/2" MPT	Bendix 103061
034032*	3/4" MPT	Bendix 287376

Part #	Reservoir Port	Replaces
034033	3/4" MPT	Bendix 101112
034034	1/2" MPT	Bendix 101622

Part #	Description
034035	Trailer spring brake valve

\*Does NOT have trailer service port for anti-compound



## AIR BRAKE VALVES

### In-Line Quick Release Valves



032019



032020

- Speeds up release of trailer service brakes when installed on service side gladhand
- Speeds up application of trailer parking brakes when installed on emergency side gladhand
- Suitable for use on double or triple trailers
- Durable zinc die cast bodies
- Flow Rate: Forward - 9.0 SCFM at 2 psi; Exhaust - 8.0 SCFM at 2 psi
- 1/2" - 14 MPT with Vibraseal thread sealer one end, 1/2" - 14 FPT other end
- 1-1/2" diameter x 3-1/2" long

Part #	Description
032019	Mounts between tractor protection valve and air lines
032020	Mounts at tractor gladhand

### Quick Release / Double Check Valve (QR-1C Style)



- Direct replacement for Bendix 289714 & Midland KN32041
- 1/4" NPT supply and balance ports
- (2) 3/8" NPT delivery ports
- (2) 1 1/32" diameter mounting holes at 1-1/2" on center
- Supply and delivery differential is 1 psi max

Part #	Description
034012	Quick release valve

### Quick Release Valves (QR-1 Style)

- 3/8" NPT exhaust port
- (2) 1 1/32" mounting holes at 1-1/2" on center
- Cracking pressure of 1 psi



Part #	Side Ports	Rear Ports	Replaces
032015	3/8" NPT	3/8" NPT	Bendix 229859, 288251 & Midland KN32005
032018	3/8" NPT	1/2" NPT	Bendix 229860 & Midland KN32011
034078	1/4" NPT	3/8" NPT	Bendix 229813

### Limiting and Quick Release Valves (LQ-2 and LQ-4 Styles)



- Direct replacement for Bendix 229505
- LQ-2 style
- Limits front axle service brake application by 50% and serves as a quick release valve for that axle - commonly found on pre-121 (pre-1985) vehicles
- 3/8" NPT supply, delivery and exhaust ports
- 1/4" NPT control port
- 1 9/32" diameter mounting holes at 1-1/2" on center

Part #	Description
034084	Limiting and quick release valve

- Direct replacement for Bendix 289144
- LQ-4 style
- For limiting front axle pressure
- 3/8" NPT supply and delivery ports
- (2) 1 9/32" diameter mounting holes at 1-1/2" on center
- Nominal hold off pressure of 4 psi
- Nominal equalizing pressure of 60 psi



Part #	Description
034036	Limiting and quick release valve



Call the Velvac Sales Team: **800.783.8871** sales@velvac.com

## AIR BRAKE VALVES

### Air Tractor Control Kits

- Kits add hand and foot control to trucks with pre-FMVSS 121 air brakes hauling an air brake trailer (for trucks with FMVSS 121 air brakes, consult the truck manufacturer)
- Hose assembly jumper lines and support springs included with kit (kit No. 131012 only)
- Hand control valve included (except for Part No. 131016). This normally closed valve has 1/4" FPT inlet/ outlet/exhaust ports and an 1/8" FPT pressure gauge port

(180 psi maximum supply pressure)  
- hand control valve also sold separately

- NOT FOR ABS APPLICATIONS



131012

Part #	Description
131012	Kit for tractor installations
131014	Kit for dump truck installations
131016	Kit for dump truck installations without hand valve
032051	Hand control valve

## AIR ACCESSORY VALVES

### Universal Fan Clutch Drive Solenoid Kit



Five year guarantee against failure under normal operating conditions!

- Nominal voltages: 12 VDC
- Working voltage: 11-16 VDC
- Maximum operating pressure: 150 psi
- Max exposure temperature: 200°F
- Mounting hole: 3/8"
- Ports: (3) 1/8" - 27 FPT
- Universal kit replaces existing solenoids found on Kysor, Bendix and Horton fan clutches
- Kit includes valve, wire harness with Weather-Pack sealed connectors, exhaust shield, in-line filter and butt connectors

Part #	Description
032192	Universal solenoid kit
032194*	Replacement solenoid
032190	Replacement in-line filter
032191	Replacement 1/8" NPT exhaust vent

\*Valve may also be used for shutter stat solenoid applications. Replaces Navistar numbers 450284C91 and 1692761C91 for this use

### Three-Way Solenoid

- Provides On/Off exhaust function
- Inlet port normally closed - for intermittent use only
- (2) 1/4" FPT ports
- 12 VDC
- 100 - 120 psi operating pressure
- 2-9/32" diameter mounting holes on 2-1/2" centers



Part #	Description
320051	Three-way solenoid

### Air Solenoid Valve

- Direct replacement for Neway 90054075 (normally open)
- 12 VDC, 10 watts
- Intermittent use only
- 100psi maximum operating pressure
- 1/4" threads



Part #	Description
034075	Air solenoid valve

NOTE: Always use in conjunction with a momentary contact switch (see Part No. 090202 on page E14)



## AIR ACCESSORY VALVES

### Power Take-off and Dump Pump Control Valve Kit



- Replaces Chelsea 328388-79X
- Kit includes combo control valve with 1/4" built-in push-to-connect fittings, in-line fuse holder with 9 amp fuse, cable, pressure protection valve 1/4" nylon tubing (50') and fittings-control valve assembly also sold separately

Part #	Description
032144	PTO and dump pump control valve kit
032142	Combo control valve (feathering valve)
034073	PTO cable
032086	Pressure protection valve

### Power Take-Off Air Shift Kit



- Power take-off kit controls add-on air-controlled accessories
- Kit includes control valve, indicator light, 1/4" nylon tubing (50') and fittings, cable, bracket and pressure protection valve. Control valve assembly, indicator light and cable sold separately

Part #	Description
034070	Power take-off air shift kit
034071	Air shift valve assembly
034072	Indicator light
034073	PTO cable
032086	Pressure protection valve

### Power Take-Off Four-Way Control Valve



- Replaces Chelsea 328865X
- Panel-mounted, three position valve
- 1/8" - 27 NPTF
- 150 psi maximum operating pressure
- Operating temperature range from -20° to +200°F

Part #	Description
032145	PTO four-way control valve assembly

### Power Take-Off Combo Control Valve with Shift Tower

- Combo valve controls PTO and dump pump operations
- 1/4" brass push-to-connect fittings included on valve assembly
- Shift tower measures 4-5/8" x 3-5/8" x 8" H overall with 2" access hole and mounting holes 4-1/4" on center



Part #	Description	Replaces
032143	PTO combo valve with shift tower	-
032142	Combo control valve (feathering valve)	Chelsea 329358X
032146	Control valve shift tower	Chelsea 329219X



Call the Velvac Sales Team: **800.783.8871** sales@velvac.com

## AIR ACCESSORY VALVES

### In-Line Quick Release Valves

- Push-connect fittings mate easily with 1/4" nylon tubing for easy installation
- 150 psi maximum operating pressure
- On/Off faceplate Part No. 032039 fits air-electric and flipper valves Part Nos. 032232, 032233, 032234 and 032236 and installs using 10-24 x 1/4" screw
- Air-Electric Valves  
Technical Information:
  - » Switch Off Position: No air flow, electrical contacts open
  - » Switch On Position: Air flows through valve, electrical contacts closed
  - » Amperage: 5 amp resistive current load at 12 VDC
  - » Terminal Size: 1/4" blade
  - » Pressure Switch: Open below 10 psi, closed above 35 psi



Part #	Photo	Description	Toggle Style	Lever Position	Primary Vehicle Application
032225	A	Air-electric toggle valve	Paddle	-	Kenworth, Volvo
032227	B	Air-electric toggle valve	Blade	-	Mack
032228	C	Air-electric toggle valve	Bat	-	Peterbilt
032229	D	Air toggle valve	Paddle	-	Kenworth, Volvo
032231	E	Air toggle valve	Blade	-	Mack
032232	F	Air-electric flipper valve	-	Right off	Freightliner
032234	F	Air-electric flipper valve	-	Right off	Navistar
032235	F	Air-electric flipper valve	-	Right off	Navistar
032233	G	Air flipper valve	-	Right off	Freightliner
032236	G	Air flipper valve	-	Right off	Navistar

\*These are only primary listings-valves are universal and suitable for a variety of applications

### Transmission Selectors



Part #	Description
032400	Trans selector A4487
032401	Trans selector A4490
032402	Trans selector A4491

### Transmission Range



Part #	Description
032403	Range value A-6909
032404	Range value A-6913
032405	Range value A-6915
032406	Range Value A-6918

### Universal Three-Way Toggle Valve



- 1/8" NPT supply and delivery (2) ports
- Includes chrome-plated flip handle
- Faceplate sold separately - install using a 10-24 x 1/4" screw

Part #	Description
032037	Universal three-way toggle valve
032039	Faceplate - On/Off

## AIR ACCESSORY VALVES

### Universal Air Accessory Dash Valves



- Two position, three-way air valves
- Include DOT compliant (FMVSS 106) push-to-connect fittings for 1/4" tubing
- Built-in standard four pin electrical connector for backlit function
- Additional rear port used to easily jumper air lines between valves
- Fit standard 22 mm x 44 mm openings, easily replacing valves found on many current model trucks
- Operating Temperature: -10° to +160°F
- Rated Pressure: 150 psi maximum
- Rated Current Load: 1 amp at 14 VDC (max.)
- Electric Connector: Valve connector mates with Metri-Pack 150 Series connector Part No. 12045813 with female terminals (for reference only - not available from Velvac and not included)

Part #	Description
032247	Inter-axle differential lock dash valve
032248	Fifth wheel slide dash valve
032249	Air suspension dump dash valve
032250	Power take off dash valve
032253	Universal dash valve
032022	Inter-axle differential lock dash valve
032023	Differential lock dash valve

### Height Control Valves: Standard Leveling Valve, Cab Leveling Valve and a Rapid Dump Feature Valve

- Valves feature patent Shear-Seal® design technology
- Superior performance in high cycle and contaminated air conditions
- Precision machined metal sealing surface creates a zero leak\* seal
- Increased life expectancy and lower air consumption
- Direct replacement for many OE valve installations

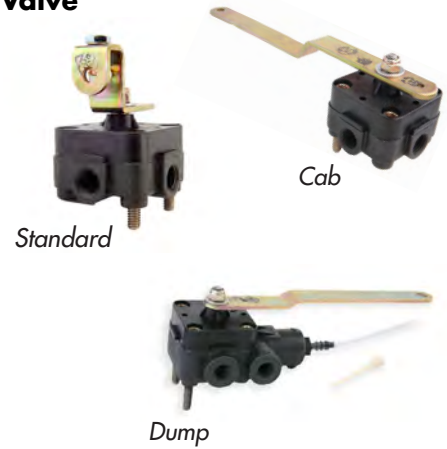

Part #	Description	Ports	Replaces	Used with Vehicles
034101	Cab valve	1/4" NPT	WABCO S464 007 004-0 Barksdale KD2483	International cab, Peterbilt cab
034111	Standard chassis valve	1/4" NPT	WABCO S464 002 443-0 Barksdale KD2484 Midland KN 27000	International chassis
034112	Standard chassis valve	1/4" NPT	Hadley/Neway 90054007, Barksdale KD2485	Kenworth chassis
034113	Standard chassis valve	1/4" NPT	Delco King of the Road 12C-1 (KOR 5549705) & 12-6-2 (KOR 5549706), Barksdale KD2489	Volvo chassis
034114	Standard chassis valve	1/4" NPT	Hadley H00450CE Barksdale KD2482	Volvo / Mack chassis
034122	Dump valve	1/4" NPT	Hadley H00500RS Barksdale KD2486	International chassis
034123	Dump valve	1/4" NPT	WABCO 464 008 115-0 Barksdale KD2487	Volvo chassis
034124	Dump valve	1/4" NPT	International 2506169C91 Hadley HAD500NS, Barksdale KD2488	International chassis w/dump, Peterbilt chassis w/dump
034126	Dump valve	1/4" NPT	Haldex PR 90554950 & 90554945, Barksdale KD2490	Kenworth chassis w/dump, Volvo chassis
034137	Standard chassis valve	1/4" NPT	Barksdale KD2481, Volvo 85112638, Volvo 85108667, Volvo 85112623, Mack 99QK148M	Volvo / Mack chassis

NOTE: See photos on next page.  
\*Zero-leak is less than 4CC per minute

Shear-Seal® is a registered trademark of Barksdale Control Products



034137



Call the Velvac Sales Team: **800.783.8871** sales@velvac.com

### Shear-Seal® Height Control Valve



034122



034123



034124



034112



034101



034126



034113



034114



034111

### Shear-Seal® Height Control Valve Linkage and Hardware

#### Adjustable Linkage

- Adjusts for 8-3/4" to 14-1/2"
- 1/4" diameter mounting bolts
- Zinc plated steel rods
- Elastomer ends



Adjustable linkage



034135



034136



034134

Part #	Description
034130	Adjustable Linkage - adjustment range 6.9-9.6 inches
034131	Adjustable Linkage - adjustment range 9.8-11.5 inches
034132	Adjustable Linkage - adjustment range 10.9-13.6 inches
034133	Adjustable Linkage - adjustment range 12.8-19.0 inches
034134	Linkage Hardware - 5/16-18 thread
034135	Linkage Hardware - 1/4-20 thread
034136	Linkage Hardware - 8 mm course thread



**NOTE: Part numbers listed in RED are NEW!**



## AIR ACCESSORY VALVES

### Height Control Valves



032139



034065  
Delayed response\*\*



034064  
Immediate response



032140



032141  
Immediate response\*

Part #	Ports	Description	Replaces
032139	1/8" NPT	Includes linkage and brackets	Hadley H600
032140	1/4" NPT	Valve only	Midland/Haldex & Neway 90554241
032141*	1/4" NPT	Includes built-in dump valve	Midland/Haldex & Neway 90554271
034064	1/4" NPT	Includes linkage kit	Midland KN27000
034065**	1/8" NPT	Includes fitting package	Neway 90054007

\* Normally open dump feature; needs air pressure to dump from air spring

\*\*7-12 seconds prior to releasing air to air bags; also known as self-leveling

### Air Horn Actuator Valves

- Direct replacements for air horn valves found on many trucks
- Replace similar valves from both Grover and Hadley
- Molded mounting bracket and push-connect fittings provide easy installation



Part #	Photo	Description	Ports	Vehicle Application
032240	A	Single outlet	(3) 1/4"	Kenworth
032241	A	Dual outlet	(3) 1/4"	Kenworth
032242	B	Dual outlet	(3) 1/4", (1) 3/8"	Freightliner
032243	B	Single outlet	(3) 1/4", (1) 3/8"	Freightliner
032244	C	Medium-duty	(2) 3/8"	Navistar
032245	D	Conventional cab	(2) 3/8"	Navistar
032246	E	Cab over	(2) 3/8"	Navistar

### Rapid Dump Air Suspension Valve



- Replaces Humphrey 250A N/O valves
- Pilot operated
- Dual delivery design allows for in-line plumbing of air spring lines and eliminates need for tee fittings
- (4) 1/8" FPT ports
- Mounts on either right or left frame rail using 1/4" mounting holes

Part #	Description
032195	Rapid dump air suspension valve



Call the Velvac Sales Team: **800.783.8871** sales@velvac.com

## AIR ACCESSORY VALVES

### Pressure Protection Valves

- Nominally closed
- Nominal closing pressure 65-75 psi
- (2) 1/4" FPT ports
- 150 psi maximum operating pressure



- Designed for convenient in-tank mounting on tanks with dual outlet ports
- All valves except Part No. 032221 include Vibraseal sealant on mounting thread for easy installation

Part #	Description
032086	Pressure protection valve

- Direct replacement for Bendix 286500
- 1/4" NPT supply and delivery ports
- 85 psi nominal closing pressure
- Non-adjustable



PR-4 Style

Part #	Description
034037	Pressure protection valve

### Three-Way Pilot Valve

- Direct replacement for Neway 90054079
- For Neway suspension systems
- 1/4" NPT supply / delivery / exhaust ports



Part #	Description
034074	Three-way pilot valve

Part #	Inlet Port (NPTM)	Outlet Ports (NPTF)	Nominal Opening Pressure (psi)	Nominal Closing Pressure (psi)	Primary Vehicle Application
032216	3/8"	3/8"	55	45	Freightliner
032217	3/8"	3/8"	85	67	Ford
032218	1/2"	3/8"	55	45	Freightliner
032219	1/2"	3/8"	85	67	Freightliner
032220	1/2"	1/4"	65	55	Peterbilt
032221	1/2"	1/4"	100 (max)	70 (min)	Kenworth
032222	1/4" Hex nipple	1/4"	100 (max)	70 (min)	Mack*

NOTE These are only primary listings-valves are universal and suitable for a variety of applications

\* Replaces Mack number 20QE2326A

### Height and Lumbar Control Seat Valves



- Valves control air ride truck seats and lumbar supports
- Available in push/pull and paddle type configurations
- Spring-loaded, three-way function

- Electro-pneumatic combination valve designed to operate air seats using an electric air compressor
- Designed to replace valves on seats by major manufacturers such as Bostrom, National and Sears

Part #	Photo	Description	Ports	Primary Seat Application
032110	A	End and side ported with removable chrome knob	(2) 1/8" FPT	Various
032205	B	End ported with removable chrome knob	(2) 1/8" FPT	Various
032206	C	Electro-pneumatic with removable black knob & (2) 1/4" blade terminals	(1) 1/8" FPT	Various
032201	D	Paddle type	(2) 3/16" Barbs	Bostrom

NOTE These are only primary listings-valves are universal and suitable for a variety of applications



## PRESSURE SWITCHES AND INDICATORS

### Air Pressure Gauge

- 1-1/2" diameter dial
- Accommodates a 1/8" FPT port
- Pressure range of 0 - 160 psi



Part #	Description
035065	Air pressure gauge

### Brake Light Switch (SL-4 Style)

- Direct replacement for Bendix 228600
- 1/4" NPT supply
- Actuates at 3-5 psi



Part #	Description
036036	Stop light switch

### Low Pressure Indicators (LP-3 Style)

- 1/4" NPT supply
- Automatic pressure release at 60 +/- 6 psi



Part #	Description	Replaces
034041	Single terminal	Bendix 279416
034042	Double terminal	Bendix 228750

NOTE: Use in conjunction with either warning buzzer Part No. 036043 or warning light Part No. 036049

### Pressure Regulator Valve

- A compact, high quality in-line pressure regulator with gauge and bracket kit, rated to 125 psi with 1/4" NPT ports



Part #	Description
320149	Pressure regulator valve

### Low Air Warning Buzzer

- 12 volt buzzer
- 9/32" diameter mounting holes



Part #	Description
036043	Low air warning buzzer

NOTE: Use in conjunction with a low pressure switch, Part No. 034041 or 034042

### Low Air Pressure Warning Light

- 12 volt red light
- Uses #57, 1895 or 293 bulb
- Mounts through 3/4" hole
- Complete with low air face plates



Part #	Description
036049	Low air pressure warning light assembly
002063	Replacement red pilot light
036045	Replacement faceplate

NOTE: Use in conjunction with a low pressure switch Part Nos. 0304041, 034042 or 175043

### Pressure Regulator Valve

- Direct replacement for Bendix 217380 & Midland KN31070
- Non-exhaust type regulator
- 3/8" NPTF delivery and supply ports
- 10-125 psi adjustable pressure gauge



Part #	Description
032060	Pressure regulator valve

### Drain Pull Valves



- Attached vinyl coated aircraft cable
- .075" diameter cable
- 1/4" MPT
- 120 psi maximum pressure

Part #	Description
032135	Valve with 3' cable
032058	Valve with 4' cable
032082	Valve with 5' cable
032160	Valve with 5' cable uncrimped on free end - includes one extra sleeve
032081	Valve without cable
032170	100' Bulk cable
032083	Replacement 5' cable & sleeves
032185	Replacement cable sleeve

## AIR TANK ACCESSORIES



Call the Velvac Sales Team: **800.783.8871** sales@velvac.com

## AIR TANK ACCESSORIES

### Air Dryer Replacement Cartridges



- All include seal rings

Part #	Description	Replaces
034046	Fits AD-SP type air dryers	Bendix 109994, Bosch 1-487-434-901 & WABCO 432-410-020-2, 432-420-220-2 (also fits System Saver 1200)
034047	Fits AD-4 air dryers	Bendix 103981, 104358
034048	Fits AD-9 air dryers	Bendix 107794, 107796

### AD-9 Air Dryer Rebuild Purge Kits



- Installation instructions and all necessary lubricants included
- 12 and 24 VDC heater/thermostat kits also sold separately. These include the heater/thermostat assembly, seal rings and mounting hardware

Part #	Description	Replaces
034087	Purge valve kit w/ purge piston assembly	Bendix 5005037, 5004336, 5004337, 107798
034088	Purge assembly kit - 12V (includes aluminum purge housing, purge valve kit and 12V heater/thermostat kit)	Bendix 800405
034089	Purge assembly kit - 24 Volt (includes aluminum purge housing, purge valve kit and 24V heater/thermostat kit)	Bendix 5004338
034092	Heater/thermostat kit only - 12V	Bendix 109578
034093	Heater/thermostat kit only - 24V	Bendix 109579

### Automatic Reservoir Drain Valve (DV-2 Style)



Non-heated

- Direct replacement for Bendix 281923 & Midland KN24000
- All ports 3/8" NPT

Part #	Description
034043	Automatic reservoir drain valve

### Air Dryer Wiring Harness

- Direct replacement for Bendix 109869, 109871, 298948



- Fits both 12 and 24 volt AD-9, AD-SP, AD-IP and System Saver 1200 units
- 22" leads

Part #	Description
034091	Air dryer wiring harness

### Safety Valves (ST-3 and ST-4 Styles)

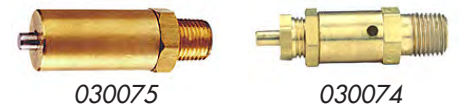

- ST-3 Style
- Automatic pressure release at 150 psi
- 1/4" NPT
- Adjustable valve preset to 125 psi by factory; adjustable from 41-149 psi

Part #	Description	Replaces
030075	Safety valve	Bendix 284142 & Midland KN31200, KN31400
030074	Adjustable safety valve	Bendix 205105

- ST-4 Style
- 1/4" NPT
- Automatic pressure release at 175 psi
- Low profile valve fits AD-9, AD-SP, AD-IP, and System Saver 1200 air dryers



034090

Part #	Description	Replaces
034090	Safety valve	Bendix 800350

## AIR TANK ACCESSORIES

### Single Check Valves



034044



320014



320001



034045



320003

Part #	Description	Replaces
034044	1/4" Threads	Bendix 229603, 800375
320014	3/8" Threads	Bendix 227870, 800373 & Midland KN23010
320001	1/2" Threads	Bendix 227717, 227788, 227871, 800372 & Midland KN23000
034045	1/2" Female threads	Bendix 800370
320003	3/4" Threads	Midland KN23040

### Air Tank Drain Cocks



036003



036019



036021

- 1/4" MPT

Part #	Description
036003	Lever handle drain cock
036019	Back seating drain cock
036021	Wing handle drain cock

## SLACK ADJUSTERS

### Manual Slack Adjusters

- Straight arm, standard duty slack adjusters with bronze bushings
- 22,000 in.-lbs. rating in accordance with SAE Test J1461 Draft 4
- Five rivet design
- 26,000 in.-lbs. maximum torque rating



Part #	Spline	Drilling	Replaces
035120	1.60"-37	6"	Bendix 283411, Midland KN44041 & Euclid E1574HD
035121	1.60"-37	5", 6", 7"	Midland KN44042
035122	1.50"-28	5", 6"	Bendix 286965, Midland KN44051 & Euclid E2458
035123	1.50"-28	5-1/2", 6-1/2"	Bendix 288753, Midland KN44061 & Euclid E2459HD
035124	1.50"-28	5", 6", 7"	Bendix 288282, Midland KN44071 & Euclid E2458HD
035125	1.50"-10	5", 6", 7"	Bendix 278323, Midland KN47001 & Euclid E612HD
035126	1.50"-10	5-1/2", 6-1/2"	Bendix 278321, Midland KN47011 & Euclid E940HD
035127	1.50"-10	5", 6"	Bendix 278312, Midland KN47081 & Euclid E1063HD
035128	1.25"-10	5", 6"	Bendix 278303, Midland KN48001 & Euclid E939
035129	1.25"-10	5", 6", 7"	Bendix 278305 & Midland KN48002
035130	1.25"-10	4-1/2", 5-1/2"	Bendix 278302, Midland KN48031 & Euclid E4904
035131	1.25"-10	4-1/2", 5-1/2" (Right hand offset)	Bendix 278294, Midland KN49000 & Euclid E2762RH
035132	1.25"-10	4-1/2", 5-1/2" (Left hand offset)	Bendix 278295, Midland KN49010 & Euclid E2763LH



Call the Velvac Sales Team: **800.783.8871** [sales@velvac.com](mailto:sales@velvac.com)

## AIR TANKS, BRAKE CHAMBERS AND DIAPHRAGMS

### Air Tanks

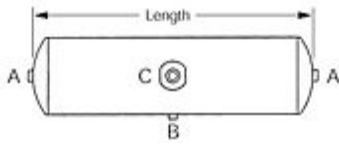

Type 1 - Bracket Mounted

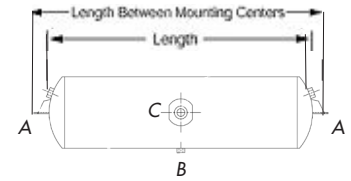

Type 2 - Flange Mounted

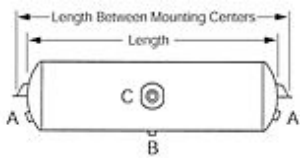

Type 3 - Flange Mounted

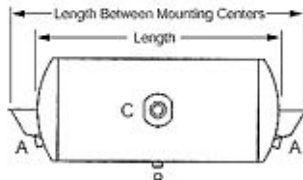

Type 4 - Flange Mounted

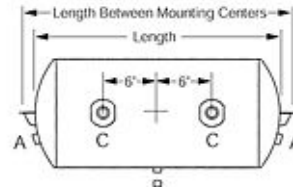

Type 5 - Flange Mounted

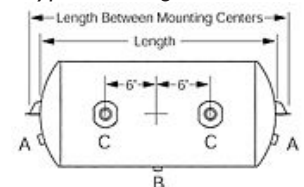

Type 6 - Flange Mounted

- All tanks feature dual main ports except Part No 035103
- All steel construction
- All tanks are water tested prior to shipping
- Dipped tanks are rust resistant and primer sealed
- Internally corrosion resistant
- Tanks meet SAE J10 requirements

### Air Tank Check Valve Kit

- Provides a second dry air reservoir
- Kit includes 1425 cu. in. air tank, mounting brackets, one-way check valve, reducer bushing and 1/4" drain plug

Part #	Description
131045	Air tank check valve kit

### Air Tank Mounting Brackets



- For tanks up to 8-3/16" in diameter

Part #	Description
501051	Air tank mounting brackets

Part #	Tank Type	Diameter	Length	A	B	C	Cu. in. Capacity	Mounting Centers
035103*	1	8"	29-1/4"	1/2"	1/4"	3/4"	1425	-
035101	2	8"	29-1/4"	3/8"	1/4"	3/4"	1425	32"
035102	3	8"	29-1/4"	3/8"	1/4"	3/4"	1425	32"
035106	3	9-1/2"	22-1/2"	3/8"	1/4"	3/4"	1488	27-1/2"
035104	4	9-1/2"	22-1/2"	3/8"	1/4"	3/4"	1488	27-1/2"
035105	4	9-1/2"	22-1/2"	1/2"	1/4"	3/4"	1488	27-1/2"
035108	3	12"	27"	3/8"	1/4"	3/4"	2850	29-1/2"
035107**	5	12"	27"	3/8"	1/4"	3/4"	2850	29-1/2"
035109**	6	12"	27"	3/8"	1/4"	3/4"	2850	29-1/2"

\* This tank can also be used for vacuum applications - also see mounting brackets Part No. 501051

\*\* Dual main ports on same side of tank-ports are 12" apart on center

### Air Brake Chambers



- Direct replacement for all popular service brake chambers
- Fully threaded shaft for maximum adjustability
- Mounting hardware, clevis and cotter pin included

Part #	Dia.	Type	Working Stroke
030013	5.785"	12	1-3/4"
030015	6.5"	16	2-1/4"
030017	7"	20	2-1/4"
030019	7.5"	24	2-1/2"
030021	8.25"	30	2-1/2"

### Air Brake Diaphragm



- Gas and oil resistant
- Rubber/neoprene blend
- Fabric reinforced for extra strength and long life

Part #	Diameter	Type
031021	6"	9
031023	5.5"	12
031025	6"	16
031027	6.5"	20
031031	7"	24
031033	8"	30
031035	9"	36



## AIR CYLINDER CONTROL VALVES

- Anodized aluminum black bodies
- Nitrile seals for long cycle life
- High impact knobs
- Balanced spool design
- Operating temperature range from -40° F to +180°F
- Stainless steel hardware
- Normal operating pressure 100 psi

### Four-Way Push/Pull Valves



- Aluminum shaft with delrin detent ring provides easy ID of valve position
- Threaded aluminum mounting boss for 1" diameter through hole mounting (nuts included)
- (3) 9/32" dia. body mounting holes
- (5) 1/4" - 18 FPT ports
- Normal operating pressure 100 psi
- Includes two faceplates:
  - » Pull to open/Push to close
  - » Pull to raise/Push to lower

### Applications for valves:

- Two position valve operates any double acting air cylinder
- Three position valve operates systems where full air or vacuum pressure must be isolated

Part #	Description
320175	2-position valve
320176	3-pos, holding type valve
320125	Replacement knob, faceplates and nuts

### Viper™ Four-Way Push/Pull



- One piece stainless steel shaft
- Can be mounted using (2) 3/16" diameter body mounting holes or through a 1/2" diameter through hole
- (3) 1/8" NPT ports, (2) 10-32 exhaust ports
- Includes faceplate

Part #	Description
320177	"Viper" four-way valve

Viper™ is a trademark of Velvac, Inc.

### Four-Way Rotary Handle Valve



- Three position valve
- (3) 1/4" - 18 FPT ports
- 1/4" NPT threaded exhaust ports
- (2) 1/4" diameter body mounting holes at 1-15/16" on center
- Operating pressure to 150 psi
- Includes solid one-piece handle and two faceplates (Raise/Lower and Open/Close)

Part #	Description
320179	Rotary handle valve
321034	Raise/Lower faceplate
030092	1/4" Cone filter

### Four-Way Push/Pull Compact Design Valve

- The compact design fits into today's small dash board designs
- Pneumatic valve is designed to control the operations of a typical air cylinder
- 150 psi max air pressure
- 0.4 Cv air flow
- Aluminum body and end caps
- 40 micron filtration

### Four-Way Electronic Solenoid Valve



- Operates any single acting or pressure double acting air cylinder
- Actuated with a std On/Off switch
- Air-piloted assist
- (5) 1/4" -18 FPT port
- (3) 9/32" dia valve body mtg holes
- Normal operating pressure 100psi
- Exhaust cone filters included

Part #	Description
320178	4-way solenoid
320132	Electrical coil
320133	Solenoid mounting nut
030092	1/4" Cone filter
030084	1/8" Cone filter

### Four-Way Mini Electronic Solenoid Valve



- Compact design - 4" overall length
- Air-piloted assist
- 1/8" supply and delivery ports
- 10-32 exhaust ports
- 12VDC coil with low 2 watt draw
- Normal operation pressure
- 100 psi

Part #	Description
320180	4-way mini solenoid
030093	10-32 Cone filter



Part #	Description	Parker #
320187	Four-way valve	410939002



Call the Velvac Sales Team: **800.783.8871** [sales@velvac.com](mailto:sales@velvac.com)

## AIR CYLINDERS

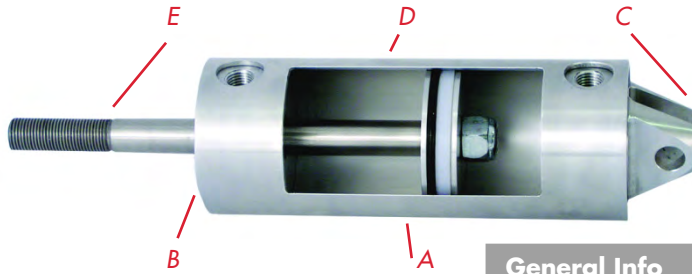

Backed by a 3 year warranty

Velvac's heavy-duty Enforcer™ series of air cylinders are built tough for long life and made from some of the strongest materials available today!

- Machined from 6061 series aluminum, 303 stainless steel, with Nitrile "O" rings and a UHMW polyethylene wear band
- Cycle tested into the millions. The solid construction means the cylinders will keep on working even in extreme conditions where other air cylinders fail. These cylinders are available in push/pull, solenoid operated and spring return versions
- MADE IN THE U.S.A.

General Info	Feature	Type
Cylinder Construction	A	Aluminum cylinder tubing with a 16 RMS finish, lock ring construction secures end caps to tube
Front Cover	B	Solid aluminum with oilight bronze bushing, Delrin seal and 1/4" NPT port
Rear Cover	C	Solid aluminum with mounting hole for 1/2" clevis pin and 1/4" NPT port
Piston Cup	D	Solid aluminum with Nitrile "O" ring rated at -40° to +185°F and UHMW polyethylene wear band
Piston Rod	E	5/8" diameter 303 series stainless steel with 5/8" - 18 thread
Temp Rating	-	-40° to +185°F
Pressure Rating	-	10 psi minimum to 150 psi maximum Standard operating pressure 100 psi



### 2-1/2" Air Cylinder

Part #	Cylinder Type	Stroke	Retracted Length	Extended Length	Thrust at 100 psi	Draw at 100 psi
100204	Push/Pull	4"	9.89"	13.89"	491 lb	460 lb
100226	Spring Return	6"	13.75"	19.75"	251 lb	460 lb
100206	Push/Pull	6"	11.89"	17.89"	491 lb	460 lb
100208	Push/Pull	8"	13.89"	21.89"	491 lb	460 lb

### 3-1/2" Air Cylinder

Part #	Cylinder Type	Stroke	Retracted Length	Extended Length	Thrust at 100 psi	Draw at 100 psi
100308	Push/Pull	8.68"	15.60"	24.28"	962 lb	930 lb
100310	Bullet Type	10"	16.92"	26.95"	962 lb	930 lb

## AIR CYLINDER CONTROL VALVES

### Cone Filters



Part #	Description
030093	10-32 Cone filter
030084	1/8" Cone filter
030092	1/4" Cone filter
030094	3/8" Cone filter

NOTE: Air cylinders and tailgate kits are designed to operate the locking linkage on dump bodies and are NOT to be used as a means of mechanically holding the tailgate shut. Custom kits are available - contact Velvac for more information

Enforcer™ is a trademark of Velvac, Inc.



## AIR CYLINDERS



Velvac's standard series of air cylinders are built for durability with a reputation for quality and affordability!

- Used in a wide variety of applications and conditions and can take the daily abuse associated with typical tailgate applications
- Backed with a 1 year warranty and 100% tested
- Available in push/pull, solenoid operated and spring return versions

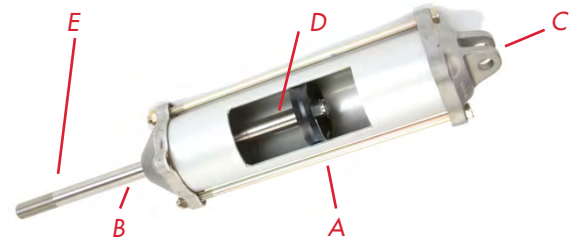

General Info	Feature	Feature/Benefit
Cylinder Construction	A	Smooth cylinder grade aluminum tubing with a 32 RMS finish, tie rod construction secures end caps to tube
Front Cover	B	Die cast aluminum with Nitrile dirt wiper and pressure seal and oil impregnated bronze bushing and 1/4" NPT port
Rear Cover	C	Die cast aluminum with mounting hole for 1/2" clevis pin and 1/4" NPT port
Piston Cup	D	Emralon-coated, single piece, molded piston cup
Piston Rod	E	5/8" diameter 300 series stainless steel with 5/8" - 18 thread
Temp Rating	-	-20° to +185°F
Pressure Rating	-	10 psi minimum to 120 psi maximum Standard operating pressure 100 psi

### 2-1/2" Air Cylinder

At 100 psi:

- Thrust: 483 lb
- Draw: 452 lb

Part #	Cylinder Type	Stroke	Retracted Length	Extended Length
100122	Push/Pull	4"	9.89"	13.89"
100125	Spring Return Norm. Ext.	4"	10.62"	14.62"
100123	Push/Pull	6"	11.89"	17.89"
100126	Spring Return Norm. Ext.	6"	13.89"	19.89"
100124	Push/Pull	8"	13.89"	21.89"

### 3-1/2" Air Cylinder

At 100 psi:

- Thrust: 962 lb
- Draw 918 lb

\*Kit contains air cylinder Part No. 100132 and extended clevis kit #019051. Use this kit when replacing previous cylinder Part No. 101028

Part #	Cylinder Type	Stroke	Retracted Length	Extended Length
100131	Push/Pull	6.68"	13.60"	20.28"
100132	Push/Pull	8.68"	15.6"	24.28"
100136	Push/Pull	8.68"	18.43"	27.12"
100137*	Push/Pull	8.68"	15.60"	24.28"

NOTE: Air cylinders and tailgate kits are designed to operate the locking linkage on dump bodies and are NOT to be used as a

means of mechanically holding the tailgate shut. For tailgate kits see page A33. Custom kits are also available - contact Velvac for information



Call the Velvac Sales Team: **800.783.8871** sales@velvac.com

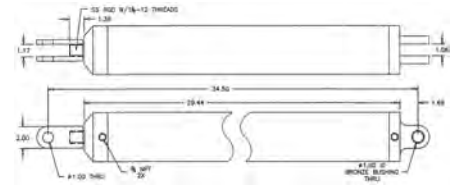

Backed by a 3 year warranty

### High Lift Cylinder - Made in the U.S.A.

General Information		Type
Cylinder Tube	Aluminum cylinder tubing with a 16 RMS finish	
Front Cover	Solid aluminum with oil tight bronze brushing, Delrin seal and 3/8" NPT port	
Rear Cover	Solid aluminum with mounting hole for 1" clevis pin and 3/8" NPT port	
Piston Cup	Solid aluminum with Nitrile "O" ring rated at -40° to +185°F and UHMW polyethylene wear band	
Temp Rating	-40° to +185°F	
Pressure Rating	Standard operating pressure 100 psi, 10 psi minimum to 150 psi maximum	

Part #	Bore	Cylinder Type	Stroke	Retracted Length	Extended Length	Thrust at 100 psi	Draw at 100 psi
100424	4"	Push/Pull	24"	34.5"	58.5"	1,275 lb	1,158 lb

### Tailgate Cylinders - Made in the U.S.A.

- Velvac's Enforcer series of tailgate cylinders is the best choice for any tailgate
- Machined from 6061 series aluminum, 5/8" diameter 303 stainless steel shaft with 5/8" - 18 threads, Nitrile "O" rings and a UHMW polyethylene wear band
- Direct replacements to Haldex and MGM
- Standard operating pressure 100 psi, 90 psi minimum to 150 psi maximum



Part #	Bore	Cylinder Type	Stroke	Retracted Length	Extended Length	Thrust at 100 psi	Draw at 100 psi
100603	6"	Spring return	3"	16.18"	19.18"	400 lb	2,400 lb
100613	6"	Spring return	4.38"	18.62"	23"	1,417 lb	1,400 lb
100614	-	*Bracket kit for 100613	-	-	-	-	-
100615	-	*Spacer kit for 100613	-	-	-	-	-

NOTE: Extended/retracted lengths are measured from the tip of the shaft to the end of the cylinder

\*The bracket kit is used for new MGM installations, while the spacer kit is used when replacing the existing MGM cylinder

## AIR CYLINDER TAILGATE LOCK KITS

### Velvac Original



Part #	Cylinder Diameter/Stroke
100022	2-1/2" x 8" Kit, contents as shown
100028	2-1/2" x 8" Kit, contents as shown, plus 50' of 3/8" black nylon tubing and clips
101002	3-1/2" x 8" Kit, contents as shown, plus 50' of 3/8" black nylon tubing and clips and extended clevis kit Part No. 019051 (see FITTINGS & HARDWARE section)



Part #	Cylinder Diameter/Stroke
101054	2-1/2" x 8" Kit, contents as shown
101058	3-1/2" x 8" Kit, contents as shown



Part #	Cylinder Diameter/Stroke
101055	2-1/2" x 8" Kit, contents as shown
101059	3-1/2" x 8" Kit, contents as shown



Part #	Cylinder Diameter/Stroke
100144-7	3-1/2" x 8" Kit, contents as shown - designed to fit Ox bodies



Part #	Cylinder Diameter/Stroke
100036	2-1/2" x 6" Kit
100037	2-1/2" x 8" Kit
101003	3-1/2" x 8" Kit with extended clevis, Part No. 019051
101004	3-1/2" x 6" Kit
101078	3-1/2" x 8" Kit with clevis Part No. 019049

- Solenoid operated cylinder kits allow the operator to electronically unlock tailgate without leaving the cab
- All kits include clevis and pins, electrical switch part No. 090177, cylinder with four-way solenoid attached

### FIFTH WHEEL AIR CYLINDERS



- Cast aluminum front and rear cover with 1/4" FTP port
- 100 psi operating pressure
- Mounting hole for 17/32" clevis, front and rear
- Gold anodized tube for corrosion resistance

Part #	Bore	Stroke	Replaces	Retracted Length	Extended Length
100101	2-1/2"	6-3/4"	Holland XA-2524-R	12-5/8"	19-13/32"
100102	3-1/2"	2"	Holland XA-2524-R-13-1	7-21/32"	9-21/32"



Call the Velvac Sales Team: **800.783.8871** [sales@velvac.com](mailto:sales@velvac.com)

## LIFT AXLE AND SUSPENSION VALVES

### Manual Push/Pull Valves

- High flow dual pressure air valves for lift axles, suspension dump systems and tailgate control
- Solid aluminum construction
- Nitrile seals for long cycle life
- High impact knobs with face plates
- Balanced stainless steel and aluminum spool design
- Operating temperature range from -40° to +180°F
- Stainless steel hardware
- Normal operating pressure 100 psi



Part #	Description	Valve Type	Ports	Air Flow	Applications	Schematic
320188	"Mini" valve w/ built in exhaust filter	3 Way	1/4" NPT	1.5 Cv	Single acting air cylinders, lift axles or suspension systems	
320184	Valve w/ remote 1/4" NPT exhaust air pilot reset option	3 Way	3/8" NPT	2.2 Cv	Single acting air cylinders, lift axles or suspension systems	
320147	"Mini" valve with 3 way integrated shuttle and built in exhaust filter	3 Way	1/4" NPT	1.5 Cv	Single acting air cylinders, lift axles or suspension systems	
320192	3 position valve with center exhaust feature	4 Way	1/4" NPT	1.5 Cv	Single or double acting air cylinders	
320146	2 position with soft 4 way detent and 1/8" NPT remote air pilot reset option	4 Way	3/8" NPT	2.2 Cv	Single acting air cylinders, lift axles or suspension systems	

### Silicone Lubricant

- Specially formulated silicone lubricant protects and extends the life of air valves and air brake valves. Helps repair the drying effects caused by alcohol and antifreeze
- Light oil can be added directly into the air lines and the heavy oil can be added directly into the valves. Apply twice a year for a better operating system



Part #	Description
320170	Light weight oil - 4 oz bottle
320171	Light weight oil - 5 pack of 4 oz bottles
320172	Heavy weight oil - 4 oz bottle
320173	Heavy weight oil - 5 pack of 4 oz bottles

#### Helpful hint:

To prevent damage to seals, premature air product failures, and possible warranty claim rejection, many OE manufacturers instruct

customers to avoid the use of petroleum based products and de-icing agents in their air systems. It is recommended to change the air

### Brass Electric Coil Air Converter

- Solenoid override adapter mounts on the coil and allows the conversion of the electrical signal into an air signal
- 1/8" NPT ports
- Solid brass construction



Part #	Description
320148	Brass electric coil air converter

dryer filters regularly and use silicone valve oils to help repair seal damage and extend the life of air valves

## LIFT AXLE AND SUSPENSION VALVES

### Solenoid Valves

- Solenoid valves allow the driver to operate single or double acting cylinders, lift axles or suspension dump systems electronically
- Constructed with the same materials as Velvac's air accessory valves
- Normal operating pressure 100 psi
- The solenoid valves have a 12-volt power consumption coil that uses only 4.8 watts



Part #	Description	Valve Type	Ports	Air Flow	Applications	Schematic
320185	Spring return valve with 1/8" NPT external pilot	4 Way	3/8" NPT	2.2 Cv	Lift axles or suspension systems	
320181	Spring return valve with internal pilot assist	4 Way	3/8" NPT	2.2 Cv	Lift axles or suspension systems	
320186	Spring return valve with internal manual override	4 Way	3/8" NPT	2.2 Cv	Lift axles	
320189	Spring return valve with air operated external manual override	4 Way	3/8" NPT	2.2 Cv	Lift axles	
320190	Push-pull valve with solenoid air pilot return	4 Way	3/8" NPT	2.2 Cv	Single or double acting air cylinders and lift axles	

### Air-Pilot Valves



Part #	Description	Valve Type	Ports	Air Flow	Applications	Schematic
320191	Air pilot spring return with 1/4" NPT air pilot supply support	3 Way	3/8" NPT	2.2 Cv	Suspension systems	
320183	Shuttle air pilot spring return valve	4 Way	3/8" NPT	2.2 Cv	Lift axles	
320182	Air pilot spring return valve with 1/8" external pilot port	4 Way	3/8" NPT	2.2 Cv	Lift axles	



Call the Velvac Sales Team: **800.783.8871** [sales@velvac.com](mailto:sales@velvac.com)



**OUR PARTS PUT YOU IN THE PASSING LANE**

# **ELECTRICAL**

**The only source you need.**

From our ISO and ABS coiled cables to plugs, fuses, sockets, terminals and switches, Velvac offers a full line of electrical components to keep drivers doing what they do best - driving.

- **Cable and plug assemblies**
- **Fuses, sockets, terminals and connectors**
- **Battery lugs and terminals**
- **And more**





## CABLE AND PLUG ASSEMBLIES

### Six-Way Coiled Cable Assembly



- 12' working length
- Durable black outer jacket resists abrasion and has excellent coil memory
- Heavy-duty zinc die cast plugs with spring guards included

Part #	Working length	Description
590061	12'	6/14 Gauge
050029	12'	Replacement cable

### Single Pole Coiled Cable Assemblies



#### Tailgate Lift Power Cable

For applications that require direct electrical power to trailer lift gates; BLUE JACKETED

- Rated at 265 amps intermittent service (30 seconds on/50 seconds off)
- Heavy-duty zinc die cast plugs with spring guards included
- 2 gauge cable

Part #	Description
590135	12' Tailgate lift power cable assembly
590136	15' Tailgate lift power cable assembly



#### Tailgate Lift

#### Battery Charging Cable

For applications where cables are used to charge trailer lift gate batteries; GREEN JACKETED, heavy-duty zinc die cast plugs with spring guards included

- 200 amp max for intermittent lift gate applications at 12 VDC
- 110 amp max for continuous applications at 12 VDC
- External ground option
- 4 gauge cable

Part #	Description
590263	12' Tailgate lift battery charging 4 gauge cable assembly
590264	15' Tailgate lift battery charging 4 gauge cable assembly

### Two Pole Coiled Cable Assemblies



- Rated at 200 amps for lift gate applications at 12 VDC
- 4 gauge cable
- Internally grounded
- Withstand temperatures of -85° to +185°F
- Durable black polyethylene outer jacket resists abrasions and chemical damage while offering excellent coil retention
- Heavy-duty zinc die cast plugs with springs guards included

Part #	Description
590171	12' Two pole coiled cable assembly
590172	15' Two pole coiled cable assembly



Call the Velvac Sales Team: **800.783.8871** sales@velvac.com

## SEVEN-WAY COILED CABLE ASSEMBLIES



### Seven-Way ISO Coiled Cable Assemblies

- Used in tractor/trailer systems requiring ISO 3731 style connectors; ISO pin prevents connections with non-ISO sockets
- 1/8, 2/10, 4/12 gauge cable
- Durable yellow outer jacket resists abrasion, provides excellent coil retention and offers quick identification of auxiliary circuit lines
- Heavy-duty zinc die cast plugs with spring guards included

Part #	Working Length	Description
590251	12'	2-12" Leads
590252	15'	2-12" Leads
590253	15'	1-48" Lead 1-12" Lead
590254	15'	1-72" Lead 1-12" Lead



### Seven-Way ABS Coiled Cable Assemblies

- Assemblies include heavy gauge wire commonly used to power trailer and dolly ABS
- 1/8, 2/10, 4/12 gauge cable
- Durable green outer jacket resists abrasion, provides excellent coil retention and offers quick identification of ABS lines
- Heavy-duty zinc die cast plugs with spring guards included
- Cable meets SAE J2394 June 1998 Type F requirements

Part #	Working Length	Description
590160	12'	2-12" Leads
590161	15'	2-12" Leads
590163	15'	1-40" Lead 1-12" Lead
590080	20'	2-12" Leads
590081	20'	1-12" Lead 1-40" Lead

NOTE: See page E7 for ABS color code chart



### Seven-Way Coiled Cable Assemblies

- Durable black outer jacket resists abrasion and provides excellent coil retention
- Heavy-duty zinc die cast plugs with spring guards included
- Operating temperature range of -55° to +185°F

Part #	Working Length	Description
590154	12'	6/12, 1/10 Gauge (2-12" Leads)
590156	12'	6/14, 1/12 Gauge (2-12" Leads)
590155	15'	6/12, 1/10 Gauge (2-12" Leads)
590157	15'	6/14, 1/12 Gauge (2-12" Leads)
590159	15'	6/12, 1/10 Gauge (1-72" Lead, 1-12" Lead)



- ISO assemblies used in tractor/trailer systems requiring ISO 3731 style connectors

Part #	Working Length	Description
590255	12'	1/8, 2/10, 4/12 Gauge
590256	15'	1/8, 2/10, 4/12 Gauge

### Seven-Way Straight Cable Assemblies

- ABS assemblies include heavy gauge wire commonly used to power trailer and dolly ABS - ABS cable meets SAE J2394 June 1998 Type F requirements

Part #	Working Length	Description
590165	12'	1/8, 2/10, 4/12 Gauge
590166	15'	1/8, 2/10, 4/12 Gauge
590179	20'	1/8, 2/10, 4/12 Gauge

- Heavy-duty zinc die cast plugs with spring guards included

Part #	Working Length	Description
590180	5'	6/12, 1/10 Gauge
590036	8'	6/12, 1/10 Gauge
590046	12'	6/12, 1/10 Gauge
590177	10'	6/12, 1/10 Gauge
590178	15'	6/12, 1/10 Gauge

## ELECTRICAL PLUGS

ISO plug



T-grip

Plastic plug with weather guard



### Seven-Way Plugs

- Heavy-duty nickel-plated zinc die cast housings on all except plastic plug, which has an unbreakable nylon housing
- Easy to remove interiors make for quick replacements
- ATA color-coded wire terminals
- Internal clamp holds cable securely in place
- Standard seven-way plugs meet ATA and SAE J560 requirements; ISO plugs meet ISO 3731: 1997 requirements

### T-Grip Seven-Way Plugs

Part #	Description
593057	Plug with spring guard
593101	ISO plug with spring guard
593111	Plastic plug with weather guard
593059	Replacement interior for 593057, 593111
593060	Replacement spring guard

### Single Grip Seven-Way Plugs

Part #	Description
593022	Plug with spring guard
593024	Plug without spring guard
593019	Replacement interior
593029	Replacement spring guard



591161



591105

### Single Pole Plugs

- Used to provide power to heavy draw auxiliary trailer equipment
- Heavy-duty zinc die cast housings
- Power and ground terminals hold up to 1/0 gauge wire

Part #	Description
591161	T-grip plug with spring guard
591105	Single grip plug without spring guard
591109	Replacement interior for 591105



### Seven-Way Blade Type Plug

- Primarily used in RV applications
- Constructed of molded PVC for impact resistance

Part #	Description
054001	Seven-way blade type plug

NOTE: See page E5 for seven-way blade type socket



### Two Pole Plug

- 200 amp, 4 gauge wire capacity
- Heavy-duty zinc die cast housings
- Internal ground
- Spring guard supports and protects cable

Part #	Description
593116	T-grip plug with spring guard

Plug with spring guard



Plug without spring guard



### Four-Way and Six Way Plugs

- Heavy-duty zinc die cast housings
- Plug locking system works with socket door to ensure proper hookup and prevent unintentional disconnections
- Spring guard 055049 supports and protects cable

Part #	Description
055059	Four-way plug with spring guard
055054	Four-way plug without spring guard
055049	Six-way plug with spring guard
055050	Six-way plug without spring guard
055051	Replacement interior for six-way plug



Call the Velvac Sales Team: **800.783.8871** sales@velvac.com



## PLUG ADAPTERS AND ACCESSORIES

Female Pins



591009

Male Pins



591010

591115



591117

591116



### Truck Tractor to Trailer Adapters

- Heavy-duty zinc die cast housing on part nos. 591009 and 591010; also includes split brass pins and terminals and a spring clip to lock adapter and plug together
- Part nos. 591115, 591116 and 591117 constructed of molded PVC for impact resistance

Part #	Description
591009	Seven-way pin to six-way adapter
591010	Six-way round to seven-way adapter
591115	Seven-way blade to four-way flat adapter
591116	Seven-way round to four-way flat adapter
591117	Six-way round to four-way flat adapter



057118



057119



057120



057121

### Continuity Testers

- LED indicators quickly identify complete circuits by glowing red; no light means problem circuit
- Fits standard seven-way blade type, four-way flat connectors and seven-way round
- Constructed of molded PVC for impact resistance
- Internally grounded

Part #	Description
057118	Seven-way plug circuit tester
057119	Seven-way socket circuit tester
057120	Seven-way blade circuit tester
057121	Four-way flat circuit tester



### Four-Way Flat Set

- Set: 48" lead (female) side and 12" lead (male) side
- Single: 48" leads
- Constructed of molded PVC for impact resistance
- ATA color-coded:  
White: Ground  
Green: Right turn and brake lights  
Yellow: Left turn and brake lights  
Brown: Tail lights

Part #	Description
090226*	Four-way flat - female
090227*	Four-way flat - male
	*Together these replace Velvac part no. 054003
054003	Four-way flat set



### Seven-Way Plug Cleaner

- Stainless steel brushes quickly clean electrical contacts for improved conductivity
- Durable plastic body

Part #	Description
055034	Seven-way plug cleaner

**NOTE: Part numbers listed in RED are NEW!**

## ELECTRICAL SOCKETS AND ACCESSORIES

### Seven-Way Circuit Breaker Sockets and Adapter Boxes

- Non-corrosive, reinforced nylon housing for added durability
- Designed for #8 ring terminals (see page E27)
- ATA color-coded contacts (see page E8 for ATA color code chart)
- Solid brass split pins are zinc-plated for corrosion resistance

- Each socket includes automatic reset circuit breakers with positive snap open/snap closed action to eliminate arcing (unless noted)
- Mounting holes are 4-1/2" on center and include steel bushings for added housing protection
- Adhesive-backed mounting gasket included
- Circuit breaker sockets meet SAE J560 requirements



- Durable zinc die cast housings
- Solid brass split pin socket offers replaceable circuit breakers for circuit protection of trailer wiring systems
- Slanted door front for plug support
- Replaceable thermoplastic base plate with ATA color codes for quick identification
- Each socket includes automatic reset circuit breakers with positive snap open/snap closed action to eliminate arcing

Part #	Description
055037	Socket with 20 amp circuit breakers
055038	Socket with 30 amp circuit breakers
055040	Socket without circuit breakers
055039	Replacement cover kit (includes cover, shaft retainer, steel hinge pin and stainless steel spring)
055041*	Deep adapter box with bottom entry
055045*	Deep adapter box with back entry



Deep adapter box with back entry



Deep adapter box with bottom entry

\*5/16" - 18" UNC cover plate studs and 2" inside depth

Part #	Description
593052	Socket with 20 amp circuit breakers
593054	Socket with 30 amp circuit breakers

### Single and Two Pole Sockets

- Durable zinc die cast housings
- Power and ground terminals on single pole socket hold up to 1/0 gauge wire
- 200 amp, 4 gauge wire capacity on two pole socket
- Two pole socket has internal ground
- Single pole socket may be soldered or crimped

- Mounting holes 3" on center
- Rear housing 1-3/4" O.D.

Part #	Description
591113	Single pole socket
593121	Two pole socket
591090	Replacement interior for single pole socket



### Seven-Way Blade Type Socket

- Screw-type socket primarily used in RV applications
- 6-24 VDC
- Mounting holes are 2-1/4" on center
- Constructed of molded PVC for impact resistance

Part #	Description
054002	Seven-way blade type socket
090216	Mounting bracket

NOTE: See page E3 for seven-way blade type plug



Optional mounting bracket



Call the Velvac Sales Team: **800.783.8871** sales@velvac.com

## ELECTRICAL SOCKETS AND ACCESSORIES

Two hole socket with screw terminals



Two hole socket with push terminals



Optional terminal protector boot



593083



Optional terminal protector boot



### ISO Seven-Way Socket

- Used in tractor/trailer systems requiring ISO 3731 style connectors - ISO socket prevents connections with non-ISO plugs
- ISO color-coded yellow, non-corrosive, reinforced nylon housing
- Wires secured by set screws
- Mounting holes are 2-15/16" on center

Part #	Description
593106	ISO socket
054017	Terminal protector boot

### Seven-Way Sockets

- Non-corrosive, reinforced nylon housing for added durability
- Screw type socket with split pins designed for #8 ring terminals (see page E27)
- Push type socket with solid pins designed for 180° snap receptacles (see Part No. 056079 on page E26)
- Mounting holes are 3" on center
- Screw type socket includes screws and washers
- Gasket included on each socket
- Sockets meet SAE J560 requirements
- Protective rubber boot seals out moisture and contaminants - sold separately

- Durable zinc die cast housings
- ABS plastic interior with ATA color codes for quick identification
- Solid brass pins
- Wires attached by set screw retainers
- Slanted door front for plug support
- Tongue and groove door design protects socket interior from dirt and moisture
- Mounting holes are 2-15/16" on center
- 1-13/16" rear housing length
- Terminal protector boot keeps terminals free from moisture and contaminants - sold separately
- Sockets meet SAE J560 requirements

Part #	Description
055043	Two hole socket with screw terminals
055062	Two hole socket with push terminals
055063	Rubber terminal protector boot

Part #	Description
593083	Socket with solid pins
593084	Socket with split pins
054017	Terminal protector boot
591022	Replacement solid pin interior
591019	Replacement cover kit (includes door, hinge pin & spring)



Optional terminal protector boot

### Four-Way and Six-Way Sockets

- Durable zinc die cast housings
- Solid brass split pins
- Locking system on door works with plug to ensure proper hook-up and prevent unintentional disconnections
- Optional protector boot keeps terminals free of moisture and contaminants - sold separately

Part #	Description
055052	Six-way socket
055056	Four-way socket
090217	Mounting bracket
090218	Terminal protector boot
055053	Replacement six-way interior



## ELECTRICAL CABLE



### Battery and Starter Cable

- Durable thermoplastic outer jacket keeps cable flexible at low temperatures and resists abrasion, ozone, oil and road salts
- Soft annealed stranded copper
- Cable meets SAE J1127 Type SGT requirements

#### Red Jacketed

Part #	Coil Length	Wire Gauge
058033	25'	6
058033-7	100'	6
058035	25'	4
058035-7	100'	4
058037	25'	2
058037-7	100'	2
058039	25'	1
058039-7	100'	1
058241	25'	1/0
058241-7	100'	1/0
058243	25'	2/0
058243-7	100'	2/0
058245	25'	3/0
058247	25'	4/0

#### Black Jacketed

Part #	Coil Length	Wire Gauge
058233	25'	6
058233-7	100'	6
058235	25'	4
058235-7	100'	4
058237	25'	2
058237-7	100'	2
058239	25'	1
058239-7	100'	1
058041	25'	1/0
058041-7	100'	1/0
058043	25'	2/0
058043-7	100'	2/0
058045	25'	3/0
058047	25'	4/0

NOTE: Battery terminals and lugs sold separately (see pages E9-11)

### Multiple Conductor Cable

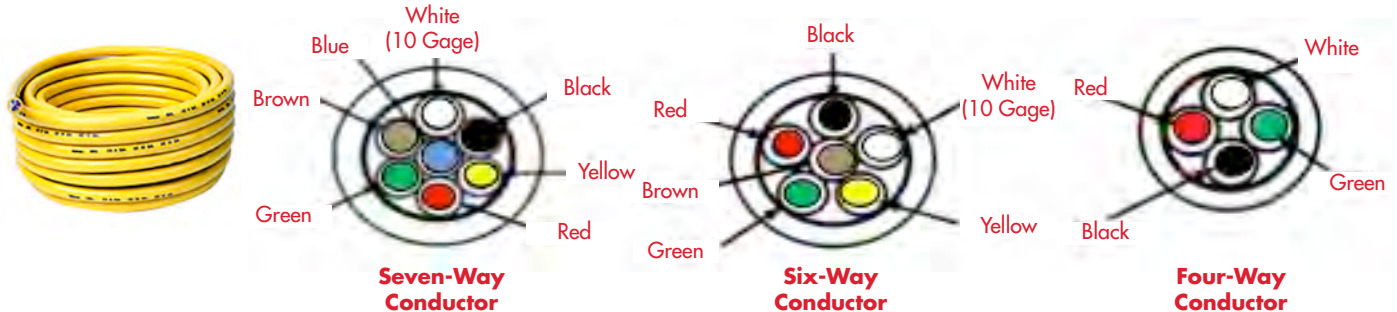

- ABS cable meets SAE J2394 June 1998 Type F requirements

#### ADA Color Code Chart

White	Ground return to towing vehicle
Black	ICC required marker and clearance light
Yellow	Left-hand directional signal
Red	Stoplights
Green	Right-hand directional signal
Brown	Tall lamps, 3-bar marker lamps
Blue	Auxiliary

Part #	Jacket Color	Coil Length	Conductor	Gauge
050019	Black	100'	Seven	6/12, 1/10
050019-7	Black	500'	Seven	6/12, 1/10
050042	Black	100'	Seven	14
050042-7	Black	500'	Seven	14
050037	Green (ABS)	100'	Seven	1/8, 2/10, 4/12
050051	Yellow (ISO)	50'	Seven	1/8, 2/10, 4/12
050052	Yellow (ISO)	100'	Seven	1/8, 2/10, 4/12
050007	Black	100'	Six	14
050007-7	Black	500'	Six	14
050001	Black	100'	Four	14
050001-7	Black	500'	Four	14



Call the Velvac Sales Team: **800.783.8871** sales@velvac.com

## BATTERY CABLE



### Battery-to-Battery Crossover Cable

- 2/0 gauge wire
- Molded lead terminals and black neoprene outer jacket

Part #	Description
058212	12" Battery crossover cable



### Ground Strap

- 4 gauge wire
- Molded zinc-plated steel lugs and tin-plated copper stranding
- 7/16" diameter bolt hole

Part #	Description
058116	Ground strap (12" - 14")



### Battery-to-Battery Crossover Cable

- 4 gauge wire
- Molded zinc-plated steel lugs and red PVC outer jacket

Part #	Description
058115	18" Switch-to-starter cable



### Battery Cable

- 2/0 gauge wire
- Molded copper lug and lead terminal
- Black PVC outer jacket

Part #	Description
058117	12" Battery cable



### Battery Booster Cables

- Copper stranded, 4 gauge wire
- Rated at 400 amps
- Black PVC outer jacket
- Red and black vinyl coated clamps feature solid copper contacts and heavy springs for positive clamping

Part #	Description
058152	16" Battery crossover cable



### 800A Booster Cable

These heavy duty battery cables are rated at 800 amps and are designed to handle jump starting heavy duty equipment

- Solid copper parrot clamps for increased conductivity
- Tangle proof design
- Braided copper wire remains flexible even in subzero temperatures
- Includes strong plastic storage container to protect cables from damage when not in use

Part #	Description
058151	800A Booster cable

### Stud Top Battery Cable

- 2/0 gauge wire
- Molded tin-plated copper lugs and black PVC outer jacket

Part #	Color	Description
058118	Black	8" Stud top battery cable
058128	Red	8" Stud top battery cable
058119	Black	12" Stud top battery cable
058129	Red	12" Stud top battery cable



## BATTERY LUGS

- Fully annealed electrolytic copper construction provides excellent conductivity
- Wire gauge identification marked on lug barrels
- Heat-shrink tubing should be used over all battery terminal connections (see page E32 and E33)

### Standard Battery Lugs

- Unique flared barrel design eliminates wire strand hang-ups
- Unplated
- Crimpable



Part #	Wire Gauge	Stud Size
056033	6	1/4"
058073	6	5/16"
058074	6	3/8"
056034	4	1/4"
058076	4	5/16"
058077	4	3/8"
058078	4	1/2"
058079	2	5/16"
056035	2	3/8"
058081	1	5/16"
056036	1	3/8"

Part #	Wire Gauge	Stud Size
058082	1	1/2"
058083	1/0	5/16"
056037	1/0	3/8"
056038	1/0	1/2"
058084	2/0	5/16"
056039	2/0	3/8"
056040	2/0	1/2"
058086	3/0	3/8"
056041	3/0	1/2"
058088	4/0	3/8"
056042	4/0	1/2"

### Heavy-Duty Battery Lugs

- Tin-plated for corrosion resistance
- Crimpable



Part #	Wire Gauge	Stud Size
058325	1/0	3/8"
058326	1/0	1/2"
058327	2/0	3/8"
058328	2/0	1/2"

Part #	Wire Gauge	Stud Size
058329	3/0	3/8"
058330	3/0	1/2"
058331	4/0	3/8"
058332	4/0	1/2"

### Heavy-Duty Flared Lug Maintenance Kit



- Kit includes 50 lugs in ten varieties ranging from 6 to 4/0 gauge with stud sized of 1/4", 3/8" and 1/2"
- Packaged in a durable plastic case with product information shown on inside label for easy identification

Part #	Description
057002	Heavy-duty flared lug maintenance kit

Part #	Qty	Part #	Qty
056033	6	056038	4
056034	6	056039	4
056035	6	056040	4
056036	6	056041	4
056037	6	056042	4

### Flared Butt Connectors

- Seamless construction
- Tin-plated for corrosion resistance



Part #	Wire Gauge
058020	1
058021	1/0
058022	2/0
058023	3/0
058024	4/0



Call the Velvac Sales Team: **800.783.8871** sales@velvac.com

## BATTERY TERMINALS

### Crimpable or Solderable Battery Terminals

- One-piece, cast copper construction
- Lead-plated for corrosion resistance
- Cable size clearly designated on terminals for correct size selection
- Polarity shown on terminals to avoid mixing positive and negative connections
- Tool die and letter codes permanently marked on terminals to simplify installation with other manufacturers' tools
- Uniform wall thickness assures high reliability when connector is crimped on cable
- Long barrels for added strength and vibration resistance
- Heat-shrink tubing should be used over all battery terminal connections (See page E32)



**Right Angle Barrel Terminals**

Part #	Wire Gauge	Polarity
057056	2/0	Positive
057057	2/0	Negative
058055	3/0	Positive
058056	3/0	Negative
058011	Replacement nut and bolt	

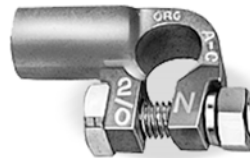

**Right Elbow Terminals**

Part #	Wire Gauge	Polarity
058052	1/0	Positive
058051	1/0	Negative
058005	2/0	Positive
058006	2/0	Negative
058009	3/0	Positive
058010	3/0	Negative
058011	Replacement nut and bolt	

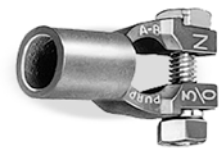

**Straight Barrel Terminals**

Part #	Wire Gauge	Polarity
058050	4	Universal
057050	1	Positive
057051	1	Negative
058001	1/0	Positive
058002	1/0	Negative
057052	2/0	Positive
057053	2/0	Negative
057054	3/0	Positive
057055	3/0	Negative
058057	4/0	Positive
058058	4/0	Negative
058011	Replacement nut and bolt	



**Left Elbow Terminals**

Part #	Wire Gauge	Polarity
058054	1/0	Positive
058053	1/0	Negative
058003	2/0	Positive
058004	2/0	Negative
058007	3/0	Positive
058008	3/0	Negative
058011	Replacement nut and bolt	



**Marine Terminal**

- 5/16" post

Part #	Description
058019	Marine terminal

**Helpful hint:**

Most Velvac terminals are colorcoded according to wire gauge specifications:

- 4 - Green
- 2 - Pink
- 1 - Pink
- 1/0 - Black
- 2/0 - Orange
- 3/0 - Purple
- 4/0 - Yellow



## BATTERY TERMINALS

### ECO-MAX Battery Terminals

- ECO-MAX is the first environmentally friendly, 100% copper battery terminal
- The post top design is manufactured with the highest quality C11000 ETP (Electrolytic Tough Pitch) copper and is completely lead free
- RoHS compliant and therefore exempt from CA Proposition 65 requirements
- C11000 ETP copper battery terminals provide the highest conductivity rating compared to any competing copper design
- Maximum electrical conductivity is 101% IACS at 68°F. Typical designs fall at 20% and 32% IACS at 68°F
- Tin plated for corrosion resistance
- Provided with nut and bolt installed
- Has a beveled barrel for facilitating cable insertion
- Color-coded for polarity identification and color and die coded for crimp settings
- Exceeds SAE Standard J-1811



ECO-Max right elbow



ECO-Max left elbow



ECO-Max flag



ECO-Max straight

Part #	Cable Gauge	Gage ID Color	Polarity	Terminal Style
058416	4	Gray	Negative	Straight
058417	4	Gray	Positive	Straight
058418	4	Gray	Universal	Straight
058419	1-2	Pink	Negative	Straight
058420	1-2	Pink	Positive	Straight
058421	1/0	Black	Negative	Straight
058422	1/0	Black	Positive	Straight
058423	2/0	Orange	Negative	Straight
058424	2/0	Orange	Positive	Straight
058425	3/0	Purple	Negative	Straight
058426	3/0	Purple	Positive	Straight
058427	4/0	Yellow	Negative	Straight
058428	4/0	Yellow	Positive	Straight
058445	1/0	Black	Negative	Flag
058446	1/0	Black	Positive	Flag
058447	2/0	Orange	Negative	Flag
058448	2/0	Orange	Positive	Flag
058449	3/0	Purple	Negative	Flag
058450	3/0	Purple	Positive	Flag
058451	4/0	Yellow	Negative	Flag
058452	4/0	Yellow	Positive	Flag
058437	1/0	Black	Negative	Left elbow
058438	1/0	Black	Positive	Left elbow
058439	2/0	Orange	Negative	Left elbow
058440	2/0	Orange	Positive	Left elbow
058441	3/0	Purple	Negative	Left elbow
058442	3/0	Purple	Positive	Left elbow
058443	4/0	Yellow	Negative	Left elbow
058444	4/0	Yellow	Positive	Left elbow
058429	1/0	Black	Negative	Right elbow
058430	1/0	Black	Positive	Right elbow
058431	2/0	Orange	Negative	Right elbow
058432	2/0	Orange	Positive	Right elbow
058433	3/0	Purple	Negative	Right elbow
058434	3/0	Purple	Positive	Right elbow
058435	4/0	Yellow	Negative	Right elbow
058436	4/0	Yellow	Positive	Right elbow



Call the Velvac Sales Team: **800.783.8871** [sales@velvac.com](mailto:sales@velvac.com)



## BATTERY TERMINALS

### Battery Stud Nut



- Stainless steel construction

Part #	Description
058068	3/8" Battery stud nut

### Heavy-Duty Terminal

- For 1" 4/0 gauge wire



Part #	Description
058016	Heavy duty terminal

### Crimpable or Solderable Terminals for Stud Top Batteries



Base terminal

Part #	Wire Gauge	Polarity
058090	1/0	Universal
058091	2/0	Universal
058092	3/0	Universal
058093	4/0	Universal



Flag terminal

Part #	Wire Gauge	Polarity
058251	1/0	Universal
058252	2/0	Universal
058253	3/0	Universal
058254	4/0	Universal

### Medium-Duty Terminal



- For 6 to 2 gauge wire

Part #	Description
058012	Medium-duty terminal

### Three-Way Battery Terminals

- For 1 to 2/0 gauge wire
- Lead construction with zinc-plated steel bolts and nuts
- Positive and negative terminals included



Part #	Description
058071	Three-way battery terminals

### OEM Battery Bolt

- Recessed groove permits attachment of battery charger or jumper cables
- Zinc-plated steel construction
- 3/8" - 16" UNC
- 1-3/16" long



Part #	Description
058296	OEM battery bolt



### Battery Post and Terminal Cleaner

Part #	Description
058046	Battery post and terminal cleaner

### Side Post Terminal

- For 6 to 2 gauge wire



Part #	Description
058013	Side post terminal

### Stud Mount To-Post Mount Conversion Terminals

- All lead construction
- Both positive and negative posts included



Part #	Description
058017	Stud mount-to-post mount conversion terminals

### Protective Battery Washers

- Washers seal out acid fumes protecting terminals from corrosion
- Packaged in convenient plastic screw top jars



Part #	Description
058094	Protective battery washers - red
058095	Protective battery washers - black

**NOTE: Part numbers listed in RED are NEW!**

## SWITCHES AND SOLENOIDS



### Indicator Lights

- Chrome housing and nylon base
- LED's rated for 15mA at 12 VDC
- 100,000 hours estimated bulb life expectancy
- Temperature rating up to +185°F (85°C)
- 20 AWG lead wires
- 7/16" diameter recommended mounting hole

Part #	Color
090213	Red
090214	Amber
090215	Green



### Wiper Control Switch

- Operating temperature: -20° to +160°F
- Washer motor: 6 amps max. current draw
- Nominal voltage: 12 VDC (9 VDC min., 16VDC max.)
- Terminal configuration: 8 pin amp connector-mates with amp connector 770579-1 and 171639-1 socket terminals (not included and not available from Velvac)
- Integrates multi-speed wiper and washer functions into a single dashboard device
- Backlit for easy identification
- Fits standard 22 mm x 44 mm opening

Part #	Description
090120	Wiper control switch



### Toggle Accessories

- Protect toggle switches from moisture, dust and dirt
- UV-resistant, black silicon construction
- Built-in hex nut base screws on to most Velvac toggle switches
- Rated for -40° to +350°F (+180°C)

Part #	Description
090210	Full boot
090211	Half boot



### License / Utility Lights

- 12 VDC
- Weather-proof gasket
- 31" wire lead with .250" male disconnect
- 89 bulb
- Fits 1-1/4" mounting hole

Part #	Description
090173	Twist-in license / utility light

- Fits GM/GMC trucks with step bumper
- 12 VDC
- 7-7/8" wire lead with protective boot where wire attaches to light and self-grounding single post adapter
- 67 bulb
- Mounting holes approx. 2-11/16" on center



Part #	Description
090174	Bumper mount license / utility light

- Rugged, spring-loaded design provides protection against accident actuation
- Mounting hole accepts all standard Velvac toggles with 15/32" mounting stems



Part #	Description
090212	Safety cover

### Battery Disconnect Switch

- Two position: on/off
- Continuous rating 180 amps (max)
- Momentary rating 1000 amps (max)
- Momentary use only: 15 sec. on/5 min. off
- Heavy gauge, plated steel casing
- Die cast lever
- 3/4" diameter mounting stem
- UL approved for 6 to 36 VDC



090104



090233, 090234

Part #	Description
090104	Battery disconnect switch SPST
090233	Battery disconnect switch DPST
090234	Battery disconnect switch DPST w/ anti-rotation indexing post

### Push Button Switch

- Rated for 50 amps at 12VDC
- 5/8" - 32 UNS mounting bushing for panels up to 1/2" thick
- Push for momentary-on action
- Die cast with silver/copper contacts and two screw terminals
- Dust and moisture resistant
- Boot nut included



Part #	Description
090190	Momentary push button switch



Call the Velvac Sales Team: **800.783.8871** sales@velvac.com

## SWITCHES AND SOLENOIDS

### Heavy Duty Toggle Switches

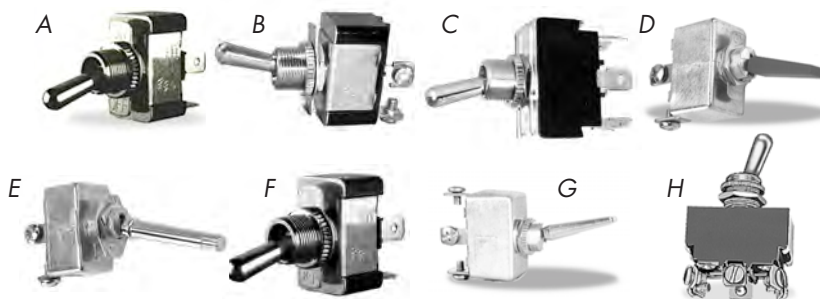

• Frame and support constructed from steel with zinc chromate, brass terminals

• Neoprene-sealed toggles are moisture and dust resistant

- Fully assembled with locating ring/tongue nut (and On/Off faceplate on single pole switches only)
- 1/2" diameter recommended mounting hole- all toggles must be installed with provided hex nut behind panel to prevent damage during installation

Photo	Part #	Poles	Amp	VDC	Circuitry	Terminals	Miscellaneous
Single Pole							
B	090176	SPST	21A	14	On / Off	(2) 0.250" Flat blade	-
A	090177	SPST	21A	14	On / Off	(2) Screw	-
B	090199	SPDT	21A	14	On / Off / On	(3) 0.250" Flat blade	-
A	090200	SPDT	21A	14	On / Off / On	(3) Screw	-
A	090201	SPDT	21A	14	(On) / Off / (On)	(3) Screw	-
A	090202	SPDT	21A	14	On / Off / (On)	(3) Screw	-
F	090191	SPST	30A	12	On / Off	(3) 0.250" Flat blade	Red LED handle****
F	090192	SPST	30A	12	On / Off	(3) 0.250" Flat blade	Green LED handle****
F	090193	SPST	30A	12	On / Off	(3) 0.250" Flat blade	Blue LED handle****
D	090186	SPST	50A	12	On / Off	(2) Screw	Black handle**
D	090187	SPST	50A	12	On / Off	(2) Screw	Red handle**
D	090188	SPST	50A	12	On / Off	(2) Screw	Chrome handle**
E	090189	SPST	50A	6/12/24	On / Off	(2) Screw	1-5/8" Chrome handle
G	090184	SPDT	50A	6/12/24	On / Off / On	(3) Screw	Chrome plated***
-	090040	SPDT	50A	6-24	On / On	(3) Screw	
-	090043	SPDT	50A	6-24	(On) / Off / (On)	(3) Screw	
Double Pole							
A	090203	DPST	21A	14	On / Off	(4) Screw	
C	090204	DPST	21A	14	On / Off	(4) 0.250" Flat blade	
H	090048	DPDT	21A	14	On / On	(6) Screw	
C	090205	DPDT	21A	14	On / On	(6) 0.250" Flat blade	
C	090206	DPDT	21A	14	On / Off / On	(6) 0.250" Flat blade	
A	090208	DPDT	21A	14	(On) / Off / (On)	(6) Screw	
C	090209	DPDT	21A	14	(On) / Off / (On)	(6) 0.250" Flat blade	
"O" Ring Sealed							
A	090179	SPST	21A	14	On / Off	(2) Screw	
A	090194	SPST	21A	14	(On) / Off	(2) Screw	
A	090196	SPDT	21A	14	On / On	(3) Screw	
A	090197	SPDT	21A	14	On / Off / On	(3) Screw	
B	090198	SPDT	21A	14	On / Off / On	(3) 0.250" Flat blade	
A	090207	DPDT	21A	14	On / Off / On	(6) Screw	

( ) indicates MOMENTARY ACTION

\*\* Die cast housing with silver-plated contacts, heavy copper terminals, stems measure 15/32" dia. X 15/32" long

\*\*\* Paddle type handle

\*\*\*\*Black toggle handles tipped with LED, min draw requirements for LED is 20 mA at 12 VDC

## SWITCHES AND SOLENOIDS

### Two-Speed Axle Switch and Automatic Terminal Block Switch

- Terminal block switch used in conjunction with axle switch to control two-speed electric axle shift
- Axle switch has red knob and uses (3) .156" female snap plugs (see page E25)



Terminal block switch

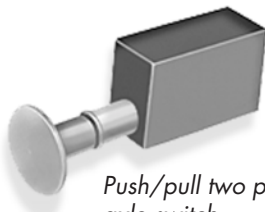

Push/pull two position axle switch



090225



090085

### Three Wire Connector

- Use as a flasher socket or any other three wire application (see page E19 for flashers)
- 18 gauge 12" leads

Part #	Description
090078	Two-speed axle switch
090079	Automatic terminal block switch

Part #	Description
090225	Three wire connector
090085	Three wire socket

### Dimmer Switches and Socket Assemblies



#### Application

- Chrysler floor mounted (1841895, 1881938, 2097628, 2291202, CH-2437)  
Year: 1959-83
- Dodge Trucks  
Year: 1959-79
- AMC (3156124, 3160926)  
Year: 1959-83

Part #	Description
090073	Dimmer switch
090083	Dimmer switch socket assembly



#### Application

- All Ford floor mounted  
Year: 1959-83 (COTF-130A024A; COTZ-13A024A, SW-263)

Part #	Description
090081	Dimmer switch
090083	Dimmer switch socket assembly



#### Application

- Vehicles without auto dimmer
- All GM floor mounted (1997028, 1997037, 3841892, D808)  
Year: 1961-83
- All Jeep floor mounted (5461816)  
Year: 1974-82

Part #	Description
090080	Dimmer switch
090082	Dimmer switch socket assembly

### Universal Solenoids

- Designed to operate a minimum of 50,000 cycles
- 125 amps at 12 VDC
- Continuous voltage
- SPST, normally Off, one circuit Off/On
- 5/16" side studs, #10 top stud/s
- Both include hardware

Part #	Description
090054	Three stud universal solenoid
090056	Four stud universal solenoid



Call the Velvac Sales Team: **800.783.8871** sales@velvac.com



## SWITCHES AND SOLENOIDS

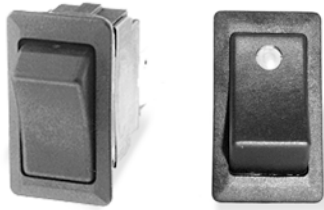

Standard

Lighted

- 21 amps at 14 VDC
- .830" x 1.450" recommended mounting hole
- Universal, snap-in design allows for easy installation
- Moisture and dust resistant
- Packaging for all new switches displays easily on pegboards or wire display rack (see Retail section)

### Full Size Rocker Switches (Standard)

Part #	Poles	Circuitry	Terminals
090109	SPST	On / Off	(2) .250" Flat blade
090150	SPST	(On) / Off	(2) .250" Flat blade
090147	SPST	On / (Off)	(2) Screw
090153	SPDT	On / (On)	(3) Screw
090111	DPST	On / Off	(4) .250" Flat blade
090149	DPST	On / (Off)	(4) Screw
090136	DPDT	On / On	(6) .250" Flat blade
090110	DPDT	On / Off / On	(6) .250" Flat blade
090158	DPDT	On / Off / (On)	(6) .250" Flat blade
090159	DPDT	On / Off / (On)	(6) Screw

( ) indicates MOMENTARY ACTION

### Accessories

Part #	Description
090219	End bracket
090220	Middle bracket
090221	Single bracket
090222	Panel plug

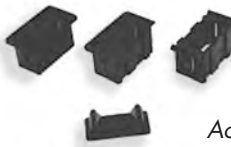

Accessories

### Full Size Rocker Switches (Lighted)

Part #	Poles	Circuitry	Terminals	Light Color
090123	SPST	On / Off	(3) Screw	Red
090124	SPST	On / Off	(3) Screw	Green
090125	SPST	On / Off	(3) Screw	Amber
090128	SPST	On / Off	(3) .250" Flat blade	Red

### On / Off Round Rocker Switch

- Single pole switches rated for 10 amps at 12 VDC
- 12 VDC illumination voltage
- Snap-in mounting design for easy installation in .79" diameter mounting hole
- (3) .187" flat blade terminals
- Two positions (SPST) with two .187" silver-plated brass blade terminals
- On/Off designation permanently etched on rocker switch
- Snap-in mounting design for easy installation in .79" diameter mounting hole

Part #	Poles	Light Color
090167	SPST	Red
090168	SPST	Amber
090169	SPST	Green

Part #	Description
090166	Round rocker switch with On/Off markings



090166

**NOTE: Part numbers listed in RED are NEW!**



## SWITCHES AND SOLENOIDS



Keys included

### Universal Ignition Switch

- Single throw ignition
- 6 to 24 VDC
- 3/4" diameter mounting stem with two terminals

Part #	Description
090076	Universal ignition switch

### Push / Pull Switches

- Rated for 15 amps at 12 VDC, 25 amps at 6 VDC
- Heavy-duty, two position (SPST) push/pull switch with two brass screw terminals
- Brass and chrome construction
- 3-1/8" overall length x 7/8" wide
- Mounting stem measures 3/8" in diameter and 1-1/4" long
- Accommodates 1" panel with stainless steel springs

Part #	Description
090181	Push / pull switch



- Rated for 75 amps at 6 to 28 VDC
- Heavy-duty, two position (SPST) push/pull switch with two brass screw terminals
- Chrome-plated metal knob
- Mounting stem measures 15/32" in diameter and 5/8" long

Part #	Description
090180	Push / pull switch

## RELAYS

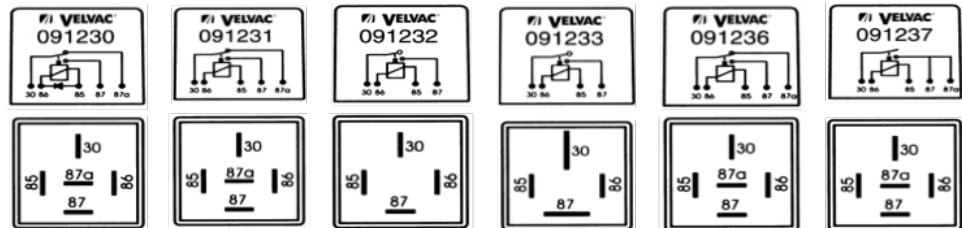

### Heavy-Duty Relay Kit

- Ideal for powering accessories with high voltage draws such as fog lights, power windows and fans
- Help ensure maximum power available to accessories and lights
- Kit includes heavy-duty relay, switch, switch mounting plate, 20' of 14 gauge wire and terminals

Part #	Description	Voltage	Amp	Terminals	Mounting Tab
091230	Relay with diode	12	40	5	No
Application for 091230: Diode eliminates voltage spikes that can occur when the relay is shut off; it can be used to run up to 30 amps continuously					
091231	Relay	12	40	5	Yes
091232	Relay	12	40	4	Yes
Application for 091232: Used to run up to 30 amps continuously					
091236	Relay	24	20	5	Yes
091237	Dual relay	12	40	5	Yes
Application for 091237: Controls two separate 20 amp accessories; also used as a single 40 amp relay					
091233	Heavy-duty relay	12	70	4	Yes
Application for 091233: Ideal for controlling larger devices; can run up to 50 amps continuously					
091235	Heavy-duty relay kit	12	70	4	Yes
In addition to standard package of one, all relays may also be ordered in bulk shop packs of 25 by adding a -7 to the part number shown					



Call the Velvac Sales Team: **800.783.8871** sales@velvac.com

## SIGNAL FLASHERS

### Electro-Mechanical and Electronic Flashers

- Designed and tested to perform in excess of one million cycles
- Audible signal indicates that flasher is activated
- Non-polarity sensitive
- 12 VDC operating range



Style A  
electro-mechanical



Style B  
electronic



### Solid State LED Flasher

- 6 amp flasher provides constant flash rate of 90 FPM for new LED lights
- Compact size fits standard two terminal flasher footprint - includes remote mount 36" long ground wire

Part #	Description
091225	Solid state LED flasher



Part #	Style	Terminals	Color	Lamp Rating	Flash Rate FPM	Amp Rating
091215	A	2	Clear smoke	1-10	60-120	25
091216	A	3	Clear smoke	1-10	60-120	25
Applications for 091216: Fits most American cars, older import cars and light trucks						
091208	B	2	Red	2-12	70-120	25
091209	B	3	Clear smoke	2-12	70-120	25
Applications for 091209: Straight truck, single trailer, high flasher usage						
091210	B	2	Clear smoke	2-16	70-120	35
091211	B	3	Clear smoke	2-16	70-120	35
Applications for 091211: Straight truck, single or double trailer or any vehicle with high flasher usage						
091212	B	2	Clear smoke	2-20	70-120	45
091213	B	3	Black	2-20	70-120	45
Applications for 091213: Severe duty, double or triple trailers or vehicles where flasher is frequently used						
091214	B	3	Clear smoke	10 Lamps / Side*	60-120	25
Application for 091214: Alternating "Wig-Wag" headlight application for emergency vehicles and school buses						

\*10 lamps per side (1156, 1157) or 4 (H4651) sealed beams  
See page E15 for three wire flasher socket Part No. 090225

### Thermal Flashers

- Flash two to three lamps for turn signals, two to six lamps for hazard warning

Part #	Description
091203	Two terminal
091204	Three terminal



### Heavy-Duty Flashers

- 12 lamp and 25 amp rating
- Last five times longer than thermal flashers
- Three-terminal flasher for vehicles equipped with flashing dash lights
- Operate at voltages as low as 7 VDC

Part #	Description
091201	Two terminal
091202	Three terminal

#### NOTES

A thermal flasher (fixed load) is NOT recommended for use when a trailer is connected to a car or truck. A heavy-duty flasher (variable load) is recommended duty for this type of application

Dash "- xx" indicates package quantity

## CIRCUIT BREAKERS

### Standard Circuit Breakers



- Copper colored battery stud provides easy identification
- "Waterproof" sealant and insert molded studs on waterproof breakers make them suitable for marine applications and trailer connections
- 12 VDC
- Meets applicable SAE J553 requirements
- Each circuit breaker includes two #10-32 nuts

Part # w/o mounting strap	Part # w/ mounting Strap	Amp
091011	091051	10
091015	091052	15
091020	091053	20
091025	091054	25
091030	091055	30
091040	091056	40
091050	091057	50

### ATM and MAXI™ Circuit Breaker



- Replacement for ATM/MINI® and MAXI™ blade type fuses
- 12 VDC, rated 5 to 30 amps
- -40°F (-40°C) to 185°F (85°C) operating temperature range
- ATM/MINI® Type II Modified Reset type breakers and MAXI™ Type I Automatic Reset type breakers meet applicable SAE J553 requirements

ATM/Mini® Part #	Maxi™ Part #	Amp
091500-3	-	5
091501	091510-10	10
091502	091511-10	15
091503	091512-10	20
091504	091513-10	25
091505	091514-10	30

### Fuse Clip Circuit Breakers



- Replacement for 1/4" x 1-1/4" glass fuses
- 12 VDC
- -25°F (-32°C) to 180°F (82°C) operating temperature range
- Type II Modified Reset type breakers meet SAE J553 requirements

Part #	Amp
091080	10
091081	15
091082	20
091083	30



### High Amp Circuit Breaker

- Type III switchable breaker typically used in auxiliary and accessory circuits for trucks, buses, RVs and marine applications
- Flush mount with sems nut installed
- 30 VDC
- -25°F (-32°C) to 180°F (82°C) operating temperature range
- Measures 2" x 3" overall
- Meets SAE J1625 requirements

Part #	Description
091005	60 High amp
091006	80 High amp
091007	100 High amp
091008	120 High amp
091003	150 High amp
091004	Economic 150 amp

### Fuse and Fuse Block

- Isolates faults in equipment such as lift trucks and other battery operated systems
- Silver plated copper link visible through a mica window

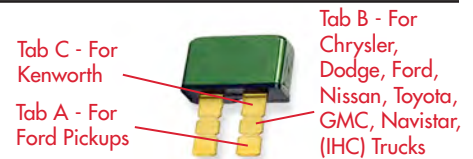

### Universal Snap-off Blade Type Circuit Breakers

- Replacement for ATC/ATO® blade type fuses
- Color-coded for easy identification
- 12 VDC
- -40°F (-40°C) to 185°F (85°C) operating temperature range
- Type I Automatic Reset type breakers meet applicable SAE J553 requirements

Part #	Amp	Color
091076	6	Silver
091071	10	Red
091072	15	Blue
091073	20	Yellow
091074	25	Silver
091075	30	Green

### Mack / Navistar Plug-In Circuit Breakers



- Fits Mack and Navistar breaker blocks
- 12 VDC
- -10°F (-23°C) to 150°F (65°C) operating temperature range
- Type II Modified Reset type breakers meet SAE J553 requirements

Mack Part #	Navistar Part #	Amp
091520	091530	10
091521	091531	15
091522	091532	20
091523	091533	25
091524	091534	30



Part #	Description
091351	ANL style fuse, 300 amp
091350	Fuse block for ANL style fuses



Call the Velvac Sales Team: **800.783.8871** sales@velvac.com

## FUSES AND ACCESSORIES

### AGC, AGX and SFE Fuses

AGC Part #	AGX Part #	SFE Part #	Amp
091131-5	-	-	1
091132-5	-	-	2
091133-5	-	-	3
091135-5	-	-	5
091137-5	-	-	7 1/2
091140-5	-	-	10
091141-5	-	-	15
091142-5	See below	091171-5	20
091143-5	-	-	25
091144-5	See below	091172-5	30

### AGX Fuse Assortments

Part #	Description
091251	AGX 20-30 amp assortment

Includes (2) 20 amp, (2) 25 amp and (2) 30 amp AGX fuses

#### NOTES

Dash "- xx" indicates package quantity

\* In addition to display card packaging, fuses may also be ordered in bulk packs of 25 by adding a -25 to the part number



### Electrical Junction Box

- Measures 6-9/16" x 3-1/4"
- Includes all fasteners and grommets

Part #	Description
055060	Electrical junction box



AGC 1-30 / SFE 20, 30  
AGC 20, 30



ATC/  
ATO®



ATM/  
MINI®



MAXI™

### ATC/ATO®, ATM/MINI® and MAXI™ Fuses

ATC/ATO®	ATM/MINI®	MAXI™	Amp	Color
-	091300-5	-	2	Gray
091173-5	091301-5	-	3	Violet
091174-5	091302-5	-	4	Pink
091175-5	091303-5	-	5	Tan
091177-5	091304-5	-	7-1/2	Brown
091180-5*	091305-5*	-	10	Red
091181-5*	091306-5*	-	15	Blue
091182-5	091307-5*	091400-5	20	Yellow
091183-5*	091308-5*	-	25	Clear
091184-5*	091309-5*	091401-5	30	Green
-	-	091402-5	40	Orange
-	-	091403-5	50	Red
-	-	091404-5	60	Blue
-	-	091406-3	80	Natural



### ATC/ATO® Fuse Panel

- Accepts blade-type fuses, auto or manual reset circuit breakers
- 6 circuits, 30 amps per circuit with quick connect terminals
- No top cover needed; recessed fuse contacts provide touch-safe protection
- Black thermoplastic construction - temperature rating of -20°F (29°C) to +150°F (65°C)
- Fuses/circuit breakers sold separately

Part #	Description
091427	ATC/ATO® fuse panel



### ATC/ATO® Fuse Assortment with Combination Fuse Tester/Puller

- Assortment contains 42 ATC fuses - seven each of the six most popular fuses from 5 to 30 amps
- Combination fuse tester/puller tests and removes blade type and a variety of glass fuses
- Reclosable heavy-duty display pkg.

Part #	Description
091254	Fuse assortment with tester



## FUSES AND ACCESSORIES



### Universal In-Line Fuse Holder

- Universal nylon twist-lock fuse holder for 1/4" x 1-1/4" AGC, AGA, AGW, AGX and SFE fuses
- 20 amp maximum load
- 14 gauge lead wire
- Fuse sold separately

Part #	Description
091188	Universal in-line fuse holder



### Heavy Duty In-Line Fuse Holder

- Nylon heavy duty fuse holder for 1/4" x 1-1/4" glass fuses
- 30 amp maximum load
- 12 gauge lead wire
- Includes one 30 amp AGC fuse installed

Part #	Description
091189	Heavy duty in-line fuse holder w/ 30 amp AGC fuse



### Heavy Duty ATC/ATO® In-Line Fuse Holders

- Fits blade type fuses from 3 to 30 amps
- 12 gauge lead wire
- Part No. 091130 includes one 30 amp ATC fuse

Part #	Description
091190	Heavy duty ATC/ATO® in-line fuse holder w/o fuse
091130	Heavy duty ATC/ATO® in-line fuse holder w/ 30 amp ATC Fuse



### ATM/MINI® In-Line Fuse Holder with Cover

- Fits ATM/MINI® blade type fuses from 2 to 30 amps
- 12 gauge lead wire
- Cover provides protection from harsh under-the-hood environmental elements
- Fuse sold separately

Part #	Description
091426	ATM/MINI® In-line fuse holder with cover



### MAXI™ In-Line Fuse Holder with Cover

- Fits MAXI blade type fuses from 20 to 60 amps
- 8 gauge lead wire
- Cover provides protection from harsh under-the-hood environmental elements
- Fuse sold separately

Part #	Description
091425	MAXI In-line fuse holder with cover



091325

091326

### Add-A-Circuits

- Converts one circuit into two fuse protected circuits; plugs into fuse-block and accepts two fuses to provide protection for the existing circuit and the add-on circuit
- 10 amp maximum circuit load
- Fuse sold separately

Part #	Description
091325	ATM/MINI® Add-a-circuit
091326	ATC/ATO® Add-a-circuit

### Self-Stripping ATC/ATO® Fuse Holder

- For use with ATC/ATO® blade type fuses up to 30 amps
- Easily attaches to wires ranging from 18 to 14 gauge
- Fuse sold separately



Part #	Description
057003	Self-stripping ATC/ATO® fuse holder

In-line fuse holders (except MAXI) and add-a-circuits are display carded to fit on display rack in Retail section



Call the Velvac Sales Team: **800.783.8871** sales@velvac.com



## FUSES AND ACCESSORIES

### Fuse Kits



Part #	Description
091001	ATM/MINI® and MAXI fuse kit
091002	ATC/ATO®, AGC and ATM/MINI® fuse kit

- Convenient, pre-packaged fuse assortments save time by keeping popular sized fuses close at hand
- Durable, see-through plastic cases with handy "locator" cards are easy to refill for using over and over
- Multi-functional kits can be displayed on the front counter to attract the impulse sale of single fuses or used as mini storage systems to save time and money by eliminating multiple trips to the shop for additional parts

### ATM/MINI® and MAXI™ Fuse Kit

ATM/MINI®	MAXI™	Qty	Amp
091300	-	10	2
091301	-	10	3
091303	-	10	5
091304	-	10	7-1/2
091305	-	10	10
091306	-	10	15
091307	-	10	20
091308	-	10	25
091309	-	10	30
-	091400	5	20
-	091401	5	30
-	091402	5	40
-	091403	5	50
-	091404	5	60
-	091406	3	80

### ATC/ATO®, AGC and ATM/MINI® Fuse Kit

AGC	ATM/MINI®	AGC	Qty	Amp
091133	-	-	10	3
091135	-	-	10	5
091140	-	-	10	10
091141	-	-	10	15
091142	-	-	10	20
091144	-	-	10	30
-	091303	-	10	5
-	091305	-	10	10
-	091306	-	10	15
-	091307	-	10	20
-	091308	-	10	25
-	091309	-	10	30
-	-	091175	10	5
-	-	091180	10	10
-	-	091181	10	15
-	-	091182	10	20
-	-	091183	10	25
-	-	091184	10	30

#### Did you know...

Federal Motor Carrier Safety Regulation 393.95 requires every bus, truck, truck tractor and a drive-away towaway operation to carry a replacement fuse for each kind and size in the vehicle?

## TERMINALS AND CONNECTORS

### Crimp Terminals and Connectors

- One-piece construction assures maximum electrical conductivity
- Electro bright, tin-plated annealed copper construction for maximum corrosion resistance
- Injection-molded insulation allows a funnel barrel construction for easy installation and ensures a consistent wall thickness for maximum reliability after crimping
- Crimp ridge on each terminal for positive location of crimp tool on terminal barrel means fewer mis-crimps
- Open end terminal design permits easy inspection of wire
- Designed to withstand temps of -40° to +221°F (+105°C)
- Heat-shrink tubing and electrical tape available and sold separately (see pages E32, E33 and E36)



**Velvac offers a wide variety of terminals and connectors. For the same application the following terminals may be available: crimp, crimp and seal, crimp/solder/seal, snap or heatless connectors**

### Crimp and Seal Terminals and Connectors

Simple three step installation reduces wiring time and costs



- Heat-shrink terminals combine color-coded, heat-shrink tubing with one-piece solderless terminals to produce fast, watertight, corrosion resistance cutwire connections
- UL approved
- Improved mechanical performance provides improved pull-out strength and strain relief
- Designed to withstand temperatures of -67°F (-55°C) to +221°F (+150°C)
- Electrical tape and heat gun available and sold separately (see page E36)
- Resist abrasion, scoring, cut-through and the effects of long term aging



STEP 1: STRIP copper wire

STEP 2: INSERT wire into sealing gel. Rotate to coat wire

STEP 3: RE-INSERT wire until insulation contacts connector. CRIMP connector



### Crimp/Solder/Seal Terminals and Connectors

- Pre-inserted solder terminals reduce installation time and increase efficiency, while achieving the benefits of both crimp terminals and solder terminals
- Each terminal contains solder for increased strength and conductivity
- Adhesive-lined heat shrink tubing seals out moisture and contaminants
- Wire gauge is printed on each connector for easy ID

### Heatless Terminals and Connectors-Revolutionary New Product

- A heatless, solder-less terminal utilizing a revolutionary anaerobic sealing technology requires NO HEAT
- Simply strip the wire and crimp, activating the sealant that reacts when the copper wire is inserted into the connector to create an environmentally sealed connection
- Easily installs in a fraction of the time of comparable heat seal connectors



- Prevents the ingress of moisture and air that can result in corrosion
- Nylon insulation provides maximum abrasion and puncture resistance while remaining seamless
- Reduces overall installation costs by eliminating the need for torches or heat guns, reducing the installation time and improving productivity



Call the Velvac Sales Team: **800.783.8871** [sales@velvac.com](mailto:sales@velvac.com)

© VELVAC INC. • 2405 South Calhoun Road • New Berlin, WI 53151-2709 • Toll Free: 800.783.8871 • Fax: 262.786.4101

## TERMINALS AND CONNECTORS

### Butt Splices



#### Crimps

Part #	Wire Gauge	Insulation
056051-50*	22-18	Vinyl-butted
057085-50	22-18	Nylon-smls**
056052-50*	16-14	Vinyl-butted
057086-50*	16-14	Nylon-smls**
056053-50*	12-10	Vinyl-butted
057087-50*	12-10	Nylon-smls**



Part #	Wire Gauge	Insulation
058362-50*	22-18	None
058028-50*	16-14	None
058029-50*	12-10	None

#### Brazed seam



Part #	Wire Gauge	Insulation
056054-10	8	Vinyl
056055-10	6	Vinyl
056056-10	4	Vinyl

Part #	Wire Gauge	Insulation
055106-10	22-18	Nylon
055107-10	16-14	Nylon
055108-10	12-10	Nylon

#### Helpful hint:

Terminal insulation is color-coded according to wire gauge specifications:

Red 22 - 18 AWG, 8 AWG  
 Blue 16 - 14 AWG, 6 AWG  
 Yellow 12 - 10 AWG, 4 AWG

#### Crimp/Seal

Part #	Wire Gauge	Insulation
055067-10	26-22	Nylon
058312-50*	22-18	Heat shrink
055075-10	22-18	Nylon & copper
055075-50	22-18	Nylon & copper
058313-40*	16-14	Heat shrink
055076-10	16-14	Nylon & copper
055076-50	16-14	Nylon & copper
058314-40*	12-10	Heat shrink
055077-10	12-10	Nylon & copper
055077-50	12-10	Nylon & copper
055068-10	8	Nylon

#### NOTES

Dash - "x" indicates package qty

\* Clam shell with quantity of ten (10) also available by adding "-10" to the base six digit number

\*\* Seamless



#### Step Down Splices

Part #	Wire Gauge	Tube Color
055069-10	22-18/16-14	Blue
055070-10	16-14/12-10	Yellow
055071-10	12-10/8	Pink

#### Crimp/Solder/Seal

Part #	Wire Gauge	Insulation
056144-25	22-18	Heat shrink
056145-25	16-14	Heat shrink
056146-25	12-10	Heat shrink



#### Heatless

Part #	Wire Gauge	Insulation
056111-5	22-18	Nylon
056111-100	22-18	Nylon
056112-5	16-14	Nylon
056112-100	16-14	Nylon
056113-5	12-10	Nylon
056113-100	12-10	Nylon

**NOTE: Part numbers listed in RED are NEW!**

## TERMINALS AND CONNECTORS

### Spade Connectors



Block spade



### Crimp

Wire Gauge	Crimp Part #	Stud Size, Insulation	Crimp Part #	Stud Size, Insulation
22-18	056043-50	8-10, Vinyl	056046-50	4-6, Vinyl
22-18	-	-	058345-50	6, Nylon
22-18	-	-	055114-10	6, Nylon
22-18	-	-	055115-10	10, Nylon
16-14	056044-50	8-10, Vinyl	056047-50*	4-6, Vinyl
16-14	057082-50	8-10, Nylon	057084-50	4-6, Nylon
16-14	-	-	055125-10	10, Nylon
12-10	056045-50	8-10, Vinyl	055135-10	10, Nylon
12-10	057083-50	8-10, Nylon	-	-

### Crimp/Seal

Part #	Wire Gauge	Stud Size
058309-50	22-18	8-10
055078-10	22-18	6
055079-10	22-18	10
058335-50	16-14	6
058310-50	16-14	8-10
058336-50	16-14	1/4"
055080-10	16-14	6
055081-10	16-14	10
058311-50	12-10	8-10
058337-50	12-10	1/4"
055082-10	12-10	10
055083-10	12-10	1/4"

### Crimp/Solder/Seal

Part #	Wire Gauge	Stud Size
056155-25	22-18	10
056156-25	16-14	10
056157-25	12-10	10



### Snap Terminals and Connectors

Plugs -  
butted seam



Receptacles -  
butted



Spades -  
butted



Receptacles -  
double



Wire Gauge	Part #	Snap Dia. Insulation	Part #	Snap Dia. Insulation	Part #	Stud Size Insulation	Part #	Snap Dia. Insulation
22-18	058338-50	0.156", Nylon	056076-50	0.156", Nylon	-	-	056080-50	0.157", Vinyl
16-14	058340-50*	0.156", Nylon	056078-50	0.156", Nylon	057092-50	8, Vinyl	-	-

### Male/Female Bullet Connections

Part #	Wire Gauge	Type	Insulation
055104-10	16-14	Male	Nylon
055105-10	16-14	Female	Nylon
055116-10	22-18	Male	Nylon
055117-10	22-18	Female	Nylon
055126-10	16-14	Male	Nylon
055127-10	16-14	Female	Nylon



Call the Velvac Sales Team: **800.783.8871** sales@velvac.com



## TERMINALS AND CONNECTORS

### Ring Tongue Connectors

#### Crimp



Butted seam



Hooked tongue - butted seam



Brazed seam

Wire Gauge	Crimp Part #	Stud Size, Insulation
22-18	056001-50	4-6, Vinyl
22-18	056002-50	8-10, Vinyl
22-18	056003-50	12-1/4", Vinyl
22-18	055109-10	6, Nylon
22-18	055110-10	10, Nylon
22-18	055111-10	1/4", Nylon
22-18	055112-10	5/16", Nylon
22-18	055113-10	3/8", Nylon
16-14	056004-50	4-6, Vinyl
16-14	057075-50	4-6, Nylon
16-14	057076-50*	8-10, Nylon
16-14	056006-50*	12-1/4", Vinyl
16-14	057077-50	12-1/4", Nylon
16-14	056007-50*	5/16"-3/8", Vinyl
16-14	057078-50	5/16"-3/8", Nylon
16-14	055120-10	6, Nylon
16-14	055121-10	10, Nylon
16-14	055122-10	1/4", Nylon
16-14	055123-10	5/16", Nylon
16-14	055124-10	3/8", Nylon
12-10	056008-50*	8-10, Vinyl
12-10	057079-50	8-10, Nylon
12-10	056009-50*	12-1/4", Vinyl
12-10	057080-50	12-1/4", Nylon
12-10	056010-50	5/16", Vinyl
12-10	057081-50	5/16", Nylon
12-10	056011-50*	3/8", Vinyl
12-10	056012-50	7/16"-1/2", Vinyl
12-10	055130-10	10, Nylon
12-10	055131-10	1/4", Nylon
12-10	055132-10	5/16", Nylon
12-10	055133-10	3/8", Nylon
12-10	055134-10	1/2", Nylon

Wire Gauge	Crimp Part #	Stud Size, Insulation
16-14	056049-50	4-6, Vinyl

Wire Gauge	Crimp Part #	Stud Size, Insulation
8	058349-50	8-10, Nylon
8	058350-50	12-1/4", Nylon
8	058351-50	5/16"-3/8", Nylon
8	058352-50	7/16"-1/2", Nylon
6	058353-50	12-1/4", Nylon
6	058354-50	5/16"-3/8", Nylon
6	058355-50	7/16"-1/2", Nylon
4	058356-50	12-1/4", Nylon
4	058357-50	5/16"-3/8", Nylon
4	058358-50	7/16"-1/2", Nylon

#### NOTES

Dash - "x" indicates package qty

\* Clam shell with quantity of ten (10) also available by adding "-10" to the base six digit number

**NOTE: Part numbers listed in RED are NEW!**



## TERMINALS AND CONNECTORS

### Ring Tongue Connectors

Continued

#### Crimp/Seal



Part #	Wire Gauge	Stud Size
058334-50	22-18	6
058301-50	22-18	8-10
055064-10	22-18	6, 8, 10
055084-10	22-18	6
055085-10	22-18	8
055086-10	22-18	10
055087-10	22-18	1/4"
055088-10	22-18	5/16"
058302-50	16-14	4-6
058304-50	16-14	1/4"
058305-50	16-14	5/16", 3/8"
055065-10	16-14	6, 8, 10
055089-10	16-14	8
055090-10	16-14	10
055091-10	16-14	1/4"
055092-10	16-14	5/16"
055093-10	16-14	3/8"
058306-50	12-10	8-10
058307-50	12-10	1/4"
058308-50	12-10	5/16", 3/8"
055066-10	12-10	6, 8, 10
055094-10	12-10	10
055095-10	12-10	1/4"
055096-10	12-10	5/16"
055097-10	12-10	3/8"

#### Crimp/Solder/Seal



Part #	Wire Gauge	Stud Size
056147-25	22-18	10
056149-25	16-14	1/4"
056150-25	16-14	3/8"
056151-25	12-10	10
056152-25	12-10	1/4"
056153-25	12-10	3/8"
056154-25	12-10	1/2"

#### NOTES

Dash - "x" indicates package quantity

\*Clam shell with quantity of ten (10) also available by adding "-10" to the base six digit number

### Three and Four Way Connectors



Three-way butted

Four-way butted

Wire Gauge	Four-Way #	Insulation	Three-Way #	Insulation
22 - 18	058346-10	Vinyl	058363-10	Vinyl
16 - 14	056084-10	Vinyl	056082-10	Vinyl
12 - 10	-	-	056083-10	Vinyl

### Pig Tails



Wire Gauge	Part #	Insulation
22 - 18	056184-50*	Nylon
16 - 14	056185-50*	Nylon
12 - 10	056186-50*	Nylon

### Wire Nuts



Part #	Size	Color
058364-50	71B	Grey
058365-50	72B	Blue
058366-40	73B	Orange
058367-10	74B	Yellow



Self strip connector

Part #	Wire Gauge
056093-50*	18-14
056094-10	12-10 Run, 18-14 Tap



Call the Velvac Sales Team: **800.783.8871** sales@velvac.com

## TERMINALS AND CONNECTORS

### Male Quick Slide Terminals And Connectors - Tab Width .250"

#### Crimp



Butted seam - fully insulated



Butted seam

Wire Gauge	Part #	Insulation	Part #	Insulation
22-18	056069-50	Nylon	056063-50	Vinyl
22-18	055098-10	Nylon	-	-
16-14	056070-50	Nylon	056064-50*	Vinyl
16-14	-	-	057090-50	Nylon
16-14	055100-10	Nylon	-	-
12-10	056071-50	Nylon	056065-50*	Vinyl
12-10	-	-	057091-50	Nylon
12-10	055102-10	Nylon	-	-



Double male to female

056088-50

None



90° Flag butted seam

056086-50

None

#### Crimp/Seal



Fully insulated

Wire Gauge	Part #	Insulation
22-18	058315-40	Ht Shrink
16-14	058316-40	Ht Shrink
12-10	058317-10	Ht Shrink
22-18	055118-10	Nylon
16-14	055128-10	Nylon
12-10	055136-10	Nylon

#### Crimp/Solder/Seal



Fully insulated

Wire Gauge	Part #	Insulation
22-18	056169-25	Vinyl
16-14	056159-25	Vinyl
12-10	056164-25	Vinyl

### Female Quick Slide Terminals And Connectors - Tab Width .250"

#### Crimp



Butted seam - fully insulated



T-tap self stripping



Butted Seam

Wire Gauge	Part #	Insulation	Part #	Insulation	Part #	Insulation
22-18	056066-50	Nylon	058347-40	Nylon	056060-50	Vinyl
22-18	055099-10	Nylon	-	-	-	-
16-14	056067-50*	Nylon	057096-40	Nylon	056061-50*	Vinyl
16-14	055101-10	Nylon	-	-	057088-50*	Nylon
12-10	056068-50*	Nylon	058348-40	Nylon	056062-50*	Vinyl
12-10	055103-10	Nylon	-	-	057089-50	Nylon



Fully insulated

#### Crimp/Seal

Wire Gauge	Part #	Insulation
22-18	058318-50	Ht Shrink
22-18	055119-10	Nylon
16-14	058319-50	Ht Shrink
16-14	055129-10	Nylon
12-10	058320-10	Ht Shrink
12-10	055137-10	Nylon

#### Crimp/Solder/Seal



Fully insulated



Butted Seam

Wire Gauge	Part #	Insulation	Part #	Insulation
22-18	056165-25	Ht Shrink	056168-25	Vinyl
16-14	056166-25	Ht Shrink	056158-25	Vinyl
12-10	056167-25	Ht Shrink	056160-25	Vinyl

#### NOTES

Dash- "x" indicates package qty

\* Clam shell with quantity of ten (10) also available by adding "-10" to the base six digit number

## TERMINALS AND CONNECTORS

### Terminal Kits

- Convenient, pre-packaged terminal assortments
- Durable, see-through plastic cases with handy "locator" cards are easy to identify and refill
- Multi-functional kits can be displayed on the front counter to attract the impulse sale of single terminals or used as mini storage system

Part #	Description
056107	Solderless terminal kit
056108	Heat-shrink terminal kit
056109	Electrical connector kit



### Solderless Terminal Kit

- 195 total fittings

Part #	Description	Qty.
057085	22-18 ga. Butt conn	12
057086	16-14 ga. Butt conn	12
057087	12-10 ga. Butt conn	12
056002	22-18 ga. Ring tongue	12
056005	16-14 ga. Ring tongue	12
056011	12-10 ga. Ring tongue	12
056043	22-18 ga. Spade tubing	12
056044	16-14 ga. Spade	12
056045	12-10 ga. Spade	12
057061	16-14 ga. Shrink tubing	5
057062	12-10 ga. Shrink tubing	5
057149	22-18 ga. Shrink tubing	5
056061	16-14 ga. F. quick	12
056062	12-10 ga. F. quick	12
056064	16-14 ga. M. quick	12
056065	12-10 ga. M. quick	12
058340	16-14 ga. Snap plug	12
056078	16-14 ga. Snap plug	12

### Heat Shrink Terminal Kit

- 132 total fittings

Part #	Description	Qty.
058312	22-18 ga. Butt conn	8
058313	16-14 ga. Butt conn	8
058314	12-10 ga. Butt conn	8
058309	22-18 ga. spade	8
058310	16-14 ga. spade	8
058311	12-10 ga. spade	8
058302	16-14 ga. Ring tongue	8
058303	16-14 ga. Ring tongue	8
058304	16-14 ga. Ring tongue	8
058305	16-14 ga. Ring tongue	8
058306	12-10 ga. Ring tongue	8
058308	12-10 ga. Ring tongue	8
058315	22-18 ga. F. quick slide	6
058316	16-14 ga. F. quick slide	6
058317	12-10 ga. F. quick slide	6
058318	22-18 ga. F. quick slide	12
058319	16-14 ga. F. quick slide	6
058320	12-10 ga. F. quick slide	6

### Electrical Connector Kit

- 170 total fittings

Part #	Description	Qty.
056051	22-18 ga. Butt conn	12
056052	16-14 ga. Butt conn	12
056053	12-10 ga. Butt conn	12
021007	3/8" tube O.D. clip	6
056091	22-14 ga. Pigtail	15
056093	18-14 Tap	10
056002	22-18 Ring tongue	12
056005	16-14 Ring tongue	12
056008	12-10 Ring tongue	12
021009	1/2" tube O.D. tube clip	6
056092	18-10 ga. Pigtail	15
056094	12-10 run 18-14 tap	10
056043	22-18 Spade	12
056044	16-14 ga. Spade	12
056045	12-10 ga. Spade	12

### Solderless Terminal Fleet Maintenance Kit

- Packaged in a heavy-duty steel box with 20 popular styles of solderless terminals and nylon tie straps

Part #	Description
056096	Kit with crimping tool
056097	Kit without crimping tool



NOTE: Terminals also sold separately on pages E24-E28. Tie straps sold separately on page E33. Crimping tool sold separately on page E35

Part #	Qty.	Part #	Qty.
056002	20	056044	20
056004	20	056047	20
056005	20	058340	20
056006	20	056078	20
056061	20	056093	20
056064	20	056050	20
056067	20	056051	20
056070	20	056052	20
056009	20	056053	20
056011	20	056186	20
056014	20		



Call the Velvac Sales Team: **800.783.8871** sales@velvac.com

## PRIMARY WIRE AND ACCESSORIES

### General Purpose Primary Wire

- Soft annealed copper strands
- PVC outer jacket
- Designed to withstand temperatures up to +250°F
- Wire meets SAE J1128 Type GPT requirements



Part #	Wire Gauge	Spool Size	Color
051101	18	100'	Black
051103	18	100'	Red
051105	18	100'	White
051117-6	16	1000'	Black
051121-6	16	1000'	Red
051123-6	16	1000'	White
051119-6	16	1000'	Green
051117	16	100'	Black
051121	16	100'	Red
051123	16	100'	White
051125	16	100'	Yellow
051127	16	100'	Blue
051129	16	100'	Brown
051119	16	100'	Green
051135-6	14	1000'	Black
051139-6	14	1000'	Red
051141-6	14	1000'	White
051143-6	14	1000'	Yellow
051145-6	14	1000'	Blue
051147-6	14	1000'	Brown
051137-6	14	1000'	Green
051135	14	100'	Black
051139	14	100'	Red
051141	14	100'	White

Part #	Wire Gauge	Spool Size	Color
051143	14	100'	Yellow
051145	14	100'	Blue
051147	14	100'	Brown
051137	14	100'	Green
051157-7	12	500'	Red
051159-7	12	500'	White
051161-7	12	500'	Yellow
051163-7	12	500'	Blue
051155-7	12	500'	Green
051153	12	100'	Black
051157	12	100'	Red
051159	12	100'	White
051161	12	100'	Yellow
051163	12	100'	Blue
051165	12	100'	Brown
051155	12	500'	Green
051175-7	10	500'	Black
051171-7	10	500'	Red
051177-7	10	500'	White
051175	10	100'	Black
051171	10	100'	Red
051177	10	100'	White
051173	10	100'	Blue

### Primary Wire Rack

- Holds (12) 100' spools, (8) 100' and (2) 1000' spools or (4) 1000' spools
- Heavy gauge plated steel construction
- Wire spools sold separately

Part #	Description
691015	Primary wire rack





## PRIMARY WIRE AND ACCESSORIES

### Gray Jacketed Parallel Wire

Part #	Wire Gauge	Spool Size
051050	16	100'
051058	14	100'
051066	12	100'
051050-7	16	500'
051058-7	14	500'

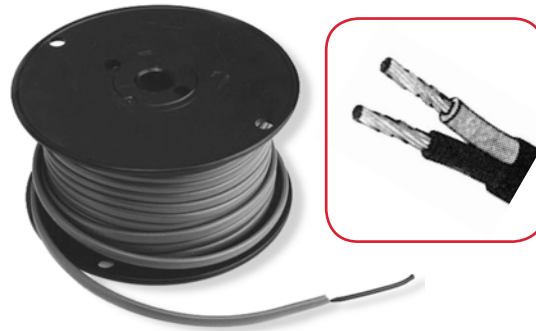

### Three-Way and Four-Way Bonded Parallel Wire\*

Part #	Wire Gauge	Conductor	Wire Color	Spool Size
051052	16	Three	Brown-Green-Yellow	100'
051060	16	Three	Brown-Green-Yellow	100'
051054	14	Four	Brown-Green Yellow-White	100'
051062	14	Four	Brown-Green Yellow-White	100'



#### NOTES

See page E7 for ATA color code description  
 \* Round wire glued together



## SPLIT LOOM

### Convuluted Split Loom

- High temperature loom suitable for engine compartment use
- Split seam permits easy insertion and repair of wire, tubing, cable, etc.
- Convuluted black nylon allows for excellent pinch and abrasion resistance
- Designed to withstand temperatures from -40° to +200°F
- Meets FMVSS 302 requirements

	100' Coil	250' Coil	Loom I.D.
020104-7		020104	1/4"
020106-7		020106	3/8"
020108-7		020108	1/2"
020110-7		020110	5/8"
020112-7		020112	3/4"
020116-7		-	1"
020117-7		-	1-1/4"
020118-7		-	1-1/2"
020119-7		-	1-7/8"



Call the Velvac Sales Team: **800.783.8871** [sales@velvac.com](mailto:sales@velvac.com)



## HEAT-SHRINK TUBING

### Heavy Wall Heat-Shrink Tubing With Liner

- Durable polyolefin construction
- Inner liner melts to produce a flexible, waterproof seal for the life of the connection
- UL Listed/CSA certified in direct buried applications
- Flame retardant
- 3:1 shrink ratio
- See page E36 for heat gun - recommended heat range is 250°F (120°C) to 485°F (250°C)



Part #	Wire Gauge Range	Length	I.D. Pre-Shrink	I.D. After
057146-10	18-14	6"	.300"	.100"
057148-5	18-14	48"	.300"	.100"
057058-10	14-6	6"	.400"	.150"
057159-5	14-6	48"	.400"	.150"
057059-10	8-1	6"	.750"	.200"
057150-25	8-1	1-1/2"	.750"	.200"
057152-2	8-1	48"	.750"	.200"
057060-10	2-4/0	6"	1.100"	.375"
057097-25	2-4/0	1-1/2"	1.100"	.375"
057160-2	2-4/0	48"	1.100"	.375"

Part #	Wire Gauge Range	Length	I.D. Pre-Shrink	I.D. After
057147-10	18-14	6"	.300"	.100"
057158-10	14-6	6"	.400"	.150"
057073-10	8-1	6"	.750"	.220"
057151-25	8-1	1-1/2"	.750"	.220"
057153-2	8-1	48"	.750"	.220"
057074-10	2-4/0	6"	1.100"	.375"
057098-25	2-4/0	1-1/2"	1.100"	.375"
057174-2	2-4/0	48"	1.100"	.375"

### Thin Wall Heat-Shrink Tubing Without Liner

Part #	Wire Gauge	Length	Color	I.D. Pre-Shrink	I.D. After
057061-25	16-14	2"	Blue	.250"	.125"
057062-25	12-10	2"	Yellow	.375"	.187"
057149-25	22-18	6"	Red	.125"	.062"
057112-10	-	6"	Black	.190"	.093"
057113-10	-	6"	White	.250"	.125"
057114-10	-	6"	Red	.375"	.187"
057115-10	-	6"	Black	.500"	.250"
057116-10	-	6"	White	.750"	.370"
057117-10	-	6"	Red	1.00"	.500"

- Durable polyolefin construction
- UL recognized and flame retardant
- Continuous operating temperature: -67°F (-55°C) to 275°F (135°C)
- Recommended heat range is 250°F (120°C) to 485°F (250°C)
- 2:1 shrink ration



#### NOTES

Dash - "x" indicates package quantity

Part #	Description
057131	3/16" I.D., Red
057132	1/4" I.D., Blue
057133	5/16" I.D., Yellow

Packaged in 8' rolls - one roll per disk pack



### Thin Wall Heat-Shrink Tubing

- Disk packaging for convenient storage and waste reduction
- Packaged for showroom display and impulse buying
- Available in three colors corresponding to NEMA color-codes
- Easily fits in toolbox

## HEAT SHRINK TUBING

### Heat-Shrink Tubing Kits

- Convenient, pre-packaged tubing assortments save time by keeping popular sized tubing in 6" lengths close at hand
- Durable, see-through plastic cases with handy "locator" cards are easy to find items and refill

Part #	Description
057110	Heavy wall heat-shrink tubing kit
057111	Thin wall heat-shrink



057110

### Heavy Wall Heat-Shrink Tubing Kit

- 36 total fittings

Part #	Pieces	Description
057060	4 pcs	1.10" Black
057059	4 pcs	.750" Black
057058	10 pcs	.400" Black
057074	4 pcs	1.10" Red
057073	4 pcs	.750" Red
057158	10 pcs	.400" Red

### Thin Wall Heat-Shrink Tubing Kit

- 86 total fittings

Part #	Pieces	Description
057112	36 pcs	3/16" Black
057113	24 pcs	1/4" White
057114	12 pcs	3/8" Red
057115	6 pcs	1/2" Black
057116	4 pcs	3/4" White
057117	4 pcs	1" Red



057111

## TIE STRAPS, GROMMETS AND WIRE CLIPS

### Cable Tie Straps

Stand. Part #	BK UV Tie Part #	Length	Min. Diam	Max. Diam	Min Ten. Strength	Stud Size
090002-100	090064-100	5"	1/16"	1-1/4"	30 lb	-
090004-100	090067-100	7"	1/16"	1-3/4"	50 lb	10
090006-25	090070-25	14"	3/16"	4"	120 lb	-
090010-25	090071-25	14"	3/16"	4"	120 lb	14
090014-100	090066-100	7"	1/16"	1-3/4"	50 lb	-
090016-100	090068-100	14"	1/16"	4"	50 lb	-
-	090030-50	24"	-	-	175 lb	-
-	090029-50	36"	-	-	175 lb	-



090002, 090064



090004, 090067



090006, 090070



090010, 090071



090014, 090066

090016, 090068

090030, 090029

#### NOTES

Dash "-xxx" indicates package quantity



Call the Velvac Sales Team: **800.783.8871** sales@velvac.com

© VELVAC INC. • 2405 South Calhoun Road • New Berlin, WI 53151-2709 • Toll Free: 800.783.8871 • Fax: 262.786.4101

## TIE STRAPS, GROMMETS AND WIRE CLIPS

### Rubber Grommets

Part #	A	B	C	D	E
021059	9/16"	7/16"	5/16"	3/16"	1/16"
021061	1-3/8"	1"	1/2"	1/2"	1/8"
021063	1-1/4"	31/32"	5/8"	3/8"	1/8"
021065	1-3/4"	1-3/16"	3/4"	1/2"	7/32"

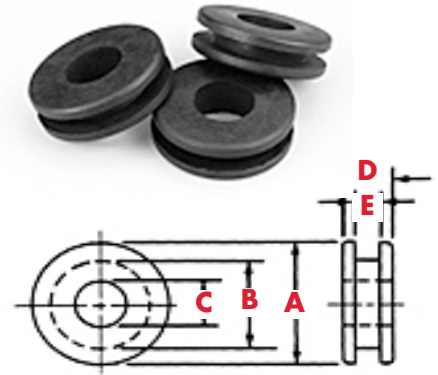

### Nylon Grommet



- Provides protection for 16, 14 and 12 gauge wires
- Fits into a 3/8" diameter mounting hole with wall thickness up to 1/8"

Part #	Description
021070	Nylon grommet

### Tube Clips



- Zinc-plated steel construction for corrosion resistance
- Rubber coating protects tubing and wires

Part #	Tube O.D.	Mounting Bolt Size
021001	3/16"	1/4"
021003	1/4"	1/4"
021005	5/16"	1/4"
021007	3/8"	1/4"
021009	1/2"	1/4"
021011	5/8"	1/4"
021013	3/4"	3/8"
021015	7/8"	1/4"
021017	1"	1/4"
021019	1-1/4"	5/16"

### Wire Clips



- Spring tension clips are ideal for holding primary wire to truck frame
- Tips are vinyl coated for wire protection

Part #	Description
021021	1/4" Wire clip
021023	1/2" Wire clip

### Rubber Cushioned Clamps



Clamp Diam.	3/8" Mount Screw, 5/8" Wide Part #	1/4" Mount Screw, 1/2" Wide Part #
1/4"	021102	021114
3/8"	021103	021115
1/2"	021104	021116
5/8"	021100	021117

Clamp Diam.	3/8" Mount Screw, 5/8" Wide Part #	1/4" Mount Screw, 1/2" Wide Part #
3/4"	021105	021118
1"	021106	021119
1-1/4"	021107	-
1-1/2"	021108	-
2"	021109	-
2-1/2"	021110	-
3"	021111	-
4"	021112	-
5"	021113	-

## SHOP TOOLS AND ACCESSORIES



### Work Lights

- Incandescent light includes grounded metal swing-open bulb guard and 25' 16/3 outdoor all-weather power cord (cord remains flexible in sub-zero temperatures to -20°F)
- On/Off switch, grounded three prong outlet and 13 amp resettable circuit breaker built into handle
- Metal hanging hook
- For use with up to 75 watt standard incandescent bulb (not included)

Part #	Description
057123	Work light



### Deluxe Crimping Tool

- Crimps terminals ranging in size from 26 to 6 gauge
- Five popular sized bolt cutting stations cleanly cut mild steel and nonferrous material

Part #	Description
058026	Deluxe crimping tool



### Economy Crimping Tool

- Accepts 8 through 4/0 gauge terminals, connectors, lugs
- Hammer required for operation

Part #	Description
058030	Economy crimping tool



### Short Tube Work Light 13 Watt

- Fluorescent light features new ergonomic handle, shatter resistant housing and 25' 16/3 attached cord
- Ballast, On/Off switch and three prong tool outlet built into bottom end of handle
- Handle accepts 360° adjustable magnet mounting clip allowing lamp to adhere to metal surface
- Shatter resistant polycarbonate lens with 270° arc of light
- 360° adjustable swivel hanging hook
- No tools needed for easy bulb replacement means it's cool and energy efficient
- Includes 13 watt fluorescent twin tube

Part #	Description
057125	Light - 13 Watt



### Heavy-Duty Crimping Tool

- For crimp-type terminals from 6 to 4/0 gauge
- Rotating, letter-coded crimping die
- Reference guides on handles for proper die settings

Part #	Description
058171	Heavy-duty crimping tool
058172	Replacement left jaw
058173	Replacement right jaw



### Long Tube Work Light 15 Watt

- Fluorescent light features shatter resistant lamp housing an 25' 18/2 attached power cord
- On/Off switch built into handle
- Plug-in ballast built into power cord plug
- Non-glare reflector
- 360° adjustable swivel hanging hook

Part #	Description
057124	Light - 15 Watt



### Copper Cable Cutter

- Capable of cutting up to 1" diameter copper stranded electrical cable
- 13" long steel handles with vinyl hand grips

Part #	Description
057072	Copper cable cutter



### Compact Cable Cutter

- Designed to cut copper wire and cable up to 4/0 gauge

Part #	Description
057071	Compact cable cutter



Call the Velvac Sales Team: **800.783.8871** [sales@velvac.com](mailto:sales@velvac.com)

© VELVAC INC. • 2405 South Calhoun Road • New Berlin, WI 53151-2709 • Toll Free: 800.783.8871 • Fax: 262.786.4101



## SHOP TOOLS AND ACCESSORIES



### Heat Gun

- Produces temperatures from 750° to 1100°F
- Built-in circuit breaker and three position switch (Hot/Off/Fan only)

Part #	Description
058160	Heat gun



### Triple Outlet All-Weather Extension Cord

- 50' 12/3 high visibility yellow cord rated at 15 amps, 125 VDC
- Heavy duty power block at female end with resettable 15 amp circuit breaker and three grounded outlets

Part #	Description
057128	50' Extension cord



### General Purpose Vinyl Electrical Tape

- Rated to 176°F (80°C)
- Meets UL510 requirements for UV resistance
- UL listed 539H and meets Canadian Standards Association LR48769

Part #	Tape Thickness	Roll Size
058382	7 mil	3/4" x 60'



### 25' Cord Reel

- Retractable 25' 16/3 cord rated at 10 amps, 125 VDC
- Housing constructed of high impact plastic with 4 built-in grounded outlets, 10 amp resettable circuit breaker and a convenient wind-up knob
- When completely wound, reel fits easily into tool box or drawer
- Carrying handle attached for convenient portability

Part #	Description
057126	25' Cord reel



### 50' Cord Reel

- Retractable 50' 14/3 yellow cord rated at 13 amps, 125 VDC to -40°
- Heavy duty cord includes heavy duty power block with built-in resettable 13 amp circuit breaker and three grounded outlets
- Industrial/commercial grade auto ratcheting plastic alloy reel housing with built-in carrying handle
- Includes quick release wall/ceiling mounting bracket for portability
- All hardware included

Part #	Description
057127	50' Cord reel



### Silicon Self-Fusing Tape

- Tape self fuses and cures in 24 hours to form a permanent moisture tight seal
- Has no adhesive lining leaving the application clean with no sticky residue
- Provides high tech alternative to heat shrink tubing
- Ideal for high temperature applications such as battery terminals
- High dielectric strength
- Temperature range: -85° to +500°F
- Packaged in clamshell, 1" wide, 20' long rolls (qty 1 per clamshell)

Part #	Color	Description
058380*	Black	Self-fusing tape
058381*	Red	Self-fusing tape

\*Add -4 to the part number for 10 piece bucket display in Retail section



## WE LEAD THE RV MARKET

Our mirrors are the  
first thing you'll see.

The Tiffin Phaeton,  
pictured here,  
with Velvac 2030  
side view mirrors.

Sleek and stylish, our **2030 Mirrors** sure turn heads. But, before you drive anywhere — you check our mirrors first. Within the RV industry, Velvac leads the way in mirrors and has proven to be *the leader in design, safety and vision.*



velvac.com



NOTE: 2030 mirrors come OEM standard — see M37 for the 2020 family of mirrors available.

Call the Velvac Sales Team: **800.783.8871** sales@velvac.com

© VELVAC INC. • 2405 South Calhoun Road • New Berlin, WI 53151-2709 • Toll Free: 800.783.8871 • Fax: 262.786.4101

**OUR PARTS PUT YOU IN THE PASSING LANE**

# **FITTINGS & HARDWARE**

## **Precision engineered.**

Velvac offers one of the most comprehensive fittings lines in the industry. From push-lock fittings with an engineered tube retention system and seal design for superior holding and side-load retention capabilities, to more traditional brass male and female fittings, Velvac has you covered.

- **Corrosion resistant**
- **Heavy gauge to exceed SAE torque requirements**
- **Extended diameter range**



# FITTINGS & HARDWARE

## PUSH-LOCK AIR BRAKE FITTINGS

- Designed for use with SAE J844 nylon tubing
- DOT 49CFR 571.106 compliant high strength composite fittings offer weight savings over all brass style fittings currently being used by many OE vehicle manufacturers
- Fittings meet performance requirements as stated in SAE J1131\*
- Operating temperatures from -45°F to +140°F
- Maximum operating pressure 145 psi
- Elbows and male branch fittings with built-in swivel for positioning
- Engineered tube retention system and seal design for superior holding and side load retention
- Positive release bushing for easy insertion and removal of tubing
- Thread sealant applied to all male pipe threads to reduce installation time and expense

\* Indicates parts that DO NOT meet DOT or SAE specification for air brake applications

### WARNING!

Velvac's line of push-lock brake fittings and tubing are designed only for use in vehicles where air is utilized as the operating fluid. As such, Velvac's push-lock air brake fittings should only be used in a manner consistent with the manufacturer's specifications.

Using Velvac's push-lock fittings or tubing improperly or in a manner inconsistent with the manufacturer's specifications may result in serious injury or property damage. For example, Velvac's push-lock fittings and tubing are not intended for use in environments exceeding 145 psi and only for temperatures between -45°F and +140°F. Velvac push-lock fittings and tubing are intended for use only as defined in 49CFR571.106.

Further, the U.S. Department of Transportation prohibits the use of push-lock fittings and nylon tubing as a connection between (I) a semi-tractor & trailer, or (II) a drive shaft and chassis.

**NOTE: 1/8" push-lock fittings DO NOT meet DOT or SAE specifications for air brake applications.**

### 90° Male Swivel Elbows (Sealant applied)

- Composite body with brass pipe-fitting end



Part #	Tube Size	Pipe Size
016212	1/8"	1/8"
016214	1/8"	1/4"
016222	5/32"	1/8"
016270	5/32"	1/4"
016271	3/16"	1/8"
016242	1/4"	1/8"
016244	1/4"	1/4"
016246	1/4"	3/8"
016254	1/4"	1/2"
016262	3/8"	1/8"
016264	3/8"	1/4"
016266	3/8"	3/8"
016268	3/8"	1/2"
016284	1/2"	1/4"
016286	1/2"	3/8"
016288	1/2"	1/2"
016278	5/8"	3/4"
016279	5/8"	3/8"
016281	5/8"	1/2"
016276	3/4"	1/2"
016277	3/4"	3/4"

### Union 'Y'

- Composite body



Part #	Tube Size
016289	1/4 x 1/4 x 1/4"
016291	1/4 x 1/4 x 3/8"
016290	3/8 x 3/8 x 3/8"

### 45° Male Swivel Elbows (Sealant applied)

- Composite body with brass pipe-fitting end



Part #	Tube Size	Pipe Size
016412*	1/8"	1/8"
016451	5/32"	1/8"
016442	1/4"	1/8"
016444	1/4"	1/4"
016446	1/4"	3/8"
016452	3/8"	1/8"
016464	3/8"	1/4"
016466	3/8"	3/8"
016947	3/8"	1/2"
016453	1/2"	1/4"
016486	1/2"	3/8"
016950	1/2"	1/2"
016454	5/8"	3/8"
016450	5/8"	1/2"
016455	5/8"	3/4"
016456	3/4"	3/8"
016457	3/4"	1/2"

### Union Tees

- Composite body



Part #	Tube Size
016910*	1/8"
016920	5/32"
016930	3/16"
016940	1/4"
016960	3/8"
016980	1/2"
016985	1/2 x 1/2 x 3/8"
016982	5/8"



Call the Velvac Sales Team: **800.783.8871** sales@velvac.com

© VELVAC INC. • 2405 South Calhoun Road • New Berlin, WI 53151-2709 • Toll Free: 800.783.8871 • Fax: 262.786.4101



# FITTINGS & HARDWARE

## PUSH-LOCK AIR BRAKE FITTINGS

### Bulkhead Unions

- Brass construction



Part #	Tube Size
016810*	1/8"
016840	1/4"
016860	3/8"
016880	1/2"

### Female Bulkhead Connectors



Part #	Tube Size	Thread Size
016814	1/4"	1/8"
016812	1/4"	1/4"
016813	3/8"	1/4"
016815	3/8"	3/8"
016816	1/2"	3/8"

### Full Unions

- Composite body



Part #	Tube Size A	Tube Size B
016610*	1/8"	1/8"
016620	5/32"	5/32"
016630*	3/16"	3/16"
016640	1/4"	1/4"
016660	3/8"	3/8"
016680	1/2"	1/2"
016670	5/8"	5/8"
016621	3/4"	3/4"
016623	5/32"	1/4"*
016622	1/4"	3/8"
016624	3/8"	1/2"

### 'Y' Male Branches

- Composite body



Part #	Tube Size	Thread Size
016294	1/4"	1/4"
016295	3/8"	1/4"

### Male Run Tees

- Brass/composite



Part #	Tube Size	Pipe Size
016400	1/4"	1/8"
016401	1/4"	1/4"
016402	3/8"	1/4"
016403	3/8"	3/8"
016404	3/8"	1/2"
016405	1/2"	3/8"
016406	1/2"	1/2"
016407	5/8"	1/2"
016409	1/4"	3/8"

### Female Elbows



Part #	Tube Size	Thread Size
016247	1/4"	1/8"
016248	1/4"	1/4"
016249	3/8"	1/4"
016250	3/8"	3/8"

### Plug In 90° Elbows



Part #	Tube Size
016348	1/4"

### Male Connectors

(Sealant supplied)



Part #	Tube Size	Pipe Size
016110*	1/8"	1/16"
016112*	1/8"	1/8"
016114*	1/8"	1/4"
016120	5/32"	1/16"
016122	5/32"	1/8"
016124	5/32"	1/4"
016121*	3/16"	1/8"
016142	1/4"	1/8"
016144	1/4"	1/4"
016146	1/4"	3/8"
016162	3/8"	1/8"
016164	3/8"	1/4"
016166	3/8"	3/8"
016168	3/8"	1/2"
016184	1/2"	1/4"
016186	1/2"	3/8"
016188	1/2"	1/2"
016951	3/4"	1/2"
016161	3/4"	3/4"
016163	5/8"	3/8"
016189	5/8"	1/2"
016187	3/4"	3/8"

### Female Connectors

(Sealant applied)



Part #	Tube Size	Pipe Size
016102	1/4"	1/8"
016103	1/4"	1/4"
016104	3/8"	1/4"
016105	3/8"	3/8"

\* Indicates parts that DO NOT meet DOT or SAE specification for air brake applications

**NOTE: Part numbers listed in RED are NEW!**

# FITTINGS & HARDWARE

## PUSH-LOCK AIR BRAKE FITTINGS

### Union 90° Elbows

- Composite body



Part #	Tube Size
016282	5/32"
016305*	3/16"
016283	1/4"
016285	3/8"
016287	1/2"

\* Indicates parts that DO NOT meet DOT or SAE specification for air brake applications

### Male Branch Swivel Tees

- (Sealant applied)
- Composite body



Part #	Tube Size	Pipe Size
016312*	1/8"	1/8"
016314*	1/8"	1/4"
016342	1/4"	1/8"
016344	1/4"	1/4"
016343	1/4 x 1/4"	3/8"
016364	3/8"	1/4"
016366	3/8"	3/8"
016368	3/8"	1/2"
016386	1/2"	3/8"
016388	1/2"	1/2"
016408	5/8"	1/2"

### Female Branch Tees



Part #	Tube Size	Pipe Size
016415	1/4"	1/4"
016416	3/8"	1/8"
016417	3/8"	1/4"

### Composite Plugs



Part #	Tube Size
016115	1/4" (Pkg. of 5)
016116	3/8" (Pkg. of 5)
016117	1/2"

## BRASS PUSH-LOCK AIR BRAKE FITTINGS

- Designed for use with SAE J844 nylon tubing
- DOT 49CFR 571.106 compliant
- Fittings complies with worldwide Standard and Legislation including SAE J1131 "Hot Pull" requirements
- Operating temperatures from -40°F to +212°F
- Maximum operating pressure 0 to 150 psi
- Elbows and male branch fittings with built-in swivel for positioning
- Collet with multiple teeth for high grip on the tube
- Side load retention capabilities
- Positive release bushing for easy insertion and removal of tubing
- Thread sealant applied to all male pipe threads to reduce installation time and expense

### 45° Male Fixed Elbows

(Sealant applied)

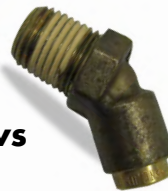

Part #	Tube Size	Pipe Size
017980	1/4"	1/8"
017981	1/4"	1/4"
017982	3/8"	1/4"
017983	3/8"	3/8"
017984	1/2"	3/8"
017985	1/2"	1/2"

### Male Run Tees

(Sealant applied)



Part #	Tube Size	Pipe Size
017900	1/4"	1/4"
017901	3/8"	1/4"
017902	3/8"	3/8"

### Male Branch Swivel Tees



Part #	Tube Size	Pipe Size
017970	1/4"	1/8"
017972	3/8"	1/4"
017973	3/8"	3/8"
017974	1/2"	3/8"



Call the Velvac Sales Team: **800.783.8871** sales@velvac.com

© VELVAC INC. • 2405 South Calhoun Road • New Berlin, WI 53151-2709 • Toll Free: 800.783.8871 • Fax: 262.786.4101



# FITTINGS & HARDWARE

## BRASS PUSH-LOCK AIR BRAKE FITTINGS

### Union Connectors



Part #	Tube A	Tube B
017910	1/4"	1/4"
017911	3/8"	3/8"
017912	1/2"	1/2"
017913	5/8"	5/8"
017914	3/4"	3/4"

### 90° Male Swivel Elbows

(Sealant applied)



Part #	Tube Size	Pipe Size
017950	1/4"	1/8"
017951	1/4"	1/4"
017952	1/4"	3/8"
017953	3/8"	1/8"
017954	3/8"	1/4"
017955	3/8"	3/8"
017956	3/8"	1/2"
017957	1/2"	1/4"
017958	1/2"	3/8"
017959	1/2"	1/2"

### Male Connectors

(Sealant applied)



Part #	Tube Size	Pipe Size
017940	1/4"	1/8"
017941	1/4"	1/4"
017942	1/4"	3/8"
017943	3/8"	1/8"
017944	3/8"	1/4"
017945	3/8"	3/8"
017946	1/2"	3/8"
017947	1/2"	1/2"

### Union Tees



Part #	Tube Size
017920	1/4"
017921	3/8"
017922	1/2"

### Union Elbows



Part #	Tube Size
017931	3/8"
017932	1/2"

### 90° Male Non-Swivel Elbows

(Sealant applied)



Part #	Tube Size	Pipe Size
017960	1/4"	1/8"
017961	1/4"	1/4"
017966	3/8"	1/8"
017962	3/8"	1/4"
017963	3/8"	3/8"
017967	1/2"	1/4"
017964	1/2"	3/8"
017965	1/2"	1/2"

### WARNING!

Velvac's line of push-lock brake fittings and tubing are designed only for use in vehicles where air is utilized as the operating fluid. As such, Velvac's push-lock air brake fittings should only be used in a manner consistent with the manufacturer's specifications.

Using Velvac's push-lock fittings or tubing improperly or in a manner inconsistent with the manufacturer's specifications may result in serious injury or property damage. For example, Velvac's push-lock fittings and tubing are not intended for use in environments exceeding 145 psi and only for temperatures between -45°F and +140°F. Velvac push-lock fittings and tubing are intended for use only as defined in 49CFR571.106.

Further, the U.S. Department of Transportation prohibits the use of push-lock fittings and nylon tubing as a connection between (I) a semi-tractor & trailer, or (II) a drive shaft and chassis.

## NYLON AIR BRAKE TUBE FITTINGS

- Designed for use with nylon air brake tubing
- DOT compliant. Fittings meet SAE J246 requirements
- Brass construction with internal stainless steel tube supports
- Pipe thread sealant featured on several fitting styles

- This pre-applied sealant offers many benefits:
  - » Provides no-leak assembly instantly. Saves application time and expense
  - » Will not contaminate systems such as tape shredding or liquid sealant washout
  - » Can be reused up to five times
  - » Provides excellent thread

### Bulkhead Unions



Part #	Tube Size
016204	1/4"
016206	3/8"
016208	1/2"

**NOTE: Part numbers listed in RED are NEW!**

# FITTINGS & HARDWARE

## NYLON AIR BRAKE TUBE FITTINGS

### 45° Elbows (Sealant applied)



Part #	Tube Size	Pipe Size
017842	1/4"	1/8"
017844	1/4"	1/4"
017862	3/8"	1/8"
017864	3/8"	1/4"
017866	3/8"	3/8"
017868	3/8"	1/2"
017886	1/2"	3/8"
017888	1/2"	1/2"
017884	1/2"	3/4"
017816	5/8"	3/8"
017808	5/8"	1/2"

### Female Connectors



Part #	Tube Size	Pipe Size
016642	1/4"	1/8"
016644	1/4"	1/4"
016662	3/8"	1/8"
016664	3/8"	1/4"
016666	3/8"	3/8"
016686	1/2"	3/8"
016688	1/2"	1/2"
016618	5/8"	1/2"
017816	5/8"	3/8"
017808	5/8"	1/2"

### Tee Thread Branches (Sealant applied)



Part #	Tube Size	Pipe Size
017242	1/4"	1/8"
017244	1/4"	1/4"
017262	3/8"	1/8"
017264	3/8"	1/4"
017266	3/8"	3/8"
017286	1/2"	3/8"
017288	1/2"	1/2"
017218	5/8"	1/2"

### Male Elbows



Part #	Tube Size	Pipe Size
016942	1/4"	1/8"
016944	1/4"	1/4"
016946	1/4"	3/8"
016962	3/8"	1/8"
016964	3/8"	1/4"
016966	3/8"	3/8"
016968	3/8"	1/2"
016984	1/2"	1/4"
016986	1/2"	3/8"
016988	1/2"	1/2"
016916	5/8"	3/8"
016908	5/8"	1/2"
016912	5/8"	3/4"
016918	3/4"	1/2"
016922	3/4"	3/4"

### Elbow End Tubes



Part #	Tube Size
016540	1/4"
016560	3/8"
016580	1/2"
016510	5/8"

### Male Connectors (Sealant applied)



Part #	Tube Size	Pipe Size
016842	1/4"	1/8"
016844	1/4"	1/4"
016846	1/4"	3/8"
016862	3/8"	1/8"
016864	3/8"	1/4"
016866	3/8"	3/8"
016868	3/8"	1/2"
016884	1/2"	1/4"
016886	1/2"	3/8"
016888	1/2"	1/2"
016890	1/2"	3/4"
016806	5/8"	3/8"
016808	5/8"	1/2"
016809	5/8"	3/4"
016818	3/4"	1/2"
016811	3/4"	3/4"

#### Helpful hint

Air brake hose repair fitting kits are part numbers 500007 and 500008



Call the Velvac Sales Team: **800.783.8871** sales@velvac.com

© VELVAC INC. • 2405 South Calhoun Road • New Berlin, WI 53151-2709 • Toll Free: 800.783.8871 • Fax: 262.786.4101

# FITTINGS & HARDWARE

## NYLON AIR BRAKE TUBE FITTINGS

### Female Elbows



Part #	Tube Size	Pipe Size
017043	1/4"	1/8"
017046	1/4"	1/4"
017064	3/8"	1/4"
017066	3/8"	3/8"
017086	1/2"	3/8"

### Tee Thread Runs



Part #	Tube Size	Pipe Size
017142	1/4"	1/8"
017144	1/4"	1/4"
017164	3/8"	1/4"
017166	3/8"	3/8"
017186	1/2"	3/8"
017188	1/2"	1/2"

### Tee End Tubes

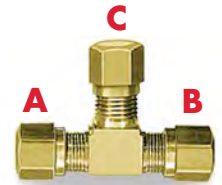

Part #	Tube Size
016440	1/4"
016460	3/8"
016482	A, B: 3/8" C: 1/4"
016480	1/2"
016481	5/8"

### Full Unions



Part #	Tube Size
016240	1/4"
016260	3/8"
016280	1/2"
016200	5/8"
016201	3/4"

### Sleeves



Part #	Tube Size
016340	1/4"
016360	3/8"
016380	1/2"
016300	5/8"
016301	3/4"

### Nuts



Part #	Tube Size
016140	1/4"
016160	3/8"
016180	1/2"
016100	5/8"
016101	3/4"

## AIR BRAKE COMPRESSION FITTINGS

- Designed for use with nylon or copper air brake tubing
- DOT compliant. Fittings meet SAE J246 requirements
- All brass construction
- Pipe thread sealant featured on several fitting styles. This pre-applied sealant offers many benefits:
  - » Provides no-leak assembly instantly. Saves application time and expense
  - » Will not contaminate systems such as tape shredding or liquid sealant
  - » Can be reused up to five times
  - » Provides excellent thread lubrication to prevent galling

### 45° Male Elbows

(Sealant applied)



Part #	Tube Size	Pipe Size
013075	3/8"	1/4"
013076	3/8"	3/8"
013077	1/2"	3/8"

### Male Elbows

(Sealant applied)



Part #	Tube Size	Pipe Size
012067	1/4"	1/8"
012071	1/4"	1/4"
012073	1/4"	3/8"
012087	3/8"	1/8"
012091	3/8"	1/4"
012093	3/8"	3/8"
012095	3/8"	1/2"
012097	1/2"	1/4"
013001	1/2"	3/8"
013003	1/2"	1/2"
013011	5/8"	1/2"

### Compression Nuts



Part #	Tube Size
011013	1/4"
011023	3/8"
011025	1/2"
011027	5/8"

**NOTE: Part numbers listed in RED are NEW!**

# FITTINGS & HARDWARE

## AIR BRAKE COMPRESSION FITTINGS

### Full Unions



Part #	Tube Size
011033	1/4"
011041	3/8"
011043	1/2"
011045	5/8"
011047	3/4"

### Nylon Tubing Inserts



Part #	Tube Size
010087	1/4"
010089	3/8"
010094	1/2"
010096	5/8"
010098	3/4"

### Female Connectors



Part #	Tube Size	Pipe Size
011093	3/8"	1/4"

### Tee Thread Branches



Part #	Tube Size
011051	1/4"
011057	3/8"
011059	1/2"

### Tee Thread Runs



Part #	Tube Size	Pipe Size
013041	3/8"	1/4"

### Spherical Sleeves



Part #	Tube Size
011001	1/4"
011003	3/8"
011005	1/2"
011007	5/8"
011009	3/4"

Fitting sleeves should NEVER be reused

### Male Connectors (Sealant applied)



Part #	Tube Size	Pipe Size
012017	1/4"	1/8"
012021	1/4"	1/4"
012023	1/4"	3/8"
012035	3/8"	1/8"
012037	3/8"	1/4"
012041	3/8"	3/8"
012043	3/8"	1/2"
012045	1/2"	1/4"
012047	1/2"	3/8"
012049	1/2"	1/2"
012053	5/8"	3/8"
012055	5/8"	1/2"
012061	3/4"	1/2"

### Tee Thread Branches (Sealant applied)



Part #	Tube Size	Pipe Size
013049	1/4"	1/8"
013057	3/8"	1/4"
013060	3/8"	3/8"

## RE-USABLE AIR HOSE FITTINGS

- Designed for use with rubber air brake hose
- Bodies, sleeves and nuts are all brass construction for durability and corrosion resistance
- Zinc-plated steel springs have rounded ends to protect air hose

### Fitting Assemblies



Part #	Hose I.D.	Pipe Size
500001	3/8"	1/2"
500009	3/8"	3/8"
500015	3/8"	1/4"
500050	1/2"	1/2"
500051	1/2"	3/8"

### Swivel Fitting Assemblies



Part #	Hose I.D.	Pipe Size
500039	3/8"	1/4"
500046	3/8"	3/8"
500044	3/8"	1/2"
500094	1/2"	3/8"



Call the Velvac Sales Team: **800.783.8871** sales@velvac.com

© VELVAC INC. • 2405 South Calhoun Road • New Berlin, WI 53151-2709 • Toll Free: 800.783.8871 • Fax: 262.786.4101



# FITTINGS & HARDWARE

## RE-USABLE AIR HOSE FITTINGS

### Nuts (w/ or w/o spring)



Part #	Type	Hose I.D.
500021	Spring & Nut	3/8"
500071	Spring & Nut	1/2"
500037	Nut Only	1/2"
500022	Nut Only	3/8"
500030	Spring Only	1/2"
500024	Spring Only	3/8"

### Nuts



Part #	Hose I.D.
500004	3/8"
500054	1/2"

### Union Assemblies



Part #	Hose I.D.
500031	3/8"
500088	1/2"

### Fitting Sleeves



Part #	Hose I.D.
500005	3/8"
500055	1/2"

Fitting sleeves should NEVER be reused

### Union Bodies



Part #	Tube Size
500033	3/8"
500041	1/2"

### Fitting Assemblies (w/ spring)



Part #	Hose I.D.	Pipe Size
500019	3/8"	1/2"
500025	3/8"	3/8"
500027	3/8"	1/4"
500070	1/2"	1/2"
500078	1/2"	3/8"

### Swivel Body Adaptors



Part #	Hose I.D.	Pipe Size	Straight Thread
140000	3/8"	1/4"	3/4" - 20
142001	3/8"	3/8"	3/4" - 20
500059	3/8"	1/2"	3/4" - 20
500052	1/2"	3/8"	7/8" - 20
500060	1/2"	1/2"	7/8" - 20

### Dual Barb Male Fitting (Sealant applied)



Part #	Hose Size	Tube Size
500079	1/4"	1/8"
500080	1/4"	1/4"
500081	5/16"	1/4"
500082	3/8"	1/4"
500083	3/8"	3/8"
500084	5/8"	1/2"
500085	3/4"	3/4"

### Firewall Couplings

- Zinc-plated steel construction
- 1/4" FPT both ends
- 3/16" diameter mounting holes on 1-3/8" centers



Part #	Description
501071	Firewall coupling

### Swivel Fitting Assemblies (w/ spring)



Part #	Hose I.D.	Pipe Size
500035	3/8"	1/4"
500042	3/8"	3/8"

### Hose Splicers



Part #	Hose Size
500063	3/8"
500064	1/2"
500065	5/8"
500066	3/4"

### Fitting Bodies



Part #	Hose I.D.	Pipe Size
500003	3/8"	1/2"
500011	3/8"	3/8"
500017	3/8"	1/4"
500053	1/2"	1/2"
500061	1/2"	3/8"

### Frame Couplings

- Zinc-plated steel construction
- FPT both ends



Part #	Frame	Overall Length	Thread
035081	1/4"	1-1/2"	3/4" - 16
035087	3/8"	1-3/8"	1" - 14

**NOTE: Part numbers listed in RED are NEW!**



# FITTINGS & HARDWARE

## CLAMPING STUDS

### Male Clamping Studs



- Zinc-plated steel construction
- 1/2" MPT each end, 1/4" FPT one end
- 1" - 14 mounting thread
- 2-3/8" overall length

Part #	Description
035021	Male clamping stud

### Female Clamping Studs



- Zinc-plated steel construction
- 1/2" MPT, 1/4" FPT one end and 1/2" FPT other end
- 1-1/4" mounting thread
- 2-1/4" overall length

Part #	Description
035029	Female clamping stud

### Frame Clamping Studs



- Zinc-plated steel construction
- 1/2" MPT one end, 3/8" FPT one end
- 1-1/4" mounting thread
- 1-7/8" overall length

Part #	Description
035079	Male clamping stud

### Bulkhead Fittings: Female to Nylon Tubing

- 3/8" NPTF thread



Part #	Tube Size
017098	1/2"
017099	3/8"

### Bulkhead Fittings with Spring



Part #	Tube Size
500096	3/8"

## VACUUM HOSE FITTINGS

### Nipples



Part #	Hose Size	Tube Size
149005	1/2"	1/2"
149006	3/4"	1/2"

## DISCHARGE HOSE FITTINGS

- Designed for use with stainless steel braided discharge hose
- All brass bodies with brass sleeves and steel nuts

### Fitting Sleeves



5/8" O.D. Part #	3/4" O.D. Part #	Type
142104	142105	Sleeve
142108	142109	Nut

### Straight Tubes



Part #	Hose O.D.
142102	5/8"
142103	3/4"

### Male Pipe Fittings



Part #	Hose O.D.	Pipe Thread
142101	5/8"	1/2" - 14

### Compression Fittings



Part #	Hose O.D.	Male Thread
142106	5/8"	13/16" - 18
142107	3/4"	1" - 18

### Female Swivel Fittings



Part #	Hose O.D.	Female Thread
142110	5/8"	7/8" - 14
142111	3/4"	1-1/16" - 14



Call the Velvac Sales Team: **800.783.8871** sales@velvac.com

© VELVAC INC. • 2405 South Calhoun Road • New Berlin, WI 53151-2709 • Toll Free: 800.783.8871 • Fax: 262.786.4101

# FITTINGS & HARDWARE

## FULLER TRANSMISSION COMPRESSION FITTINGS

- Designed for use with polyethylene nylon and plastic tubing  
NOT FOR AIR BRAKE USE
- All brass construction

### Sleeves



Part #	Tube Size
010093	3/16"

### Male Connectors



Part #	Tube Size	Pipe Size
012016	1/8"	1/16"
012015	3/16"	1/8"
012012	5/32"	1/16"
012014	5/32"	1/8"
012022	1/8"	1/8"

### Male Elbows



Part #	Tube Size	Pipe Size
012069	1/8"	1/8"
012064	5/32"	1/8"
012066	1/8"	1/8"
012068	3/16"	1/8"

### Nuts



Part #	Tube Size
011012	1/8"
011014	3/16"
011016	5/32"

### Slotted Collets



Part #	Tube Size
011000	1/8"
011020	5/32"

### Insert



Part #	Tube Size
010085	3/16"

### Full Unions



Part #	Tube Size
011032	1/8"
011034	5/32"

## INVERTED FLARE FITTINGS

- Designed for use with flareable copper, brass, aluminum and welded steel hydraulic tubing
- All brass construction (unless otherwise noted)
- UL compliant for flammable liquid and gas
- Fittings meet SAE J246 requirements
- DOT compliant

### Male Connectors



Part #	Tube Size	Pipe Size	Straight Thread
006842	1/4"	1/8"	7/16" - 24
006852	5/16"	1/8"	1/2" - 20
006854	5/16"	1/4"	1/2" - 20
006864	3/8"	1/4"	5/8" - 18
006866	3/8"	3/8"	5/8" - 18
006886	1/2"	3/8"	3/4" - 18

### Male Elbows



Part #	Tube Size	Pipe Size	Straight Thread
006942	1/4"	1/8"	7/16" - 24

### Nuts



Part #	Tube Size	Straight Thread
006103	3/16"	3/8" - 24
006104	1/4"	7/16" - 24
006106	3/8"	5/8" - 10

- Brass construction

Part #	Tube Size	Straight Thread
006304	1/4"	7/16" - 24
006305	5/16"	1/2" - 24

### Female Connectors



Part #	Tube Size	Pipe Size	Straight Thread
006642	1/4"	1/8"	7/16" - 24
006664	3/8"	1/4"	5/8" - 18

### Unions



Part #	Tube Size	Straight Thread
006203	3/16"	3/8" - 24
006204	1/4"	7/16" - 24
006205	5/16"	1/2" - 20
006206	3/8"	5/8" - 18

**NOTE: Part numbers listed in RED are NEW!**

# FITTINGS & HARDWARE

## PIPE FITTINGS

### Pipe Crosses



Part #	Pipe Size	Material
017075	1/4"	Brass
017077	3/8"	Brass
017078	1/2"	Brass

### Close Nipples



Part #	Pipe Size	Material
016051	1/8"	Brass
016052	1/4"	Brass
016053	3/8"	Brass
016054	1/2"	Brass
016065	3/4"	Malleable iron

### Caps

(Female Pipe Fittings)



Part #	Pipe Size
017223	1/8"
017224	1/4"
017225	3/8"
017226	1/2"
017227	3/4"

### Hex Nipples



Part #	Pipe Size	Material
018009	1/8"	Brass
018010	1/4"	Brass
018011	3/8"	Brass
018012	1/2"	Brass
018023	3/4"	Plated steel

### Male Branch Tees



Part #	Pipe Size	Material
016014	1/8"	Brass
016015	1/4"	Brass
016016	3/8"	Brass
016017	1/2"	Brass

### Pipe Elbows



Part #	Pipe Size	Material
017003	1/8"	Brass
017004	1/4"	Brass
017005	3/8"	Brass
017006	1/2"	Brass

### 45° Street Elbows



Part #	Pipe Size	Material
017023	1/8"	Brass
017025	1/4"	Brass
017027	3/8"	Brass
017029	1/2"	Brass

### Pipe Tees



Part #	Pipe Size	Material
016001	1/8"	Brass
016002	1/4"	Brass
016003	3/8"	Brass
016004	1/2"	Brass
016005	3/4"	Brass

### Pipe Nipples



• Brass

Part #	Pipe Size	Length
016021	1/8"	1-1/2"
016025	1/4"	1-1/2"
016029	3/8"	1-1/2"
016033	1/2"	1-1/2"
016044	1/4"	2 1/2"
016045	3/8"	2 1/2"
016046	3/8"	3"
016047	3/4"	2 1/2"

• Malleable Iron

Part #	Pipe Size	Length
016037	1/8"	2"
016038	1/4"	2"
016039	3/8"	2"
016040	1/2"	2"
016041	1/2"	3"
016042	3/4"	2"
016043	3/4"	3"

### Reducer Bushings



• Brass

Part #	Pipe Size	Material
016079	1/4" x 1/8"	Brass
016089	1/4" x 1"	Brass
016080	3/8" x 1/8"	Brass
016081	3/8" x 1/4"	Brass
016082	1/2" x 1/8"	Brass
016083	1/2" x 1/4"	Brass
016084	1/2" x 3/8"	Brass
016088	1/2" x 1"	Brass
016085	3/4" x 1/4"	Brass
016086	3/4" x 3/8"	Brass
016087	3/4" x 1/2"	Brass
017000	1" x 3/4"	Malleable iron



Call the Velvac Sales Team: **800.783.8871** [sales@velvac.com](mailto:sales@velvac.com)

© VELVAC INC. • 2405 South Calhoun Road • New Berlin, WI 53151-2709 • Toll Free: 800.783.8871 • Fax: 262.786.4101

# FITTINGS & HARDWARE

## PIPE FITTINGS

### Street Tees



Part #	Pipe Size	Material
017091	1/8"	Brass
017093	1/4"	Malleable iron
017095	3/8"	Malleable iron
017096	1/2"	Malleable iron
017094	3/4"	Brass

### Street Elbows

- Brass construction



Part #	Pipe Size	Material
017015	1/8"	Brass
017039	1/4" x 1/8"	Brass
017017	1/4"	Brass
017019	3/8"	Brass
017021	1/2"	Brass
017031	3/4"	Brass

### Hex Head Plugs



Part #	Pipe Size	Material
017051	1/8"	Brass
017053	1/4"	Brass
017055	3/8"	Brass
017057	1/2"	Brass
017056	3/4"	Brass
017058	1"	Brass

### Square Head Plugs



Part #	Pipe Size	Material
017061	1/8"	Plated steel
017063	1/4"	Plated steel
017065	3/8"	Plated steel
017067	1/2"	Plated steel
017069	3/4"	Plated steel
017059	3/4"	Brass
017072	1"	Brass

### Reducer Couplings



Part #	Pipe Size	Material
017081	1/4" x 1/8"	Brass
017083	3/8" x 1/4"	Brass
017089	1/2" x 1/4"	Brass
017085	1/2" x 3/8"	Brass
017090	3/4" x 1/2"	Brass

### Reducer Hex Nipples



Part #	Pipe Size	Material
018013	1/4" x 1/8"	Brass
018030	3/8" x 1/8"	Brass
018025	3/8" x 1/4"	Plated steel
018026	1/2" x 1/4"	NPTF
018027	1/2" x 3/8"	Plated steel
018029	3/4" x 1/2"	Plated steel

### Counter-Sunk Plugs



Part #	Pipe Size	Material
017106	1/8"	Brass
017107	1/4"	Brass
017108	3/8"	Brass
017109	1/2"	Brass
017110	3/4"	Brass

### Couplings



Part #	Pipe Size	Material
016067	1/8"	Brass
016068	1/4"	Brass
016069	3/8"	Brass
016070	1/2"	Brass
016077	3/4"	Malleable iron

### Adapters



Part #	Pipe Size	Material
018034	1/8" x 1/8"	Brass
018006	1/4" x 1/8"	Brass
018035	1/4" x 1/4"	Brass
018007	3/8" x 1/4"	Brass
018036	3/8" x 1/8"	Brass
018037	3/8" x 3/8"	Brass
018008	1/2" x 3/8"	Brass
018038	3/4" x 1/2"	Brass

### Slotted Plugs



Part #	Pipe Size	Material
017101	1/8"	Brass
017102	1/4"	Brass
017103	3/8"	Brass

**NOTE: Part numbers listed in RED are NEW!**



# FITTINGS & HARDWARE

## SAE 45° FLARE FITTINGS

- Designed for use with flareable copper, brass, aluminum and welded steel hydraulic tubing
- All brass construction
- UL compliant for flammable liquid and gas
- Fittings meet SAE J246 requirements

### Hose Barb to Female Flare Swivels



Part #	Tube Size	Hose Size
016945	3/8"	3/8"
016948	1/4"	1/4"

### Male Connectors



Part #	Tube Size	Pipe Size	Straight Thread
014822	1/8"	1/8"	5/16" - 24
014832	3/16"	1/8"	3/8" - 24
014842	1/4"	1/8"	7/16" - 20
014844	1/4"	1/4"	7/16" - 20
014210	1/4"	3/8"	7/16" - 20
014211	3/8"	3/4"	5/8" - 18
014852	5/16"	1/8"	1/2" - 20
014854	5/16"	1/4"	1/2" - 20
014862	3/8"	1/8"	5/8" - 18
014864	3/8"	1/4"	5/8" - 18
014866	3/8"	3/8"	5/8" - 18
014868	3/8"	1/2"	5/8" - 18
014884	1/2"	1/4"	3/4" - 16
014886	1/2"	3/8"	3/4" - 16
014212	5/8"	3/4"	7/8" - 14
014888	1/2"	1/2"	3/4" - 16
014806	5/8"	3/8"	7/8" - 14
014808	5/8"	1/2"	7/8" - 14
014818	3/4"	1/2"	1-1/16"-14
014811	3/4"	3/4"	1-1/16"-14

### Unions



Part #	Tube Size	Straight Thread
014204	1/4"	7/16" - 20
014206	3/8"	5/8" - 18
014208	1/2"	3/4" - 16
014200	5/8"	7/8" - 14
014209	3/4"	1 1/16" - 14

### Male Elbows



Part #	Tube Size	Pipe Size	Straight Thread
014942	1/4"	1/8"	7/16" - 20
014944	1/4"	1/4"	7/16" - 20
014946	1/4"	3/8"	7/16" - 20
014952	5/16"	1/8"	1/2" - 20
014962	3/8"	1/8"	5/8" - 18
014964	3/8"	1/4"	5/8" - 18
014966	3/8"	3/8"	5/8" - 18
014968	3/8"	1/2"	5/8" - 18
014984	1/2"	1/4"	3/4" - 16
014986	1/2"	3/8"	3/4" - 16
014988	1/2"	1/2"	3/4" - 16
014906	5/8"	3/8"	7/8" - 14
014908	5/8"	1/2"	7/8" - 14
014918	3/4"	1/2"	1-1/16"-14
014911	3/4"	3/4"	1-1/16"-14

### 45° Elbows



Part #	Tube Size	Pipe Size	Straight Thread
015942	1/4"	1/8"	7/16" - 20
015944	1/4"	1/4"	7/16" - 20
015964	3/8"	1/4"	5/8" - 18
015966	3/8"	3/8"	5/8" - 18
015986	1/2"	3/8"	3/4" - 16
015988	1/2"	1/2"	3/4" - 16
015906	5/8"	3/8"	7/8" - 14
015908	5/8"	1/2"	7/8" - 14

### Long Nuts



Part #	Tube Size	Straight Thread
014106	3/8"	5/8" - 18

### Cap Nuts



Part #	Tube Size	Straight Thread
014216	3/8"	5/8" - 18
014217	1/2"	3/4" - 16
014218	5/8"	7/8" - 14



Call the Velvac Sales Team: **800.783.8871** sales@velvac.com

© VELVAC INC. • 2405 South Calhoun Road • New Berlin, WI 53151-2709 • Toll Free: 800.783.8871 • Fax: 262.786.4101



# FITTINGS & HARDWARE

## INVERTED FLARE FITTINGS

- Designed for use with flareable copper, brass, aluminum and welded steel hydraulic tubing
- All brass construction (unless otherwise noted)
- UL compliant for flammable liquid and gas
- Fittings meet SAE J246 requirements
- DOT compliant

### Male Connectors



Part #	Tube Size	Pipe Size	Straight Thread
006842	1/4"	1/8"	7/16" - 24
006852	5/16"	1/8"	1/2" - 20
006854	5/16"	1/4"	1/2" - 20
006864	3/8"	1/4"	5/8" - 18
006866	3/8"	3/8"	5/8" - 18
006886	1/2"	3/8"	3/4" - 18

### Female Connectors



Part #	Tube Size	Pipe Size	Straight Thread
006642	1/4"	1/8"	7/16" - 24
006664	3/8"	1/4"	5/8" - 18

### Nuts



Part #	Tube Size	Straight Thread	Material
006103	3/16"	3/8" - 24	Brass
006104	1/4"	7/16" - 24	Brass
006106	3/8"	5/8" - 10	Brass
006304	1/4"	7/16" - 24	Plated steel
006305	5/16"	5/16" - 24	Plated steel

### Unions



Part #	Tube Size	Straight Thread
006203	3/16"	3/8" - 24
006204	1/4"	7/16" - 24
006205	5/16"	1/2" - 20
006206	3/8"	5/8" - 18

### Male Elbows



Part #	Tube Size	Pipe Size	Straight Thread
006942	1/4"	1/8"	7/16" - 24

## TRUCK & TRAILER REPAIR KITS

### Transmission Air Line Repair Kit

- 11 total fittings

Part #	Description	Qty.
016112	1/8 x 1/8" Male connector	1
016120	5/32 x 1/16" Male connector	2
016122	5/32 x 1/8" Male connector	2
016212	1/8 x 1/8" Male connector	1
016222	5/32 x 1/8" Male connector	1
016610	1/8" Union	1
016620	5/32" Union	1
016630	3/16" Union	1
090028	Nylon tube cutter	1

### Nylon Air Brake Tube Fitting Kit

- 33 total fittings

Part #	Description	Qty.
016240	1/4" Full union	2
016260	3/8" Full union	2
016280	1/2" Full union	2
016200	5/8" Full union	2
016842	1/4 x 1/8" Male connector	2
016844	1/4 x 1/4" Male connector	3
016864	3/8 x 1/4" Male connector	2
016866	3/8 x 3/8" Male connector	1

**NOTE: See next page for kit part numbers**

Part #	Description	Qty.
016886	1/2 x 3/8" Male connector	1
016942	1/4 x 1/8" Male elbow	2
016944	1/4 x 1/4" Male elbow	3
016964	3/8 x 1/4" Male elbow	2
016966	3/8 x 3/8" Male elbow	3
016986	1/2 x 3/8" Male elbow	2
016988	1/2 x 1/2" Male elbow	2

**NOTE: Part numbers listed in RED are NEW!**

# FITTINGS & HARDWARE

## TRUCK & TRAILER REPAIR KITS



Part #	Description
690031	In-Cab Air Line Repair Kit - Push Lock
690033	Air Brake Line Repair Kit - Push Lock
690035	Nylon Tubing Repair Kit - Push Lock
690037	Transmission Air Line Repair Kit - Push Lock
690050	NTA Fitting Kit

### In-Cab Air Line Repair Kit

- 24 total fittings

Part #	Description	Qty.
016112	1/8 x 1/8" Male connector	2
016114	1/8 x 1/4" Male connector	2
016142	1/4 x 1/8" Male connector	2
016144	1/4 x 1/4" Male connector	2
016162	3/8 x 1/8" Male connector	1
016164	3/8 x 1/4" Male connector	1
016242	1/4 x 1/8" Elbow	1
016244	1/4 x 1/4" Elbow	1
016264	3/8 x 1/4" Elbow	1
016610	1/8" Union	2
016630	3/16" Union	2
016640	1/4" Union	2
016660	3/8" Union	1
016910	1/8" Tee	1
016930	3/16" Tee	1
016940	1/4" Tee	1
016960	3/8" Tee	1

### Air Brake Line Repair Kit

- 24 total fittings

Part #	Description	Qty.
016166	3/8 x 3/8" Male connector	2
016168	3/8 x 1/2" Male connector	1
016184	1/2 x 1/4" Male connector	1
016268	3/8 x 1/2" Male connector	1
016284	1/2 x 1/4" Male connector	1
016286	1/2 x 3/8" Male connector	1
016186	1/2 x 3/8" Male connector	2
016188	1/2 x 1/2" Male connector	1
016660	3/8" Union	2
016680	1/2" Union	2
016266	3/8 x 3/8" Elbow	2
016288	1/2 x 1/2" Elbow	1
016960	3/8" Tee	2
016980	1/2" Tee	2

### Nylon Tubing Repair Kit

Part #	Description	Qty.
020132	1/8" Blue nylon tubing	2'
020065	5/32" Black nylon tubing	2'
020066	3/16" Black nylon tubing	2'
020164	1/4" Yellow nylon tubing	2'
020156	3/8" Red nylon tubing	2'
020168	1/2" Yellow nylon tubing	2'
016610	1/8" Union	2
016620	5/32" Union	2
016630	3/16" Union	2
016640	1/4" Union	2
016660	3/8" Union	2
016680	1/2" Union	2
090014	7" Nylon tie straps	12
090028	Nylon tube cutter	1



Call the Velvac Sales Team: **800.783.8871** [sales@velvac.com](mailto:sales@velvac.com)

© VELVAC INC. • 2405 South Calhoun Road • New Berlin, WI 53151-2709 • Toll Free: 800.783.8871 • Fax: 262.786.4101

## FITTING ASSORTMENTS

### Large Air Brake Fitting Assortment

- Assortment includes the following part numbers and quantities plus rack 690090 (in RETAIL section)

Part #	Quantity
010087	50
010089	50
010094	25
010096	25
010098	25
011001	25
011003	50
011005	25
011007	10
011009	10
011013	25
011023	15
011025	5
011027	3
011029	3
011033	10

Part #	Total Fittings
690059	583

Part #	Quantity
011041	15
011043	10
011045	3
011047	2
011057	5
011059	3
011073	5
012017	10
012021	10
012035	5
012037	20
012041	10
012043	5
012045	10
012047	10
012049	5

**NOTE**  
See previous pages for fitting photos and descriptions.

Part #	Quantity
012053	3
012055	3
012067	10
012071	10
012087	5
012091	20
012093	5
012095	5
012097	5
013001	10
013003	5
013011	3
013041	5
013057	5
013075	5
690090	1

### Push-Lock Fitting Assortment

- Assortment includes the following part numbers and quantities plus rack 690090 (in RETAIL section)

Part #	Quantity
016112	5
016114	5
016120	5
016122	5
016142	5
016144	5
016162	5
016164	5
016166	5
016168	5

Part #	Total Fittings
690072	155

Part #	Quantity
016184	5
016186	5
016188	5
016242	5
016244	5
016264	5
016266	5
016268	5
016284	5
016286	5
016288	5



Part #	Quantity
016610	5
016620	5
016630	5
016640	5
016660	5
016680	5
016930	5
016940	5
016960	5
016980	5
690090	1

# FITTINGS & HARDWARE

## FITTING ASSORTMENTS

### Nylon Air Brake Tube Fitting Assortment

- Assortment includes the following part numbers and quantities plus rack 690090 (in RETAIL section)

Part #	Total Fittings
690071	304



Part #	Quantity
016100	3
016101	3
016140	25
016160	10
016180	5
016200	3
016201	2
016240	10
016260	5
016280	5
016300	10
016301	10
016340	25
016360	25

Part #	Quantity
016380	25
016808	3
016818	2
016842	10
016844	10
016862	5
016864	5
016866	5
016884	5
016886	5
016888	5
016908	3
016916	5
016918	2

Part #	Quantity
016922	5
016942	10
016944	10
016962	5
016964	5
016966	5
016968	5
016984	5
016986	5
016988	5
017264	5
017266	5
017286	3
690090	1

### Brass Pipe Fitting Assortment

- Assortment includes the following part numbers and quantities plus rack 690090 (in RETAIL section)

Part #	Total Fittings
690064	340



Part #	Quantity
016001	5
016002	5
016003	5
016004	5
016051	10
016052	20
016053	20
016054	5
016067	10
016068	10
016069	5
016070	5

Part #	Quantity
016079	10
016080	10
016081	30
016083	5
016084	5
016087	5
017015	5
017017	5
017019	5
017021	5
017023	5
017025	5
017027	5

Part #	Quantity
017029	5
017051	10
017053	20
017055	20
017057	5
018006	10
018007	10
018008	10
018009	10
018010	20
018011	10
018012	5
690090	1



Call the Velvac Sales Team: **800.783.8871** [sales@velvac.com](mailto:sales@velvac.com)

© VELVAC INC. • 2405 South Calhoun Road • New Berlin, WI 53151-2709 • Toll Free: 800.783.8871 • Fax: 262.786.4101

# FITTINGS & HARDWARE

## HOSE CLAMPS AND COOLANT VALVES

### Miniature/General Purpose Slotted/Liner/EuroSeal® Clamps

- All clamps feature 300 series stainless steel bands
- Miniature, general purpose and liner clamps include yellow dichromate slotted hex head screws. Euro-Seal® clamps feature 300 series stainless steel screws



Miniature clamps ideal for use on air and fuel lines



General purpose slotted clamps meet applicable SAE J1508 requirements

Miniature Clamps	General Purpose Slotted Clamps	Liner Clamps	Euro-Seal® Clamps	SAE Size	Clamping Range (in.)
022204	-	-	-	4	7/32 – 5/8
022206	022306	022106	022506	6	5/16 – 5/8
-	022308	022108	022508	8	1/2 – 55/64
-	022310	022110	022510	10	5/8 – 1-1/16
-	022312	022112	022512	12	3/4 – 1-1/4
-	022316	022116	022516	16	1 – 1-5/8
-	022320	022120	022520	20	1-11/64 – 1-3/4
-	022324	022124	022524	24	1-1/4 – 2
-	022328	022128	022528	28	1-5/8 – 2-3/8
-	022332	022132	022532	32	1-3/4 – 2-1/2
-	022336	022136	022536	36	2 – 2-3/4
-	022340	022140	022540	40	2-5/32 – 2-15/16
-	022344	022144	022544	44	2-3/8 – 3-1/8
-	022348	022148	022548	48	2-3/4 – 3-1/2
-	022352	-	-	52	2-13/16 – 3-3/4
-	022356	-	022556	56	3-1/8 – 4
-	022360	-	-	60	3-1/2 – 4-3/8
-	022364	-	022564	64	4 – 4-3/4
-	022372*	-	022572	72	4-3/8 – 5-1/8
-	022380*	-	022680	80	4-3/4 – 5-1/2
-	022388*	-	022688	88	5-1/8 – 5-7/8
-	022396*	-	-	96	5-9/16 – 6-1/2
-	022404*	-	022574	104	6-1/4 – 7-5/64

\*These clamps may be made smaller than the clamping range shows in the table. Following are the smallest diameters for each of these clamps in the order shown on the chart: 1-7/8", 2-1/2", 3-1/8", 3-5/8", 4-1/8"



Euro-Seal® clamps with embossed threads and rounded band edge help eliminate hose abrasion and damage. Clamps meet or exceed international specifications for material, corrosion resistance, sizing and torque



Liner clamps designed with inner liner to protect silicone hose from extruding through band slots; unique construction allows more tightening torque to the perforations while maximizing vibration resistance

Euro-Seal® is a registered trademark of Breeze Industrial Products



# FITTINGS & HARDWARE

## HOSE CLAMPS AND COOLANT VALVES

### Spring Loaded T-Bolt Clamps

- Eliminates "cold flow hose leaks" by automatically adjusting diameter for hose compression set or expansion/contraction of hose and fittings due to temperature changes
- Recommended for bus, truck and heavy-duty equipment air intake and coolant connectors
- 300 series stainless steel band, floating bridge liner and trunion
- Yellow dichromate plated steel bolt, spring, washer and 1/2" lock-nut
- Clamps meet applicable SAE J1508 requirements

Part #	Clamping Range (mm)	Clamping Range (in.)
022580	57 - 65	2-1/4 - 2-9/16
022581	67 - 77	2-3/4 - 3-1/16
022582*	78 - 86	3-1/16 - 3-3/8
022583	87 - 95	3-7/16 - 3-3/4
022584*	90 - 98	3-9/16 - 3-7/8
022585	98 - 106	3-7/8 - 4-3/16
022626*	103 - 111	4-1/16 - 4-3/8
022586	106 - 114	4-3/16 - 4-1/2
022627*	116 - 124	4-9/16 - 4-7/8

\* Designed for change-air cooling



### T-Bolt Clamps

- Applications include engine air intake, exhaust, hoses, filters and low pressure hydraulic connections
- 300 series stainless steel band, floating bridge liner and trunion
- Yellow dichromate plated steel bolt and 7/16" locknut
- Clamps meet applicable SAE J1508 requirements

Part #	Clamping Range (mm)	Clamping Range (in.)
022550	63 - 71	2-1/2 - 2-13/16
022551	67 - 77	2-3/4 - 3-1/16
022587	76 - 84	3 - 3-5/16
022588	83 - 90	3-1/4 - 3-9/16
022589	87 - 98	3-7/16 - 3-7/8
022591	95 - 103	3-3/4 - 4-1/16
022592	108 - 116	4-1/4 - 4-9/16
022593	121 - 128	4-3/4 - 5-1/16
022557	133 - 141	5-1/4 - 5-9/16
022594	146 - 154	5-3/4 - 6-1/16
022596	159 - 166	6-1/4 - 6-9/16
022597	184 - 192	7-1/4 - 7-9/16
022598	216 - 223	8-1/2 - 8-13/16



Call the Velvac Sales Team: **800.783.8871** [sales@velvac.com](mailto:sales@velvac.com)

© VELVAC INC. • 2405 South Calhoun Road • New Berlin, WI 53151-2709 • Toll Free: 800.783.8871 • Fax: 262.786.4101

## HOSE CLAMPS AND COOLANT VALVES

### Constant-Torque® Clamps

- Patented Belleville spring design eliminates "cold flow hose leaks" by automatically adjusting diameter for hose compression set or expansion/contraction of hose and fittings due to temperature changes
- Specified by many top fleets for new vehicle installations
- Recommended for bus, truck and heavy-duty equipment air intake and coolant connections
- Extended inner liner covers worm gear slots to protect against extrusions and damage
- All stainless steel construction
- Extended adjustment range permits fewer stocked parts

**NOTE:** For proper installation, the Belleville spring washer stacks should be nearly collapsed flat and the screw tip should extend beyond 1/4". Using a torque wrench, tighten to recommended torque range

Part #	Clamping Range (mm)	Clamping Range (in.)
Torque rated at 30-70 in./lb.		
022410	14 – 27	9/16 – 1-1/16
022412	17 – 32	11/16 – 1-1/4
022416	21 – 38	13/16 – 1-1/2
022420	21 – 44	13/16 – 1-3/4
022424	27 – 51	1-1/16 – 2
Torque rated at 40-125 in./lb.		
022400	32 – 54	1-1/4 – 2-1/8
022425	45 – 67	1-3/4 – 2-5/8
022430	57 – 79	2-1/4 – 3-1/8
022435	70 – 92	2-3/4 – 3-5/8
022440	83 – 105	3-1/4 – 4-1/8
022445	95 – 118	3-3/4 – 4-5/8
022450	108 – 130	4-1/4 – 5-1/8

### Hi-Torque® Clamps

- Heavy gauge housing engineered so eight screw threads are simultaneously engaged to provide over four times the recommended SAE torque requirements of standard worm drive clamps
- All stainless steel construction
- Extended diameter ranges allow coverage from 1-1/4" to 9-1/8" with only four clamps
- Clamps exceed applicable SAE J1508 requirements

Part #	Clamping Range (mm)	Clamping Range (in.)
022462	32 – 67	1-1/4 – 2-5/8
022463	54 – 105	2-1/8 – 4-1/8
022464	102 – 156	4 – 6-1/8
022465	156 – 232	6-1/8 – 9-1/8



Constant-Torque® clamp



Hi-Torque® clamp

Constant-Torque® and Hi-Torque® are registered trademarks of Breeze Industrial Products

# FITTINGS & HARDWARE

## HOSE CLAMPS AND COOLANT VALVES

### Muffler Clamps/Saddle Clamps

- Heavy duty clamp with round 3/8-16
- Zinc plated for corrosion protection
- Complete with grade 2 serrated flange nuts
- Individually packaged

Part #	Size
022048	1.75"
022049	2"
022050	2.5"
022051	3"
022052	3.5"
022053	4"
022054	4.5"
022055	5"



Muffler/saddler clamp

### Flat Band Clamp

- Manufactured with a stainless steel band for corrosion protection
- Clamp assembly consists of a stainless steel band with one spacer, two bolts and one reaction block pre-attached to band with one spacer and two nuts packaged with the band

Part #	Size
022059	4"
022060	5"



Flat band clamp

### Guillotine Style Clamp

- Heavy-duty guillotine clamps are manufactured with a round 3/8 - 16 u-bolt and are zinc plated for corrosion protection
- Clamp contains a reinforced rib design for enhanced strength
- Packaged individually in a poly bag
- Complete with grade 2 serrated flange nuts

Part #	Size
022056	4"
022057	4.5"
022058	5"



Guillotine style clamp



Call the Velvac Sales Team: **800.783.8871** [sales@velvac.com](mailto:sales@velvac.com)

© VELVAC INC. • 2405 South Calhoun Road • New Berlin, WI 53151-2709 • Toll Free: 800.783.8871 • Fax: 262.786.4101

## HOSE CLAMPS AND COOLANT VALVES

### Turbo V-Band Clamp

Part #	Nominal (in.)	Clamp Dimensions (in.)					Application
		A	B	C	D	E	
022470	3.82	.077	.207	.281	.040	.875	CAT, DDC, Ford, GMC, Navistar
022471	3.88	.050	.400	.281	.040	.875	Cummins, Ford, Volvo
022472	4.50	.077	.207	.281	.040	.875	DDC, GMC, Navistar
022473	4.61	.050	.156	.218	.035	.750	Mack, Switzer
022474	4.75	.077	.158	.310	.040	.875	Cummins, CAT, Freightliner, GMC, Navistar, Volvo, Western Star
022475	5.25	.050	.262	.141	.035	.750	DDC, Navistar, Freightliner
022476	5.88	.050	.400	.281	.040	.875	Cummins, DDC, CAT
022477	4.50	.050	.262	.141	.035	.750	Navistar
022478	3.21	.050	.262	.141	.035	.750	Cummins, Freightliner, Blue Bird bus, Ford, Oshkosh

- Clamps connect vehicle exhaust pipe flange to turbo or engine manifold
- Built to withstand high temperatures produced by heavy-duty engines and turbos
- All stainless steel construction
- Clamps meet or exceed OEM standards for material and quality

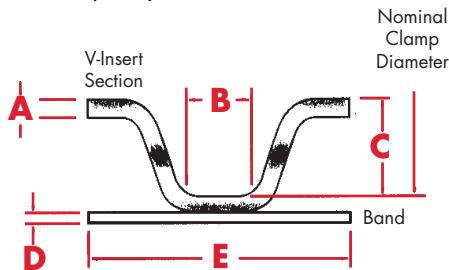

**AIR INTAKE SYSTEM**  
Hi-Torque or T-Bolt

**TURBO EXHAUST MANIFOLD**  
V-Bolt

**FUEL LINE**  
Miniature

**CHARGE AIR COOLING, AIR TO AIR AFTER-COOLING SYSTEM**  
Spring-Loaded T-Bolt

**COOLANT SYSTEM**  
Constant Torque or Hi-Torque

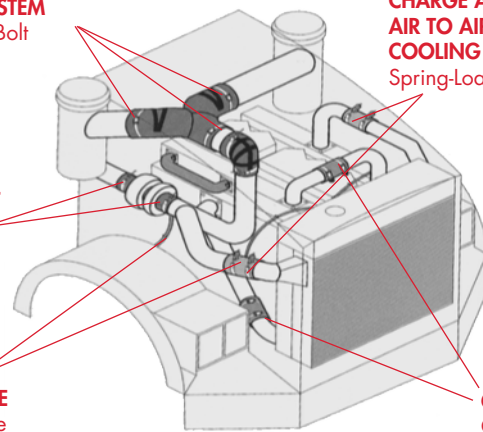

### Coolant Shutoff Valves

- All brass construction

Part #	O.D.	Pipe Size
023066	3/8"	3/8"
023106	5/8"	3/8"
023108	5/8"	1/2"
023126	3/4"	3/8"
023128	3/4"	1/2"



# FITTINGS & HARDWARE

## CLEVIS AND CLEVIS PINS

### Clevis

- Forged steel construction
- Zinc-plated for corrosion resistance

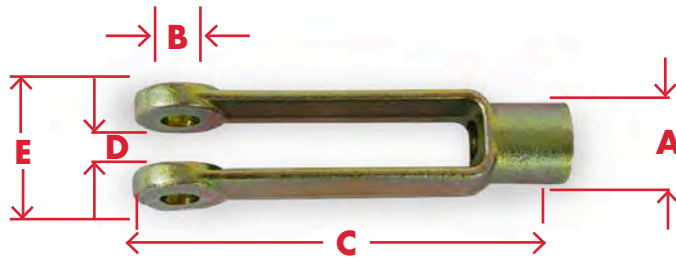

Part #	A	B	C	D	E
019002	1/4" - 28	1/4"	2"	9/32"	5/8"
019003	5/16" - 24	5/16"	2-1/4"	11/32"	3/4"
019004	3/8" - 24	3/8"	2-1/2"	7/16"	7/8"
019006	1/2" - 20	1/2"	3"	9/16"	1-1/8"
019009	1/2" - 20	1/2"	1-7/8"	9/16"	1-1/4"
019011	5/8" - 18	1/2"	1-7/8"	9/16"	1-1/4"
019013	5/8" - 18	1/2"	2-5/16"	9/16"	1-1/2"
019015	5/8" - 18	5/8"	4-15/16"	11/16"	1-3/8"
019017	5/8" - 18	5/8"	2-5/16"	9/16"	1-1/2"

### Clevis and Clevis Pin Kits

- Each kit includes one yoke, clevis pin and cotter pin
- Forged steel construction
- Zinc-plated for corrosion resistance

Part #	A	B	C	D	E	F	G	H
019049	5/8" - 18	1/2"	1-7/8"	9/16"	1-1/4"	1/2"	1-1/2"	1-3/8"
019050	1/2" - 20	1/2"	1-7/8"	9/16"	1-1/4"	1/2"	1-1/2"	1-3/8"
019051	5/8" - 18	1/2"	4-15/16"	9/16"	1-1/4"	1/2"	1-5/8"	1-3/8"
019088*	5/8" - 18	1/2"	1-7/8"	9/16"	1-1/4"	1/2"	1-1/2"	1-11/32"

\*Includes 3/8" x 1/4" reducer bushing and 5/8" - 18 hex nut

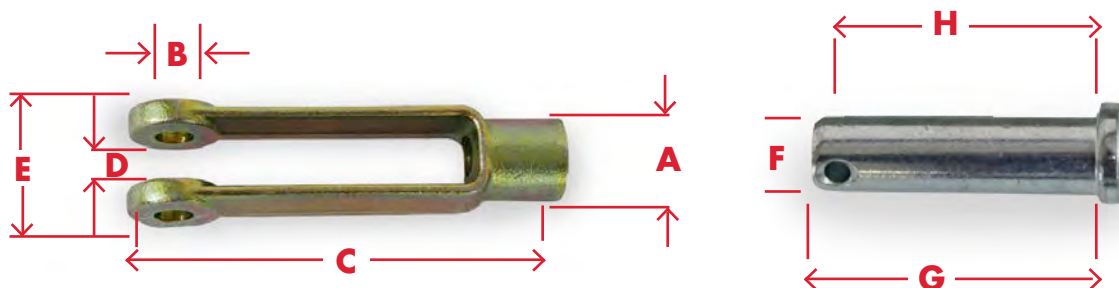

Call the Velvac Sales Team: **800.783.8871** [sales@velvac.com](mailto:sales@velvac.com)

© VELVAC INC. • 2405 South Calhoun Road • New Berlin, WI 53151-2709 • Toll Free: 800.783.8871 • Fax: 262.786.4101



### Standard Clevis Pin

Part #	Nominal Size	A	B
019057	1/4	0.672"	0.633"
019059	5/16	0.812"	0.757"
019061	3/8	0.938"	0.883"
019065	1/2	1.203"	1.133"
019067	1/2	1.343"	1.273"
019069	1/2	1.593"	1.523"
019071	5/8	1.453"	1.383"
019073	5/8	1.593"	1.523"

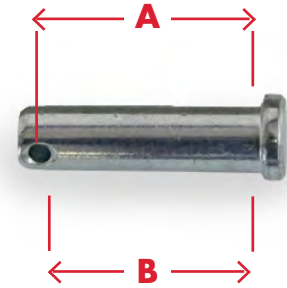

### Universal Clevis Pin

- Each includes cotter pin

Part #	A	B	C
019058	1/4"	2"	17/32"
019060	5/16"	2"	9/16"
019062	3/8"	2"	17/32"
019064	7/16"	2"	9/16"
019070	1/2"	2"	9/16"
019072	5/8"	3"	9/32"

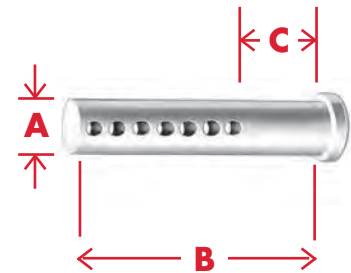

\*Holes are spaced at 1/4" intervals

## THE VELVAC DIFFERENCE

In the passing  
lane since 1934.



Velvac is TS 16949 &  
ISO 14001 certified.



For over 80 years **Velvac** has been providing high quality, innovative products with a focus on safety, value and great customer service. We stay out in front to help you stay ahead of your competition — that's what being in the passing lane is all about.



[velvac.com](http://velvac.com)



Call the Velvac Sales Team: **800.783.8871** [sales@velvac.com](mailto:sales@velvac.com)

© VELVAC INC. • 2405 South Calhoun Road • New Berlin, WI 53151-2709 • Toll Free: 800.783.8871 • Fax: 262.786.4101

**OUR PARTS PUT YOU IN THE PASSING LANE**

# FUEL SYSTEMS

## Protect your fuel system.

Velvac offers a wide range of locking fuel caps and anti-siphon tubes to keep unlawful occurrences at bay. With OEM approved designs and patented locking features, Velvac has your back.

- Fuel caps
- Anti-siphon tubes
- Tank valves



# FUEL SYSTEMS

## ALUMINUM NON-LOCKING FUEL CAPS — Designed for Diesel Fuel Applications

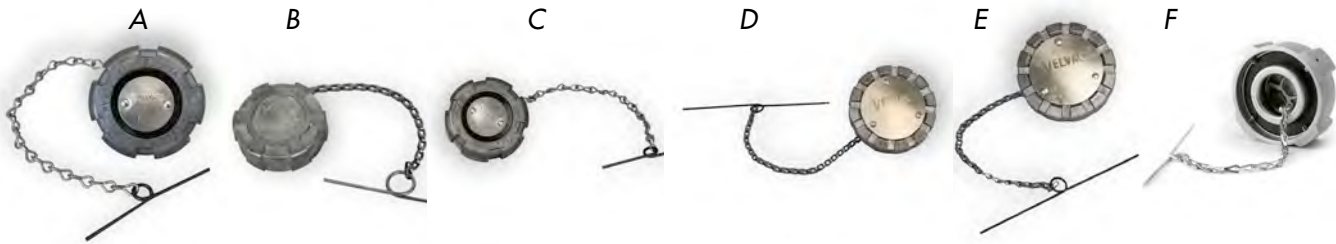

Part #	Photo	Type	V	T/R	P/R	Nominal Size	Threads Per Inch	Across Cap	Threads Filler Neck
600135	A	Female	•	•	•	2"	11-1/2 NPSH	2-1/4"	2-1/4"
600198	B	Female	-	•	-	2"	11-1/2 NPSH	2-1/4"	2-1/4"
600136	C	Female	•	•	•	2"	8 UN 2B	2-1/4"	2-1/4"
600186	D	Female Replaces Freightliner A03-12927-4 and Kenworth K071-398**	•	•	•	2"	11-1/2 NPSH	2-1/4"	2-1/4"
600184	E	Female Replaces Freightliner A03-15682-4 and Western Star 43301-3401*	•	•	•	3"	8 NPSL	3.37"	3.37"
600148	F	Female, 1/4 Turn Replaces Freightliner 03-37017-000	-	•	-	3"	CAM CAP	N/A	N/A
600168	G	Female	-	•	-	3"	8 NPSL	4.35"	4.35"
600180	H	Female	•	•	•	4"	8 NPSM	4.35"	4.35"
600172	I	Male	-	•	-	4-1/4"	8	4-1/4"	4-1/8"
601065	J	Bayonet	•	-	-	4"	N/A	3-7/8"	3-7/8"
600260	K	Female, Kenworth	•	•	•	3"	5-1/2 NS	3.35"	3.35"
600264	L	Female, Reefer & International	-	•	-	2"	11-1/2 NPSH	2-1/4"	2-1/4"
600211	M	Lever, Peterbilt	-	-	•	4"	-	N/A	N/A

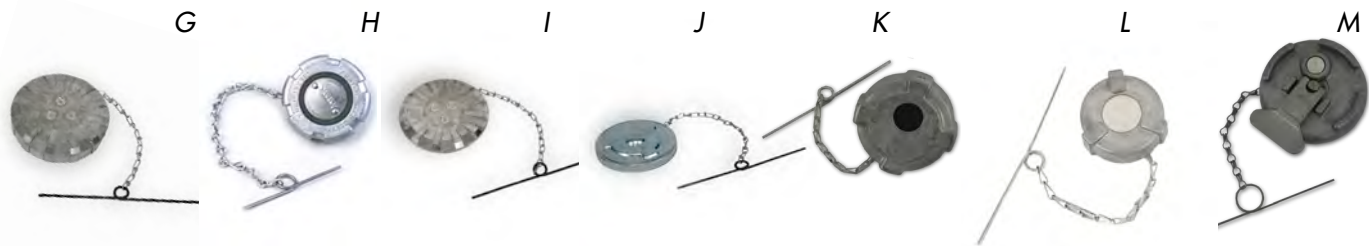

### Fuel Caps

- Comes in attractive clamshell packaging
- All locks have a single key available
- All locks are direct replacement of OEM caps

### NOTES

\* Freightliners after 1983 and Western Star after 1982 both with diesel fuel tanks with 3" male pipe filler necks

\*\* Freightliners prior to 1984 and Kenworth after 1984, Peterbilt prior to 1980 and Western Stars prior to 1983 all with diesel fuel tanks with 3" male pipe filler necks

**V** Vented

**T/R** Thermal relief

**P/R** Pressure relief



Call the Velvac Sales Team: **800.783.8871** sales@velvac.com

© VELVAC INC. • 2405 South Calhoun Road • New Berlin, WI 53151-2709 • Toll Free: 800.783.8871 • Fax: 262.786.4101



# FUEL SYSTEMS

## ALUMINUM LOCKING FUEL CAPS

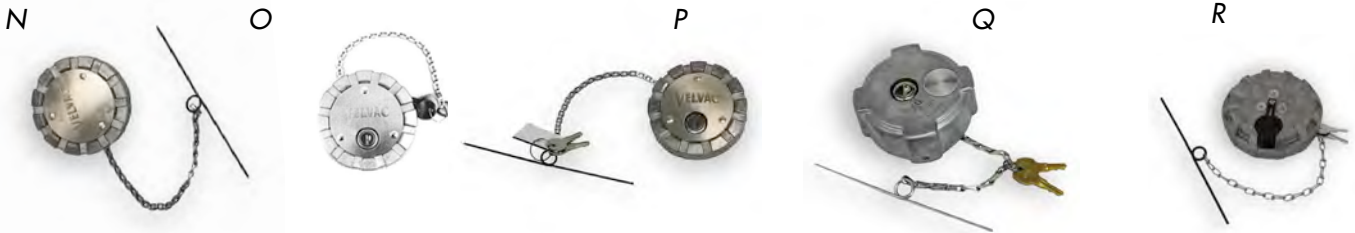

Part #	Photo	Type	V	T/R	P/R	Nominal Size	Threads Per Inch	Across Cap	Across Threads Filler Neck
600150	N	Female, Freightliner M2	-	●	-	2.5"	8 UN	2.38"	2.38"
600185-6***	O	Female Replaces Freightliner A03-12927-6 and Kenworth K071-385-1234**	●	●	●	3"	5-1/2"	3-7/16"	3-1/2"
600183-6***	P	Female Replaces Freightliner A03-15682-6 and Western Star 43301-3403*	●	●	●	3"	8 NPSL	3.37"	3.37"
600149	Q	Female, 1/4 Turn Replaces Freightliner 03-37017-002	-	●	-	3"	CAM CAP	N/A	N/A
600169-6	R	Female	-	●	●	4"	8 NPSL	4.35"	4.35"
600181-6	S	Female	●	●	●	4"	8 NPSM	4.35"	4.35"
600259	T	Female, Volvo, Mack & International	-	-	●	3"	8 NPSL	3.37"	3.37"
600263	U	Female, Kenworth w/ Thermo Relief	-	●	-	3-1/2"	5-1/2 NS	3.38"	3.38"
600212	V	Lever, Peterbilt	-	-	●	4"	N/A	N/A	N/A

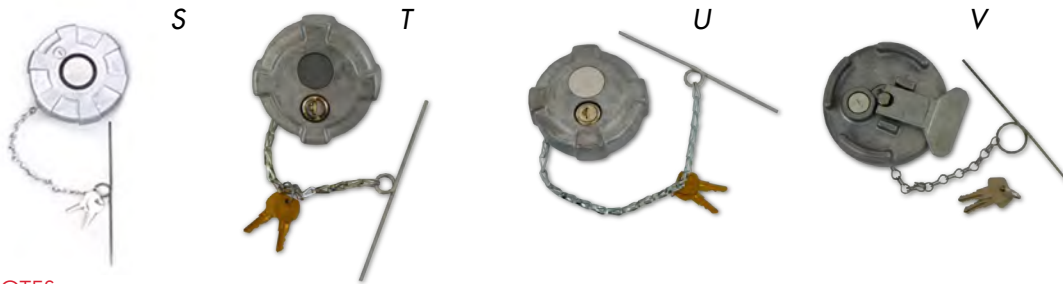

### NOTES

\*\*\* Keys not available separately

**V** Vented

**T/R** Thermal relief

**P/R** Pressure relief

### NOTE

All caps meet or exceed Federal Motor Carrier Safety Administration (FMCSA) requirements. This product conforms to the relief pressure and leakage rate test as required by 49 CFR 393.67 standards to protect from the inherent dangers associated with fuel leaks

Fuel caps come in attractive retail clamshell packaging

Part No. 600263 shown here >





# FUEL SYSTEMS

## GAS / DIESEL FUEL CAPS

Vented aluminum caps meet 49 CFR 393.67 requirements for vehicles built after October 1985. Vented brass caps are designed for use only on vehicles with non-vented fuel systems built prior to October 1985. Non-vented brass caps are designed for use only on vehicles equipped with properly vented fuel systems. For complete information on current fuel tank system requirements, see Code of Federal Regulations 49 CFR 393.67

- Available as vented or non-vented
- Fusible meltouts on brass fuel caps for thermal relief
- Safety chains and crossbars are standard on all caps except Part No. 600009 which features a 14" exterior cable with an attached 3/16" I.D. ring
- Patented Loc-Gard on locking cap protects against moisture and contaminants (US Patent No. 4,706,841)
- All locking fuel caps are supplied with 2 keys

### WARNING!

Aluminum fuel caps are designed ONLY for Diesel applications; brass fuel caps are designed for gasoline, diesel and oil applications



### Brass Locking Fuel Cap

- Nominal size - 2"
- Threads per inch - 11-1/2
- Cap - 2-1/4"
- Filler neck - 2-5/16"

Part #	Description
600196-6	Female, non-vented



### Brass Fuel Cap

- Nominal size - 2"
- Threads per inch - 11-1/2
- Cap - 2-1/4"
- Filler neck - 2-5/16"

Part #	Description
600009	Female, non-vented



### Brass Fuel Cap

- Nominal size - 2-1/8"
- Threads per inch - 12
- Cap - 2-1/8"
- Filler neck - 2-1/16"

Part #	Description
600017	Male, vented

### Aluminum Locking Fuel Cap

- Nominal size - 2"
- Threads per inch - 11-1/2
- Cap - 2-1/4"
- Filler neck - 2-5/16"

Part #	Description
600270	Female, non-vented



### Brass Fuel Cap

- Nominal size - 2"
- Threads per inch - 11-1/2
- Cap - 2-1/4"
- Filler neck - 2-5/16"

Part #	Description
600133	Female, non-vented
600007	Female, vented

**NOTE: Part numbers listed in RED are NEW!**



Call the Velvac Sales Team: **800.783.8871** sales@velvac.com

© VELVAC INC. • 2405 South Calhoun Road • New Berlin, WI 53151-2709 • Toll Free: 800.783.8871 • Fax: 262.786.4101

## REPLACEMENT PARTS FOR CAPS



Part #	Replacement Part	Application
600011	2" Gasket	600196-6, 600009, 600133, 600007
600021	2 1/8" Gasket	600017
600081	3" Gasket	600184, 600185-6, 600183-6
601069	4" Gasket	600168, 600169-6, 600172, 600173-6
600041	Lock Cam	600169-6
600053	Lock Cam	600173-6
600175	Loc-Gard cap	600173-6
600176	Loc-Gard cap	600169-6, 600196-6
601063	Chain and bar	600168, 600169-6, 600172, 600173-6, 601065
600040	Chain and bar	600007, 600017, 600133, 600196-6
600631	Key No 31	Lock No 31 - Used on 600169-6 and 600196-6
600632	Key No 32	Lock No 32 - Used on 600169-6 and 600196-6
600633	Key No 33	Lock No 33 - Used on 600169-6 and 600196-6
600219	Key No 19	Lock No 19 - Used on 600169-6 and 600196-6
600220	Key No 20	Lock No 20 - Used on 600169-6 and 600196-6
600221	Key No 21	Lock No 21 - Used on 600169-6 and 600196-6



## ANTI-SIPHON TUBES

### Protect your fuel with Velvac's Anti-Siphon Tube

- Fast and easy installation — tube is designed to lock onto filler neck wall to prevent removal
- Eliminates the potential for fuel theft from syphoning through filler neck
- Durable all aluminum construction
- Vented design allows fueling at 20+ gallons per minute
- OEM approved with sizes to fit most vehicle applications



600265



600258

Part #	Dimension "B"	Description
600241	3-3/4 inches	Fits heavy duty Volvo, International and Mack trucks
600242	3-3/4 inches	Fits heavy duty Volvo, International and Mack trucks
600243	2-3/4 inches	Fits heavy duty Kenworth
600244	2-3/4 inches	Fits heavy duty Freightliner
600245	2-1/4 inches	Fits Medium-duty trucks
600246	3-3/4 inches	Fits medium-duty and Reefer trucks
600258	-	4" Anti-siphon tube
600265	-	2-1/2" Peterbilt anti-siphon tube w/ installation kit

#### NOTE

Dimension "B" is from the underside of the top lip to the tip of the last barb

# FUEL SYSTEMS

## FUEL TANK VALVES

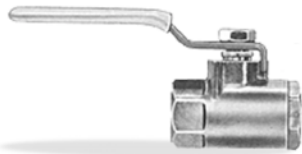

### Ball Valve

- Designed for fuel line shutoff in gasoline and diesel vehicles. May also be used for water and air service lines
- Heavy-duty forged brass body provides extended service
- Teflon® seats and seals provide positive sealing with easy opening and closing
- 600 psi water, oil or fuel
- 150 psi on/off saturated steam service lines
- 29 in. Hg vacuum service

Part #	Description
060050	Ball valve with 1/2" FPT both ends

Three-way  
060004



Three-way  
060012



### Tank Cocks

- All brass bodies
- Mounting flanges with 1/4" bolt holes
- Standard 1-1/2" stems

Four-way  
060001, 060007



Part #	Description
060004	Three-way tank cock with 3/8" FPT side ports
060012	Three-way tank cock with 1/4" FPT bottom and side ports
060001	Four-way tank cock with 3/8" FPT bottom and side ports
060007	Four-way tank cock with 1/4" FPT bottom and side ports

## RETURN FLOW SPLITTERS

- Designed for dual draw/dual return diesel fuel system
- Distributes fuel equally to both left and right tanks eliminating the need for crossover lines
- Durable zinc die cast bodies
- Convenient tee configuration for easy plumbing to each tank
- Applicable for marine use
- (3) 1/2" FPT ports
- (2) 1/4" mounting holes



Part #	Description	Vehicle Applications
060070	Standard flow	Fits heavy duty Volvo, International and Mack trucks
060071	High flow	Fits heavy duty Volvo, International and Mack trucks

## DIESEL FUEL VALVES



- All brass bodies provide added durability — both with 1/2" MPT bottom ports
- Neoprene seats make valves compatible with most liquids

Part #	Description
060026	Leveling valve with 1/2" FPT side port
060027	Leveling valve with 5/8" SAE 45" male flare side port



Call the Velvac Sales Team: **800.783.8871** [sales@velvac.com](mailto:sales@velvac.com)

## ELECTRIC FUEL TANK SELECTOR VALVES

### Six Port Motor-Driven Valve

- Designed for systems with fuel or vapor return lines - not for use with fuel systems operating over 30 psi
- Reduces the possibility of fuel returning to incorrect tank as valve remains in actuated position after power is disconnected
- Permits high closing pressures
- Can be used for biodiesel, vegetable oil and olive oil
- 12 VDC
- Operating temperature range of -40° to 180° F
- 3/8" supply lines, 5/16" return lines
- Weatherproof electrical connector Part No. 060049 is required for all new installations

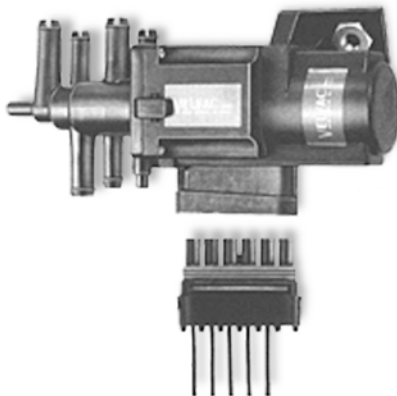

Part #	Description
060047	Six port motor-driven valve
060049	Electrical connector

### Fuel Solenoid Shut Off Valve

- Direct replacement for Cummins 3035342, BM-69973
- 12 VDC
- Ports accept 1/4" tube
- 3" overall height
- Includes seal ring and port plug



Part #	Description
034095	Fuel solenoid valve

## FUEL TANK SAFETY VENTS

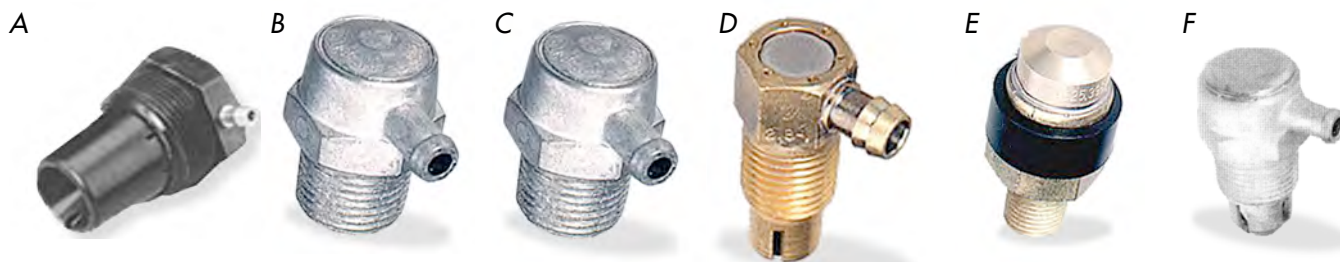

- Feature patented anti-spill protection
- Vents meet all applicable DOT requirements

Part #	Photo	Thread Size	Barb Size (I.D. Hose)	Fuel Application	Vehicle Application
060060	A	1-1/4" PTF SAE Short	1/4"	Diesel	Peterbilt
060061	B	1/2"-14 PTF SAE Short	5/16"	Gasoline	Various
060062	C	1/2"-14 PTF SAE Short	5/16"	Diesel	Various
060063	D	1/4"-18" PTF	1/4"	Diesel	Various

### Valves with Pressure and Thermal Relief Features

Part #	Photo	Thread Size	Barb Size (I.D. Hose)	Fuel Application	Pre-1992
060040	E	1/4"-18 PTF	N/A	Diesel	Kenworth
060064	F	1/2"-14 PTF SAE Short	5/16"	Diesel	Kenworth

**NOTE: Part numbers listed in RED are NEW!**

## FUEL TANK VALVES

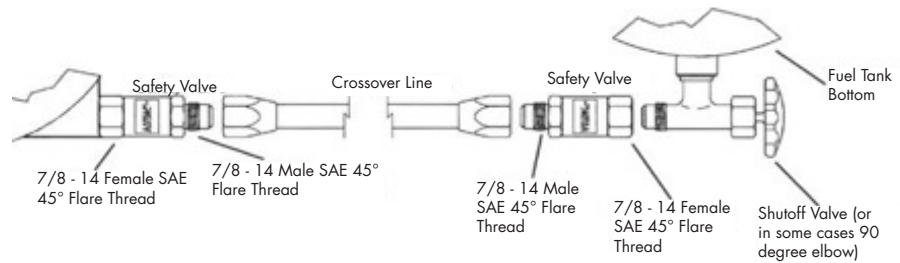

Fuel tank diagram

### Crossover Fuel Line Safety Valve

- Functions as a "fuse" in the fuel crossover line, automatically shutting off the flow of fuel if the line between a vehicle's main and auxiliary tanks is torn away or obstructed
- Separates before the crossover fuel line ruptures, preventing damage to fuel tank lines, fittings and valves
- Reduces the risk of fire and fuel slick by minimizing fuel loss if crossover fuel line is torn away
- 3-1/8" length, 1-1/4" diameter
- Lightweight aluminum construction

Part #	Description
060056	Crossover fuel line safety valve

## ADAPTER KITS



### Filler Neck Adapter Kit

- Part No. 600112 allows 2" female fuel caps to be installed on filler necks with small inside diameters
- Part No. 600191 allows 2" female fuel caps to be installed on 2-1/2" male filler neck with 8 threads per inch
- Include aluminum adapter, installation instructions and adhesive

Part #	Description
600112	Filler neck adapter kit
600191	Filler neck adapter kit

### Saddle Tank Mounting Kit

- Complete kit for mounting one saddle tank

Part #	Description	
602002	Saddle tank mounting kit	
<b>Kit Contents:</b>		
Part #	Description	Qty
060033	Rubber pad	4
	Spring	4
	Lock nut	4
	Hex bolt	4

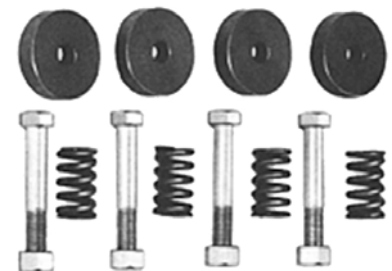

1/2" center hole

#### NOTE

Replacement rubber pads available; no replacements available for other kit parts.



Call the Velvac Sales Team: **800.783.8871** sales@velvac.com



**OUR PARTS PUT YOU IN THE PASSING LANE**

# **BACK-UP ALARMS**

## **Alarms, warning devices & switches.**

Velvac back-up alarms meet the needs of almost every vehicle application and environment.

- **Heavy duty OEM style**
- **Patented double-reflex horn**
- **Speaker alarms**



# BACK-UP ALARMS

## Horn Style Alarms

### Double Reflex Horn Style Back-up Alarm

10-Year Warranty



HD STD



HD OEM

- Features patented double reflex horn speaker, providing efficient, high output sound with less power consumption and reduced heat for greater reliability and performance. 24" long folder horn allows alarm to run cooler by using about half the power consumption of conventional speaker alarms to achieve the same decibel output
- High impact glass filled nylon housing meets high temperature demands of SAE J994 and UL flame testing. Provides durability needed for the toughest work and vehicle environments
- 10 year warranty
- HD OEM style alarms incorporate a self-cleaning feature that "pumps" out contaminants from the sound chamber for increased reliability and an anti-tamper grill to help protect the alarm from damage
- 12-24 VDC polarity and peak voltage protection, temperature range -40° to +85°C
- Slotted mounting centers with optional back or bottom mounting for easy installation
- Meets requirements of SAE J994, CE, eMark and UL, OSHA, MSHA, IP67

### External Switch

- Switch will cause alarm to activate when linkage is shifted into reverse
- Operating temperatures of -40°F to +140°F
- 12-24 VDC
- Not for underwater use



Part #	Description
697011	External switch

### Heavy Duty External Switch

- For use on vehicles that do not have back-up lights readily available
- Equiv: Preco SW30



Part #	Voltage	Amps
697012	12-80 V	10

Part #	Decibels	Rated Current mAmps (mA)	Connection Type	Mounting Bracket	Mounting Center	ECCO Equivalent	PRECO Equivalent
<b>HD OEM</b>							
697017	107	500	Wire	Metal	7"	787/872	360
697032	112	500	Wire	Metal	7"	876	110
697105	87-112*	300	Wire	Metal	7"	SA920	6010
697106	87-112*	300	Wire	Metal	6"	SA917	1040
697104	82-107*	300	Wire	Integrated nylon	4"	SA901	1048
<b>HD STD</b>							
697002	102	300	Wire	Integrated nylon	3.25"	575	270
697007	107	300	Wire	Integrated nylon	3.25"	575	270

\* Self-adjusting alarm features a true, high sensitivity microphone to sense ambient noise levels around the alarm and automatically adjust the sound output to be 10 decibels



Call the Velvac Sales Team: **800.783.8871** sales@velvac.com

© VELVAC INC. • 2405 South Calhoun Road • New Berlin, WI 53151-2709 • Toll Free: 800.783.8871 • Fax: 262.786.4101

# BACK-UP ALARMS

## Speaker Style Alarms

- High impact glass filled nylon housing meets high temperature demands of SAE J994 and UL requirements for flame testing
- 12-24 VDC polarity and peak voltage protection
- Temperature range -40° to +85°C
- Epoxy encapsulation protection and 3 year warranty



697103



699287 & 699297

Part #	Decibels	Rated Current mAmps (mA)	Connection Type	ECCO Equivalent	PRECO Equivalent
697287	87	100	Wire	—	—
697297	97	500	Wire	—	—
699287	87	500	Terminal	505	220/240
699297	97	500	Terminal	510/520	230/240
697103	82-102*	200	Wire	SA950	1020

\* Self-adjusting alarm features a true, high sensitivity microphone to sense ambient noise levels around the alarm and automatically adjust the sound output to be 10 decibels



697087, 697097 & 697107



697066 & 697112



699087, 699097 & 699107



699112

Part #	Decibels	Rated Current mAmps (mA)	Connection Type	Mounting Center	ECCO Equivalent	PRECO Equivalent
699087	87	200 - 300	Terminal	3.25	505	220/ELT 278
699097	97	200 - 300	Terminal	3.25	510/520	230/230LV/240
699107	107	200 - 300	Terminal	3.25	—	250
699112	112	200 - 300	Terminal	—	—	—
697087	87	100 - 200	Wire	3.25	—	—
697097	97	100 - 200	Wire	3.25	—	240C5
697107	107	400 - 500	Wire	3.25	575	270
697112	112	400 - 500	Wire	4.12	—	—
697066	87-112*	400 - 500	Wire	4.12	SA901	1020

- High impact glass filled nylon housing meets high temperature demands of SAE J994 and provides durability needed for even tough work and vehicle environments
- Epoxy encapsulation protects electronics against moisture, allowing steam cleaning or pressure washing
- Ground strap included on 699 Series terminal alarms - two 9" x 16" gauge wires included
- Temperature range -40° to +85°C
- Slotted mounting centers with optional back or bottom mounting for easy installation - dimensions in table above
- Meets SAE J944 requirements
- 1 year warranty

# BACK-UP ALARMS

## BACK-UP ALARMS & WARNING DEVICES

### Flush Mount Alarms

- High impact glass filled nylon housing meets high temperature demands of SAE J994 and provides durability needed for even tough work and vehicle environments
- 12 - 24 VDC operation, temperature range -40° to +85°C
- 697124 and 697125 alarms are designed to mount flush into standard 4" hole on vehicle body. These alarms include rubber mounting boot and wire harness with mating connector
- 697187 and 697197 feature a compact design for mounting into 1/75" hole in vehicle body - overall unit depth is 1.28"



697187 & 697197

Part #	Decibels	Rated Current mAmps (mA)	Connection Type	Hole Diameter	ECCO Equivalent	PRECO Equivalent
697187	87	250	Wire	1.75"	—	—
697197	97	250	Wire	1.75"	—	—
697124	97	200 - 400	Wire harness w/ connector	4"	410/415	4030
697125	107	200 - 400	Wire harness w/ connector	4"	435	4050

### Warning Devices



696087, 696097 & 696107

Part #	Decibels	Rated Current mAmps (mA)	Connection Type	Mounting Centers	ECCO Equivalent	PRECO Equivalent
696087	87	90 - 400	Terminal	3.25"	-	-
696097	97	150 - 400	Terminal	3.25"	DT500	D5232
696107	107	150 - 500	Terminal	3.25"	-	-

- Yellow colored nylon housings clearly identify as warning devices
- 12 - 24 VDC operation - ground strap included
- Slotted mounting centers with optional back or bottom mounting for easy installation



Call the Velvac Sales Team: **800.783.8871** [sales@velvac.com](mailto:sales@velvac.com)



**OUR PARTS PUT YOU IN THE PASSING LANE**

# ACCESSORIES

**Yep, it's in here.**

From wiper blades to emergency triangles, if you couldn't find what you were looking for in the other sections of our catalog, it's probably right here.

- **Wiper blades & emergency triangles**
- **Tarp straps & king pin locks**
- **And a whole lot more!**





# ACCESSORIES

## WIPER BLADES



### Universal Winter Heavy Duty

- Heavy duty steel construction is surrounded by a rubber boot to minimize the accumulation of snow and ice on wiper blades

Part #	Length	Anco #	Trico #
W15	15"	30-15	37-151
W16	16"	30-16	37-160
W18	18"	30-18	37-180
W20	20"	30-20	37-205
W22	22"	30-22	37-225
W24	24"	30-24	37-245
W26	26"	-	-
W28	28"	-	-



### Heavy Duty Flex Blades

- Designed for heavy duty arms that have less than 48 oz. of load. Can be used on flat or curved windshields with narrow saddle arms

Part #	Length	Anco #	Trico #
72-15	15"	52-15	63-151 64-150
72-16	16"	52-16	63-161 64-160
72-18	18"	52-18	63-18 64-180
72-20	20"	52-20	63-12 64-200



### Premium Universal Wiper Blade

- All makes premium heavy duty wiper blade replaces the Anco 91 Series heavy duty blade. Features a riveted all steel frame and compression molded rubber blade for increased life and durability

Part #	Length	Anco #	Trico #
76-14	14"	91-14	-
76-15	15"	91-15	15-1
76-16	16"	91-16	16-1 16-2
76-18	18"	91-18	18-1 18-2
76-19	19"	91-19	19-1 19-2
76-20	20"	91-20	20-1 20-2 20-4 20-9
76-21	21"	91-21	21-1
76-22	22"	91-22	22-1 22-4 22-9
76-24	24"	91-24	24-1 24-4 24-9
76-28	28"	91-28	28-1



### Winter Heavy Duty Narrow

- Heavy duty steel frame for narrow arms is surrounded by a rubber boot to minimize the accumulation of snow and ice

Part #	Length	Anco #	Trico #
WN15	15"	59-15	66-150
WN16	16"	59-16	66-160

\*Refer to [www.velvac.com](http://www.velvac.com) for all makes cross reference guide



Call the Velvac Sales Team: **800.783.8871** [sales@velvac.com](mailto:sales@velvac.com)

© VELVAC INC. • 2405 South Calhoun Road • New Berlin, WI 53151-2709 • Toll Free: 800.783.8871 • Fax: 262.786.4101

## WIPER BLADES



### Heavy Duty Flat Blade

- Used in flat windshield applications. Stainless steel rail. Typically used on heavy duty trucks, school buses, step vans and RVs

Part #	Length	Anco #	Trico #
71-13	13"	51-13	62-130
71-14	14"	51-14	61-140
71-15	15"	51-15	61-150
71-16	16"	51-16	61-160
71-18	18"	51-18	61-180
71-20	20"	51-20	61-200



### Universal Wiper Blade

- All makes heavy duty wiper blade replaces the Anco 31 Series blade, featuring an all steel frame construction with compression molded-rubber for long life

Part #	Length	Anco #	Trico #
75-14	14"	31-14	-
75-15	15"	31-15	-
75-16	16"	31-16	-
75-17	17"	31-17	-
75-18	18"	31-18	-
75-19	19"	31-19	-
75-20	20"	31-20	-
75-21	21"	31-21	-
75-22	22"	31-22	-
75-24	24"	31-24	-



### Transit Blade

- Typically used for bus and transit vehicle applications, with wide saddle arms

Part #	Length	Anco #	Trico #
13226SS	26"	52-27 52-28	-

## TARP STRAPS

### Tarp Straps

- Made of molded rubber for ozone resistance and stretch resiliency
- Designed to hold tarp covers on trucks and trailers
- Hooks are crimped to prevent hook disconnection
- Straps will stretch up to twice their original length
- Premium and DPM straps add increased UV protection



Rubber Tarp Part #	Premium EDPM	Description
580113	580118	9" Length
580114	580119	15" Length
580115	580120	21" Length
580116	580121	31" Length
580117	580122	41" Length

**WARNING!**

Rubber tarp straps can have a strong spring tension and can cause bodily injury if they were to come unhooked or break. Safety glasses are recommended. Tarp straps are not to be used to restrain or secure cargo.

**NOTE: Part numbers listed in RED are NEW!**

# ACCESSORIES

## EMERGENCY TRIANGLE

### Emergency Triangle Kit

- Kit contains three HD triangles packaged in a red plastic box
- Fluorescent orange plastic and red reflectors is visible day or night
- Snaps together for easy set up
- Heavy weighted sand filled base provides stability
- Meets all applicable FMVSS 125 and SAE/DOT specifications



Part #	Description
090240	Emergency triangle kit

## KING PIN LOCK

### King Pin Lock

- Help deter unwanted trailer hookups
  - Made of durable cast iron, it enhances protection against theft, breakage or damage
  - Heavy duty zinc plated lock set helps deter rusting and extends service life
  - Lock set includes two (2) keys
- NOTE: Each King pin lock is randomly keyed  
NOTE: Keyed alike is not available



Part #	Description
019032	King pin lock

## MECHANICS WIRE

### Mechanics Wire

- Heavy-duty black annealed construction

Part #	Wire Size	Roll Weight
090142	14 ga.	2 lb.
090145	14 ga.	5 lb.
090162	16 ga.	2 lb.
090165	16 ga.	5 lb.
090182	18 ga.	2 lb.
090185	18 ga.	5 lb.



Call the Velvac Sales Team: **800.783.8871** [sales@velvac.com](mailto:sales@velvac.com)

© VELVAC INC. • 2405 South Calhoun Road • New Berlin, WI 53151-2709 • Toll Free: 800.783.8871 • Fax: 262.786.4101

### Tite-Seal Document Storage Case

- Patented rubber caps create a watertight seal
- Aluminum mounting bracket features cushioned tube supports and pre-drilled mounting holes
- CapKeeper protective cable secures caps to mounting bracket

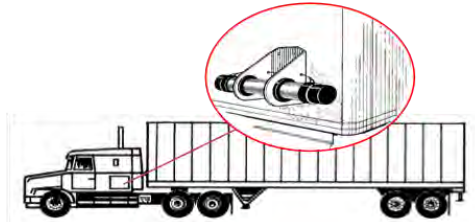

Case with bracket and CapKeeper™ cable



Light duty



Standard case with bracket

Part #	Description
090113*	Light duty aluminum tube with painted steel cap
090114*	9" Aluminum tube with bracket
090115*	9" Aluminum tube with bracket and CapKeeper cable
090116*	12" Aluminum tube with bracket and CapKeeper cable
090119	Replacement rubber cap

\* Bulk pack available. See price list

CapKeeper™ is a trademark of Velvac, Inc.

### License and Permit Holder

- UV-resistant Lexan®
- Inside dimensions are 3-1/8" to 3-3/4" wide x 5-1/2" high x 1-1/4" deep
- Three 1/4" mounting posts
- Documents secured by a metal spring clip and plate

Part #	Description
090060	License and permit holder
090061	Replacement cover



Lexan® is a registered trademark of SABIC Innovation Plastics

**NOTE: Part numbers listed in RED are NEW!**

# ACCESSORIES

## RADIATOR CAPS

### Heavy Duty Radiator Caps

- Velvac is now featuring all makes of heavy duty truck radiator caps



10208



10206



10238



10308



10205

Part #	Deep Neck	Pressure (lb.)
10205	1"	4
10206	1"	7
10208	3/4"	4
10238	Threaded filler neck	16
10308	3/4"	4

- For radiator overflow reservoir systems



10227



10228, 10229



10230, 10231



10233



10237



10241, 10242



10327

Part #	I.D. Size	Deep Neck	Pressure (lb.)
10227	32 mm	16 mm	13
10228	-	3/4"	7
10229	-	3/4"	13
10230	-	3/4"	16
10231	-	3/4"	16 vented
10233	32 mm	16 mm	16
10237	-	3/4"	10
10241	31 mm	10 mm	13
10242	31 mm	10 mm	16
10327	32 mm	16 mm	13
10328	-	3/4"	7
10329	-	3/4"	13
10330	-	3/4"	16
10331	-	3/4"	16 vented
10333	32 mm	16 mm	16
10337	-	3/4"	10



10328, 10329



10333



10330, 10331



10337

Manufactured by Stant®, an industry leader

Stant® is a registered trademark of Stant



Call the Velvac Sales Team: **800.783.8871** [sales@velvac.com](mailto:sales@velvac.com)

© VELVAC INC. • 2405 South Calhoun Road • New Berlin, WI 53151-2709 • Toll Free: 800.783.8871 • Fax: 262.786.4101



## RADIATOR CAPS

### Heavy Duty Radiator Caps (cont.)

Part #	O.D. Size	Deep Neck	Pressure (lb.)
10281	"B" 2-11/16"	3/4"	4
10282	"B" 2-11/16"	3/4"	7
10283	"B" 2-11/16"	3/4"	10
10292*	"B" 2-11/16"	3/4"	7
10293*	"B" 2-11/16"	3/4"	10
10294	"B" 2-11/16"	3/4"	15

Manufactured by Stant®, an industry leader



\*For radiator overflow reservoir systems

## CONSPICUITY TAPE

### Conspicuity Tape

- All the red and white conspicuity tape is DOT-C2 certified and guaranteed to meet or exceed all FMVSS 108 & NHTSA requirements
- The red and white tape comes with a 3, 5 or 10 year warranty
- School bus yellow tape has an enhanced daytime appearance and sight detection for safety. It meets or exceeds FMVSS 131 and FMVSS 217 requirements
- The white is a high performance polyester film that is thin and flexible
- The conspicuity strips are weather, solvent and UV resistant
- The red circles are SAE-A DOT approved
- The latest addition to the line is the diamond plate conspicuity tape. It is thin and flexible, weather resistant and has a distinctive design



058398

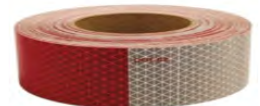

058370

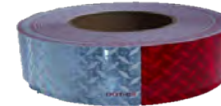

058402



058400



058373, 058374, 058377

Part #	Description	Warranty
058395	2" x 150' Roll of 11" Red / 7" White	3 Year
058370	2" x 150' Roll of 11" Red / 7" White	5 Year
058396	2" x 150' Roll of 11" Red / 7" White	10 Year
058397	2" x 150' Roll of 6" Red / 6" White	5 Year
058402	2" x 150' Roll of 6" Red / 6" White diamond plate	5 Year
058398	2" x 150' Roll of solid white	5 Year
058400	1" x 150' Roll of solid yellow	10 Year
058379	2" x 150' Roll of solid yellow	10 Year

Part #	Description	Warranty
058373	2" x 18" 11" Red / 7" White conspicuity strips	5 Year
058374	2" x 12" White conspicuity strips	5 Year
058377	2-3/4" Diameter red reflective circles	N/A
058399	3-3/4" x 6-1/2" Reflective American flag	5 Year



058399

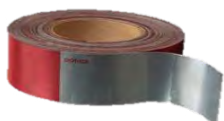

058395



058396

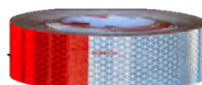

058397

**NOTE: Part numbers listed in RED are NEW!**

**HDT TOP 20 AWARD WINNER**

**Hooking up  
your trailer just  
got really easy.**

**PATENT  
ISSUED**

U.S. PATENT NO.  
9,357,114 B1



Recognized by  
Heavy Duty Trucking  
as a Top 20  
Product of the Year!

Our **5th Wheel Dual Camera System** makes it so much easier for commercial drivers to make sure that everything is lined up properly. Seeing the kingpin enter the throat of the 5th wheel helps ensure safety and takes the guesswork out of the coupling process. *Now patented!*

 **VELVAC**<sup>®</sup>  
*In the Passing Lane Since 1934*

velvac.com



See V11 for more info on the 5th Wheel Dual Camera System

Call the Velvac Sales Team: **800.783.8871** sales@velvac.com

© VELVAC INC. • 2405 South Calhoun Road • New Berlin, WI 53151-2709 • Toll Free: 800.783.8871 • Fax: 262.786.4101

**OUR PARTS PUT YOU IN THE PASSING LANE**

# **RETAIL MERCHANDISING**

## **Sell more with POP displays!**

Our attractive custom designed displays help your team organize and position the "high runners" that your customers are looking for.

- **Mirror, electrical & air displays**
- **Fittings & clamp displays**
- **Buckets, boxes & racks**





## DISPLAYS WITH PRODUCT ASSORTMENTS

### Mirror Assortment and Spinner Display



- Velvac now offers a 3-sided spinner display complete with an assortment of popular mirrors that reduce blind spots and improve driver safety.

**Assortment includes the following part numbers and quantities plus spinner display:**

- Part. No. 690110 includes:
  - » 17 popular mirrors
  - » 150 items total
  - » 3-sided spinner display
  - » Plan-o-gram
  - » 25 4" peg hooks

The assortment of mirrors includes:

- » West coast
- » 8½" convex
- » 5, 6, 7½" convex
- » Stick-on

Part #	Quantity
708501	12
708502	12
708556	6
708503	6
708520	10
708521	8
708515	10
708509	10
708508	10
705038	10
705333	8
705107	6
708331	6
705335	6
723050	10
723060	10
723065	10
723075	10
723100	3
690108	25
690104	1
Plan-o-gram	1

Part #	Description
690110	Mirror assortment & display



Call the Velvac Sales Team: **800.783.8871** [sales@velvac.com](mailto:sales@velvac.com)

## DISPLAYS WITH PRODUCT ASSORTMENTS

### Air and Electrical Display Rack



Part #	Description
690201	Includes rack and bins, air and electrical products, plan-o-gram, header, display and bin label

- Ships with an attractive laminated Velvac header
- Designed for a flexible product set
- Bins are designed to accept dividers to increase storage possibilities
- Display is formed from 16-gauge steel for strength and stability
- Display is designed to hold up to 800 pounds
- Easy to assemble
- Ships with plan-o-gram

**Assortment includes the following part numbers and quantities plus air and electrical display pack:**

Part #	Quantity
035031	40
035032	40
035033	40
035037	5
035092	5
035093	5
035009	100
035010	100
035011	100
035094	5
035095	5
035007	50
035070	4
022002	5
022001	5
022025	5
032082	5
032058	5
590160	4
590161	4
590163	4
590155	4
590157	4
593057	5
593022	5
593083	5
593084	5
038001	5
038003	5
038005	5
580037	10
580039	5
580040	5



## DISPLAYS WITH PRODUCT ASSORTMENTS

### Electrical Component Assortment and Spinner Display



- Assortment of popular, high running electrical components
  - » Butt and ring tongue connectors
  - » Quick slide connectors
  - » Heatless connectors
  - » Fuse holders and fuses
  - » Heat shrink tubing
  - » Silicon self-sealing tape
  - » Electrical tape
  - » Crimping tools
  - » Cable ties
- Includes:
  - » 65 popular, high running part numbers
  - » 226 items total
  - » 3-sided spinner display
  - » Plan-o-gram
  - » 107 4" peg hooks

Part #	Description
690111	Electrical assortment & display

*Assortment includes the following part numbers and quantities plus spinner display:*

Part #	Quantity	Part #	Quantity
058313-10	10	090068-100	9
058313-40	10	091190	4
058314-10	6	091130	4
058314-40	4	091426	2
058312-10	4	091189	2
058312-50	6	091325	2
056052-10	4	091326	2
056052-50	6	091175-5	2
056053-10	4	091180-5	2
056053-50	6	091181-5	2
056051-50	6	091182-5	2
057086-50	4	091183-5	2
058026	2	091184-5	2
090070-25	9	091303-5	2
058303-50	4	091305-5	2
058304-50	4	091306-5	2
058306-50	2	091307-5	2
056005-10	4	091308-5	2
056005-50	4	091309-5	2
056006-50	4	091400-5	2
056008-50	4	091401-5	2
056011-50	2	091402-5	2
058316-40	2	091403-5	2
058319-50	2	091404-5	2
056070-50	2	091131-5	2
056067-50	2	091135-5	2
056111-5	3	091140-5	2
056112-5	3	091142-5	2
056113-5	3	091144-5	2
058382	8	091254	4
058380	2	090066-100	9
057131	2	690104	1
057132	2	Plan-o-gram	1
057133	2		



Call the Velvac Sales Team: **800.783.8871** [sales@velvac.com](mailto:sales@velvac.com)

### Brass Fitting POP Display

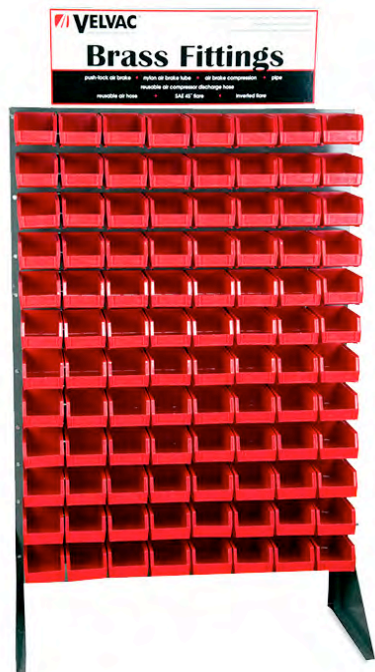

- Designed for more flexibility and storage space
- Attractive header card puts the Velvac name in front of customers
- Bins are designed to accept dividers that increase storage possibilities
- Frame is formed from 16-gauge steel for strength and stability
- Frame is designed to hold up to 800 pounds
- Choose from 3 different bin size layouts to best fit your needs
- Display assembly can be ordered in 3 different pre-designed configurations or by the individual pieces for a more custom display

Part #	Type	Spec's
690187	Cabinet frame only	54"H x 36"W x 16"D (Header adds 10")
690188	Small storage bin	7 <sup>3</sup> / <sub>8</sub> "L x 4 <sup>1</sup> / <sub>8</sub> "W x 3"H (Holds: 50 seals, 5-10 drain plugs, 4-5 gladhands)
690189	Medium storage bin	10 <sup>3</sup> / <sub>4</sub> "L x 8 <sup>1</sup> / <sub>4</sub> "W x 7"H (Holds: 15 gladhands, 15 7-way plugs, 10 sockets)
690190	Large storage bin	14 <sup>3</sup> / <sub>4</sub> "L x 16 <sup>1</sup> / <sub>2</sub> "W x 7"H (Holds: 2-3 coiled electric sets, 1-2 coiled air sets)
690191	Small bin divider	2 <sup>1</sup> / <sub>2</sub> "H x 6 <sup>3</sup> / <sub>4</sub> "L
690192	Medium bin divider	6 <sup>1</sup> / <sub>2</sub> "H x 10"L
690193	Large bin divider	6 <sup>1</sup> / <sub>2</sub> "H x 13 <sup>3</sup> / <sub>4</sub> "L



Part #	Cabinet Configurations
690194	Velvac header card, instruction sheet, 96 small bins and 48 small bin dividers
690195	Velvac header card, instruction sheet, 56 small bins, 4 medium bins, 2 large bins, 28 small bin dividers, 2 medium bin dividers and 1 large bin divider
690196	Velvac header card, instruction sheet, 40 small bins, 8 medium bins, 2 large bins, 20 small bin dividers, 4 medium bin dividers and 1 large bin divider

### Fitting Labels

Part #	Description
409904	Complete set of bin labels for all fittings



\* Packet of peelable sticker labels for use on all brass fittings POP display units

## FITTINGS DISPLAY RACKS

### Fitting Assortments



Part #	Pipe Size	Total Fittings
690072	Push-lock fitting assortment	155
690059	Large air brake compression fitting assortment	583
690071	Nylon air brake tube fitting assortment	304
690064	Brass pipe fitting assortment	340
690090	Cabinet only	-
690091	Replacement drawer dividers (Pkg. qty 12)	-

- Steel cabinet with rust-resistant baked enamel finish
- Cabinet includes 18 drawer dividers and 9 large steel drawers with a "positive stop" feature, preventing drawers from being accidentally pulled out
- Dimensions: 17¼"W x 10⅞"H x 11⅝"D
- Assortments come complete with all specified fittings, cabinet and drawer dividers

## BUCKET AND COUNTER BOXES

### Counter Top Bucket Display



- A convenient way to display new products while increasing your inside store sales
- Round clear canister, 7" diameter x 7½" height
- Sold complete with cover for easy shipping or fleet sales
- Product label includes an area to display your part number, UPC code and price

Part #	Contents
035160	200 Black polyurethane gladhand seals
035161	200 Red polyurethane gladhand seals
035162	200 Blue polyurethane gladhand seals
035163	200 Black rubber gladhand seals
058380-4	10 Rolls black silicon self fusing tape
058381-4	10 Rolls red silicon self fusing tape
056121	Heatless butt connectors (50) 056111-5, (200) 056112-5, (50) 056113-5
690202	Display bucket only



Call the Velvac Sales Team: **800.783.8871** [sales@velvac.com](mailto:sales@velvac.com)

## BUCKET AND COUNTER BOXES

### Polyurethane Gladhand Seals



- Color-coded seals will not crack or tear, reducing maintenance time and costs associated with rubber seal replacement
- Available in an attractive display box with 25 sets of seals (sets consist of 4 seals per bag, 2 red and 2 blue)

Part #	Description
035012	Display box with seals
035009	Red polyurethane seals
035010	Blue polyurethane seals
035011	Black polyurethane seals

### Display Bin Box



- Manufactured with corrugated cardboard for extra durability
- Great for store merchandising or storage of loose parts
- Fits on standard shelving or display units
- Complete with Velvac logo for store merchandising and branding

Part #	Description
690007	White 4" x 9"
690008	White 6" x 9"

## HOSE CLAMP AND AIR HOSE RACKS

### Slotted Hose Clamp Rack and Assortment



Part #	Description
022632	Slotted hose clamp rack & assortment

**Assortment includes the following hose clamps:**

Part #	SAE Size	Quantity	Description	Range (in.)
022204	4 Mini	30	Miniature clamp	7/32" - 5/8"
022206	6 Mini	30	Miniature clamp	7/16" - 25/32"
022310	10	20	Slotted clamp	9/16" - 1-1/16"
022312	12	20	Slotted clamp	11/16" - 1-1/4"
022320	20	20	Slotted clamp	13/16" - 1-3/4"
<b>022324</b>	24	20	Slotted clamp	1-1/16" - 2"
022328	28	20	Slotted clamp	1-5/16" - 2-1/4"
<b>022332</b>	32	20	Slotted clamp	1-9/16" - 2-1/2"
022336	36	20	Slotted clamp	1-13/16" - 2"
022565	1	-	Rack & header	-

- Assortment includes rack, header and 200 of the fastest moving miniature and general purpose slotted clamps

**NOTE: Part numbers listed in RED are NEW!**



## HOSE CLAMP AND AIR HOSE RACKS

### Large Hose Clamp Rack



- Attractive freestanding or wall mountable display
- Includes 270 of the most popular clamp offerings
- Rack dimensions: 21 1/2"W x 23"H x 8"D
- Moveable hooks allow for several different configurations

Part #	Description
022628	Rack and header only
022630	Hose clamp assortment with rack and header

#### Assortment includes the following hose clamps:

Part #	Description	Size	Quantity
022204	Mini clamp	7/32" x 5/8"	20
022206	Mini clamp	7/16" x 25/32"	20
022310	Slotted clamp	9/16" x 1 1/16"	20
022312	Slotted clamp	1 1/16" - 1 1/4"	20
022320	Slotted clamp	1 3/16" - 1 3/4"	20
022324	Slotted clamp	1 1/16" - 2"	20
022328	Slotted clamp	1 5/16" - 2 1/4"	20
022332	Slotted clamp	1 9/16" - 2 1/2"	20
022336	Slotted clamp	1 13/16" - 2 3/4"	20
022626	Spring T-bolt clamp	4 1/16" - 4 3/8"	15
022581	Spring T-bolt clamp	2 3/4" - 3 1/16"	15
022430	Constant torq clamp	2 1/4" - 3 1/8"	15
022435	Constant torq clamp	2 3/4" - 3 5/8"	15
022425	Constant torq clamp	1 3/4" - 2 5/8"	15
022445	Constant torq clamp	3 3/4" - 4 5/8"	15

### Air Brake Hose Assembly Display Rack



- For display and organization of 3/8" and 1/2" air hose assemblies
- 12 separate slots hold up to 48 hose assemblies
- Rack measures 21"W x 6"H x 6"D
- Air brake hose assemblies sold separately

Part #	Description
691020	Display rack



Call the Velvac Sales Team: **800.783.8871** [sales@velvac.com](mailto:sales@velvac.com)



## FLOOR DISPLAYS



Product sold separately

- Increase your sales opportunities by displaying product and letting your customers know what you have available for sale
- Assembles in minutes - no tools required
- Stands 5' tall (5'6" with the 3 Velvac header signs)
- Three 16" pegboard panels
- Rotating display stand

### Three-Sided Spinner Display

Part #	Description
690104	3-sided spinner display only

#### Peghooks available separately:

Part #	Description
690108	4" Peghooks
690107	2" Peghooks

### Primary Wire Rack



Wire spools sold separately

- Holds (12) 100' spools, (8) 100' & (2) 1000' spools or (4) 1000' spools

Part #	Description
691015	Primary wire rack

### Wire Display Rack



Product sold separately

- Freestanding or wall mountable display constructed of sturdy heavy gauge steel
- Overall dimensions 16½"H x 14¾"W x 6"D (header adds approximately 5¼" to height measurement)
- 15 hooks to display your product
- Use to build a seasonal display on parts counter
- Build your own:
  - » Electrical connector display
  - » Fuse display
  - » Fuse holder display

Part #	Description
091256	Wire display rack only

**NOTE: Part numbers listed in RED are NEW!**

## 100+ PAGES OF OE REPLACEMENT MIRROR PARTS



**Broken mirror?  
Today's your lucky day.**

With more than 100 pages of **OE Replacement Mirrors** in our catalog, finding your vehicle's mirror isn't the hard part, it's forgiving the "other guy" for breaking it in the first place. Whether it's just the glass, a part or the whole mirror assembly, we've got you covered — *and that's not luck, it's Velvac.*



[velvac.com](http://velvac.com)



OE Replacement Mirrors and Parts start on page M32

Call the Velvac Sales Team: **800.783.8871** [sales@velvac.com](mailto:sales@velvac.com)

© VELVAC INC. • 2405 South Calhoun Road • New Berlin, WI 53151-2709 • Toll Free: 800.783.8871 • Fax: 262.786.4101

**OUR PARTS PUT YOU IN THE PASSING LANE**

# INDEX

**Search every product.**

Find what you're looking for fast with our search index that doesn't require a magnifying glass to view.

- **Part Numbers**
- **Sectional Page Listings**
- **Visit [velvac.com](http://velvac.com) for more**





## PARTS INDEX

<b>MIRRORS</b>	<b>M</b>
<b>VISION SYTEMS</b>	<b>V</b>
<b>HOSE SUPPORT</b>	<b>H</b>
<b>AIR PRODUCTS</b>	<b>A</b>
<b>ELECTRICAL PRODUCTS</b>	<b>E</b>
<b>FITTINGS &amp; HARDWARE</b>	<b>FH</b>
<b>FUEL PRODUCTS</b>	<b>F</b>
<b>BACK-UP CAMERAS</b>	<b>B</b>
<b>ACCESSORIES</b>	<b>AC</b>
<b>RETAIL MERCHANDISING</b>	<b>R</b>

### THE VELVAC SECTIONAL CATALOG

To make finding the part you need easier, all products have been numbered sequentially and listed with their sectional page reference number. For the most up-to-date listing of products, please visit our online catalog at: [velvac.com](http://velvac.com)

PART NO.	PAGE	PART NO.	PAGE	PART NO.	PAGE
71-13	AC3	75-22	AC3	011023	FH7
71-14	AC3	75-24	AC3	011025	FH7
71-15	AC3	76-14	AC2	011027	FH7
71-16	AC3	76-15	AC2	011029	FH17
71-18	AC3	76-16	AC2	011032	FH11
71-20	AC3	76-18	AC2	011033	FH8
72-15	AC2	76-19	AC2	011034	FH11
72-16	AC2	76-20	AC2	011041	FH8
72-18	AC2	76-21	AC2	011043	FH8
72-20	AC2	76-22	AC2	011045	FH8
75-14	AC3	76-24	AC2	011047	FH8
75-15	AC3	76-28	AC2	011051	FH8
75-16	AC3	10205	AC6	011057	FH8
75-17	AC3	10206	AC6	011059	FH8
75-18	AC3	10208	AC6	011073	FH17
75-19	AC3	10227	AC6	011093	FH8
75-20	AC3	10228	AC6	012012	FH11
75-21	AC3	10229	AC6	012014	FH11
		10230	AC6	012015	FH11
				012016	FH11
				012017	FH8
				012021	FH8
				012022	FH11
				012023	FH8
				012035	FH8
				012037	FH8
				012041	FH8
				012043	FH8
				012045	FH8
				012047	FH8
				012049	FH8
				012053	FH8
				012055	FH8
				012061	FH8
				012064	FH11
				012066	FH11
				012067	FH7
				012068	FH11
				012069	FH11
				012071	FH7
				012073	FH7
				012087	FH7
				012091	FH7
				012093	FH7
				012095	FH7
				012097	FH7
				013001	FH7
				013003	FH7
				013011	FH7
				013041	FH8
				013049	FH8
				013057	FH8
				013060	FH8
				013075	FH7
				013076	FH7
				013077	FH7
				014106	FH14
				014200	FH14
				014204	FH14
				014206	FH14
				014208	FH14
				014209	FH14
				014210	FH14
				014211	FH14
				014212	FH14
				014216	FH14
				014217	FH14
				014218	FH14
				014806	FH14
				014808	FH14
				014811	FH14
				014818	FH14
				014822	FH14
				014832	FH14
				014842	FH14
				014844	FH14
				014852	FH14
				014854	FH14
				014862	FH14
				014864	FH14
				014866	FH14
				014868	FH14
				014884	FH14
				014886	FH14
				014888	FH14
				014906	FH14
				014908	FH14
				014911	FH14
				014918	FH14
				014942	FH14
				014944	FH14
				014946	FH14
				014952	FH14
				014962	FH14
				014964	FH14
				014966	FH14
				014968	FH14
				014984	FH14
				014986	FH14
				014988	FH14
				015906	FH14
				015908	FH14
				015942	FH14
				015944	FH14
				015964	FH14
				015966	FH14
				015986	FH14
				015988	FH14
				016001	FH12
				016002	FH12
				016003	FH12
				016004	FH12
				016005	FH12
				016033	FH12
				016037	FH12
				016038	FH12



Call the Velvac Sales Team: **800.783.8871** [sales@velvac.com](mailto:sales@velvac.com)

## PARTS INDEX

PART NO.	PAGE	PART NO.	PAGE	PART NO.	PAGE	PART NO.	PAGE	PART NO.	PAGE
016039	FH12	016187	FH3	016386	FH4	016809	FH6	017023	FH12
016040	FH12	016188	FH3	016388	FH4	016810	FH3	017025	FH12
016041	FH12	016189	FH3	016400	FH3	016811	FH6	017027	FH12
016042	FH12	016200	FH7	016401	FH3	016812	FH3	017029	FH12
016043	FH12	016201	FH7	016402	FH3	016813	FH3	017031	FH13
016044	FH12	016204	FH5	016403	FH3	016814	FH3	017039	FH13
016045	FH12	016206	FH5	016404	FH3	016815	FH3	017043	FH7
016046	FH12	016208	FH5	016405	FH3	016816	FH3	017046	FH7
016047	FH12	016212	FH2	016406	FH3	016818	FH6	017051	FH13
016051	FH12	016214	FH2	016407	FH3	016840	FH3	017053	FH13
016052	FH12	016222	FH2	016408	FH4	016842	FH6	017055	FH13
016053	FH12	016240	FH7	016409	FH3	016844	FH6	017056	FH13
016054	FH12	016242	FH2	016412	FH2	016846	FH6	017057	FH13
016065	FH12	016244	FH2	016415	FH4	016860	FH3	017058	FH13
016067	FH13	016246	FH2	016416	FH4	016862	FH6	017059	FH13
016068	FH13	016247	FH3	016417	FH4	016864	FH6	017061	FH13
016069	FH13	016248	FH3	016440	FH7	016866	FH6	017063	FH13
016070	FH13	016249	FH3	016442	FH2	016868	FH6	017064	FH7
016077	FH13	016250	FH3	016444	FH2	016880	FH3	017065	FH13
016079	FH12	016254	FH2	016446	FH2	016884	FH6	017066	FH7
016080	FH12	016260	FH7	016450	FH2	016886	FH6	017067	FH13
016081	FH12	016262	FH2	016451	FH2	016888	FH6	017069	FH13
016082	FH12	016264	FH2	016452	FH2	016890	FH6	017072	FH13
016083	FH12	016266	FH2	016453	FH2	016908	FH6	017075	FH12
016084	FH12	016268	FH2	016454	FH2	016910	FH2	017077	FH12
016085	FH12	016270	FH2	016455	FH2	016912	FH6	017078	FH12
016086	FH12	016271	FH2	016456	FH2	016916	FH6	017081	FH13
016087	FH12	016276	FH2	016457	FH2	016918	FH6	017083	FH13
016088	FH12	016277	FH2	016460	FH7	016920	FH2	017085	FH13
016089	FH12	016278	FH2	016464	FH2	016922	FH6	017086	FH7
016100	FH7	016279	FH2	016466	FH2	016930	FH2	017089	FH13
016101	FH7	016280	FH7	016480	FH7	016940	FH2	017090	FH13
016102	FH3	016281	FH2	016481	FH7	016942	FH6	017091	FH13
016103	FH3	016282	FH4	016482	FH7	016944	FH6	017093	FH13
016104	FH3	016283	FH4	016486	FH2	016945	FH14	017094	FH13
016105	FH3	016284	FH2	016510	FH6	016946	FH6	017095	FH13
016110	FH3	016285	FH4	016540	FH6	016947	FH2	017096	FH13
016112	FH3	016286	FH2	016560	FH6	016948	FH14	017098	FH10
016114	FH3	016287	FH4	016580	FH6	016950	FH2	017099	FH10
016115	FH4	016288	FH2	016610	FH3	016951	FH3	017101	FH13
016116	FH4	016289	FH2	016618	FH6	016960	FH2	017102	FH13
016117	FH4	016290	FH2	016620	FH3	016962	FH6	017103	FH13
016120	FH3	016291	FH2	016621	FH3	016964	FH6	017106	FH13
016121	FH3	016294	FH3	016622	FH3	016966	FH6	017107	FH13
016122	FH3	016295	FH3	016623	FH3	016968	FH6	017108	FH13
016124	FH3	016300	FH7	016624	FH3	016980	FH2	017109	FH13
016140	FH7	016301	FH7	016630	FH3	016982	FH2	017110	FH13
016142	FH3	016305	FH4	016640	FH3	016984	FH6	017142	FH7
016144	FH3	016312	FH4	016642	FH6	016985	FH2	017144	FH7
016146	FH3	016314	FH4	016644	FH6	016986	FH6	017164	FH7
016160	FH7	016340	FH7	016660	FH3	016988	FH6	017166	FH7
016161	FH3	016342	FH4	016662	FH6	017000	FH12	017186	FH7
016162	FH3	016343	FH4	016664	FH6	017003	FH12	017188	FH7
016163	FH3	016344	FH4	016666	FH6	017004	FH12	017218	FH6
016164	FH3	016348	FH3	016670	FH3	017005	FH12	017223	FH12
016166	FH3	016360	FH7	016680	FH3	017006	FH12	017224	FH12
016168	FH3	016364	FH4	016686	FH6	017015	FH13	017225	FH12
016180	FH7	016366	FH4	016688	FH6	017017	FH13	017226	FH12
016184	FH3	016368	FH4	016806	FH6	017019	FH13	017227	FH12
016186	FH3	016380	FH7	016808	FH6	017021	FH13	017242	FH6



## PARTS INDEX

PART NO.	PAGE	PART NO.	PAGE	PART NO.	PAGE	PART NO.	PAGE	PART NO.	PAGE
017244	FH6	017970	FH4	020053	A7	021011	E35	022057	FH22
017262	FH6	017972	FH4	020053-7	A7	021013	E35	022058	FH22
017264	FH6	017973	FH4	020055	A7	021015	E35	022059	FH22
017266	FH6	017974	FH4	020055-7	A7	021017	E35	022060	FH22
017286	FH6	017980	FH4	020057	A7	021019	E35	022106	FH19
017288	FH6	017981	FH4	020057-7	A7	021021	E35	022108	FH19
017808	FH6	017982	FH4	020059	A7	021023	E35	022110	FH19
017816	FH6	017983	FH4	020059-7	A7	021059	E35	022112	FH19
017842	FH6	017984	FH4	020062	A7	021061	E35	022116	FH19
017844	FH6	017985	FH4	020062-7	A7	021063	E35	022120	FH19
017862	FH6	018006	FH13	020064	A7	021065	E35	022124	FH19
017864	FH6	018007	FH13	020064-6	A7	021070	E35	022128	FH19
017866	FH6	018008	FH13	020065	A7	021100	E35	022132	FH19
017868	FH6	018009	FH12	020066	A7	021102	E35	022136	FH19
017884	FH6	018010	FH12	020104	E32	021103	E35	022140	FH19
017886	FH6	018011	FH12	020104-7	E32	021104	E35	022144	FH19
017888	FH6	018012	FH12	020106	E32	021105	E35	022148	FH19
017900	FH4	018013	FH13	020106-7	E32	021106	E35	022204	FH19
017901	FH4	018023	FH12	020108	E32	021107	E35	022206	FH19
017902	FH4	018025	FH13	020108-7	E32	021108	E35	022306	FH19
017910	FH5	018026	FH13	020110	E32	021109	E35	022308	FH19
017911	FH5	018027	FH13	020110-7	E32	021110	E35	022310	FH19
017912	FH5	018029	FH13	020112	E32	021111	E35	022312	FH19
017913	FH5	018030	FH13	020112-7	E32	021112	E35	022316	FH19
017914	FH5	018034	FH13	020116-7	E32	021113	E35	022320	FH19
017920	FH5	018035	FH13	020117-7	E32	021114	E35	022324	FH19
017921	FH5	018036	FH13	020118-7	E32	021115	E35	022328	FH19
017922	FH5	018037	FH13	020119-7	E32	021116	E35	022332	FH19
017931	FH5	018038	FH13	020132	A7	021117	E35	022336	FH19
017932	FH5	019002	FH24	020134	A7	021118	E35	022340	FH19
017940	FH5	019003	FH24	020134-6	A7	021119	E35	022344	FH19
017941	FH5	019004	FH24	020136	A7	022000	A9	022348	FH19
017942	FH5	019006	FH24	020136-7	A7	022001	A9	022352	FH19
017943	FH5	019009	FH24	020138	A7	022002	A9	022356	FH19
017944	FH5	019011	FH24	020138-7	A7	022004	A9	022360	FH19
017945	FH5	019013	FH24	020142	A7	022005	A9	022364	FH19
017946	FH5	019015	FH24	020144	A7	022008	A9	022372	FH19
017947	FH5	019017	FH24	020144-6	A7	022009	A9	022380	FH19
017950	FH5	019032	AC4	020146	A7	022011	A5	022388	FH19
017951	FH5	019049	FH24	020146-7	A7	022011-7	A5	022396	FH19
017952	FH5	019050	FH24	020154	A7	022025	A9	022400	FH21
017953	FH5	019051	FH24	020154-6	A7	022026	A9	022404	FH19
017954	FH5	019057	FH25	020156	A7	022027	A9	022410	FH21
017955	FH5	019058	FH25	020156-7	A7	022028	A8	022412	FH21
017956	FH5	019059	FH25	020157	A7	022030	A9	022416	FH21
017957	FH5	019060	FH25	020158	A7	022031	A9	022420	FH21
017958	FH5	019061	FH25	020158-7	A7	022032	A9	022424	FH21
017959	FH5	019062	FH25	020164	A7	022047	A5	022425	FH21
017960	FH5	019064	FH25	020164-6	A7	022047-7	A5	022430	FH21
017961	FH5	019065	FH25	020166	A7	022048	FH22	022435	FH21
017962	FH5	019067	FH25	020166-7	A7	022049	FH22	022440	FH21
017963	FH5	019069	FH25	020168	A7	022050	FH22	022445	FH21
017964	FH5	019070	FH25	020168-7	A7	022051	FH22	022450	FH21
017965	FH5	019071	FH25	021001	E35	022052	FH22	022462	FH21
017966	FH5	019072	FH25	021003	E35	022053	FH22	022463	FH21
017967	FH5	019073	FH25	021005	E35	022054	FH22	022464	FH21
017967	FH5	019088	FH24	021007	E35	022055	FH22	022465	FH21
		020052	A7	021009	E35	022056	FH22	022470	FH23



Call the Velvac Sales Team: **800.783.8871** [sales@velvac.com](mailto:sales@velvac.com)

PART NO.	PAGE	PART NO.	PAGE	PART NO.	PAGE	PART NO.	PAGE	PART NO.	PAGE
022471	FH23	022643	A10	032190	A17	034029	A14	034093	A25
022472	FH23	022644	A10	032191	A17	034030	A15	034095	F7
022473	FH23	022680	FH19	032192	A17	034031	A15	034101	A20
022474	FH23	022688	FH19	032194	A17	034032	A15	034111	A20
022475	FH23	023066	FH23	032195	A22	034033	A15	034112	A20
022476	FH23	023106	FH23	032201	A23	034034	A15	034113	A20
022477	FH23	023108	FH23	032205	A23	034035	A15	034114	A20
022478	FH23	023126	FH23	032206	A23	034036	A16	034122	A20
022506	FH19	023128	FH23	032216	A23	034037	A23	034123	A20
022508	FH19	030013	A27	032217	A23	034038	A15	034124	A20
022510	FH19	030015	A27	032218	A23	034039	A15	034126	A20
022512	FH19	030017	A27	032219	A23	034040	A15	034130	A21
022516	FH19	030019	A27	032220	A23	034041	A24	034131	A21
022520	FH19	030021	A27	032221	A23	034042	A24	034132	A21
022524	FH19	030074	A25	032222	A23	034043	A25	034133	A21
022528	FH19	030075	A25	032225	A19	034044	A26	034134	A21
022532	FH19	030084	A28	032227	A19	034045	A26	034135	A21
022536	FH19	030084	A29	032228	A19	034046	A25	034136	A21
022540	FH19	030092	A28	032229	A19	034047	A25	034137	A20
022544	FH19	030092	A28	032231	A19	034048	A25	035005	A3
022548	FH19	030092	A29	032232	A19	034049	A12	035007	A3
022550	FH20	030093	A28	032233	A19	034050	A12	035009	A3
022551	FH20	030093	A29	032234	A19	034051	A11	035010	A3
022556	FH19	030094	A29	032235	A19	034052	A12	035011	A3
022557	FH20	031021	A27	032236	A19	034053	A12	035012	R7
022564	FH19	031023	A27	032240	A22	034054	A12	035021	FH10
022565	R7	031025	A27	032241	A22	034055	A11	035025	A4
022572	FH19	031027	A27	032242	A22	034056	A13	035026	A4
022574	FH19	031031	A27	032243	A22	034057	A13	035029	FH10
022580	FH20	031033	A27	032244	A22	034058	A13	035031	A2
022581	FH20	031035	A27	032245	A22	034059	A13	035032	A2
022582	FH20	032015	A16	032246	A22	034062	A13	035033	A2
022583	FH20	032018	A16	032247	A20	034063	A14	035036	A4
022584	FH20	032019	A16	032248	A20	034064	A22	035037	A4
022585	FH20	032020	A16	032249	A20	034065	A22	035038	A2
022586	FH20	032022	A20	032250	A20	034066	A14	035042	A2
022587	FH20	032023	A20	032253	A20	034067	A14	035045	A2
022588	FH20	032037	A19	032400	A19	034068	A12	035065	A24
022589	FH20	032039	A19	032401	A19	034069	A14	035070	A4
022591	FH20	032051	A17	032402	A19	034070	A18	035079	FH10
022592	FH20	032058	A24	032403	A19	034071	A18	035081	FH9
022593	FH20	032060	A24	032404	A19	034072	A18	035087	FH9
022594	FH20	032081	A24	032405	A19	034073	A18	035092	A2
022596	FH20	032082	A24	032406	A19	034074	A23	035093	A2
022597	FH20	032083	A24	034012	A16	034075	A17	035094	A2
022598	FH20	032086	A23	034013	A11	034077	A15	035095	A2
022626	FH20	032110	A23	034014	A11	034078	A16	035100	A4
022627	FH20	032131	A14	034015	A11	034079	A11	035101	A27
022628	R8	032135	A24	034016	A11	034080	A11	035102	A27
022630	R8	032139	A22	034017	A11	034081	A12	035103	A27
022633	A10	032140	A22	034018	A11	034082	A12	035104	A27
022634	A10	032141	A22	034019	A11	034083	A14	035105	A27
022635	A10	032142	A18	034020	A13	034084	A16	035106	A27
022636	A10	032143	A18	034021	A13	034085	A12	035107	A27
022637	A10	032144	A18	034023	A13	034087	A25	035108	A27
022638	A10	032145	A18	034024	A13	034088	A25	035109	A27
022639	A10	032146	A18	034025	A13	034089	A25	035120	A26
022640	A10	032160	A24	034026	A13	034090	A25	035121	A26
022641	A10	032170	A24	034027	A13	034091	A25	035122	A26
022642	A10	032185	A24	034028	A13	034092	A25	035123	A26

## PARTS INDEX

PART NO.	PAGE	PART NO.	PAGE	PART NO.	PAGE	PART NO.	PAGE	PART NO.	PAGE
035124	A26	050019	E8	051171-7	E31	055093-10	E28	056035	E10
035125	A26	050019-7	E8	051173	E31	055094-10	E28	056036	E10
035126	A26	050029	E2	051175	E31	055095-10	E28	056037	E10
035127	A26	050037	E8	051175-7	E31	055096-10	E28	056038	E10
035128	A26	050042	E8	051177	E31	055097-10	E28	056039	E10
035129	A26	050042-7	E8	051177-7	E31	055098-10	E29	056040	E10
035130	A26	050051	E8	054001	E4	055099-10	E29	056041	E10
035131	A26	050052	E8	054002	E6	055100-10	E29	056042	E10
035132	A26	051050	E32	054003	E5	055101-10	E29	056043-50	E26
035140	A3	051050-7	E32	054017	E7	055102-10	E29	056044-50	E26
035141	A3	051052	E32	055034	E5	055103-10	E29	056045-50	E26
035142	A3	051054	E32	055037	E6	055104-10	E26	056046-50	E26
035143	A3	051058	E32	055038	E6	055105-10	E26	056047-50	E26
035144	A3	051058-7	E32	055039	E6	055106-10	E25	056049-50	E27
035145	A3	051060	E32	055040	E6	055107-10	E25	056051-50	E25
035146	A3	051062	E32	055041	E6	055108-10	E25	056052-50	E25
035147	A3	051066	E32	055043	E7	055109-10	E27	056053-50	E25
035150	A4	051101	E31	055045	E6	055110-10	E27	056054-10	E25
035150-6	A4	051103	E31	055049	E4	055111-10	E27	056055-10	E25
035151	A2	051105	E31	055050	E4	055112-10	E27	056056-10	E25
035152	A2	051117	E31	055051	E4	055113-10	E27	056060-50	E29
035160	R6	051117-6	E31	055052	E7	055114-10	E26	056061-50	E29
035161	R6	051119	E31	055053	E7	055115-10	E26	056062-50	E29
035162	R6	051119-6	E31	055054	E4	055116-10	E26	056063-50	E29
035163	R6	051121	E31	055056	E7	055117-10	E26	056064-50	E29
035164	A3	051121-6	E31	055059	E4	055118-10	E29	056065-50	E29
035165	A3	051123	E31	055060	E21	055119-10	E29	056066-50	E29
035166	A3	051123-6	E31	055062	E7	055120-10	E27	056067-50	E29
035167	A3	051125	E31	055063	E7	055121-10	E27	056068-50	E29
035168	A3	051127	E31	055064-10	E28	055122-10	E27	056069-50	E29
035169	A2	051129	E31	055065-10	E28	055123-10	E27	056070-50	E29
035170	A2	051135	E31	055066-10	E28	055124-10	E27	056071-50	E29
035173	A2	051135-6	E31	055067-10	E25	055125-10	E26	056076-50	E26
035174	A2	051137	E31	055068-10	E25	055126-10	E26	056078-50	E26
035175	A4	051137-6	E31	055069-10	E25	055127-10	E26	056080-50	E26
035176	A4	051139	E31	055070-10	E25	055128-10	E29	056082-10	E28
035177	A4	051139-6	E31	055071-10	E25	055129-10	E29	056083-10	E28
035178	A4	051141	E31	055075-10	E25	055130-10	E27	056084-10	E28
035179	A2	051141-6	E31	055075-50	E25	055131-10	E27	056086-50	E29
035180	A2	051143	E31	055076-10	E25	055132-10	E27	056088-50	E29
035181	A2	051143-6	E31	055076-50	E25	055133-10	E27	056093-50	E28
035182	A2	051145	E31	055077-10	E25	055134-10	E27	056094-10	E28
036003	A26	051145-6	E31	055077-50	E25	055135-10	E26	056096	E30
036019	A26	051147	E31	055078-10	E26	055136-10	E29	056097	E30
036021	A26	051147-6	E31	055079-10	E26	055137-10	E29	056107	E30
036036	A24	051153	E31	055080-10	E26	056001-50	E27	056108	E30
036043	A24	051155	E31	055081-10	E26	056002-50	E27	056109	E30
036045	A24	051155-7	E31	055082-10	E26	056003-50	E27	056111-100	E25
036049	A24	051157	E31	055083-10	E26	056004-50	E27	056111-5	E25
038001	H3	051157-7	E31	055084-10	E28	056006-50	E27	056112-100	E25
038003	H3	051159	E31	055085-10	E28	056007-50	E27	056112-5	E25
038005	H3	051159-7	E31	055086-10	E28	056008-50	E27	056113-100	E25
038008	H3	051161	E31	055087-10	E28	056009-50	E27	056113-5	E25
050001	E8	051161-7	E31	055088-10	E28	056010-50	E27	056121	R6
050001-7	E8	051163	E31	055089-10	E28	056011-50	E27	056144-25	E25
050007	E8	051163-7	E31	055090-10	E28	056012-50	E27	056145-25	E25
050007-7	E8	051165	E31	055091-10	E28	056033	E10	056146-25	E25
		051171	E31	055092-10	E28	056034	E10	056147-25	E28



Call the Velvac Sales Team: **800.783.8871** [sales@velvac.com](mailto:sales@velvac.com)

PART NO.	PAGE	PART NO.	PAGE	PART NO.	PAGE	PART NO.	PAGE	PART NO.	PAGE
056149-25	E28	057091-50	E29	058019	E11	058129	E9	058345-50	E26
056150-25	E28	057092-50	E26	058020	E10	058151	E9	058346-10	E28
056151-25	E28	057096-40	E29	058021	E10	058152	E9	058347-40	E29
056152-25	E28	057097-25	E33	058022	E10	058160	E37	058348-40	E29
056153-25	E28	057098-25	E33	058023	E10	058171	E36	058349-50	E27
056154-25	E28	057110	E34	058024	E10	058172	E36	058350-50	E27
056155-25	E26	057111	E34	058026	E36	058173	E36	058351-50	E27
056156-25	E26	057112	E34	058028-50	E25	058212	E9	058352-50	E27
056157-25	E26	057112-10	E33	058029-50	E25	058233	E8	058353-50	E27
056158-25	E29	057113	E34	058030	E36	058233-7	E8	058354-50	E27
056159-25	E29	057113-10	E33	058033	E8	058235	E8	058355-50	E27
056160-25	E29	057114	E34	058033-7	E8	058235-7	E8	058356-50	E27
056164-25	E29	057114-10	E33	058035	E8	058237	E8	058357-50	E27
056165-25	E29	057115	E34	058035-7	E8	058237-7	E8	058358-50	E27
056166-25	E29	057115-10	E33	058037	E8	058239	E8	058362-50	E25
056167-25	E29	057116	E34	058037-7	E8	058239-7	E8	058363-10	E28
056168-25	E29	057116-10	E33	058039	E8	058241	E8	058364-50	E28
056169-25	E29	057117	E34	058039-7	E8	058241-7	E8	058365-50	E28
056184-50	E28	057117-10	E33	058041	E8	058243	E8	058366-40	E28
056185-50	E28	057118	E5	058041-7	E8	058243-7	E8	058367-10	E28
056186-50	E28	057119	E5	058043	E8	058245	E8	058370	AC7
057002	E10	057120	E5	058043-7	E8	058247	E8	058373	AC7
057003	E22	057121	E5	058045	E8	058251	E13	058374	AC7
057050	E11	057123	E36	058046	E13	058252	E13	058377	AC7
057051	E11	057124	E36	058047	E8	058253	E13	058379	AC7
057052	E11	057125	E36	058050	E11	058254	E13	058380	E37
057053	E11	057126	E37	058051	E11	058296	E13	058380-4	R6
057054	E11	057127	E37	058052	E11	058301-50	E28	058381	E37
057055	E11	057128	E37	058053	E11	058302-50	E28	058381-4	R6
057056	E11	057131	E33	058054	E11	058304-50	E28	058382	E37
057057	E11	057132	E33	058055	E11	058305-50	E28	058395	AC7
057058	E34	057133	E33	058056	E11	058306-50	E28	058396	AC7
057058-10	E33	057146-10	E33	058057	E11	058307-50	E28	058397	AC7
057059	E34	057147-10	E33	058058	E11	058308-50	E28	058398	AC7
057059-10	E33	057148-5	E33	058068	E13	058309-50	E26	058399	AC7
057060	E34	057149-25	E33	058071	E13	058310-50	E26	058400	AC7
057060-10	E33	057150-25	E33	058073	E10	058311-50	E26	058402	AC7
057061-25	E33	057151-25	E33	058074	E10	058312-50	E25	058416	E12
057062-25	E33	057152-2	E33	058076	E10	058313-40	E25	058417	E12
057071	E36	057153-2	E33	058077	E10	058314-40	E25	058418	E12
057073	E34	057158	E34	058078	E10	058315-40	E29	058419	E12
057073-10	E33	057158-10	E33	058079	E10	058316-40	E29	058420	E12
057074	E34	057159-5	E33	058081	E10	058317-10	E29	058421	E12
057074-10	E33	057160-2	E33	058082	E10	058318-50	E29	058422	E12
057075-50	E27	057174-2	E33	058083	E10	058319-50	E29	058423	E12
057076-50	E27	058001	E11	058084	E10	058320-10	E29	058424	E12
057077-50	E27	058002	E11	058086	E10	058325	E10	058425	E12
057078-50	E27	058003	E11	058088	E10	058326	E10	058426	E12
057079-50	E27	058004	E11	058090	E13	058327	E10	058427	E12
057080-50	E27	058005	E11	058091	E13	058328	E10	058428	E12
057081-50	E27	058006	E11	058092	E13	058329	E10	058429	E12
057082-50	E26	058007	E11	058093	E13	058330	E10	058430	E12
057083-50	E26	058008	E11	058094	E13	058331	E10	058431	E12
057084-50	E26	058009	E11	058095	E13	058332	E10	058432	E12
057085-50	E25	058010	E11	058115	E9	058334-50	E28	058433	E12
057086-50	E25	058011	E11	058116	E9	058335-50	E26	058434	E12
057087-50	E25	058012	E13	058117	E9	058336-50	E26	058435	E12
057088-50	E29	058013	E13	058118	E9	058337-50	E26	058436	E12
057089-50	E29	058016	E13	058119	E9	058338-50	E26	058437	E12
057090-50	E29	058017	E13	058128	E9	058340-50	E26	058438	E12

## PARTS INDEX

PART NO.	PAGE	PART NO.	PAGE	PART NO.	PAGE	PART NO.	PAGE	PART NO.	PAGE
058439	E12	090076	E18	090198	E15	091076	E20	091306-5	E21
058440	E12	090078	E16	090199	E15	091080	E20	091307-5	E21
058441	E12	090079	E16	090200	E15	091081	E20	091308-5	E21
058442	E12	090080	E16	090201	E15	091082	E20	091309-5	E21
058443	E12	090081	E16	090202	E15	091083	E20	091325	E22
058444	E12	090082	E16	090203	E15	091130	E22	091326	E22
058445	E12	090083	E16	090204	E15	091131-5	E21	091350	E20
058446	E12	090085	E16	090205	E15	091132-5	E21	091351	E20
058447	E12	090104	E14	090206	E15	091133-5	E21	091400-5	E21
058448	E12	090109	E17	090207	E15	091135-5	E21	091401-5	E21
058449	E12	090110	E17	090208	E15	091137-5	E21	091402-5	E21
058450	E12	090111	E17	090209	E15	091140-5	E21	091403-5	E21
058451	E12	090113	AC5	090210	E14	091141-5	E21	091404-5	E21
058452	E12	090114	AC5	090211	E14	091142-5	E21	091406-3	E21
060001	F6	090115	AC5	090212	E14	091143-5	E21	091425	E22
060004	F6	090116	AC5	090213	E14	091144-5	E21	091426	E22
060007	F6	090119	AC5	090214	E14	091173-5	E21	091427	E21
060012	F6	090120	E14	090215	E14	091174-5	E21	091500-3	E20
060026	F6	090123	E17	090216	E6	091175-5	E21	091501	E20
060027	F6	090124	E17	090217	E7	091177-5	E21	091502	E20
060033	F8	090125	E17	090218	E7	091180-5	E21	091503	E20
060040	F7	090128	E17	090219	E17	091181-5	E21	091504	E20
060047	F7	090136	E17	090220	E17	091182-5	E21	091505	E20
060049	F7	090142	AC4	090221	E17	091183-5	E21	091510-10	E20
060050	F6	090145	AC4	090222	E17	091184-5	E21	091511-10	E20
060056	F8	090147	E17	090225	E16	091188	E22	091512-10	E20
060060	F7	090149	E17	090226	E5	091189	E22	091513-10	E20
060061	F7	090150	E17	090227	E5	091190	E22	091514-10	E20
060062	F7	090153	E17	090233	E14	091201	E19	091520	E20
060063	F7	090158	E17	090234	E14	091202	E19	091521	E20
060064	F7	090159	E17	090240	AC4	091203	E19	091522	E20
060070	F6	090162	AC4	091001	E23	091204	E19	091523	E20
060071	F6	090165	AC4	091002	E23	091208	E19	091524	E20
090002-100	E34	090166	E17	091003	E20	091209	E19	100022	A32
090004-100	E34	090167	E17	091004	E20	091210	E19	100028	A32
090006-25	E34	090168	E17	091005	E20	091211	E19	100036	A32
090010-25	E34	090169	E17	091006	E20	091212	E19	100037	A32
090014	FH16	090173	E14	091007	E20	091213	E19	100101	A32
090014-100	E34	090174	E14	091008	E20	091214	E19	100102	A32
090016-100	E34	090176	E15	091011	E20	091215	E19	100122	A30
090028	A8	090177	E15	091015	E20	091216	E19	100123	A30
090029-50	E34	090179	E15	091020	E20	091225	E19	100124	A30
090030-50	E34	090180	E18	091025	E20	091230	E18	100125	A30
090040	E15	090181	E18	091030	E20	091231	E18	100126	A30
090043	E15	090182	AC4	091040	E20	091232	E18	100131	A30
090048	E15	090184	E15	091050	E20	091233	E18	100132	A30
090054	E16	090185	AC4	091051	E20	091235	E18	100136	A30
090056	E16	090186	E15	091052	E20	091236	E18	100137	A30
090060	AC5	090187	E15	091053	E20	091237	E18	100144-7	A32
090061	AC5	090188	E15	091054	E20	091251	E21	100204	A29
090064-100	E34	090189	E15	091055	E20	091254	E21	100206	A29
090066-100	E34	090190	E14	091056	E20	091256	R10	100208	A29
090067-100	E34	090191	E15	091057	E20	091300-5	E21	100226	A29
090068-100	E34	090192	E15	091071	E20	091301-5	E21	100308	A29
090070-25	E34	090193	E15	091072	E20	091302-5	E21	100310	A29
090071-25	E34	090194	E15	091073	E20	091303-5	E21	100424	A31
090073	E16	090196	E15	091074	E20	091304-5	E21	100603	A31
		090197	E15	091075	E20	091305-5	E21	100613	A31



Call the Velvac Sales Team: **800.783.8871** [sales@velvac.com](mailto:sales@velvac.com)



PART NO.	PAGE	PART NO.	PAGE	PART NO.	PAGE	PART NO.	PAGE	PART NO.	PAGE
100614	A31	146018	A5	147048	A5	149034	A5	320191	A34
100615	A31	146020	A5	147054	A5	149036	A5	320192	A33
101002	A32	146022	A5	147060	A5	149042	A5	321034	A28
101003	A32	146024	A5	147072	A5	149046	A5	351108	V11
101004	A32	146026	A5	148012	A5	149048	A5	351109	V11
101054	A32	146028	A5	148016	A5	149060	A5	409904	R5
101055	A32	146030	A5	148018	A5	149072	A5	500001	FH8
101058	A32	146032	A5	148020	A5	149119	A5	500003	FH9
101059	A32	146034	A5	148022	A5	149120	A5	500004	FH9
101078	A32	146036	A5	148024	A5	149121	A5	500005	FH9
131012	A17	146038	A5	148026	A5	149122	A5	500007	A7
131014	A17	146040	A5	148028	A5	149123	A5	500008	A7
131016	A17	146042	A5	148030	A5	149124	A5	500009	FH8
131045	A27	146044	A5	148032	A5	149125	A5	500011	FH9
140000	FH9	146046	A5	148034	A5	149126	A8	500015	FH8
140079	A7	146048	A5	148036	A5	210304	V16	500017	FH9
140133	A6	146052	A5	148038	A5	210307	V16	500019	FH9
140134	A6	146054	A5	148040	A5	210312	V16	500021	FH9
140135	A6	146060	A5	148042	A5	210501	V16	500022	FH9
140136	A6	146072	A5	148044	A5	210512	V15	500024	FH9
140139	A6	146084	A5	148046	A5	210517	V15	500025	FH9
140140	A6	146518	A5	148048	A5	210522	V15	500027	FH9
140141	A6	146520	A5	148054	A5	210527	V15	500030	FH9
140142	A6	146522	A5	148060	A5	210532	V15	500031	FH9
142001	FH9	146524	A5	148066	A5	210542	V16	500033	FH9
142101	FH10	146526	A5	148072	A5	210543	V16	500035	FH9
142102	FH10	146528	A5	148084	A5	250001	V16	500037	FH9
142103	FH10	146530	A5	148096	A5	250500	V15	500039	FH8
142104	FH10	146532	A5	148518	A5	250501	V15	500041	FH9
142106	FH10	146534	A5	148520	A5	320001	A26	500042	FH9
142107	FH10	146536	A5	148522	A5	320003	A26	500044	FH8
142108	FH10	146538	A5	148524	A5	320014	A26	500046	FH8
142110	FH10	146540	A5	148526	A5	320051	A17	500050	FH8
142111	FH10	146542	A5	148528	A5	320125	A28	500051	FH8
142113	A6	146544	A5	148530	A5	320132	A28	500052	FH9
142113-7	A6	146546	A5	148532	A5	320133	A28	500053	FH9
142114	A6	146548	A5	148534	A5	320146	A33	500054	FH9
142118	A6	146554	A5	148536	A5	320147	A33	500055	FH9
142124	A6	146560	A5	148538	A5	320148	A33	500059	FH9
142130	A6	146572	A5	148540	A5	320149	A24	500060	FH9
142136	A6	146584	A5	148542	A5	320170	A33	500061	FH9
142148	A6	146596	A5	148544	A5	320171	A33	500063	FH9
142324	A6	147009	A5	148546	A5	320172	A33	500064	FH9
142336	A6	147012	A5	148548	A5	320173	A33	500065	FH9
142436	A6	147016	A5	148554	A5	320175	A28	500066	FH9
142518	A6	147018	A5	148560	A5	320176	A28	500070	FH9
142524	A6	147020	A5	148572	A5	320177	A28	500071	FH9
142536	A6	147022	A5	148584	A5	320178	A28	500078	FH9
142552	A6	147024	A5	148596	A5	320179	A28	500079	FH9
142554	A6	147026	A5	149001	A8	320180	A28	500080	FH9
142572	A6	147028	A5	149002	A8	320181	A34	500081	FH9
142584	A6	147030	A5	149005	FH10	320182	A34	500082	FH9
142618	A6	147032	A5	149006	FH10	320183	A34	500083	FH9
142624	A6	147034	A5	149018	A5	320184	A33	500084	FH9
145110	A8	147036	A5	149020	A5	320185	A34	500085	FH9
145112	A8	147038	A5	149024	A5	320186	A34	500088	FH9
145115	A8	147040	A5	149026	A5	320187	A28	500094	FH8
145120	A8	147042	A5	149028	A5	320188	A33	500096	FH10
145212	A8	147044	A5	149030	A5	320189	A34	501051	A27
145215	A8	147046	A5	149032	A5	320190	A34	501071	FH9

## PARTS INDEX

PART NO.	PAGE	PART NO.	PAGE	PART NO.	PAGE	PART NO.	PAGE	PART NO.	PAGE
580009	A4	590156	E3	600081	F5	690064	FH18	700064	M31
580037	H2	590157	E3	600112	F8	690071	FH18	701001	M31
580038	H2	590159	E3	600133	F4	690072	FH17	701006	M31
580039	H2	590160	E3	600135	F2	690090	R6	701050	M31
580040	H2	590161	E3	600136	F2	690091	R6	701054	M31
580041	H2	590163	E3	600148	F2	690104	R9	701071	M31
580042	A4	590165	E3	600149	F3	690107	R9	701072	M31
580066	H2	590166	E3	600150	F3	690108	R9	702023	M21
580067	H2	590171	E2	600168	F2	690110	R2	702023	M22
580076	H2	590172	E2	600169-6	F3	690111	R4	702042	M3
580078	H2	590177	E3	600172	F2	690187	R5	702044	M3
580081	H2	590178	E3	600175	F5	690188	R5	702045	M3
580082	H2	590179	E3	600176	F5	690189	R5	702047	M3
580086	H2	590180	E3	600180	F2	690190	R5	702051	M22
580094	H2	590251	E3	600181-6	F3	690191	R5	702057	M22
580107	H2	590252	E3	600183-6	F3	690192	R5	702076	M21
580111	H2	590253	E3	600184	F2	690193	R5	702076	M22
580112	H2	590254	E3	600185-6	F3	690194	R5	702086	M69
580113	AC3	590255	E3	600186	F2	690195	R5	702098-5	M21
580114	AC3	590256	E3	600191	F8	690196	R5	702148	M13
580115	AC3	590263	E2	600196-6	F4	690197	R9	702149	M13
580116	AC3	590264	E2	600198	F2	690198	R9	702157	M20
580117	AC3	591009	E5	600211	F2	690199	R9	702158	M13
580123	A4	591010	E5	600212	F3	690200	R9	702159	M13
581001	H4	591019	E7	600219	F5	690201	R3	703005	M21
581005	H4	591022	E7	600220	F5	690202	R6	703005	M22
581006	H4	591090	E6	600221	F5	691015	E31	703006	M21
581006	A4	591105	E4	600241	F5	691015	R10	703007	M21
581011	H4	591109	E4	600242	F5	691020	R8	703007	M22
581015	H4	591113	E6	600243	F5	691050	R9	703008	M21
581038	H4	591115	E5	600244	F5	696087	B4	703101	M22
581040	H4	591116	E5	600245	F5	696097	B4	703102	M22
581100	H3	591117	E5	600246	F5	696107	B4	703103	M22
581100-5	H3	591161	E4	600258	F5	697002	B2	703104	M22
581101	H3	593019	E4	600259	F3	697007	B2	704032	M22
581101-5	H3	593022	E4	600260	F2	697017	B2	704065	M131
581102	H3	593024	E4	600263	F3	697032	B2	704066	M131
581102-5	H3	593029	E4	600264	F2	697066	B3	704068	M131
581103	H3	593052	E6	600265	F5	697087	B3	704069	M131
581103-5	H3	593054	E6	600270	F4	697097	B3	704070	M131
581104	H3	593057	E4	600631	F5	697103	B3	704077	M22
581104-5	H3	593059	E4	600632	F5	697104	B2	704078	M22
581105	H3	593060	E4	600633	F5	697105	B2	704091	M22
581105-5	H3	593083	E7	601063	F5	697106	B2	704093	M22
581106	H3	593084	E7	601065	F2	697107	B3	704095	M22
581106-5	H3	593101	E4	601069	F5	697112	B3	704120	M124
581107	H3	593106	E7	602002	F8	697124	B4	704120	M22
581107-5	H3	593111	E4	690007	R7	697125	B4	704121	M22
590036	E3	593116	E4	690008	R7	697187	B4	704122	M124
590046	E3	593121	E6	690021	H3	697197	B4	704122	M22
590061	E2	600007	F4	690022	H3	697287	B3	704132-5	M22
590080	E3	600009	F4	690023	H3	697297	B3	704152-5	M22
590081	E3	600011	F5	690031	FH16	699087	B3	704153-5	M22
590135	E2	600017	F4	690033	FH16	699097	B3	704154	M22
590136	E2	600021	F5	690035	FH16	699107	B3	704155	M22
590154	E3	600040	F5	690037	FH16	699112	B3	704158	M22
590155	E3	600041	F5	690050	FH16	699287	B3	704159	M22
		600053	F5	690059	FH17	699297	B3	704177-5	M22



Call the Velvac Sales Team: **800.783.8871** [sales@velvac.com](mailto:sales@velvac.com)

PART NO.	PAGE	PART NO.	PAGE	PART NO.	PAGE	PART NO.	PAGE	PART NO.	PAGE
704178-5	M22	708476	M12	709589	M24	710651	V11	714527	M46
704268	M21	708478	M12	709623	M24	710651-1	V11	714528	M46
704280	M21	708479	M12	709624	M24	710651-3	V11	714529	M46
704315	M22	708501	M12	709650	M24	712245	M30	714530	M46
704325	M22	708502	M12	709651	M24	712323	M29	714531	M46
704335	M22	708503	M12	709673	M128	712479	M30	714532	M46
705038	M5	708504	M12	709673	M24	712638	M29	714533	M46
705051	M22	708508	M12	709674	M128	712640	M29	714534	M46
705101	M4	708509	M12	709674	M24	712641	M28	714535	M46
705102	M4	708510	M12	709701	M24	712642	M28	714536	M46
705103	M4	708511	M12	709702	M24	712643	M28	714537	M46
705104	M5	708513	M12	709732	M24	712644	M28	714538	M46
705105	M5	708514	M12	709733	M24	712647	M28	714539	M46
705107	M5	708515	M12	709748	M128	712648	M130	714540	M46
705108	M4	708516	M12	709785	M129	712896	M124	714541	M46
705111	M5	708520	M12	709855	M128	712897	M124	714542	M46
705112	M3	708521	M12	709912	V3	712898	M124	714543	M46
705113	M3	708525	M4	709915	V6	712900	M124	714544	M46
705114	M3	708526	M4	709916	V6	712908	M67	714545	M61
705115	M3	708551	M12	709921	V8	713104	M49	714546	M61
705116	M3	708552	M12	709931	M128	713113	M49	714547	M61
705117	M5	708553	M12	709932	M128	713114	M49	714548	M61
705148	M50	708554	M12	709941	V4	713118	M49	714549	M61
705150	M50	708555	M12	709942	V4	713119	M49	714550	M61
705332	M4	708556	M12	709948	V4	713120	M49	714551	M61
705333	M4	708557	M12	709949	V4	713121	M49	714552	M61
705334	M4	708558	M12	709952	V3	713154	M50	714553	M61
705335	M4	708559	M12	709953	V6	713198	M95	714554	M61
708001	M3	708560	M12	709954	V8	713204	M49	714555	M61
708005	M3	708601	M13	709993	M129	713404	M29	714556	M61
708008	M3	708602	M13	709994	M128	713407	M49	714557	M61
708020	M3	708603	M13	709995	M128	713444	M26	714558	M61
708022	M3	708604	M13	710011	V3	713445	M26	714559	M61
708046	M3	708605	M13	710323	V6	713752	M28	714560	M61
708156	M21	708606	M13	710324	V6	713759	M31	714561	M61
708176-5	M21	708608	M13	710325	V5	713760	M31	714562	M61
708181	M21	708609	M13	710326	V3	713769	M31	714563	M61
708197-5	M21	708610	M13	710359	V9	713785	M67	714564	M61
708198-5	M21	708611	M19	710360	V9	713789	M67	714565	M61
708209	M2	708615	M13	710384	V10	713796	M68	714566	M61
708209-4	M2	708685	M50	710385	V10	713798	M68	714567	M61
708211	M2	709002	M18	710386	V10	713883	M68	714568	M61
708211-4	M2	709006	M18	710387	V10	713993	M68	714569	M61
708331	M4	709216	M12	710388	V10	714146	M124	714570	M61
708335	M95	709217	M12	710389	V10	714147	M124	714571	M61
708336	M95	709218	M12	710390	V10	714256	M128	714572	M61
708337	M95	709226	M12	710391	V10	714258	M128	714573	M61
708369	M2	709226	M124	710392	V10	714403	M28	714574	M61
708441	M12	709275	M18	710393	V10	714515	M46	714575	M128
708442	M12	709276	M18	710394	V10	714516	M46	714576	M128
708444	M12	709309	M2	710395	V10	714517	M46	714577	M128
708446	M12	709329	M2	710396	V10	714518	M46	714578	M128
708448	M12	709407	M128	710397	V10	714519	M46	714579	M128
708449	M12	709422	M128	710589	V5	714520	M46	714580	M128
708450	M12	709448	M128	710615	V3	714521	M46	714581	M128
708453	M12	709448	M24	710640	V11	714522	M46	714581	M24
708457	M12	709449	M128	710640-1	V11	714523	M46	714582	M128
708463	M12	709449	M24	710640-3	V11	714524	M46	714582	M24
708463	M124	709450	M24	710641	V11	714525	M46	714589	M128
708473	M12	709589	M128	710649	V11	714526	M46	714589	M24

## PARTS INDEX

PART NO.	PAGE	PART NO.	PAGE	PART NO.	PAGE	PART NO.	PAGE	PART NO.	PAGE
714590	M128	714920	M61	715433	M39	715915	M63	716056	M129
714590	M24	714921	M61	715434	M39	715916	M63	716103	M128
714591	M61	714942	M24	715435	M39	715917	M63	716104	M128
714592	M61	714943	M24	715436	M39	715918	M63	716105	M128
714593	M61	714944	M24	715437	M39	715919	M63	716106	M128
714601	M61	714945	M24	715438	M39	715920	M63	716107	M129
714602	M61	714946	M24	715439	M39	715921	M63	716109	M129
714603	M61	714947	M24	715440	M39	715922	M63	716113	M129
714604	M61	715101	M28	715441	M39	715923	M41	716115	M129
714605	M61	715131	M46	715442	M39	715924	M41	716138-5	M68
714606	M61	715132	M46	715443	M39	715925	M41	716152	M24
714607	M128	715133	M46	715444	M39	715926	M41	716153	M24
714607	M24	715141	M46	715445	M39	715927	M41	716154	M24
714608	M128	715148	M26	715446	M39	715928	M41	716155	M24
714608	M24	715150	M26	715447	M39	715929	M41	716187	M24
714620	M25	715153	M46	715448	M39	715930	M41	716188	M24
714621	M25	715154	M46	715449	M39	715931	M41	716189	M24
714622	M25	715166	M51	715450	M39	715932	M41	716190	M24
714623	M25	715168	M51	715451	M39	715933	M41	716205	M24
714624	M25	715198	M18	715452	M39	715934	M41	716206	M24
714625	M25	715203	M18	715453	M39	715935	M63	716207	M24
714626	M25	715212	M28	715454	M39	715936	M63	716208	M24
714627	M25	715213	M28	715455	M39	715937	M63	716314	V6
714628	M25	715372	M23	715456	M39	715938	M63	716318	V6
714629	M25	715373	M23	715457	M39	715939	M63	716319	M41
714630	M25	715374	M23	715458	M39	715940	M63	716320	M41
714631	M25	715401	M39	715459	M39	715941	M63	716321	M41
714646	M25	715402	M39	715460	M39	715942	M63	716322	M41
714647	M25	715403	M39	715529	M25	715943	M63	716323	M41
714648	M25	715404	M39	715620	M25	715944	M63	716324	M41
714649	M25	715405	M39	715704	M121	715945	M63	716325	M63
714672	M30	715406	M39	715778	M26	715946	M63	716326	M63
714673	M30	715407	M39	715779	M26	715953	M41	716327	M63
714674	M30	715408	M39	715786	M124	715954	M41	716328	M63
714675	M30	715409	M39	715859	M46	715955	M41	716329	M63
714720	M26	715410	M39	715860	M46	715962	M63	716330	M63
714721	M26	715411	M39	715861	M46	715963	M63	716331	M42
714782	M124	715412	M39	715885	M69	715964	M63	716332	M42
714783	M124	715413	M39	715886	M69	715971	M41	716333	M42
714784	M124	715414	M39	715887	M69	715972	M41	716334	M42
714785	M124	715415	M39	715888	M69	715973	M41	716335	M42
714904	M61	715416	M39	715889	M69	715980	M63	716336	M42
714905	M61	715417	M39	715899	M41	715981	M63	716337	M42
714906	M61	715418	M39	715900	M41	715982	M63	716338	M42
714907	M61	715419	M39	715901	M41	715985	M128	716339	M42
714908	M61	715420	M39	715902	M41	715986	M128	716340	M42
714909	M61	715421	M39	715903	M41	715987	M128	716341	M42
714910	M61	715422	M39	715904	M41	715988	M128	716342	M42
714911	M61	715423	M39	715905	M41	715989	M128	716343	M41
714912	M61	715424	M39	715906	M41	715990	M128	716344	M41
714913	M61	715425	M39	715907	M41	715991	M128	716345	M41
714914	M61	715426	M39	715908	M41	715992	M128	716346	M41
714915	M61	715427	M39	715909	M41	715997	M128	716347	M41
714916	M61	715428	M39	715910	M41	716011	M128	716348	M41
714917	M61	715429	M39	715911	M63	716011	M129	716349	M63
714918	M61	715430	M39	715912	M63	716012	M128	716350	M63
714919	M61	715431	M39	715913	M63	716012	M129	716351	M63
		715432	M39	715914	M63	716055	M129	716352	M63



Call the Velvac Sales Team: **800.783.8871** [sales@velvac.com](mailto:sales@velvac.com)

PART NO.	PAGE	PART NO.	PAGE	PART NO.	PAGE	PART NO.	PAGE	PART NO.	PAGE
716353	M63	716415	M41	716974	M128	717561	M65	717826	V13
716354	M63	716416	M41	717174	M45	717574	M65	717827	V13
716355	M42	716417	M63	717175	M45	717575	M65	717828	V13
716356	M42	716418	M63	717176	M45	717576	M65	717829	V13
716357	M42	716419	M63	717181	M45	717577	M65	717830	V13
716358	M42	716420	M63	717182	M45	717578	M65	717831	V13
716359	M42	716421	M63	717183	M45	717579	M65	717832	V13
716360	M42	716422	M63	717184	M45	717580	M65	717844	M26
716361	M42	716423	M42	717185	M45	717581	M65	717845	M26
716362	M42	716424	M42	717186	M45	717582	M65	717866	M45
716363	M42	716425	M42	717187	M45	717583	M65	717867	M45
716364	M42	716426	M42	717188	M45	717584	M65	717868	M45
716365	M42	716427	M42	717189	M45	717585	M65	717871	V5
716366	M42	716428	M42	717379	M45	717586	M44	717878	V4
716367	M41	716429	M42	717380	M45	717587	M44	717897	V4
716368	M41	716430	M42	717381	M45	717588	M44	717901	V4
716369	M41	716431	M42	717382	M45	717589	M44	717953	V4
716370	M41	716433	M128	717383	M45	717590	M44	717971	V4
716371	M41	716434	M128	717384	M45	717591	M44	717973	V3
716372	M41	716435	M63	717501	M45	717592	M44	718389-5	M61
716373	M63	716436	M63	717502	M45	717593	M44	718390-5	M61
716374	M63	716437	M63	717503	M45	717594	M44	718391-5	M61
716375	M63	716498	M128	717504	M43	717595	M44	718394-5	M18
716376	M63	716499	M128	717505	M43	717596	M44	718416	M64
716377	M63	716502	M128	717506	M43	717597	M44	718417	M64
716378	M63	716503	M128	717507	M43	717598	M44	718418	M64
716379	M41	716504	M128	717508	M43	717599	M44	718419	M64
716380	M41	716505	M128	717509	M43	717600	M44	718420	M64
716381	M41	716506	M128	717513	M45	717601	M44	718421	M64
716382	M41	716507	M128	717514	M45	717602	M44	718422	M64
716383	M41	716508	M128	717515	M45	717603	M44	718423	M64
716384	M41	716509	M128	717516	M43	717607	M44	718424	M64
716385	M63	716515	M129	717517	M43	717608	M44	718425	M64
716386	M63	716516	M129	717518	M43	717609	M44	718426	M64
716387	M63	716519	M129	717523	M43	717770	V9	718427	M64
716388	M63	716520	M129	717524	M43	717771	V9	718428	M64
716389	M63	716521	M129	717525	M43	717772	V9	718429	M64
716390	M63	716522	M129	717526	M43	717773	V9	718430	M64
716391	M41	716525	M129	717527	M43	717774	V9	718431	M64
716392	M41	716526	M129	717528	M43	717775	V9	718432	M64
716393	M41	716872	M18	717541	M43	717776	V9	718433	M64
716394	M41	716900	M28	717542	M43	717777	V9	718434	M64
716395	M41	716901	M28	717543	M43	717778	V9	718435	M64
716396	M41	716902	M121	717544	M43	717809	V13	718436	M64
716397	M63	716902	M28	717545	M43	717810	V13	718437	M64
716398	M63	716903	M28	717546	M43	717811	V13	718438	M64
716399	M63	716906	M28	717547	M43	717812	V13	718439	M64
716402	M42	716907	M28	717548	M43	717813	V13	718440	M64
716403	M42	716908	M49	717549	M43	717814	V13	718441	M64
716404	M42	716909	M68	717550	M65	717815	V13	718442	M64
716405	M42	716913	M25	717551	M65	717816	V13	718443	M64
716406	M42	716914	M25	717552	M65	717817	V13	718444	M64
716407	M42	716915	M25	717553	M65	717818	V13	718445	M64
716408	M42	716916	M25	717554	M65	717819	V13	718446	M64
716409	M42	716917	M25	717555	M65	717820	V13	718447	M64
716410	M42	716918	M25	717556	M65	717821	V13	718448	M64
716411	M41	716919	M25	717557	M65	717822	V13	718449	M64
716412	M41	716922	M25	717558	M65	717823	V13	718450	M64
716413	M41	716929	M29	717559	M65	717824	V13	718451	M64
716414	M41	716973	M128	717560	M65	717825	V13	718612	M43



## PARTS INDEX

PART NO.	PAGE	PART NO.	PAGE	PART NO.	PAGE	PART NO.	PAGE	PART NO.	PAGE
718613	M43	719268	M50	719369	M40	719429	M62	719592	V8
718614	M43	719311	M40	719370	M40	719430	M62	719593	V8
718615	M43	719312	M40	719371	M40	719431	M62	719594	V8
718616	M43	719313	M40	719372	M40	719432	M62	719595	V8
718617	M43	719314	M40	719373	M40	719433	M62	719596	V8
718618	M65	719315	M40	719374	M40	719434	M62	719597	V8
718619	M65	719316	M40	719375	M40	719435	M62	719598	V8
718620	M65	719317	M40	719376	M40	719436	M62	719599	V8
718621	M65	719318	M40	719379	M40	719437	M62	719600	V8
718622	M65	719319	M40	719380	M40	719438	M62	719601	V8
718623	M65	719320	M40	719381	M40	719439	M62	719602	V8
718730	M66	719321	M40	719382	M40	719440	M62	719603	V8
718731	M66	719322	M40	719383	M40	719441	M62	719612	V8
718732	M66	719323	M40	719384	M40	719442	M62	721090	M29
718733	M66	719324	M40	719385	M40	719443	M62	721092	M29
718734	M66	719325	M40	719386	M40	719444	M62	723047	M130
718735	M66	719326	M40	719387	M40	719445	M62	723049	M130
718736	M66	719327	M40	719388	M40	719446	M62	723050	M19
718737	M66	719328	M40	719389	M40	719447	M62	723055	M130
718738	M66	719329	M40	719390	M40	719448	M62	723057	M130
718739	M66	719330	M40	719391	M40	719449	M62	723060	M19
718740	M66	719331	M40	719392	M40	719450	M62	723065	M19
718741	M66	719332	M40	719393	M40	719451	M62	723068	M124
718742	M66	719333	M40	719394	M40	719452	M62	723068	M19
718743	M66	719334	M40	719395	M40	719453	M62	723068-6	M19
718744	M66	719335	M40	719396	M40	719454	M62	723075	M19
718745	M66	719336	M40	719397	M62	719455	M62	723095	M18
718746	M66	719337	M40	719398	M62	719456	M62	723097	M18
718747	M66	719338	M40	719399	M62	719457	M62	723100	M130
718748	M66	719339	M40	719400	M62	719458	M62	723103	M124
718749	M66	719340	M40	719401	M62	719459	M62	723103	M13
718750	M66	719341	M40	719402	M62	719460	M62	723104	M13
718751	M66	719342	M40	719403	M62	719461	M62	723106	M69
718752	M66	719343	M40	719404	M62	719462	M62	723107	M69
718753	M66	719344	M40	719405	M62	719463	M62	723115	M130
718754	M66	719345	M40	719406	M62	719464	M62	724007	M29
718755	M66	719346	M40	719407	M62	719465	M62	724008	M29
718756	M66	719347	M40	719408	M62	719466	M62	727067	M29
718757	M66	719348	M40	719409	M62	719467	M62	728730	M47
718758	M66	719349	M40	719410	M62	719468	M62	728731	M47
718759	M66	719350	M40	719411	M62	719469	M62	728732	M47
718763	M66	719351	M40	719412	M62	719470	M62	728733	M47
718764	M66	719352	M40	719413	M62	719471	M62	728734	M47
718765	M66	719353	M40	719414	M62	719472	M62	728735	M47
718766	M66	719354	M40	719415	M62	719473	M62	728736	M47
718767	M66	719355	M40	719416	M62	719474	M62	728737	M47
718768	M66	719356	M40	719417	M62	719475	M62	728738	M47
718769	M66	719357	M40	719418	M62	719476	M62	728739	M47
718770	M66	719358	M40	719419	M62	719477	M62	728740	M47
718771	M66	719360	M40	719420	M62	719478	M62	728741	M47
718772	M66	719361	M40	719421	M62	719479	M62	728742	M47
718773	M66	719362	M40	719422	M62	719480	M62	728743	M47
718774	M66	719363	M40	719423	M62	719547	V13	728744	M47
718775	M66	719364	M40	719424	M62	719548	V13	728745	M47
718776	M66	719365	M40	719425	M62	719549	V13	728746	M47
718777	M66	719366	M40	719426	M62	719550	V13	728747	M47
719267	M50	719367	M40	719427	M62	719551	V13	728748	M47
		719368	M40	719428	M62	719552	V13	728749	M47



Call the Velvac Sales Team: **800.783.8871** [sales@velvac.com](mailto:sales@velvac.com)

PART NO.	PAGE	PART NO.	PAGE	PART NO.	PAGE	PART NO.	PAGE	PART NO.	PAGE
728750	M47	747866	V7	V084143112	M56	V134271009	M72	V154003110	M100
728751	M47	747867	V7	V084143112	M57	V134271009	M9	V154003110	M79
728752	M47	747894	V7	V084143112	M58	V134281011	M103	V154003110	M85
728753	M47	747901	M129	V084200101	M86	V134281011	M104	V154003110	M91
728754	M47	748029	M131	V084270006	M109	V134281011	M120	V154003117	M100
728755	M47	748215	M130	V084270006	M118	V134281011	M17	V154003117	M79
728756	M47	748216	M30	V084270006	M120	V134281011	M36	V154003117	M85
728757	M47	748269	M130	V084270006	M123	V134281011	M70	V154003117	M91
728758	M47	748304	M129	V084270006	M34	V134281011	M82	V154004001	M100
728759	M47	748416	M131	V084270006	M36	V134281011	M94	V154004001	M79
728766	M47	757015	M131	V084270006	M72	V134281015	M103	V154004001	M85
728767	M47	757016	M131	V084270006	M75	V134281015	M104	V154004001	M91
728768	M47	790563	V7	V084270006	M9	V134281015	M109	V154004002	M100
728769	M47	790564	V7	V084380005	M83	V134281015	M114	V154004002	M79
728770	M47	790576	V7	V084803997	M10	V134281015	M118	V154004002	M85
728771	M47	790605	V7	V084803997	M105	V134281015	M120	V154004002	M91
728772	M47	790626	V16	V084803997	M110	V134281015	M123	V154148001	M55
728773	M47	790627	V16	V093841100	M52	V134281015	M17	V154148001	M56
728774	M47	790628	V16	V094002590	M100	V134281015	M34	V154148001	M57
728775	M47	790629	V16	V094002590	M79	V134281015	M36	V154148002	M55
728776	M47	790631	V16	V094002590	M85	V134281015	M70	V154148002	M56
728777	M47	790632	V16	V094002590	M91	V134281015	M75	V154148002	M57
728778	M47	790633	V16	V094252591	M100	V134281015	M82	V154148002	M58
728779	M47	790634	V16	V094252591	M79	V134281015	M94	V154158001	M55
728780	M47	790635	V16	V094252591	M85	V134580001	M14	V154158001	M56
730104	M20	V083200233	M107	V094252591	M91	V144580001	M14	V154158001	M57
730105	M20	V083200233	M109	V113870510B	M107	V153832000	M7	V154158001	M58
730122	M20	V083200233	M116	V113870510B	M112	V153832003	M53	V154158002	M55
730126	M20	V083200233	M118	V113870510B	M116	V153832003	M7	V154158002	M56
730195	M20	V083200233	M120	V113870510B	M16	V153832107	M106	V154158002	M57
730201	M20	V083200233	M33	V114272001	M109	V153832107	M111	V154158002	M58
730202	M20	V083200233	M75	V114272001	M114	V153832107	M115	V154270010	M123
730209	M20	V083840200	M52	V114272001	M118	V153832107	M53	V154270010	M72
730210	M20	V083841300	M127	V114272001	M120	V153832107	M7	V154270010	M9
730212	M20	V083841400	M127	V114272001	M123	V153882117	M107	V154270011	M108
745137	V7	V084000100	M100	V114272001	M33	V153882117	M112	V154270011	M113
745138	V7	V084000100	M79	V114272001	M71	V153882117	M116	V154270011	M117
745139	V10	V084002002	M100	V114272001	M8	V153882117	M15	V154270011	M120
745140	V10	V084002002	M79	V115490001	M10	V153882117	M16	V154270011	M123
745142	V7	V084010001	M127	V134271000	M120	V153882117	M54	V154270011	M33
745241	V11	V084010001	M57	V134271000	M36	V153882117	M83	V154270011	M35
745243	V7	V084022051	M112	V134271000	M72	V153882120	M103	V154270011	M72
745244	V7	V084022051	M114	V134271000	M9	V153882120	M104	V154270011	M74
745245	V7	V084090001	M107	V134271001	M72	V153882120	M16	V154270011	M9
745252	V7	V084090001	M112	V134271001	M9	V153882120	M54	V154280001	M103
747070	M130	V084090001	M116	V134271008	M109	V153882120	M82	V154280001	M104
747072	M130	V084090001	M54	V134271008	M114	V153882120	M94	V154280001	M123
747386	M2	V084090001	M7	V134271008	M118	V153882210	M16	V154280001	M17
747387	M2	V084090002	M107	V134271008	M120	V153882210	M54	V154280001	M70
747451	M2	V084090002	M112	V134271008	M123	V153882213	M15	V154280001	M82
747524	M129	V084090002	M116	V134271008	M36	V153882213	M16	V154280001	M94
747551	M129	V084090002	M54	V134271008	M72	V153882213	M54	V154280002	M109
747632	M129	V084090002	M7	V134271008	M74	V154003100	M100	V154280002	M114
747633	M129	V084142400	M127	V134271008	M9	V154003100	M79	V154280002	M118
747850	V7	V084142400	M57	V134271009	M109	V154003100	M85	V154280002	M120
747855	M129	V084143012	M55	V134271009	M114	V154003100	M91	V154280002	M17
747856	M129	V084143012	M56	V134271009	M118	V154003107	M100	V154280002	M36
747863	M129	V084143012	M57	V134271009	M120	V154003107	M79	V154280002	M75
747864	V7	V084143012	M58	V134271009	M123	V154003107	M85	V154280003	M109
747865	V7	V084143112	M55	V134271009	M34	V154003107	M91	V154280003	M118

## PARTS INDEX

PART NO.	PAGE	PART NO.	PAGE	PART NO.	PAGE	PART NO.	PAGE	PART NO.	PAGE
V154280003	M120	V514270016	M122	V514380013	M87	V564281013	M103	V584004030	M78
V154280003	M123	V514270016	M35	V514380014	M6	V564281013	M104	V584004030	M84
V154280003	M17	V514270016	M74	V514380014	M87	V564281013	M123	V584004030	M90
V154280003	M34	V514270016	M8	V514384543	M83	V564281013	M17	V584004030	M99
V154280003	M75	V514270017	M108	V514384544	M83	V564281013	M82	V584004032	M78
V154382117	M6	V514270017	M113	V515492110	M10	V564281013	M94	V584004032	M84
V154382117	M83	V514270017	M117	V515492210	M10	V564281014	M109	V584004032	M90
V154382117	M87	V514270017	M119	V515492230	M10	V564281014	M114	V584004032	M99
V154580003	M14	V514270017	M122	V562601127	M14	V564281014	M118	V584004033	M76
V155492110	M10	V514270017	M33	V562601127	M73	V564281014	M120	V584004033	M88
V155492121	M10	V514270017	M8	V563600160	M100	V564281014	M17	V584004033	M96
V155492150	M10	V514270018	M108	V563600160	M102	V564281014	M36	V584004034	M76
V155492151	M10	V514270018	M113	V563600160	M79	V564281014	M75	V584004034	M88
V404055700	M77	V514270018	M117	V563600160	M81	V564281015	M109	V584004034	M96
V404055700	M89	V514270018	M119	V563600160	M85	V564281015	M118	V584004046	M76
V404055700	M97	V514270018	M122	V563600160	M89	V564281015	M120	V584004046	M88
V404055800	M77	V514270018	M33	V563600160	M91	V564281015	M123	V584004046	M96
V404055800	M89	V514270018	M8	V563600160	M93	V564281015	M17	V584004048	M76
V404055800	M97	V514270019	M122	V563600160	M97	V564281015	M34	V584004048	M88
V404065204	M77	V514270019	M8	V563600160	M77	V564281015	M75	V584004048	M96
V404065204	M89	V514270103	M71	V563600260	M100	V564450350	M27	V584004501	M78
V404065204	M97	V514270103	M8	V563600260	M102	V564450350	M60	V584004501	M99
V404065304	M77	V514270104	M71	V563600260	M79	V564451101	M87	V584004502	M78
V404065304	M89	V514270104	M8	V563600260	M81	V584004001	M76	V584004502	M99
V404065304	M97	V514270121	M119	V563600260	M83	V584004001	M88	V584004504	M78
V514080002	M48	V514270121	M35	V563600260	M85	V584004001	M96	V584004504	M99
V514080002	M98	V514270121	M8	V563600260	M89	V584004001	M98	V584004505	M78
V514090028	M106	V514270122	M119	V563600260	M91	V584004002	M76	V584004505	M99
V514090028	M111	V514270122	M35	V563600260	M93	V584004002	M88	V584004506	M78
V514090028	M115	V514270122	M8	V563600260	M97	V584004002	M96	V584004506	M99
V514090029	M106	V514271005	M71	V563600260	M77	V584004002	M98	V584004509	M78
V514090029	M111	V514271005	M8	V563882208	M103	V584004004	M76	V584004509	M99
V514090029	M115	V514271006	M71	V563882208	M104	V584004004	M88	V584004513	M78
V514270001	M71	V514271006	M8	V563882208	M15	V584004004	M96	V584004513	M99
V514270001	M8	V514271007	M71	V563882208	M82	V584004005	M76	V584004517	M78
V514270002	M71	V514271007	M8	V563882208	M94	V584004005	M88	V584004517	M84
V514270002	M8	V514271008	M71	V563882218	M15	V584004005	M96	V584004517	M90
V514270003	M71	V514271008	M8	V563882218	M83	V584004006	M76	V584004517	M99
V514270003	M8	V514271107	M71	V564080002	M48	V584004006	M88	V584004518	M78
V514270004	M71	V514271107	M8	V564080002	M98	V584004006	M96	V584004518	M84
V514270004	M8	V514271108	M71	V564090013	M103	V584004021	M84	V584004518	M90
V514270013	M71	V514271108	M8	V564090013	M104	V584004021	M90	V584004518	M99
V514270013	M8	V514380001	M6	V564090013	M82	V584004025	M78	V584004520	M78
V514270014	M71	V514380003	M6	V564090013	M94	V584004025	M84	V584004520	M84
V514270014	M8	V514380004	M6	V564090025	M107	V584004025	M90	V584004520	M90
V514270015	M108	V514380005	M6	V564090025	M112	V584004025	M99	V584004520	M99
V514270015	M113	V514380005	M87	V564090025	M116	V584004026	M78	V584004521	M78
V514270015	M117	V514380006	M6	V564281001	M103	V584004026	M84	V584004521	M84
V514270015	M119	V514380006	M87	V564281001	M104	V584004026	M90	V584004521	M90
V514270015	M122	V514380007	M6	V564281001	M17	V584004026	M99	V584004521	M99
V514270015	M35	V514380007	M87	V564281001	M70	V584004028	M78	V584004522	M78
V514270015	M74	V514380008	M6	V564281001	M82	V584004028	M84	V584004522	M84
V514270015	M8	V514380008	M87	V564281001	M94	V584004028	M90	V584004522	M90
V514270016	M108	V514380011	M6	V564281002	M120	V584004028	M99	V584004522	M99
V514270016	M113	V514380011	M87	V564281002	M17	V584004029	M78	V584004524	M78
V514270016	M117	V514380012	M6	V564281002	M36	V584004029	M84	V584004524	M84
V514270016	M119	V514380012	M87	V564281005	M17	V584004029	M90	V584004524	M90
		V514380013	M6	V564281005	M70	V584004029	M99	V584004524	M99



Call the Velvac Sales Team: **800.783.8871** [sales@velvac.com](mailto:sales@velvac.com)

PART NO.	PAGE	PART NO.	PAGE	PART NO.	PAGE	PART NO.	PAGE	PART NO.	PAGE
V584004525	M84	V584049311	M104	V584660017	M80	V613871900	M127	V614090033	M7
V584004525	M90	V584049312	M104	V584660017	M92	V613871900	M127	V614090034	M16
V584004526	M78	V584070100	M111	V584660018	M101	V613871900	M52	V614090034	M54
V584004526	M84	V584070100	M113	V584660018	M80	V613871900	M53	V614090035	M16
V584004526	M90	V584070100	M115	V584660018	M92	V613871900	M55	V614090035	M54
V584004526	M99	V584070300	M106	V584660019	M101	V613871900	M57	V614210001	M6
V584004528	M78	V584070300	M108	V584660019	M80	V613871900	M58	V614210001	M87
V584004528	M84	V584070310	M115	V584660019	M92	V613871998	M107	V614250010	M85
V584004528	M90	V584070310	M117	V584660020	M101	V613871998	M112	V614250010	M91
V584004528	M99	V584070310	M119	V584660020	M80	V613871998	M116	V614270002	M72
V584004529	M84	V584070310	M74	V584660020	M92	V614000010	M10	V614270002	M9
V584004529	M90	V584070312	M119	V584660023	M101	V614000010	M100	V614270003	M72
V584004530	M78	V584070320	M115	V584660023	M80	V614000010	M109	V614270003	M9
V584004530	M84	V584070330	M35	V584660023	M92	V614000010	M114	V614270004	M120
V584004530	M90	V584070340	M35	V584660102	M101	V614000010	M118	V614270004	M72
V584004530	M99	V584070500	M117	V584660102	M80	V614000010	M120	V614270004	M9
V584004532	M78	V584070500	M119	V584660102	M92	V614000010	M123	V614270005	M120
V584004532	M84	V584070500	M33	V584660104	M101	V614000010	M14	V614270005	M72
V584004532	M90	V584071300	M122	V584660104	M80	V614000010	M17	V614270005	M9
V584004532	M99	V584250541	M84	V584660104	M92	V614000010	M33	V614270006	M72
V584004535	M100	V584250541	M90	V584660106	M101	V614000010	M70	V614270006	M9
V584004535	M79	V584250542	M84	V584660106	M80	V614000010	M75	V614271007	M109
V584004536	M100	V584250542	M90	V584660106	M92	V614000010	M79	V614271007	M114
V584004536	M79	V584250544	M84	V584660108	M101	V614000010	M8	V614271007	M118
V584004624	M84	V584250544	M90	V584660108	M80	V614000010	M71	V614271007	M120
V584004624	M90	V584250554	M84	V584660108	M92	V614080001	M48	V614271007	M123
V584004630	M84	V584250554	M90	V584660110	M101	V614080002	M48	V614271007	M34
V584004630	M90	V584250574	M84	V584660110	M80	V614090017	M16	V614271007	M72
V584005009	M76	V584250574	M90	V584660110	M92	V614090017	M54	V614271007	M9
V584005009	M88	V584660001	M101	V584660118	M101	V614090018	M16	V614280008	M103
V584005009	M96	V584660001	M80	V584660118	M80	V614090018	M54	V614280008	M104
V584005010	M76	V584660001	M92	V584660118	M92	V614090019	M16	V614280008	M123
V584005010	M88	V584660002	M101	V584660120	M101	V614090019	M54	V614280008	M17
V584005010	M96	V584660002	M80	V584660120	M80	V614090020	M16	V614280008	M70
V584005012	M76	V584660002	M92	V584660120	M92	V614090020	M54	V614280008	M82
V584005012	M88	V584660003	M101	V593601152	M105	V614090021	M53	V614280008	M94
V584005012	M96	V584660003	M80	V593601152	M19	V614090021	M7	V614330001	M56
V584005013	M76	V584660003	M92	V593601152	M59	V614090022	M53	V614380005	M83
V584005013	M88	V584660004	M101	V593601428	M59	V614090022	M7	V614610002	M32
V584005013	M96	V584660004	M80	V593603121	M125	V614090023	M53	V614610003	M32
V584005014	M76	V584660004	M92	V593605228	M105	V614090023	M7	V614660001	M102
V584005014	M88	V584660005	M101	V593605228	M19	V614090024	M53	V614660001	M81
V584005014	M96	V584660005	M80	V593605228	M59	V614090024	M7	V614660001	M93
V584005016	M76	V584660005	M92	V594121161	M60	V614090025	M53	V614660002	M102
V584005016	M88	V584660006	M101	V594121171	M126	V614090025	M7	V614660002	M81
V584005016	M96	V584660006	M80	V594121261	M60	V614090026	M53	V614660002	M93
V584049001	M94	V584660006	M92	V594121461	M60	V614090026	M7	V614660003	M102
V584049002	M94	V584660007	M101	V594450100	M27	V614090027	M53	V614660003	M81
V584049011	M94	V584660007	M80	V594450100	M60	V614090027	M7	V614660003	M93
V584049012	M94	V584660007	M92	V624059999	M98	V614090028	M53	V614660004	M102
V584049101	M103	V584660008	M101	V613600001	M105	V614090028	M7	V614660004	M81
V584049102	M103	V584660008	M80	V613600001	M19	V614090029	M53	V614660004	M93
V584049111	M103	V584660008	M92	V613600001	M59	V614090029	M7	V614660005	M102
V584049112	M103	V584660009	M101	V613600002	M59	V614090030	M53	V614660005	M81
V584049201	M82	V584660009	M80	V613720112	M125	V614090030	M7	V614660005	M93
V584049202	M82	V584660009	M92	V613724110	M125	V614090031	M53	V614660006	M102
V584049211	M82	V584660010	M101	V613846012	M52	V614090031	M7	V614660006	M81
V584049212	M82	V584660010	M80	V613846022	M52	V614090032	M53	V614660006	M93
V584049301	M104	V584660010	M92	V613871900	M125	V614090032	M7	V614660007	M102
V584049302	M104	V584660017	M101	V613871900	M126	V614090033	M53	V614660007	M81



## PARTS INDEX

**MIRRORS** M

**VISION SYTEMS** V

**HOSE SUPPORT** H

**AIR PRODUCTS** A

**ELECTRICAL PRODUCTS** E

**FITTINGS & HARDWARE** FH

**FUEL PRODUCTS** F

**BACK-UP CAMERAS** B

**ACCESSORIES** AC

**RETAIL MERCHANDISING** R

### THE VELVAC SECTIONAL CATALOG

To make finding the part you need easier, all products have been numbered sequentially and listed with their sectional page reference number. For the most up-to-date listing of products, please visit our online catalog at: [velvac.com](http://velvac.com)



PART NO.	PAGE	PART NO.	PAGE
V614660007	M93	V614730023	M127
V614660008	M102	V624059999	M103
V614660008	M81	V624059999	M104
V614660008	M93	V624059999	M107
V614660009	M102	V624059999	M112
V614660009	M81	V624059999	M116
V614660009	M93	V624059999	M16
V614660010	M102	V624059999	M48
V614660010	M81	V624059999	M53
V614660010	M93	V624059999	M55
V614660011	M102	V624059999	M56
V614660011	M81	V624059999	M57
V614660011	M93	V624059999	M58
V614720001	M126	V624059999	M7
V614720004	M126	V624059999	M77
V614720004	M127	V624059999	M82
V614720005	M126	V624059999	M89
V614720005	M127	V624059999	M94
		V624059999	M97

PART NO.	PAGE
W15	AC2
W16	AC2
W18	AC2
W20	AC2
W22	AC2
W24	AC2
W26	AC2
W28	AC2
WN14	AC2
WN15	AC2

- Founded in 1934
- Leading supplier of heavy truck aftermarket products
- TS 16949 & ISO 14001 certified



New Berlin headquarters



Reynosa facility



Call the Velvac Sales Team: **800.783.8871** [sales@velvac.com](mailto:sales@velvac.com)



