

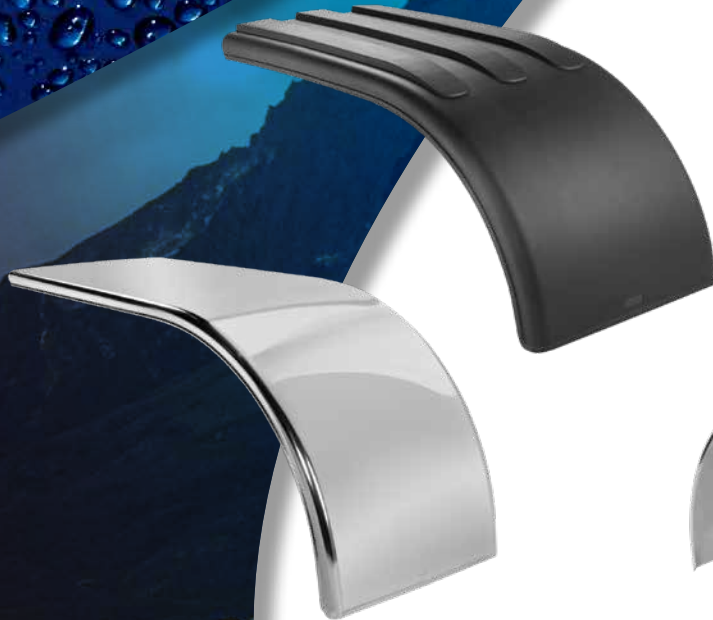

NU-LINE[®]

Protecting Your Truck
For More Than 35 Years



Toll Free: 866-837-2082
www.nuline.ca
sales@nuline.ca



 A Marmon Highway Technologies[®]/Berkshire Hathaway Company

Contents

	Poly Fenders	
	◆ Single Axle/Full Tandem/ 3	Half Tandem
	◆ Quarter Fender/Super Single 4	
	◆ Poly Mounting Kits 4	
	Quarter Fenders	
	◆ Quarter fenders 5	
	Half Tandem Fenders	
	◆ Half tandem fenders 6	
	◆ Half tandem mounting kits 7	
	Single Axle Fenders	
	◆ Single axle fenders 8-9	
	◆ Single axle mounting kits 9	
	Full Tandem Fenders	
	◆ Full tandem fenders 10	
	◆ Full tandem mounting kits 11	



Tanker Fenders

- ◆ Single axle/full and half tandem 12-13



ACP Aluminum Checker Plate/Super Single Fenders

- ◆ Half tandem/full tandem/ 14
- single axle/super single fenders



Fender Mounting Components

- ◆ Mounting components 15
- ◆ Centre/rear brackets 16



Mud Flap Hangers, Anti-Sail Brackets, Mud & Deck Plates

- ◆ Hangers 17-18
- ◆ Light bars & panels 17
- ◆ Air Pass mud flaps 18
- ◆ Deck Plates 18



New Products 19

- ◆ **NEW** Side Guards 19
- ◆ **NEW** AWAYWASH 19

New Products

Side Guards



Lifetime Warranty*

- ◆ Side Guards provide an additional protection barrier in the event of a side collision.

Pair Part #: **NSG5-KIT**
 Single Part #: **NSG5-1**
 Other models see page 19



For information scan or go to: nuline.ca
 Search "Side Guards"

NEW Page 19

AWAYWASH



Lifetime Warranty*

- ◆ AWAYWASH is the first on-board polyethylene system for ready-mix concrete truck chute washout. This patented design allows to wash the chute in compliance with environmental requirements while avoiding risks of contamination and penalties/fines. The product is light, sturdy and easy to maintain as concrete does not adhere to it.



For information scan or go to: nuline.ca
 Search "awaywash"

NEW Page 19

For sales enquiries email:
sales@nuline.ca

Helpful Information

- | | |
|------------------------|--------------------------|
| SS = Stainless | SRU = Stainless ribs up |
| A = Aluminum | NR = No ribs |
| G = Galvanized | 16 ga. = .057" typically |
| PX = Poly | 18 ga. = .048" typically |
| ARU = Aluminum ribs up | 14 ga = .070" typically |

Poly Single Axle Fenders



- ◆ Long lasting high density polyethylene construction
- ◆ Corrosion, wear and UV resistant
- ◆ Lightweight
- ◆ Easy to clean and maintain



Pair Part #: **NF180PX**
Single Part #: **NF180PX-1**

- ◆ Black poly fender(s)
- ◆ 76" overall length
- ◆ 24" width
- ◆ Weight: 21 lbs (pair)
- ◆ See colour choices below

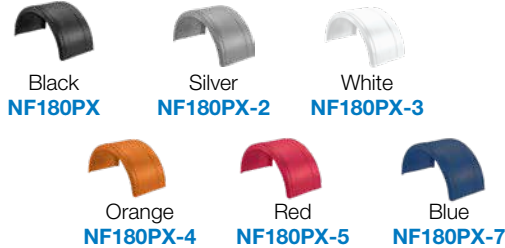
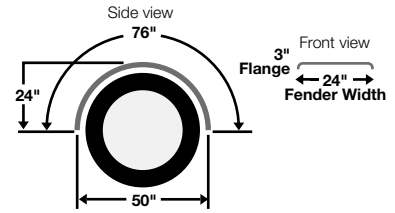

See Poly Video:
Scan or go to nuline.ca ...
choose "Gallery" ...
choose "Videos"

Pair Part #: **NF18026PX**
Single Part #: **NF18026PX-1**

- ◆ Black poly fender(s)
- ◆ 79" overall length
- ◆ 26" width (2" wider than NF180PX)
- ◆ Weight: 21 lbs (pair)

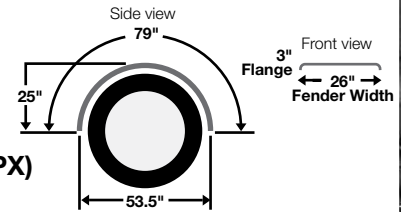

Pair Part #: **NF166PX**
Single Part #: **NF166PX-1**

- ◆ Black poly fender(s)
- ◆ 64" overall length
- ◆ 24" width
- ◆ Weight: 19 lbs (pair)

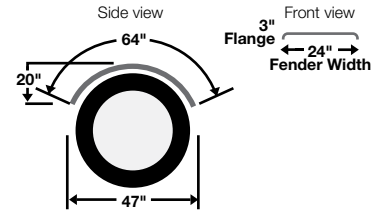

Black Poly Full Tandem Fenders



Pair Part #: **NF13254PX**
Single Part #: **NF13254PX-1**

- ◆ Black poly fender(s)
- ◆ 131" overall length
- ◆ 26" width
- ◆ Weight: 48 lbs (pair)

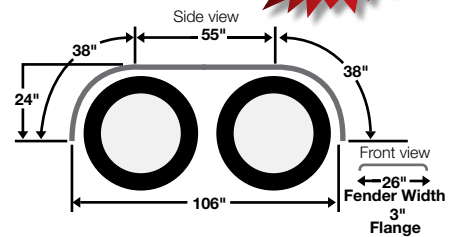

Black Poly Half Tandem Fenders



Available in multiple colours;
10 pair minimum order.
8 week lead time.

Pair Part #: **NF66PX**
Single Part #: **NF66PX-1**

- ◆ Black poly fender(s)
- ◆ 66" overall length
- ◆ 26" width
- ◆ Weight: 22 lbs (pair)

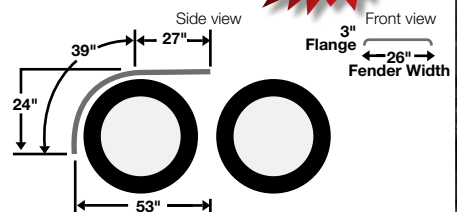

* All Nu-Line Poly fenders feature a limited lifetime product warranty. Warranty is non-transferable and applies to installation on one vehicle. Contact Nu-Line for warranty details.

Poly Quarter Fender



Pair Part #: **N1900-KIT**

Driver Side: **N1900-L**

Passenger Side: **N1900-R**

- ◆ Two polyethylene fenders
- ◆ Two top flaps with hardware
- ◆ Two black clamps
- ◆ 24" length
- ◆ Weight: 20 lbs (pair)

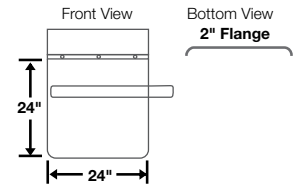

Poly Mounting Kits

Recommended single axle and full tandem mounting kit:

N180PMK



Recommended:

Order **N230** center mounts separately. Need left hand and right hand models. See page 16 for centre mount information.

Recommended half tandem mounting kit:

N66PMKXB



Recommended:

Order **N230** center mounts separately. Need Left hand and right hand. See page 16 for centre mount information.

Poly Super Single Fenders



Pair Part #: **NF180PX-19**

Single Part #: **NF180PX-19-1**

- ◆ Super single axle poly fender(s)
- ◆ 76" overall length
- ◆ 19" width
- ◆ Weight: 16 lbs (pair)

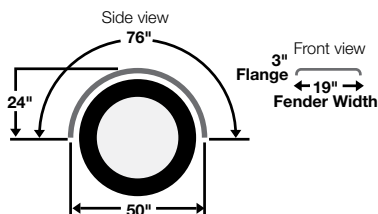

Pair Part #: **NF66PX-19**

Single Part #: **NF66PX-19-1**

- ◆ Super single poly half tandem fender(s)
- ◆ 66" overall length
- ◆ 19" width
- ◆ Weight: 17 lbs (pair)

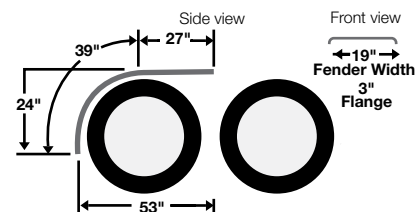

* All Nu-Line Poly fenders feature a limited lifetime product warranty. Warranty is non-transferable and applies to installation on one vehicle. Contact Nu-Line for warranty details.

Stainless Steel Quarter Fenders



Part #: N224-SS

- ◆ Two 18 gauge stainless steel fenders
- ◆ Two N200-SS7 mounting arms
- ◆ Two top flaps with hardware
- ◆ Two stainless steel clamps
- ◆ 24" length
- ◆ Weight: 35 lbs (pair)

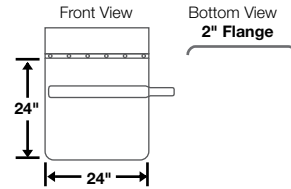

Part #: N224-SSB

- ◆ Two 18 gauge stainless steel fenders
- ◆ Two mounting pipes
- ◆ Six mounting braces
- ◆ Two top flaps with hardware
- ◆ Two stainless steel clamps
- ◆ 24" length
- ◆ Weight: 30 lbs (pair)

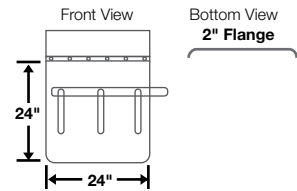

Part #: N227-SS

- ◆ Two 18 gauge stainless steel fenders
- ◆ Two N200-SS7 mounting arms
- ◆ Two top flaps with hardware
- ◆ Two stainless steel clamps
- ◆ 26" length
- ◆ Weight: 35 lbs (pair)

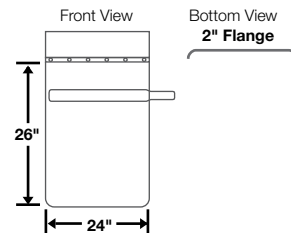

Part #: 1585-FB

- ◆ Two 18 gauge stainless steel fenders
- ◆ Two top flaps with hardware
- ◆ Two stainless steel clamps
- ◆ 22" length
- ◆ Weight: 32 lbs (pair)

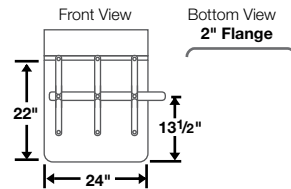

Part #: 1585-LM

- ◆ Two 18 gauge stainless steel fenders
- ◆ Two top flaps with hardware
- ◆ Two stainless steel clamps
- ◆ 22" length
- ◆ Weight: 29 lbs (pair)

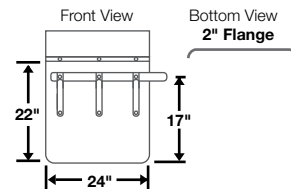

1000 Series



Also available:
 NF1060SSNRLF
 NF1066SSNRLF
 NF1080SSNR

Pair Part #: **NF1060SSNR**
 Single Part #: **NF1060SSNR-1**

- ◆ 16 gauge stainless steel fender(s)
- ◆ 60" overall length
- ◆ 24" width
- ◆ Weight: 52 lbs (pair)

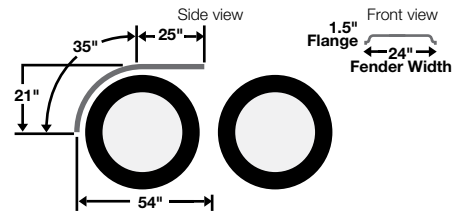

Pair Part #: **NF1066SSNR**
 Single Part #: **NF1066SSNR-1**

- ◆ 16 gauge stainless steel fender(s)
- ◆ 66" overall length
- ◆ 24" width
- ◆ Weight: 58 lbs (pair)

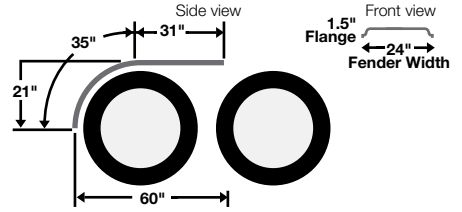

NF Series



Pair Part #: **NF60SS**
 Single Part #: **NF60SS-1**

- ◆ 16 gauge stainless steel fender(s)
- ◆ 60" overall length
- ◆ 24" width
- ◆ Weight: 52 lbs (pair)

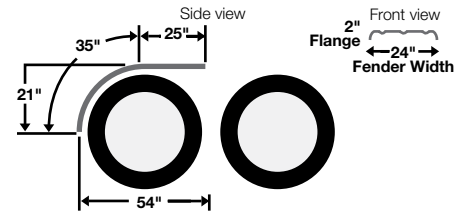

Pair Part #: **NF66SS**
 Single Part #: **NF66SS-1**

- ◆ 16 gauge stainless steel fender(s)
- ◆ 66" overall length
- ◆ 24" width
- ◆ Weight: 60 lbs (pair)

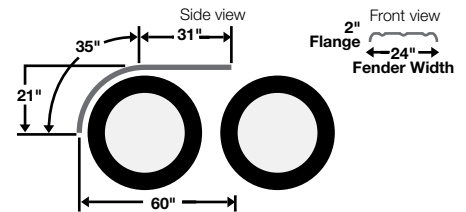

Pro Series



Pair Part #: **NF66SSNR**
 Single Part #: **NF66SSNR-1**

- ◆ 14 gauge stainless steel fender(s)
- ◆ 66" overall length
- ◆ 24" width
- ◆ Weight: 76 lbs (pair)

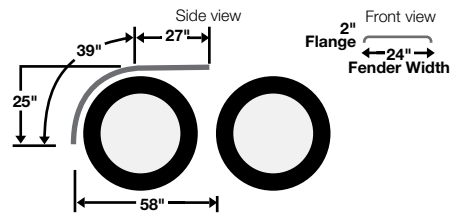

Use a mounting kit with heavy duty arms (N200-SS7HD)

N Series

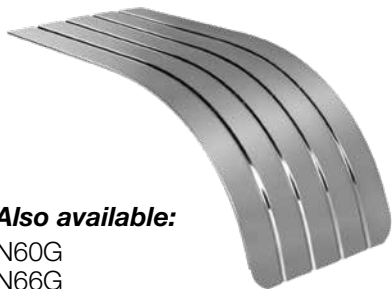

Also available:
 N60G
 N66G
 N80SS
 N80G
 N125SS
 N125G

Pair Part #: **N60SS**
 Single Part #: **N60SS-1**

- ◆ 18 gauge stainless steel fender(s)
- ◆ 60" overall length
- ◆ 24" width
- ◆ Weight: 44 lbs (pair)

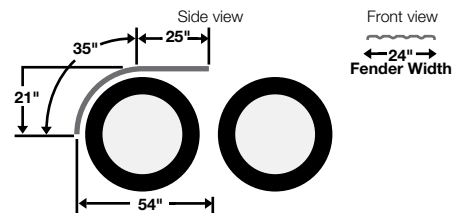

Pair Part #: **N66SS**
 Single Part #: **N66SS-1**

- ◆ 18 gauge stainless steel fender(s)
- ◆ 66" overall length
- ◆ 24" width
- ◆ Weight: 50 lbs (pair)

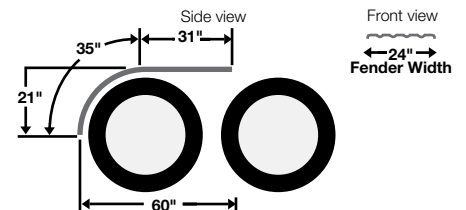

Half Tandem Fender Mounting Kit Options

(All kits mount one pair of fenders)

Part #: **N260SSMKXB**

Includes:

- 2 of N200-SS7
- 2 of N52
- 1 of N260SSHB

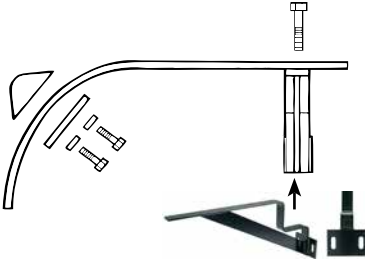

Order centre mounts separately on page 16.



Heavy duty version of this kit is: N260SSMKHDXB

Part #: **N260SSMK**

Includes:

- 2 of N200-SS7
- 2 of N230*
- 2 of N52
- 1 of N260SSHB

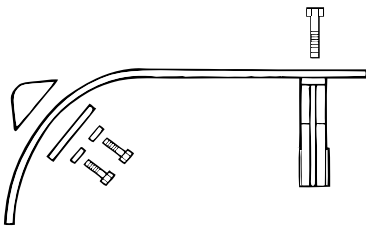

Part #: **N260SSMKUB**

Includes:

- 2 of N200-SS7
- 1 of N230PMRH
- 1 of N230PMLH
- 2 of N52
- 1 of N260SSHB

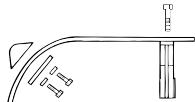

Part #: **N8060SSMK**

Includes:

- 1 of NC091-SS
- 2 of N230*
- 1 of N6080SSHB

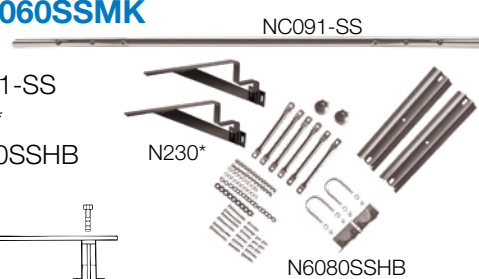
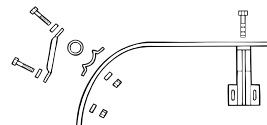

*N230 is standard, other options available on page 16.

Additional kits available (www.nuline.ca)

1000 Series



Pair Part #: **NF10166SSNR**

Single Part #: **NF10166SSNR-1**

- ◆ 16 gauge stainless steel fender(s)
- ◆ 66" overall length
- ◆ 24" width
- ◆ Weight: 60 lbs (pair)

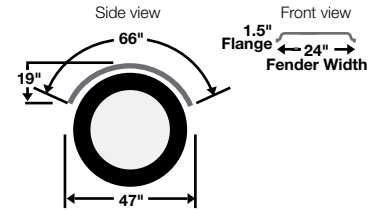

Pair Part #: **NF10180SSNR**

Single Part #: **NF10180SSNR-1**

- ◆ 16 gauge stainless steel fender(s)
- ◆ 80" overall length
- ◆ 24" width
- ◆ Weight: 70 lbs (pair)

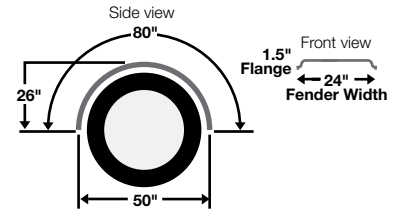

NF Series



Pair Part #: **NF155A**

Single Part #: **NF155A-1**

- ◆ .090" aluminum fender(s)
- ◆ 55" overall length
- ◆ 24" width
- ◆ Weight: 26 lbs (pair)

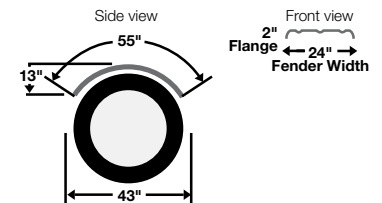

Pair Part #: **NF155SS**

Single Part #: **NF155SS-1**

- ◆ 16 gauge stainless steel fender(s)
- ◆ 55" overall length
- ◆ 24" width
- ◆ Weight: 48 lbs (pair)

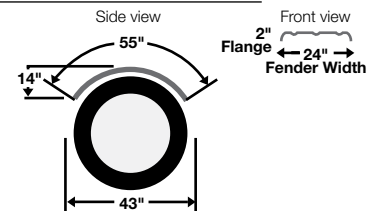

Pair Part #: **NF166A**

Single Part #: **NF166A-1**

- ◆ .090" aluminum fender(s)
- ◆ 66" overall length
- ◆ 24" width
- ◆ Weight: 32 lbs (pair)

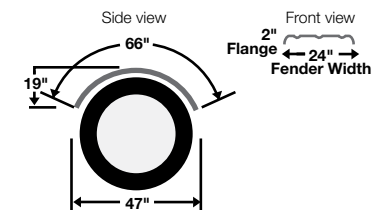

Also available:
NF166SS

Pair Part #: **NF180A**

Single Part #: **NF180A-1**

- ◆ .090" aluminum fender(s)
- ◆ 80" overall length
- ◆ 24" width
- ◆ Weight: 40 lbs (pair)

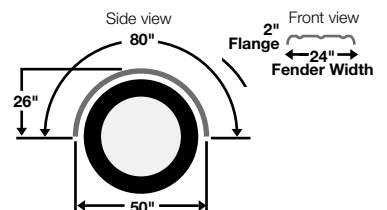

Pair Part #: **NF180SS**

Single Part #: **NF180SS-1**

- ◆ 16 gauge stainless steel fender(s)
- ◆ 80" overall length
- ◆ 24" width
- ◆ Weight: 70 lbs (pair)

Pro Series



Pair Part #: **NF166SSNR**

Single Part #: **NF166SSNR-1**

- ◆ 14 gauge stainless steel fender(s)
- ◆ 66" overall length
- ◆ 24" width
- ◆ Weight: 76 lbs (pair)

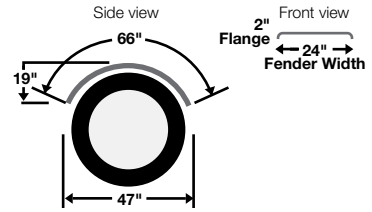

Pair Part #: **NF180SSNR**

Single Part #: **NF180SSNR-1**

- ◆ 14 gauge stainless steel fender(s)
- ◆ 80" overall length
- ◆ 24" width
- ◆ Weight: 92 lbs (pair)

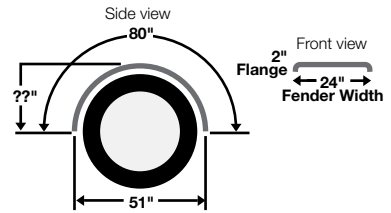

Use a mounting kit with heavy duty arms (N200-SS7HD)

N Series



Also available:

N180G
N155SS
N155G

Pair Part #: **N180SS**

Single Part #: **N180SS-1**

- ◆ 18 gauge stainless steel fender(s)
- ◆ 80" overall length
- ◆ 24" width
- ◆ Weight: 60 lbs (pair)

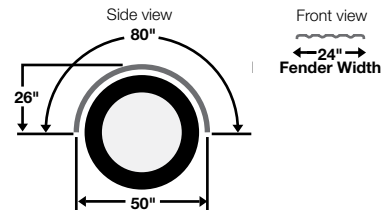

Single Axle Fender Mounting Kits

All kits mount one pair of fenders

Part #: **N2180SSMK**

Includes

- 4 of N200-SS7
- 4 of N52
- 1 of N2180SSHB

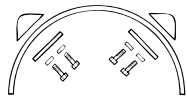

Heavy duty version of this kit is:
N2180SSMKHD

Part #: **N180GMK**

Includes

- 4 of N30
- 1 of N180GHB

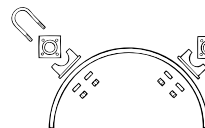
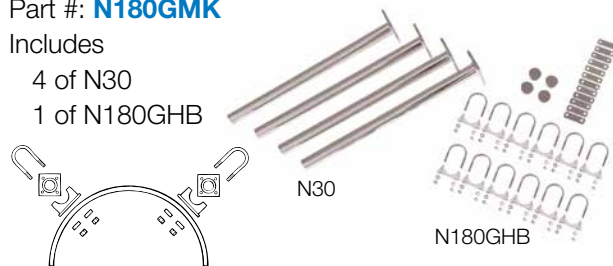

Part #: **N2180PMK**

Includes

- 4 of N200-SS7-BLK powder coated
- 4 of N52
- 1 of N2180SSHB

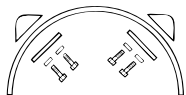

Part #: **N180GMK-PM**

Includes

- 4 of N40
- 1 of N180GHB

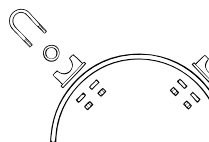
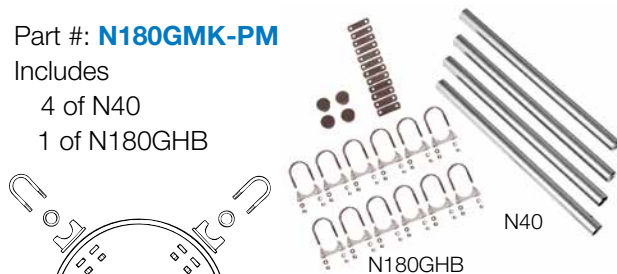

Additional kits available (www.nuline.ca)



1000 Series



Also available:
NF1012060SSNR
NF1012554SSNR

Pair Part #: **NF1012054SSNR**

Single Part #: **NF1012054SSNR-1**

- ◆ 16 gauge stainless steel fender(s)
- ◆ 120" overall length
- ◆ 24" width
- ◆ Weight: 106 lbs (pair)

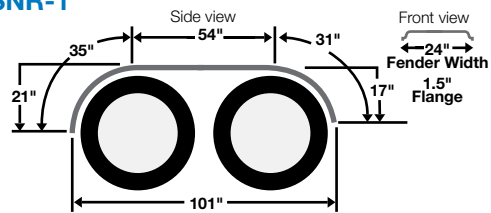

NF Series



Also available:
NF120A
NF120SS
NF126SS
NF12054A

Pair Part #: **NF12054SS**

Single Part #: **NF12054SS-1**

- ◆ 16 gauge stainless steel fender(s)
- ◆ 120" overall length
- ◆ 24" width
- ◆ Weight: 106 lbs (pair)

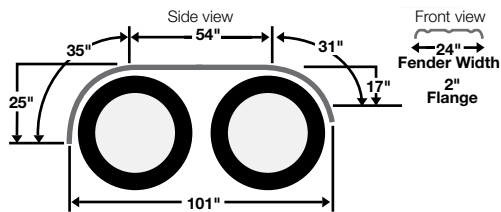

Pro Series



Also available:
NF142SSNR

Pair Part #: **NF13254SSNR**

Single Part #: **NF13254SSNR-1**

- ◆ 14 gauge stainless steel fender(s)
- ◆ 132" overall length
- ◆ 24" width
- ◆ Weight: 150 lbs (pair)

Use a mounting kit with heavy duty arms (N200-SS7HD)

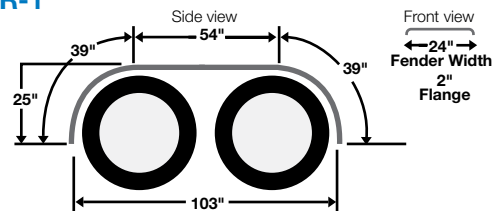

N Series



Also available:
N120SS
N120G
N12054G

Pair Part #: **N12054SS**

Single Part #: **N12054SS-1**

- ◆ 18 gauge stainless steel fender(s)
- ◆ 120" overall length
- ◆ 24" width
- ◆ Weight: 88 lbs (pair)

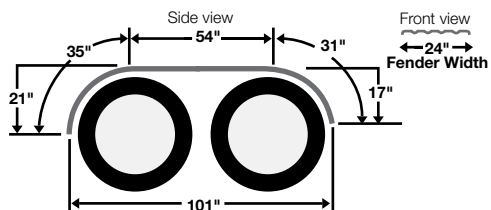

Full Tandem Mounting Kit Options

(All kits mount one pair of fenders)

Part #: N2120SSMKXB

Includes:

- 4 of N200-SS7
- 4 of N52
- 1 of N2120SSHB

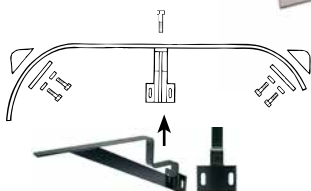

Heavy duty version of this kit is:
N2120SSMKHDXB

Order centre mounts separately on page 16

Part #: N2120SSMK

Includes:

- 4 of N200-SS7
- 4 of N52
- 2 of N230*
- 1 of N2120SSHB

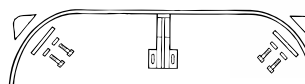

*N230 is standard, other options available on page 16.

Additional kits available (www.nuline.ca)

Download Flyers and Videos www.nuline.ca

Choose "Nu-Line" Menu and then choose "Literature".



Choose "Nu-Line" Menu and then choose "Videos".

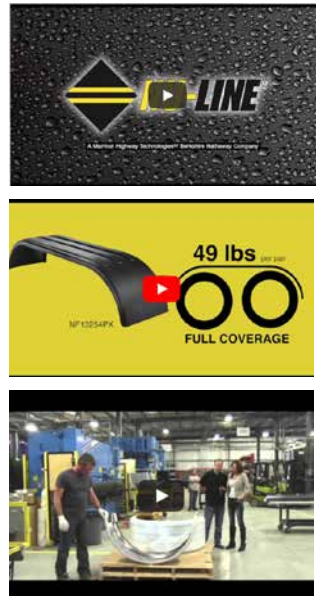

www.nuline.ca



Tanker Fenders

Full Tandem Flanged 3 Rib



- Pair Part #: **NF99A**
 Single Part #: **NF99A-1**
- ◆ .090" aluminum fender(s)
 - ◆ 108" overall length
 - ◆ 24" width
 - ◆ Weight: 52 lbs (pair)

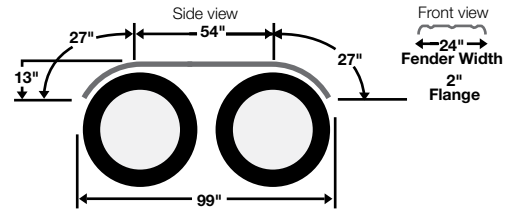

- Pair Part #: **NF96ARU**
 Single Part #: **NF96ARU-1**
- ◆ .090" aluminum fender(s)
 - ◆ **Ribs up** design
 - ◆ 107" overall length
 - ◆ 25" width
 - ◆ Weight: 52 lbs (pair)

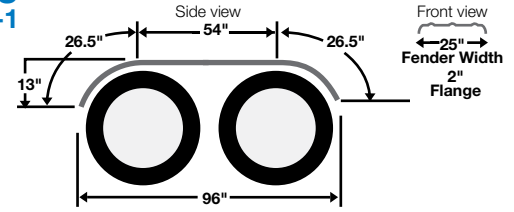

- Pair Part #: **NF99SS**
 Single Part #: **NF99SS-1**
- ◆ 16 gauge stainless steel fender(s)
 - ◆ 108" overall length
 - ◆ 24" width
 - ◆ Weight: 94 lbs (pair)

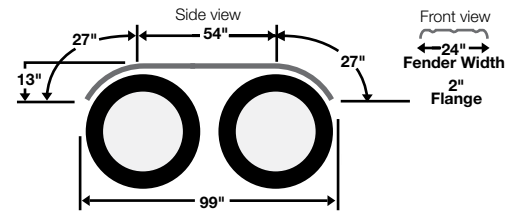

- Pair Part #: **NF96SSRU**
 Single Part #: **NF96SSRU-1**
- ◆ .090" stainless steel fender(s)
 - ◆ **Ribs up** design
 - ◆ 107" overall length
 - ◆ 25" width
 - ◆ Weight: 52 lbs (pair)

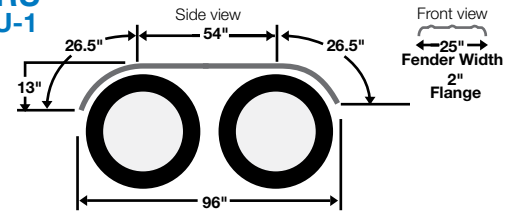

Half Tandem Flanged 3 Rib



- Pair Part #: **NF139A**
 Single Part #: **NF139A-1**
- ◆ .090" aluminum fender(s)
 - ◆ 144" overall length
 - ◆ 24" width
 - ◆ Weight: 68 lbs (pair)

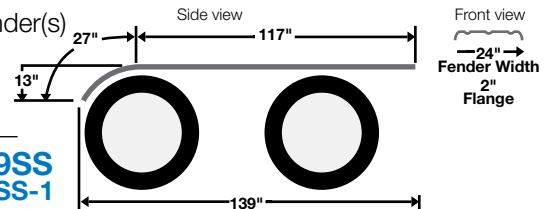

- Pair Part #: **NF139SS**
 Single Part #: **NF139SS-1**
- ◆ 16 gauge stainless steel fender(s)
 - ◆ 144" overall length
 - ◆ 24" width
 - ◆ Weight: 126 lbs (pair)



- Pair Part #: **NF139ARU**
 Single Part #: **NF139ARU-1**
- ◆ .090" aluminum fender(s)
 - ◆ **Ribs up** construction
 - ◆ 144" overall length
 - ◆ 25" width
 - ◆ Weight: 68 lbs (pair)

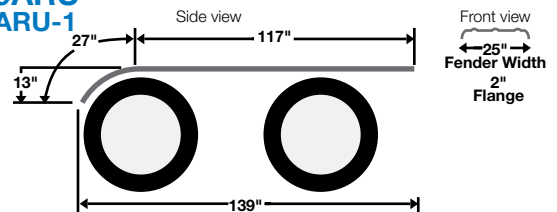

- Pair Part #: **NF139SSRU**
 Single Part #: **NF139SSRU-1**
- ◆ .090" stainless steel fender(s)
 - ◆ **Ribs up** construction
 - ◆ 144" overall length
 - ◆ 25" width
 - ◆ Weight: 68 lbs (pair)

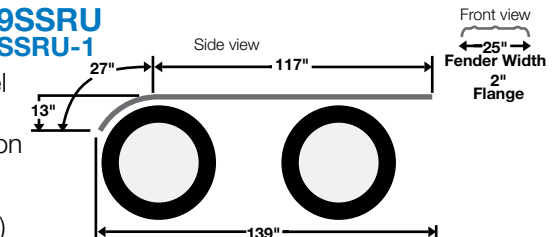

Tanker Fenders

Half Tandem Flanged 3 Rib



Pair Part #: **NF122A**
Single Part #: **NF122A-1**

- ◆ .090" aluminum fender(s)
- ◆ 125" overall length
- ◆ 24" width
- ◆ Weight: 60 lbs (pair)

Pair Part #: **NF122SS**
Single Part #: **NF122SS-1**

- ◆ 16 gauge stainless steel fender(s)
- ◆ 125" overall length
- ◆ 24" width
- ◆ Weight: 110 lbs (pair)

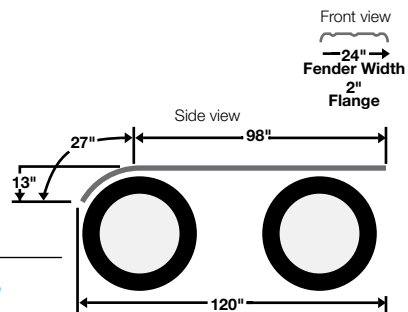

Pair Part #: **NF150A**
Single Part #: **NF150A-1**

- ◆ .090" tri-axle half tandem aluminum fender(s)
- ◆ 155" overall length
- ◆ 24" width
- ◆ Weight: 74 lbs (pair)

Pair Part #: **NF150SS**
Single Part #: **NF150SS-1**

- ◆ 16 gauge tri-axle half tandem stainless steel fender(s)
- ◆ 155" overall length
- ◆ 24" width
- ◆ Weight: 136 lbs (pair)

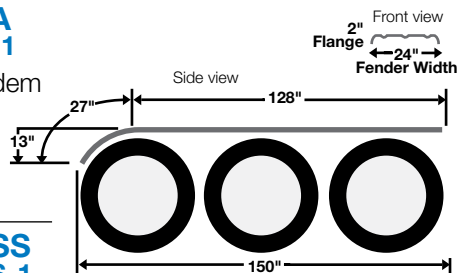

Also available:

- NF66A (Aluminum)
- NF80SS (Stainless Steel)
- NF125A (Aluminum)
- NF125SS (Stainless Steel)

Single Axle Flanged 3 Rib



Pair Part #: **NF166A**
Single Part #: **NF166A-1**

- ◆ .090" aluminum fender(s)
- ◆ 66" overall length
- ◆ 24" width
- ◆ Weight: 32 lbs (pair)

Pair Part #: **NF166SS**
Single Part #: **NF166SS-1**

- ◆ 16 gauge stainless steel fender(s)
- ◆ 66" overall length
- ◆ 24" width
- ◆ Weight: 60 lbs (pair)

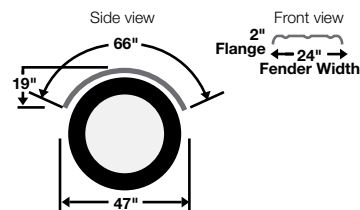

Also available:

- NF155SS
- NF160SS

Super Single Tanker Fenders



Pair Part #: **NF139A-19**
Single Part #: **NF139A-19-1**

- ◆ .090" aluminum fender(s)
- ◆ 144" overall length
- ◆ 24" width
- ◆ Weight: 55 lbs (pair)

Pair Part #: **NF99A-19**
Single Part #: **NF99A-19-1**

- ◆ .090" aluminum fender(s)
- ◆ 108" overall length
- ◆ 19" width
- ◆ Weight: 41 lbs (pair)

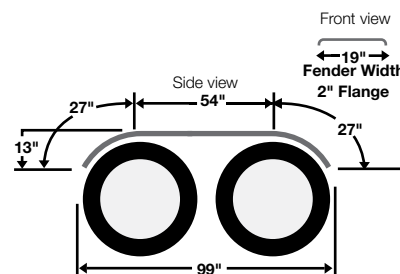
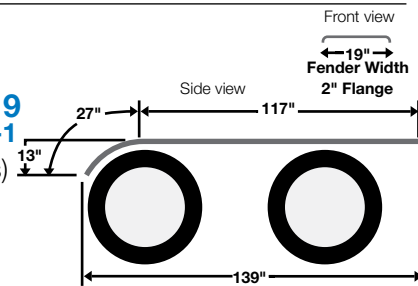

ACP Aluminum Checker Plate Fenders

Half Tandem

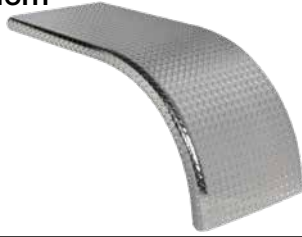

Pair Part #: **NF66ACP**

Single Part #: **NF66ACP-1**

- ◆ .100" aluminum fender(s)
- ◆ 66" overall length
- ◆ 24" width
- ◆ Weight: 38 lbs (pair)

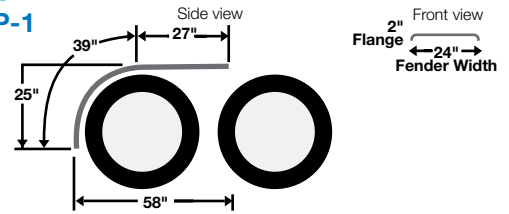

Full Tandem



Pair Part #: **NF12054ACP**

Single Part #: **NF12054ACP-1**

- ◆ .100" aluminum fender(s)
- ◆ 120" overall length
- ◆ 24" width
- ◆ Weight: 75 lbs (pair)

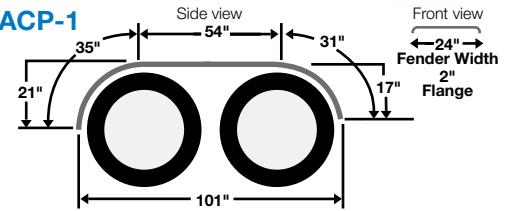

Single Axle

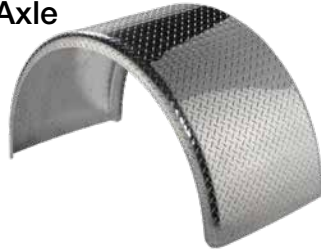

Pair Part #: **NF180ACP**

Single Part #: **NF180ACP-1**

- ◆ .100" aluminum fender(s)
- ◆ 80" overall length
- ◆ 24" width
- ◆ Weight: 44 lbs (pair)

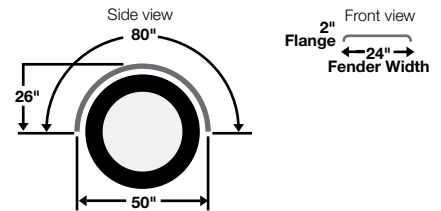

Super Single Fenders

Single Axle



Recommended mounting kit N218019SSMK

Pair Part #: **NF180SSNR19**

Single Part #: **NF180SSNR19-1**

- ◆ 16 gauge stainless steel fender(s)
- ◆ Smooth construction
- ◆ 80" overall length
- ◆ 19" width
- ◆ Weight: 45 lbs (pair)

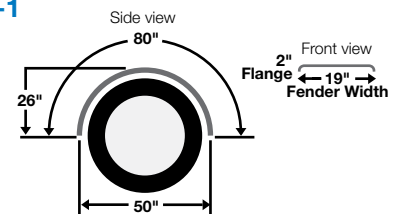

Half Tandem



Recommended mounting kit N26019SSMK

Pair Part #: **NF72SSNR19**

Single Part #: **NF72SSNR19-1**

- ◆ 16 gauge stainless steel fender(s)
- ◆ Smooth construction
- ◆ 72" overall length
- ◆ 19" width
- ◆ Weight: 64 lbs (pair)

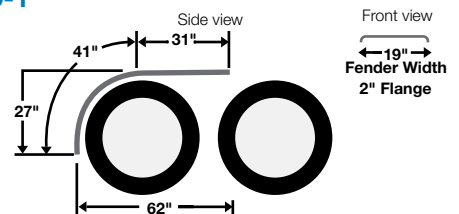

Fender Mounting Components

(Sold as single pieces)



Part #: **N200-SS7**

◆ 29" stainless steel side mount arm - 14 gauge

Part #: **N200-SS7HD**

◆ 29" heavy duty stainless steel side mount arm - 12 gauge



Part #: **N200-SS7-19**

◆ Stainless steel side mount arm for super single applications - 14 gauge



Part #: **N200SS7-BLK**

◆ 29" powder coated side mount arm - black - 14 gauge



Part #: **N52**

◆ Threaded 3/4" - 16 post mount - 7" length

Part #: **N8**

◆ Non-thread mount - Uses a bolt and nut 5/8" - 7" length



Part #: **N52-19**

◆ Threaded 3/4" - 16 post mount for super single applications - 10 1/2" length



Part #: **N40 (No Holes)**

◆ 30" threaded 3/4"-16 post mount - zinc

Part #: **N40-C (Holes)**

◆ 30" threaded 3/4"-16 post mount - chrome



Part #: **N728-SS**

◆ 29" side mount pipe stainless steel



Part #: **NC091 (No Holes)**

◆ 94" Pipe - zinc

Part #: **NC091-SS (Holes)**

◆ 94" pipe - stainless steel



Part #: **N30 (No Holes)**

◆ 30" Side Mount - zinc

Part #: **N30-C (No Holes)**

◆ 30" side mount - chrome



Part #: **N2125-SS**

◆ Stainless steel clamp with bolt and nut



Part #: **N123-8 BULK**

◆ 50 muffler clamps

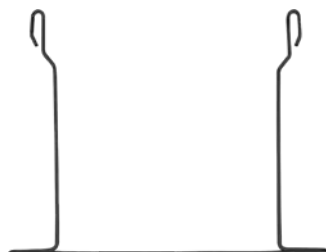

Anti-Sail Mud Flap Brackets

Part #: **N2620P**

◆ Painted anti-sail mud flap bracket

◆ Fits standard 24" wide mud flaps up to 1/2" thick

Part #: **N2620C**

◆ Chrome plated anti-sail mud flap bracket

◆ Fits standard 24" wide mud flaps up to 1/2" thick



Centre/Rear Mounting Brackets

(Sold as single piece)



Adjustable bracket for easy installation

- ◆ Makes fender installation easy
- ◆ Post mounts to truck frame with one bolt
- ◆ Takes up minimum space on truck frame
- ◆ 8" high with 27" to 30" length adjustment
- ◆ 360° swivel provides maximum flexibility when mounting to the truck frame
- ◆ Mounts many types of fenders
- ◆ All hardware included.



- 8" offset Part #: **N360**
- NEW** 4" offset Part #: **N360-4**
- NEW** 10" offset Part #: **N360-10**

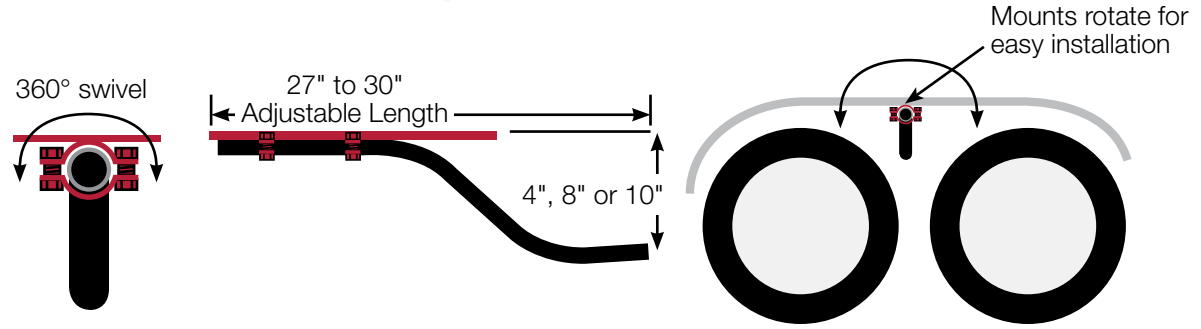

- Part #: **N230PMLH**
- ◆ Universal - left hand
 - ◆ Height 8¹/₂" - 11⁵/₈"
 - ◆ Single hole

- Part #: **N230PMRH**
- ◆ Universal - right hand
 - ◆ Height 8¹/₂" - 11⁵/₈"
 - ◆ Single hole



- Part #: **N230**
- ◆ Regular
 - ◆ Height 12³/₄"
 - ◆ Plate: 4" x 6"
 - ◆ Bolt centres: 4¹/₄"



- Part #: **N230-FL-LH**
- ◆ Left hand
 - ◆ Height 12¹/₂"
 - ◆ Slots in bar

- Part #: **N230-FL-RH**
- ◆ Right hand
 - ◆ Height 12¹/₂"
 - ◆ Slots in bar



- Part #: **N235-LH**
- ◆ Outboard - left hand
 - ◆ Height 7¹/₂"
 - ◆ Slot in bar

- Part #: **N235-RH**
- ◆ Outboard - right hand
 - ◆ Height 7¹/₂"
 - ◆ Slot in bar



- Part #: **N230-19L**
- ◆ Super single application - left hand
 - ◆ Height 8¹/₂" - 11⁵/₈"
 - ◆ Single hole

- Part #: **N230-19R**
- ◆ Super single application - right hand
 - ◆ Height 8¹/₂" - 11⁵/₈"
 - ◆ Single hole

Spring Loaded Mud Flap Hangers

(Mounting hardware included with all Mud Flap Hangers)

NF30 Series

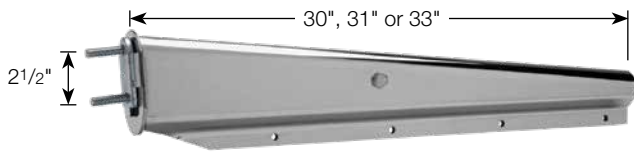

Pair Part #:	Description	length
NF30P	Painted	30"
NF30C	Chrome	30"
NF30SS	Stainless Steel	30"
NF31SS	Stainless Steel	31"
NF33SS	Stainless Steel	33"

NF37 Angled Series

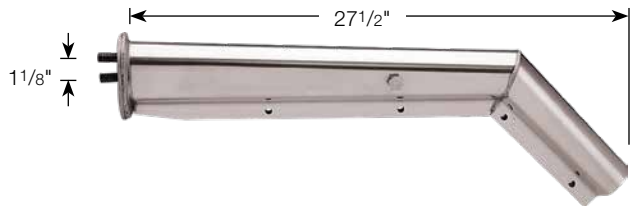

Pair Part #:	Description
NF37P	Painted
NF37C	Chrome
NF37SS	Stainless Steel

NF3345 Angled Series

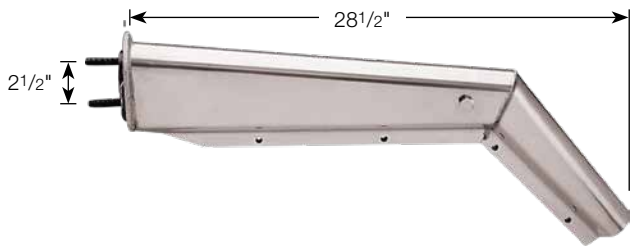

Pair Part #:	Description
NF3345P	Painted
NF3345C	Chrome
NF3345SS	Stainless Steel

NF27 Series

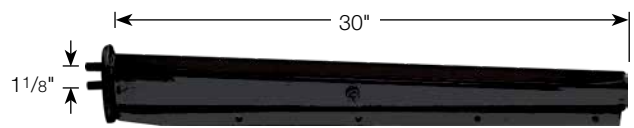

Pair Part #:	Description
NF27P	Painted
NF27C	Chrome
NF27SS	Stainless Steel

Light Bar & Centre Panel Spring Loaded

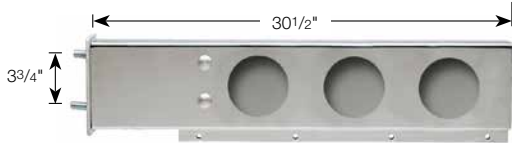

Lights not included

Part #:	Description
NL306SSNL	Stainless steel light bar pair
NL306SSNL-1RH	Stainless steel light bar right hand
NL306SSNL-1LH	Stainless steel light bar left hand

Flexible Mud Flap Reflector Strips

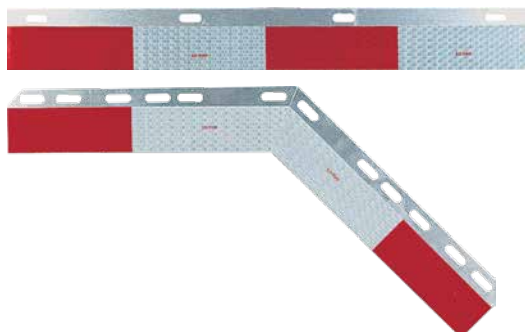

Pair Part #:	Description
NRS3000	Fits NF27, NF30, NF31, NF33, N23, N25, NL306
NRS3700	Fits NF37, NF3345, N33, N35



Flexible Mud Flap Hangers (Includes mounting hardware)

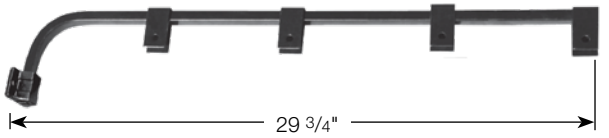

Pair Part #: **N25**
Description: Two spring hangers
N25-BARREL 40 spring hangers (no hardware)
N23-2BULK 40 mounting kits

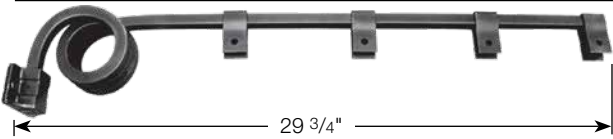

Pair Part #: **N23**
Description: Two coiled spring hangers

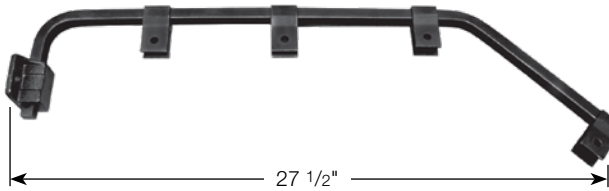

Pair Part #: **N35**
Description: Two angled spring hangers

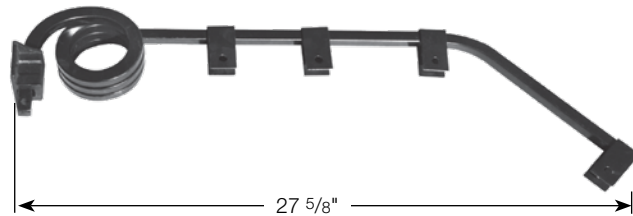

Pair Part #: **N33**
Description: Two angled
 Coiled spring hangers

Air Pass Mud Flaps

(Sold as single piece)



Imagine a flap with a Lifetime warranty* for normal wear and tear!



- Part #: **N2424APF**
24"x24" Air Pass mud flap
- Part #: **N2430APF**
24"x30" Air Pass mud flap
- Part #: **N2436APF**
24"x36" Air Pass mud flap

* Contact Nu-Line for warranty details.

- ◆ **Fuel Savings:** Using CFD (Computational Fluid Dynamics) testing on a trailer/tractor combination there was a 0.4% fuel savings with slotted mud flaps.
- ◆ **Weight Savings:** On a truck/trailer combination using 4 flaps you could expect at least an 8 lb savings over a 5 lb rubber flap.
- ◆ **Payback:** in approximately a year.
- ◆ **High Quality Materials:** High impact nylon suitable for winters (to -70°C). After gravelometer testing there was no cracking or fractures observed. Air Pass withstood gravel impacts that conventional poly flaps cannot.
- ◆ No need for anti-sail brackets.

Round Pattern Deck Plates



Part #:	Description	Nominal Thickness	Channel Depth	Standard Width	Length
N2433GR	Galvanized	.086"	1 1/2"	24"	33"
N3633GR				36"	

"J" hooks included

Diamond Pattern Deck Plates



Part #:	Description	Nominal Thickness	Channel Depth	Standard Width	Length
N1833GD	Galvanized	.075"	1 1/2"	18 3/4"	33"
N2433GD				24"	
N3633GD				36"	

"J" hooks included

Side Guards

NEW

Many trucks work in close proximity to pedestrians and cyclists. Nu-Line Side Guards provide an additional protection barrier in the event of a side collision.

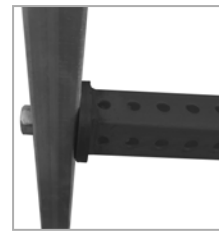

Easy 1-bolt assembly to truck frame.



Easy 5 minute per side installation.



Pin locking system removes in seconds for temporary access to undercarriage.

- ◆ Meets VOLPE recommend standard of side guard force protection
- ◆ Easy/flexible installation (5 minutes per side)
- ◆ No welding or fabrication
- ◆ No "certified" installer required
- ◆ Easy temporary removal if automotive technician needs access to undercarriage



Limited Lifetime Warranty*

2' beams Pair Part #: **NSG2-KIT**

3' beams Pair Part #: **NSG3-KIT**

5' beams Pair Part #: **NSG5-KIT**

8' beams Pair Part #: **NSG8-KIT**

To order one side change **KIT** to -1

AWAYWASH - Concrete Washout System



AWAYWASH is the first on-board polyethylene system for ready-mix concrete truck chute washout. This patented design allows to wash the chute in compliance with environmental requirements while avoiding risks of contamination and penalties/fines. The product is light, sturdy and easy to maintain as concrete does not adhere to it.



Part #: **NF330-6KIT**



Part #: **N7330-2KIT**



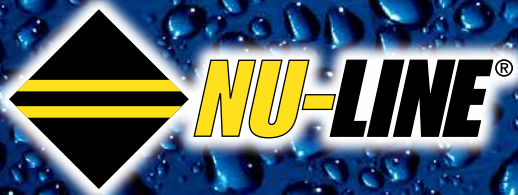

Nu-Line is Canada's Spray Suppression Leader. With a full line of products to fit all major manufacturers trucks and trailers, you can count on Nu-Line for unparalleled quality and exceptional value. Nu-Line is a Marmon Highway Technologies LLC (MHT) company. MHT companies support the transportation industry worldwide with a wide range of high-quality products and services. MHT companies are members of Marmon Holdings, Inc., an International Association of more than 175 business units that operate independently within diverse business sectors. Marmon Holdings, Inc. is a Berkshire Hathaway company.



Toll Free: 866-837-2082
www.nuline.ca
sales@nuline.ca

Nu-Line Products Inc.

891 Arvin Avenue, Stoney Creek, ON L8E 5N9

Fax: (905) 643-5380

Specifications subject to change without notice.

NL2018-6000-1809-R7
©2018 Nu-Line Products, Inc.

For installation, fender care and warranty information go to nuline.ca and choose Nu-Line menu and then choose "Literature"