

KIT MASTERS

EXCEEDING EXPECTATIONS WITH HIGHER QUALITY PRODUCTS & SERVICE



FAN CLUTCH EXPERTS

Now Your Exclusive Distributor of BorgWarner® Products



Kysor® On/Off Drives



Viscous Fan Drives



Fan Blades



*Cool Logic™
Fan Drives*

www.kit-masters.com

GET PARTS FAST THROUGH OUR REGIONAL WAREHOUSES

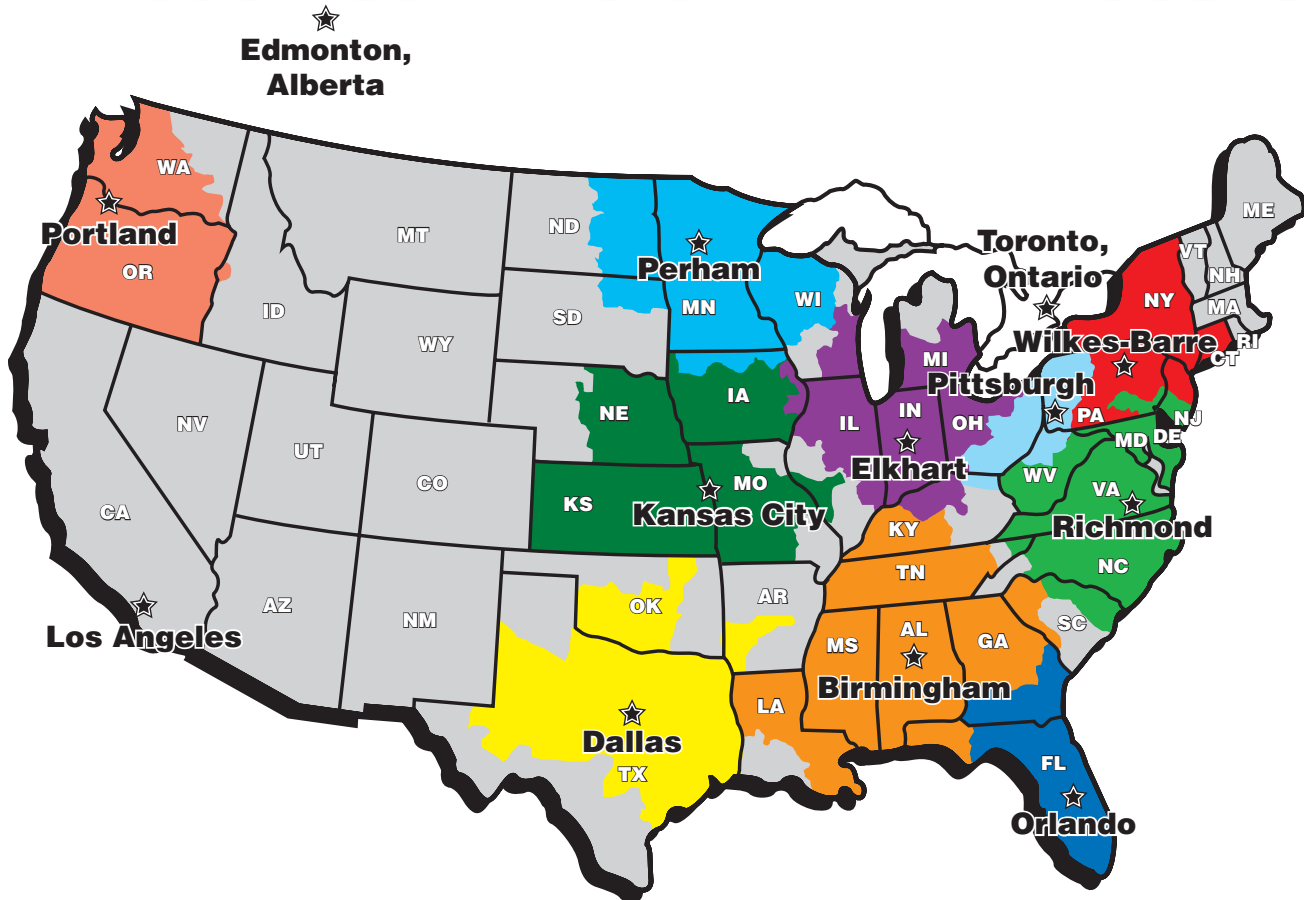

To get you the fan clutch parts you need fast, we have **added warehouses throughout the United States and Canada.** You now have access to over **97% of all remanufactured fan clutches** and over 99% of all rebuild kits and accessories via **NEXT DAY GROUND SHIPPING.**

United States

Birmingham, Alabama
Elkhart, Indiana
Dallas, Texas
Orlando, Florida
Los Angeles, California

Canada

Edmonton, Alberta
Toronto, Ontario

LIMITED WARRANTY:

Kit Masters Inc. warrants its products to be free of defects in material and workmanship for 24 months or 200,000 miles, (whichever comes first), from the date of installation. This warranty shall not apply to conditions resulting from misuse, negligence, alteration, accident, or improper installation or improper maintenance. Bendix & BorgWarner products carry a 12 month/100,000 mile warranty.

RETURNED GOODS:

Items returned for credit must be returned freight prepaid. Items returned for credit must be returned to Kit Masters, Inc., 825 1st Street NE, Perham, MN 56573

Contents

Rebuild Kits - 7500/9500 Air Engaged4

GoldTop® Rebuild Kits - Spring Engaged.....5

Rebuild Kits - F/A & R/A (Front Air & Rear Air)8

Remanufactured Fan Clutches - F/A & R/A (Front Air & Rear Air)9

BorgWarner® Products11

Bendix®-Style Fan Clutches.....12

Recommended Shop Inventory.....13

How to identify a Fan Clutch without a part number.....14

Fan Clutch Controls.....15

Fan Blades16

Remanufactured Fan Clutches - 7500/9500 Series, GoldTop® & Bendix® 17-86

 Caterpillar®17

 Cummins®.....37

 Detroit Diesel®.....57

 International®.....66

 Mack®67

 MCI® Remote Mount.....69

 Mercedes-Benz®.....70

 Volvo®72

 Bendix®73

Cross Reference87

 7500/9500 Series & GT (GoldTop®)87

 Bendix® Conversions and Rebuild Kits.....105

 F/A & R/A (Front Air & Rear Air).....107

Kit Masters Resources 111

DISCLAIMER

All of the pictures, specifications, descriptions, text and other data in this catalog have been carefully checked and researched with original manufacturers catalogs at the time of publication. We assume no responsibility should any information be deemed as incorrect, and reserve the right to make changes at any time without notice.

Manufacturer’s names, symbols, numbers and descriptions are used for reference purposes only. It is not implied that any part listed is the product of these manufacturers.

NOTE: Any reference made herein to Ford®, GMC®, MCI®, Mack®, Mercedes Benz®, Freightliner®, Navistar®, International®, Volvo®, Peterbilt®, Western Star®, Kenworth®, Sterling®, Caterpillar®, Cummins®, Detroit®, Horton®, Kysor®, Bendix®, FD-3™, FD-L™, Borg Warner®, is purely for identification purposes only.

All of the above companies are registered trademarks or trade names of their respective companies. We do not intend to represent any parts shown as products manufactured by the above companies.

Rebuild Kits - Air Engaged

7500HP – 7.5” S Series



9500HP – 9.5" HT/S Series

9505SP - 9.5" HT/S Series "Special Plate"



FEATURES INCLUDE:

- U.S. Components and U.S. Manufactured
- Two Bearing Hub Design vs. One Bearing Hub Design
- SKF Bearings vs. Imported Bearings
- Angular Contact Bearing
- Floating Return Spring vs. Captive Return Spring
- Higher Quality Lining
- Superior Fused Plate (Virgin Teflon vs. Lead)
- Superior O-Rings (HNBR vs. NBR)
- All Wearable Components Are Always Replaced
- 200,000 Miles / 24 Months Warranty

9500 Major Kits



7500 Major Kits



4205 - S & HT/S Series



Lining Kits



MFGR'S PART NUMBERS	KIT MASTERS PART #
994205	4205
994207	94207
994212	7503
994245	9505
994246	9503
994305	9500HP

MFGR'S PART NUMBERS	KIT MASTERS PART #
994306	9505SP
994307	7500HP
994308	9500HP
994314	7500H
994315	9500H
994316	9505H

MFGR'S PART NUMBERS	KIT MASTERS PART #
994319	9503
994321	7503
994322	9500HP
994323	9500H
994324	7500HP
994325	7500H

MFGR'S PART NUMBERS	KIT MASTERS PART #
994388	9500HP
994370	4205
NA	7500
NA	9500

Rebuild Kits - Spring Engaged



We developed the new GoldTop® Rebuild Kits to out-perform the competition!

With over 5,000 inch-pounds of torque, the GoldTop® Rebuild Kits will handle all fan blades!

14-256

Upgrade to over 5,000 inch-pounds of Torque!

2.56" Pilot
2 Pulley Bearings

14-256-1

Upgrade to over 5,000 inch-pounds of Torque!

2.56" Pilot
1 Pulley Bearing

14-200

Upgrade to over 5,000 inch-pounds of Torque!

2" Pilot
2 Pulley Bearings

Kit Masters Kits to Rebuild Horton® Fan Clutch

<p>14-SBL</p> <p>Seal, Bearing & Lining Kit</p>	<p>14-S</p> <p>Seal Kit</p>	<p>14-L</p> <p>Lining Kit</p>
--	------------------------------------	--------------------------------------

MFGR'S PART NUMBERS	KIT MASTERS PART #	USE STUD KIT
994346	14-S	-
994347	14-256	-
994349	14-L	-
994353	14-256-1	300SK
994373	14-256	150SK
994375	14-256	250SK
994377	14-256	300SK
994379	14-256	350SK
994381	14-256	425SK
994383	14-200	-

MFGR'S PART NUMBERS	KIT MASTERS PART #	USE STUD KIT
994385	14-200	150SK
994387	14-200	300SK
994900	14-256	-
994902	14-256-1	-
994966	14-SBL	-
994985	14-256	-
994995	14-256	150SK
995031	14-256-1	-
995033	14-SBL	-
995034	14-256	-

MFGR'S PART NUMBERS	KIT MASTERS PART #	USE STUD KIT
995035	14-256	-
995037	14-256	150SK
995042	14-256	250SK
995046	14-L	-
995047	14-LP	-
995052	14-256	200SK
995053	14-256	300SK
995054	14-256	-
995055	14-256-1	200SK
995056	14-256-1	300SK

MFGR'S PART NUMBERS	KIT MASTERS PART #	USE STUD KIT
995057	14-256-1	200SK
995058	14-256-1	300SK
995062	14-256-1	350SK
995063	14-256	350SK
994995	14-256	-
995530	14-256	-
995534	14-256	275SK
994922	14-256*	-

*Also requires 14-ADPT & 14-5

The Ultimate way to Reman!

HAS YOUR FAN CLUTCH

FAILED TOO SOON

The New Torque Leader Solves the Problem!



Our GoldTop® is unmatched by any competitors (new or remanufactured) & packs over 5,000 inch-pounds of Torque!

We developed the GoldTop® Rebuild Kit to out-perform the competition!

Highest Torque Rating

With over 5,000 inch-pounds of torque, the GoldTop® Rebuild Kit will handle all fan blades!!

Less Time To Install

Our exclusive design combines nine separate components into **ONE FINAL ASSEMBLY** – this dramatically reduces installation time and installation errors.

Higher Quality Internal Components

- Kevlar® impregnated friction material
- 4-point urethane seal
- Elimination of two seals equals two less leak paths
- Cast on cast construction reduces corrosion and wear

Lower Cost

Upgrading your fan clutch is as simple as installing the GoldTop® Rebuild Kit.

- Less failures
- Less time to install



Compare to the Alternative

Kit Masters patented GoldTop® reduces nine components into **one component assembly**, saving significant installation time and reducing the risk of installation errors.

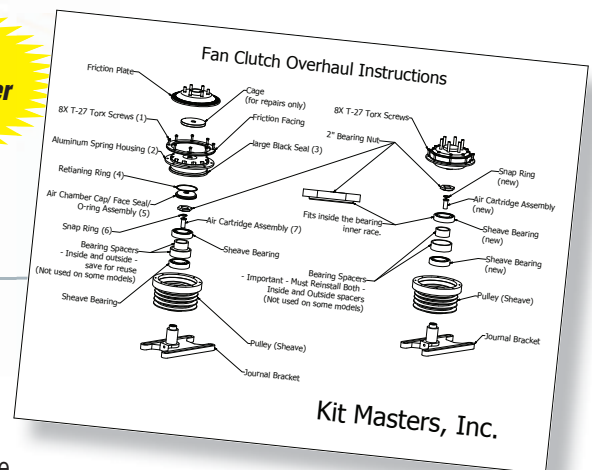

Kit Masters, Inc.

Competitive Advantage

Two O-Rings are Better than One!
 Plus, our High-Torque 8801X is engineered to outlast the competition.

Kit Masters' 8801X extended shaft allows for the addition of a urethane o-ring for resilience to motion, and a Viton® o-ring to create a superior air barrier.

8801X Shaft Design allows for **DUAL SEAL PROTECTION**



At Kit Masters we are always striving to make good products even better.

That is why we made our 8801X remanufactured fan clutch the highest torque rated K26 replacement on the market.



WE STOCK

1077 - KYSOR® HUBS
 1093 - KYSOR® HUB & CLUTCHES



Call for Availability

See page 10 for hub identification guide



X-TENDER Plates Equipped

When your friction material is worn, simply flip the plates over, and the X-Tender dimples push the worn friction material back into operation.

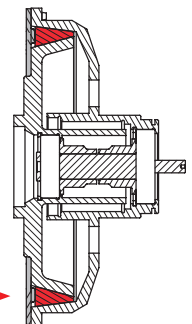
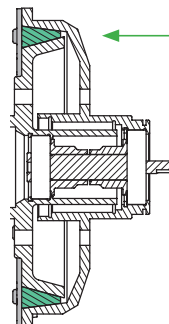

Front & Rear Air Rebuild Kits

K30, K26 and K22 Front and Rear Air Rebuild Kits



DESCRIPTION	OEM#
8000SKL - Front Air 8500SKL - Rear Air SEAL LINING KIT COMBINATION for K-22 Fan Clutches	1033-05435-02 1033-05435-03
8800SKL - Rear Air SEAL LINING KIT COMBINATION for K-26 & K-30	1033-09339-01



DESCRIPTION	OEM#
8000SK - K22 Front Air 8500SK - K22, K26 & K30 Rear Air SEAL KIT to Repair Air Leaks	1033-08233-01



8500L / 8800L - LINING KIT	
DESCRIPTION	OEM#
8500L LINING KIT for K-22	1033-08250-01
8800L LINING KIT for K-26 & K-30	1033-09340-01

1077 HUB BEARING KITS

When replacing your fan clutch, you should also consider replacing the pulley bearings



DESCRIPTION	OEM#
BEARING KITS	
8581-01	1033-07781-01
8582-01	1033-07782-01
8582-02	1033-07782-02
8582-03	1033-07782-03
8582-04	1033-07782-04

THESE FIVE BEARING KITS WILL REPAIR ALL REAR-AIR 1077-XXXXX-XX REAR AIR HUBS. REPLACING THE HUB BEARINGS WILL ENSURE LONGER FAN CLUTCH LIFE.

8581-01



8582-01



8582-02



8582-03



8582-04



Remanufactured F/A & R/A

PART NO.

8001X Front Air

Kit # 800SKL

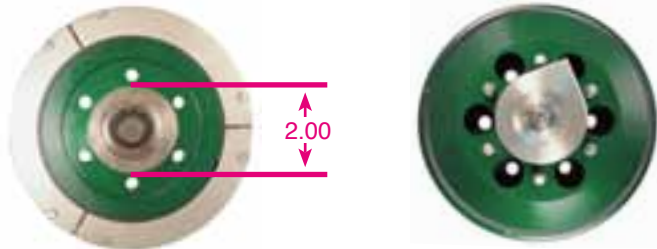

PART NO.

8005X Front Air

Kit # 800SKL

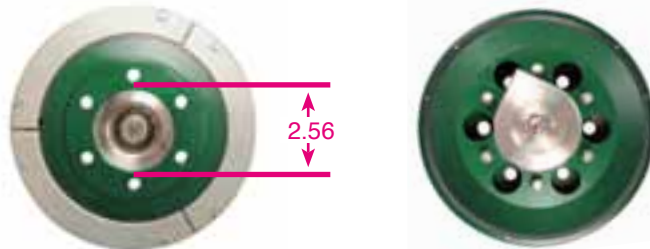

8802X Rear Air

Kit # 850SKL

No Studs with threaded 5/16 holes

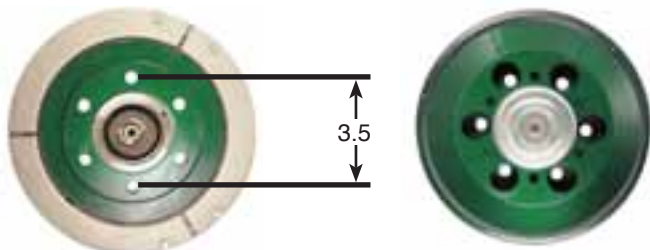

8803X Rear Air

Kit # 850SKL

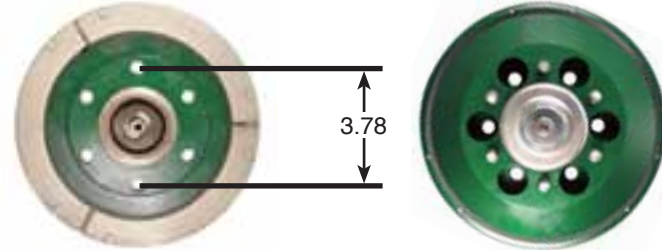

8501X Rear Air

Kit # 850SKL

Most common 1995-2003

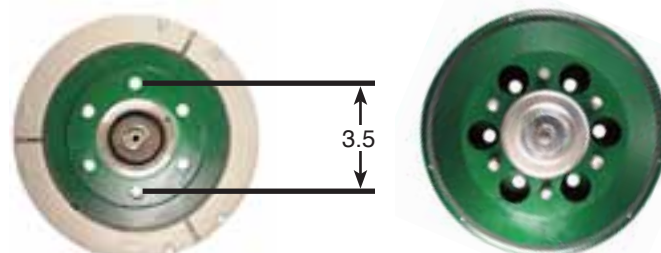

8801X Rear Air

Kit # 880SKL

Most common 2003-Present

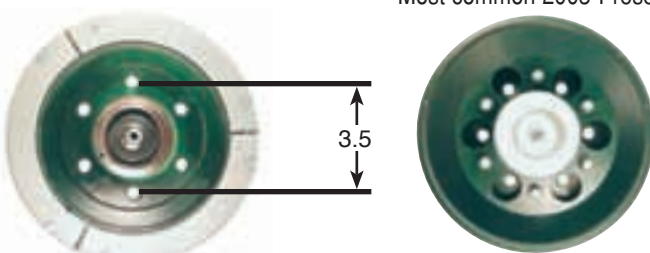

SUPERSEDED BY →

All NEW Shaft Design
allows for
DUAL SEAL PROTECTION

See page 7 for more information on Kit Masters' exclusive Dual Seal Protection. We also stock most R/A Hubs and Complete R/A Hub and Clutch assemblies, call for availability.

OEM #	Kit Masters #	Use Kit #	Style	Notes
1090-07050-01	8001X	N/A	FA	Replace Only
1090-07050-03	8005X	N/A	FA	Replace Only
1090-08000-01	8001X	8000SKL	K-22 FA	
1090-08000-05	8005X	8000SKL	K-22 FA	Mack® Application Only
1090-08500-01	8801X	8500SKL	K-22 RA	Most Common
1090-08500-02	8802X	8500SKL	K-22 RA	Used on some Fords®
1090-08500-03	8803X	8500SKL	K-22 RA	Used on some Fords®
1090-09000-01	8001X	N/A	FA	
1090-09500-01	8801X	8800SKL	K-26 RA	K- 26
1090-09500-03	8803X	8800SKL	K-26 RA	
1090-09600-01	K-30	8800SKL	K-30 RA	Use 8801X unless on Mack®
1090-09900-01	K-30	8800SKL	K-30 RA	Use 8801X unless on Mack®

Borg Warner Hubs/Clutches

How to order BorgWarner-Style rear air fan clutch assemblies.

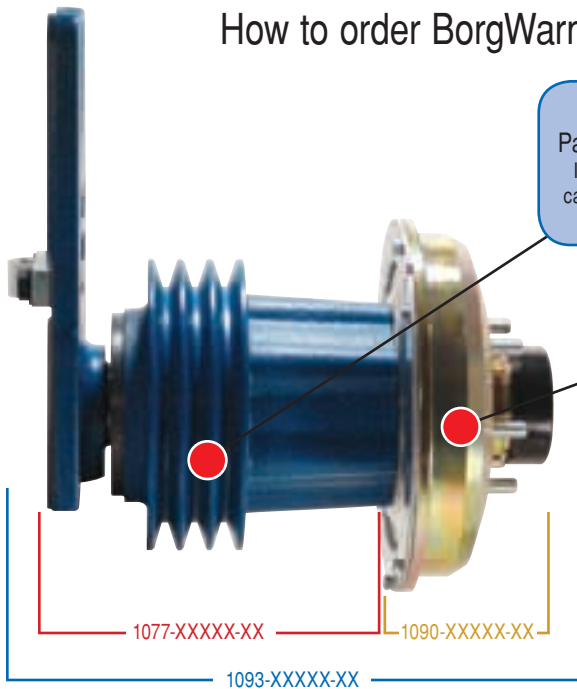

FAN HUB
Part Number 1077-XXXX-XX
Identified by tag on bracket or by calling Kit Masters with the casting number on bracket

FAN CLUTCH
Identified by tag on clutch or by using cross-reference based on Fan Hub part number.

Part number 1093-XXXX-XX refers to an entire BorgWarner-Style fan clutch assembly. It is for reference purposes only and not available for ordering.

Using the cross-reference guide that begins on page 107 will break the assembly down into two part numbers for you to order (the Fan Hub number and Fan Clutch number).

If you are only replacing the Fan Clutch portion, you should also consider replacing the pulley bearings

HT550® / HT650® CONVERSIONS

Our 8009X is a direct replacement/upgrade for Mack® applications of the HT650®/HT550® fan clutches.*

OEM #	Kit Masters #	OEM #	Kit Masters #
991400.....	.8011X	991439.....	.8009X
991405.....	.8011X	991445.....	.8010X
991419.....	.8011X	991446.....	.8011X
991420.....	.8011X	991450.....	.8010X
991428.....	.8009X	991451.....	.8009X
991435.....	.8009X		



THEIRS



OURS

*When converting from HT650®/550®, reverse solenoid valve to air to disengage instead of air to engage.

KIT MASTERS

Is your new supplier for



KYSOR[®] ON/OFF DRIVES

*Brand new
for heavy
duty market*

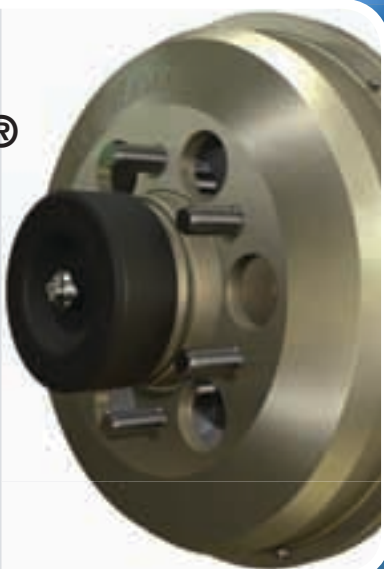

FANS

*-All Sizes
-All Makes
-All Models*

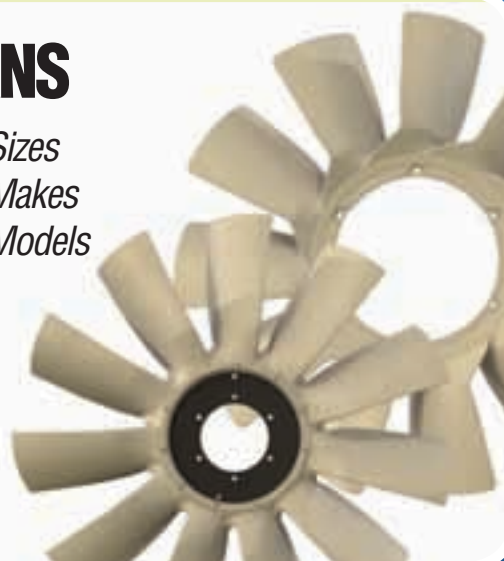

VISCOUS FAN DRIVES

*-Genuine O.E.
-School Busses
-Medium Duty
-Light Duty*



COOL LOGIC[™] FAN DRIVES

*-Heavy Duty
Multi Speed*



See supplemental catalog for more information.

Bendix®-Style Fan Clutches



Available only from Kit Masters!

Premium remanufactured Bendix-Style fan clutches.

- All Wearable Components Are ALWAYS Replaced
- Upgraded Seal Materials
- Upgraded Bearings
- Unique GTN Option (see below)
- **100,000 Mile - 12 Month Warranty**

OR

Upgrade to GoldTop® Technology

Upgrade the Bendix®-Style Fan Clutch to the **GoldTop® Spring Engaged Fan Clutch.**

**From
Old**



**To
Gold**



- Upgrade from approximately 1,000" lbs. of torque to well over 5,000" lbs. of torque.
- Easy to find replacement parts.
- Easier for future rebuilding.
- The shaft, pulley, and fan clutch mechanism are new, only the bracket is reused.
- **2 Year / 200,000 Mile Warranty**

**Upgrade to over
5,000 inch-pounds
of Torque!**

Recommended Shop Inventory

With these products on hand you can rebuild or replace over 95% of all heavy duty fan clutches in operation today!

7500HP – 7.5" S Series



9500HP – 9.5" HT/S Series

9505SP - 9.5" HT/S Series "Special Plate"



8801X – Rear Air



14-256

Upgrade to over 5,000 inch-pounds of Torque!

2.56" Pilot
2 Pulley Bearings

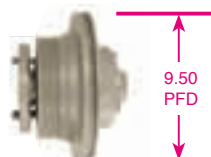

Gold Top
By Kit Masters

Fan Clutch Identification

How to identify a Fan Clutch without a part number

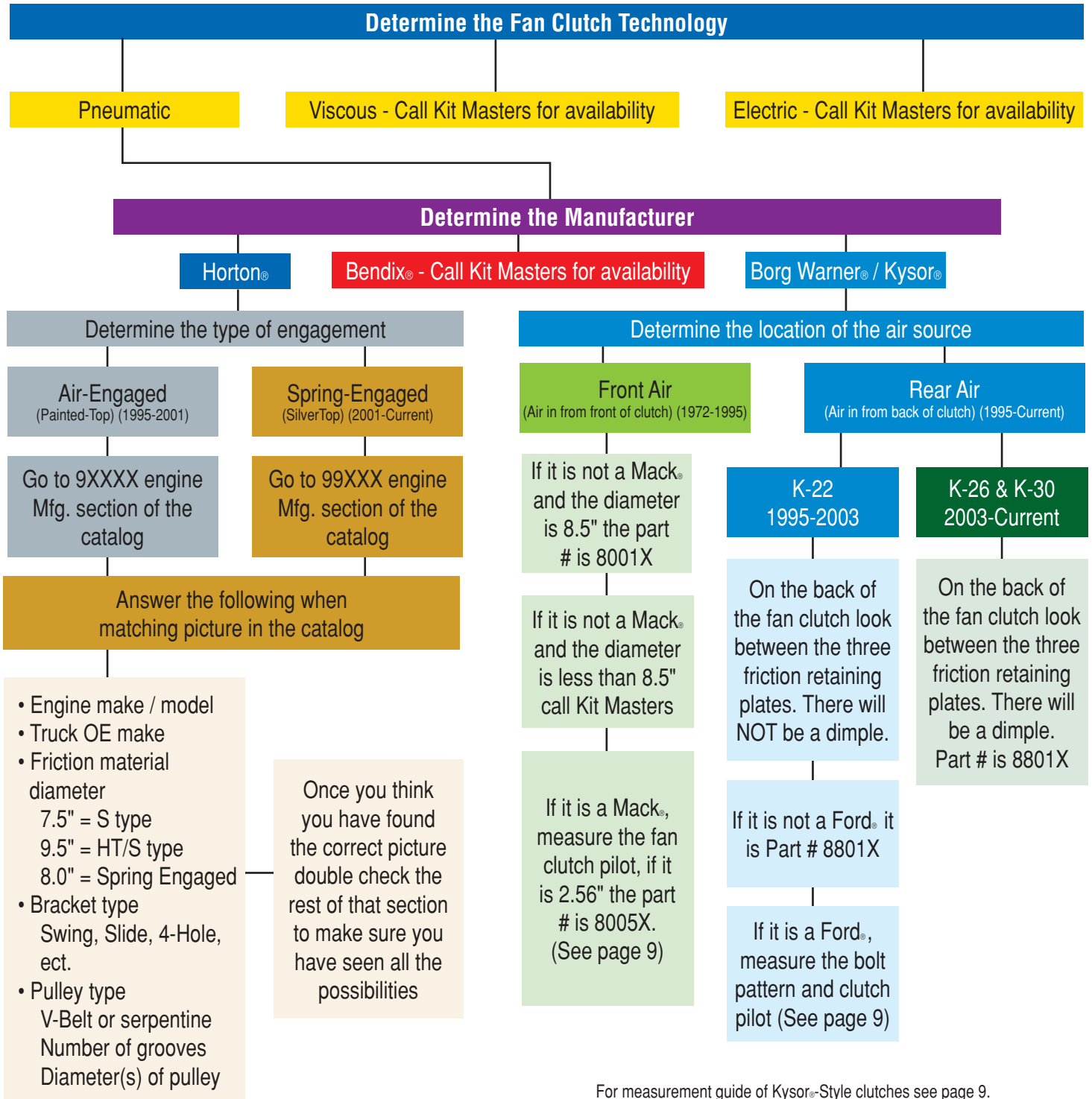

For measurement guide of Kysor-Style clutches see page 9.

All of the above companies are registered trademarks or trade names of their respective companies. We do not intend to represent any parts shown as products manufactured by the above companies.

Fan Clutch Controls

Thermal Switches



PART#	DESCRIPTION	OEM#
3611	185° Normally Open Thermal Switch (3/8" Thread)	993611
3616	185° Normally Open Thermal Switch (1/2" Thread)	993616
3619	185° Normally Closed Thermal Switch (1/2" Thread)	993619
3617	190° Normally Open Thermal Switch (1/2" Thread)	993617
3603	190° Normally Closed Thermal Switch (1/2" Thread)	993603
3653	195° Normally Open Thermal Switch (1/2" Thread) used on most Cummins®	993653
3605	195° Normally Closed Thermal Switch (1/2" Thread) used on most Cummins®	993605
3654	200° Normally Open Thermal Switch (1/2" Thread) used on most Detroit®	993654
3606	200° Normally Closed Thermal Switch (1/2" Thread) used on most Detroit®	993606
3655	205° Normally Open Thermal Switch (1/2" Thread) used on most Caterpillar®	993655
3607	205° Normally Closed Thermal Switch (1/2" Thread) used on most Caterpillar®	993607
3624	210° Normally Open Thermal Switch (1/2" Thread)	993624
3684	210° Normally Closed Thermal Switch (1/2" Thread)	993684
3625	215° Normally Open Thermal Switch (1/2" Thread)	993625
3685	215° Normally Closed Thermal Switch (1/2" Thread)	N/A
3626	220° Normally Open Thermal Switch (1/2" Thread)	993626
3665	220° Normally Closed Thermal Switch (1/2" Thread)	993665

Solenoid Valves

PART#	DESCRIPTION	OEM#
3282	3-way Solenoid Valve NO-NC 125NPTF, 12VDC	993282
3283	3-way Solenoid Valve NO-NC 125NPTF, 24VDC	993283

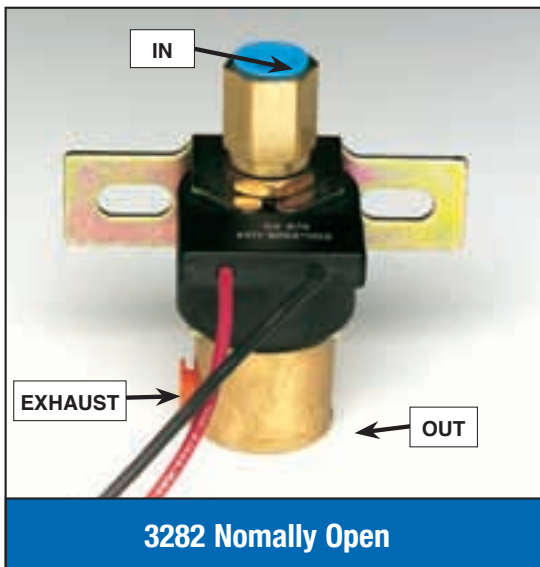

Used with air engaged fan clutches with Normally Closed Thermal Switch, or use with all spring engaged fan clutches.

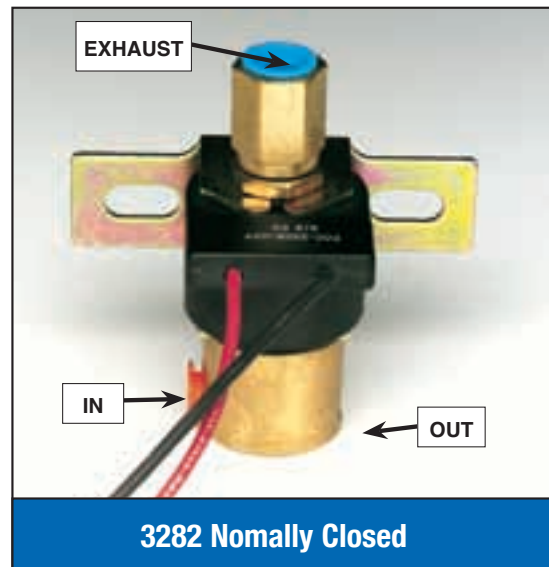

Used with air engaged fan clutches with Normally Open Thermal Switch.

3282 and 3283 3-way Solenoid Valves can be plumbed either Normally Open or Normally Closed.

Fan Blades

How to Specify a Kit Masters Fan Blade

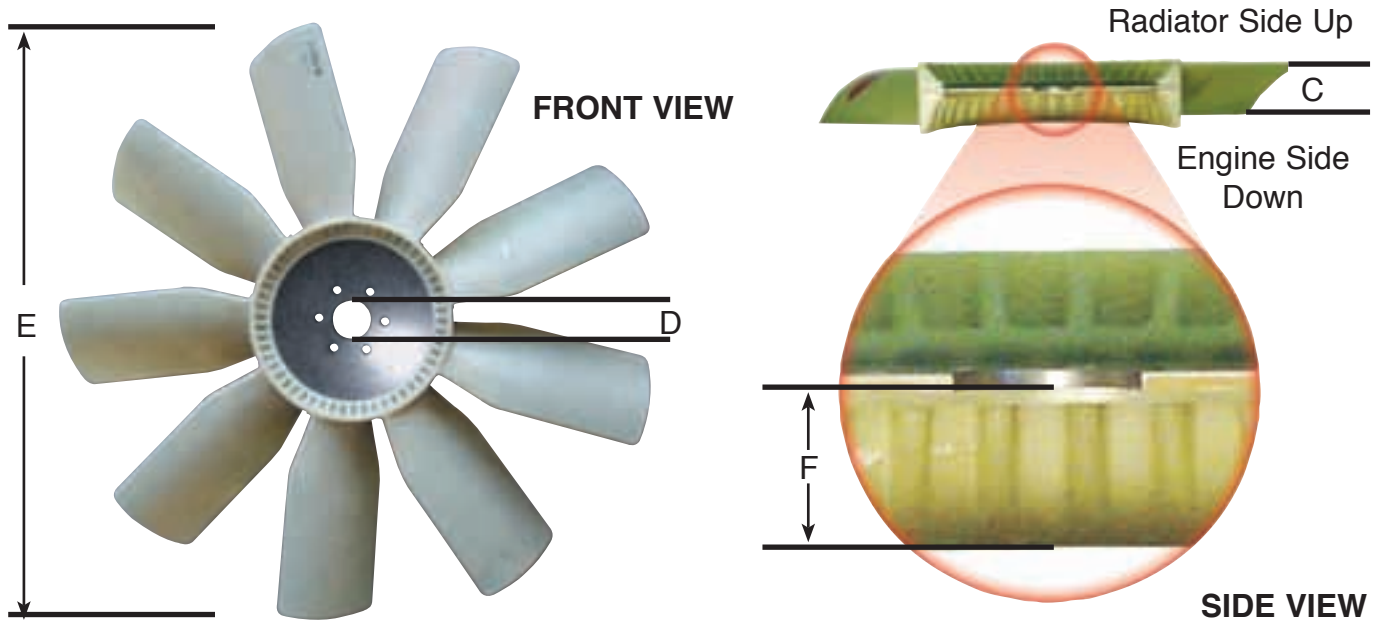

To order a fan blade please provide the following information:



A. Choose one of the following:
Fan Rotation Options

- 1 = Clockwise Rotation (sucker)
- 2 = Counterclockwise Rotation (pusher)
- (Most OTR trucks are CW)

B. Choose one of the following:
Number of Fan Blades

- 6 = 6 Blades
- 7 = 7 Blades
- 8 = 8 Blades
- 9 = 9 Blades
- 0 = 10 Blades
- 1 = 11 Blades

C. Choose one of the following:
Maximum Projected Width
(Pitch)

- 1 = 2.27
- 2 = 2.76
- 3 = 2.97
- 4 = 3.089
- 5 = 3.247
- 6 = 3.34
- 7 = 3.565
- 8 = 4.28
- 9 = 5.05

(Additional Dimensions are also available -
Contact your Distributor)

Most fan blades ship within 24 hours.

D. Choose one of the following:
Fan Pilot Diameters

- 1 = 2.00"
- 2 = 2.05"
- 3 = 2.56"
- 4 = 5.00"

E. Choose one of the following:
Fan Blade Diameter

- 24 = 24" Fan
- 26 = 26" Fan
- 28 = 28" Fan
- 30 = 30" Fan
- 32 = 32" Fan
- 34 = 34" Fan

F. Choose one of the following:
Dish Measurement (Inches)

- A = 7/8" (0.875")
- B = 1 1/4" (1.250")
- C = 1 3/8" (1.375")
- D = 1 1/2" (1.50")
- E = 1 5/8" (1.625")
- F = 1 3/4" (1.750")
- G = 1 7/8" (1.875")
- H = 2" (2.00")
- I = 2 1/8" (2.125")
- J = 2 1/4" (2.250")
- K = 2 3/8" (2.375")
- L = 2 1/2" (2.50")
- M = 2 5/8" (2.625")
- N = 2 3/4" (2.750")
- O = 2 7/8" (2.875")
- P = 3" (3.00")
- Q = 3 1/4" (3.250")
- R = 3 3/4" (3.750")

Caterpillar®

PART NO.

90005

Kit # 7500HP

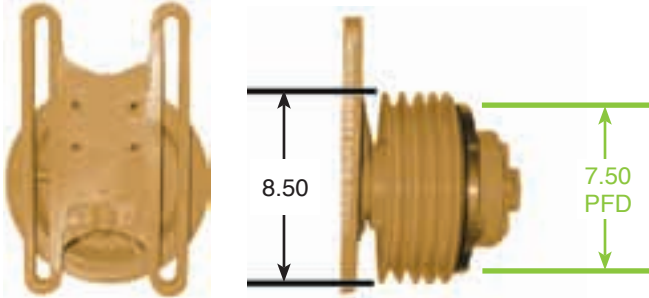

PART NO.

90007

Kit # 7500HP

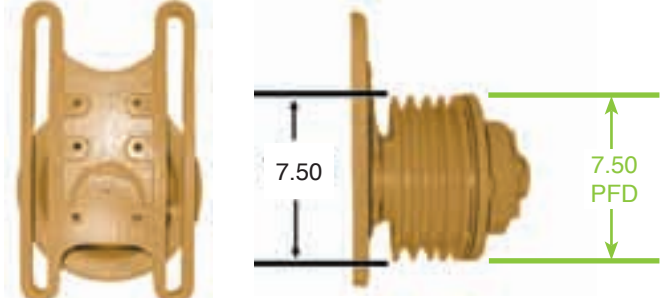

90014

Kit # 7500HP



90015

Kit # 7500HP

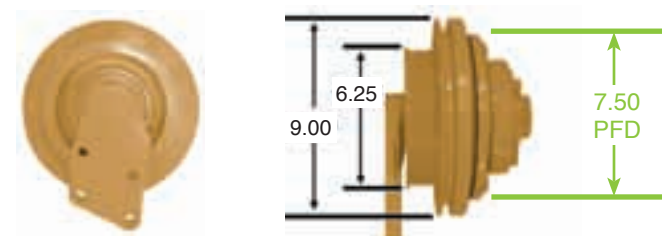

90022

Kit # 7500HP

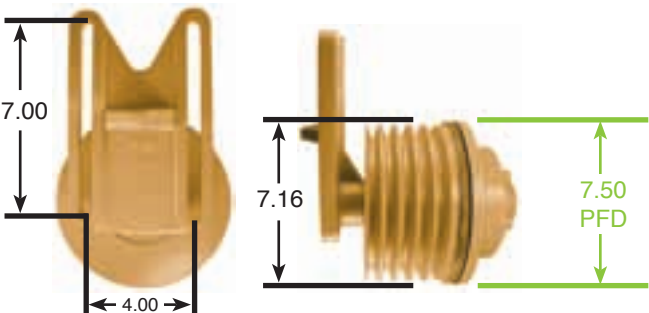

90028

Kit # 7500HP

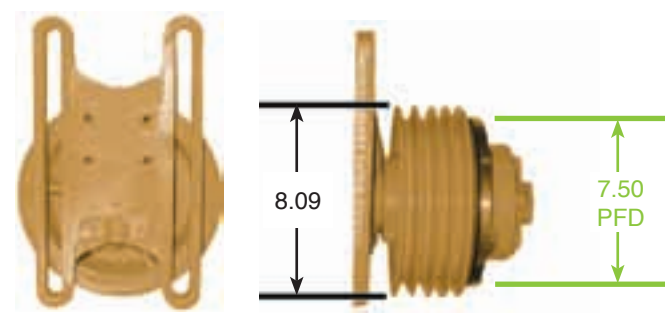

90030

Kit # 7500HP

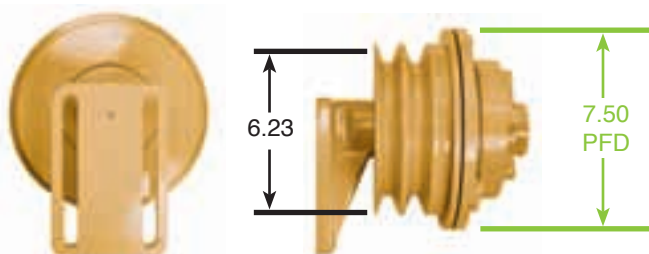

91002

Kit # 9500HP

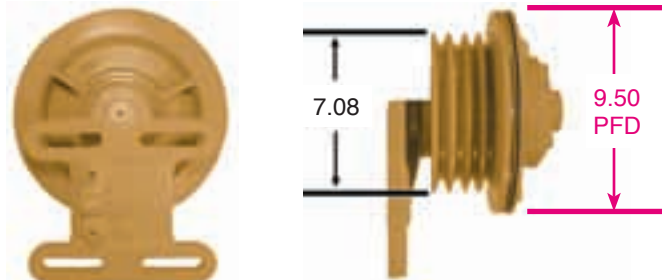

PART NO.

91003

Kit # 9505SP

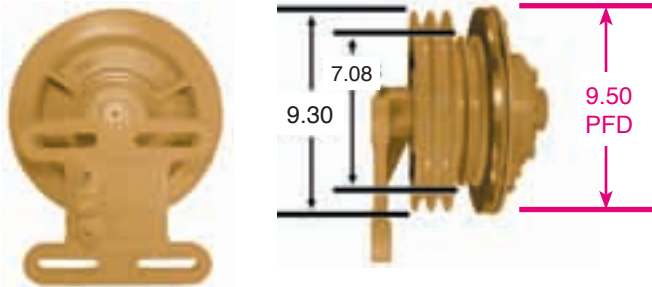

PART NO.

91005

Kit # 9500HP

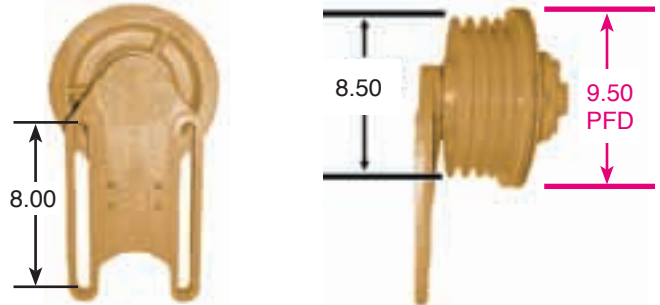

91007

Kit # 9500HP

2" Fan Pilot

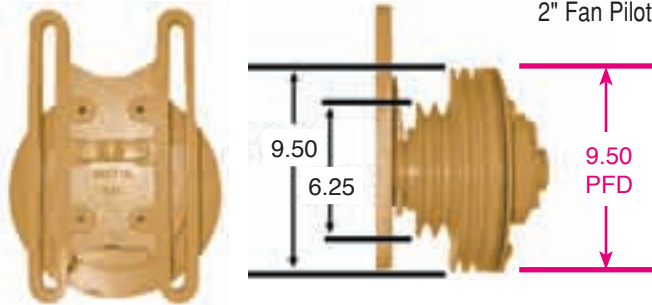

91008

Kit # 9500HP

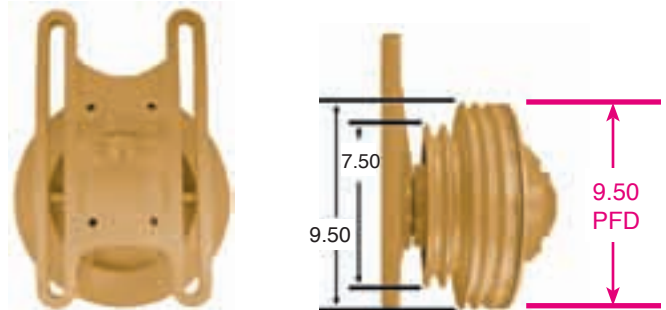

91012

Kit # 9505SP

5" Fan Pilot
(2" Fan Pilot - Contact Distributor)

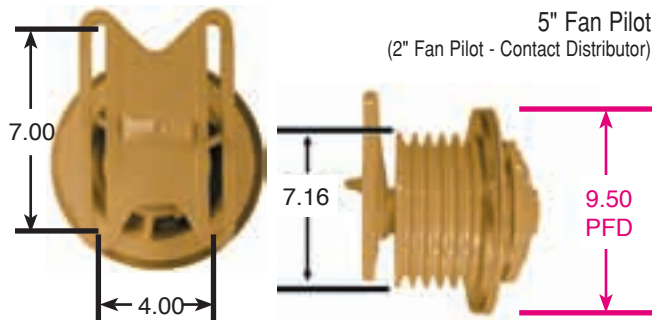

91013

Kit # 9500HP

5" Fan Pilot

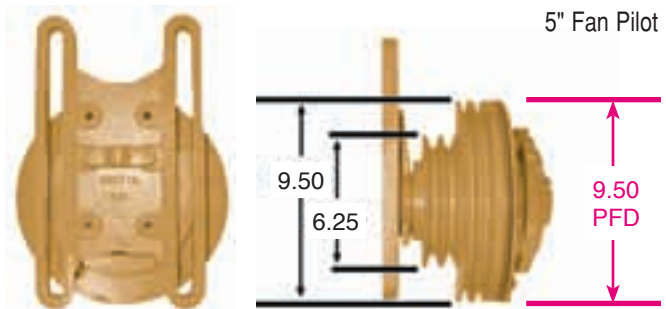

91014

Kit # 9500HP

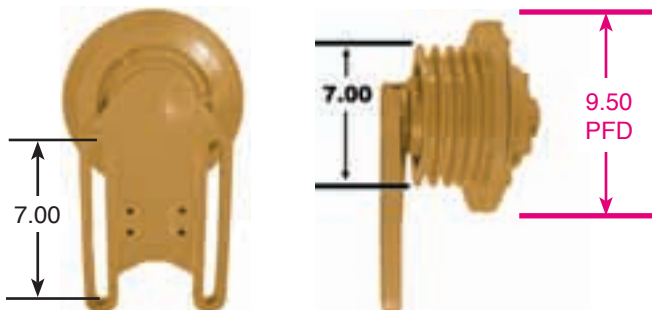

91015

Kit # 9500HP

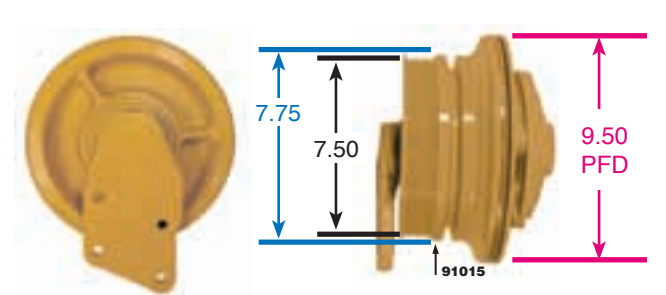

Caterpillar®

PART NO.

91017

Kit # 9505SP

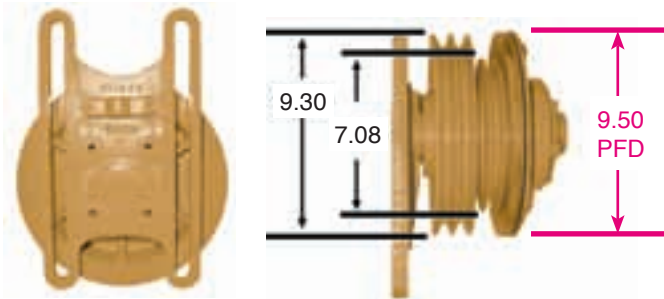

PART NO.

91020

Kit # 9500HP

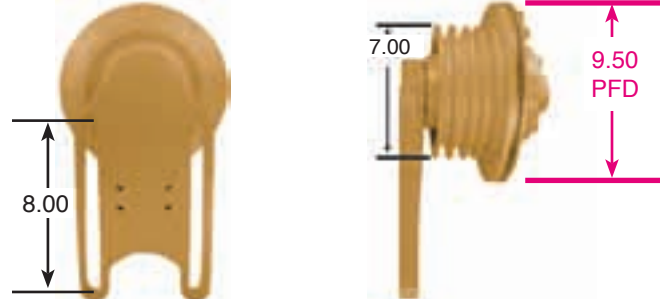

91025

Kit # 9500HP

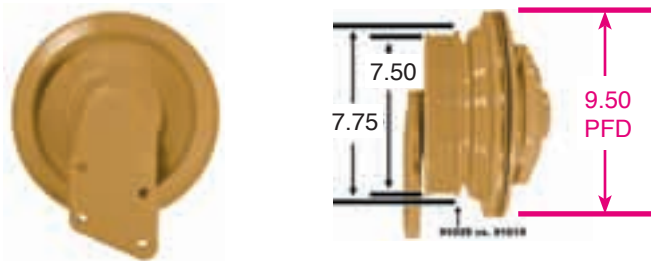

91027

Kit # 9500HP

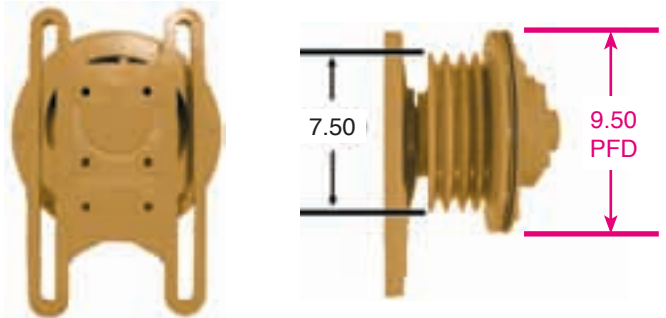

91028

Kit # 9500HP

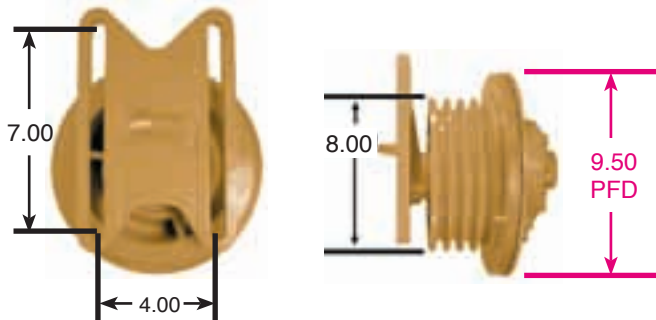

91035

Kit # 9500HP

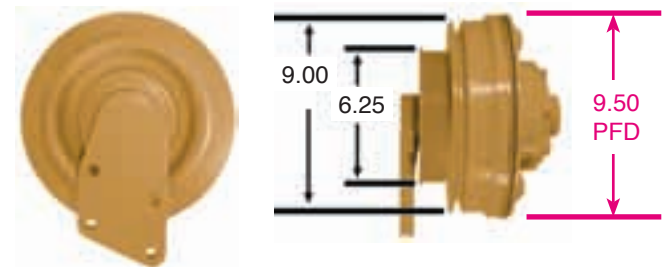

91038

Kit # 9500HP

5" Fan Pilot

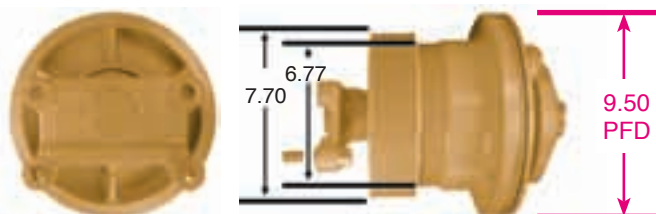

91048

Kit # 9500HP

2.56" Fan Pilot

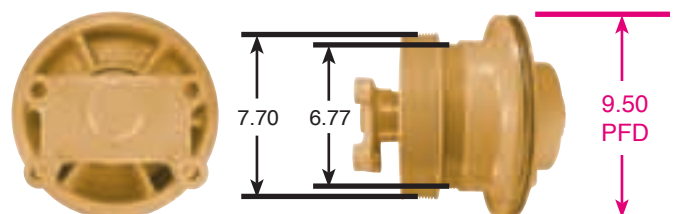

PART NO.

91049

Kit # 9500HP

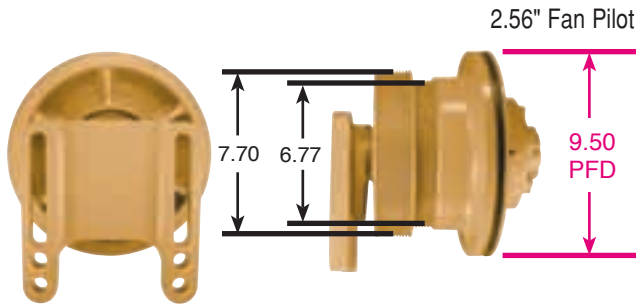

PART NO.

91051

Kit # 9500HP

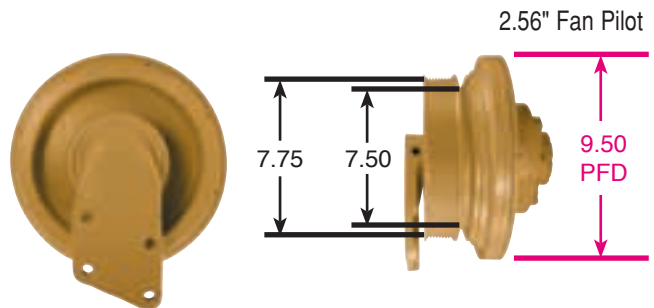

91057

Kit # 9500HP

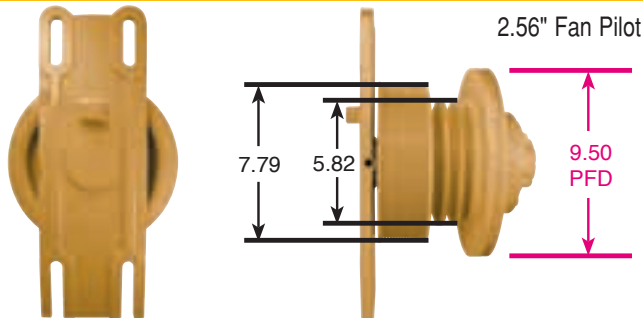

91059

Kit # 9500HP

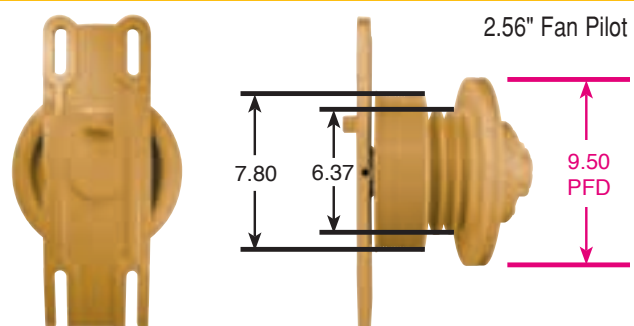

91060

Kit # 9500HP

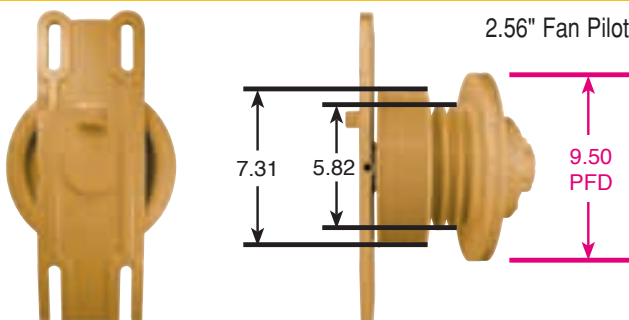

91063

Kit # 9500HP

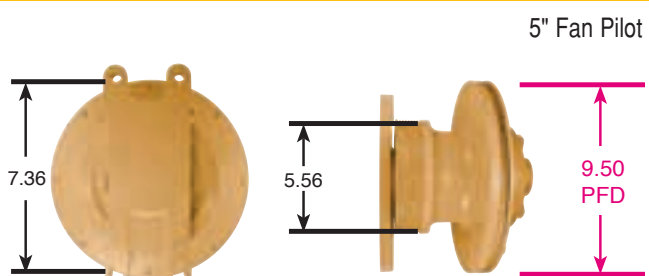

91066

Kit # 9500HP

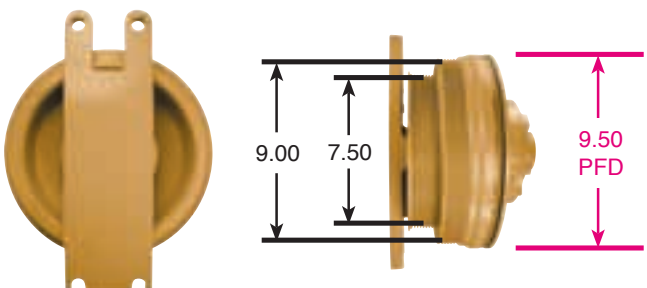

91067

Kit # 9500HP

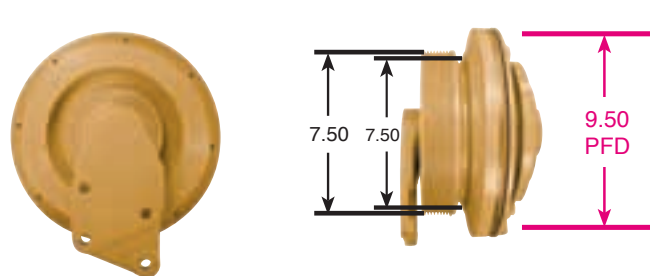

Caterpillar®

PART NO.

91068

Kit # 9500HP

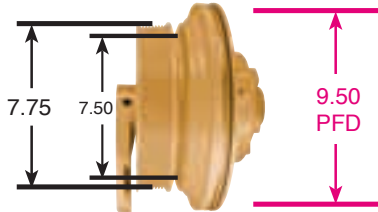

PART NO.

91069

Kit # 9500HP

Same as 91070

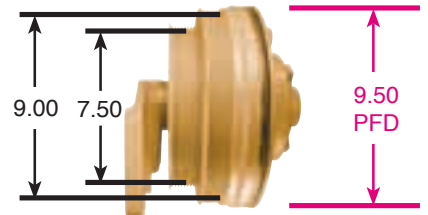

91070

Kit # 9500HP

Same as 91069

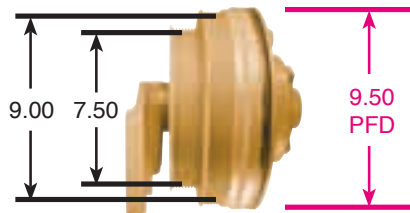

91071

Kit # 9500HP

2" Fan Pilot

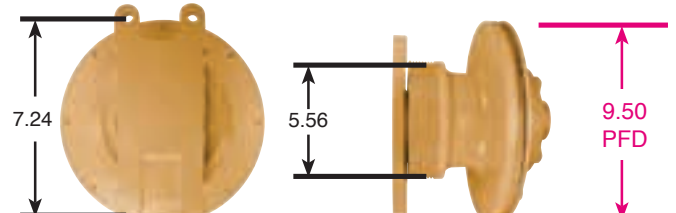
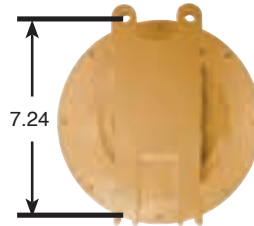

91076

Kit # 9500HP

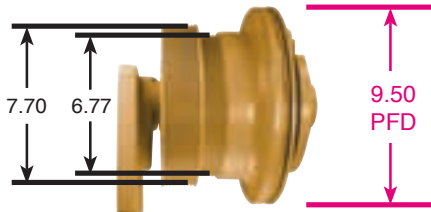

91081

Kit # 9500HP

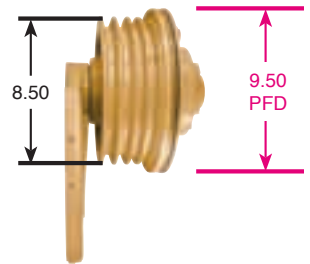
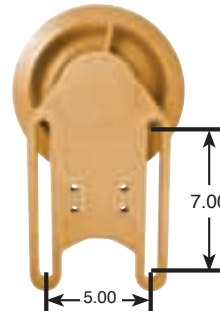

91082

Kit # 9500HP

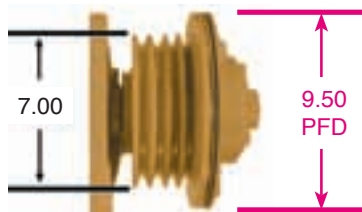

91085

Kit # 9500HP

5" Fan Pilot

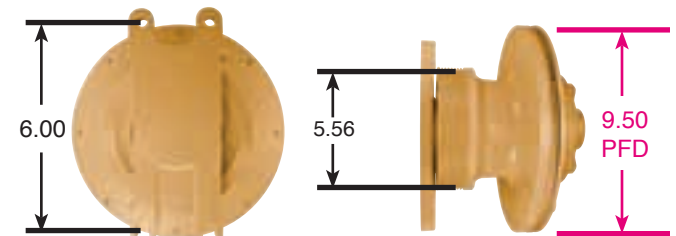
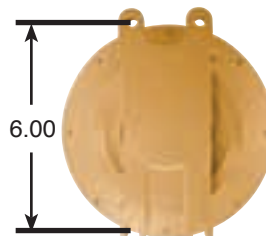

PART NO.

91087

Kit # 9500HP

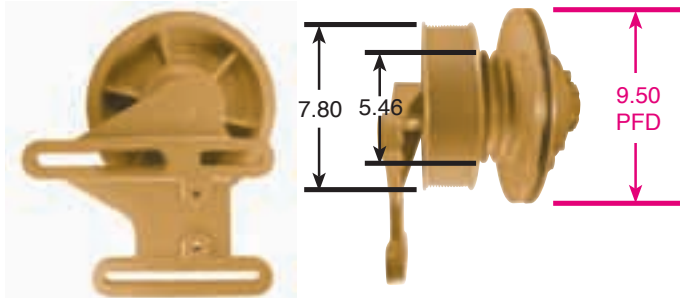

PART NO.

91089

Kit # 9500HP

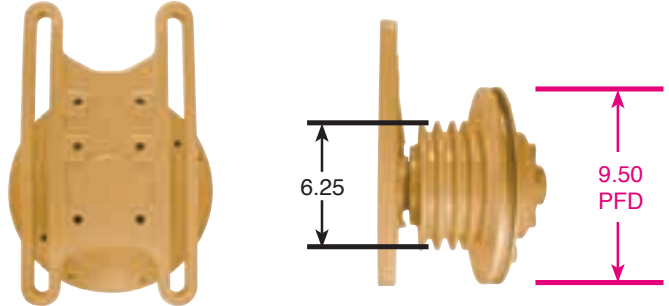

91090

Kit # 9500HP

2" Fan Pilot

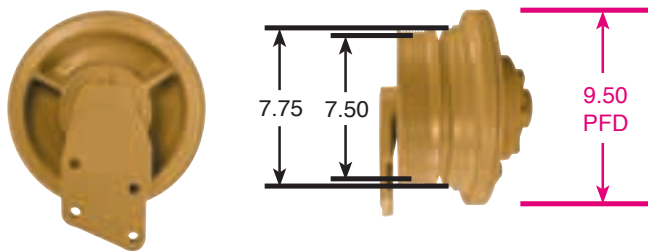

91097

Kit # 9500HP

2" Fan Pilot
Same as 91007

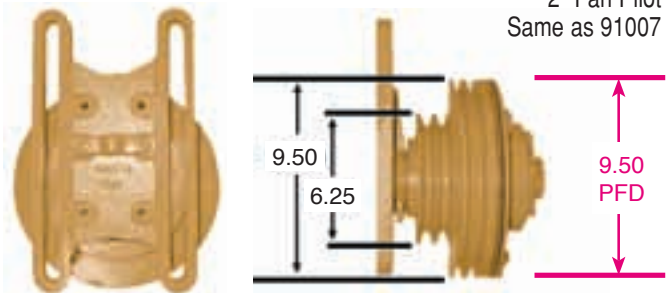

91098

Kit # 9500HP

5" Fan Pilot

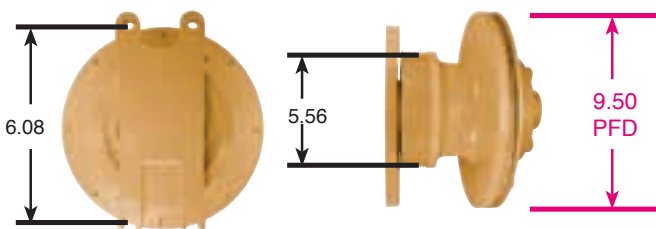

91102

Kit # 9500HP

2.56" Fan Pilot

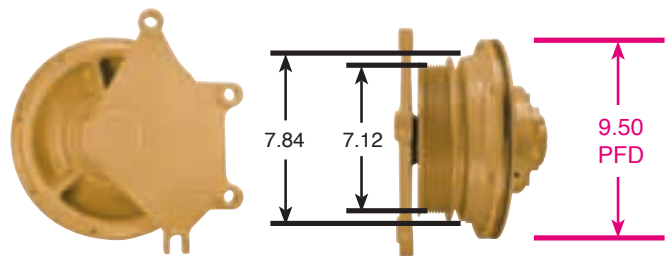

91106

Kit # 9500HP

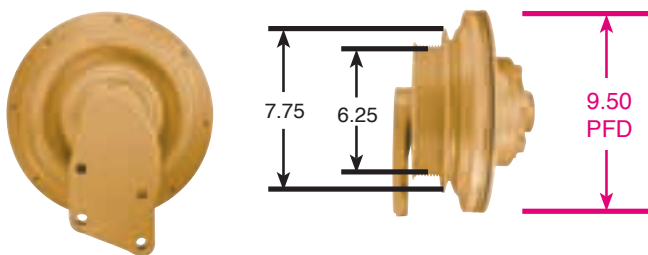

91115

Kit # 9505SP

May use Kit #9500HP

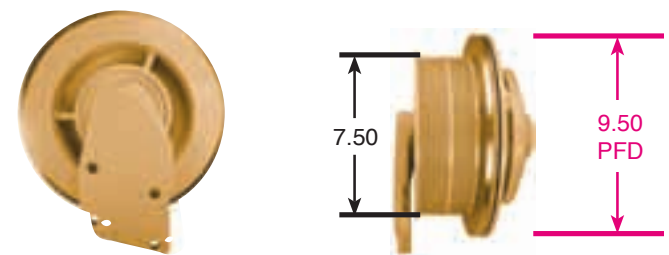

Caterpillar®

PART NO.

91116

Kit # 9500HP

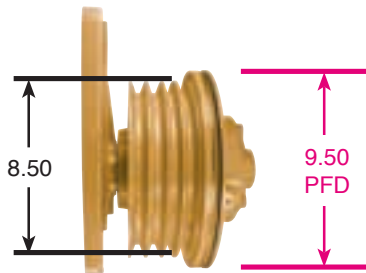
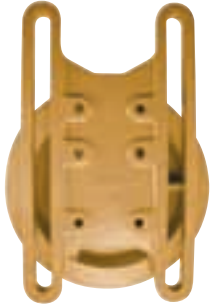

PART NO.

99012

GoldTop

Kit # 14-256

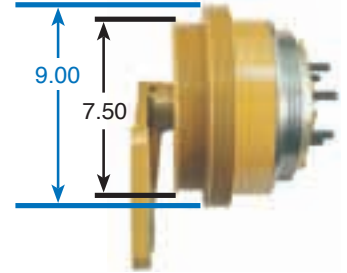

99034

GoldTop

Kit # 14-256

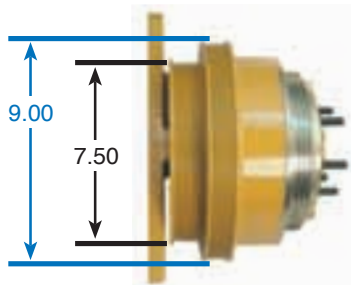

99037

GoldTop

Kit # 14-256

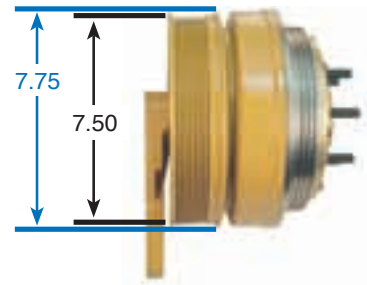

99038

GoldTop

Kit # 14-256

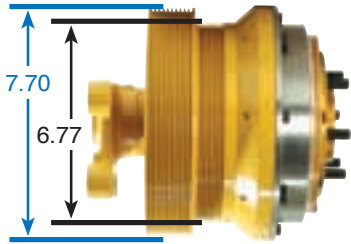

99044

GoldTop

Kit # 14-256

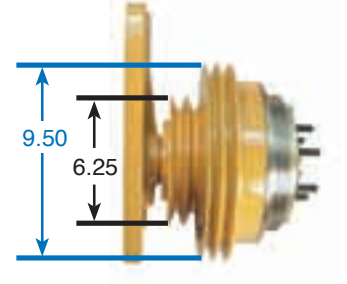

99068

GoldTop

Kit # 14-256

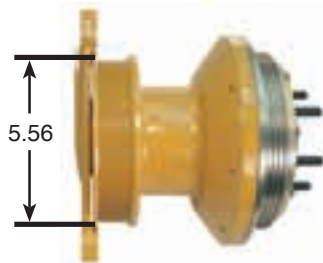

99069

GoldTop

Kit # 14-256

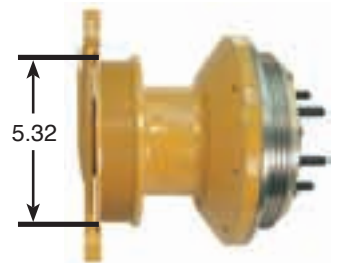

Caterpillar®

PART NO.

99070

GoldTop
by Kit Masters

Kit # 14-256

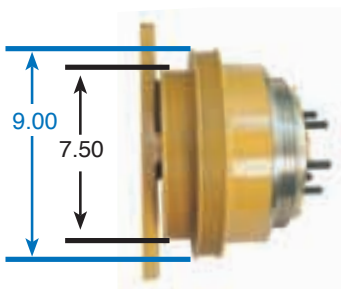

PART NO.

99071

GoldTop
by Kit Masters

Kit # 14-256

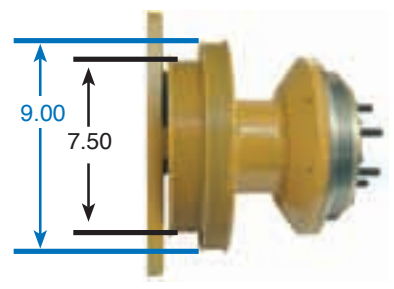

99073

GoldTop
by Kit Masters

Kit # 14-256

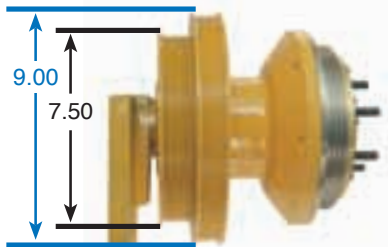

99074

GoldTop
by Kit Masters

Kit # 14-256

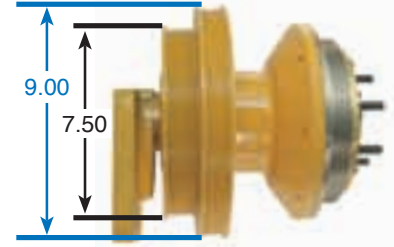

99075

GoldTop
by Kit Masters

Kit # 14-256

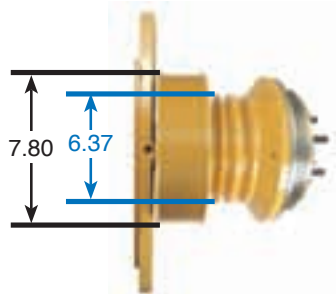

99076

GoldTop
by Kit Masters

Kit # 14-256

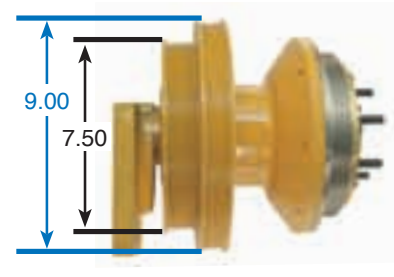

99078

GoldTop
by Kit Masters

Kit # 14-256

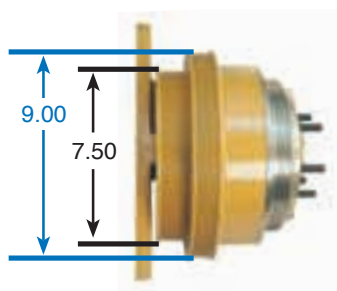

99079

GoldTop
by Kit Masters

Kit # 14-256

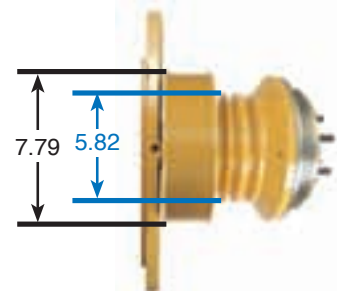

Caterpillar®

PART NO.

99080

Gold^{Top}
by Kit Masters

Kit # 14-256

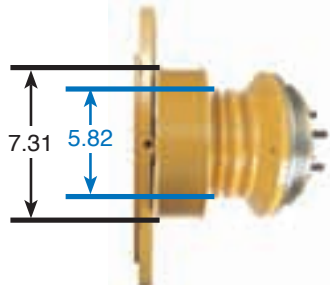

PART NO.

99084

Gold^{Top}
by Kit Masters

Kit # 14-256

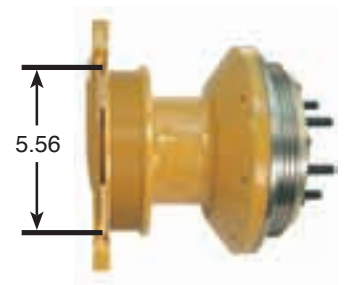

99098

Gold^{Top}
by Kit Masters

Kit # 14-256



99103

Gold^{Top}
by Kit Masters

Kit # 14-256

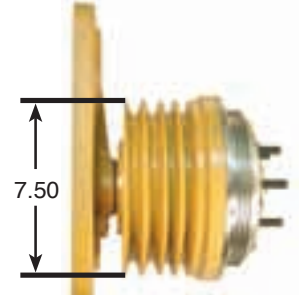

99119

Gold^{Top}
by Kit Masters

Kit # 14-256

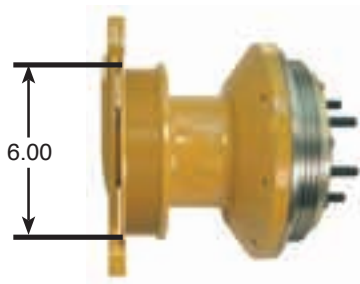

99135

Gold^{Top}
by Kit Masters

Kit # 14-256

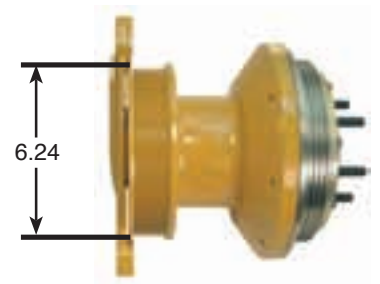

99157

Gold^{Top}
by Kit Masters

Kit # 14-256

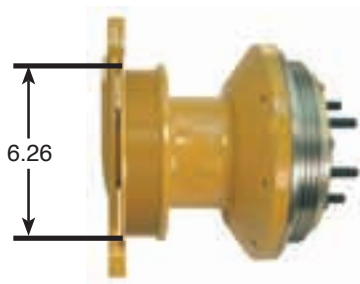

99160

Gold^{Top}
by Kit Masters

Kit # 14-256

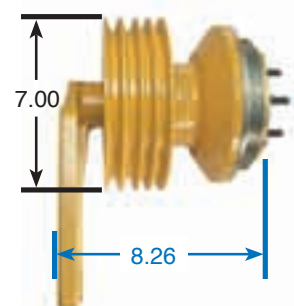

Caterpillar®

PART NO.

99161

GoldTop
by Kit Masters

Kit # 14-256

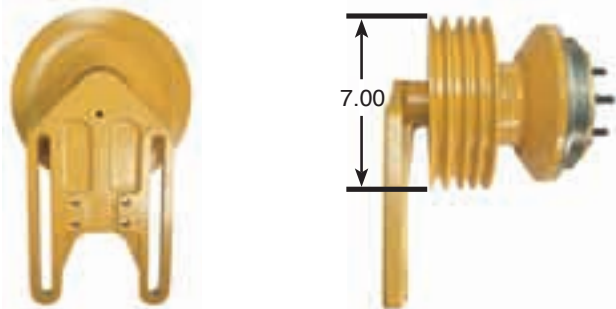

PART NO.

99162

GoldTop
by Kit Masters

Kit # 14-256

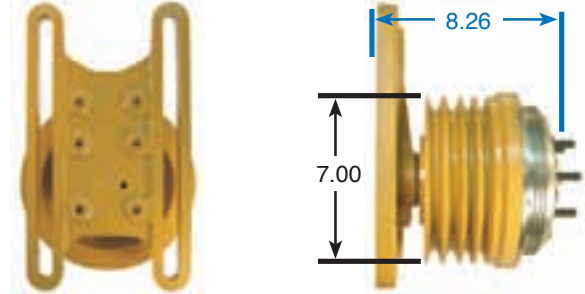

99163

GoldTop
by Kit Masters

Kit # 14-256

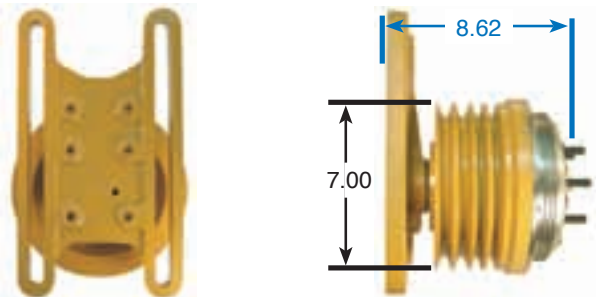

99164

GoldTop
by Kit Masters

Kit # 14-256

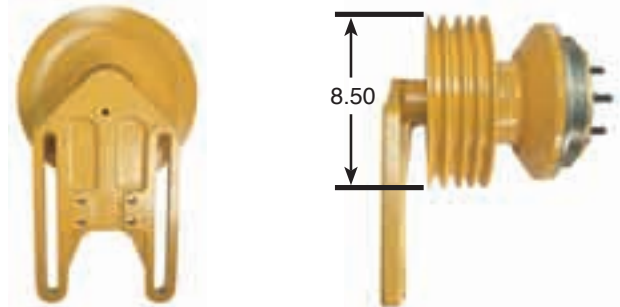

99173

GoldTop
by Kit Masters

Kit # 14-256

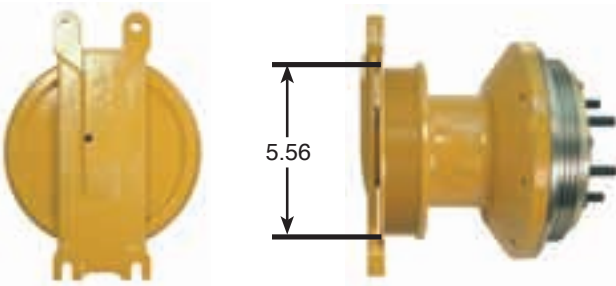

99177

GoldTop
by Kit Masters

Kit # 14-256

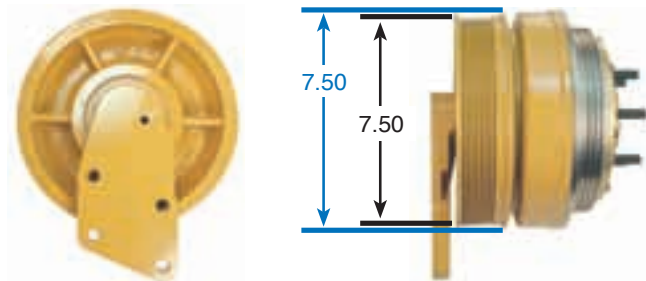

99183

GoldTop
by Kit Masters

Kit # 14-256

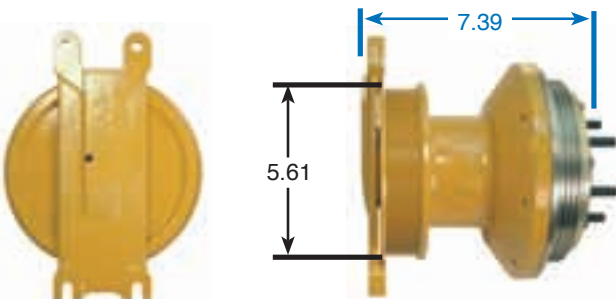

99184

GoldTop
by Kit Masters

Kit # 14-256

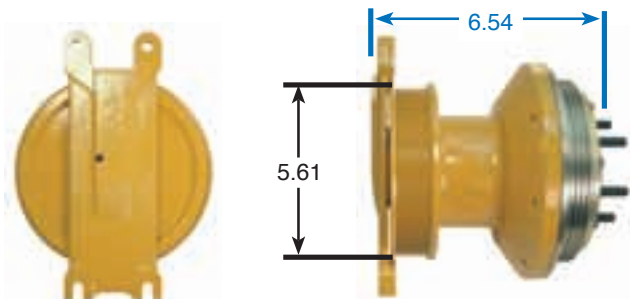

Caterpillar®

PART NO.

99189

Gold Top
by Kit Masters

Kit # 14-256

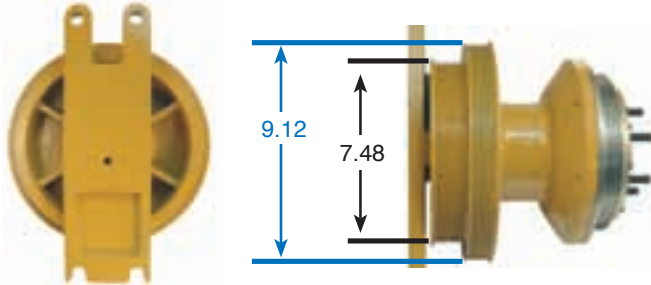

PART NO.

99190

Gold Top
by Kit Masters

Kit # 14-256

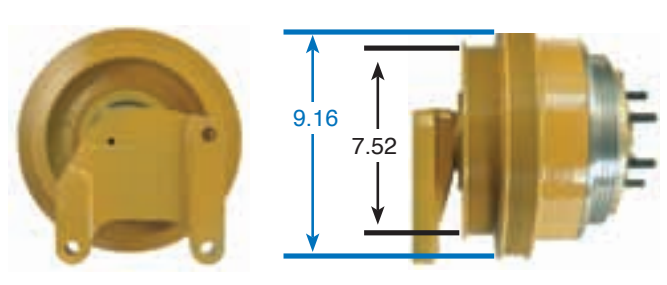

99191

Gold Top
by Kit Masters

Kit # 14-256

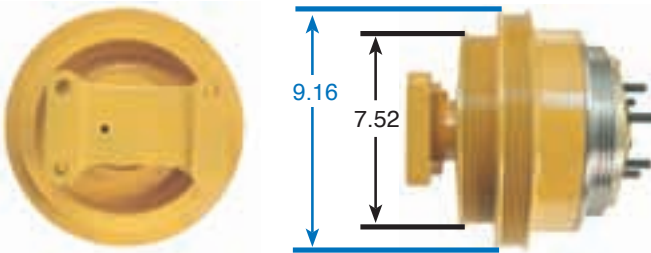

Also use Stud Kit 300SK

99192

Gold Top
by Kit Masters

Kit # 14-256

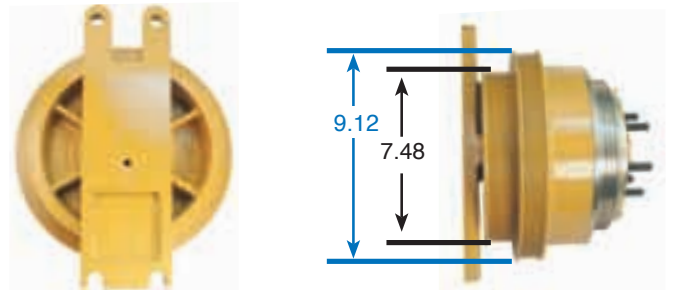

99194

Gold Top
by Kit Masters

Kit # 14-256

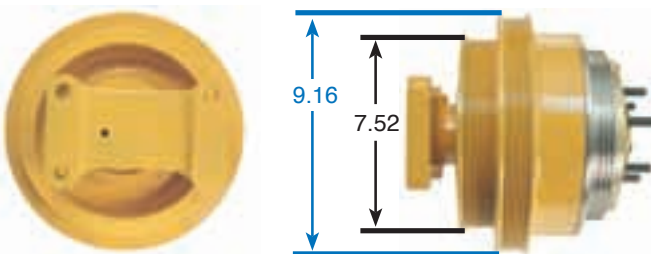

99200

Gold Top
by Kit Masters

Kit # 14-256

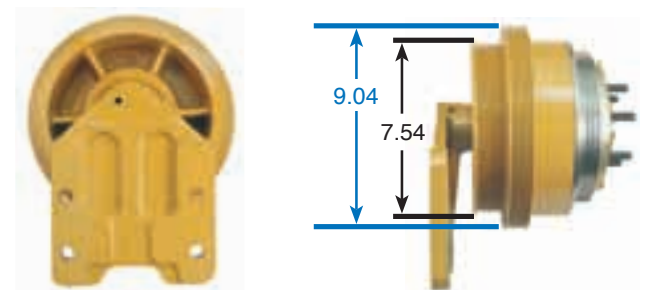

99209

Gold Top
by Kit Masters

Kit # 14-256

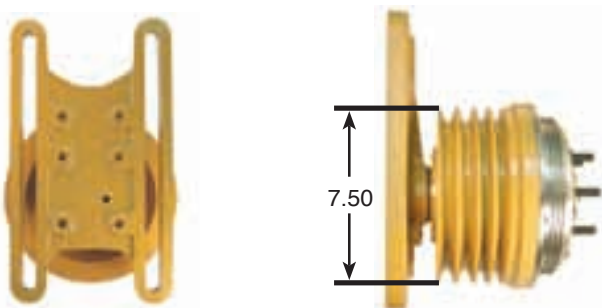

99211

Gold Top
by Kit Masters

Kit # 14-256

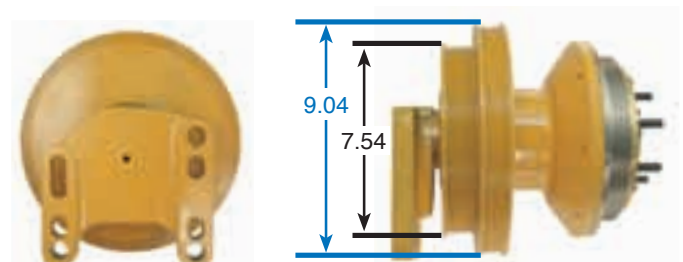

PART NO.

99212

GoldTop
by Kit Masters

Kit # 14-256

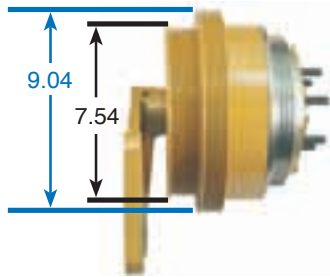

PART NO.

99220

GoldTop
by Kit Masters

Kit # 14-256

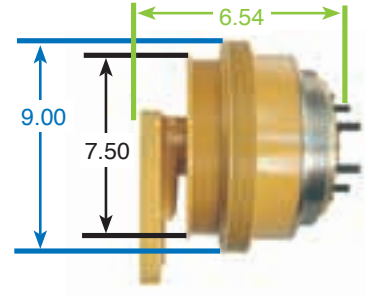

99221

GoldTop
by Kit Masters

Kit # 14-256

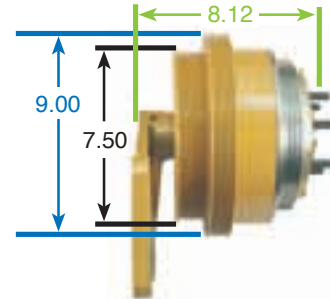

99240

GoldTop
by Kit Masters

Kit # 14-256

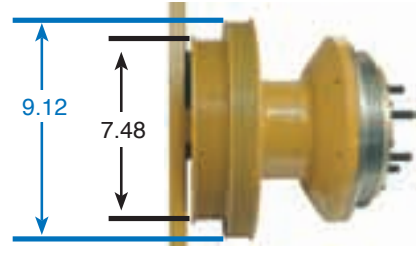
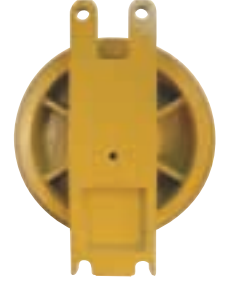

99269

GoldTop
by Kit Masters

Kit # 14-256

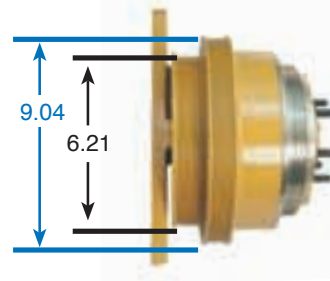

99273

GoldTop
by Kit Masters

Kit # 14-256

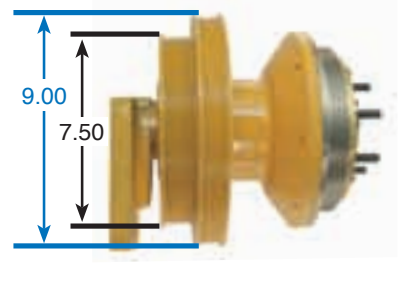

99279

GoldTop
by Kit Masters

Kit # 14-256

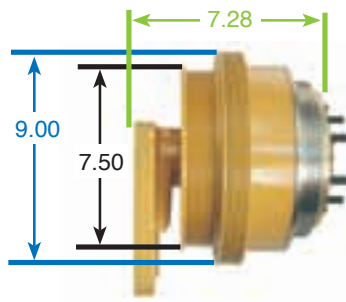

99280

GoldTop
by Kit Masters

Kit # 14-256

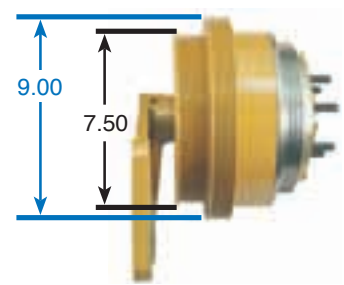

Caterpillar®

PART NO.

99281

GoldTop
by Kit Masters

Kit # 14-256

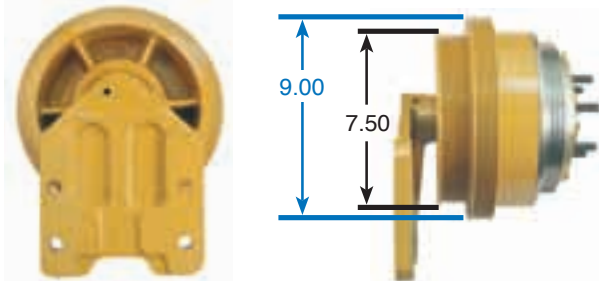

PART NO.

99289

GoldTop
by Kit Masters

Kit # 14-256

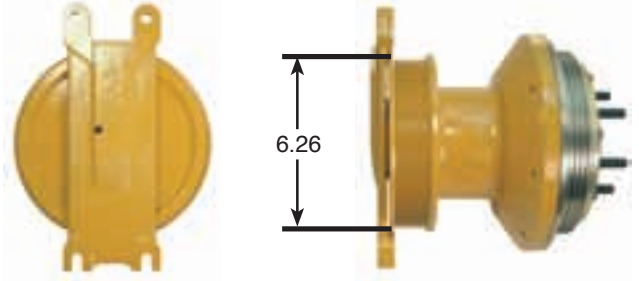

99291

GoldTop
by Kit Masters

Kit # 14-256

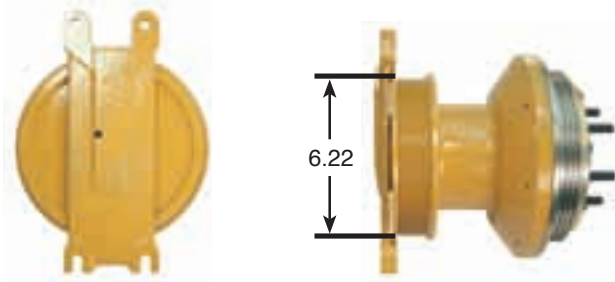

99292

GoldTop
by Kit Masters

Kit # 14-256

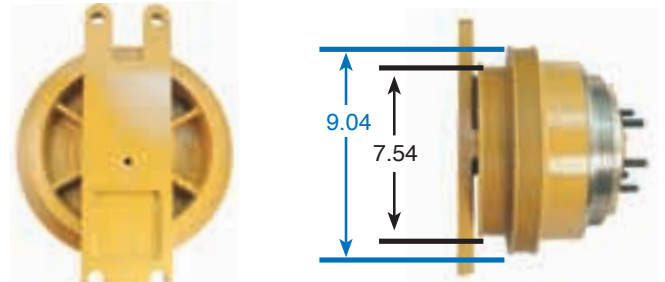

99294

GoldTop
by Kit Masters

Kit # 14-256

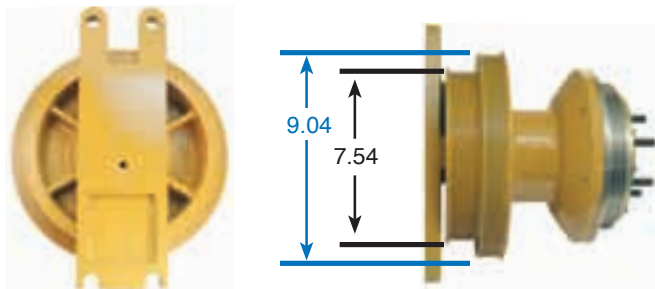

99298

GoldTop
by Kit Masters

Kit # 14-256

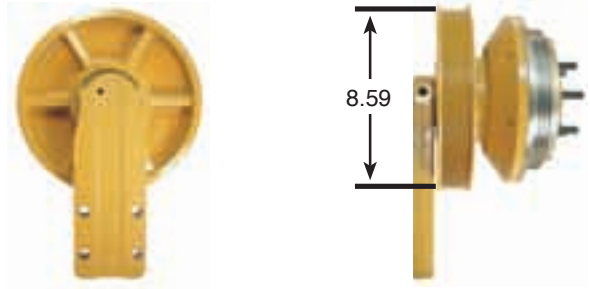

99307

GoldTop
by Kit Masters

Kit # 14-256

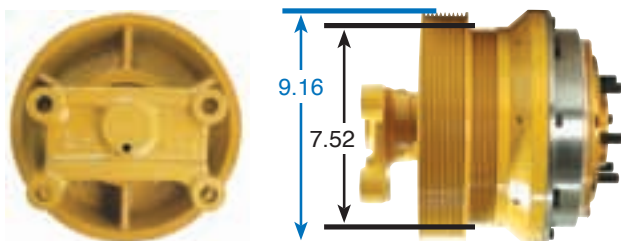

99311

GoldTop
by Kit Masters

Kit # 14-256-1

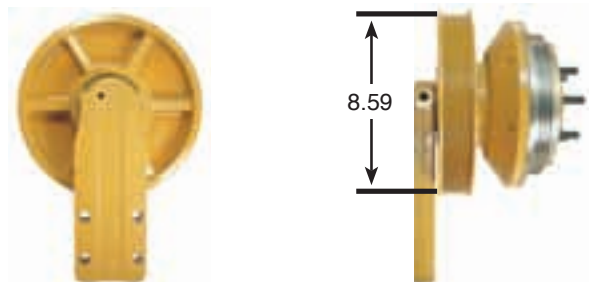

Caterpillar®

PART NO.

99313

GoldTop
by Kit Masters

Kit # 14-256

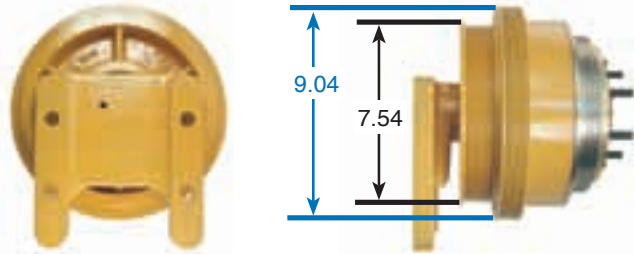

PART NO.

99316

GoldTop
by Kit Masters

Kit # 14-256

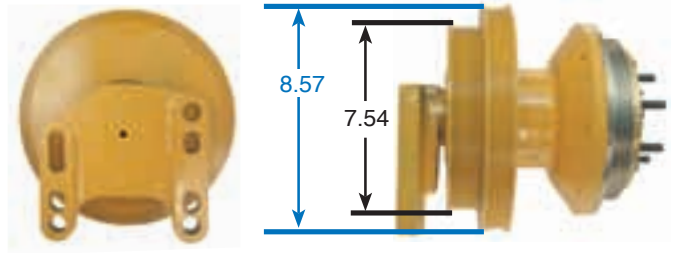

99317

GoldTop
by Kit Masters

Kit # 14-256

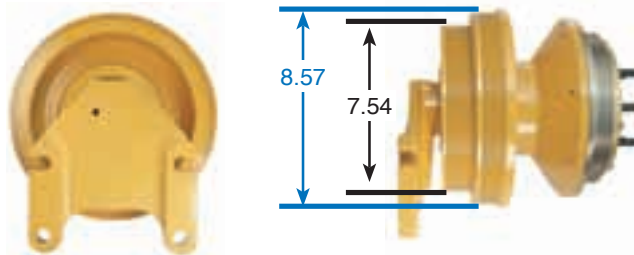

99318

GoldTop
by Kit Masters

Kit # 14-256

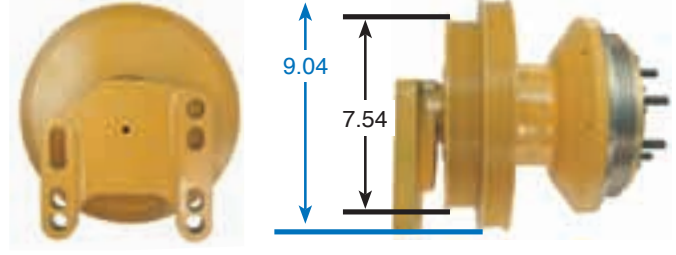

99319

GoldTop
by Kit Masters

Kit # 14-256

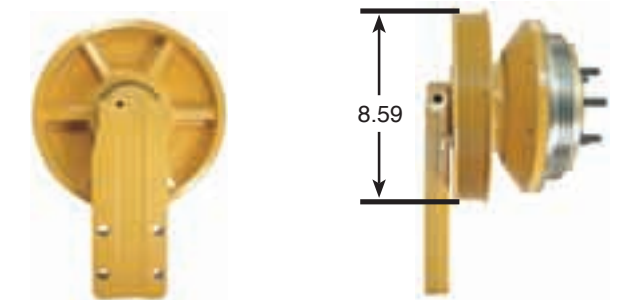

99320

GoldTop
by Kit Masters

Kit # 14-256

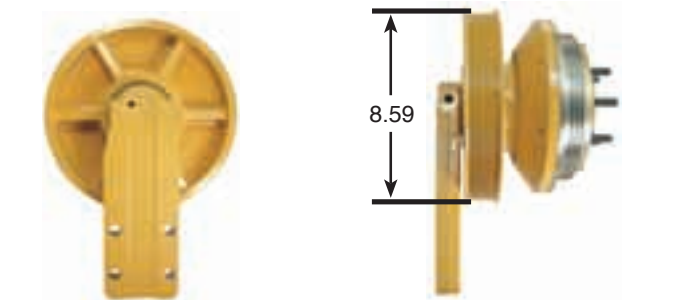

99322

GoldTop
by Kit Masters

Kit # 14-256

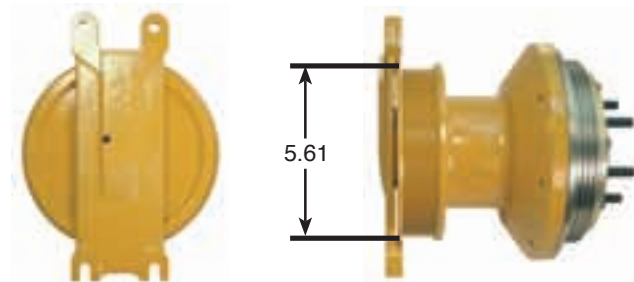

99323

GoldTop
by Kit Masters

Kit # 14-256

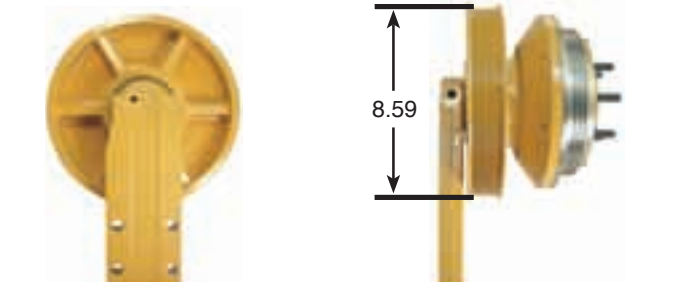

Caterpillar®

PART NO.

99327

Gold Top
by Kit Masters

Kit # 14-256

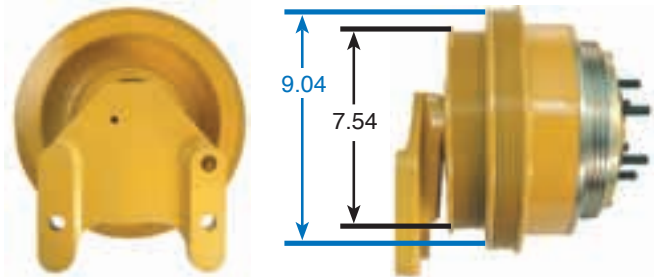

PART NO.

99330

Gold Top
by Kit Masters

Kit # 14-256

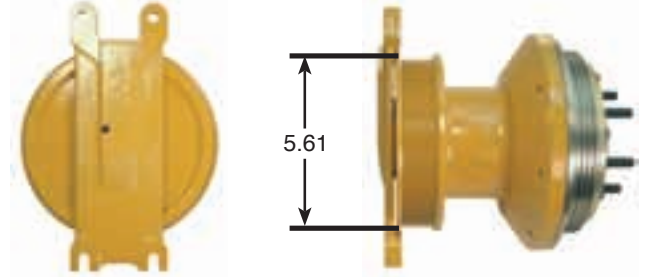

99333

Gold Top
by Kit Masters

Kit # 14-256

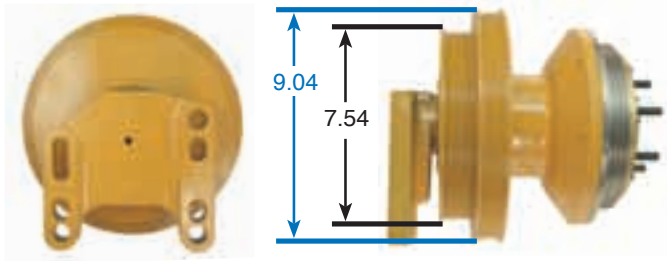

99334

Gold Top
by Kit Masters

Kit # 14-256

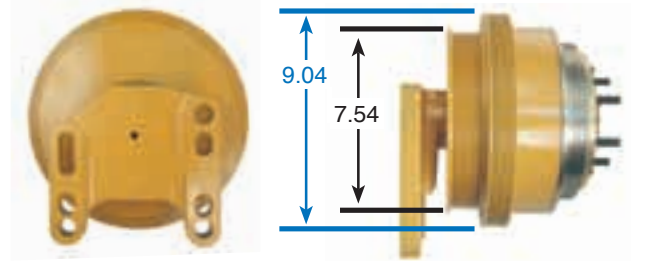

99337

Gold Top
by Kit Masters

Kit # 14-256

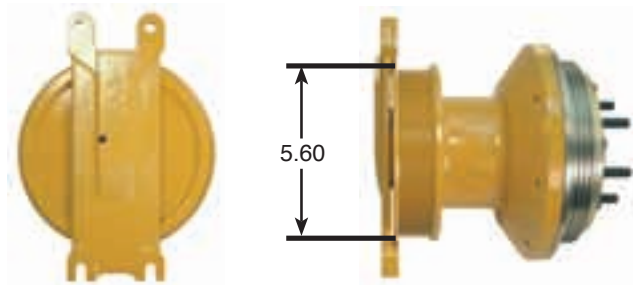

99339

Gold Top
by Kit Masters

Kit # 14-256-1

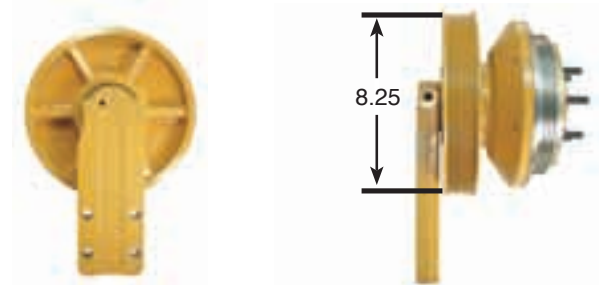

99341

Gold Top
by Kit Masters

Kit # 14-256-1

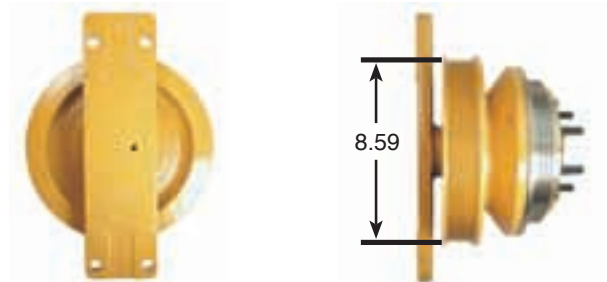

99342

Gold Top
by Kit Masters

Kit # 14-256

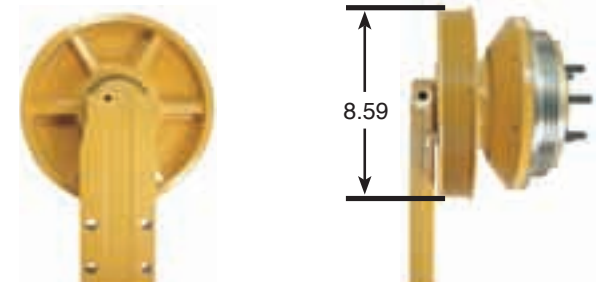

Caterpillar®

PART NO.

99346

GoldTop
by Kit Masters

Kit # 14-256

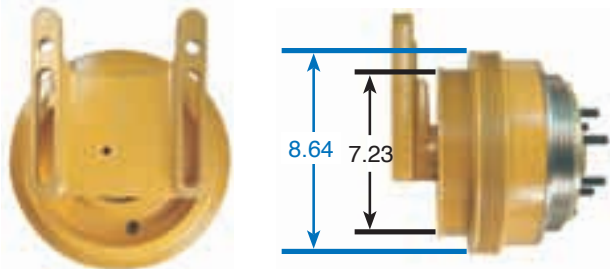

PART NO.

99351

GoldTop
by Kit Masters

Kit # 14-256

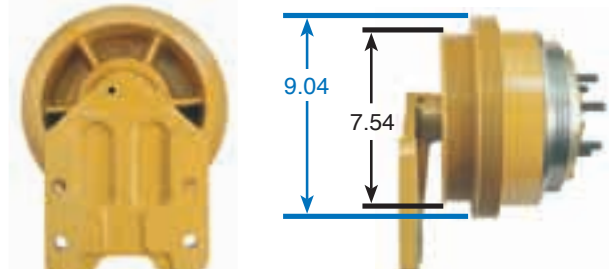

99354

GoldTop
by Kit Masters

Kit # 14-256

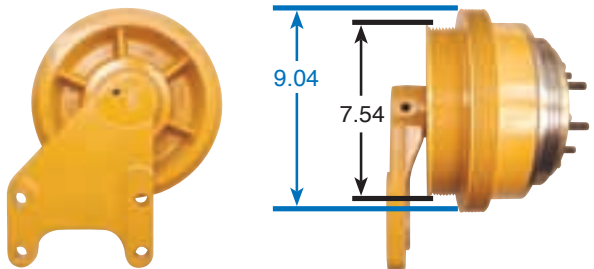

99358

GoldTop
by Kit Masters

Kit # 14-256-1

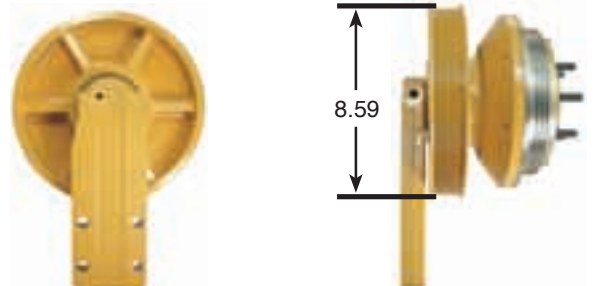

99359

GoldTop
by Kit Masters

Kit # 14-256-1

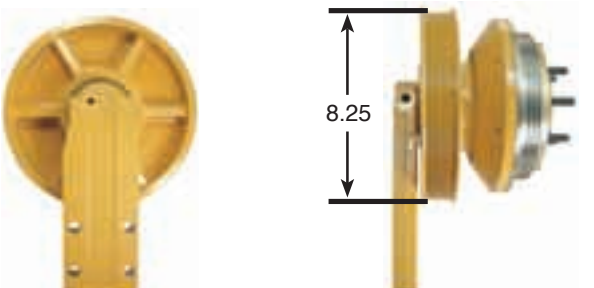

99360

GoldTop
by Kit Masters

Kit # 14-256

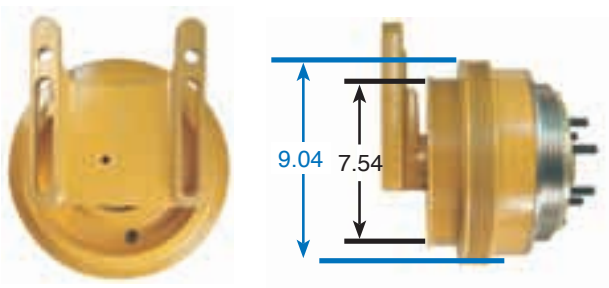

99361

GoldTop
by Kit Masters

Kit # 14-256

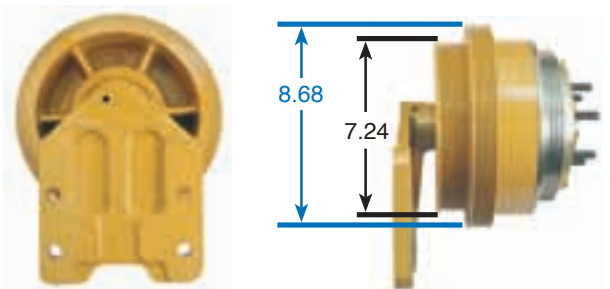

99362

GoldTop
by Kit Masters

Kit # 14-256

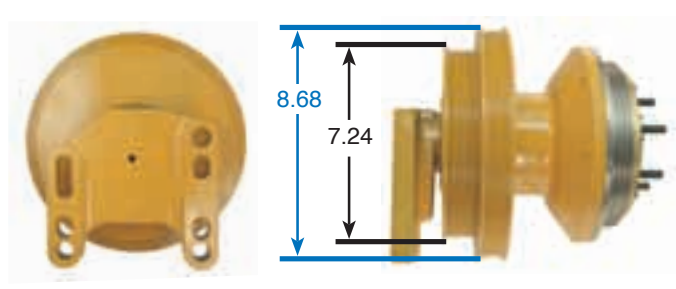

Caterpillar®

PART NO.

99363

Gold Top

Kit # 14-256-1

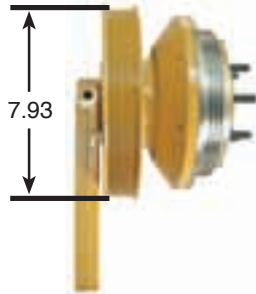

PART NO.

99366

Gold Top

Kit # 14-256-1

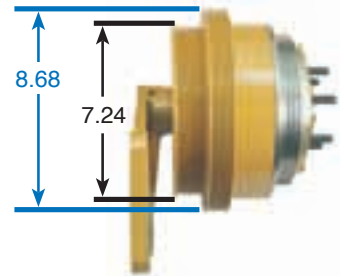

99367

Gold Top

Kit # 14-256-1

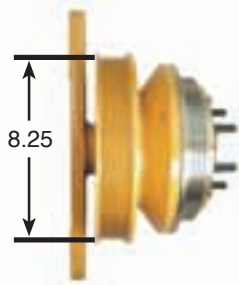

99368

Gold Top

Kit # 14-256-1

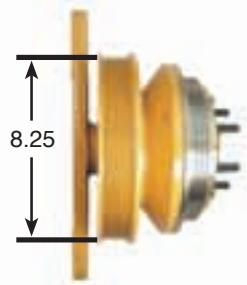

99369

Gold Top

Kit # 14-256

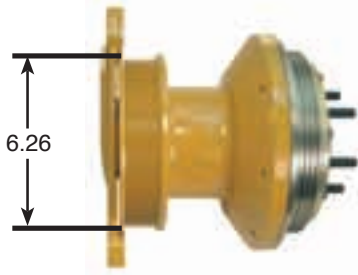

99374

Gold Top

Kit # 14-256

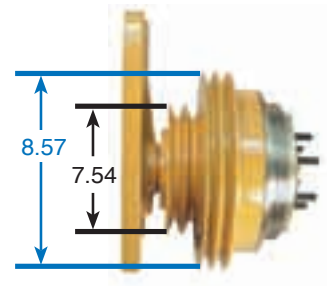

99377

Gold Top

Kit # 14-256

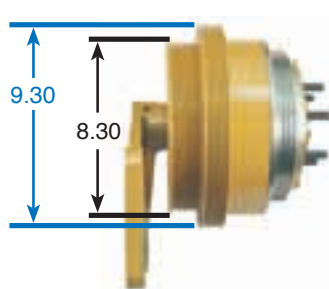

99382

Gold Top

Kit # 14-256

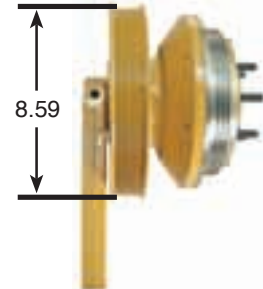

Caterpillar®

PART NO.

99386

GoldTop
by Kit Masters

Kit # 14-256

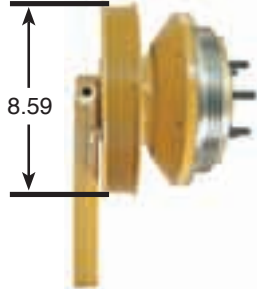

PART NO.

99387

GoldTop
by Kit Masters

Kit # 14-256

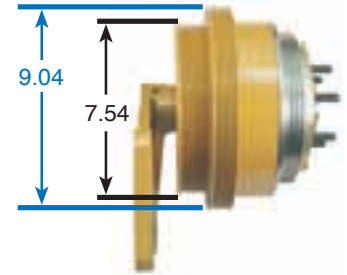

99401

GoldTop
by Kit Masters

Kit # 14-256

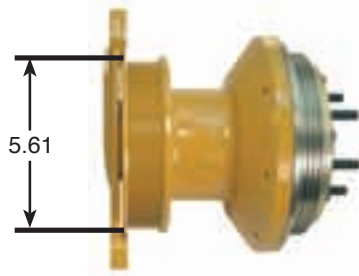

99403

GoldTop
by Kit Masters

Kit # 14-256

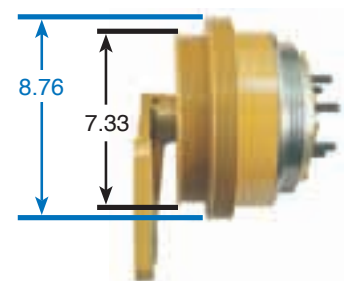

99411

GoldTop
by Kit Masters

Kit # 14-256-1

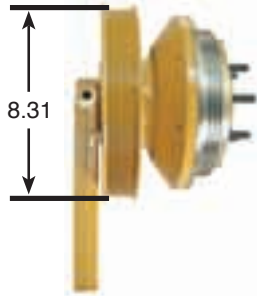

99412

GoldTop
by Kit Masters

Kit # 14-256-1

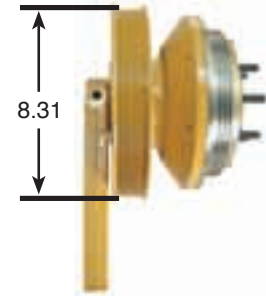

99413

GoldTop
by Kit Masters

Kit # 14-256

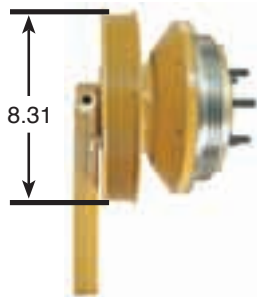

99414

GoldTop
by Kit Masters

Kit # 14-256

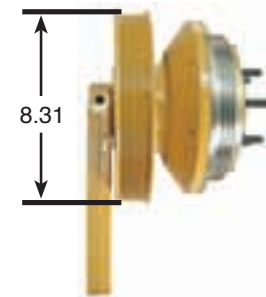

Caterpillar®

PART NO.

99420

GoldTop
by Kit Masters

Kit # 14-256

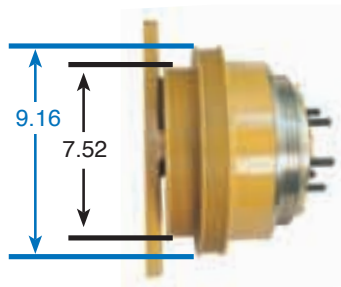

PART NO.

99422

GoldTop
by Kit Masters

Kit # 14-256

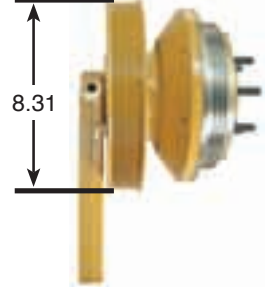

99425

GoldTop
by Kit Masters

Kit # 14-256

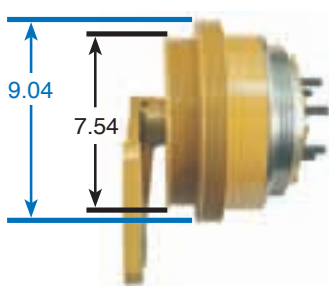

99428

GoldTop
by Kit Masters

Kit # 14-256



99438

GoldTop
by Kit Masters

Kit # 14-256

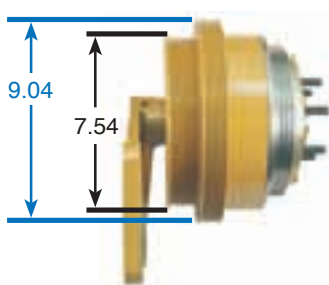

99439

GoldTop
by Kit Masters

Kit # 14-256

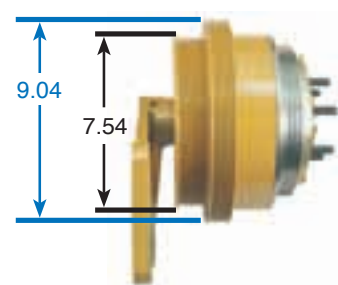

99440

GoldTop
by Kit Masters

Kit # 14-256

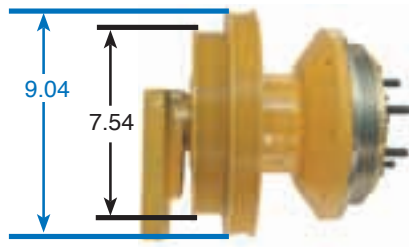

99453

GoldTop
by Kit Masters

Kit # 14-256-1

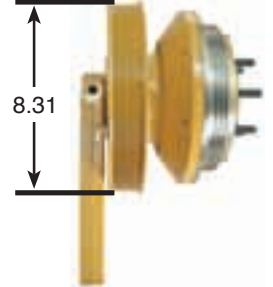

Cummins®

PART NO.

90000

Kit # 7500HP



PART NO.

90001

Kit # 7500HP



90002

Kit # 7500HP



90008

Kit # 7500HP

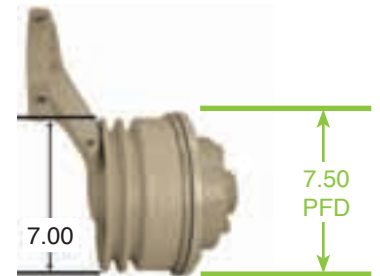

90010

Kit # 7500HP



90012

Kit # 7500HP



90013

Kit # 7500HP



90016

Kit # 7500HP

5" Fan Pilot



PART NO.

90017

Kit # 7500HP

2" Fan Pilot



PART NO.

90021

Kit # 7500HP

5" Fan Pilot



90023

Kit # 7500HP



90024

Kit # 7500HP

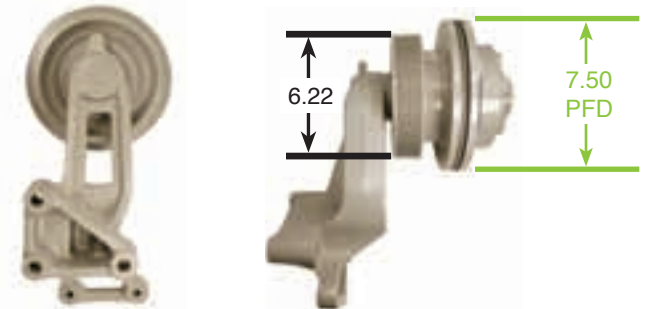

90025

Kit # 7500HP

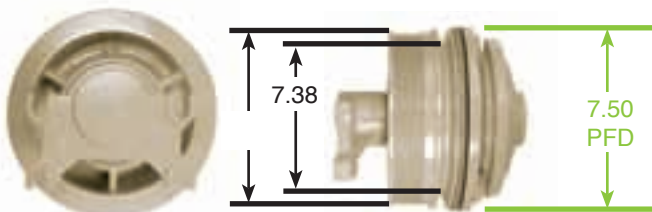

90027

Kit # 7500HP

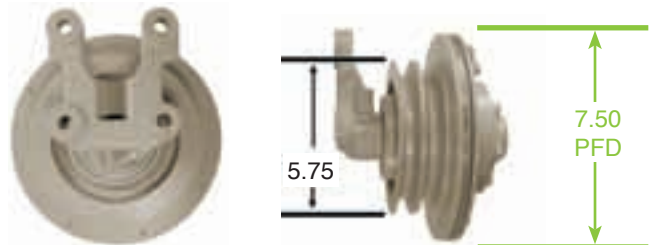

90031

Kit # 7500HP

2" Fan Pilot

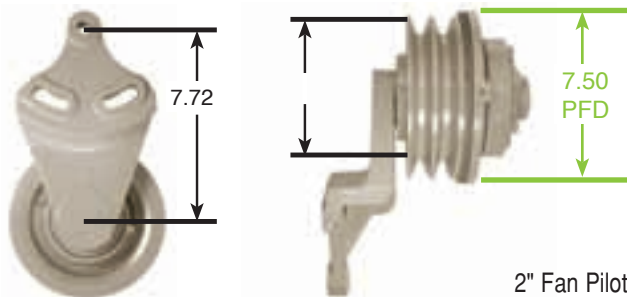

90032

Kit # 7500HP



Cummins®

PART NO.

91000

Kit # 9500HP

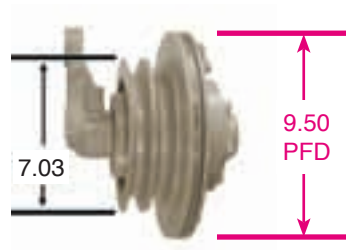

PART NO.

91001

Kit # 9500HP

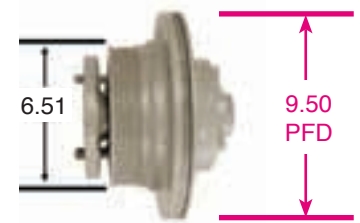

91004

Kit # 9500HP

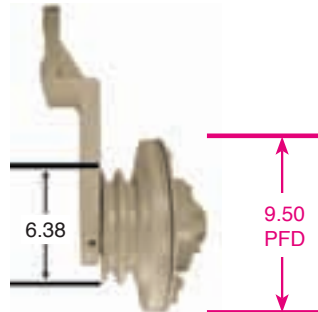

91006

Kit # 9500HP

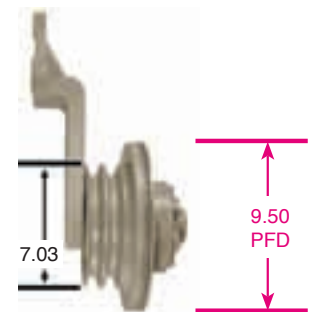

91009

Kit # 9500HP

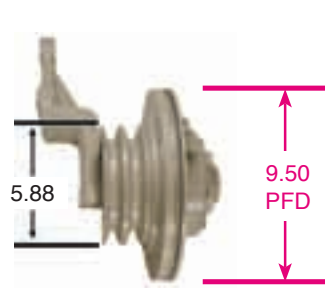
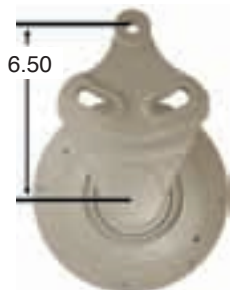

91010

Kit # 9500HP

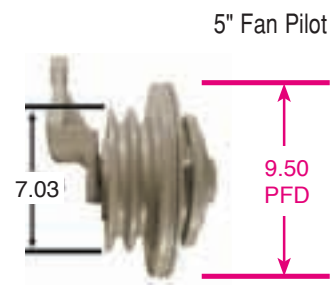

91016

Kit # 9500HP

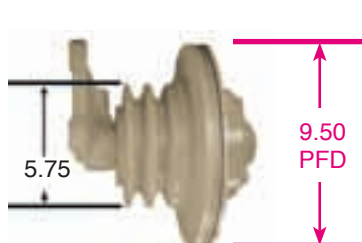

91018

Kit # 9500HP

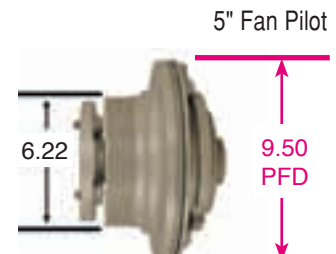

PART NO.

91019

Kit # 9500HP

5" Fan Pilot

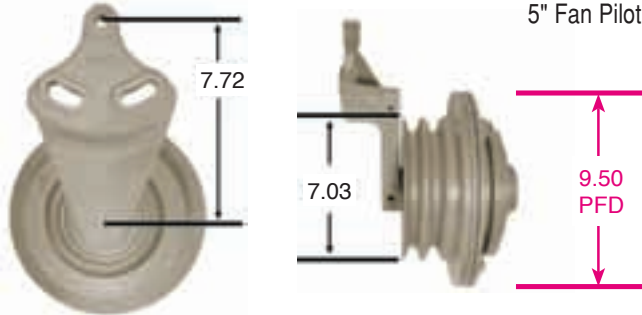

PART NO.

91021

Kit # 9500HP

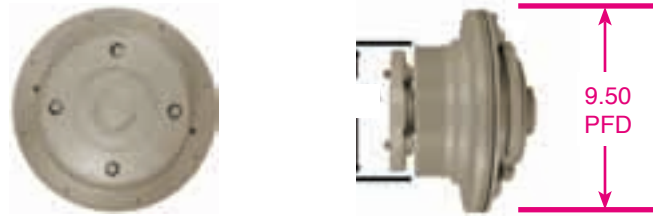

91022

Kit # 9500HP

5" Fan Pilot

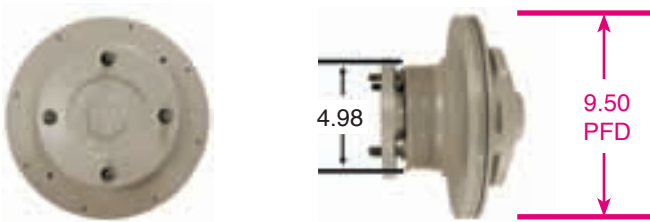

91026

Kit # 9500HP

2" Fan Pilot

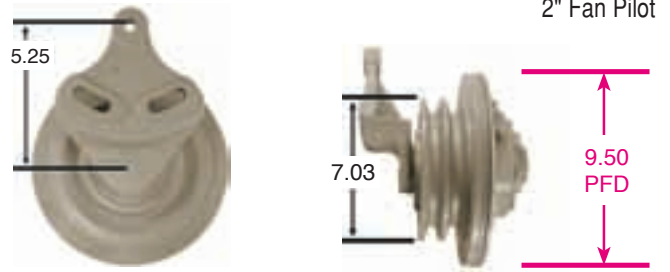

91029

Kit # 9500HP

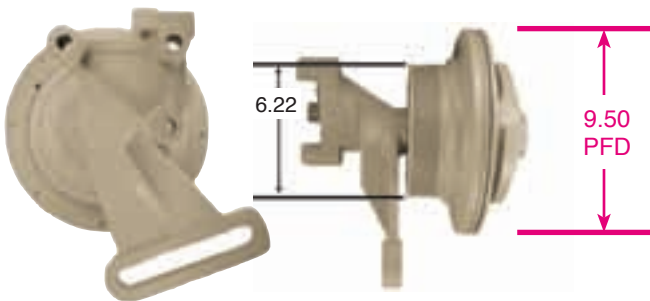

91030

Kit # 9500HP

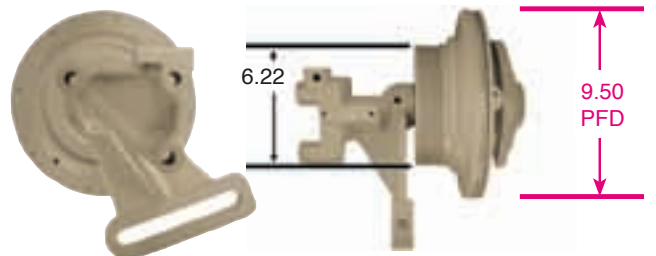

91032

Kit # 9500HP

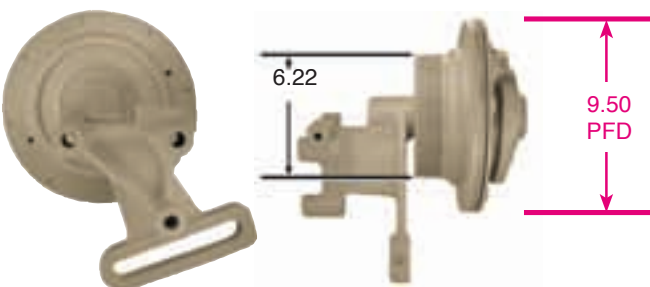

91034

Kit # 9500HP

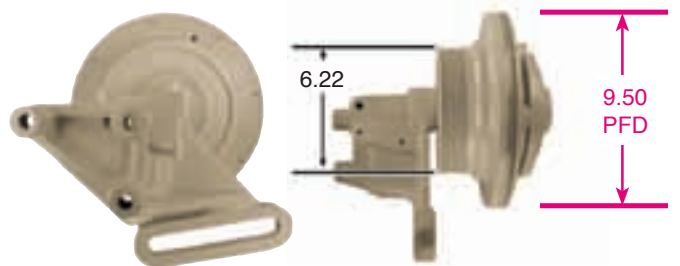

Cummins®

PART NO.

91036

Kit # 9500HP

2" Fan Pilot



PART NO.

91044

Kit # 9500HP

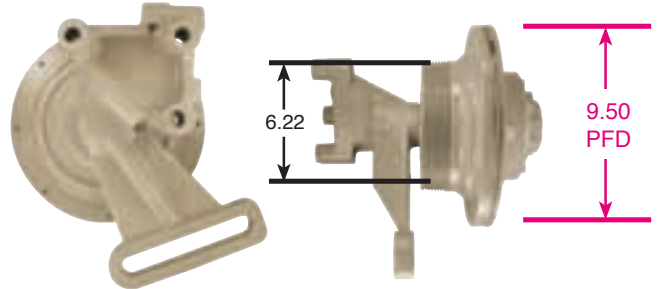

91045

Kit # 9500HP

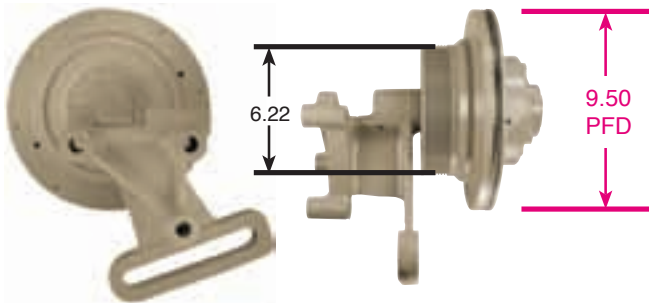

91054

Kit # 9500HP

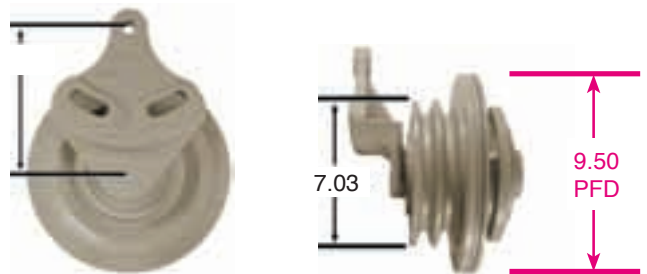

91055

Kit # 9500HP

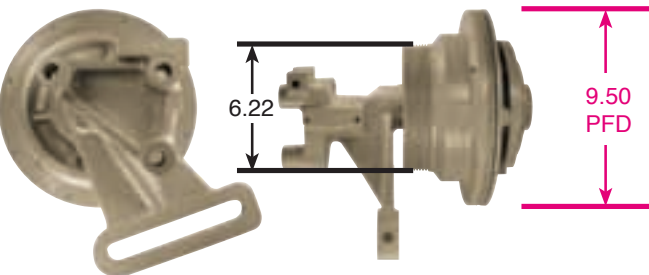

91056

Kit # 9500HP

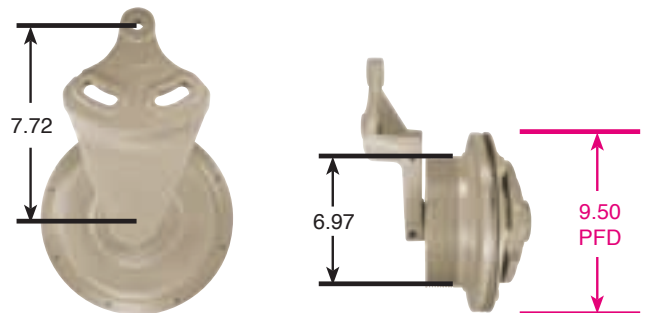

91058

Kit # 9500HP

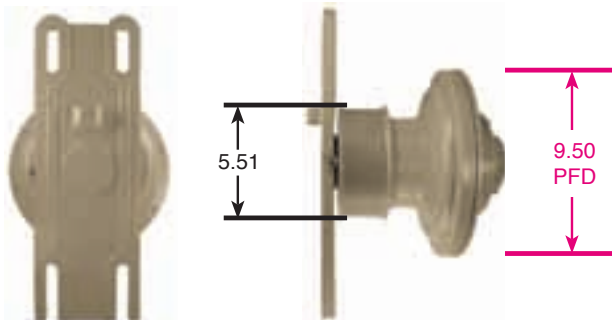

91061

Kit # 9500HP

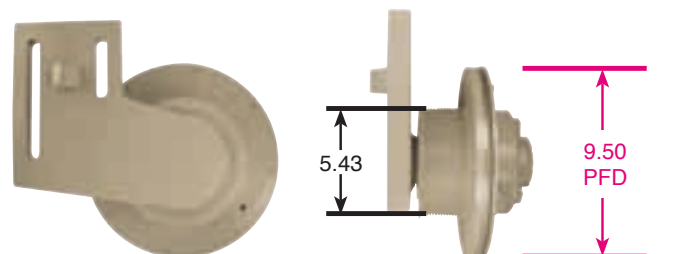

PART NO.

91064

Kit # 9500HP

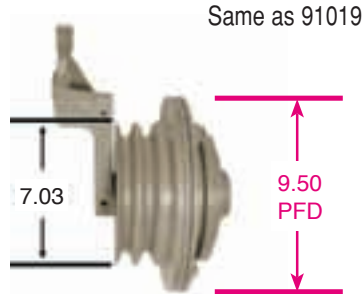

PART NO.

91072

Kit # 9500HP

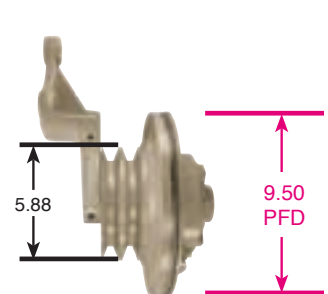

91073

Kit # 9500HP

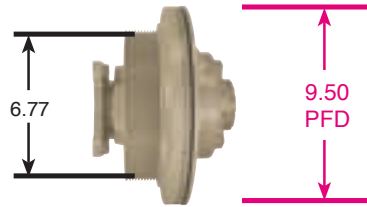

91074

Kit # 9500HP

2" Fan Pilot



91075

Kit # 9500HP

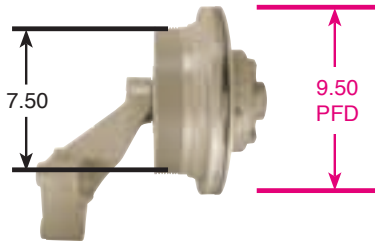

91078

Kit # 9500HP

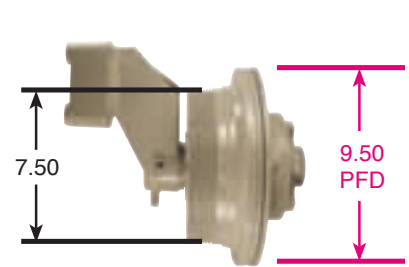

91079

Kit # 9500HP

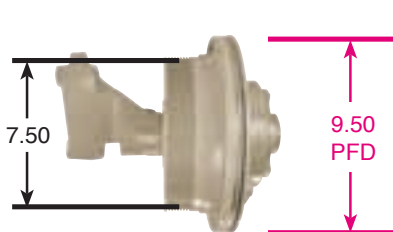

91080

Kit # 9500HP

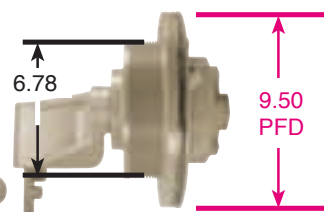

Cummins®

PART NO.

91086

Kit # 9500HP

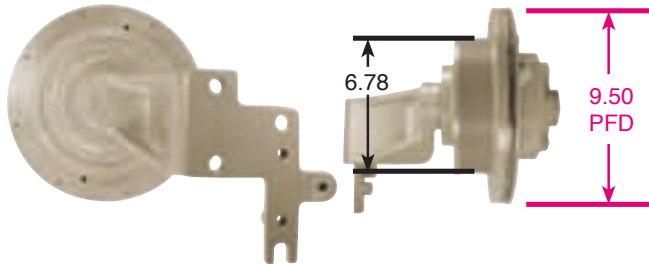

PART NO.

91088

Kit # 9500HP

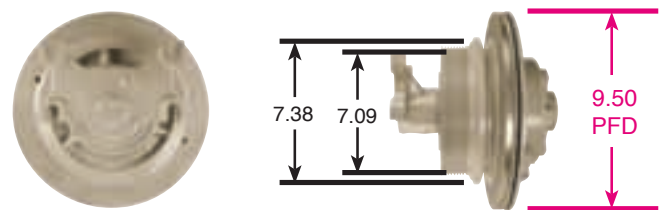

91092

Kit # 9500HP

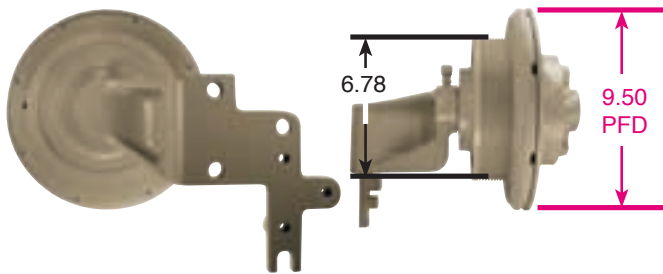

91093

Kit # 9504HP

Special Bearing Kit

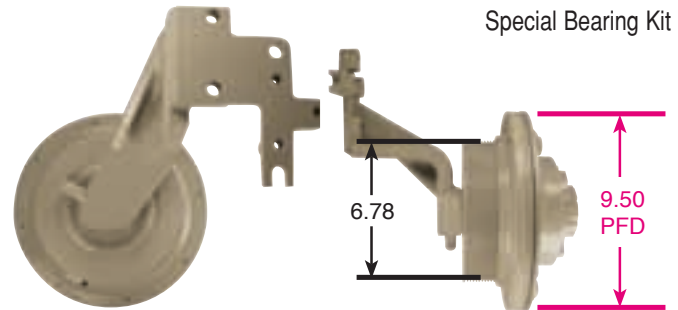

91094

Kit # 9500HP

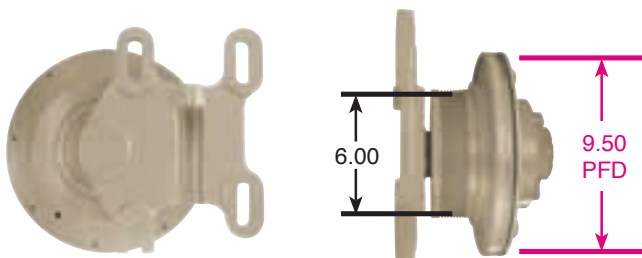

91095

Kit # 9500HP

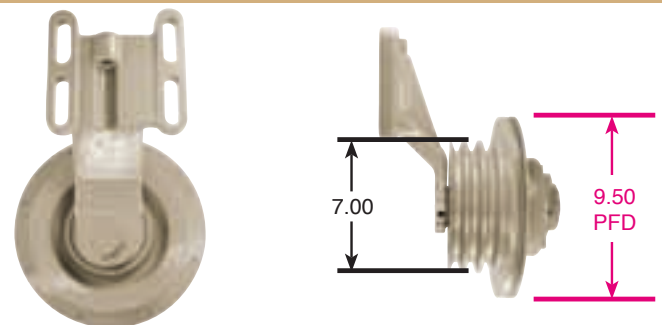

91096

Kit # 9500HP

Same as 91072

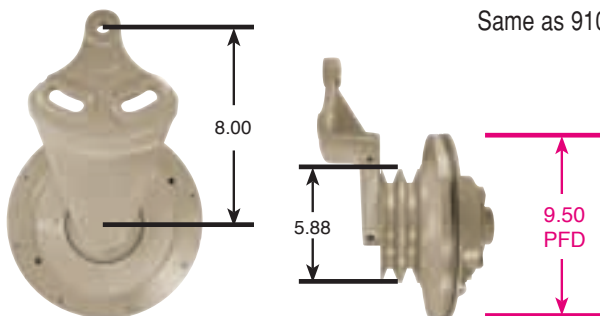

91099

Kit # 9500HP

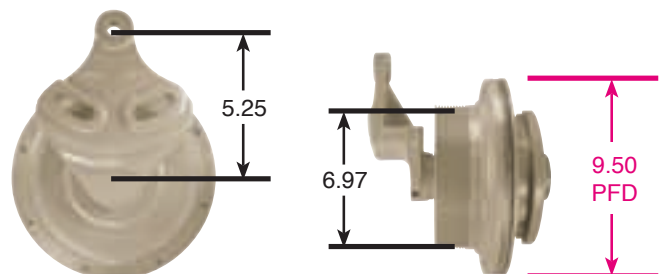

PART NO.

91100

Kit # 9500HP

5" Fan Pilot

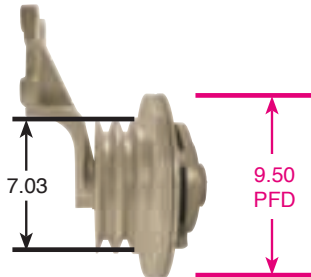

PART NO.

91101

Kit # 9500HP

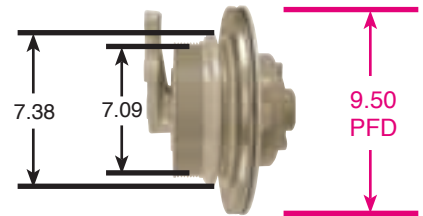

91103

Kit # 9500HP

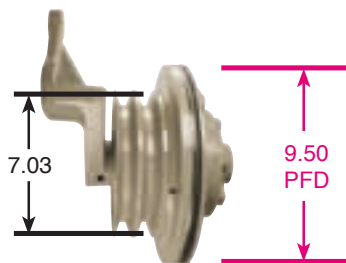

91104

Kit # 9500HP

2" Fan Pilot

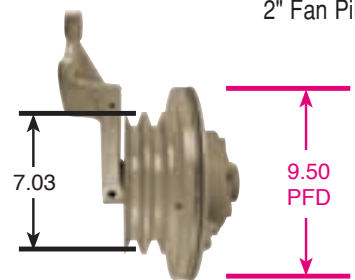

91108

Kit # 9500HP

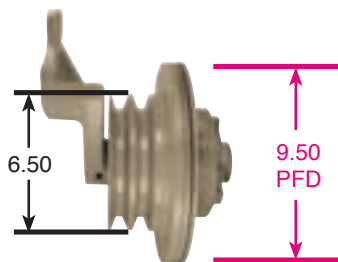
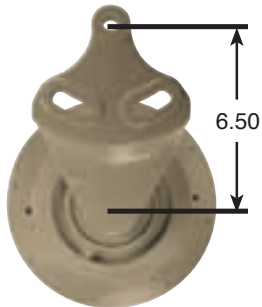

91109

Kit # 9500HP

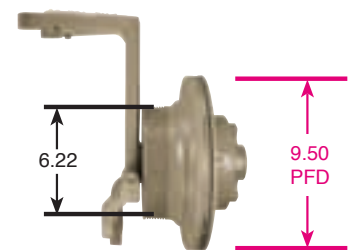

91110

Kit # 9500HP

2" Fan Pilot

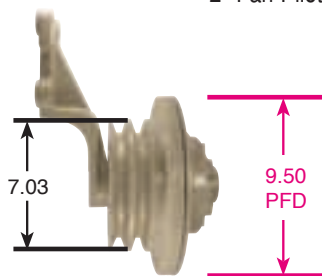

91111

Kit # 9500HP

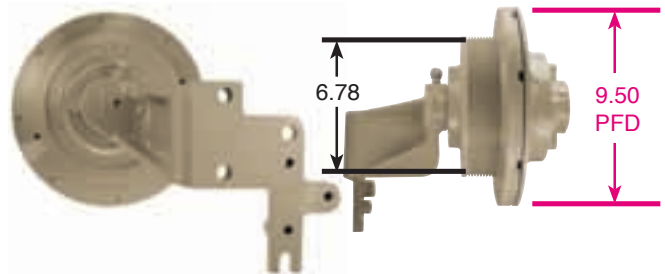

Cummins®

PART NO.

91112

Kit # 9500HP

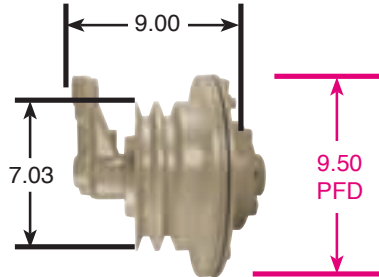

PART NO.

91113

Kit # 9500HP

Same as 91009

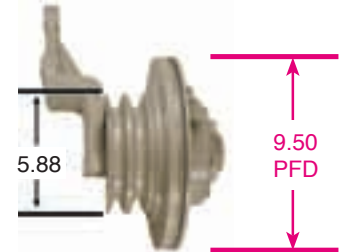

99002

Gold^{Top}
by Kit Masters

Kit # 14-256

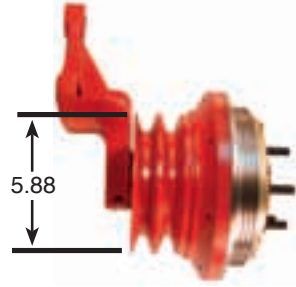

99004

Gold^{Top}
by Kit Masters

Kit # 14-256



99005

Gold^{Top}
by Kit Masters

Kit # 14-256

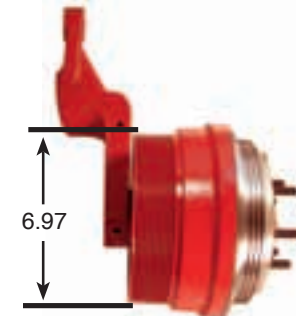

99010

Gold^{Top}
by Kit Masters

Kit # 14-256-1

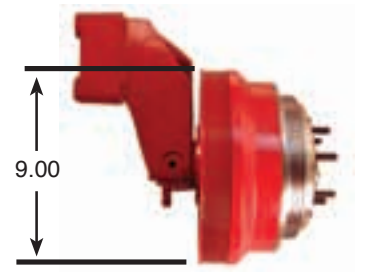

99011

Gold^{Top}
by Kit Masters

Kit # 14-256-1

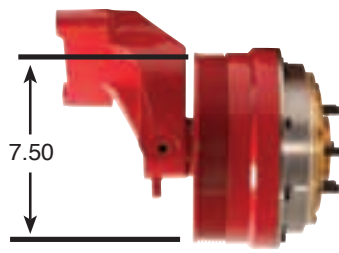

99014

Gold^{Top}
by Kit Masters

Kit # 14-256



Cummins®

PART NO.

99015

GoldTop
by Kit Masters

Kit # 14-256

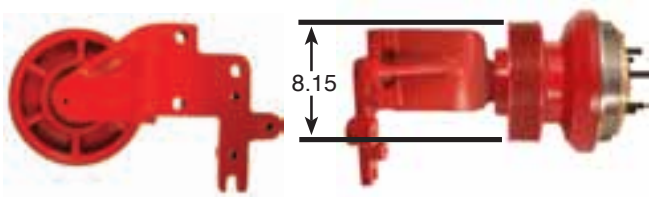

PART NO.

99025

GoldTop
by Kit Masters

Kit # 14-200

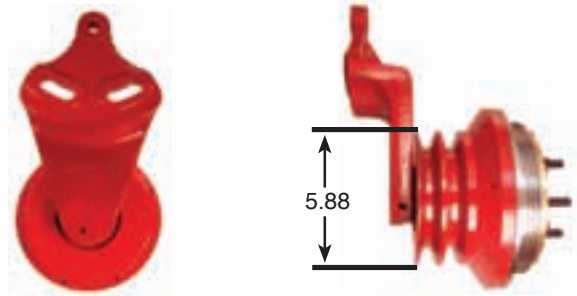

99026

GoldTop
by Kit Masters

Kit # 14-256

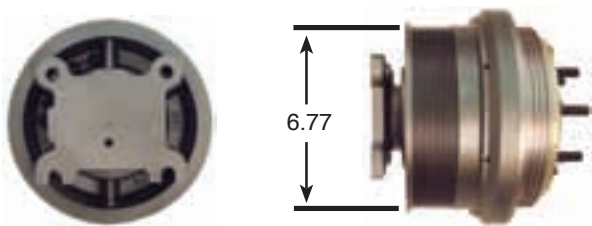

99030

GoldTop
by Kit Masters

Kit # 14-256-1

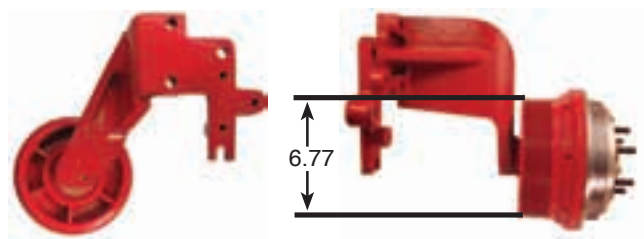

99035

GoldTop
by Kit Masters

Kit # 14-256

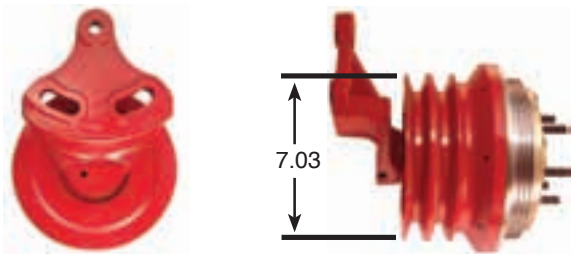

99036

GoldTop
by Kit Masters

Kit # 14-256

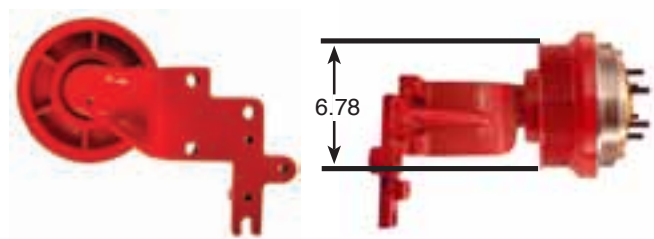

99040

GoldTop
by Kit Masters

Kit # 14-256

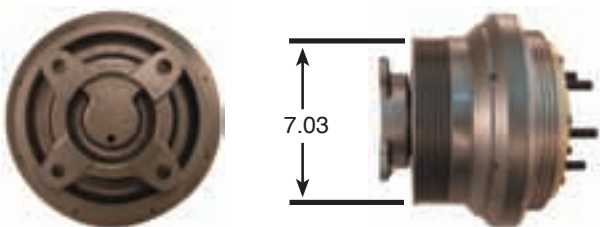

99047

GoldTop
by Kit Masters

Kit # 14-256

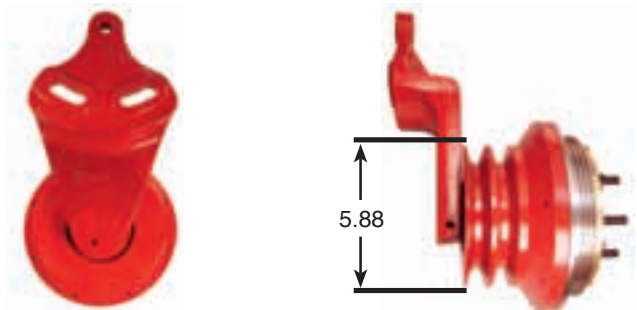

Cummins®

PART NO.

99050

Gold  Top
by Kit Masters

Kit # 14-256

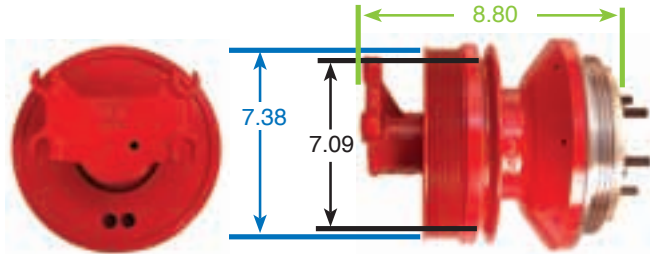

PART NO.

99051

Gold  Top
by Kit Masters

Kit # 14-256

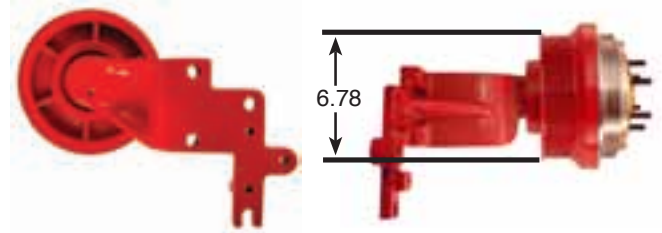

99052

Gold  Top
by Kit Masters

Kit # 14-256

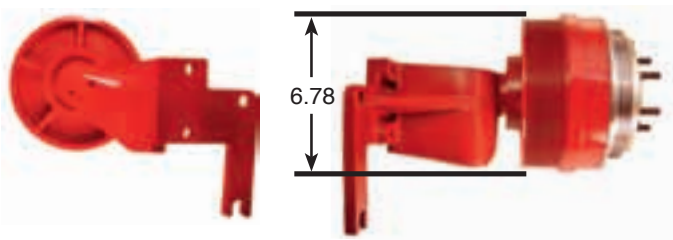

99053

Gold  Top
by Kit Masters

Kit # 14-256

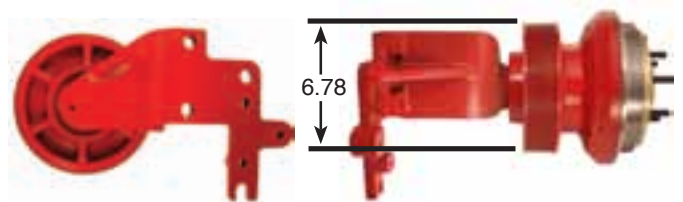

99054

Gold  Top
by Kit Masters

Kit # 14-256

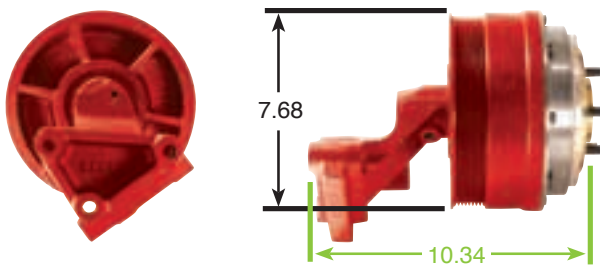

99055

Gold  Top
by Kit Masters

Kit # 14-256

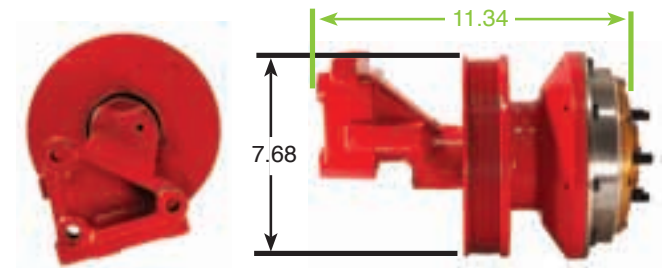

99056

Gold  Top
by Kit Masters

Kit # 14-256

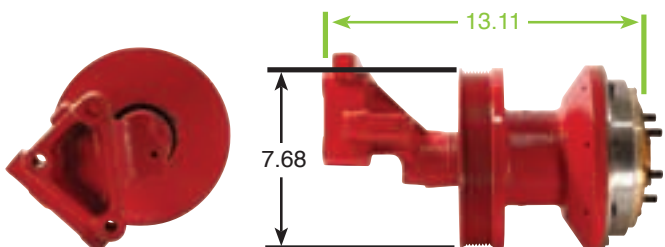

99057

Gold  Top
by Kit Masters

Kit # 14-256

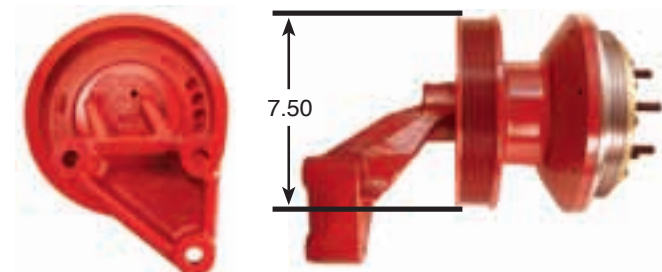

PART NO.

99059

GoldTop
by Kit Masters

Kit # 14-256

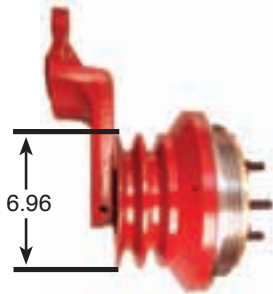

PART NO.

99060

GoldTop
by Kit Masters

Kit # 14-256

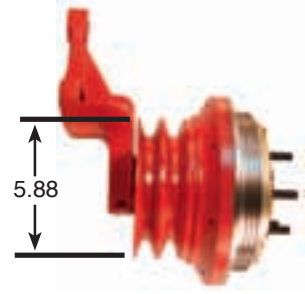

99081

GoldTop
by Kit Masters

Kit # 14-256

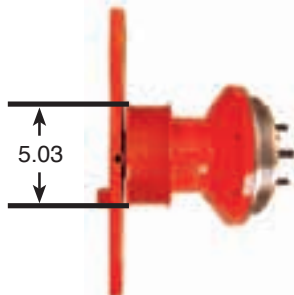

99082

GoldTop
by Kit Masters

Kit # 14-256

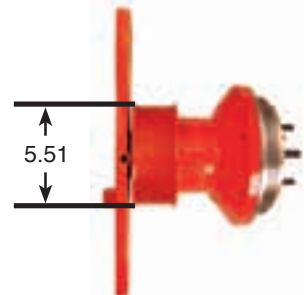

99088

GoldTop
by Kit Masters

Kit # 14-256

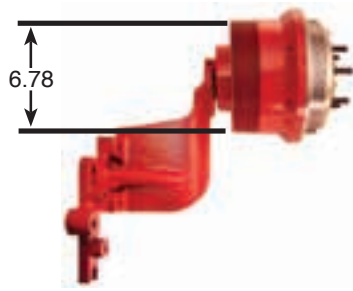

99090

GoldTop
by Kit Masters

Kit # 14-256

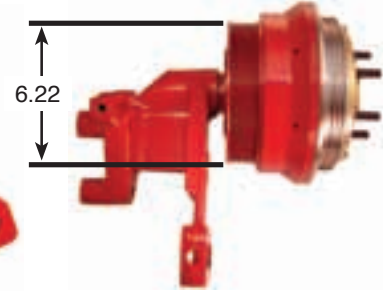

99094

GoldTop
by Kit Masters

Kit # 14-256

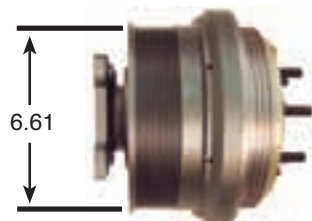

99095

GoldTop
by Kit Masters

Kit # 14-256

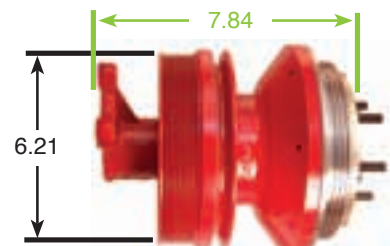

Cummins®

PART NO.

99097

Gold^{Top}
by Kit Masters

Kit # 14-256

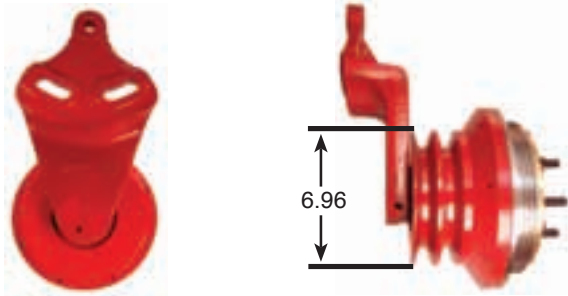

PART NO.

99099

Gold^{Top}
by Kit Masters

Kit # 14-256

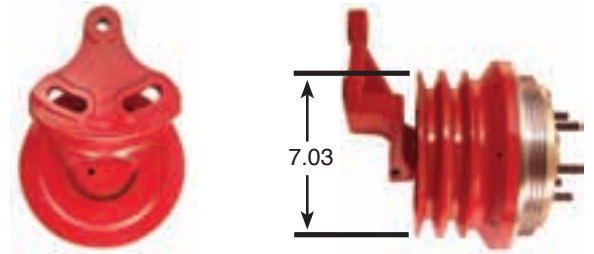

99101

Gold^{Top}
by Kit Masters

Kit # 14-256

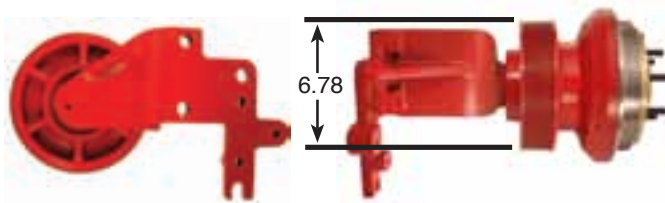

99104

Gold^{Top}
by Kit Masters

Kit # 14-256

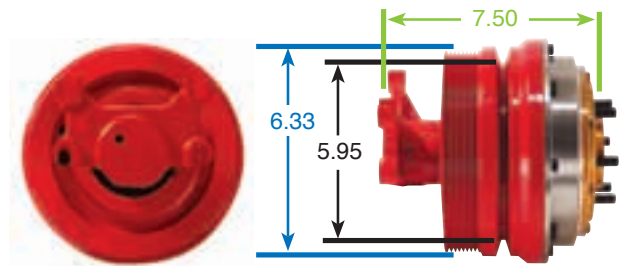

99110

Gold^{Top}
by Kit Masters

Kit # 14-256

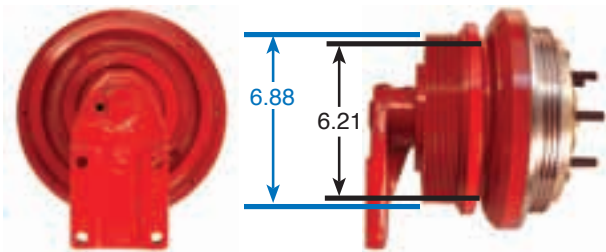

99111

Gold^{Top}
by Kit Masters

Kit # 14-256

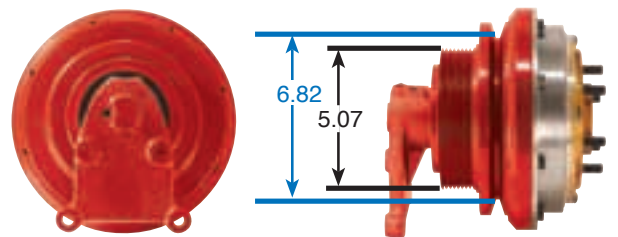

99112

Gold^{Top}
by Kit Masters

Kit # 14-256

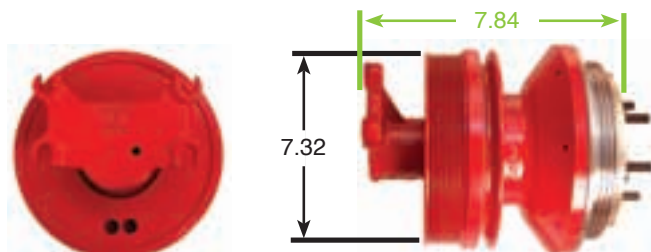

99113

Gold^{Top}
by Kit Masters

Kit # 14-256

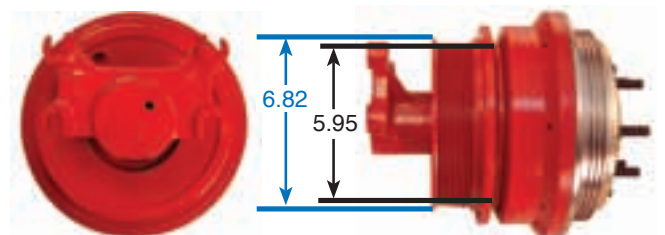

PART NO.

99114

Gold^{Top}
by Kit Masters

Kit # 14-256

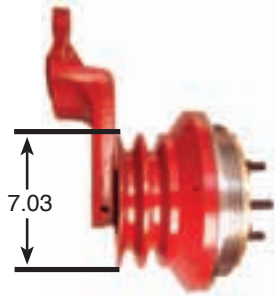

PART NO.

99115

Gold^{Top}
by Kit Masters

Kit # 14-256

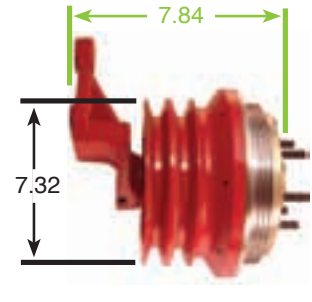

99116

Gold^{Top}
by Kit Masters

Kit # 14-256

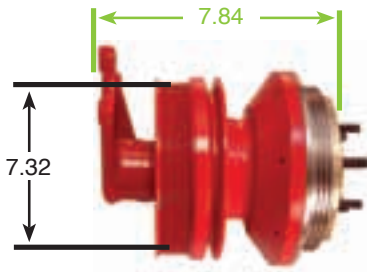

99117

Gold^{Top}
by Kit Masters

Kit # 14-256

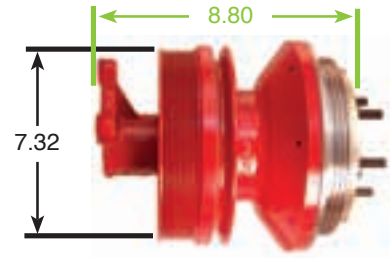

99118

Gold^{Top}
by Kit Masters

Kit # 14-256

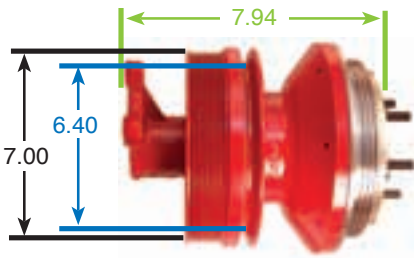

99128

Gold^{Top}
by Kit Masters

Kit # 14-256

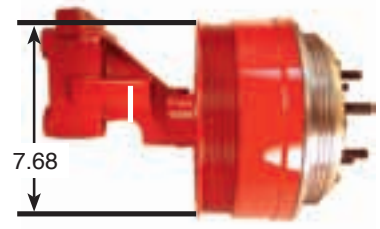

99130

Gold^{Top}
by Kit Masters

Kit # 14-256

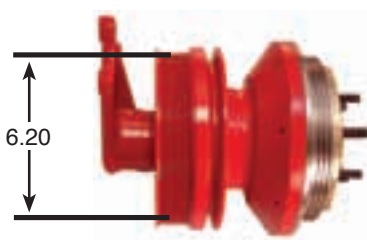

99131

Gold^{Top}
by Kit Masters

Kit # 14-256

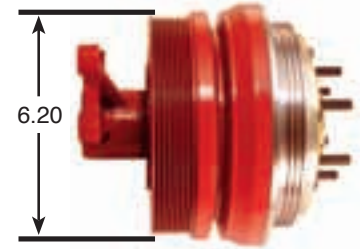

Cummins®

PART NO.

99132

Gold^{Top}
by Kit Masters

Kit # 14-256

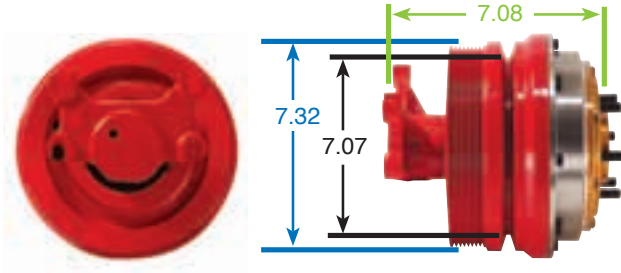

PART NO.

99133

Gold^{Top}
by Kit Masters

Kit # 14-256

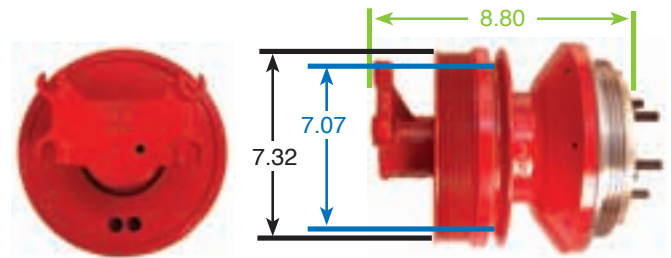

99134

Gold^{Top}
by Kit Masters

Kit # 14-256

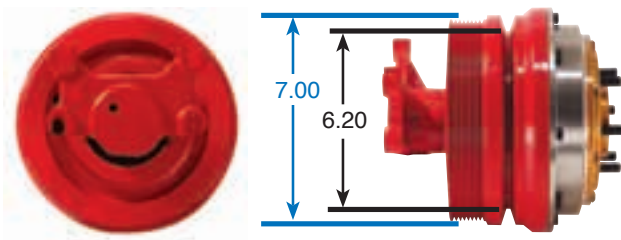

99153

Gold^{Top}
by Kit Masters

Kit # 14-200

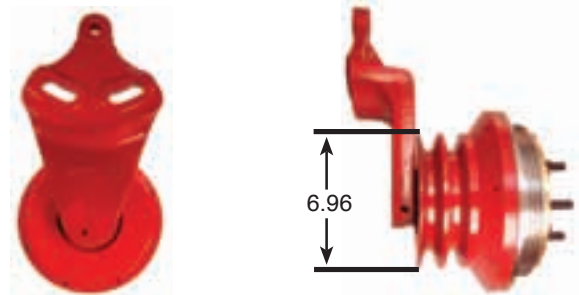

99154

Gold^{Top}
by Kit Masters

Kit # 14-256

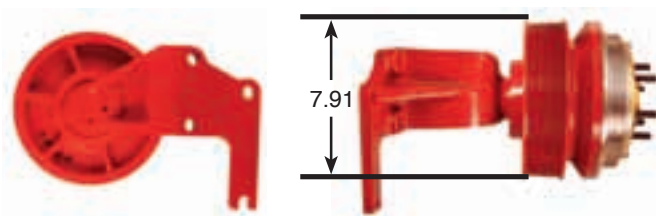

99167

Gold^{Top}
by Kit Masters

Kit # 14-256

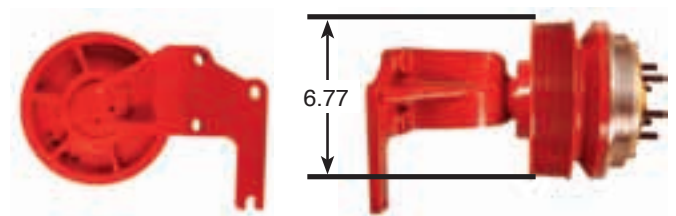

99168

Gold^{Top}
by Kit Masters

Kit # 14-256

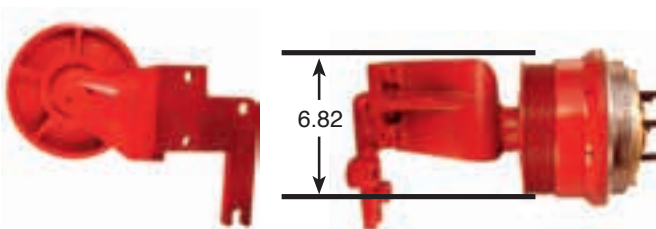

99169

Gold^{Top}
by Kit Masters

Kit # 14-256

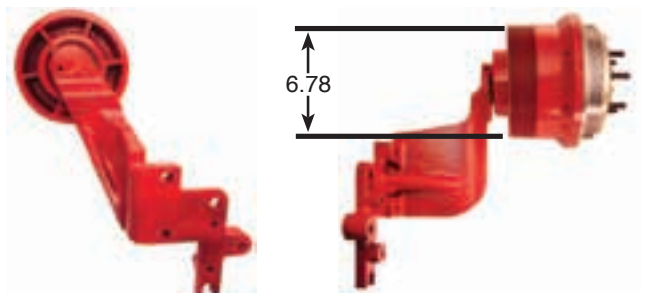

Cummins®

PART NO.

99170

GoldTop
by Kit Masters

Kit # 14-256



PART NO.

99171

GoldTop
by Kit Masters

Kit # 14-256

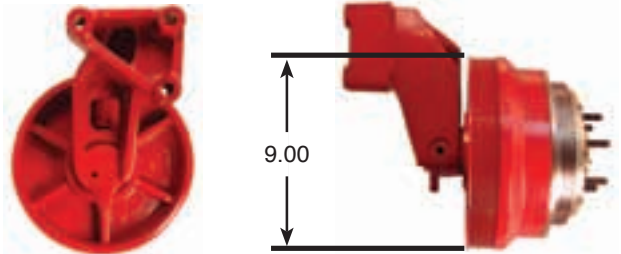

99172

GoldTop
by Kit Masters

Kit # 14-256

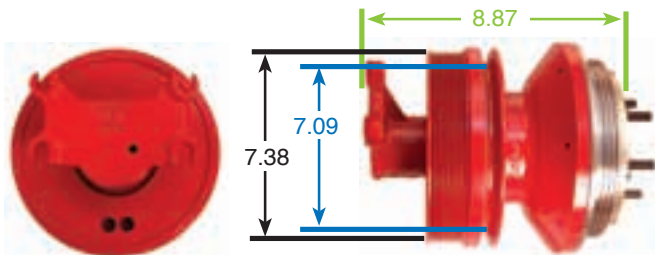

99175

GoldTop
by Kit Masters

Kit # 14-256

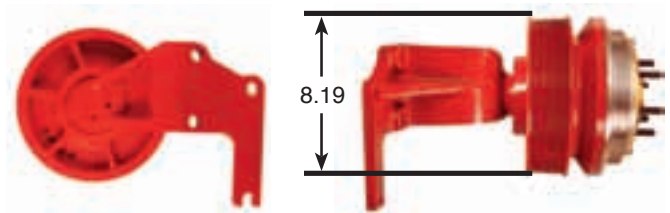

99188

GoldTop
by Kit Masters

Kit # 14-256

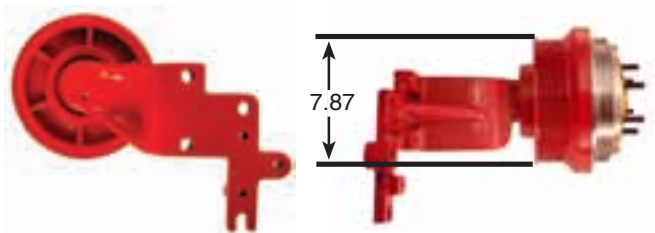

99197

GoldTop
by Kit Masters

Kit # 14-256

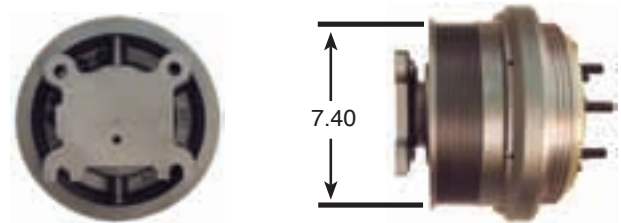

99198

GoldTop
by Kit Masters

Kit # 14-256

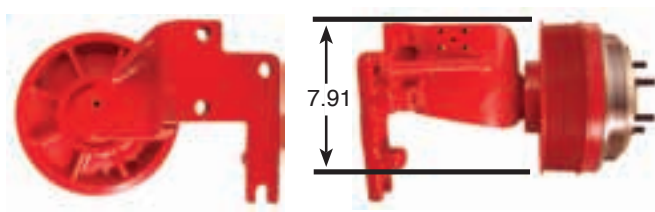

99205

GoldTop
by Kit Masters

Kit # 14-256

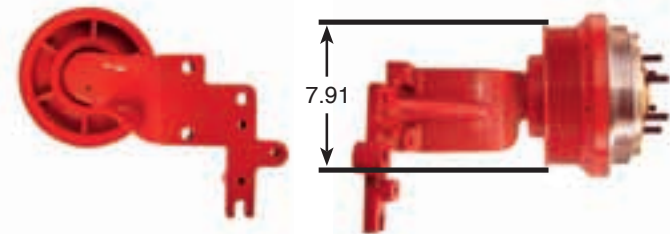

Cummins®

PART NO.

99233

Gold^{Top}
by Kit Masters

Kit # 14-256-1

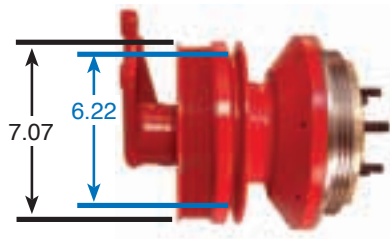

PART NO.

99238

Gold^{Top}
by Kit Masters

Kit # 14-256

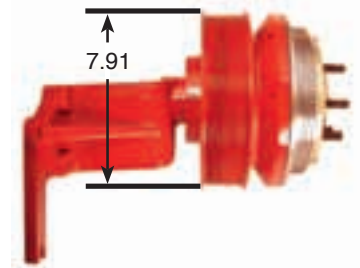

99263

Gold^{Top}
by Kit Masters

Kit # 14-256

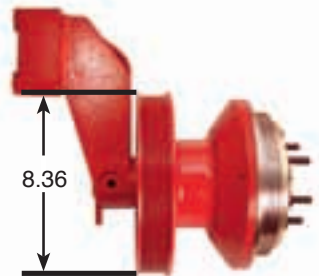

99282

Gold^{Top}
by Kit Masters

Kit # 14-256

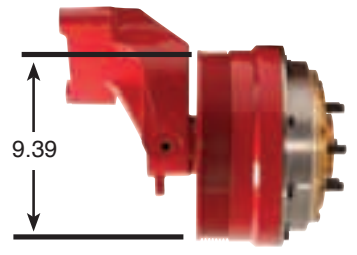

99295

Gold^{Top}
by Kit Masters

Kit # 14-256



99309

Gold^{Top}
by Kit Masters

Kit # 14-256

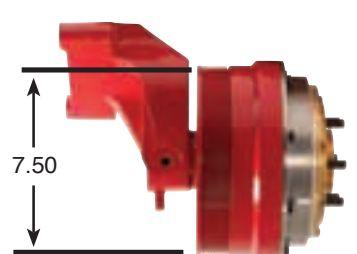

99310

Gold^{Top}
by Kit Masters

Kit # 14-256-1

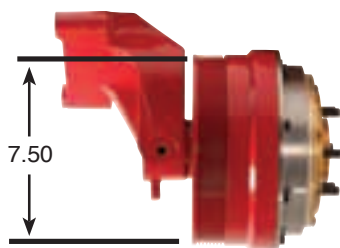

99325

Gold^{Top}
by Kit Masters

Kit # 14-256

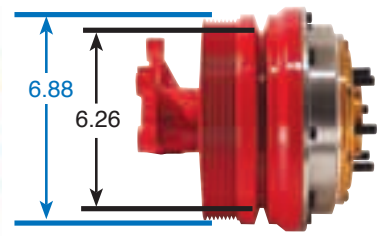

Cummins®

PART NO.

99326

GoldTop
by Kit Masters

Kit # 14-256

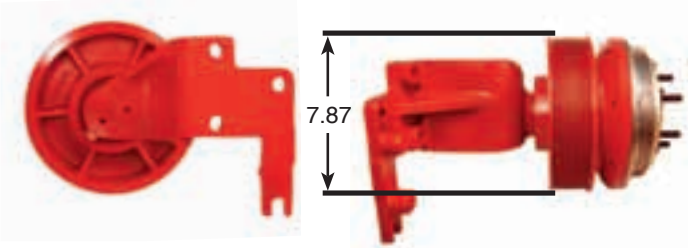

PART NO.

99331

GoldTop
by Kit Masters

Kit # 14-256

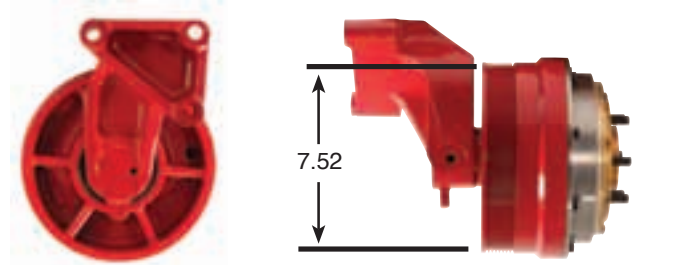

99343

GoldTop
by Kit Masters

Kit # 14-256

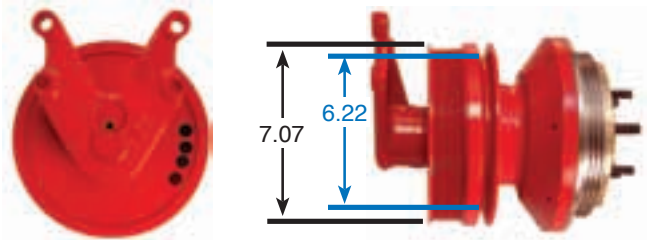

99349

GoldTop
by Kit Masters

Kit # 14-256

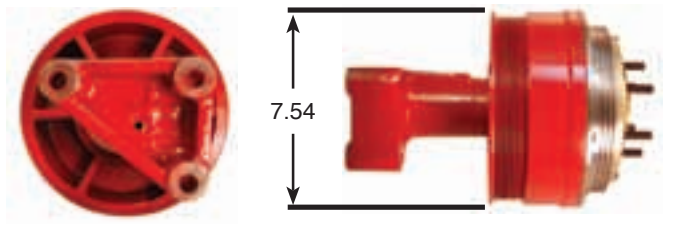

99384

GoldTop
by Kit Masters

Kit # 14-256

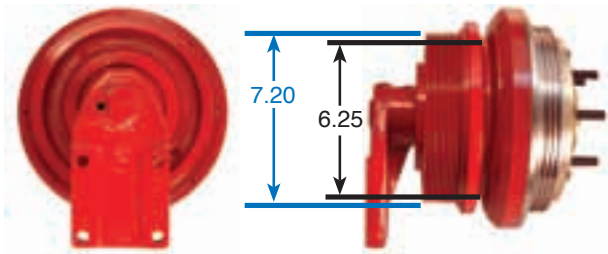

99389

GoldTop
by Kit Masters

Kit # 14-256

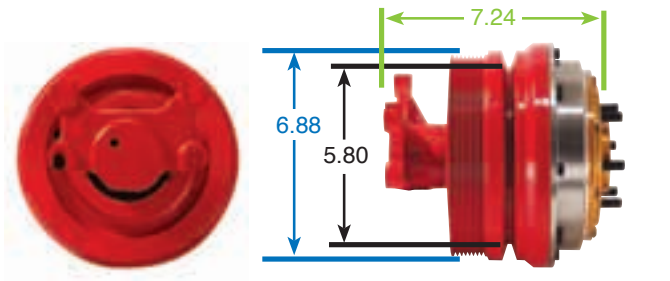

KIT MASTERS REBUILD KITS

See pages 4 through 8 for a wide variety of Kit Masters rebuild kits.

Major Kits • Seal Kits
Lining Kits • Bearing Kits



Cummins®

PART NO.

99415

Gold  Top
by Kit Masters

Kit # 14-256

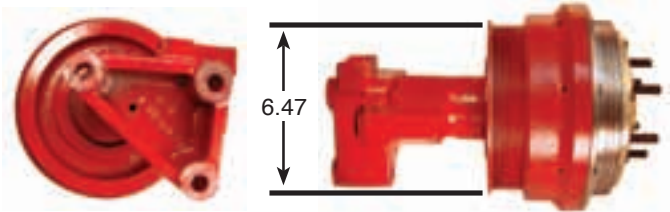

PART NO.

99430

Gold  Top
by Kit Masters

Kit # 14-256

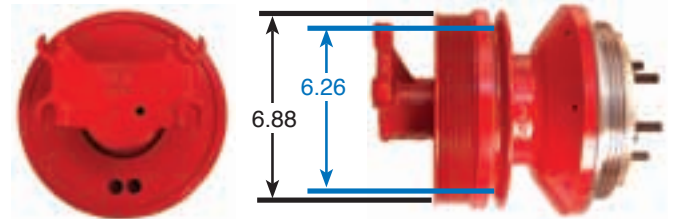

99446

Gold  Top
by Kit Masters

Kit # 14-256

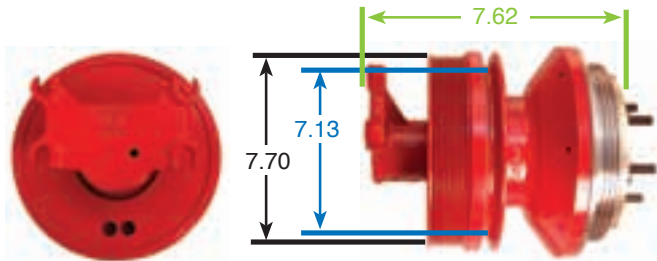

99466

Gold  Top
by Kit Masters

Kit # 14-256

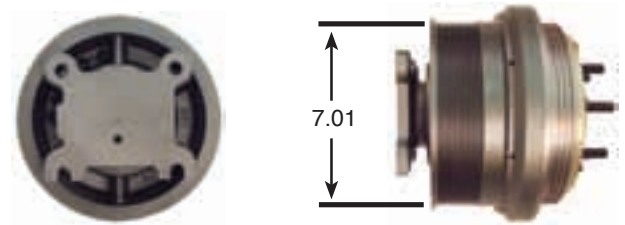

99600

Gold  Top
by Kit Masters

Kit # 14-256

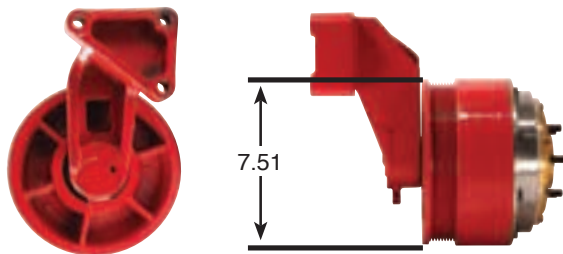

99601

Gold  Top
by Kit Masters

Kit # 14-256

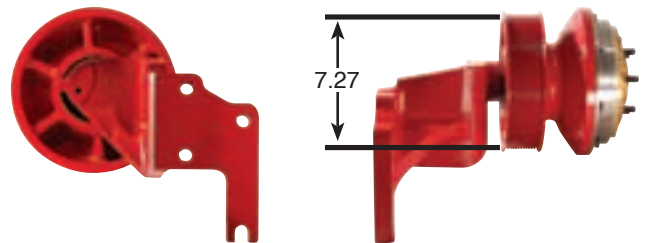

99801

Gold  Top
by Kit Masters

Kit # 14-256

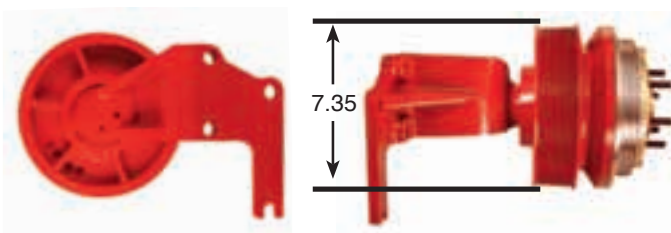

99823

Gold  Top
by Kit Masters

Kit # 14-256

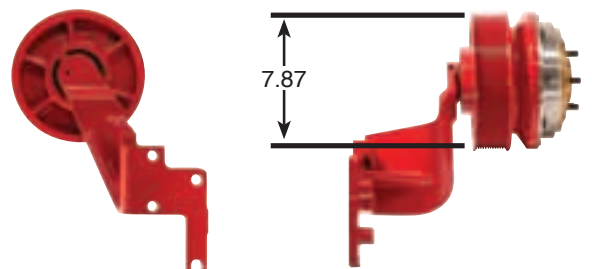

Detroit Diesel®

PART NO.

90003

Kit # 7500HP

2.05" Fan Pilot

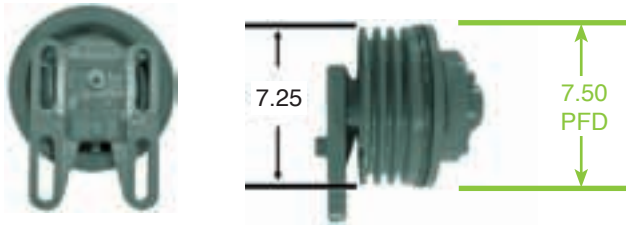

PART NO.

90004

Kit # 7500HP

2.05" Fan Pilot

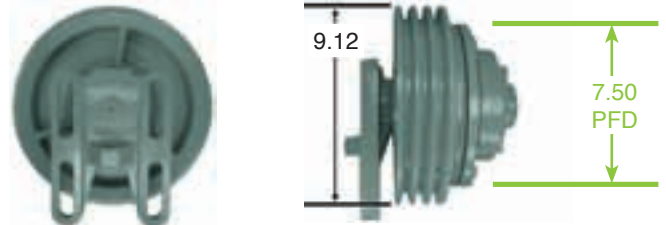

90009

Kit # 7500HP

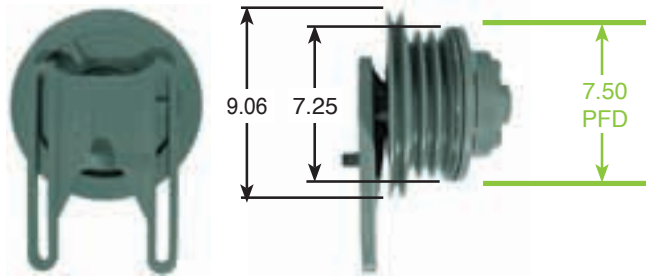

90011

Kit # 7500HP

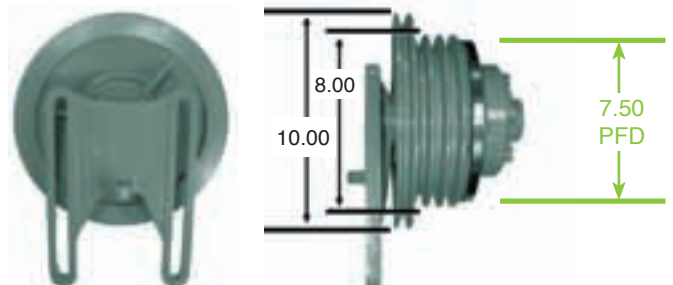

90018

Kit # 7500HP

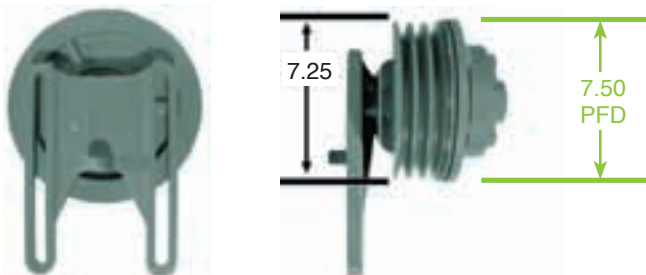

90019

Kit # 7500HP

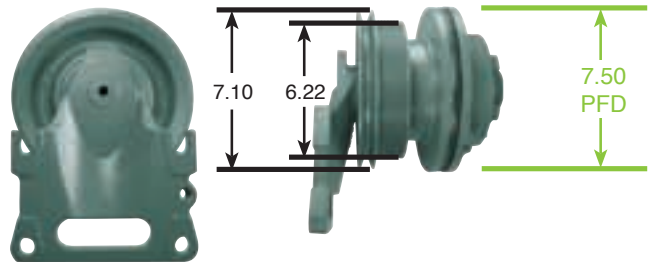

90020

Kit # 7500HP

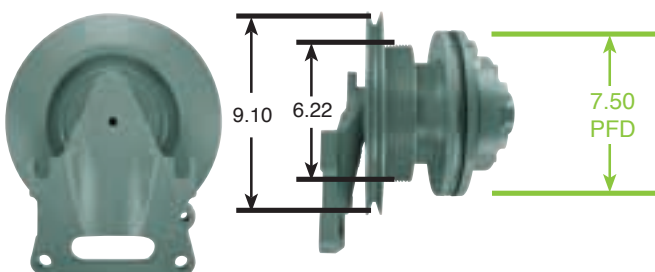

90029

Kit # 7500HP

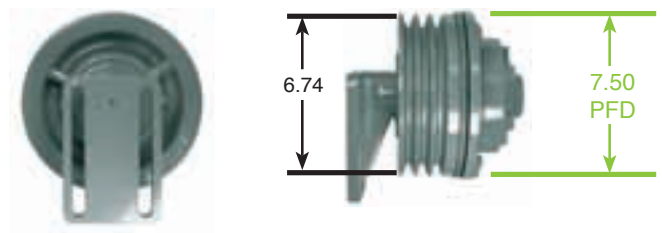

Detroit Diesel®

PART NO.

91011

Kit # 9500HP

Same as 91091

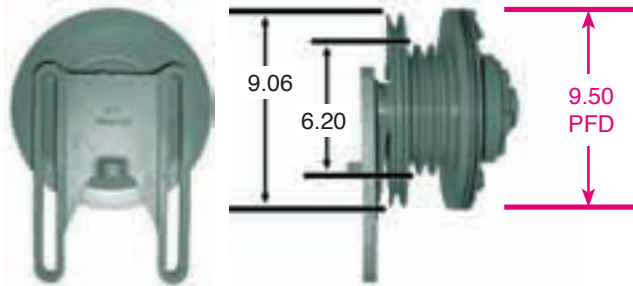

PART NO.

91023

Kit # 9500HP

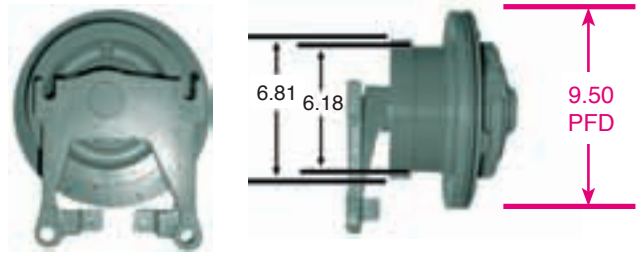

91024

Kit # 9500HP

Same as 91065

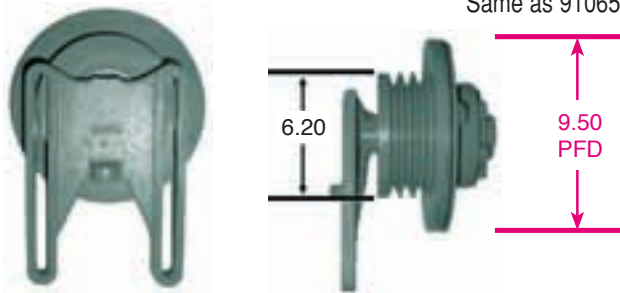

91031

Kit # 9500HP

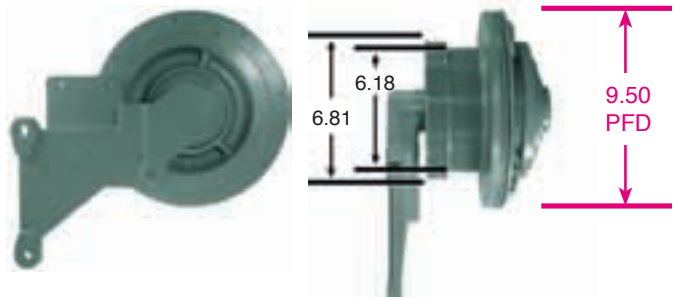

91033

Kit # 9500HP

2.56" Fan Pilot

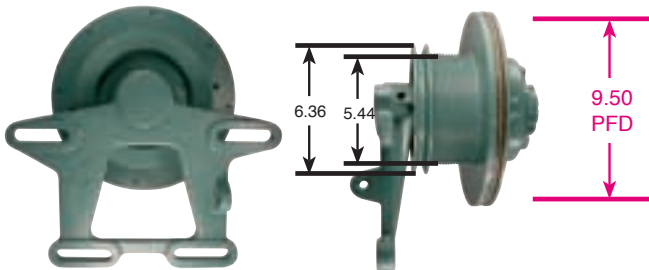

91037

Kit # 9500HP

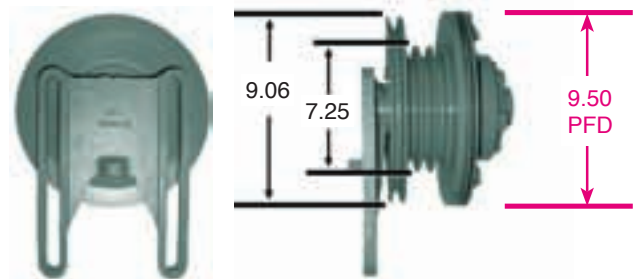

91046

Kit # 9500HP

2.56" Fan Pilot

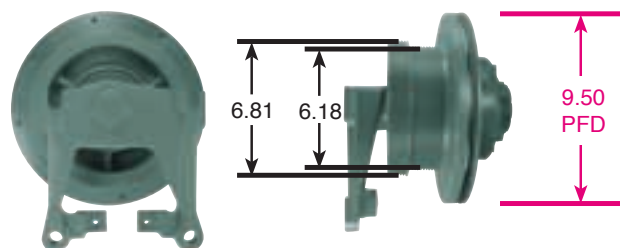

91047

Kit # 9500HP

2.56" Fan Pilot

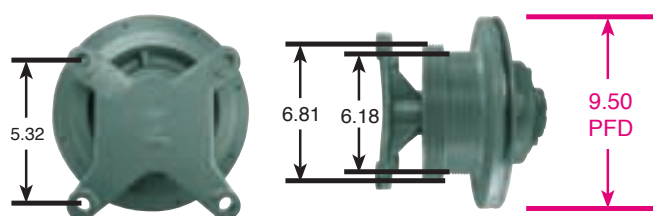

Detroit Diesel®

PART NO.

91050

Kit # 9500HP

2.56" Fan Pilot

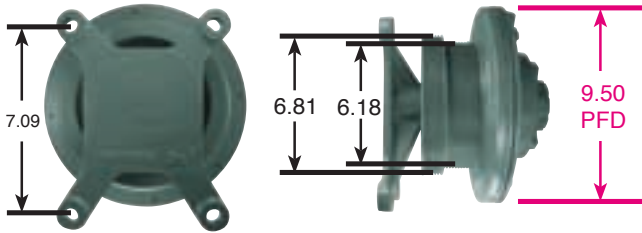

PART NO.

91052

Kit # 9500HP

5" Fan Pilot

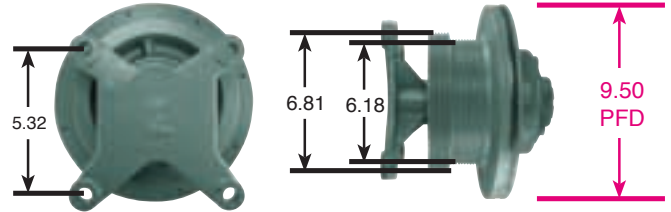

91062

Kit # 9506HP

2.56" Fan Pilot

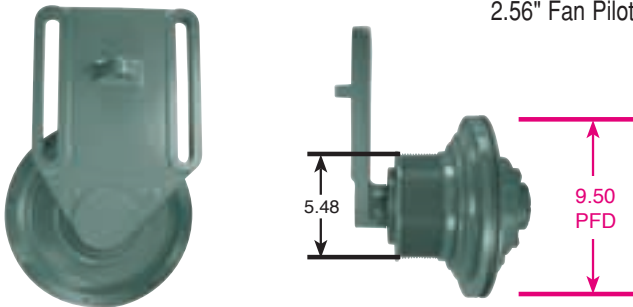

91065

Kit # 9500HP

Same as 91024

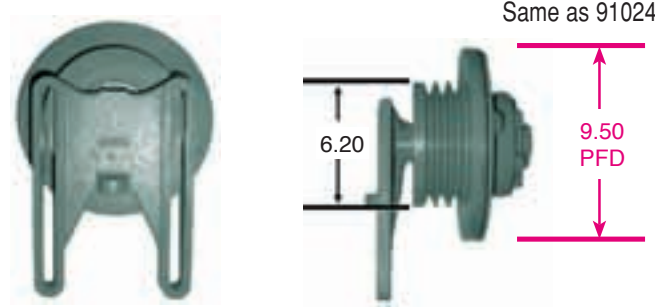

91077

Kit # 9500HP

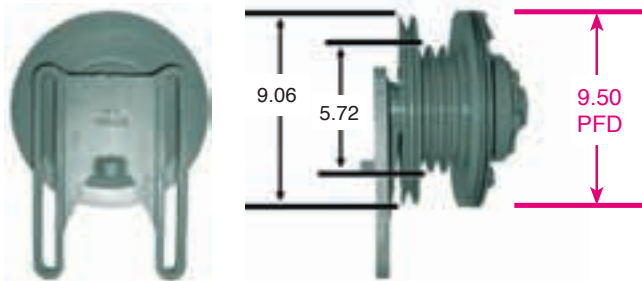

91083

Kit # 9500HP

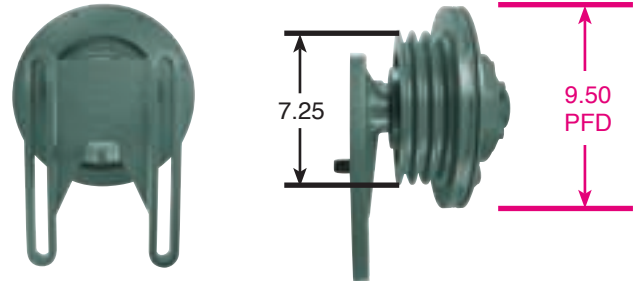

91091

Kit # 9500HP

Same as 91011

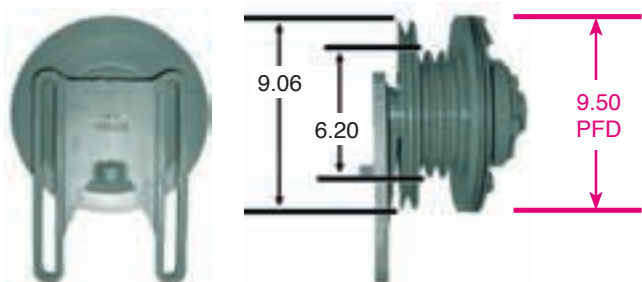

91105

Kit # 9500HP

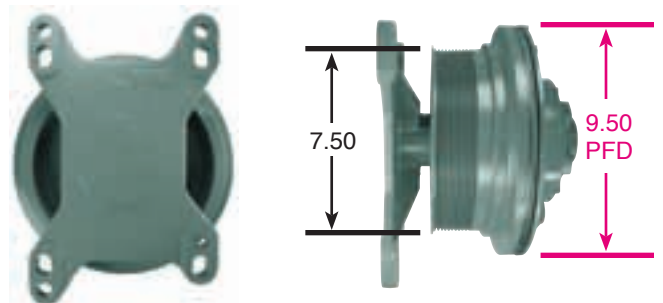

Detroit Diesel®

PART NO.

91107

Kit # 9500HP

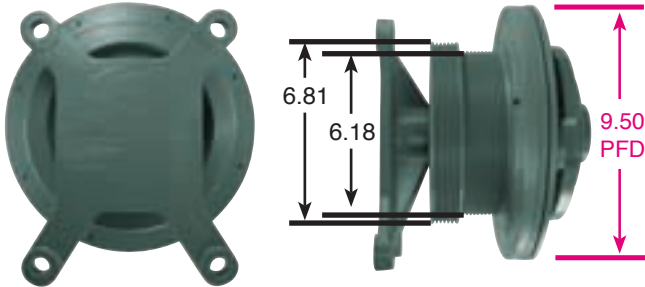

PART NO.

91114

Kit # 9500HP

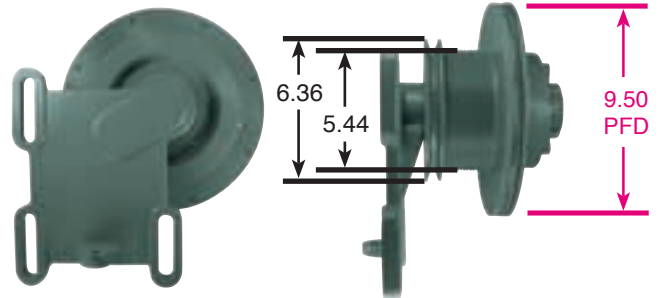

99003

GoldTop
by KI Masters

Kit # 14-200

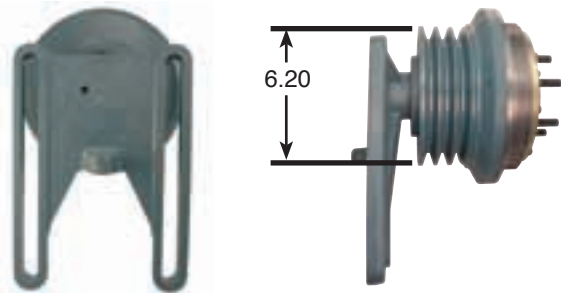

99006

GoldTop
by KI Masters

Kit # 14-200

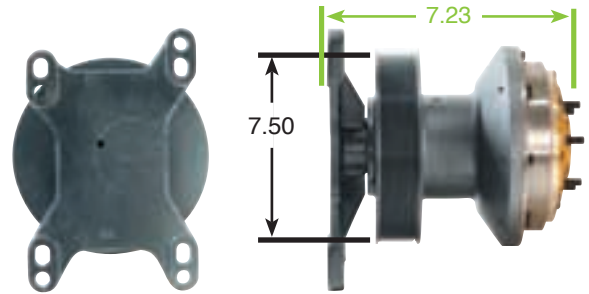

99007

GoldTop
by KI Masters

Kit # 14-256

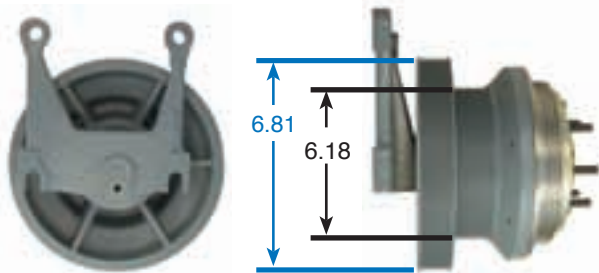

99016

GoldTop
by KI Masters

Kit # 14-256

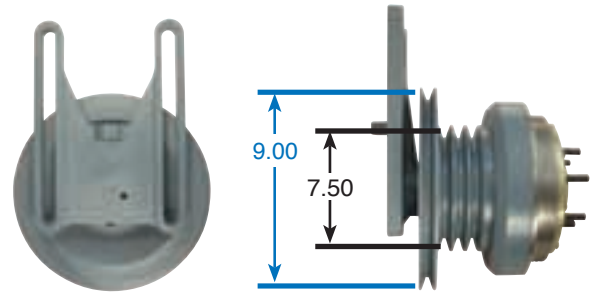

99017

GoldTop
by KI Masters

Kit # 14-256

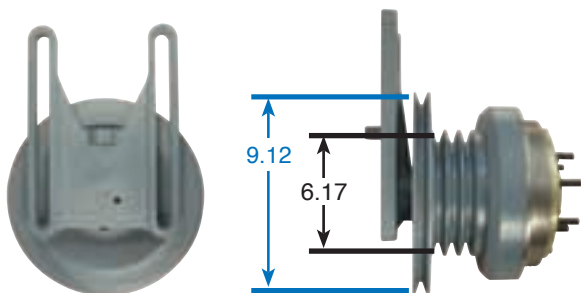

99018

GoldTop
by KI Masters

Kit # 14-256

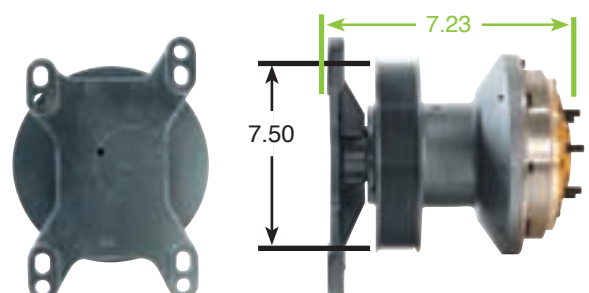

Detroit Diesel®

PART NO.

99027

GoldTop
by Kit Masters

Kit # 14-256

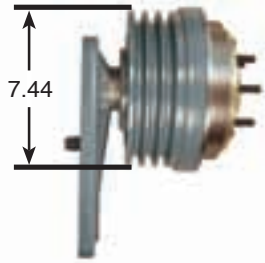

Also use Stud Kit 250SK

PART NO.

99028

GoldTop
by Kit Masters

Kit # 14-256

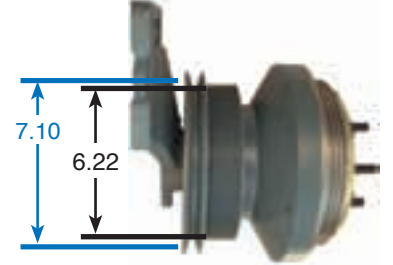

99029

GoldTop
by Kit Masters

Kit # 14-256

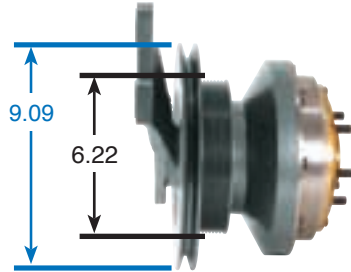

99031

GoldTop
by Kit Masters

Kit # 14-256

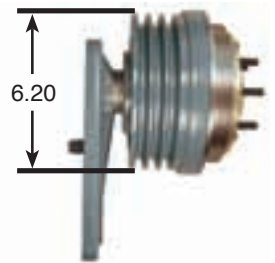

99041

GoldTop
by Kit Masters

Kit # 14-256

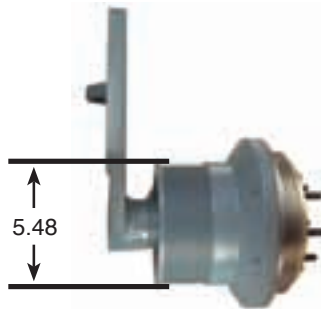

99049

GoldTop
by Kit Masters

Kit # 14-256

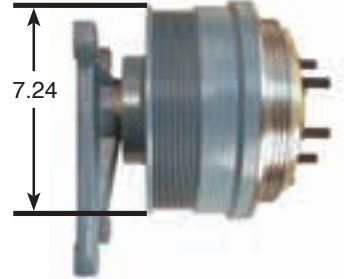

99061

GoldTop
by Kit Masters

Kit # 14-256

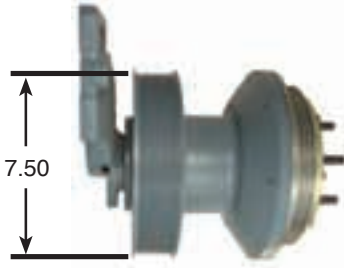

99062

GoldTop
by Kit Masters

Kit # 14-256

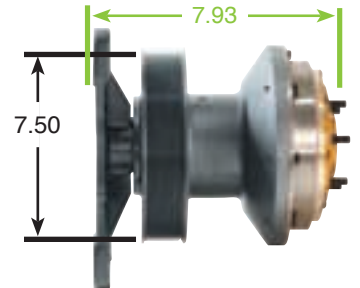

Detroit Diesel®

PART NO.

99063

GoldTop
by Kit Masters

Kit # 14-256

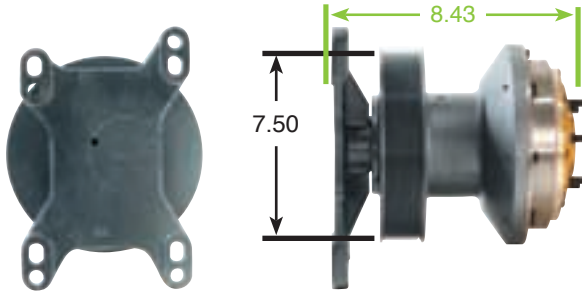

PART NO.

99064

GoldTop
by Kit Masters

Kit # 14-256

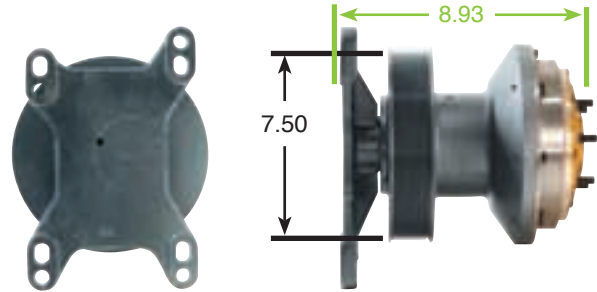

99065

GoldTop
by Kit Masters

Kit # 14-256

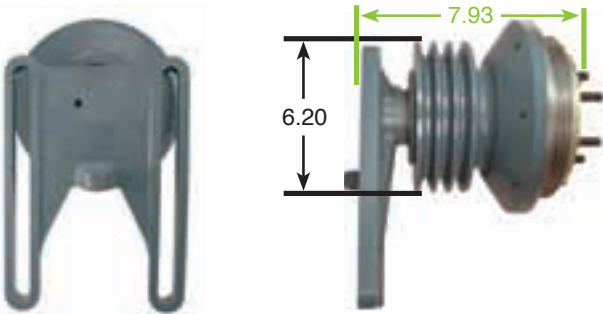

99066

GoldTop
by Kit Masters

Kit # 14-256

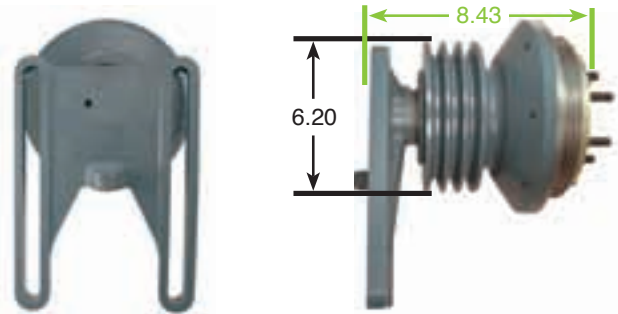

99067

GoldTop
by Kit Masters

Kit # 14-256

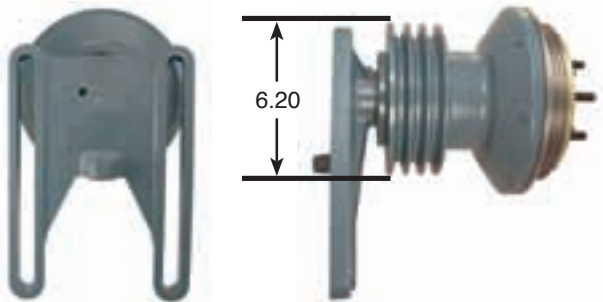

99092

GoldTop
by Kit Masters

Kit # 14-256

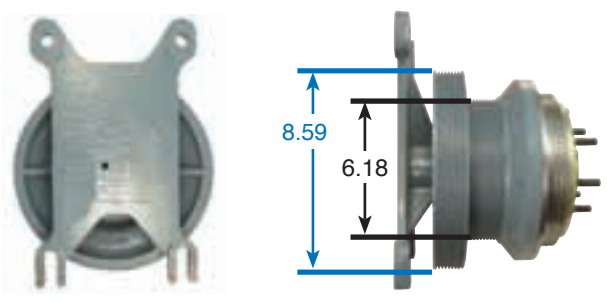

99151

GoldTop
by Kit Masters

Kit # 14-256

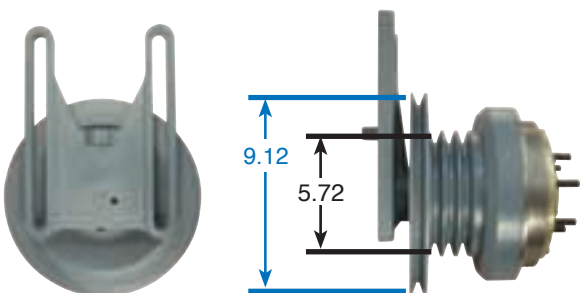

99203

GoldTop
by Kit Masters

Kit # 14-256

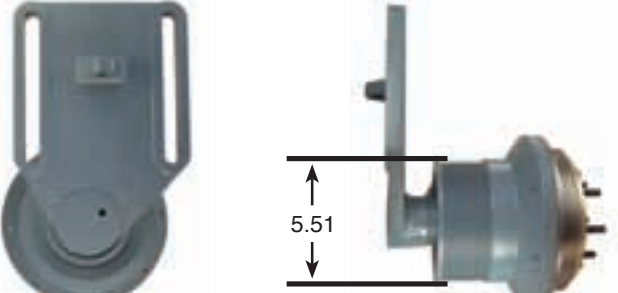

Detroit Diesel®

PART NO.

99216

GoldTop
by Kit Masters

Kit # 14-256

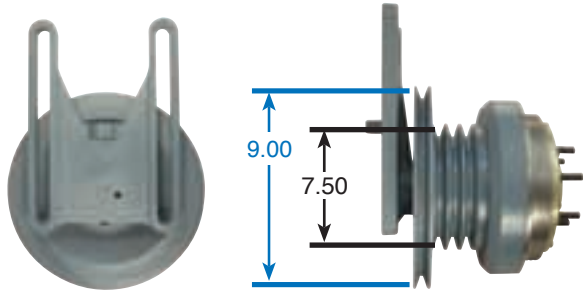

PART NO.

99217

GoldTop
by Kit Masters

Kit # 14-256

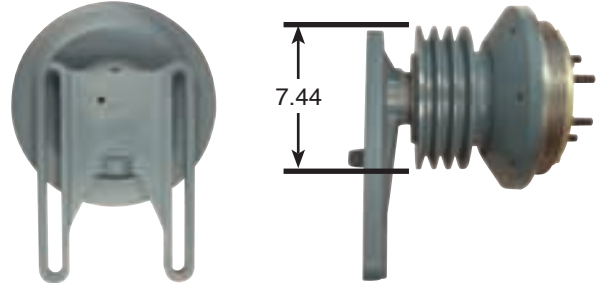

99222

GoldTop
by Kit Masters

Kit # 14-256

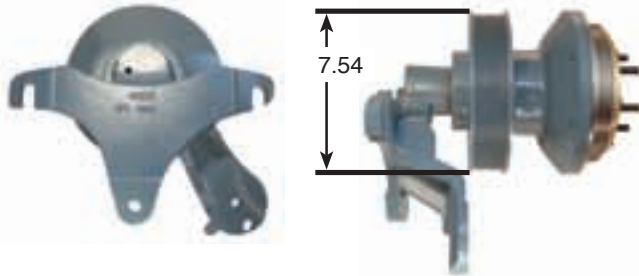

99223

GoldTop
by Kit Masters

Kit # 14-256

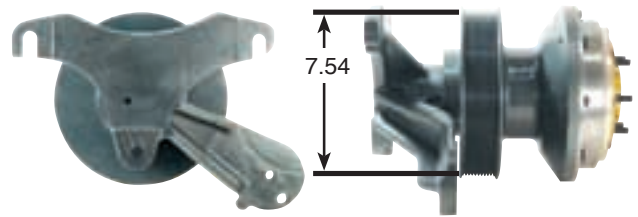

99224

GoldTop
by Kit Masters

Kit # 14-256

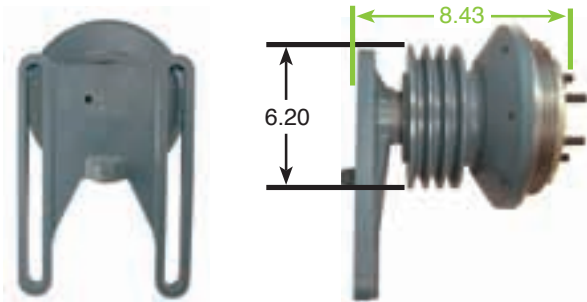

99225

GoldTop
by Kit Masters

Kit # 14-256

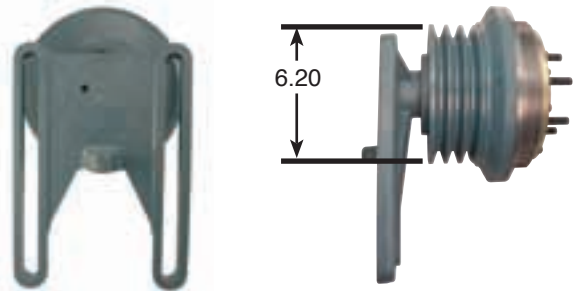

99226

GoldTop
by Kit Masters

Kit # 14-256

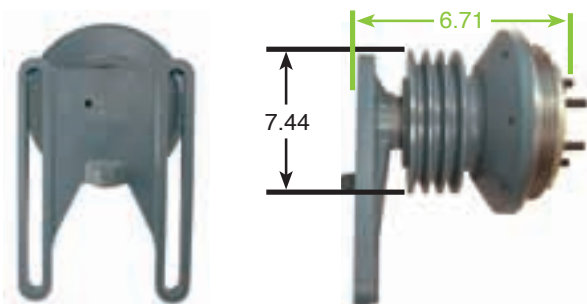

99228

GoldTop
by Kit Masters

Kit # 14-256

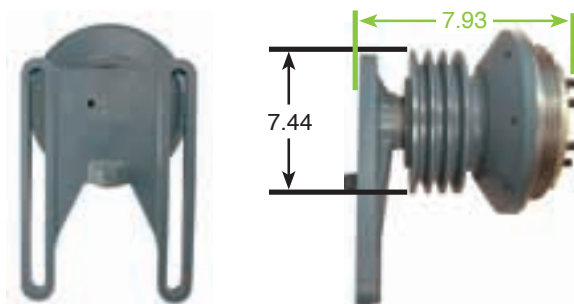

Detroit Diesel®

PART NO.

99229

GoldTop
by Kit Masters

Kit # 14-256

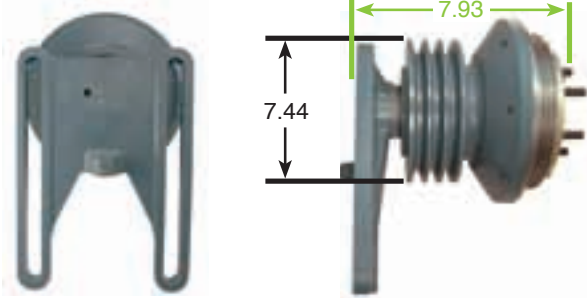

PART NO.

99243

GoldTop
by Kit Masters

Kit # 14-256

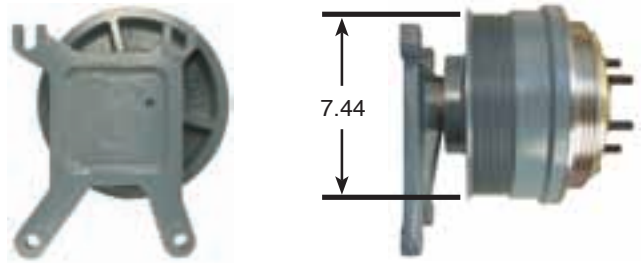

99256

GoldTop
by Kit Masters

Kit # 14-256

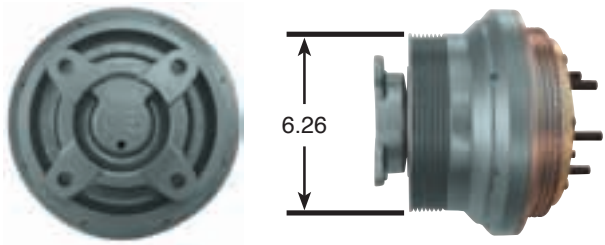

99268

GoldTop
by Kit Masters

Kit # 14-256

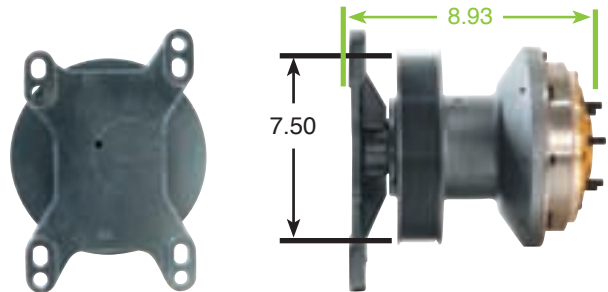

99286

GoldTop
by Kit Masters

Kit # 14-200

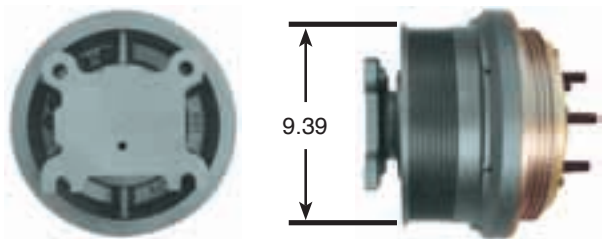

99300

GoldTop
by Kit Masters

Kit # 14-256

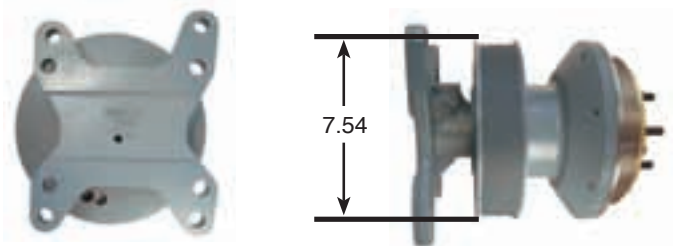

99305

GoldTop
by Kit Masters

Kit # 14-200

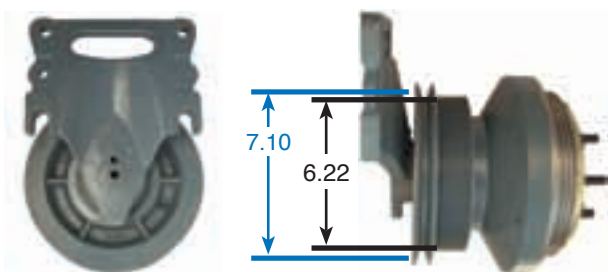

99410

GoldTop
by Kit Masters

Kit # 14-256

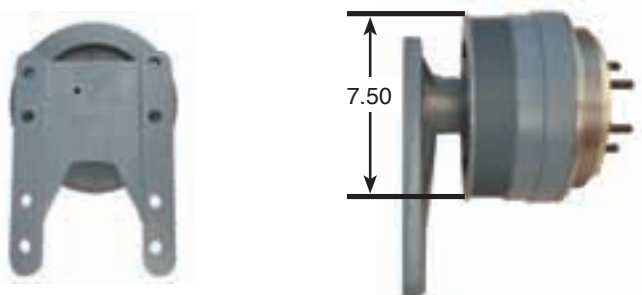

Detroit Diesel®

PART NO.

99419

GoldTop
by KI Masters

Kit # 14-200

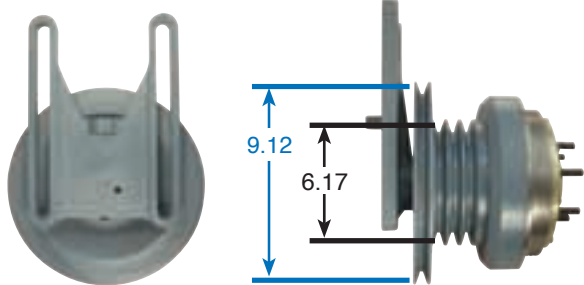

PART NO.

99429

GoldTop
by KI Masters

Kit # 14-256

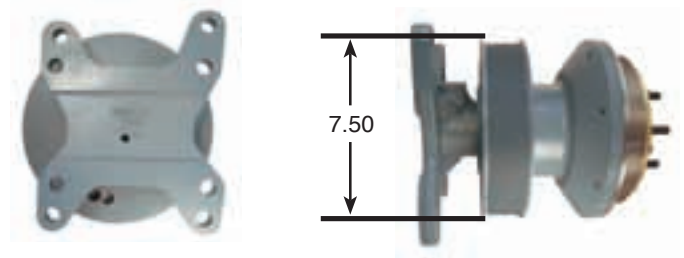

99450

GoldTop
by KI Masters

Kit # 14-256

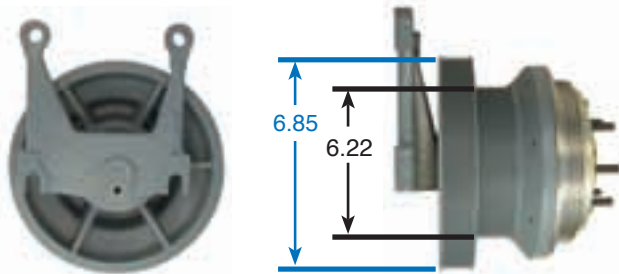

99621

GoldTop
by KI Masters

Kit # 14-256

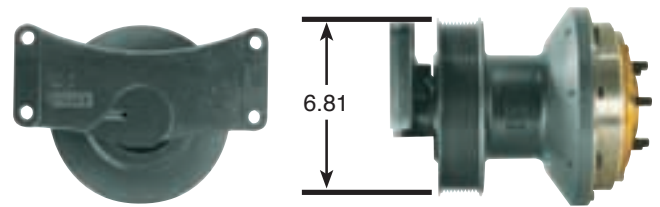

99849

GoldTop
by KI Masters

Kit # 14-256

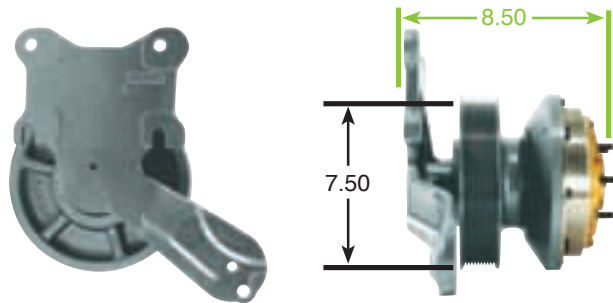

99850

GoldTop
by KI Masters

Kit # 14-256

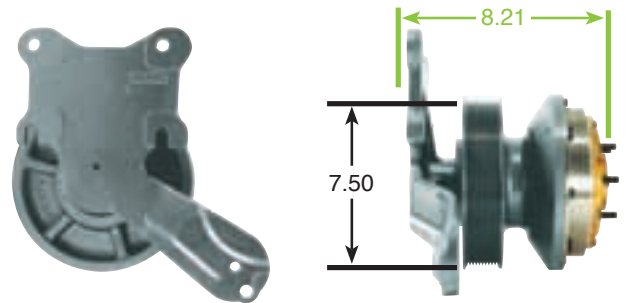

International®

PART NO.

91042

Kit # 9500HP

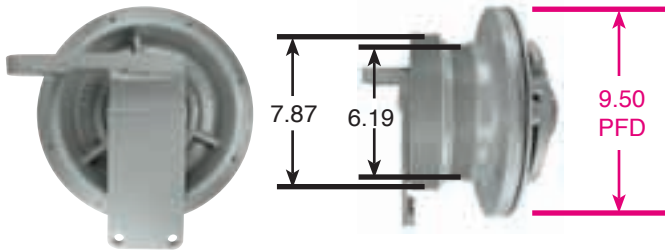

PART NO.

91043

Kit # 9500HP

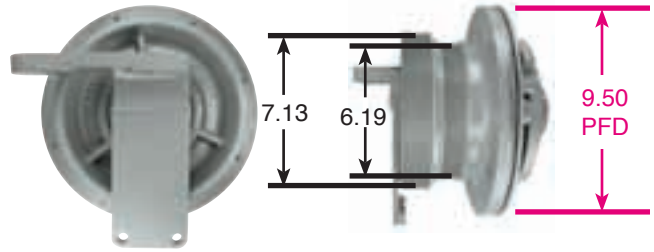

99023

GoldTop
by Kit Masters

Kit # 14-256

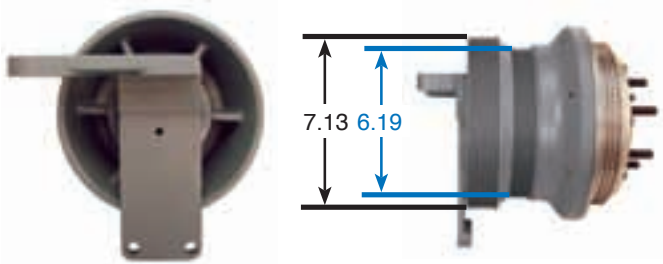

99024

GoldTop
by Kit Masters

Kit # 14-256

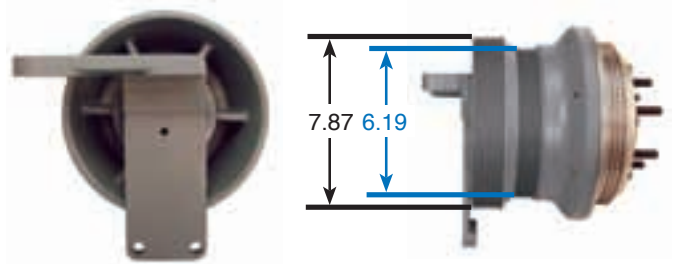

99252

GoldTop
by Kit Masters

Kit # 14-256

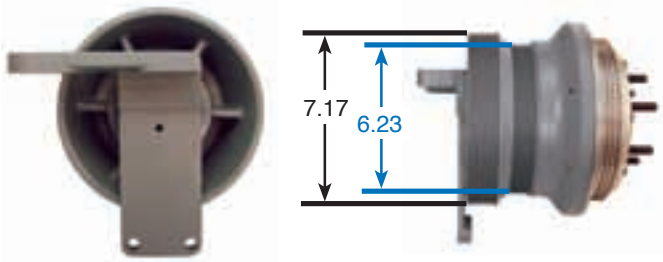

KIT MASTERS REBUILD KITS

See pages 4 through 8 for a wide variety of Kit Masters rebuild kits.

Major Kits • Seal Kits
Lining Kits • Bearing Kits



Mack

PART NO.

99247

GoldTop
by Kit Masters

Kit # 14-256

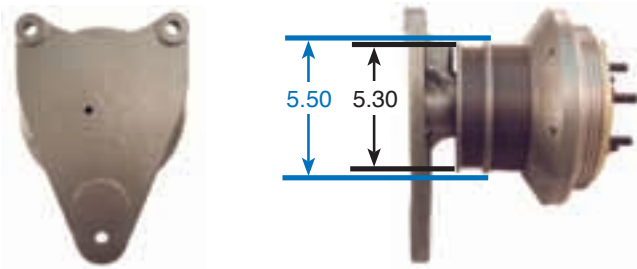

PART NO.

99347

GoldTop
by Kit Masters

Kit # 14-256

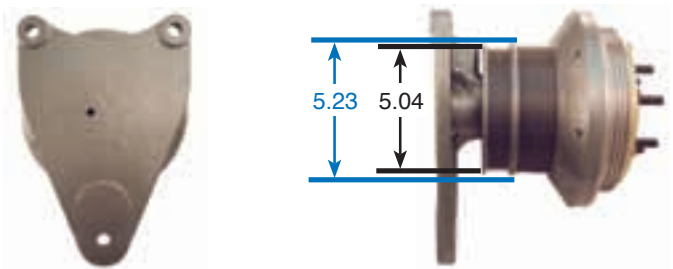

99348

GoldTop
by Kit Masters

Kit # 14-256

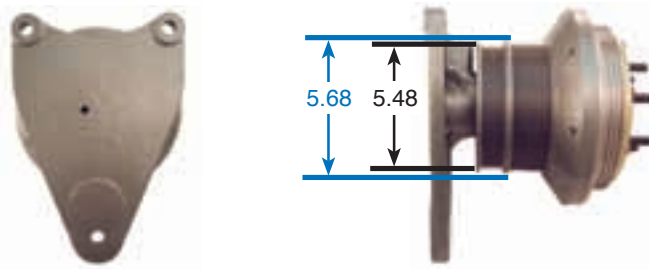

99356

GoldTop
by Kit Masters

Kit # 14-256

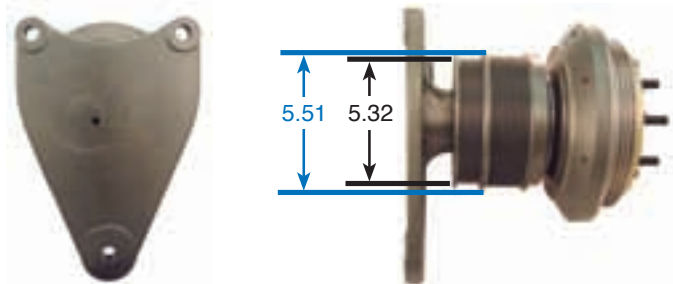

99357

GoldTop
by Kit Masters

Kit # 14-256

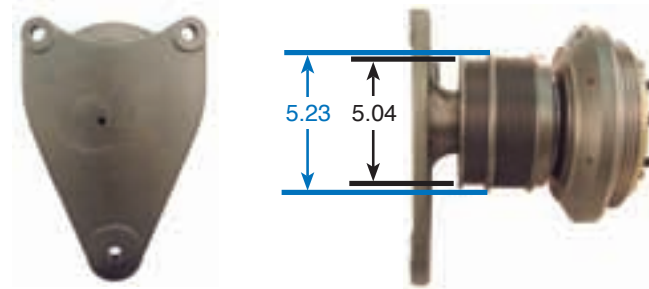

99399

GoldTop
by Kit Masters

Kit # 14-256

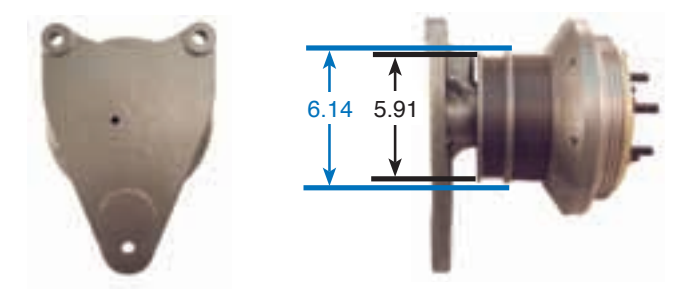

99400

GoldTop
by Kit Masters

Kit # 14-256

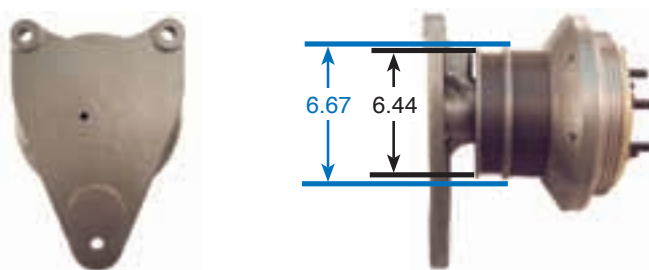

99407

GoldTop
by Kit Masters

Kit # 14-256

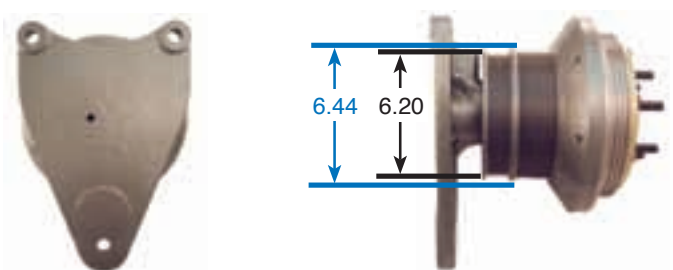

MCI® Remote Mount

PART NO.

91039

Kit # 9500HP

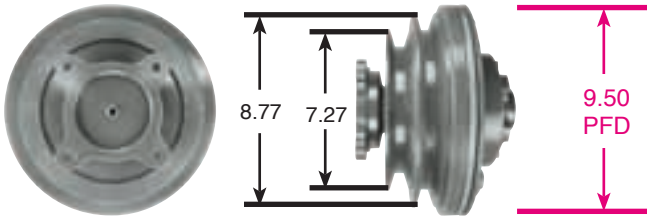

PART NO.

91039GTN

Kit # 14-200

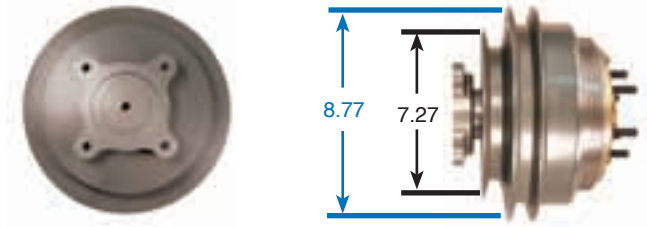

91040

Kit # 9500HP

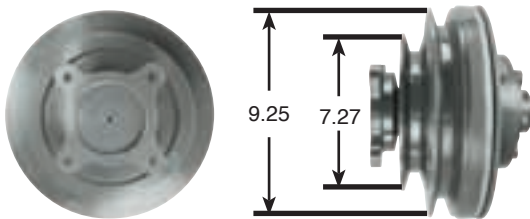

91040GTN

Kit # 14-200

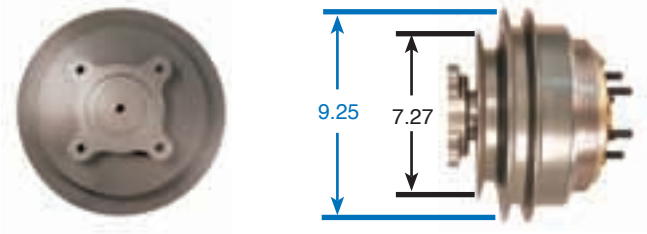

91041

Kit # 9500HP

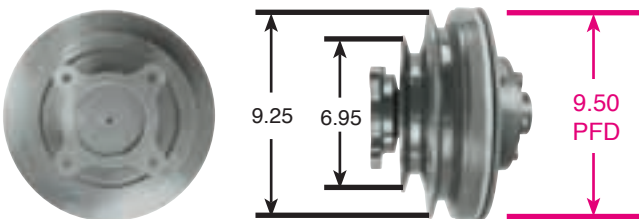

91041GTN

Kit # 14-200

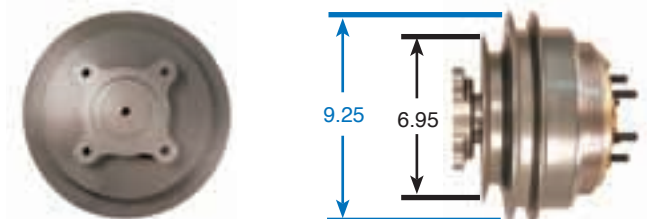

99285

GoldTop
by Kit Masters

Kit # 14-256

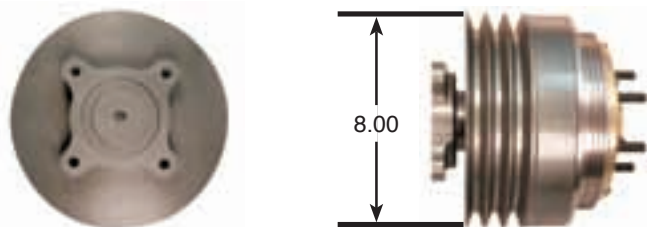

Upgrade to a GoldTop®!

Convert these clutches from air-engaged to spring-engaged with our

unique GTN option

Mercedes-Benz®

PART NO.

99077

GoldTop
by Kit Masters

Kit # 14-256-1

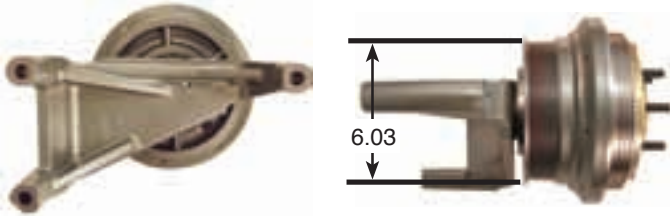

PART NO.

99142

GoldTop
by Kit Masters

Kit # 14-256-1

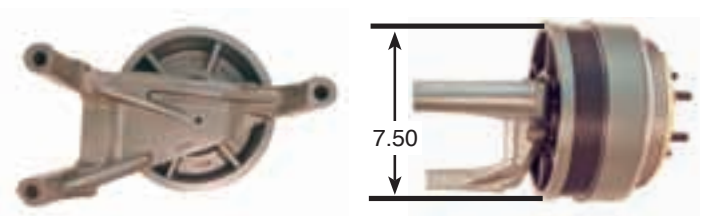

99143

GoldTop
by Kit Masters

Kit # 14-256-1

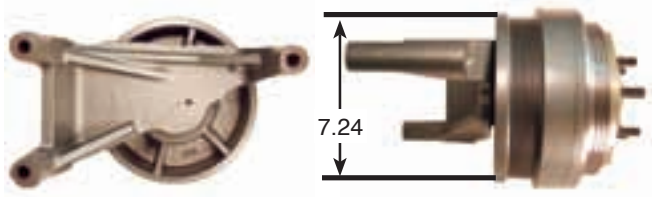

99275

GoldTop
by Kit Masters

Kit # 14-256-1

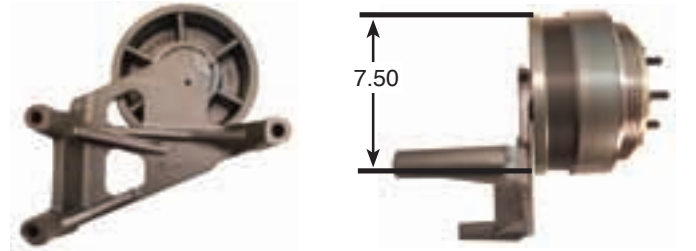

99301

GoldTop
by Kit Masters

Kit # 14-256-1

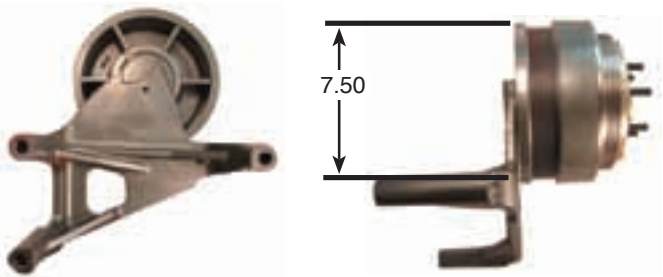

99302

GoldTop
by Kit Masters

Kit # 14-256-1

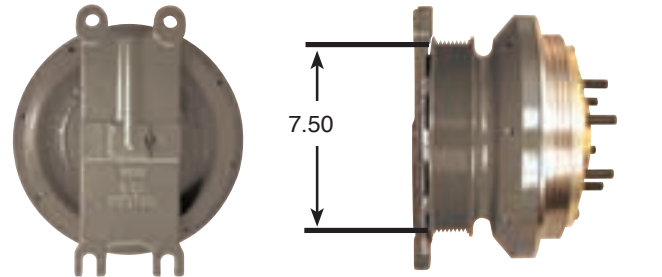

99336

GoldTop
by Kit Masters

Kit # 14-256-1

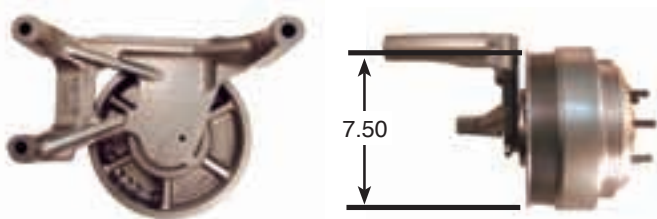

99381

GoldTop
by Kit Masters

Kit # 14-256-1

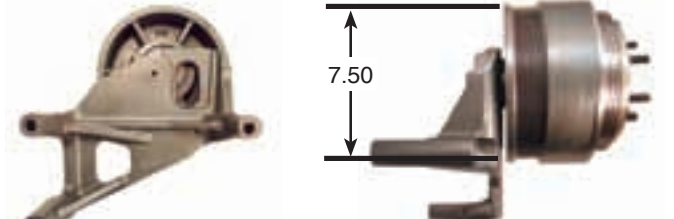

PART NO.

91073

Kit # 9500HP

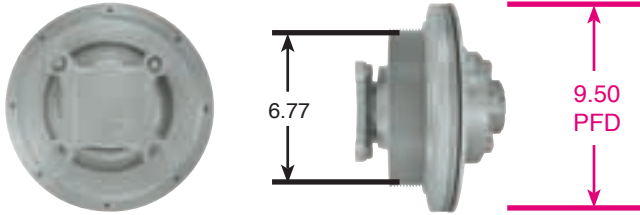

PART NO.

91084

Kit # 9500HP

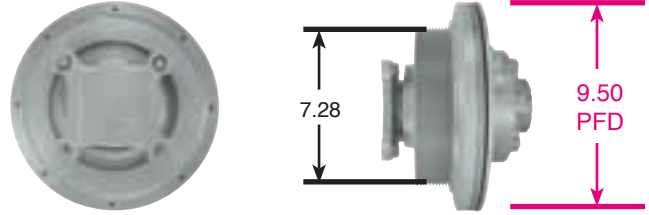

99019



Kit # 14-256

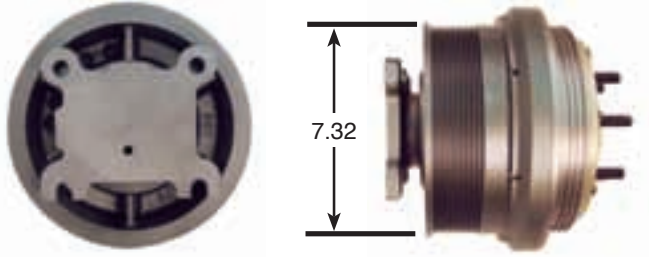

99196



Kit # 14-256

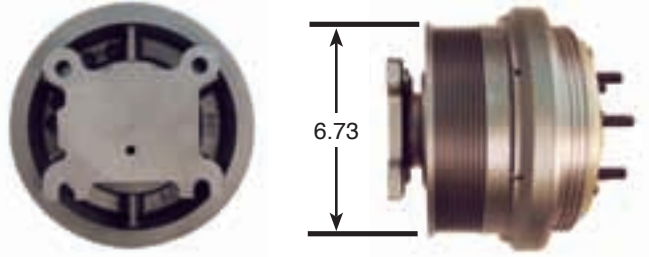

99197



Kit # 14-256

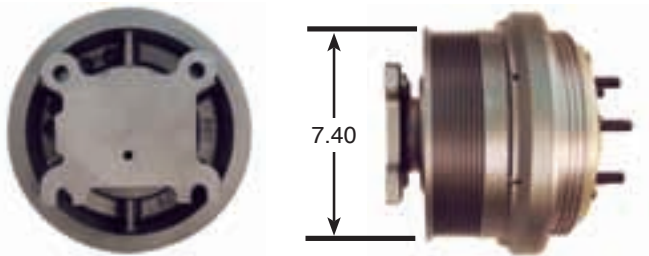

99454



Kit # 14-256

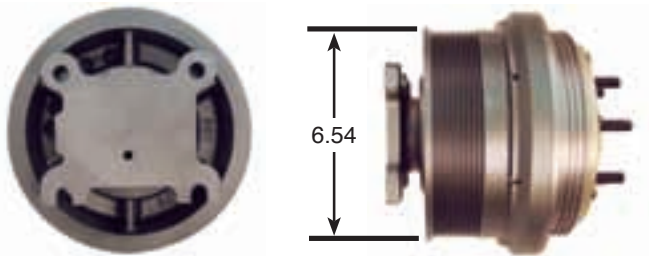

Bendix®

PART NO.

104725X

Kit # 104939

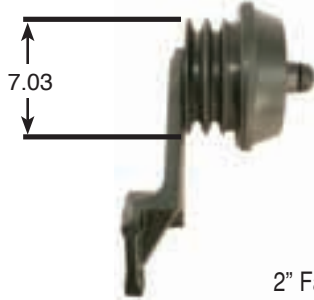

2" Fan Pilot

PART NO.

104735X

Kit # 104939

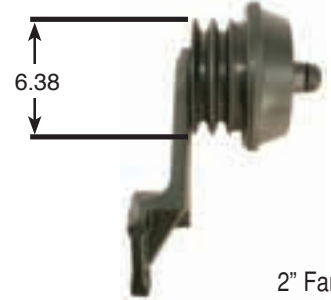

2" Fan Pilot

104750X

Kit # 104939

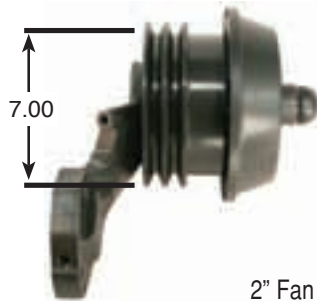

2" Fan Pilot

104751X

Kit # 104939

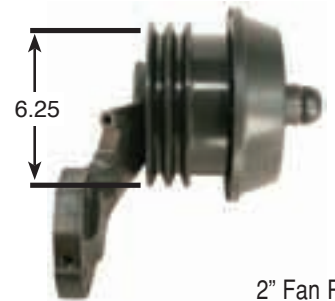

2" Fan Pilot

104756X

Kit # 104941

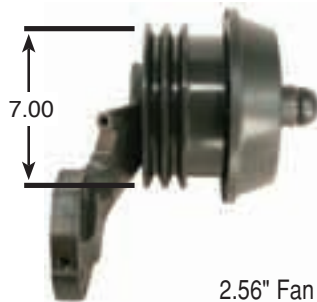

2.56" Fan Pilot

104757X

Kit # 104941

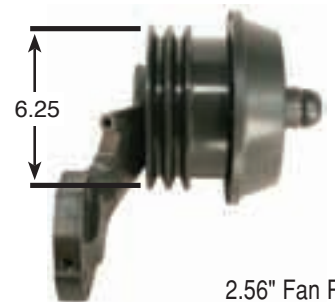

2.56" Fan Pilot

104758X

Kit # 104939



2" Fan Pilot

104760X

Kit # 104941



2.56" Fan Pilot

PART NO.

104761X

Kit # 104939

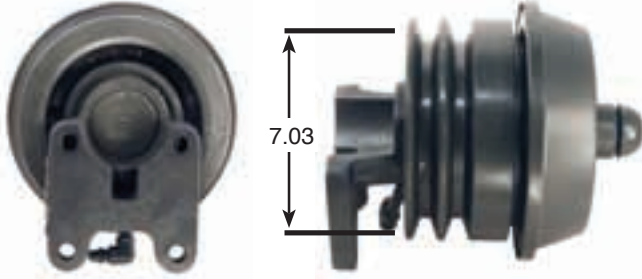

2" Fan Pilot

PART NO.

104763X

Kit # 104941

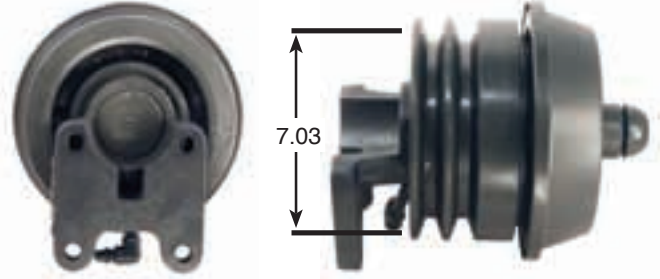

2.56" Fan Pilot

104767X

Kit # 104939

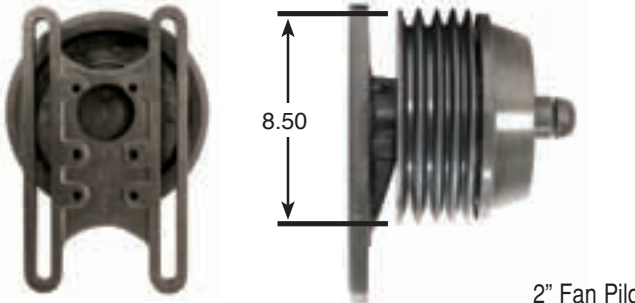

2" Fan Pilot

104769X

Kit # 104941

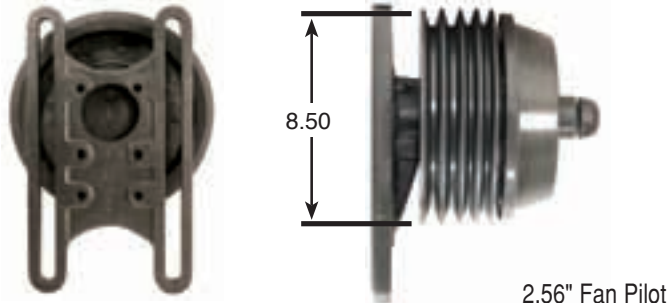

2.56" Fan Pilot

104770X

Kit # 104939

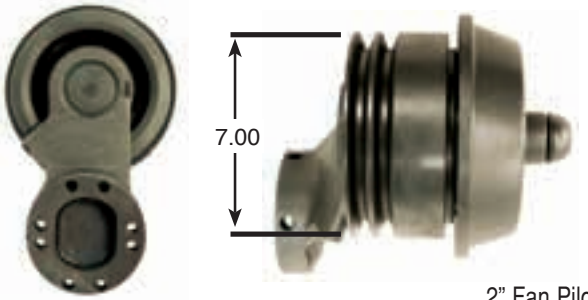

2" Fan Pilot

104772X

Kit # 104941

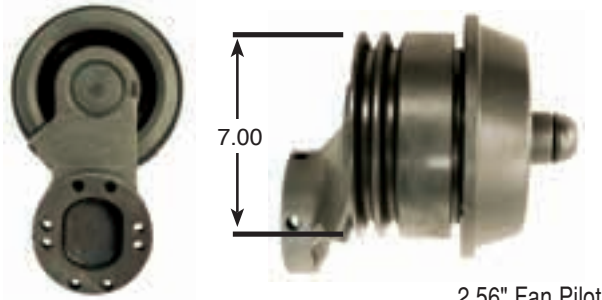

2.56" Fan Pilot

104773X

Kit # 104939

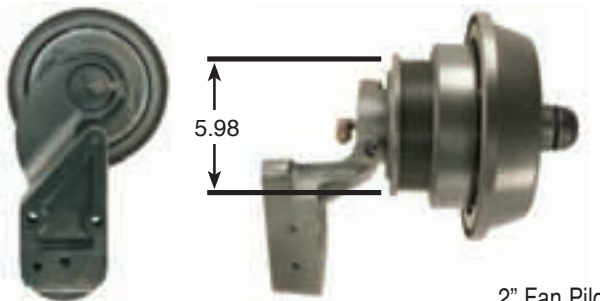

2" Fan Pilot

104775X

Kit # 104941

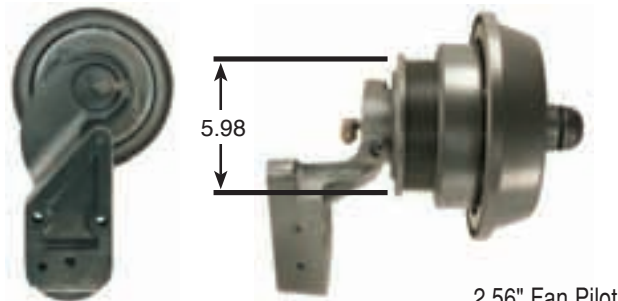

2.56" Fan Pilot

Bendix®

PART NO.

104776X

Kit # 104939

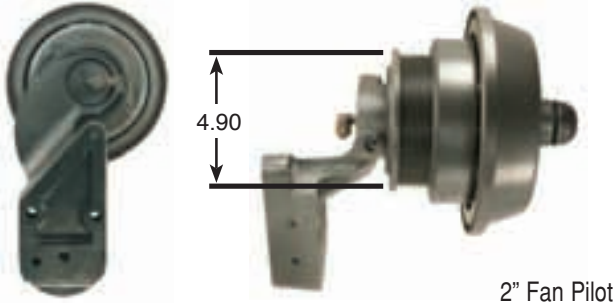

2" Fan Pilot

PART NO.

104778X

Kit # 104941

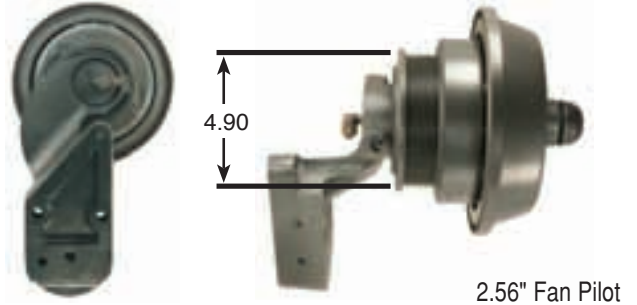

2.56" Fan Pilot

104782X

Kit # 104939

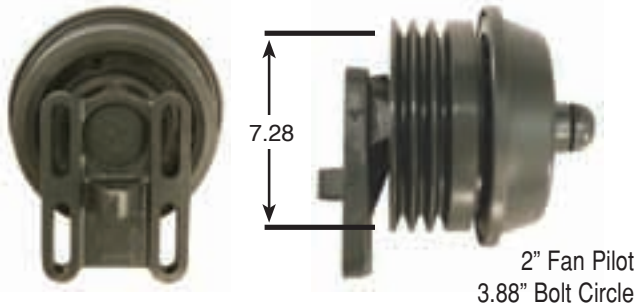

2" Fan Pilot
3.88" Bolt Circle

104784X

Kit # 104941

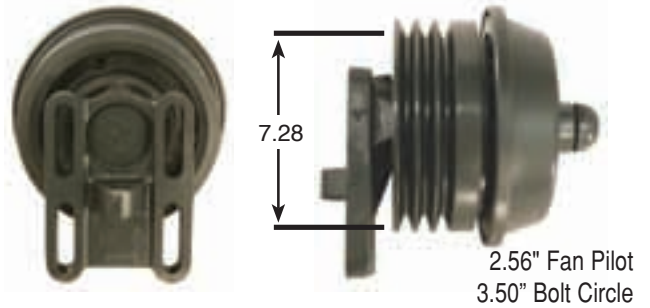

2.56" Fan Pilot
3.50" Bolt Circle

104785X

Kit # 104939

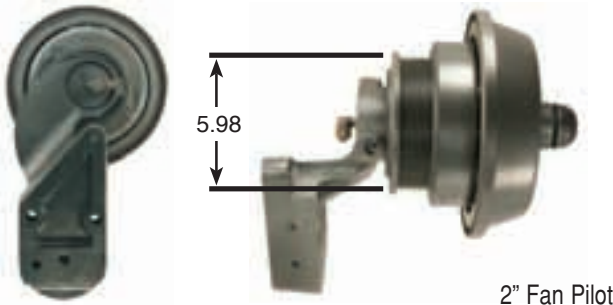

2" Fan Pilot

104787X

Kit # 104941

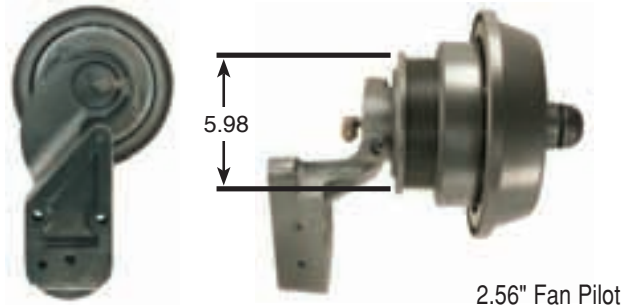

2.56" Fan Pilot

104870X

Kit # 104939

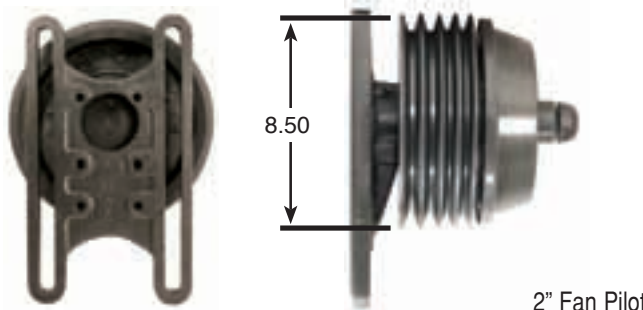

2" Fan Pilot

104871X

Kit # 104939

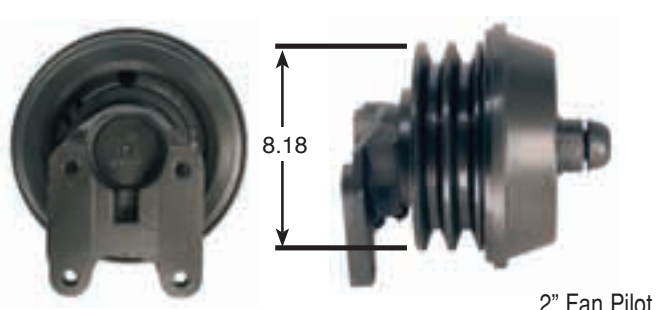

2" Fan Pilot

PART NO.

104872X

Kit # 104939

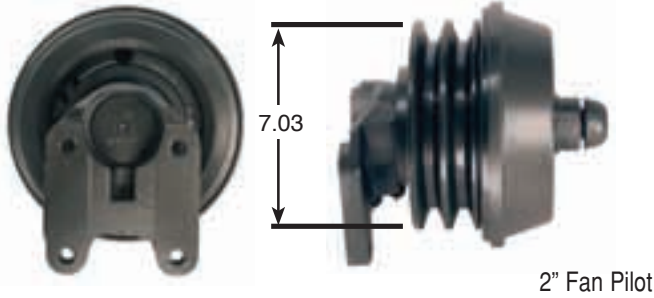

PART NO.

104873X

Seal Kit # 104937

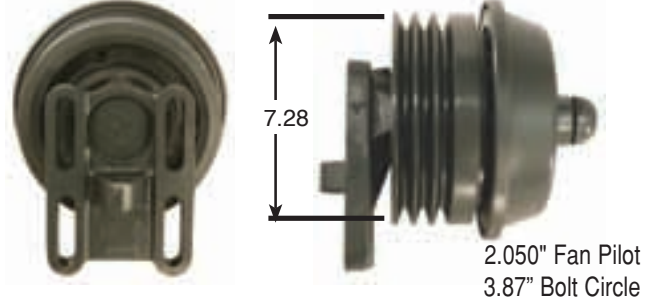

104874X

Kit # 104939

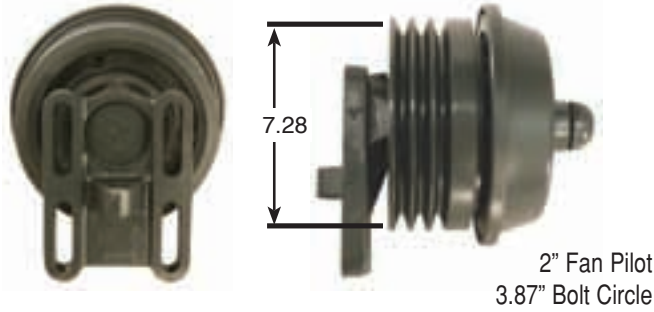

104875X

Kit # 104939

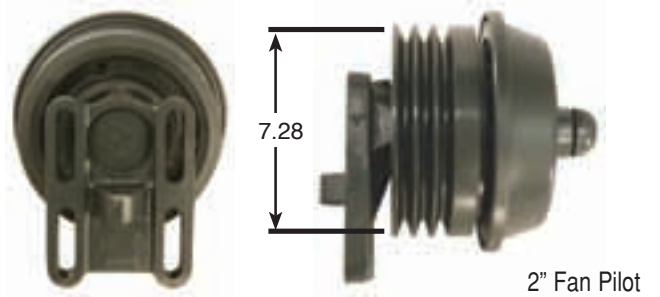

104876X

Kit # 104939

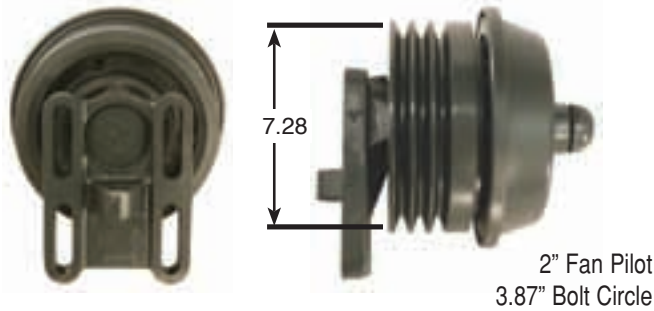

104877X

Kit # 104939

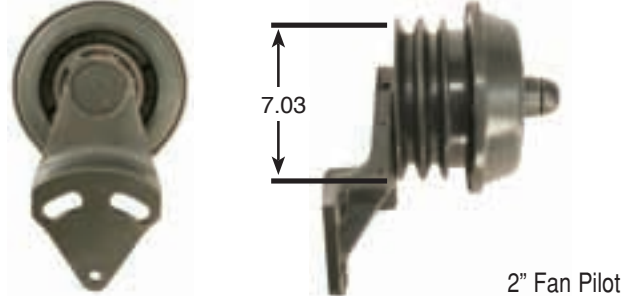

104878X

Kit # 104939

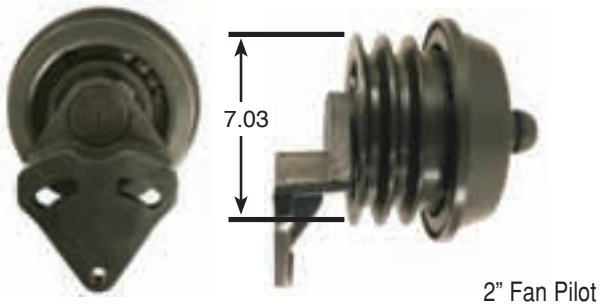

104879X/104881X Kit # 104939

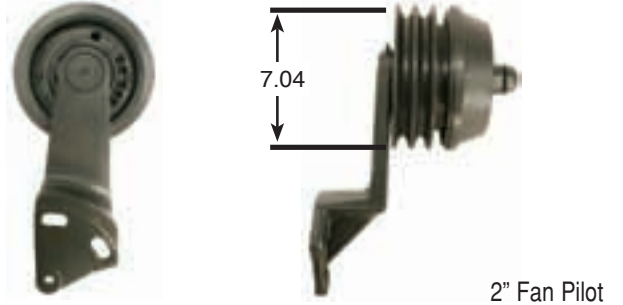

Bendix®

PART NO.

104880X/104882X Kit # 104939



2" Fan Pilot

PART NO.

104883X/104887X Kit # 104939

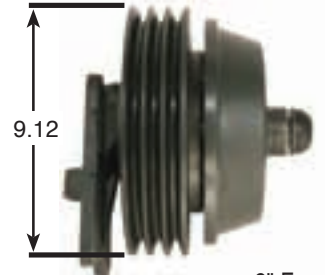

2" Fan Pilot

104884X/104885X Seal Kit # 104937

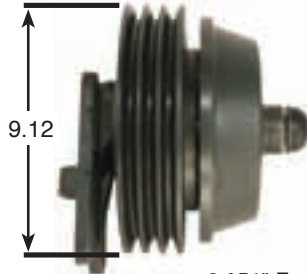

2.051" Fan Pilot

104886X Seal Kit # 104937

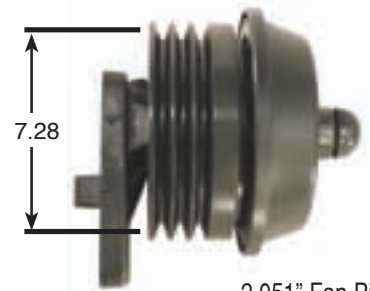

2.051" Fan Pilot

104887X Kit # 104939

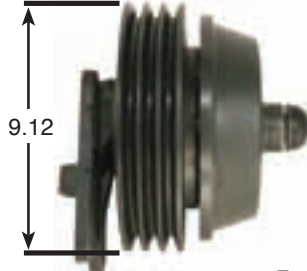

2.051" Fan Pilot

104889X Kit # 104939

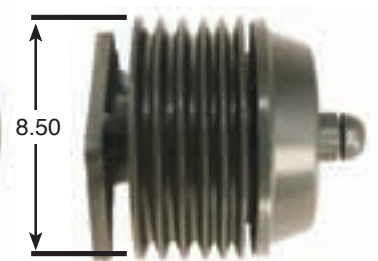

104890X/104891X Kit # 104939

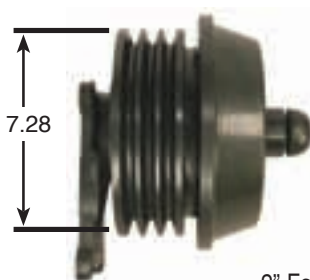

2" Fan Pilot

104892X Seal Kit # 104937

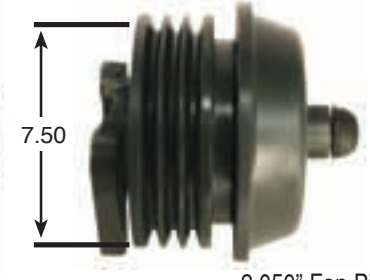

2.050" Fan Pilot

PART NO.

104893X

Kit # 104939

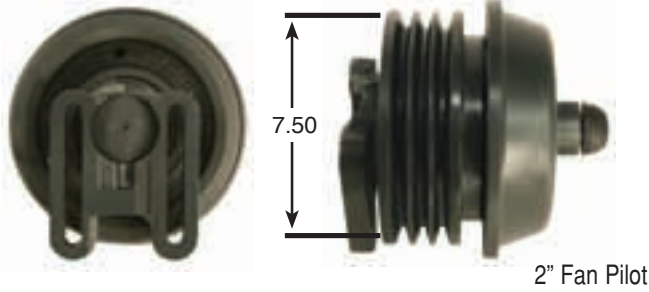

2" Fan Pilot

PART NO.

104894X

Kit # 104939

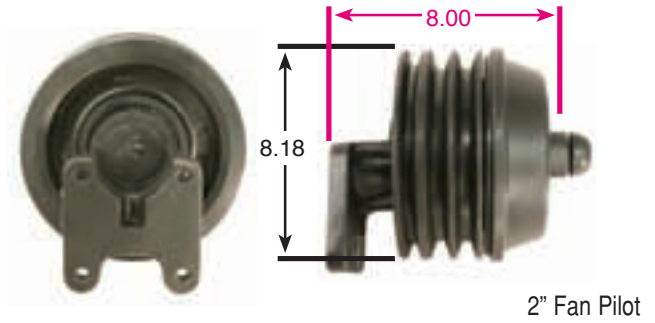

2" Fan Pilot

104896X

Seal Kit # 104937

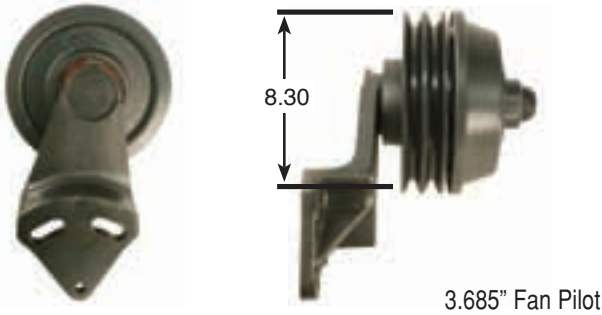

3.685" Fan Pilot

104897X

Seal Kit # 104937

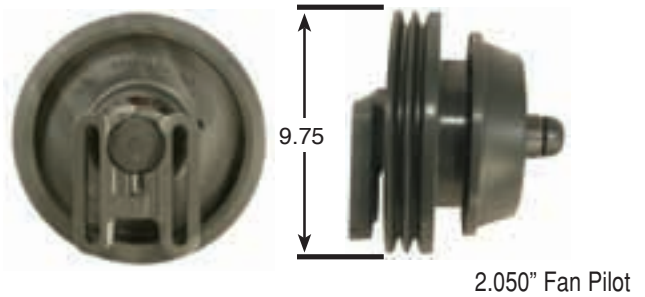

2.050" Fan Pilot

104898X

Seal Kit # 104937

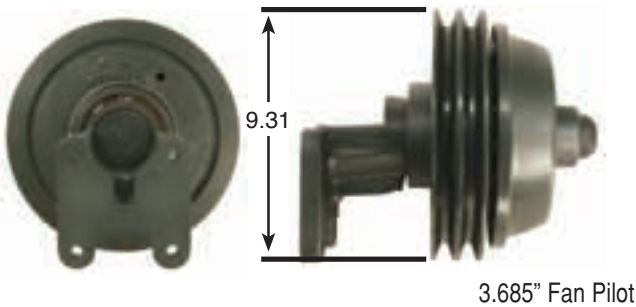

3.685" Fan Pilot

104899X

Seal Kit # 104937

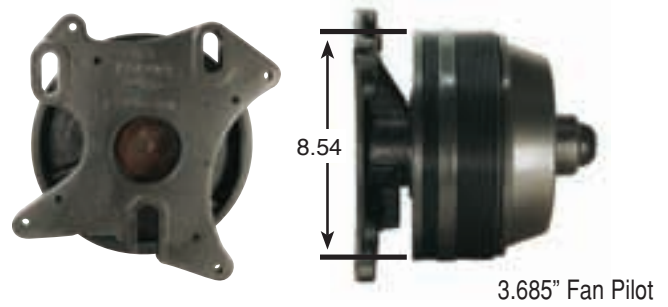

3.685" Fan Pilot

104900X

Seal Kit # 104937

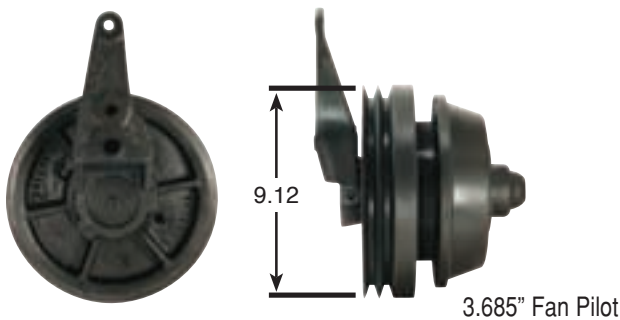

3.685" Fan Pilot

104901X

Kit # 104939

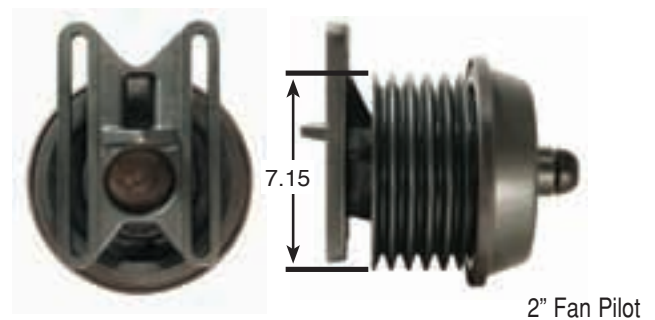

2" Fan Pilot

Bendix®

PART NO.

104902X/104903X Kit # 104939

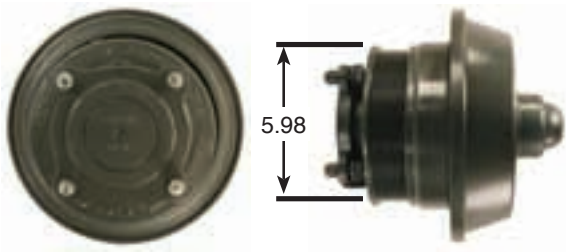

2" Fan Pilot

PART NO.

104905X Kit # 104939

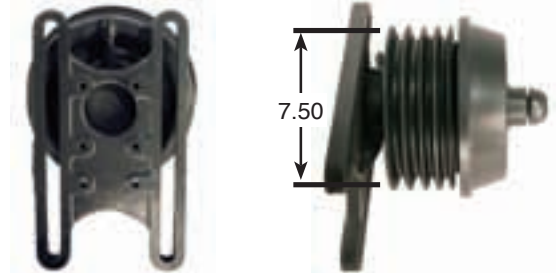

2" Fan Pilot

104965X

Kit # 104939

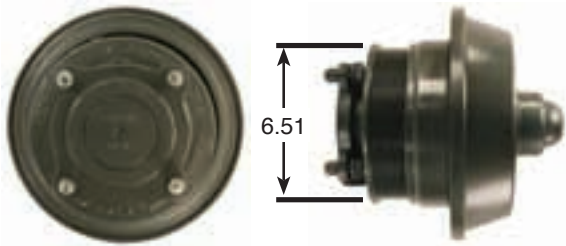

2" Fan Pilot

104981X

Kit # 104941

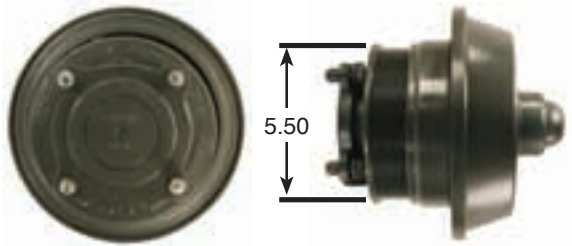

2.56" Fan Pilot

104989X

Kit # 104941

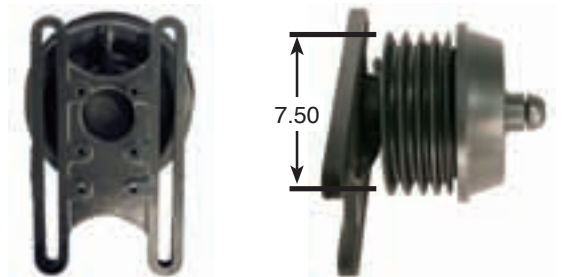

2.56" Fan Pilot

104990X

Kit # 104941

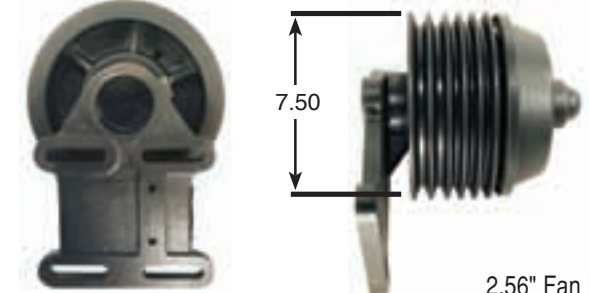

2.56" Fan Pilot

106092X

Kit # 104941

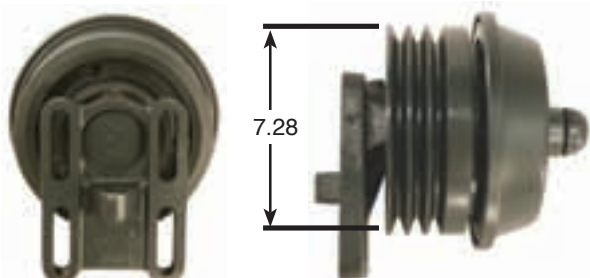

2.56" Fan Pilot

106093X

Kit # 104941

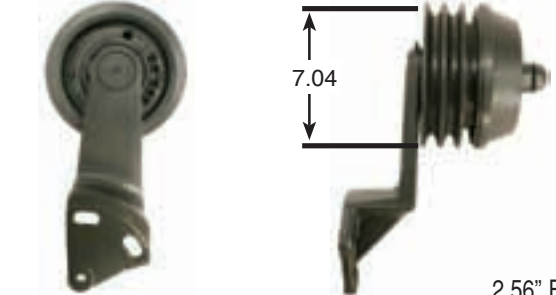

2.56" Fan Pilot

PART NO.

106095X

Kit # 104941

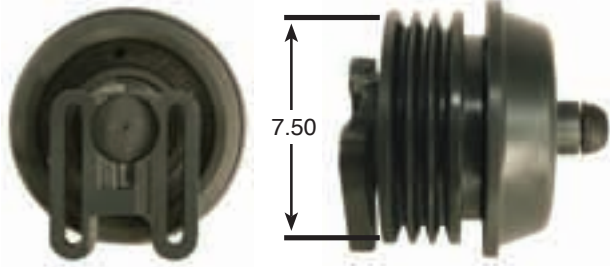

2.56" Fan Pilot

PART NO.

106096X

Kit # 104941

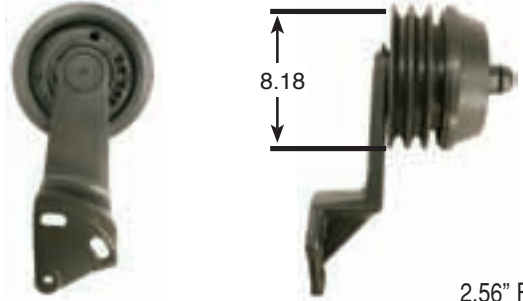

2.56" Fan Pilot

106097X

Kit # 104941

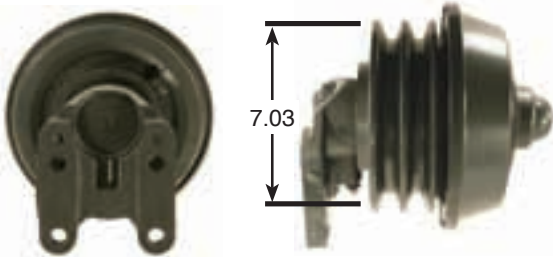

2.56" Fan Pilot

106098X

Kit # 104941

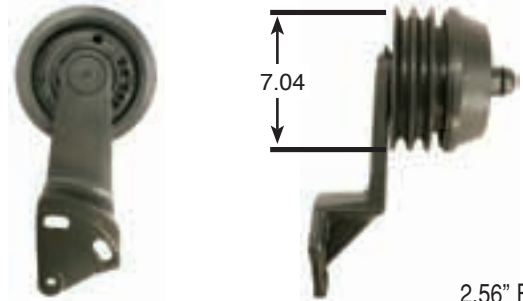

2.56" Fan Pilot

106099X

Kit # 104941

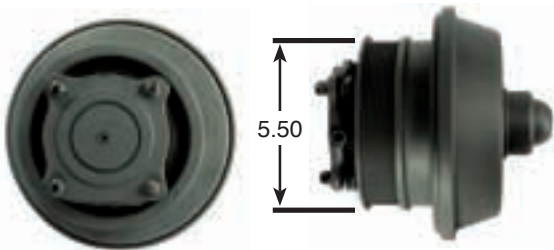

2.56" Fan Pilot

106120X/106235X Kit # 104941

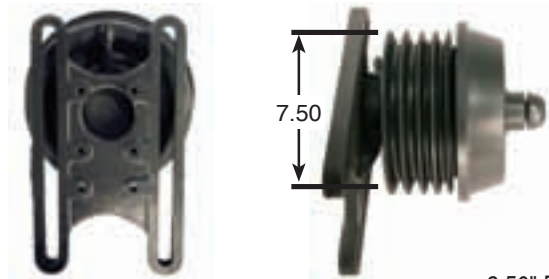

2.56" Fan Pilot

106236X

Kit # 104941

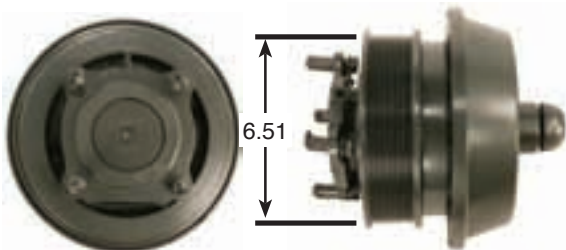

2.56" Fan Pilot

106238X

Kit # 104941

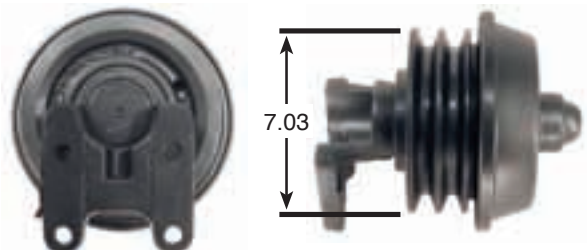

2.56" Fan Pilot

Bendix®

PART NO.

106271X

Kit # 104941

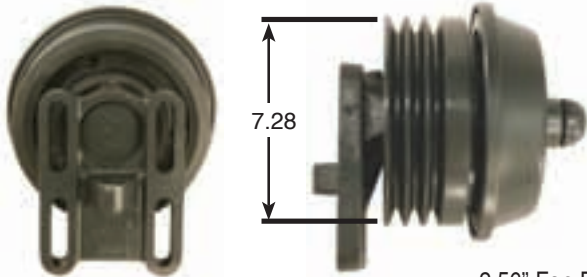

2.56" Fan Pilot

PART NO.

106272X

Kit # 104941

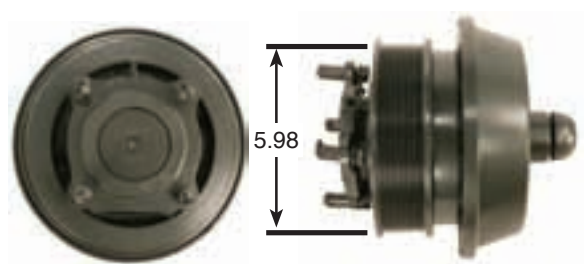

2.56" Fan Pilot

106350X

Kit # 104941

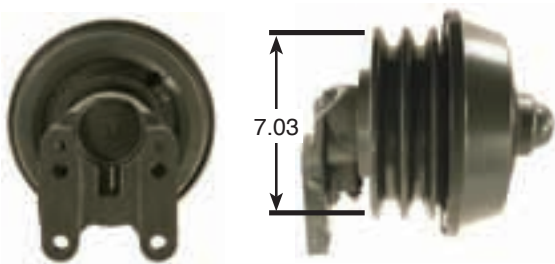

2.56" Fan Pilot

106450X

Kit # 104941

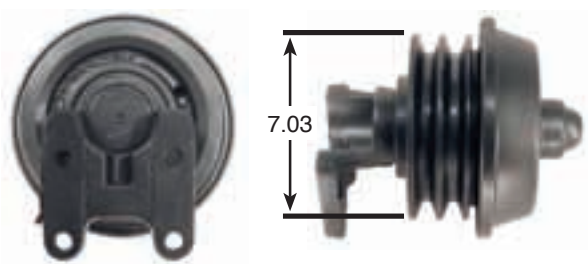

2.56" Fan Pilot

106724X

Kit # 106731

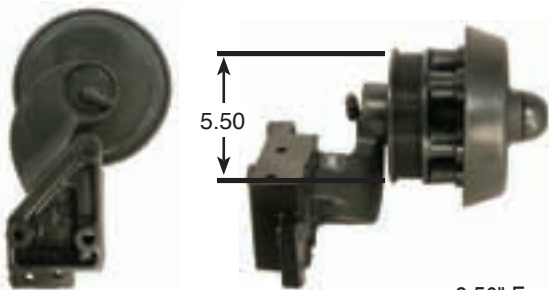

2.56" Fan Pilot

106842X

Kit # 104941

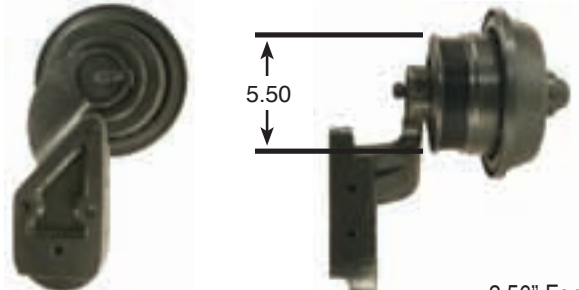

2.56" Fan Pilot

106844X

Kit # 104939

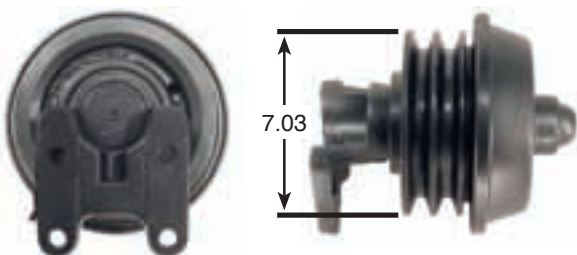

2" Fan Pilot

106866X

Kit # 104939

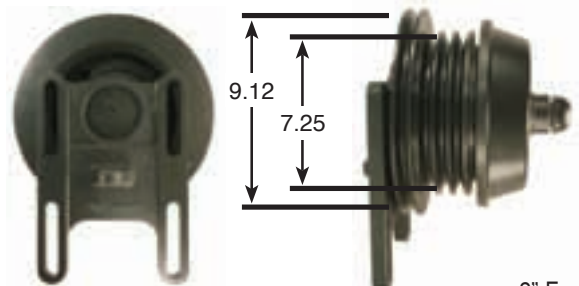

2" Fan Pilot

PART NO.

106876X

Kit # 104941

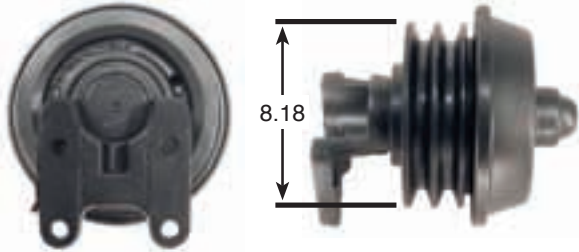

2.56" Fan Pilot

PART NO.

106970X

Kit # 106731

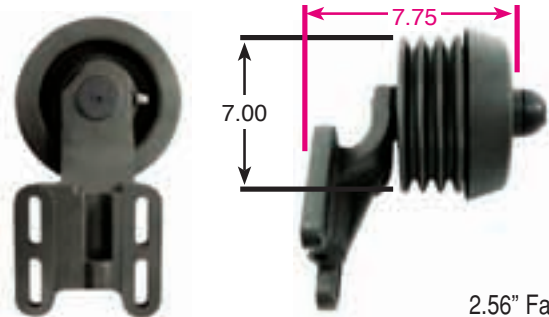

2.56" Fan Pilot

106974X

Kit # 106731

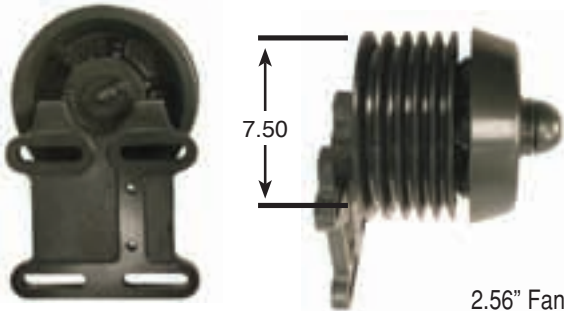

2.56" Fan Pilot

107473X

Kit # 106731

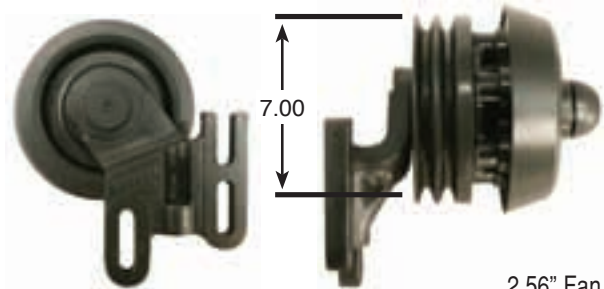

2.56" Fan Pilot

107542X

Kit # 106731

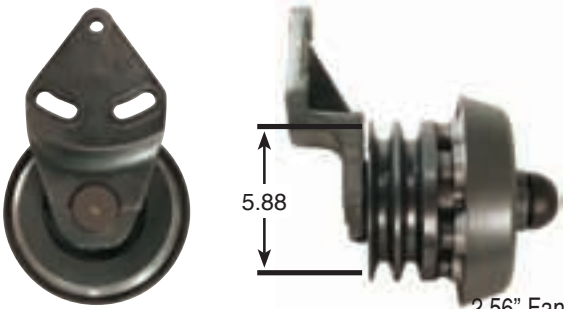

2.56" Fan Pilot

107543X

Kit # 106731

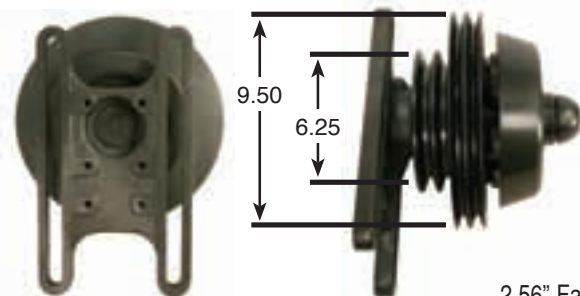

2.56" Fan Pilot

107580X

Kit # 104939

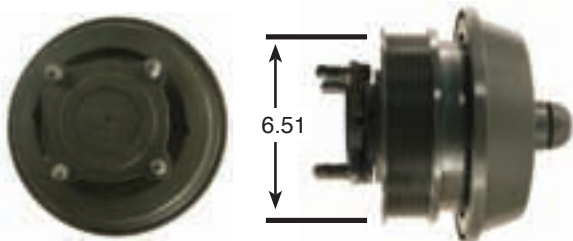

2" Fan Pilot

107627X

Kit # 106731

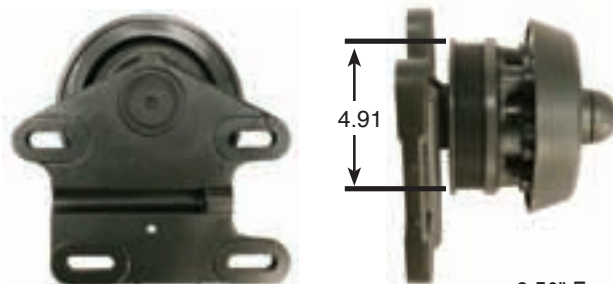

2.56" Fan Pilot

Bendix®

PART NO.

107638X

Kit # 104939

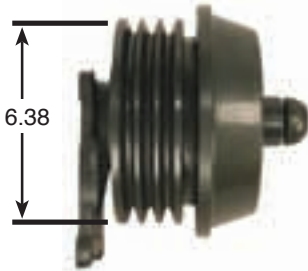

2" Fan Pilot

PART NO.

107901X

Kit # 106731

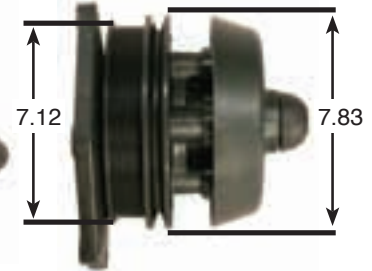

2.56" Fan Pilot

107940X

Kit # 104940



2" Fan Pilot
counterclockwise rotation

107942X

Kit # 106731

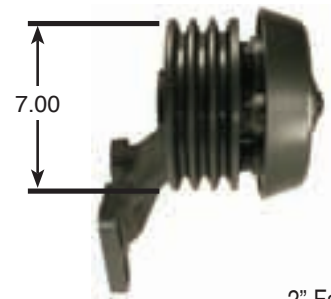

2" Fan Pilot

107970X

Kit # 104939



2" Fan Pilot

108006X

Kit # 104941

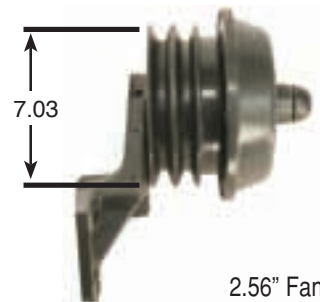

2.56" Fan Pilot

108122X

Kit # 106731

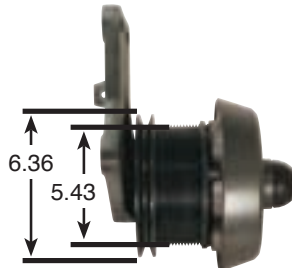

2.56" Fan Pilot

108323X

Kit # 104939



2" Fan Pilot

PART NO.

108378X

Kit # 106731

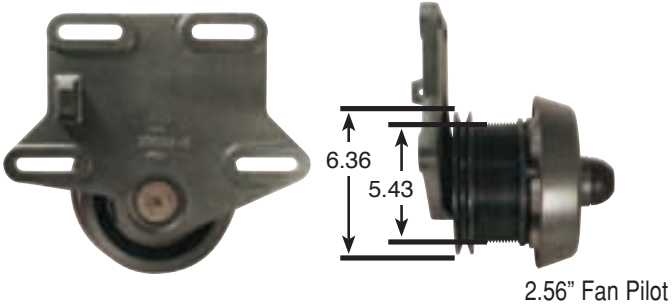

PART NO.

108460X

Kit # 106731

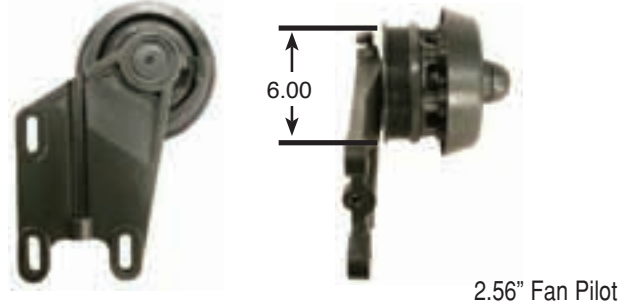

108461X

Kit # 106731

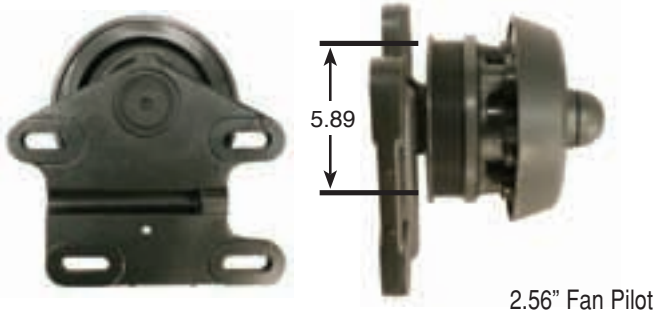

108463X

Kit # 106731

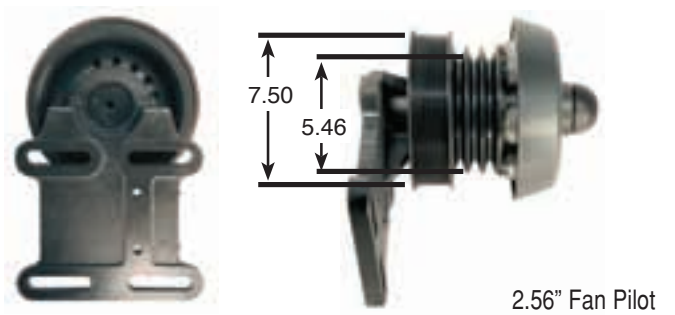

108464X

Kit # 106731

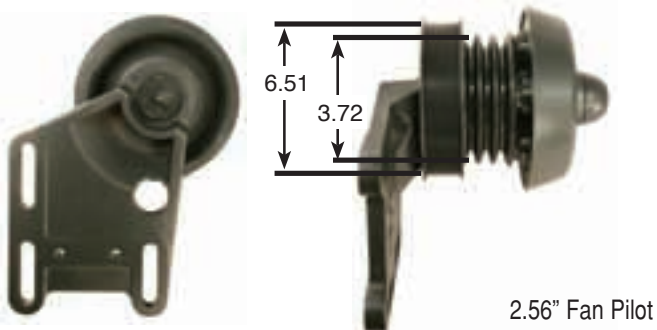

108483X

Kit # 106731

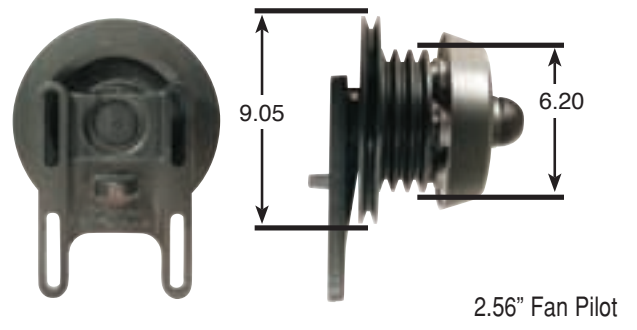

108530X

Kit # 106731

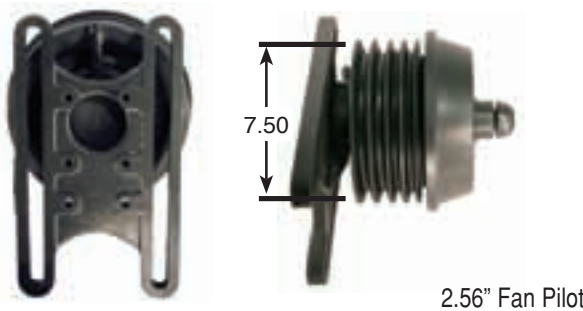

108533X

Kit # 106731

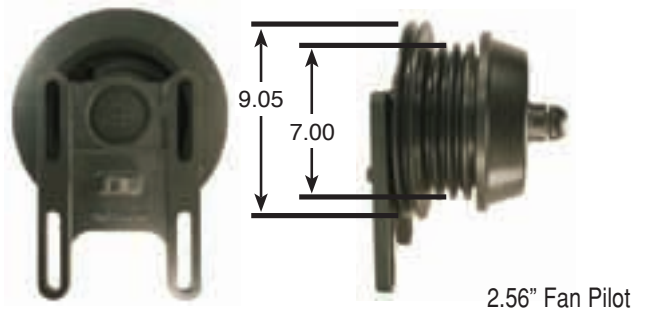

Bendix®

PART NO.

108534X

Kit # 106731

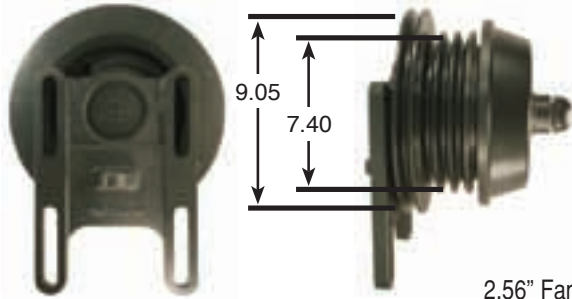

2.56" Fan Pilot

PART NO.

108552X

Kit # 106731

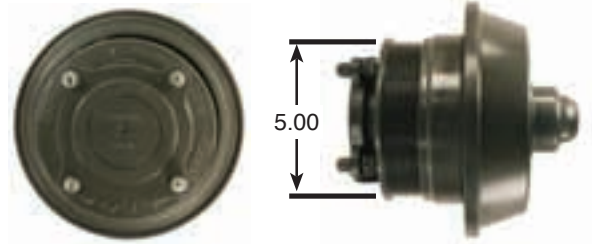

2.56" Fan Pilot

108553X

Kit # 106731

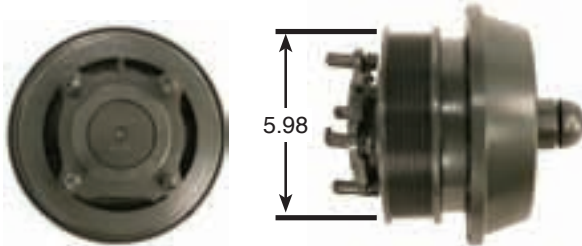

2.56" Fan Pilot

108621X

Kit # 106731

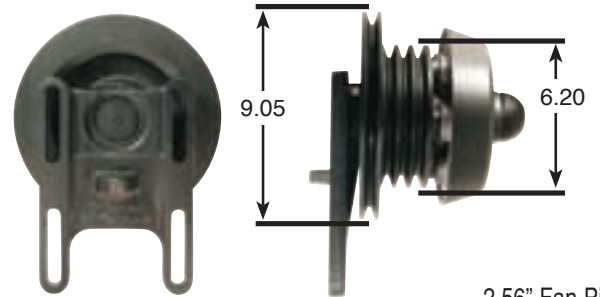

2.56" Fan Pilot

108696X

Kit # 106731

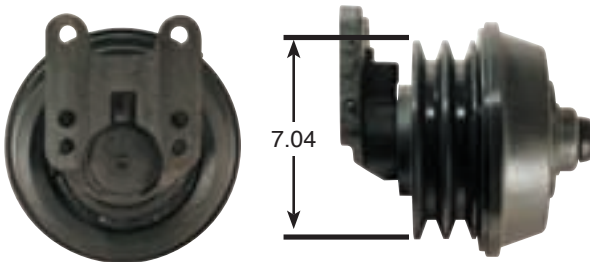

2.56" Fan Pilot

108697X

Kit # 106731

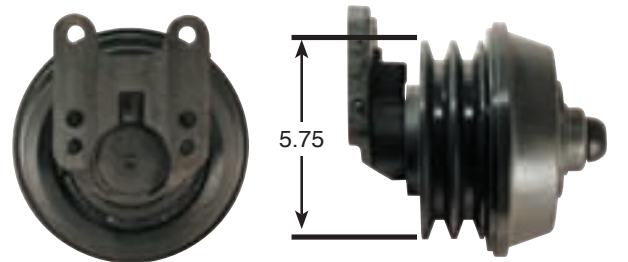

2.56" Fan Pilot

109032X

Kit # 104939

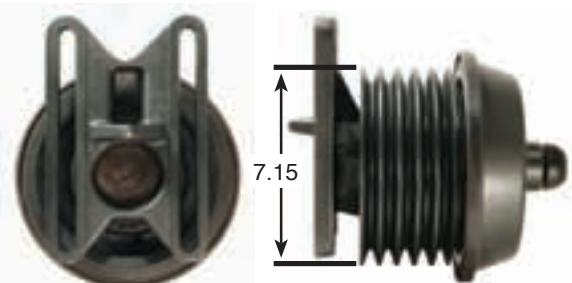

2" Fan Pilot

109355X

Kit # 106731



Cross Reference - 7500/9500 & GT

MFGR PART #	KIT MASTERS PART #	USE KIT	Also Use Kit	CAT. PAGE #	MFGR PART #	KIT MASTERS PART #	USE KIT	Also Use Kit	CAT. PAGE #	MFGR PART #	KIT MASTERS PART #	USE KIT	Also Use Kit	CAT. PAGE #
590000	90000	7500HP		37	591035	91035	9500HP		19	791017	91017	9505SP		19
590001	90001	7500HP		37	591036	91036	9500HP		41	791018	91018	9500HP		39
590002	90002	7500HP		37	591037	91037	9500HP		58	791019	91019	9500HP		40
590003	90003	7500HP		57	591038	91038	9500HP		19	791020	91020	9500HP		19
590004	90004	7500HP		57	790000	90000	7500HP		37	791021	91021	9500HP		40
590005	90005	7500HP		17	790001	90001	7500HP		37	791022	91022	9500HP		40
590007	90007	7500HP		17	790002	90002	7500HP		37	791023	91023	9500HP		58
590008	90008	7500HP		37	790003	90003	7500HP		57	791024	91024	9500HP		58
590009	90009	7500HP		57	790004	90004	7500HP		57	791025	91025	9500HP		19
590010	90010	7500HP		37	790005	90005	7500HP		17	791026	91026	9500HP		40
590011	90011	7500HP		57	790007	90007	7500HP		17	791027	91027	9500HP		19
590012	90012	7500HP		37	790008	90008	7500HP		37	791028	91028	9500HP		19
590013	90013	7500HP		37	790009	90009	7500HP		57	791029	91029	9500HP		40
590014	90014	7500HP		17	790010	90010	7500HP		37	791030	91030	9500HP		40
590015	90015	7500HP		17	790011	90011	7500HP		57	791031	91031	9500HP		58
590016	90016	7500HP		37	790012	90012	7500HP		37	791032	91032	9500HP		40
590017	90017	7500HP		38	790013	90013	7500HP		37	791033	91033	9500HP		58
590018	90018	7500HP		57	790014	90014	7500HP		17	791034	91034	9500HP		40
591000	91000	9500HP		39	790015	90015	7500HP		17	791035	91035	9500HP		19
591001	91001	9500HP		39	790016	90016	7500HP		37	791036	91036	9500HP		41
591002	91002	9500HP		17	790017	90017	7500HP		38	791037	91037	9500HP		58
591003	91003	9505SP		18	790018	90018	7500HP		57	791038	91038	9500HP		19
591004	91004	9500HP		39	790019	90019	7500HP		57	791039	91039	9500HP		69
591005	91005	9500HP		18	790020	90020	7500HP		57	791040	91040	9500HP		69
591006	91006	9500HP		39	790021	90021	7500HP		38	791041	91041	9500HP		69
591007	91007	9500HP		18	790022	90022	7500HP		17	791042	91042	9500HP		66
591008	91008	9500HP		18	790023	90023	7500HP		38	791043	91043	9500HP		66
591009	91009	9500HP		39	790024	90024	7500HP		38	791044	91044	9500HP		41
591010	91010	9500HP		39	790025	90025	7500HP		38	791045	91045	9500HP		41
591011	91011	9500HP		58	790026	90026	7500HP		**	791046	91046	9500HP		58
591012	91012	9505SP		18	790027	90027	7500HP		38	791047	91047	9500HP		58
591013	91013	9500HP		18	790028	90028	7500HP		17	791048	91048	9500HP		19
591014	91014	9500HP		18	790029	90029	7500HP		57	791049	91049	9500HP		20
591015	91015	9500HP		18	790030	90030	7500HP		17	791050	91050	9500HP		59
591016	91016	9500HP		39	790031	90031	7500HP		38	791051	91051	9500HP		20
591017	91017	9505SP		19	790032	90032	7500HP		38	791052	91052	9500HP		59
591018	91018	9500HP		39	791000	91000	9500HP		39	791054	91054	9500HP		41
591019	91019	9500HP		40	791001	91001	9500HP		39	791055	91055	9500HP		41
591020	91020	9500HP		19	791002	91002	9500HP		17	791056	91056	9500HP		41
591021	91021	9500HP		40	791003	91003	9505SP		18	791057	91057	9500HP		20
591022	91022	9500HP		40	791004	91004	9500HP		39	791058	91058	9500HP		41
591023	91023	9500HP		58	791005	91005	9500HP		18	791059	91059	9500HP		20
591024	91024	9500HP		58	791006	91006	9500HP		39	791060	91060	9500HP		20
591025	91025	9500HP		19	791007	91007	9500HP		18	791061	91061	9500HP		41
591026	91026	9500HP		40	791008	91008	9500HP		18	791062	91062	9500HP		59
591027	91027	9500HP		19	791009	91009	9500HP		39	791063	91063	9500HP		20
591028	91028	9500HP		19	791010	91010	9500HP		39	791064	91064	9500HP		42
591029	91029	9500HP		40	791011	91011	9500HP		58	791065	91065	9500HP		59
591030	91030	9500HP		40	791012	91012	9505SP		18	791066	91066	9500HP		20
591031	91031	9500HP		58	791013	91013	9500HP		18	791067	91067	9500HP		20
591032	91032	9500HP		40	791014	91014	9500HP		18	791068	91068	9500HP		21
591033	91033	9500HP		58	791015	91015	9500HP		18	791069	91069	9500HP		21
591034	91034	9500HP		40	791016	91016	9500HP		39	791070	91070	9500HP		21

Cross Reference - 7500/9500 & GT

MFGR PART #	KIT MASTERS PART #	USE KIT	Also Use Kit	CAT. PAGE #	MFGR PART #	KIT MASTERS PART #	USE KIT	Also Use Kit	CAT. PAGE #	MFGR PART #	KIT MASTERS PART #	USE KIT	Also Use Kit	CAT. PAGE #
791071	91071	9500HP		21	799037	99037	14-256		23	799346	99346	14-256		32
791072	91072	9500HP		42	799039	99039	14-256		**	799360	99360	14-256		32
791073	91073	9500HP		42, 72	799040	99040	14-256		46	799381	99381	14-256		70
791074	91074	9500HP		42	799041	99041	14-256		61	799410	99410	14-256		64
791075	91075	9500HP		42	799044	99044	14-256		23	799491	99247	14-256		67
791076	91076	9500HP		21	799047	99047	14-256		46	799492	99400	14-256		67
791077	91077	9500HP		59	799049	99049	14-256		61	799493	99399	14-256		67
791078	91078	9500HP		42	799052	99052	14-256		47	799494	99347	14-256		67
791079	91079	9500HP		42	799057	99057	14-256		47	799495	99348	14-256		67
791080	91080	9500HP		42	799065	99065	14-256		62	799496	99423	14-256		68
791081	91081	9500HP		21	799067	99067	14-256		62	799497	99497	14-256		68
791082	91082	9500HP		21	799068	99068	14-256		23	799498	99498	14-256		**
791083	91083	9500HP		59	799070	99070	14-256		24	799499	99426	14-256		68
791084	91084	9500HP		72	799073	99073	14-256		24	799801	99801	14-256		55
791085	91085	9500HP		21	799074	99074	14-256		24	79A8600	99600	14-256		55
791086	91086	9500HP		43	799077	99077	14-256-1		70	79A8601	99601	14-256		55
791087	91087	9500HP		22	799078	99078	14-256		24	79A8611	99611	14-256		**
791088	91088	9500HP		43	799079	99079	14-256		24	79A9019	99019	14-256		72
791089	91089	9500HP		22	799082	99082	14-256		48	79A9023	99023	14-256		66
791090	91090	9500HP		22	799084	99084	14-256		25	79A9064	99064	14-256		62
791091	91091	9500HP		59	799090	99090	14-256		48	79A9065	99065	14-256		62
791092	91092	9500HP		43	799098	99098	14-256		25	79A9067	99067	14-256		62
791093	91093	9504HP		43	799103	99103	14-256		25	79A9068	99068	14-256		23
791094	91094	9500HP		43	799128	99128	14-256		50	79A9073	99073	14-256		24
791095	91095	9500HP		43	799131	99131	14-256		50	79A9074	99074	14-256		24
791096	91096	9500HP		43	799142	99142	14-256-1		70	79A9079	99079	14-256		24
791097	91097	9500HP		22	799143	99143	14-256-1		70	79A9098	99098	14-256		25
791098	91098	9500HP		22	799154	99154	14-256		51	79A9103	99103	14-256		25
791099	91099	9500HP		43	799161	99161	14-256		26	79A9131	99131	14-256		50
791100	91100	9500HP		44	799168	99168	14-256		51	79A9168	99168	14-256		51
791101	91101	9500HP		44	799189	99189	14-256		27	79A9205	99205	14-256		52
791102	91102	9500HP		22	799191	99191	14-256	300SK	27	79A9222	99222	14-256		63
791103	91103	9500HP		44	799205	99205	14-256		52	79A9223	99223	14-256		63
791104	91104	9500HP		44	799223	99223	14-256		63	79A9238	99238	14-256		53
791105	91105	9500HP		59	799238	99238	14-256		53	79A9263	99263	14-256		53
791106	91106	9500HP		22	799263	99263	14-256		53	79A9268	99268	14-256		64
791107	91107	9500HP		60	799285	99285	14-256		69	79A9285	99285	14-256		69
791108	91108	9500HP		44	799291	99291	14-256		29	79A9291	99291	14-256		29
791109	91109	9500HP		44	799292	99292	14-256		29	79A9298	99298	14-256		29
791110	91110	9500HP		44	799298	99298	14-256		29	79A9300	99300	14-256		64
791111	91111	9500HP		44	799300	99300	14-256		64	79A9306	99306	14-256		**
791112	91112	9500HP		45	799311	99311	14-256-1		29	79A9313	99313	14-256		30
791113	91113	9500HP		45	799313	99313	14-256		30	79A9316	99316	14-256		30
791114	91114	9500HP		60	799316	99316	14-256		30	79A9317	99317	14-256		30
791115	91115	9505SP		22	799317	99317	14-256		30	79A9318	99318	14-256		30
791116	91116	9500HP		23	799318	99318	14-256		30	79A9319	99319	14-256		30
799004	99004	14-256		57	799323	99323	14-256		30	79A9323	99323	14-256		**
799005	99005	14-256		45	799326	99326	14-256		54	79A9326	99326	14-256		54
799012	99012	14-256		23	799333	99333	14-256		31	79A9333	99333	14-256		31
799019	99019	14-256		72	799334	99334	14-256		31	79A9334	99334	14-256		31
799023	99023	14-256		66	799336	99336	14-256-1		70	79A9346	99346	14-256		32
799024	99024	14-256		66	799339	99339	14-256-1		31	79A9360	99360	14-256		32
799027	99027	14-256	250SK	61	799341	99341	14-256-1		31	79A9361	99361	14-256		32

** NON-STANDARD: OEM# is not available as a standard remanufactured fan clutch. Kit Masters does stock many non-standard items, please call for availability.

Cross Reference - 7500/9500 & GT

MFGR PART #	KIT MASTERS PART #	USE KIT	Also Use Kit	CAT. PAGE #	MFGR PART #	KIT MASTERS PART #	USE KIT	Also Use Kit	CAT. PAGE #	MFGR PART #	KIT MASTERS PART #	USE KIT	Also Use Kit	CAT. PAGE #
79A9362	99362	14-256		32	829853	Use Kit	7500HP		**	980013	90013	7500HP		37
79A9366	99366	14-256		33	829854	90004	7500HP		57	980014	90014	7500HP		17
79A9410	99410	14-256		64	829855	Use Kit	7500HP		**	980015	90009	7500HP		57
79A9421	99421	14-256		**	829861	Use Kit	7500HP		**	980016	Use Kit	7500HP		**
79A9428	99428	14-256		35	829864	90810	94207		**	980017	90015	7500HP		17
79A9437	99437	14-256		**	839803	90023	7500HP		38	980018	Use Kit	7500HP		**
79A9465	99197	14-256		52, 72	839806	Use Kit	7500HP		**	980019	Use Kit	7500HP		**
79A9466	99466	14-256		55	839811	90000	7500HP		37	980020	91000	9500HP		39
79A9493	99399	14-256		67	839812	Use Kit	7500HP		**	980021	Use Kit	7500HP		**
79A9515	99188	14-256		52	839813	90000	7500HP		37	980022	Use Kit	7500HP		**
79A9801	99801	14-256		55	839822	Use Kit	7500HP		**	980023	90014	7500HP		17
79A9809	99809	14-256		36	839832	90003	7500HP		57	980024	90017	7500HP		38
79A9818	99818	14-256		36	839854	90004	7500HP		57	980025	Use Kit	7500HP		**
79A9850	99850	14-256		65	839861	Use Kit	7500HP		**	980026	90015	7500HP		17
79A9897	99897	14-256		56	839864	90810	94207		**	980027	90016	7500HP		37
79A9898	99834	14-256		36	839865	90005	7500HP		17	980028	90005	7500HP		17
809800	Use Kit	7500HP		**	839874	91005	9500HP		18	980029	Use Kit	7500HP		**
809803	90023	7500HP		38	843826	90002	7500HP		37	980031	Use Kit	7500HP		**
809804	91001	9500HP		39	849803	90010	7500HP		37	980032	Use Kit	7500HP		**
809806	Use Kit	7500HP		**	849812	91000	9500HP		39	980033	Use Kit	7500HP		**
809811	90000	7500HP		37	849813	91016	9500HP		39	980036	90014	7500HP		17
809812	Use Kit	7500HP		**	849822	Use Kit	7500HP		**	980037	90018	7500HP		57
809815	90008	7500HP		37	849874	Use Kit	7500HP		**	980038	Use Kit	7500HP		**
809823	90001	7500HP		37	859803	91001	9500HP		39	980039	Use Kit	7500HP		**
809826	90002	7500HP		37	859822	91004	9500HP		39	980040	90002	7500HP		37
809829	Use Kit	7500HP		**	859865	90005	7500HP		17	980043	90022	7500HP		17
809832	90003	7500HP		57	859867	91002	9500HP		17	980044	90019	7500HP		57
809835	Use Kit	7500HP		**	869811	90000	7500HP		37	980045	Use Kit	7500HP		**
809845	Use Kit	7500HP		**	869822	91006	9500HP		39	980046	Use Kit	7500HP		**
809849	90011	7500HP		57	869864	90022	7500HP		17	980048	Use Kit	7500HP		**
809853	Use Kit	7500HP		**	869865	90007	7500HP		17	980049	90021	7500HP		38
809854	90004	7500HP		57	879812	Use Kit	7500HP		**	980050	90019	7500HP		57
809861	Use Kit	7500HP		**	879823	90804	94207		**	980051	90021	7500HP		38
809864	Use Kit	7500HP		**	879865	90005	7500HP		17	980052	Use Kit	7500HP		**
809865	90005	7500HP		17	879867	91002	9500HP		17	980053	Use Kit	7500HP		**
819803	90023	7500HP		38	889803	90010	7500HP		37	980054	Use Kit	7500HP		**
819804	90010	7500HP		37	889812	Use Kit	9500HP		**	980055	90017	7500HP		38
819806	Use Kit	7500HP		**	889867	91003	9505SP		18	980056	90015	7500HP		17
819811	90000	7500HP		37	889874	Use Kit	9500HP		**	980057	Use Kit	7500HP		**
819812	Use Kit	7500HP		**	899832	90003	7500HP		57	980059	90022	7500HP		17
819820	Use Kit	7500HP		**	899865	90007	7500HP		17	980060	90010	7500HP		37
819823	90001	7500HP		37	899874	Use Kit	9500HP		**	980061	90018	7500HP		57
819826	90002	7500HP		37	900004	Use Kit	7500HP		**	980062	90013	7500HP		37
819829	Use Kit	7500HP		**	900006	90004	7500HP		57	980063	90017	7500HP		38
819849	90009	7500HP		57	980003	90000	7500HP		37	980064	90004	7500HP		57
819853	Use Kit	7500HP		**	980004	Use Kit	7500HP		**	980065	Use Kit	7500HP		**
819854	90004	7500HP		57	980005	Use Kit	7500HP		**	980066	Use Kit	7500HP		**
819855	Use Kit	7500HP		**	980006	Use Kit	7500HP		**	980067	90014	7500HP		17
819861	Use Kit	7500HP		**	980007	Use Kit	7500HP		**	980068	Use Kit	7500HP		**
819865	90005	7500HP		17	980008	90012	7500HP		37	980069	90002	7500HP		37
819875	91027	9500HP		19	980009	90005	7500HP		17	980070	90014	7500HP		17
829826	Use Kit	7500HP		**	980010	90009	7500HP		57	980071	90015	7500HP		17
829832	90003	7500HP		57	980011	91115	9500HP		22	980072	Use Kit	7500HP		**
829839	Use Kit	7500HP		**	980012	Use Kit	7500HP		**	980073	90023	7500HP		38

Cross Reference - 7500/9500 & GT

MFGR PART #	KIT MASTERS PART #	USE KIT	Also Use Kit	CAT. PAGE #	MFGR PART #	KIT MASTERS PART #	USE KIT	Also Use Kit	CAT. PAGE #	MFGR PART #	KIT MASTERS PART #	USE KIT	Also Use Kit	CAT. PAGE #
980074	90016	7500HP		37	981019	91116	9500HP		23	981073	91009	9500HP		39
980075	Use Kit	7500HP		**	981020	Use Kit	9505SP		**	981074	91032	9500HP		40
980076	Use Kit	7500HP		**	981021	Use Kit	9500HP		**	981075	91040	9500HP		69
980077	90012	7500HP		37	981022	91034	9500HP		40	981076	Use Kit	9500HP		**
980078	90000	7500HP		37	981023	91018	9500HP		39	981077	91026	9500HP		40
980079	Use Kit	7500HP		**	981024	91010	9500HP		39	981078	Use Kit	9500HP		**
980080	90005	7500HP		17	981025	Use Kit	9505SP		**	981080	91028	9500HP		19
980081	90007	7500HP		17	981026	Use Kit	9500HP		**	981081	Use Kit	9500HP		**
980082	90002	7500HP		37	981027	Use Kit	9500HP		**	981082	91039	9500HP		69
980083	Use Kit	7500HP		**	981028	91019	9500HP		40	981083	91040	9500HP		69
980084	Use Kit	7500HP		**	981029	Use Kit	9500HP		**	981084	91114	9500HP		60
980085	90003	7500HP		57	981030	91034	9500HP		40	981085	91016	9500HP		39
980086	90003	7500HP		57	981031	91020	9500HP		19	981086	91041	9500HP		69
980087	90009	7500HP		57	981032	Use Kit	9500HP		**	981087	Use Kit	9500HP		**
980088	Use Kit	7500HP		**	981033	91109	9500HP		44	981088	91077	9500HP		59
980089	Use Kit	7500HP		**	981034	91034	9500HP		40	981089	91094	9500HP		43
980090	Use Kit	7500HP		**	981035	91095	9500HP		43	981090	91039	9500HP		69
980091	90008	7500HP		37	981036	91012	9505SP		18	981091	91040	9500HP		69
980092	Use Kit	7500HP		**	981037	91011	9500HP		58	981092	91041	9500HP		69
980093	90001	7500HP		37	981038	91082	9500HP		21	981094	91076	9500HP		21
980094	Use Kit	7500HP		**	981039	91029	9500HP		40	981095	Use Kit	9500HP		**
980095	Use Kit	7500HP		**	981040	91030	9500HP		40	981096	91006	9500HP		39
980096	Use Kit	7500HP		**	981041	91022	9500HP		40	981097	91054	9500HP		41
980097	90010	7500HP		37	981042	91021	9500HP		40	981098	91052	9500HP		59
980098	Use Kit	7500HP		**	981043	Use Kit	9500HP		**	981099	91038	9500HP		19
980099	90013	7500HP		37	981044	Use Kit	9500HP		**	981100	Use Kit	9500HP		**
980100	90018	7500HP		57	981045	Use Kit	9500HP		**	981101	91011	9500HP		58
980101	Use Kit	7500HP		**	981046	Use Kit	9500HP		**	981102	91000	9500HP		39
980102	90020	7500HP		57	981047	91031	9500HP		58	981103	91020	9500HP		19
980103	Use Kit	7500HP		**	981048	91023	9500HP		58	981104	91024	9500HP		58
980104	Use Kit	7500HP		**	981049	91036	9500HP		41	981105	91082	9500HP		21
980105	90004	7500HP		57	981050	91024	9500HP		58	981106	91102	9500HP		22
980107	Use Kit	7500HP		**	981051	91067	9500HP		20	981107	Use Kit	9500HP		**
980108	Use Kit	7500HP		**	981052	Use Kit	9500HP		**	981108	91110	9500HP		44
981000	91003	9505SP		18	981053	91027	9500HP		19	981109	91026	9500HP		40
981001	91027	9500HP		19	981054	91027	9500HP		19	981110	91014	9500HP		18
981002	91000	9500HP		39	981055	Use Kit	9500HP		**	981111	91030	9500HP		40
981003	91103	9500HP		44	981057	91033	9500HP		58	981112	91023	9500HP		58
981004	91012	9505SP		18	981058	Use Kit	9500HP		**	981113	91009	9500HP		39
981005	91015	9500HP		18	981059	91031	9500HP		58	981114	91035	9500HP		19
981006	91007	9500HP		18	981060	91090	9500HP		22	981115	91043	9500HP		66
981007	91008	9500HP		18	981061	91024	9500HP		58	981116	91000	9500HP		39
981008	91108	9500HP		44	981062	91037	9500HP		58	981117	91028	9500HP		19
981009	91000	9500HP		39	981063	91081	9500HP		21	981118	91089	9500HP		22
981010	Use Kit	9500HP		**	981064	91014	9500HP		18	981119	91067	9500HP		20
981011	91009	9500HP		39	981065	Use Kit	9500HP		**	981120	91024	9500HP		58
981012	91016	9500HP		39	981066	Use Kit	9500HP		**	981121	91001	9500HP		39
981013	91026	9500HP		40	981067	91116	9500HP		23	981122	91042	9500HP		66
981014	Use Kit	9500HP		**	981068	Use Kit	9500HP		**	981123	91052	9500HP		59
981015	Use Kit	9500HP		**	981069	91025	9500HP		19	981124	91087	9500HP		22
981016	91017	9505SP		19	981070	91011	9500HP		58	981125	91090	9500HP		22
981017	91104	9500HP		44	981071	91025	9500HP		19	981126	91027	9500HP		19
981018	Use Kit	9505SP		**	981072	Use Kit	9500HP		**	981127	91011	9500HP		58

** NON-STANDARD: OEM# is not available as a standard remanufactured fan clutch. Kit Masters does stock many non-standard items, please call for availability.

Cross Reference - 7500/9500 & GT

MFGR PART #	KIT MASTERS PART #	USE KIT	Also Use Kit	CAT. PAGE #	MFGR PART #	KIT MASTERS PART #	USE KIT	Also Use Kit	CAT. PAGE #	MFGR PART #	KIT MASTERS PART #	USE KIT	Also Use Kit	CAT. PAGE #
981128	91000	9500HP		39	981184	91068	9500HP		21	981238	91038	9500HP		19
981129	91001	9500HP		39	981185	91115	9505SP		22	981239	91019	9500HP		40
981130	91106	9500HP		22	981186	91016	9500HP		39	981240	Use Kit	9500HP		**
981131	Use Kit	9500HP		**	981187	91110	9500HP		44	981241	Use Kit	9500HP		**
981132	91028	9500HP		19	981188	91077	9500HP		59	981242	91036	9500HP		41
981133	91032	9500HP		40	981189	91057	9500HP		20	981243	91009	9500HP		39
981134	Use Kit	9500HP		**	981190	91058	9500HP		41	981244	91068	9500HP		21
981135	Use Kit	9500HP		**	981191	Use Kit	9500HP		**	981245	Use Kit	9500HP		**
981136	91035	9500HP		19	981192	Use Kit	9500HP		**	981246	Use Kit	9500HP		**
981138	91021	9500HP		40	981193	Use Kit	9500HP		**	981247	Use Kit	9500HP		**
981139	91022	9500HP		40	981194	91059	9500HP		20	981248	Use Kit	9500HP		**
981140	91012	9505SP		18	981195	Use Kit	9500HP		**	981249	Use Kit	9500HP		**
981141	91007	9500HP		18	981196	Use Kit	9500HP		**	981250	91071	9500HP		21
981143	91024	9500HP		58	981197	91072	9500HP		42	981251	91026	9500HP		40
981144	91071	9500HP		21	981198	91000	9500HP		39	981252	91000	9500HP		39
981145	91009	9500HP		39	981199	91060	9500HP		20	981253	91026	9500HP		40
981146	91024	9500HP		58	981200	Use Kit	9500HP		**	981254	91095	9500HP		43
981147	91024	9500HP		58	981201	Use Kit	9500HP		**	981255	Use Kit	9500HP		**
981148	91014	9500HP		18	981202	Use Kit	9500HP		**	981256	91082	9500HP		21
981149	91035	9500HP		19	981203	91061	9500HP		41	981257	91028	9500HP		19
981150	91025	9500HP		19	981204	Use Kit	9500HP		**	981258	Use Kit	9500HP		**
981151	91006	9500HP		39	981205	Use Kit	9500HP		**	981260	91000	9500HP		39
981152	91018	9500HP		39	981206	91114	9500HP		60	981261	91007	9500HP		18
981153	91015	9500HP		18	981207	91033	9500HP		58	981262	91001	9500HP		39
981154	91010	9500HP		39	981208	91085	9500HP		21	981264	91081	9500HP		21
981155	91019	9500HP		40	981209	91011	9500HP		58	981265	91005	9500HP		18
981156	91029	9500HP		40	981210	Use Kit	9500HP		**	981266	91116	9500HP		23
981157	91034	9500HP		40	981211	Use Kit	9500HP		**	981267	Use Kit	9500HP		**
981158	91022	9500HP		40	981212	91100	9500HP		44	981268	Use Kit	9500HP		**
981159	91023	9500HP		58	981213	Use Kit	9500HP		**	981269	Use Kit	9500HP		**
981160	91076	9500HP		21	981214	91007	9500HP		18	981270	Use Kit	9500HP		**
981161	91052	9500HP		59	981215	Use Kit	9500HP		**	981271	91055	9500HP		41
981162	91054	9500HP		41	981216	91012	9505SP		18	981272	91032	9500HP		40
981163	91089	9500HP		22	981217	Use Kit	9500HP		**	981273	91016	9500HP		39
981164	91032	9500HP		40	981218	Use Kit	9500HP		**	981274	Use Kit	9500HP		**
981165	91102	9500HP		22	981219	91007	9500HP		18	981275	Use Kit	9500HP		**
981166	Use Kit	9500HP		**	981220	Use Kit	9500HP		**	981276	91056	9500HP		41
981167	91036	9500HP		41	981221	91087	9500HP		22	981277	91068	9500HP		21
981168	91043	9500HP		66	981222	Use Kit	9500HP		**	981278	Use Kit	9500HP		**
981169	91016	9500HP		39	981223	Use Kit	9500HP		**	981279	91001	9500HP		39
981170	91036	9500HP		41	981224	91024	9500HP		58	981280	91109	9500HP		44
981171	91106	9500HP		22	981225	91054	9500HP		41	981281	91017	9505SP		19
981172	91012	9505SP		18	981226	91035	9500HP		19	981282	91008	9505SP		18
981173	Use Kit	9500HP		**	981227	91031	9500HP		58	981283	91112	9500HP		45
981174	Use Kit	9500HP		**	981228	91031	9500HP		58	981284	91003	9505SP		18
981175	Use Kit	9500HP		**	981229	91023	9500HP		58	981285	Use Kit	9505SP		**
981176	91024	9500HP		58	981230	91011	9500HP		58	981286	Use Kit	9500HP		**
981177	91094	9500HP		43	981231	Use Kit	9500HP		**	981287	Use Kit	9500HP		**
981178	Use Kit	9500HP		**	981232	91052	9500HP		59	981288	91004	9500HP		39
981179	91039	9500HP		69	981233	91029	9500HP		40	981289	91104	9500HP		44
981180	91040	9500HP		69	981234	91032	9500HP		40	981290	91103	9500HP		44
981181	91041	9500HP		69	981235	91030	9500HP		40	981291	91108	9500HP		44
981182	91071	9500HP		21	981236	Use Kit	9500HP		**	981292	Use Kit	9500HP		**
981183	91037	9500HP		58	981237	Use Kit	9500HP		**	981294	91007	9500HP		18

Cross Reference - 7500/9500 & GT

MFGR PART #	KIT MASTERS PART #	USE KIT	Also Use Kit	CAT. PAGE #	MFGR PART #	KIT MASTERS PART #	USE KIT	Also Use Kit	CAT. PAGE #	MFGR PART #	KIT MASTERS PART #	USE KIT	Also Use Kit	CAT. PAGE #
981295	91081	9500HP		21	981348	91074	9500HP		42	987004	Use Kit	9500HP		**
981296	Use Kit	9500HP		**	981349	91014	9500HP		18	987005	Use Kit	9500HP		**
981297	91107	9500HP		60	981350	Use Kit	9500HP		**	987006	Use Kit	9500HP		**
981298	91011	9500HP		58	981351	91064	9500HP		42	987007	Use Kit	9500HP		**
981299	91087	9500HP		22	981352	Use Kit	9500HP		**	987008	91079	9500HP		42
981300	91088	9500HP		43	981354	91001	9500HP		39	987009	91075	9500HP		42
981301	91101	9500HP		44	981355	91001	9500HP		39	987010	91042	9500HP		66
981302	Use Kit	9500HP		**	981356	Use Kit	9500HP		**	987011	91043	9500HP		66
981303	91102	9500HP		22	981357	91006	9500HP		39	987016	Use Kit	9500HP		**
981304	91095	9500HP		43	981358	91006	9500HP		39	987017	91078	9500HP		42
981305	91094	9500HP		43	981359	91004	9500HP		39	987018	91073	9500HP		42, 72
981306	Use Kit	9500HP		**	981360	91081	9500HP		21	987019	Use Kit	9500HP		**
981307	Use Kit	9500HP		**	981361	Use Kit	9500HP		**	987024	Use Kit	9500HP		**
981308	Use Kit	9500HP		**	981362	91014	9500HP		18	987025	91084	9500HP		72
981309	91020	9500HP		19	981363	91014	9500HP		18	987026	Use Kit	9500HP		**
981310	91071	9500HP		21	981364	91081	9500HP		21	987027	Use Kit	9500HP		**
981311	91099	9500HP		43	981365	91070	9500HP		21	987028	Use Kit	9500HP		**
981312	91062	9500HP		59	981366	91070	9500HP		21	987029	91037	9500HP		58
981313	Use Kit	9500HP		**	981367	Use Kit	9500HP		**	987030	Use Kit	9500HP		**
981314	Use Kit	9500HP		**	981368	91091	9500HP		59	987032	91084	9500HP		72
981315	Use Kit	9500HP		**	981369	91000	9500HP		39	987033	Use Kit	9500HP		**
981316	91037	9500HP		58	981370	Use Kit	9500HP		**	987034	Use Kit	9500HP		**
981317	91031	9500HP		58	981371	Use Kit	9500HP		**	987035	91073	9500HP		42, 72
981318	91066	9500HP		20	981372	Use Kit	9500HP		**	987036	Use Kit	9500HP		**
981319	91066	9500HP		20	981373	Use Kit	9500HP		**	987037	91044	9500HP		41
981320	Use Kit	9500HP		**	981374	Use Kit	9500HP		**	987038	91045	9500HP		41
981321	91028	9500HP		19	981375	Use Kit	9500HP		**	987039	Use Kit	9500HP		**
981322	91072	9500HP		42	981376	Use Kit	9500HP		**	987040	Use Kit	9500HP		**
981323	91107	9500HP		60	981377	91001	9500HP		39	987041	Use Kit	9500HP		**
981324	91024	9500HP		58	981378	Use Kit	9500HP		**	987042	Use Kit	9500HP		**
981325	91036	9500HP		41	981379	91055	9500HP		41	987043	91080	9500HP		42
981326	Use Kit	9500HP		**	981381	91029	9500HP		40	987044	Use Kit	9500HP		**
981327	91035	9500HP		19	981382	91023	9500HP		58	987045	Use Kit	9500HP		**
981328	91009	9500HP		39	981383	91076	9500HP		21	987046	Use Kit	9500HP		**
981329	Use Kit	9500HP		**	981384	91052	9500HP		59	987047	Use Kit	9500HP		**
981330	Use Kit	9500HP		**	981385	91032	9500HP		40	987048	Use Kit	9500HP		**
981331	Use Kit	9500HP		**	981386	91038	9500HP		19	987049	Use Kit	9500HP		**
981332	Use Kit	9500HP		**	981389	91086	9500HP		43	987050	Use Kit	9500HP		**
981333	Use Kit	9500HP		**	981390	Use Kit	9500HP		**	987051	Use Kit	9500HP		**
981334	91062	9500HP		59	981391	91092	9500HP		43	987052	Use Kit	9500HP		**
981335	Use Kit	9500HP		**	981392	Use Kit	9500HP		**	987053	Use Kit	9500HP		**
981336	91083	9500HP		59	981393	91111	9500HP		44	987054	91046	9500HP		58
981337	Use Kit	9500HP		**	981394	91093	9504HP		43	987055	91047	9500HP		58
981338	91098	9500HP		22	981395	91105	9500HP		59	987056	Use Kit	9500HP		**
981339	91066	9500HP		20	981397	Use Kit	9500HP		**	987057	Use Kit	9500HP		**
981340	91072	9500HP		42	981398	Use Kit	9500HP		**	987058	91048	9500HP		19
981341	91063	9500HP		20	981399	Use Kit	9500HP		**	987059	91049	9500HP		20
981342	91065	9500HP		59	981400	Use Kit	9500HP		**	987060	Use Kit	9500HP		**
981343	91097	9500HP		22	981401	91112	9500HP		45	987061	Use Kit	9500HP		**
981344	91096	9500HP		43	987000	Use Kit	9500HP		**	987062	91050	9500HP		59
981345	91113	9500HP		45	987001	Use Kit	9500HP		**	987063	Use Kit	9500HP		**
981346	Use Kit	9500HP		**	987002	Use Kit	9500HP		**	987064	91075	9500HP		42
981347	Use Kit	9500HP		**	987003	Use Kit	9500HP		**	987065	91079	9500HP		42

** NON-STANDARD: OEM# is not available as a standard remanufactured fan clutch. Kit Masters does stock many non-standard items, please call for availability.

Cross Reference - 7500/9500 & GT

MFGR PART #	KIT MASTERS PART #	USE KIT	Also Use Kit	CAT. PAGE #	MFGR PART #	KIT MASTERS PART #	USE KIT	Also Use Kit	CAT. PAGE #	MFGR PART #	KIT MASTERS PART #	USE KIT	Also Use Kit	CAT. PAGE #
987066	Use Kit	9500HP		**	989038	99038	14-256		23	989095	99095	14-256		48
987067	91051	9500HP		20	989039	99039	14-256		**	989096	99096	14-256		**
987068	91116	9500HP		23	989040	99040	14-256		46	989097	99097	14-256		49
987069	Use Kit	9500HP		**	989041	99041	14-256		61	989098	99098	14-256		25
987070	Use Kit	9500HP		**	989043	99043	14-256		**	989099	99099	14-256		49
987073	91091	9500HP		59	989044	99044	14-256		23	989100	99100	14-256		**
987074	Use Kit	9500HP		**	989045	99045	14-256		**	989101	99101	14-256		49
987075	Use Kit	9500HP		**	989046	99046	14-256		**	989102	99102	14-256		**
987076	91097	9500HP		22	989047	99047	14-256		46	989103	99103	14-256		25
987077	91066	9500HP		20	989048	99048	14-256		**	989104	99104	14-256		49
987078	91070	9500HP		21	989049	99049	14-256		61	989106	99106	14-256		**
987079	91070	9500HP		21	989050	99050	14-256		47	989107	99107	14-256		**
987080	Use Kit	9500HP		**	989051	99051	14-256		47	989108	99108	14-256		**
987081	91080	9500HP		42	989052	99052	14-256		47	989110	99110	14-256	350SK	49
987082	Use Kit	9500HP		**	989053	99053	14-256		47	989111	99111	14-256		49
987084	Use Kit	9500HP		**	989054	99054	14-256		47	989112	99112	14-256		49
987085	91088	9500HP		43	989055	99055	14-256		47	989113	99113	14-256		49
987086	Use Kit	9500HP		**	989056	99056	14-256		47	989114	99114	14-256		50
988600	99600	14-256		55	989057	99057	14-256		47	989115	99115	14-256		50
988601	99601	14-256		55	989058	99058	14-256		**	989116	99116	14-256	250SK	50
988621	99621	14-256		65	989059	99059	14-256		48	989117	99117	14-256		50
989001	99001	14-256		**	989060	99060	14-256		48	989118	99118	14-256		50
989002	99002	14-200	Remove Studs	45	989061	99061	14-256		61	989119	99119	14-256		25
989003	99003	14-200	Remove Studs	60	989062	99062	14-256		61	989124	99124	14-256		**
989004	99004	14-256		45	989063	99063	14-256		62	989125	99125	14-256-1		**
989005	99005	14-256		45	989064	99064	14-256		62	989126	99126	14-256		**
989006	99006	14-200		60	989065	99065	14-256		62	989127	99127	14-256		**
989007	99007	14-256		60	989066	99066	14-256		62	989128	99128	14-256		50
989008	99008	14-256-1		**	989067	99067	14-256		62	989129	99129	14-256		**
989009	99009	14-256-1		**	989068	99068	14-256		23	989130	99130	14-256		50
989010	99010	14-256-1		45	989069	99069	14-256		23	989131	99131	14-256		50
989011	99011	14-256-1		45	989070	99292	14-256		29	989132	99132	14-256		51
989012	99012	14-256		23	989071	99071	14-256		24	989133	99133	14-256		51
989013	99013	14-256		**	989072	99072	14-256		**	989134	99134	14-256		51
989014	99014	14-256		45	989073	99073	14-256		24	989135	99135	14-256		25
989015	99015	14-256		46	989074	99074	14-256		24	989136	99136	14-256		**
989016	99016	14-256		60	989075	99075	14-256		24	989139	99139	14-256		**
989017	99017	14-256		60	989076	99076	14-256		24	989142	99142	14-256-1		70
989018	99018	14-256		60	989077	99077	14-256-1		70	989143	99143	14-256-1		70
989019	99019	14-256		72	989078	99294	14-256		29	989146	99146	14-256		**
989020	99090	14-256		48	989079	99079	14-256		24	989147	99147	14-256	425SK	**
989023	99023	14-256		66	989080	99080	14-256		25	989149	99149	14-256	200SK	**
989024	99024	14-256		66	989081	99081	14-256		48	989150	99150	14-256		**
989025	99025	14-200	Remove Studs	46	989082	99082	14-256		48	989151	99151	14-256	200SK	62
989026	99026	14-256		46	989083	99083	14-256		**	989152	99152	14-256		**
989027	99027	14-256	250SK	61	989084	99084	14-256		25	989153	99153	14-200		51
989028	99028	14-256		61	989085	99085	14-256		**	989154	99154	14-256		51
989029	99029	14-256		61	989087	99087	14-256		**	989155	99155	14-256		**
989030	99030	14-256-1		46	989088	99088	14-256		48	989157	99157	14-256		25
989031	99031	14-256	250SK	61	989090	99090	14-256		48	989158	99158	14-200		**
989034	99034	14-256		23	989091	99091	14-256		**	989159	99159	14-256		**
989035	99035	14-256		46	989092	99092	14-256		62	989160	99160	14-256		25
989036	99036	14-256		46	989093	99093	14-256		**	989161	99161	14-256		26
989037	99037	14-256		23	989094	99094	14-256		48	989162	99162	14-256		26

Cross Reference - 7500/9500 & GT

MFGR PART #	KIT MASTERS PART #	USE KIT	Also Use Kit	CAT. PAGE #	MFGR PART #	KIT MASTERS PART #	USE KIT	Also Use Kit	CAT. PAGE #	MFGR PART #	KIT MASTERS PART #	USE KIT	Also Use Kit	CAT. PAGE #
989163	99163	14-256		26	989224	99224	14-256		63	989294	99294	14-256		29
989164	99164	14-256		26	989225	99225	14-256		63	989295	99295	14-256		53
989165	99165	14-256		**	989226	99226	14-256		63	989296	99296	14-256	350SK	**
989166	99166	14-256		**	989227	99227	14-256		**	989297	99297	14-256		**
989167	99167	14-256		51	989228	99228	14-256		63	989298	99298	14-256		29
989168	99168	14-256		51	989229	99229	14-256	250SK	63	989300	99300	14-256		64
989169	99169	14-256		51	989230	99230	14-256		**	989301	99301	14-256-1		70
989170	99170	14-256	250SK	52	989231	99231	14-256		**	989302	99302	14-256-1		70
989171	99171	14-256		52	989232	99232	14-256		**	989303	99303	14-256		**
989172	99172	14-256	200SK	52	989233	99233	14-256-1		53	989304	99304	14-200		**
989173	99173	14-256		26	989235	99235	14-256		**	989305	99305	14-200		64
989174	99174	14-256		**	989236	99236	14-256		**	989306	99306	14-256		**
989175	99175	14-256		52	989238	99238	14-256		53	989307	99307	14-256		29
989176	99176	14-256	250SK	**	989239	99239	14-256		**	989309	99309	14-256		53
989177	99177	14-256		26	989240	99240	14-256		28	989310	99310	14-256-1		53
989181	99181	14-200	300SK	**	989241	99241	14-256		**	989311	99311	14-256-1		29
989183	99183	14-256		26	989242	99242	14-256		**	989313	99313	14-256		30
989184	99184	14-256		26	989243	99243	14-256		64	989316	99316	14-256		30
989186	99186	14-256	14-ADPT	**	989246	99246	14-256		**	989317	99317	14-256		30
989187	99187	14-256		**	989247	99247	14-256		67	989318	99318	14-256		30
989188	99188	14-256		52	989248	99248	14-256-1		**	989319	99319	14-256		30
989189	99189	14-256		27	989251	99251	14-256-1		**	989320	99320	14-256		30
989190	99190	14-256		27	989252	99252	14-256		66	989321	99321	14-256		**
989191	99191	14-256		27	989253	99253	14-256	350SK	**	989322	99322	14-256		30
989192	99192	14-256		27	989254	99254	14-256		**	989323	99323	14-256		30
989194	99194	14-256		27	989255	99255	14-256		**	989324	99324	14-256		**
989195	99466	14-256		55	989256	99256	14-256	300SK	64	989325	99325	14-256	250SK	53
989196	99196	14-256		72	989259	99259	14-256-1		**	989326	99326	14-256		54
989197	99197	14-256		52, 72	989261	99261	14-256		**	989327	99327	14-256		31
989198	99198	14-256		52	989262	99262	14-256		**	989329	99329	14-256		**
989199	99199	14-256		**	989263	99263	14-256		53	989330	99330	14-256		31
989200	99200	14-256		27	989264	99264	14-256		**	989331	99331	14-256		54
989201	99201	14-200	200SK	**	989266	99266	14-256		**	989332	99332	14-256	250SK	**
989202	99202	14-256		**	989268	99268	14-256		64	989333	99333	14-256		31
989203	99203	14-256		62	989269	99269	14-256		28	989334	99334	14-256		31
989204	99204	14-256		**	989270	99270	14-256		**	989335	99335	14-256		**
989205	99205	14-256		52	989272	99410	14-256		64	989336	99336	14-256-1		70
989206	99206	14-256		**	989273	99273	14-256		28	989337	99337	14-256		31
989207	99207	14-256		**	989274	99274	14-256	14-ADPT + 250SK	**	989339	99339	14-256-1		31
989208	99208	14-256		**	989275	99275	14-256-1		70	989340	99361	14-256		32
989209	99209	14-256		27	989277	99277	14-256		**	989341	99341	14-256-1		31
989211	99211	14-256		27	989278	99278	14-256		**	989342	99342	14-256		31
989212	99212	14-256		28	989279	99436	14-256		**	989343	99343	14-256		54
989213	99213	14-256		**	989280	99280	14-256		28	989346	99346	14-256		32
989214	99214	14-256		**	989281	99281	14-256		29	989347	99347	14-256		67
989216	99216	14-256	250SK	63	989282	99282	14-256	200SK	53	989348	99474	14-256		**
989217	99217	14-256		63	989283	99283	14-256	200SK	**	989349	99349	14-256		54
989218	99218	14-256	250SK	**	989285	99285	14-256		69	989350	99350	14-256		**
989219	99219	14-256	250SK	**	989286	99286	14-200	300SK	64	989351	99351	14-256		32
989220	99220	14-256		28	989289	99289	14-256	300SK	29	989352	99352	14-256		**
989221	99221	14-256		28	989291	99291	14-256		29	989353	99353	14-256-1		**
989222	99222	14-256		63	989292	99292	14-256		29	989354	99354	14-256		32
989223	99223	14-256		63	989293	99071	14-256		24	989356	99356	14-256	250SK	67

** NON-STANDARD: OEM# is not available as a standard remanufactured fan clutch. Kit Masters does stock many non-standard items, please call for availability.

Cross Reference - 7500/9500 & GT

MFGR PART #	KIT MASTERS PART #	USE KIT	Also Use Kit	CAT. PAGE #	MFGR PART #	KIT MASTERS PART #	USE KIT	Also Use Kit	CAT. PAGE #	MFGR PART #	KIT MASTERS PART #	USE KIT	Also Use Kit	CAT. PAGE #
989357	99357	14-256	250SK	67	989423	99423	14-256		68	989506	99506	14-256	300SK	**
989358	99358	14-256-1		32	989424	99202	14-256		**	989508	99508	14-256		**
989359	99359	14-256-1		32	989425	99425	14-256		35	989509	99509	14-256	250SK	**
989360	99360	14-256		32	989426	99426	14-256		68	989510	99510	14-256		**
989361	99361	14-256		32	989427	99427	14-256		68	989511	99511	14-256	150SK	**
989362	99362	14-256		32	989430	99430	14-256		55	989512	99512	14-256		**
989363	99363	14-256-1		33	989431	99431	14-256		**	989513	99513	14-256		**
989364	99364	14-256		**	989434	99434	14-256		**	989514	99514	14-256	150SK	**
989365	99365	14-256		**	989435	99281	14-256		29	989515	99188	14-256	150SK	52
989366	99366	14-256		33	989436	99436	14-256		**	989517	99517	14-256		**
989367	99367	14-256-1		33	989437	99437	14-256		**	989521	99521	14-256		**
989368	99368	14-256-1		33	989438	99438	14-256		35	989522	99522	14-256		**
989369	99369	14-256		33	989439	99439	14-256		35	989523	99523	14-256	250SK	**
989373	99197	14-256		52, 72	989440	99440	14-256		35	989525	99525	14-256-1	250SK	**
989374	99374	14-256		33	989444	99444	14-256	200SK	**	989526	99526	14-256		**
989375	99375	14-256		**	989445	99445	14-256		**	989528	99528	14-256-1		**
989377	99377	14-256		33	989446	99446	14-256		55	989529	99529	14-256		**
989378	99378	14-256		**	989448	99448	14-256		**	989530	99530	14-256	250SK	**
989380	99467	14-256		**	989450	99450	14-256	200SK	65	989531	99531	14-256	250SK	**
989381	99381	14-256		70	989451	99451	14-256		**	989532	99532	14-256		**
989382	99382	14-256		33	989452	99452	14-256		**	989533	99533	14-256		**
989383	99383	14-256		**	989453	99453	14-256-1		35	989534	99534	14-256	350SK	**
989384	99384	14-256		54	989454	99454	14-256		72	989537	99537	14-256		**
989385	99385	14-256		**	989455	99455	14-256-1		71	989538	99538	14-256	150SK	**
989386	99386	14-256		34	989457	99457	14-256		**	989800	99800	14-256		**
989387	99425	14-256		35	989458	99458	14-256		**	989801	99801	14-256		55
989388	99388	14-256		**	989459	99459	14-256	200SK	**	989802	99802	14-256		**
989389	99389	14-256	250SK	54	989461	99461	14-256		**	989803	99803	14-256		**
989395	99395	14-256		**	989466	99466	14-256		55	989804	99820	14-256		**
989396	99191	14-256	300SK	27	989467	99467	14-256		**	989805	99805	14-256		**
989398	99398	14-256		**	989468	99431	14-256		**	989806	99806	14-256		**
989399	99399	14-256		67	989469	99469	14-256		**	989807	99807	14-256-1		**
989400	99400	14-256		67	989470	99491	14-256		67	989808	99808	14-256		**
989401	99401	14-256		34	989471	99400	14-256		67	989809	99809	14-256		36
989402	99402	14-256		**	989472	99399	14-256		67	989810	99810	14-256		**
989403	99403	14-256		34	989473	99347	14-256		67	989812	99812	14-256		**
989404	99404	14-256		**	989474	99348	14-256		67	989813	99813	14-256		**
989405	99405	14-256		**	989475	99423	14-256		68	989815	99815	14-256		**
989406	99406	14-256		**	989476	99497	14-256		68	989816	99816	14-256		**
989407	99407	14-256		67	989477	99498	14-256		**	989817	99817	14-256		**
989409	99409	14-256		**	989478	99426	14-256		68	989818	99818	14-256		36
989410	99410	14-256		64	989491	99247	14-256		67	989819	99819	14-256		**
989411	99411	14-256-1		34	989492	99400	14-256		67	989820	99820	14-256		**
989412	99412	14-256-1		34	989493	99399	14-256		67	989821	99821	14-256		**
989413	99413	14-256		34	989494	99347	14-256		67	989822	99822	14-256		**
989414	99414	14-256		34	989495	99348	14-256		67	989823	99823	14-256		55
989415	99415	14-256		55	989498	99498	14-256		**	989824	99824	14-256		**
989416	99416	14-256	300SK	**	989499	99426	14-256		68	989825	99825	14-256-1		**
989417	99417	14-256		**	989500	99500	14-256		**	989826	99826	14-256		**
989418	99418	14-256		**	989501	99501	14-256		**	989827	99827	14-256		**
989419	99419	14-200	200SK	65	989502	99502	14-256		**	989828	99828	14-256		**
989420	99420	14-256		35	989503	99503	14-256	250SK	**	989829	99829	14-256		**
989421	99421	14-256		**	989504	99504	14-256		**	989830	99830	14-256		**
989422	99422	14-256		35	989505	99505	14-256		**	989831	99831	14-256		**

Cross Reference - 7500/9500 & GT

MFGR PART #	KIT MASTERS PART #	USE KIT	Also Use Kit	CAT. PAGE #	MFGR PART #	KIT MASTERS PART #	USE KIT	Also Use Kit	CAT. PAGE #	MFGR PART #	KIT MASTERS PART #	USE KIT	Also Use Kit	CAT. PAGE #
989832	99469	14-256		**	989888	99888	14-256	200SK	**	990042	Use Kit	7500HP		**
989835	99835	14-256		**	989889	99889	14-256		**	990043	Use Kit	7500HP		**
989836	99836	14-256-1		**	989890	99890	14-256		**	990044	Use Kit	7500HP		**
989837	99837	14-256		**	989891	99891	14-256		**	990045	Use Kit	7500HP		**
989838	99838	14-256		**	989892	99892	14-256		**	990046	Use Kit	7500HP		**
989839	99600	14-256		55	989893	99893	14-256-1		**	990047	90004	7500HP		57
989840	99840	14-256-1		**	989894	99894	14-256		**	990048	90004	7500HP		57
989841	99841	14-256-1		**	989895	99895	14-256		**	990049	90004	7500HP		57
989842	99842	14-256		**	989896	99896	14-256-1		**	990050	Use Kit	7500HP		**
989843	99336	14-256-1		70	989897	99897	14-256		56	990051	Use Kit	7500HP		**
989844	99844	14-256-1		**	989898	99898	14-256		**	990052	Use Kit	7500HP		**
989845	99845	14-256		**	989899	99899	14-256-1		**	990053	Use Kit	7500HP		**
989846	99846	14-256-1		**	990000	Use Kit	7500HP		**	990054	Use Kit	7500HP		**
989847	99847	14-256		**	990001	Use Kit	7500HP		**	990055	Use Kit	7500HP		**
989848	99848	14-256		**	990002	Use Kit	7500HP		**	990056	Use Kit	7500HP		**
989849	99849	14-256		65	990003	90023	7500HP		38	990057	90022	7500HP		17
989850	99850	14-256		65	990004	90023	7500HP		38	990058	90005	7500HP		17
989852	99852	14-256		**	990005	90023	7500HP		38	990059	90005	7500HP		17
989853	99853	14-256-1		**	990006	90010	7500HP		37	990060	90005	7500HP		17
989854	99854	14-256		**	990007	90017	7500HP		38	990061	90005	7500HP		17
989855	99855	14-256		**	990008	90010	7500HP		37	990062	90007	7500HP		17
989856	99856	14-256		**	990009	Use Kit	7500HP		**	990063	90005	7500HP		17
989857	99857	14-256		**	990010	Use Kit	7500HP		**	990064	Use Kit	7500HP		**
989858	99858	14-256		**	990011	Use Kit	7500HP		**	990065	Use Kit	7500HP		**
989859	99859	14-256		**	990012	90000	7500HP		37	990066	Use Kit	7500HP		**
989860	99860	14-256		**	990013	90000	7500HP		37	990067	90004	7500HP		57
989861	99861	14-256		**	990014	90000	7500HP		37	990069	Use Kit	7500HP		**
989862	99862	14-256-1		**	990015	90000	7500HP		37	990070	90007	7500HP		17
989863	99863	14-256		**	990016	Use Kit	7500HP		**	990071	Use Kit	7500HP		**
989864	99864	14-256		**	990017	Use Kit	7500HP		**	990072	Use Kit	7500HP		**
989865	99865	14-256	275SK	**	990018	90000	7500HP		37	990073	Use Kit	7500HP		**
989866	99866	14-256		**	990019	90008	7500HP		37	990074	Use Kit	7500HP		**
989867	99867	14-256		**	990020	Use Kit	7500HP		**	990075	90012	7500HP		37
989868	99868	14-256		**	990021	Use Kit	7500HP		**	990076	90005	7500HP		17
989869	99869	14-256		**	990022	Use Kit	7500HP		**	990077	90009	7500HP		57
989870	99870	14-256		**	990023	90001	7500HP		37	990078	91115	9505SP		22
989871	99871	14-256		**	990024	90001	7500HP		37	990079	Use Kit	7500HP		**
989872	99872	14-256		**	990025	90002	7500HP		37	990080	90013	7500HP		37
989873	99873	14-256		**	990026	90002	7500HP		37	990081	90014	7500HP		17
989874	99874	14-256		**	990027	Use Kit	7500HP		**	990082	Use Kit	7500HP		**
989875	99875	14-256-1		**	990028	Use Kit	7500HP		**	990083	90015	7500HP		17
989876	99876	14-256		**	990029	Use Kit	7500HP		**	990084	Use Kit	7500HP		**
989877	99877	14-256		**	990030	90003	7500HP		57	990085	Use Kit	7500HP		**
989878	99878	14-256		**	990031	90003	7500HP		57	990086	Use Kit	7500HP		**
989879	99879	14-256		**	990032	90003	7500HP		57	990087	Use Kit	7500HP		**
989880	99880	14-256		**	990034	90003	7500HP		57	990088	Use Kit	7500HP		**
989881	99881	14-256		**	990035	Use Kit	7500HP		**	990089	90014	7500HP		17
989882	99882	14-256		**	990036	Use Kit	7500HP		**	990090	Use Kit	7500HP		**
989883	99883	14-256-1		**	990037	Use Kit	7500HP		**	990091	90015	7500HP		17
989884	99884	14-256		**	990038	Use Kit	7500HP		**	990092	90016	7500HP		37
989885	99885	14-256		56	990039	Use Kit	7500HP		**	990093	Use Kit	7500HP		**
989886	99886	14-256		**	990040	90011	7500HP		57	990094	Use Kit	7500HP		**
989887	99887	14-256		**	990041	90009	7500HP		57	990095	Use Kit	7500HP		**

** NON-STANDARD: OEM# is not available as a standard remanufactured fan clutch. Kit Masters does stock many non-standard items, please call for availability.

Cross Reference - 7500/9500 & GT

MFGR PART #	KIT MASTERS PART #	USE KIT	Also Use Kit	CAT. PAGE #	MFGR PART #	KIT MASTERS PART #	USE KIT	Also Use Kit	CAT. PAGE #	MFGR PART #	KIT MASTERS PART #	USE KIT	Also Use Kit	CAT. PAGE #
990096	Use Kit	7500HP		**	990154	Use Kit	7500HP		**	991035	Use Kit	9500HP		**
990097	Use Kit	7500HP		**	990155	90001	7500HP		37	991036	Use Kit	9505SP		**
990098	90014	7500HP		17	990156	Use Kit	7500HP		**	991037	Use Kit	9500HP		**
990099	90018	7500HP		57	990157	Use Kit	7500HP		**	991038	91034	9500HP		40
990100	Use Kit	7500HP		**	990158	Use Kit	7500HP		**	991039	91018	9500HP		39
990101	Use Kit	7500HP		**	990159	90010	7500HP		37	991040	91010	9500HP		39
990102	90002	7500HP		37	990160	Use Kit	7500HP		**	991041	Use Kit	9505SP		**
990105	90019	7500HP		57	990161	90013	7500HP		37	991042	Use Kit	9500HP		**
990106	90022	7500HP		17	990162	90018	7500HP		57	991043	Use Kit	9500HP		**
990107	Use Kit	7500HP		**	990163	Use Kit	7500HP		**	991044	91019	9500HP		40
990108	Use Kit	7500HP		**	990164	90020	7500HP		57	991045	Use Kit	9500HP		**
990110	Use Kit	7500HP		**	990165	Use Kit	7500HP		**	991046	91020	9500HP		19
990111	90021	7500HP		38	990166	Use Kit	7500HP		**	991047	Use Kit	9500HP		**
990112	90019	7500HP		57	990167	90004	7500HP		57	991048	91109	9500HP		44
990113	90021	7500HP		38	990169	Use Kit	7500HP		**	991049	91095	9500HP		43
990114	Use Kit	7500HP		**	990170	Use Kit	7500HP		**	991050	91012	9505SP		18
990115	Use Kit	7500HP		**	990804	90804	94207		**	991051	91011	9500HP		58
990116	Use Kit	7500HP		**	990810	90810	94207		**	991052	91082	9500HP		21
990117	90017	7500HP		38	990811	90810	94207		**	991053	91029	9500HP		40
990118	90015	7500HP		17	991000	91001	9500HP		39	991054	91030	9500HP		40
990119	Use Kit	7500HP		**	991001	91000	9500HP		39	991055	91022	9500HP		40
990121	90022	7500HP		17	991002	Use Kit	9500HP		**	991056	91021	9500HP		40
990122	90010	7500HP		37	991003	91112	9500HP		45	991057	Use Kit	9500HP		**
990123	90018	7500HP		57	991004	91004	9500HP		39	991058	Use Kit	9500HP		**
990124	90013	7500HP		37	991005	91006	9500HP		39	991059	Use Kit	9500HP		**
990125	90017	7500HP		38	991006	91002	9500HP		17	991060	Use Kit	9500HP		**
990126	90004	7500HP		57	991007	91002	9500HP		17	991061	91031	9500HP		58
990127	Use Kit	7500HP		**	991008	91003	9505SP		18	991062	91023	9500HP		58
990128	Use Kit	7500HP		**	991009	91005	9500HP		18	991063	91036	9500HP		41
990129	90014	7500HP		17	991010	Use Kit	9500HP		**	991064	91024	9500HP		58
990130	Use Kit	7500HP		**	991011	Use Kit	9500HP		**	991065	91067	9500HP		20
990131	90002	7500HP		37	991012	91027	9500HP		19	991066	Use Kit	9500HP		**
990132	90014	7500HP		17	991013	91001	9500HP		39	991067	91027	9500HP		19
990133	90015	7500HP		17	991014	Use Kit	9500HP		**	991068	91027	9500HP		19
990134	Use Kit	7500HP		**	991015	91016	9500HP		39	991069	Use Kit	9500HP		**
990135	90023	7500HP		38	991016	91003	9505SP		18	991071	91037	9500HP		58
990136	90016	7500HP		37	991017	91027	9500HP		19	991072	Use Kit	9500HP		**
990137	Use Kit	7500HP		**	991018	91000	9500HP		39	991073	91033	9500HP		58
990138	Use Kit	7500HP		**	991019	91103	9500HP		44	991074	91090	9500HP		22
990139	90012	7500HP		37	991020	91012	9505SP		18	991075	Use Kit	9500HP		**
990140	90000	7500HP		37	991021	91007	9500HP		18	991076	91014	9500HP		18
990141	Use Kit	7500HP		**	991022	91008	9500HP		18	991077	Use Kit	9500HP		**
990142	90005	7500HP		17	991023	91015	9500HP		18	991078	Use Kit	9500HP		**
990143	90007	7500HP		17	991024	91108	9500HP		44	991079	91116	9500HP		23
990144	90002	7500HP		37	991025	91000	9500HP		39	991080	Use Kit	9500HP		**
990145	Use Kit	7500HP		**	991026	Use Kit	9500HP		**	991081	91025	9500HP		19
990146	Use Kit	7500HP		**	991027	91009	9500HP		39	991082	91025	9500HP		19
990147	90003	7500HP		57	991028	91016	9500HP		39	991084	91009	9500HP		39
990148	90003	7500HP		57	991029	91026	9500HP		40	991085	91032	9500HP		40
990149	90009	7500HP		57	991030	Use Kit	9500HP		**	991086	91040	9500HP		69
990150	Use Kit	7500HP		**	991031	Use Kit	9500HP		**	991087	Use Kit	9500HP		**
990151	Use Kit	7500HP		**	991032	91017	9505SP		19	991088	Use Kit	9500HP		**
990152	Use Kit	7500HP		**	991033	91104	9500HP		44	991090	91028	9500HP		19
990153	90008	7500HP		37	991034	Use Kit	9505SP		**	991092	91039	9500HP		69

Cross Reference - 7500/9500 & GT

MFGR PART #	KIT MASTERS PART #	USE KIT	Also Use Kit	CAT. PAGE #	MFGR PART #	KIT MASTERS PART #	USE KIT	Also Use Kit	CAT. PAGE #	MFGR PART #	KIT MASTERS PART #	USE KIT	Also Use Kit	CAT. PAGE #
991093	91040	9500HP		69	991148	91007	9500HP		18	991204	91100	9500HP		44
991094	91114	9500HP		60	991149	91024	9500HP		58	991207	91061	9500HP		41
991095	Use Kit	9500HP		**	991150	Use Kit	9500HP		**	991208	Use Kit	9500HP		**
991096	91041	9500HP		69	991151	91009	9500HP		39	991209	91114	9500HP		60
991098	91077	9500HP		59	991152	91014	9500HP		18	991210	91033	9500HP		58
991099	91094	9500HP		43	991153	91035	9500HP		19	991211	91085	9500HP		21
991100	91039	9500HP		69	991154	91025	9500HP		19	991212	91011	9500HP		58
991101	91040	9500HP		69	991155	91006	9500HP		39	991213	Use Kit	9500HP		**
991102	91041	9500HP		69	991156	91018	9500HP		39	991214	Use Kit	9500HP		**
991103	91076	9500HP		21	991157	91015	9500HP		18	991215	Use Kit	9500HP		**
991104	Use Kit	9500HP		**	991158	91010	9500HP		39	991216	Use Kit	9500HP		**
991105	91006	9500HP		39	991159	91019	9500HP		40	991217	Use Kit	9500HP		**
991106	91054	9500HP		41	991160	91029	9500HP		40	991218	91087	9500HP		22
991107	91052	9500HP		59	991161	91034	9500HP		40	991219	Use Kit	9500HP		**
991108	91038	9500HP		19	991162	91022	9500HP		40	991220	Use Kit	9500HP		**
991109	Use Kit	9500HP		**	991163	91023	9500HP		58	991221	91031	9500HP		58
991110	91011	9500HP		58	991164	91076	9500HP		21	991222	91023	9500HP		58
991111	91000	9500HP		39	991165	91052	9500HP		59	991223	91011	9500HP		58
991112	91020	9500HP		19	991166	91054	9500HP		41	991224	Use Kit	9500HP		**
991113	91024	9500HP		58	991167	91089	9500HP		22	991225	91052	9500HP		59
991114	91082	9500HP		21	991168	91032	9500HP		40	991226	91029	9500HP		40
991115	Use Kit	9500HP		**	991169	91102	9500HP		22	991227	91019	9500HP		40
991116	Use Kit	9500HP		**	991170	Use Kit	9500HP		**	991228	91054	9500HP		41
991117	91110	9500HP		44	991171	91036	9500HP		41	991229	Use Kit	9500HP		**
991118	91026	9500HP		40	991172	Use Kit	9500HP		**	991230	Use Kit	9500HP		**
991119	91014	9500HP		18	991173	91016	9500HP		39	991231	91038	9500HP		19
991120	91009	9500HP		39	991174	91036	9500HP		41	991232	Use Kit	9500HP		**
991121	91035	9500HP		19	991175	91106	9500HP		22	991233	Use Kit	9500HP		**
991122	Use Kit	9500HP		**	991176	91012	9505SP		18	991234	91036	9500HP		41
991123	91000	9500HP		39	991177	Use Kit	9500HP		**	991235	91009	9500HP		39
991124	91028	9500HP		19	991178	Use Kit	9500HP		**	991236	91068	9500HP		21
991125	91089	9500HP		22	991179	91025	9500HP		19	991237	Use Kit	9500HP		**
991126	91067	9500HP		20	991180	91094	9500HP		43	991238	Use Kit	9500HP		**
991127	91024	9500HP		58	991181	Use Kit	9500HP		**	991239	Use Kit	9500HP		**
991128	91001	9500HP		39	991182	91071	9500HP		21	991240	Use Kit	9500HP		**
991129	Use Kit	9500HP		**	991183	91037	9500HP		58	991241	Use Kit	9500HP		**
991130	91087	9500HP		22	991184	91068	9500HP		21	991242	91071	9500HP		21
991131	91090	9500HP		22	991185	91016	9500HP		39	991243	91026	9500HP		40
991132	91027	9500HP		19	991186	91110	9500HP		44	991244	91000	9500HP		39
991133	91011	9500HP		58	991187	91077	9500HP		59	991245	91095	9500HP		43
991134	91000	9500HP		39	991188	91115	9505SP		22	991246	Use Kit	9500HP		**
991135	91001	9500HP		39	991189	91058	9500HP		41	991247	91082	9500HP		21
991136	91106	9500HP		22	991190	Use Kit	9500HP		**	991248	91028	9500HP		19
991137	Use Kit	9500HP		**	991191	Use Kit	9500HP		**	991249	Use Kit	9500HP		**
991138	Use Kit	9500HP		**	991192	91057	9500HP		20	991251	91001	9500HP		39
991139	Use Kit	9500HP		**	991193	91072	9500HP		42	991253	Use Kit	9500HP		**
991140	91035	9500HP		19	991194	Use Kit	9500HP		**	991254	91081	9500HP		21
991142	91021	9500HP		40	991195	Use Kit	9500HP		**	991255	91005	9500HP		18
991143	91041	9500HP		69	991196	91059	9500HP		20	991256	91116	9500HP		23
991144	91040	9500HP		69	991199	91000	9500HP		39	991257	Use Kit	9500HP		**
991145	91039	9500HP		69	991201	91060	9500HP		20	991258	Use Kit	9500HP		**
991146	91022	9500HP		40	991202	91012	9505SP		18	991259	Use Kit	9500HP		**
991147	91012	9505SP		18	991203	Use Kit	9500HP		**	991260	Use Kit	9500HP		**

** NON-STANDARD: OEM# is not available as a standard remanufactured fan clutch. Kit Masters does stock many non-standard items, please call for availability.

Cross Reference - 7500/9500 & GT

MFGR PART #	KIT MASTERS PART #	USE KIT	Also Use Kit	CAT. PAGE #	MFGR PART #	KIT MASTERS PART #	USE KIT	Also Use Kit	CAT. PAGE #	MFGR PART #	KIT MASTERS PART #	USE KIT	Also Use Kit	CAT. PAGE #
991261	91055	9500HP		41	991322	Use Kit	9500HP		**	991383	Use Kit	9500HP		**
991262	Use Kit	9500HP		**	991324	91024	9500HP		58	991384	Use Kit	9500HP		**
991263	Use Kit	9500HP		**	991325	91036	9500HP		41	991385	Use Kit	9500HP		**
991264	Use Kit	9500HP		**	991328	91035	9500HP		19	991386	Use Kit	9500HP		**
991265	91056	9500HP		41	991329	91009	9500HP		39	991387	Use Kit	9500HP		**
991266	91068	9500HP		21	991330	Use Kit	9500HP		**	991388	Use Kit	9500HP		**
991267	Use Kit	9500HP		**	991331	Use Kit	9500HP		**	991398	91086	9500HP		43
991268	91001	9500HP		39	991332	91094	9500HP		43	991399	Use Kit	9500HP		**
991269	91109	9500HP		44	991333	91033	9500HP		58	993282	3282			**
991270	91017	9505SP		19	991334	91095	9500HP		43	993283	3283			**
991271	91008	9505SP		18	991335	Use Kit	9500HP		**	993603	3603			**
991272	91112	9500HP		45	991336	Use Kit	9500HP		**	993605	3605			**
991273	91003	9505SP		18	991337	Use Kit	9500HP		**	993606	3606			**
991274	Use Kit	9505SP		**	991338	Use Kit	9500HP		**	993607	3607			**
991275	Use Kit	9500HP		**	991339	Use Kit	9500HP		**	993611	3611			**
991276	Use Kit	9500HP		**	991341	91062	9500HP		59	993617	3617			**
991277	91004	9500HP		39	991342	Use Kit	9500HP		**	993619	3619			**
991278	91104	9500HP		44	991343	91083	9500HP		59	993653	3653			**
991279	91103	9500HP		44	991345	91098	9500HP		22	993654	3654			**
991280	91108	9500HP		44	991346	91066	9500HP		20	993655	3655			**
991281	Use Kit	9500HP		**	991347	91072	9500HP		42	994205	4205			**
991283	91007	9500HP		18	991348	91063	9500HP		20	994207	94207			**
991284	91081	9500HP		21	991349	91065	9500HP		59	994212	7503			**
991285	Use Kit	9500HP		**	991350	91097	9500HP		22	994245	9505			**
991286	91107	9500HP		60	991351	91096	9500HP		43	994246	9503			**
991287	91087	9500HP		22	991352	91113	9500HP		45	994305	9500HP			**
991288	91088	9500HP		43	991353	Use Kit	9500HP		**	994306	9505SP			**
991289	91101	9500HP		44	991354	Use Kit	9500HP		**	994307	7500HP			**
991290	Use Kit	9500HP		**	991355	91074	9500HP		42	994308	9500HP			**
991291	91102	9500HP		22	991356	91014	9500HP		18	994314	7500H			**
991292	91095	9500HP		43	991358	91064	9500HP		42	994315	9500H			**
991293	91094	9500HP		43	991359	Use Kit	9500HP		**	994316	9505H			**
991294	Use Kit	9500HP		**	991360	Use Kit	9500HP		**	994319	9503			**
991295	Use Kit	9500HP		**	991361	91062	9500HP		59	994321	7503			**
991297	91020	9500HP		19	991362	Use Kit	9500HP		**	994322	9500HP			**
991298	91071	9500HP		21	991364	91001	9500HP		39	994323	9500H			**
991299	91099	9500HP		43	991365	91001	9500HP		39	994324	7500HP			**
991300	91062	9500HP		59	991366	Use Kit	9500HP		**	994325	7500H			**
991301	Use Kit	9500HP		**	991367	91006	9500HP		39	994346	14-S			**
991302	Use Kit	9500HP		**	991368	91006	9500HP		39	994347	14-256			**
991303	Use Kit	9500HP		**	991369	91004	9500HP		39	994349	14-L			**
991304	91037	9500HP		58	991370	91081	9500HP		21	994353	14-256-1	300SK		**
991305	91066	9500HP		20	991371	Use Kit	9500HP		**	994356	14-200			**
991306	91066	9500HP		20	991372	91014	9500HP		18	994370	4205			**
991307	Use Kit	9500HP		**	991373	91014	9500HP		18	994372	14-LP			**
991308	91028	9500HP		19	991374	91081	9500HP		21	994373	14-256	150SK		**
991310	91058	9500HP		41	991375	91070	9500HP		21	994375	14-256	250SK		**
991312	91061	9500HP		41	991376	91069	9500HP		21	994377	14-256	300SK		**
991316	91060	9500HP		20	991377	Use Kit	9500HP		**	994379	14-256	350SK		**
991317	Use Kit	9500HP		**	991378	91091	9500HP		59	994381	14-256	425SK		**
991318	Use Kit	9500HP		**	991379	Use Kit	9500HP		**	994383	14-200			**
991319	Use Kit	9500HP		**	991380	Use Kit	9500HP		**	994385	14-200	150SK		**
991320	Use Kit	9500HP		**	991381	Use Kit	9500HP		**	994387	14-200	300SK		**
991321	Use Kit	9500HP		**	991382	Use Kit	9500HP		**	994388	9500HP			**

Cross Reference - 7500/9500 & GT

MFGR PART #	KIT MASTERS PART #	USE KIT	Also Use Kit	CAT. PAGE #	MFGR PART #	KIT MASTERS PART #	USE KIT	Also Use Kit	CAT. PAGE #	MFGR PART #	KIT MASTERS PART #	USE KIT	Also Use Kit	CAT. PAGE #
994900	14-256			**	997040	Use Kit	9500HP		**	998600	99600	14-256		55
994902	14-256-1			**	997042	91084	9500HP		72	998601	99601	14-256		55
994966	14-SBL			**	997043	Use Kit	9500HP		**	998621	99621	14-256		65
994985	14-256			**	997044	Use Kit	9500HP		**	999001	99001	14-256		**
994995	14-256	150SK		**	997045	91073	9500HP		42, 72	999002	99002	14-200	Remove Studs	45
995031	14-256-1			**	997046	Use Kit	9500HP		**	999003	99003	14-200	Remove Studs	60
995033	14-SBL			**	997047	91044	9500HP		41	999004	99004	14-256		45
995034	14-256			**	997048	91045	9500HP		41	999005	99005	14-256		45
995035	14-256			**	997049	Use Kit	9500HP		**	999006	99006	14-200		60
995037	14-256	150SK		**	997050	Use Kit	9500HP		**	999007	99007	14-256		60
995042	14-256	250SK		**	997051	Use Kit	9500HP		**	999008	99008	14-256-1		**
995046	14-L			**	997052	Use Kit	9500HP		**	999009	99009	14-256-1		**
995047	14-LP			**	997053	91080	9500HP		42	999010	99010	14-256-1		45
995052	14-256	200SK		**	997054	Use Kit	9500HP		**	999011	99011	14-256-1		45
995053	14-256	300SK		**	997055	Use Kit	9500HP		**	999012	99012	14-256		23
995054	14-256			**	997056	Use Kit	9500HP		**	999013	99013	14-256		**
995055	14-256-1	200SK		**	997057	Use Kit	9500HP		**	999014	99014	14-256		45
995056	14-256-1	300SK		**	997058	Use Kit	9500HP		**	999015	99015	14-256		46
995057	14-256-1	200SK		**	997059	Use Kit	9500HP		**	999016	99016	14-256		60
995058	14-256-1	300SK		**	997060	Use Kit	9500HP		**	999017	99017	14-256		60
995062	14-256-1	350SK		**	997061	Use Kit	9500HP		**	999018	99018	14-256		60
995063	14-256	350SK		**	997062	Use Kit	9500HP		**	999019	99019	14-256		72
995530	14-256			**	997063	Use Kit	9500HP		**	999020	99020	14-256		48
995534	14-256	275SK		**	997064	91046	9500HP		58	999023	99023	14-256		66
997001	Use Kit	9500HP		**	997065	91047	9500HP		58	999024	99024	14-256		66
997002	Use Kit	9500HP		**	997066	Use Kit	9500HP		**	999025	99025	14-200	Remove Studs	46
997003	Use Kit	9500HP		**	997067	Use Kit	9500HP		**	999026	99026	14-256		46
997005	Use Kit	9500HP		**	997068	91048	9500HP		19	999027	99027	14-256	250SK	61
997006	Use Kit	9500HP		**	997069	91049	9500HP		20	999028	99028	14-256		61
997007	Use Kit	9500HP		**	997070	Use Kit	9500HP		**	999029	99029	14-256		61
997008	Use Kit	9500HP		**	997071	Use Kit	9500HP		**	999030	99030	14-256-1		46
997009	Use Kit	9500HP		**	997072	91050	9500HP		59	999031	99031	14-256	250SK	61
997010	Use Kit	9500HP		**	997073	Use Kit	9500HP		**	999034	99034	14-256		23
997011	Use Kit	9500HP		**	997074	91075	9500HP		42	999035	99035	14-256		46
997012	Use Kit	9500HP		**	997075	91079	9500HP		42	999036	99036	14-256		46
997013	91111	9500HP		44	997076	Use Kit	9500HP		**	999037	99037	14-256		23
997014	91092	9500HP		43	997077	91051	9500HP		20	999038	99038	14-256		23
997016	91093	9504HP		43	997078	91116	9500HP		23	999039	99039	14-256		46
997017	91079	9500HP		42	997079	Use Kit	9500HP		**	999040	99040	14-256		46
997018	91075	9500HP		42	997080	Use Kit	9500HP		**	999041	99041	14-256		61
997019	91105	9500HP		59	997083	91091	9500HP		59	999043	99043	14-256		**
997020	91042	9500HP		66	997084	Use Kit	9500HP		**	999044	99044	14-256		23
997021	91043	9500HP		66	997085	Use Kit	9500HP		**	999045	99045	14-256		**
997026	Use Kit	9500HP		**	997086	Use Kit	9500HP		**	999046	99046	14-256		**
997027	91078	9500HP		42	997087	91066	9500HP		20	999047	99047	14-256		46
997028	91073	9500HP		42, 72	997088	91070	9500HP		21	999048	99048	14-256		**
997029	Use Kit	9500HP		**	997089	91069	9500HP		21	999049	99049	14-256		61
997034	Use Kit	9500HP		**	997091	91080	9500HP		42	999050	99050	14-256		47
997035	91084	9500HP		72	997092	Use Kit	9500HP		**	999051	99051	14-256		47
997036	Use Kit	9500HP		**	997094	Use Kit	9500HP		**	999052	99052	14-256		47
997037	Use Kit	9500HP		**	997095	91088	9500HP		43	999053	99053	14-256		47
997038	Use Kit	9500HP		**	997096	91097	9500HP		22	999054	99054	14-256		47
997039	Use Kit	9500HP		**	997098	Use Kit	9500HP		**	999055	99055	14-256		47

** NON-STANDARD: OEM# is not available as a standard remanufactured fan clutch. Kit Masters does stock many non-standard items, please call for availability.

Cross Reference - 7500/9500 & GT

MFGR PART #	KIT MASTERS PART #	USE KIT	Also Use Kit	CAT. PAGE #	MFGR PART #	KIT MASTERS PART #	USE KIT	Also Use Kit	CAT. PAGE #	MFGR PART #	KIT MASTERS PART #	USE KIT	Also Use Kit	CAT. PAGE #
999056	99056	14-256		47	999114	99114	14-256		50	999184	99184	14-256		26
999057	99057	14-256		47	999115	99115	14-256		50	999186	99186	14-256	14-ADPT	**
999058	99058	14-256		**	999116	99116	14-256	250SK	50	999187	99187	14-256		**
999059	99059	14-256		48	999117	99117	14-256		50	999188	99188	14-256		52
999060	99060	14-256		48	999118	99118	14-256		50	999189	99189	14-256		27
999061	99061	14-256		61	999119	99119	14-256		25	999190	99190	14-256		27
999062	99062	14-256		61	999124	99124	14-256		**	999191	99191	14-256	300SK	27
999063	99063	14-256		62	999125	99125	14-256-1		**	999192	99192	14-256		27
999064	99064	14-256		62	999126	99126	14-256		**	999194	99194	14-256		27
999065	99065	14-256		62	999127	99127	14-256		**	999195	99466	14-256		55
999066	99066	14-256		62	999128	99128	14-256		50	999196	99196	14-256		72
999067	99067	14-256		62	999129	99129	14-256		**	999197	99197	14-256		52, 72
999068	99068	14-256		23	999130	99130	14-256		50	999198	99198	14-256		52
999069	99069	14-256		23	999131	99131	14-256		50	999199	99199	14-256		**
999070	99070	14-256		24	999132	99132	14-256		51	999200	99200	14-256		27
999071	99071	14-256		24	999133	99133	14-256		51	999201	99201	14-200	200SK	**
999072	99072	14-256		**	999134	99134	14-256		51	999202	99202	14-256		**
999073	99073	14-256		24	999135	99135	14-256		25	999203	99203	14-256		62
999074	99074	14-256		24	999136	99136	14-256		**	999204	99204	14-256		**
999075	99075	14-256		24	999139	99139	14-256		**	999205	99205	14-256		52
999076	99076	14-256		24	999142	99142	14-256-1		70	999206	99206	14-256		**
999077	99077	14-256-1		70	999143	99143	14-256-1		70	999207	99207	14-256		**
999078	99078	14-256		24	999146	99146	14-256		**	999208	99208	14-256		**
999079	99079	14-256		24	999147	99147	14-256	425SK	**	999209	99209	14-256		27
999080	99080	14-256		25	999149	99149	14-256	200SK	**	999211	99211	14-256		27
999081	99081	14-256		48	999150	99150	14-256		**	999212	99212	14-256		28
999082	99082	14-256		48	999151	99151	14-256	200SK	62	999213	99213	14-256		**
999083	99083	14-256		**	999152	99152	14-256		**	999214	99214	14-256		**
999084	99084	14-256		25	999153	99153	14-200		51	999216	99216	14-256	250SK	63
999085	99085	14-256		**	999154	99154	14-256		51	999217	99217	14-256		63
999087	99087	14-256		**	999155	99155	14-256		**	999218	99218	14-256	250SK	**
999088	99088	14-256		48	999157	99157	14-256		25	999219	99219	14-256	250SK	**
999090	99090	14-256		48	999158	99158	14-200		**	999220	99220	14-256		28
999091	99091	14-256		**	999159	99159	14-256		**	999221	99221	14-256		28
999092	99092	14-256		62	999160	99160	14-256		25	999222	99222	14-256		63
999093	99093	14-256		**	999161	99161	14-256		26	999223	99223	14-256		63
999094	99094	14-256		48	999162	99162	14-256		26	999224	99224	14-256		63
999095	99095	14-256		48	999163	99163	14-256		26	999225	99225	14-256		63
999096	99096	14-256		**	999164	99164	14-256		26	999226	99226	14-256		63
999097	99097	14-256		49	999165	99165	14-256		**	999227	99065	14-256		62
999098	99098	14-256		25	999166	99166	14-256		**	999228	99228	14-256		63
999099	99099	14-256		49	999167	99167	14-256		51	999229	99229	14-256	250SK	63
999100	99100	14-256		**	999168	99168	14-256		51	999230	99230	14-256		**
999101	99101	14-256		49	999169	99169	14-256		51	999231	99231	14-256		**
999102	99102	14-256		**	999170	99170	14-256	250SK	52	999232	99232	14-256		**
999103	99103	14-256		25	999171	99171	14-256		52	999233	99233	14-256-1		53
999104	99104	14-256		49	999172	99172	14-256	200SK	52	999235	99235	14-256		**
999106	99106	14-256		**	999173	99173	14-256		26	999236	99236	14-256		**
999107	99107	14-256		**	999174	99174	14-256		**	999238	99238	14-256		53
999108	99108	14-256		**	999175	99175	14-256		52	999239	99239	14-256		**
999110	99110	14-256	350SK	49	999176	99176	14-256	250SK	**	999240	99240	14-256		28
999111	99111	14-256		49	999177	99177	14-256		26	999241	99241	14-256		**
999112	99112	14-256		49	999181	99181	14-200	300SK	**	999242	99242	14-256		**
999113	99113	14-256		49	999183	99183	14-256		26	999243	99243	14-256		64

Cross Reference - 7500/9500 & GT

MFGR PART #	KIT MASTERS PART #	USE KIT	Also Use Kit	CAT. PAGE #	MFGR PART #	KIT MASTERS PART #	USE KIT	Also Use Kit	CAT. PAGE #	MFGR PART #	KIT MASTERS PART #	USE KIT	Also Use Kit	CAT. PAGE #
999246	99246	14-256		**	999317	99317	14-256		30	999378	99378	14-256		**
999247	99247	14-256		67	999318	99318	14-256		30	999380	99380	14-256		**
999248	99248	14-256-1		**	999319	99319	14-256		30	999381	99381	14-256		70
999251	99251	14-256-1		**	999320	99320	14-256		30	999382	99382	14-256		33
999252	99252	14-256		66	999321	99321	14-256		**	999383	99383	14-256		**
999253	99253	14-256	350SK	**	999322	99322	14-256		30	999384	99384	14-256		54
999254	99254	14-256		**	999323	99323	14-256		30	999385	99385	14-256		**
999255	99255	14-256		**	999324	99324	14-256		**	999386	99386	14-256		34
999256	99256	14-256	300SK	64	999325	99325	14-256	250SK	53	999387	99387	14-256		34
999259	99259	14-256-1		**	999326	99326	14-256		54	999388	99388	14-256		**
999261	99261	14-256		**	999327	99327	14-256		31	999389	99389	14-256	250SK	54
999262	99262	14-256		**	999329	99329	14-256		**	999395	99395	14-256		**
999263	99263	14-256		53	999330	99330	14-256		31	999396	99191	14-256	300SK	27
999264	99264	14-256		**	999331	99331	14-256		54	999398	99398	14-256		**
999266	99266	14-256		**	999332	99332	14-256	250SK	**	999399	99399	14-256		67
999268	99268	14-256		64	999333	99333	14-256		31	999400	99400	14-256		67
999269	99269	14-256		28	999334	99334	14-256		31	999401	99401	14-256		34
999270	99270	14-256		**	999335	99335	14-256		**	999402	99402	14-256		**
999272	99410	14-256		64	999336	99336	14-256-1		70	999403	99403	14-256		34
999273	99273	14-256		28	999337	99337	14-256		31	999404	99404	14-256		**
999274	99274	14-256	14-ADPT + 250SK	**	999339	99339	14-256-1		31	999405	99405	14-256		**
999275	99275	14-256-1		70	999340	99361	14-256		32	999406	99406	14-256		**
999277	99277	14-256		**	999341	99341	14-256-1		31	999407	99407	14-256		67
999278	99278	14-256		**	999342	99342	14-256		31	999409	99409	14-256		**
999279	99279	14-256		28	999343	99343	14-256		54	999410	99410	14-256		64
999280	99280	14-256		28	999346	99346	14-256		32	999411	99411	14-256-1		34
999281	99281	14-256		29	999347	99347	14-256		67	999412	99412	14-256-1		34
999282	99282	14-256	200SK	53	999348	99348	14-256		67	999413	99413	14-256		34
999283	99283	14-256	200SK	**	999349	99349	14-256		54	999414	99414	14-256		34
999285	99285	14-256		69	999350	99350	14-256		**	999415	99415	14-256		55
999286	99286	14-200	300SK	64	999351	99351	14-256		32	999416	99416	14-256	300SK	**
999289	99289	14-256	300SK	29	999352	99352	14-256		**	999417	99417	14-256		**
999291	99291	14-256		29	999353	99353	14-256-1		**	999418	99418	14-256		**
999292	99292	14-256		29	999354	99354	14-256		32	999419	99419	14-200	200SK	65
999293	99071	14-256		24	999356	99356	14-256	250SK	67	999420	99420	14-256		35
999294	99294	14-256		29	999357	99357	14-256	250SK	67	999421	99421	14-256		**
999295	99295	14-256		53	999358	99358	14-256-1		32	999422	99422	14-256		35
999296	99296	14-256	350SK	**	999359	99359	14-256-1		32	999423	99423	14-256		68
999297	99297	14-256		**	999360	99360	14-256		32	999424	99202	14-256		**
999298	99298	14-256		29	999361	99361	14-256		32	999425	99425	14-256		35
999300	99300	14-256		64	999362	99362	14-256		32	999426	99426	14-256		68
999301	99301	14-256-1		70	999363	99363	14-256-1		33	999427	99427	14-256		68
999302	99302	14-256-1		70	999364	99364	14-256		**	999428	99428	14-256		35
999303	99303	14-256		**	999365	99365	14-256		**	999429	99429	14-256		65
999304	99304	14-200		**	999366	99366	14-256		33	999430	99430	14-256		55
999305	99305	14-200		64	999367	99367	14-256-1		33	999431	99431	14-256		**
999306	99306	14-256		**	999368	99368	14-256-1		33	999434	99434	14-256		**
999307	99307	14-256		29	999369	99369	14-256		33	999435	99281	14-256		29
999309	99309	14-256		53	999372	99466	14-256		55	999436	99279	14-256		28
999310	99310	14-256-1		53	999373	99197	14-256		52, 72	999437	99346	14-256		32
999311	99311	14-256-1		29	999374	99374	14-256		33	999438	99438	14-256		35
999313	99313	14-256		30	999375	99375	14-256		**	999439	99439	14-256		35
999316	99316	14-256		30	999377	99377	14-256		33	999440	99440	14-256		35

** NON-STANDARD: OEM# is not available as a standard remanufactured fan clutch. Kit Masters does stock many non-standard items, please call for availability.

Cross Reference - 7500/9500 & GT

MFGR PART #	KIT MASTERS PART #	USE KIT	Also Use Kit	CAT. PAGE #	MFGR PART #	KIT MASTERS PART #	USE KIT	Also Use Kit	CAT. PAGE #	MFGR PART #	KIT MASTERS PART #	USE KIT	Also Use Kit	CAT. PAGE #
999444	99444	14-256	200SK	**	999521	99521	14-256		**	999843	99336	14-256-1		70
999445	99445	14-256		**	999522	99522	14-256		**	999844	99844	14-256-1		**
999446	99446	14-256		55	999523	99523	14-256	250SK	**	999845	99845	14-256		**
999448	99448	14-256		**	999525	99525	14-256-1	250SK	**	999846	99846	14-256-1		**
999450	99450	14-256	200SK	65	999526	99526	14-256		**	999847	99847	14-256		**
999451	99451	14-256		**	999528	99528	14-256-1		**	999848	99897	14-256		56
999452	99452	14-256		**	999529	99529	14-256		**	999849	99849	14-256		65
999453	99453	14-256-1		35	999530	99530	14-256	250SK	**	999850	99850	14-256		65
999454	99454	14-256		72	999531	99531	14-256	250SK	**	999852	99852	14-256		**
999455	99455	14-256-1		71	999532	99532	14-256		**	999853	99853	14-256-1		**
999457	99457	14-256		**	999533	99533	14-256		**	999854	99854	14-256		**
999458	99458	14-256		**	999534	99534	14-256	350SK	**	999855	99855	14-256		**
999459	99459	14-256	200SK	**	999537	99537	14-256		**	999856	99856	14-256		**
999461	99461	14-256		**	999538	99538	14-256	150SK	**	999857	99857	14-256		**
999463	99196	14-256		72	999800	99800	14-256		**	999858	99858	14-256		**
999465	99197	14-256		52, 72	999801	99801	14-256		55	999859	99859	14-256		**
999466	99466	14-256		55	999802	99802	14-256		**	999860	99860	14-256		**
999467	99467	14-256		**	999803	99803	14-256		**	999861	99861	14-256		**
999468	99431	14-256		**	999804	99804	14-256		**	999862	99862	14-256-1		**
999469	99469	14-256		**	999805	99805	14-256		**	999863	99863	14-256		**
999470	99247	14-256		67	999806	99806	14-256		**	999864	99864	14-256		**
999471	99400	14-256		67	999807	99807	14-256-1		**	999865	99865	14-256	275SK	**
999472	99399	14-256		67	999808	99808	14-256		**	999866	99866	14-256		**
999473	99347	14-256		67	999809	99809	14-256		36	999867	99867	14-256		**
999474	99348	14-256		67	999810	99810	14-256		**	999868	99868	14-256		**
999475	99423	14-256		68	999812	99812	14-256		**	999869	99869	14-256		**
999476	99497	14-256		68	999813	99813	14-256		**	999870	99870	14-256		**
999477	99498	14-256		**	999815	99815	14-256		**	999871	99871	14-256		**
999478	99426	14-256		68	999816	99816	14-256		**	999872	99872	14-256		**
999491	99247	14-256		67	999817	99817	14-256		**	999873	99873	14-256		**
999492	99400	14-256		67	999818	99818	14-256		36	999874	99874	14-256		**
999493	99399	14-256		67	999819	99819	14-256		**	999875	99875	14-256-1		**
999494	99347	14-256		67	999820	99804	14-256		**	999876	99876	14-256		**
999495	99348	14-256		67	999821	99821	14-256		**	999877	99877	14-256		**
999496	99496	14-256		68	999822	99822	14-256		**	999878	99878	14-256		**
999497	99497	14-256		68	999823	99823	14-256		55	999879	99879	14-256		**
999498	99498	14-256		**	999824	99824	14-256		**	999880	99880	14-256		**
999499	99426	14-256		68	999825	99825	14-256-1		**	999881	99881	14-256		**
999500	99500	14-256		**	999826	99826	14-256		**	999882	99882	14-256		**
999501	99501	14-256		**	999827	99827	14-256		**	999883	99883	14-256-1		**
999502	99502	14-256		**	999828	99828	14-256		**	999884	99884	14-256		**
999503	99503	14-256	250SK	**	999829	99829	14-256		**	999885	99885	14-256		56
999504	99504	14-256		**	999830	99830	14-256		**	999886	99886	14-256		**
999505	99505	14-256		**	999831	99897	14-256		56	999887	99887	14-256		**
999506	99506	14-256	300SK	**	999832	99469	14-256		**	999888	99888	14-256	200SK	**
999508	99508	14-256		**	999834	99834	14-256		36	999889	99889	14-256		**
999509	99509	14-256	250SK	**	999835	99835	14-256		**	999890	99890	14-256		**
999510	99510	14-256		**	999836	99836	14-256-1		**	999891	99834	14-256		36
999511	99511	14-256	150SK	**	999837	99837	14-256		**	999892	99892	14-256		**
999512	99512	14-256		**	999838	99899	14-256		**	999893	99893	14-256-1		**
999513	99513	14-256		**	999839	99600	14-256		55	999894	99894	14-256		**
999514	99514	14-256	150SK	**	999840	99600	14-256		55	999895	99895	14-256		**
999515	99188	14-256	150SK	52	999841	99841	14-256-1		**	999896	99896	14-256-1		**
999517	99517	14-256		**	999842	99842	14-256		**	999897	99897	14-256		56

Cross Reference - 7500/9500 & GT

MFGR PART #	KIT MASTERS PART #	USE KIT	Also Use Kit	CAT. PAGE #	MFGR PART #	KIT MASTERS PART #	USE KIT	Also Use Kit	CAT. PAGE #	MFGR PART #	KIT MASTERS PART #	USE KIT	Also Use Kit	CAT. PAGE #
99A8600	99600	14-256		55	99A9366	99366	14-256		33	99A9756	99756	14-256		**
99A8601	99601	14-256		55	99A9405	99405	14-256		**	99A9757	99757	14-256		**
99A8602	99602	14-256		**	99A9437	99437	14-256		**	99A9759	99759	14-256		**
99A8603	99603	14-256		**	99A9461	99461	14-256		**	99A9769	99769	14-256		**
99A8604	99604	14-256		**	99A9505	99505	14-256		**	99A9770	99770	14-256		**
99A8607	99607	14-256		**	99A9506	99506	14-256		**	99A9771	99771	14-256		**
99A8608	99608	14-256		**	99A9509	99509	14-256		**	99A9801	99801	14-256		55
99A8609	99609	14-256		**	99A9511	99511	14-256		**	99A9809	99809	14-256		36
99A8611	99611	14-256		**	99A9515	99188	14-256		52	99A9816	99816	14-256		**
99A8613	99613	14-256		**	99A9522	99522	14-256		**	99A9829	99829	14-256		**
99A8616	99616	14-256		**	99A9536	99536	14-256		**	99A9830	99830	14-256		**
99A8620	99620	14-256		**	99A9551	99551	14-256		**	99A9833	99833	14-256		**
99A8621	99621	14-256		65	99A9552	99552	14-256		**	99A9837	99837	14-256		**
99A8627	99627	14-256		**	99A9553	99553	14-256		**	99A9840	99600	14-256		55
99A8631	99631	14-256		**	99A9554	99554	14-256		**	99A9842	99842	14-256		**
99A8634	99634	14-256		**	99A9558	99558	14-256		**	99A9845	99845	14-256		**
99A8635	99635	14-256		**	99A9559	99559	14-256		**	99A9847	99847	14-256		**
99A8638	99638	14-256		**	99A9562	99562	14-256		**	99A9850	99850	14-256		65
99A8642	99642	14-256		**	99A9564	99564	14-256		**	99A9855	99855	14-256		**
99A8643	99643	14-256		**	99A9569	99569	14-256		**	99A9856	99856	14-256		**
99A8647	99647	14-256		**	99A9570	99570	14-256		**	99A9858	99858	14-256		**
99A8648	99648	14-256		**	99A9573	99573	14-256		**	99A9859	99859	14-256		**
99A8650	99650	14-256		**	99A9709	99709	14-256		**	99A9861	99861	14-256		**
99A8652	99652	14-256		**	99A9710	99710	14-256		**	99A9863	99863	14-256		**
99A8653	99653	14-256		**	99A9711	99711	14-256		**	99A9864	99864	14-256		**
99A8655	99655	14-256		**	99A9714	99714	14-256		**	99A9865	99865	14-256		**
99A8656	99656	14-256		**	99A9720	99720	14-256		**	99A9867	99867	14-256		**
99A8657	99657	14-256		**	99A9729	99729	14-256		**	99A9868	99868	14-256		**
99A9023	99023	14-256		66	99A9730	99730	14-256		**	99A9870	99870	14-256		**
99A9024	99024	14-256		66	99A9731	99731	14-256		**	99A9871	99871	14-256		**
99A9161	99161	14-256		26	99A9732	99732	14-256		**	99A9872	99872	14-256		**
99A9168	99168	14-256		51	99A9733	99733	14-256		**	99A9873	99873	14-256		**
99A9189	99189	14-256		27	99A9734	99734	14-256		**	99A9874	99874	14-256		**
99A9191	99191	14-256	300SK	27	99A9736	99736	14-256		**	99A9876	99876	14-256		**
99A9194	99194	14-256		27	99A9742	99742	14-256		**	99A9877	99877	14-256		**
99A9198	99198	14-256		52	99A9743	99743	14-256		**	99A9878	99878	14-256		**
99A9238	99238	14-256		53	99A9744	99744	14-256		**	99A9879	99879	14-256		**
99A9263	99263	14-256		53	99A9745	99745	14-256		**	99A9885	99885	14-256		56
99A9264	99264	14-256		**	99A9746	99746	14-256		**	99A9886	99886	14-256		**
99A9306	99306	14-256		**	99A9747	99747	14-256		**	99A9887	99887	14-256		**
99A9313	99313	14-256		30	99A9748	99748	14-256		**	99A9892	99892	14-256		**
99A9319	99319	14-256		30	99A9749	99749	14-256		**	99A9897	99897	14-256		56
99A9334	99334	14-256		31	99A9750	99750	14-256		**	99A9898	99834	14-256		36
99A9360	99360	14-256		32	99A9752	99752	14-256		**					

** NON-STANDARD: OEM# is not available as a standard remanufactured fan clutch. Kit Masters does stock many non-standard items, please call for availability.

Cross Reference - Bendix®

OEM	Kit Masters Part #	Conversion Clutch #	Use Kit #	Cat. Page #
065480	108621X	108621GTN	106731	XX
065505	109355X	109355GTN	106731	XX
065520	109376X	109376GTN	106731	XX
065525	109400X	109400GTN	106731	XX
102532	Call Us	-	-	**
102666	Call Us	-	-	**
104725	104725X	104725GTN	104939	73
104735	104735X	104735GTN	104939	73
104750	104750X	104750GTN	104939	73
104751	104751X	104750GTN	104939	73
104752	104756X	104756GTN	104941	73
104753	104757X	104757GTN	104941	73
104756	104756X	104756GTN	104941	73
104757	104757X	104757GTN	104941	73
104758	104758X	104758GTN	104939	73
104759	104760X	104760GTN	104941	73
104760	104760X	104760GTN	104941	73
104761	104761X	104761GTN	104939	74
104762	104763X	104763GTN	104941	74
104763	104763X	104763GTN	104941	74
104764	104764X	104764GTN	104939	**
104765	104765X	104765GTN	104941	**
104766	104765X	104765GTN	104941	**
104767	104767X	104767GTN	104939	74
104768	104769X	104769GTN	104941	74
104769	104769X	104769GTN	104941	74
104770	104770X	104770GTN	104939	74
104771	104772X	104772GTN	104941	74
104772	104772X	104772GTN	104941	74
104773	104773X	104773GTN	104939	74
104774	104775X	104775GTN	104941	74
104775	104775X	104775GTN	104941	74
104776	104776X	104776GTN	104939	75
104777	104778X	104778GTN	104941	75
104778	104778X	104778GTN	104941	75
104779	104779X	104779GTN	104939	**
104780	104781X	104781GTN	104941	**
104781	104781X	104781GTN	104941	**
104782	104782X	104782GTN	104939	75
104783	104784X	104784GTN	104941	75
104784	104784X	104784GTN	104941	75
104785	104785X	104785GTN	104939	75
104786	104787X	104787GTN	104941	75
104787	104787X	104787GTN	104941	75
104870	104870X	104870GTN	104939	75

OEM	Kit Masters Part #	Conversion Clutch #	Use Kit #	Cat. Page #
104871	104871X	104871GTN	104939	75
104872	104872X	104872GTN	104939	76
104873	104873X	104873GTN	104937*	76
104874	104874X	104874GTN	104939	76
104875	104875X	104875GTN	104939	76
104876	104876X	104876GTN	104939	76
104877	104877X	104877GTN	104939	76
104878	104878X	104878GTN	104939	76
104879	104879X	104879GTN	104939	76
104880	104880X	104880GTN	104939	77
104881	104881X	104881GTN	104939	76
104882	104882X	104882GTN	104939	77
104883	104883X	104883GTN	104939	77
104884	104884X	104884GTN	104937*	77
104885	104885X	104885GTN	104937*	77
104886	104886X	104886GTN	104937*	77
104887	104887X	104887GTN	104939	77
104889	104889X	104889GTN	104939	77
104890	104890X	104890GTN	104939	77
104891	104891X	104891GTN	104939	77
104892	104892X	104892GTN	104937*	77
104893	104893X	104893GTN	104939	78
104894	104894X	104894GTN	104939	78
104895	104894X	104894GTN	104939	78
104896	104896X	104896GTN	104937*	78
104897	104897X	104897GTN	104937*	78
104898	104898X	104898GTN	104937*	78
104899	104899X	104899GTN	104937*	78
104900	104900X	104900GTN	104937*	78
104901	104901X	104901GTN	104939	78
104902	104902X	104902GTN	104939	79
104903	104903X	104903GTN	104939	79
104904	104904X	104904GTN	104939	**
104905	104905X	104905GTN	104939	79
104906	104906X	104906GTN	104939	**
104907	104907X	104907GTN	104937*	**
104915	104750X	104750GTN	104939	73
104916	104751X	104751GTN	104939	73
104917	104758X	104758GTN	104939	73
104918	104761X	104761GTN	104939	74
104919	104764X	104764GTN	104939	**
104920	104767X	104767GTN	104939	74
104921	104770X	104770GTN	104939	74
104922	104773X	104773GTN	104939	74
104923	104776X	104776GTN	104939	75

OEM	Kit Masters Part #	Conversion Clutch #	Use Kit #	Cat. Page #
104924	104779X	104779GTN	104939	**
104925	104782X	104782GTN	104939	75
104926	104785X	104785GTN	104939	75
104965	104965X	104965GTN	104939	79
104981	104981X	104981GTN	104941	79
104987	104989X	104989GTN	104941	79
104988	104990X	104990GTN	104941	79
104989	104989X	104989GTN	104941	79
104990	104990X	104990GTN	104941	79
106091	106091X	106091GTN	104941	**
106092	106092X	106092GTN	104941	79
106093	106093X	106093GTN	104941	79
106095	106095X	106095GTN	104941	80
106096	106096X	106096GTN	104941	80
106097	106097X	106097GTN	104941	80
106098	106098X	106098GTN	104941	80
106099	106099X	106099GTN	104941	80
106120	106120X	106120GTN	104941	80
106235	106235X	106235GTN	104941	80
106236	106236X	106236GTN	104941	80
106237	106876X	106876GTN	104941	82
106238	106238X	106238GTN	104941	80
106270	106270X	106270GTN	104941	**
106271	106271X	106271GTN	104941	81
106272	106272X	106272GTN	104941	81
106291	106291X	106291GTN	104941	**
106350	106350X	106350GTN	104941	81
106450	106450X	106450GTN	104941	81
106723	106724X	106724GTN	106731	81
106724	106724X	106724GTN	106731	81
106734	106970X	106970GTN	106731	82
106772	106970X	106970GTN	106731	82
106841	106842X	106842GTN	104941	81
106842	106842X	106842GTN	104941	81
106844	106844X	106844GTN	104939	81
106866	106866X	106866GTN	104939	81
106876	106876X	106876GTN	104941	82
106969	106970X	106970GTN	106731	82
106970	106970X	106970GTN	106731	82
106973	106974X	106974GTN	106731	82
106974	106974X	106974GTN	106731	82
107147	107147X	107147GTN	104941	**
107172	107473X	107473GTN	106731	82
107173	107473X	107473GTN	106731	82
107472	107473X	107473GTN	106731	82

* Seal Kit

Manufacturer's names, symbols, numbers and descriptions are used for reference purposes only. It is not implied that any part listed is the product of these manufacturers.

Cross Reference - Bendix®

OEM	Kit Masters Part #	Conversion Clutch #	Use Kit #	Cat. Page #	OEM	Kit Masters Part #	Conversion Clutch #	Use Kit #	Cat. Page #	OEM	Kit Masters Part #	Conversion Clutch #	Use Kit #	Cat. Page #
107473	107473X	107473GTN	106731	82	108462	108463X	108463GTN	106731	84	288028	104870X	104870GTN	104939	75
107480	107480X	107480GTN	104939	**	108463	108463X	108463GTN	106731	84	288606	104878X	104878GTN	104939	76
107542	107542X	107542GTN	106731	82	108464	108464X	108464GTN	106731	84	288610	104873X	104873GTN	104937*	76
107543	107543X	107543GTN	106731	82	108483	108483X	108483GTN	106731	84	288614	104874X	104874GTN	104939	76
107544	107544X	107544GTN	106731	**	108497	108497X	108497GTN	106731	**	288615	104871X	104871GTN	104939	75
107580	107580X	107580GTN	104939	82	108530	108530X	108530GTN	106731	84	288626	104782X	104782GTN	104939	75
107626	107627X	107627GTN	106731	82	108531	108531X	108531GTN	106731	**	288636	104870X	104870GTN	104939	75
107627	107627X	107627GTN	106731	82	108532	108532X	108532GTN	106731	**	288670	104873X	104873GTN	104937*	76
107638	107638X	107638GTN	104939	83	108533	108533X	108533GTN	106731	84	288689	104782X	104782GTN	104939	75
107815	104981X	104981GTN	104941	79	108534	108534X	108534GTN	106731	85	288880	104770X	104770GTN	104939	74
107878	107941X	107941GTN	106731	**	108552	108552X	108552GTN	106731	85	288901	104877X	104877GTN	104939	76
107889	107942X	107942GTN	106731	83	108553	108553X	108553GTN	106731	85	288945	104880X	104880GTN	104939	77
107900	107901X	107901GTN	106731	83	108621	108621X	108621GTN	106731	85	288619	104885X	104885GTN	104937*	77
107901	107901X	107901GTN	106731	83	108629	108633X	108633GTN	106731	**	288623	104885X	104885GTN	104937*	77
107940	107940X	107940GTN	104940	83	108696	108696X	108696GTN	106731	85	288633	104885X	104885GTN	104937*	77
107941	107941X	107941GTN	106731	**	108697	108697X	108697GTN	106731	85	288915	104904X	104904GTN	104939	**
107942	107942X	107942GTN	106731	83	108817	108817X	108817GTN	104939	**	288916	104904X	104904GTN	104939	**
107970	107970X	107970GTN	104939	83	108893	108893X	108893GTN	106731	**	288931	104897X	104897GTN	104937*	78
108006	108006X	108006GTN	104941	83	109032	109032X	109032GTN	104939	85	288938	104892X	104892GTN	104937*	77
108057	108122X	108122GTN	106731	83	109171	108621X	108621GTN	106731	85	288997	104883X	104883GTN	104939	77
108122	108122X	108122GTN	106731	83	109353	109355X	109355GTN	106731	85	289000	104896X	104896GTN	104937*	78
108323	108323X	108323GTN	104939	83	109354	109355X	109355GTN	106731	85	289064	104899X	104899GTN	104937*	78
108378	108378X	108378GTN	106731	84	109355	109355X	109355GTN	106731	85	289386	104889X	104889GTN	104939	77
108432	108464X	108464GTN	106731	84	109372	109376X	109376GTN	106731	86	289526	104890X	104890GTN	104939	77
108445	108450X	108450GTN	106731	**	109374	109376X	109376GTN	106731	86	289552	104897X	104897GTN	104937*	78
108450	108450X	108450GTN	106731	**	109376	109376X	109376GTN	106731	86	289565	104901X	104901GTN	104939	78
108460	108460X	108460GTN	106731	84	109386	109386X	109386GTN	104941	**	289673	104884X	104884GTN	104937*	77
108458	108461X	108461GTN	106731	84	109398	109400X	109400GTN	106731	86	289695	104900X	104900GTN	104937*	78
108459	108460X	108460GTN	106731	84	109399	109400X	109400GTN	106731	86	289841	104782X	104782GTN	104939	75
108460	108460X	108460GTN	106731	84	109400	109400X	109400GTN	106731	86					
108461	108461X	108461GTN	106731	84	287847	104894X	104894GTN	104939	78					

* Seal Kit

** NON-STANDARD: OEM# is not available as a standard remanufactured fan clutch. Kit Masters does stock many non-standard items, please call for availability.

Cross Reference - Front Air & Rear Air

OEM #	Description	Kit Masters #	Use Kit #
1033-05435-02	K22 Front Air Seal Kit with Lining	8000SKL	
1033-05435-03	K22 Rear Air Seal Kit with Lining	8500SKL	
1033-07781-01	Bearing Kit for Pulley	8581-01	
1033-07782-01	Bearing Kit for Pulley	8582-01	
1033-07782-02	Bearing Kit for Pulley	8582-02	
1033-07782-03	Bearing Kit for Pulley	8582-03	
1033-07782-04	Bearing Kit for Pulley	8582-04	
1033-08233-01	K22/K26 Rear Air Seal Kit	8500SK	
1033-08233-01	K22 Front Air Seal Kit	8000SK	
1033-08250-01	K22 Lining Kit	8500L	
1033-09339-01	K26 Rear Air Seal Kit with Lining	8800SKL	
1033-09340-01	K26 Lining Kit	8800L	
1090-07050-01	K22 Front Air Remanufactured Fan Clutch	8001X	N/A
1090-07050-03	K22 Front Air Remanufactured Fan Clutch	8005X	N/A
1090-08000-01	K22 Front Air Remanufactured Fan Clutch	8001X	8000SKL
1090-08000-05	K22 Front Air Remanufactured Fan Clutch	8005X	8000SKL
1090-08500-01	K22 Rear Air Remanufactured Fan Clutch	8801X	8500SKL
1090-08500-02	K22 Rear Air Remanufactured Fan Clutch	8802X	8500SKL
1090-08500-03	K22 Rear Air Remanufactured Fan Clutch	8803X	8500SKL
1090-09000-01	K26 Front Air Remanufactured Fan Clutch	8001X	NA
1090-09500-01	K26 Rear Air Remanufactured Fan Clutch	8801X	8800SKL
1090-09500-03	K26 Rear Air Remanufactured Fan Clutch	8803X	8800SKL
1090-09600-01	K30 Rear Air Remanufactured Fan Clutch	8801X	8800SKL
1090-09900-01	K30 Rear Air Remanufactured Fan Clutch	8801X	8800SKL

OEM PART #		KIT MASTERS PART #		OEM PART #		KIT MASTERS PART #	
HUB & CLUTCH PART #	HUB ONLY PART #	HUB BEARING KIT PART #	REMAN. FAN CLUTCH PART #	HUB & CLUTCH PART #	HUB ONLY PART #	HUB BEARING KIT PART #	REMAN. FAN CLUTCH PART #
1093-07736-01	1077-07735-01	8581-01	8801X	1093-07768-07	1077-07767-07	8581-01	8801X
1093-07736-02	1077-07735-02	8581-01	8801X	1093-07768-08	1077-07767-08	8581-01	8801X
1093-07736-03	1077-07735-03	8581-01	8801X	1093-07768-09	1077-07767-09	8581-01	8801X
1093-07736-04	1077-07735-04	8581-01	8801X	1093-07771-01	1077-07770-01	8581-01	8801X
1093-07736-05	1077-07735-05	8581-01	8801X	1093-07771-02	1077-07770-02	8581-01	8801X
1093-07736-06	1077-07735-06	8581-01	8801X	1093-07771-03	1077-07770-03	8581-01	8801X
1093-07736-07	1077-07735-07	8581-01	8801X	1093-07771-04	1077-07770-04	8581-01	8801X
1093-07736-08	1077-07735-08	8581-01	8801X	1093-07771-05	1077-07770-05	8581-01	8801X
1093-07736-09	1077-07735-09	8581-01	8801X	1093-07771-06	1077-07770-06	8581-01	8801X
1093-07736-10	1077-07735-10	8581-01	8801X	1093-07771-07	1077-07770-07	8581-01	8801X
1093-07736-12	1077-07735-12	8581-01	8801X	1093-07771-08	1077-07770-08	8581-01	8801X
1093-07736-13	1077-07735-13	8581-01	8801X	1093-07771-09	1077-07770-09	8581-01	8801X
1093-07736-14	1077-07735-14	8581-01	8801X	1093-07771-10	1077-07770-10	8581-01	8801X
1093-07736-15	1077-07735-15	8581-01	8801X	1093-07771-12	1077-07770-12	8581-01	8801X
1093-07740-01	1077-07738-01	8582-01	8801X	1093-07771-13	1077-07770-13	8581-01	8801X
1093-07740-02	1077-07738-02	8582-01	8801X	1093-07868-01	1077-07867-01	8581-01	8801X
1093-07740-03	1077-07738-03	8582-01	8801X	1093-07868-02	1077-07867-02	8581-01	8801X
1093-07740-04	1077-07738-04	8582-01	8801X	1093-07868-03	1077-07867-03	8581-01	8801X
1093-07740-06	1077-07738-06	8582-01	8801X	1093-07868-04	1077-07867-04	8581-01	8801X
1093-07740-07	1077-07738-07	8582-01	8801X	1093-07868-05	1077-07867-05	8581-01	8801X
1093-07758-01	1077-07757-01	8582-01	8801X	1093-07868-06	1077-07867-06	8581-01	8801X
1093-07758-02	1077-07757-02	8582-01	8801X	1093-07868-07	1077-07867-07	8581-01	8801X
1093-07768-01	1077-07767-01	8581-01	8801X	1093-07868-08	1077-07867-08	8581-01	8801X
1093-07768-02	1077-07767-02	8581-01	8801X	1093-07868-09	1077-07867-09	8581-01	8801X
1093-07768-03	1077-07767-03	8581-01	8801X	1093-07868-10	1077-07867-10	8581-01	8801X
1093-07768-04	1077-07767-04	8581-01	8801X	1093-07868-11	1077-07867-11	8581-01	8801X
1093-07768-05	1077-07767-05	8581-01	8801X	1093-07868-12	1077-07867-12	8581-01	8801X
1093-07768-06	1077-07767-06	8581-01	8801X	1093-07870-01	1077-07869-01	8581-01	8801X

KIT MASTERS HAS MOST 1077-XXXXX-XX KYSOR-STYLE HUBS AVAILABLE

Cross Reference - Rear Air

OEM PART #		KIT MASTERS PART #		OEM PART #		KIT MASTERS PART #	
HUB & CLUTCH PART #	HUB ONLY PART #	HUB BEARING KIT PART #	REMAN. FAN CLUTCH PART #	HUB & CLUTCH PART #	HUB ONLY PART #	HUB BEARING KIT PART #	REMAN. FAN CLUTCH PART #
1093-07870-02	1077-07869-02	8581-01	8801X	1093-08040-02	1077-08039-02	8581-01	8801X
1093-07870-03	1077-07869-03	8581-01	8801X	1093-08070-01	1077-08069-01	8581-01	8801X
1093-07870-04	1077-07869-04	8581-01	8801X	1093-08070-02	1077-08069-02	8581-01	8801X
1093-07896-01	1077-07895-01	8581-01	8801X	1093-08072-01	1077-08071-01	8581-01	8801X
1093-07896-02	1077-07895-02	8581-01	8801X	1093-08072-02	1077-08071-02	8581-01	8801X
1093-07896-03	1077-07895-03	8581-01	8801X	1093-08072-03	1077-08071-03	8581-01	8801X
1093-07896-04	1077-07895-04	8581-01	8801X	1093-08072-04	1077-08071-04	8581-01	8801X
1093-07896-05	1077-07895-05	8581-01	8801X	1093-08072-05	1077-08071-05	8581-01	8801X
1093-07896-06	1077-07895-06	8581-01	8801X	1093-08080-01	1077-08079-01	8581-01	8801X
1093-07896-07	1077-07895-07	8581-01	8801X	1093-08080-02	1077-08079-02	8581-01	8801X
1093-07896-08	1077-07895-08	8581-01	8801X	1093-08080-03	1077-08079-03	8581-01	8801X
1093-07896-09	1077-07895-09	8581-01	8801X	1093-08080-04	1077-08079-04	8581-01	8801X
1093-07896-12	1077-07895-12	8581-01	8801X	1093-08080-05	1077-08079-05	8581-01	8801X
1093-07900-01	1077-07899-01	8582-01	8801X	1093-08080-06	1077-08079-06	8581-01	8801X
1093-07900-02	1077-07899-02	8582-01	8801X	1093-08080-07	1077-08079-07	8581-01	8801X
1093-07900-03	1077-07899-03	8582-01	8801X	1093-08093-01	1077-08092-01	8581-01	8801X
1093-07904-01	1077-07903-01	8581-01	8801X	1093-08093-02	1077-08092-02	8581-01	8801X
1093-07906-01	1077-07905-01	8581-01	8801X	1093-08100-01	1077-08099-01	8581-01	8801X
1093-07906-02	1077-07905-02	8581-01	8801X	1093-08100-02	1077-08099-02	8581-01	8801X
1093-07906-04	1077-07905-04	8581-01	8801X	1093-08100-03	1077-08099-03	8581-01	8801X
1093-07909-01	1077-07908-01	8581-01	8801X	1093-08100-04	1077-08099-04	8581-01	8801X
1093-07912-01	1077-07911-01	8581-01	8801X	1093-08100-05	1077-08099-05	8581-01	8801X
1093-07928-01	1077-07927-01	8581-01	8801X	1093-08100-06	1077-08099-06	8581-01	8801X
1093-07928-02	1077-07927-02	8581-01	8801X	1093-08100-07	1077-08099-07	8581-01	8801X
1093-07930-01	1077-07929-01	8581-01	8801X	1093-08100-08	1077-08099-08	8581-01	8801X
1093-07930-02	1077-07929-02	8581-01	8801X	1093-08100-09	1077-08099-09	8581-01	8801X
1093-07930-03	1077-07929-03	8581-01	8801X	1093-08100-11	1077-08099-11	8581-01	8801X
1093-07930-04	1077-07929-04	8581-01	8801X	1093-08102-01	1077-08101-01	8582-01	8801X
1093-07930-05	1077-07929-05	8581-01	8801X	1093-08102-02	1077-08101-02	8581-01	8801X
1093-07930-06	1077-07929-06	8581-01	8801X	1093-08102-03	1077-08101-03	8581-01	8801X
1093-07930-07	1077-07929-07	8581-01	8801X	1093-08102-04	1077-08101-04	8581-01	8801X
1093-07930-08	1077-07929-08	8581-01	8801X	1093-08102-05	1077-08101-05	8582-01	8801X
1093-07930-09	1077-07929-09	8581-01	8801X	1093-08102-06	1077-08101-06	8582-01	8801X
1093-07930-10	1077-07929-10	8581-01	8801X	1093-08114-01	1077-08113-01	8582-02	8802X
1093-07930-12	1077-07929-12	8581-01	8801X	1093-08114-02	1077-08113-02	8582-02	8802X
1093-07930-13	1077-07929-13	8581-01	8801X	1093-08114-03	1077-08113-03	8582-02	8802X
1093-07930-15	1077-07929-15	8581-01	8801X	1093-08116-01	1077-08115-01	8582-03	8801X
1093-07930-16	1077-07929-16	8581-01	8801X	1093-08116-02	1077-08115-02	8582-03	8801X
1093-07930-17	1093-07929-17	8581-01	8801X	1093-08116-03	1077-08115-03	8582-03	8801X
1093-07930-18	1093-07929-18	8581-01	8801X	1093-08116-04	1077-08115-04	8582-03	8801X
1093-07934-01	1077-07933-01	8581-01	8801X	1093-08118-01	1077-08117-01	8581-01	8801X
1093-07934-02	1077-07933-02	8581-01	8801X	1093-08118-02	1077-08117-02	8581-01	8801X
1093-07934-03	1077-07933-03	8581-01	8801X	1093-08122-01	1077-08121-01	8582-04	8803X
1093-07934-04	1077-07933-04	8581-01	8801X	1093-08122-02	1077-08121-02	8582-04	8803X
1093-07936-01	1077-07935-01	8581-01	8801X	1093-08122-03	1077-08121-03	8582-04	8803X
1093-07936-02	1077-07935-02	8581-01	8801X	1093-08124-01	1077-08123-01	8581-01	8801X
1093-07936-03	1077-07935-03	8581-01	8801X	1093-08132-01	1077-08131-01	8582-03	8801X
1093-07936-04	1077-07935-04	8581-01	8801X	1093-08132-02	1077-08131-02	8582-03	8801X
1093-07957-01	1077-07956-01	8581-01	8801X	1093-08134-01	1077-08133-01	8582-03	8801X
1093-07957-02	1077-07956-02	8581-01	8801X	1093-08134-02	1077-08133-02	8582-03	8801X
1093-07957-03	1077-07956-03	8581-01	8801X	1093-08134-03	1077-08133-03	8582-03	8801X
1093-07957-04	1077-07956-04	8581-01	8801X	1093-08162-01	1077-08161-01	8582-02	8802X
1093-07987-01	1077-07986-01	8581-01	8801X	1093-08164-01	1077-08163-01	8581-01	8801X
1093-07987-02	1077-07986-02	8581-01	8801X	1093-08167-01	1077-08166-01	8581-01	8801X
1093-08032-01	1077-08031-01	8581-01	8801X	1093-08167-02	1077-08166-02	8581-01	8801X
1093-08032-02	1077-08031-02	8581-01	8801X	1093-08167-03	1077-08166-03	8581-01	8801X
1093-08034-01	1077-08033-01	8581-01	8801X	1093-08167-04	1077-08166-04	8581-01	8801X
1093-08036-01	1077-08035-01	8582-01	8801X	1093-08172-01	1077-08171-01	8582-01	8801X
1093-08040-01	1077-08039-01	8581-01	8801X	1093-08182-01	1077-08181-01	8581-01	8801X

KIT MASTERS HAS MOST 1077-XXXXX-XX RA HUBS AVAILABLE

Cross Reference - Rear Air

OEM PART #		KIT MASTERS PART #		OEM PART #		KIT MASTERS PART #	
HUB & CLUTCH PART #	HUB ONLY PART #	HUB BEARING KIT PART #	REMAN. FAN CLUTCH PART #	HUB & CLUTCH PART #	HUB ONLY PART #	HUB BEARING KIT PART #	REMAN. FAN CLUTCH PART #
1093-08184-01	1077-08183-01	8581-01	8801X	1093-09060-08	1077-09059-08	8581-01	8801X
1093-08192-01	1077-08191-01	8581-01	8801X	1093-09060-09	1077-09059-09	8581-01	8801X
1093-08202-01	1077-08201-01	8581-01	8801X	1093-09060-10	1077-09059-10	8581-01	8801X
1093-08208-01	1077-08207-01	8581-01	8801X	1093-09062-01	1077-09061-01	8582-04	8801X
1093-08208-02	1077-08207-02	8581-01	8801X	1093-09062-02	1077-09061-02	8582-04	8803X
1093-08212-01	1077-08211-01	8581-01	8801X	1093-09064-01	1077-09063-01	8581-01	8801X
1093-08212-02	1077-08211-02	8581-01	8801X	1093-09064-02	1077-09063-02	8581-01	8801X
1093-08218-01	1077-08217-01	8582-01	8802X	1093-09064-04	1077-09063-04	8581-01	8801X
1093-08218-02	1077-08217-02	8582-01	8802X	1093-09068-01	1077-09067-01	8581-01	8801X
1093-08218-03	1077-08217-03	8582-01	8802X	1093-09068-02	1077-09067-02	8581-01	8801X
1093-08222-01	1077-08221-01	8582-01	8802X	1093-09068-03	1077-09067-03	8581-01	8801X
1093-08226-01	1077-08225-01	8581-01	8801X	1093-09072-01	1077-09071-01	8581-01	8801X
1093-08226-02	1077-08225-02	8581-01	8801X	1093-09076-01	1077-09075-01	8581-01	8801X
1093-08232-01	1077-08231-01	8582-01	8801X	1093-09076-02	1077-09075-02	8581-01	8801X
1093-08235-01	1077-08234-01	8581-01	8801X	1093-09076-03	1077-09075-03	8581-01	8801X
1093-08235-02	1077-08234-02	8581-01	8801X	1093-09076-04	1077-09075-04	8581-01	8801X
1093-08258-01	1077-08257-01	8581-01	8801X	1093-09076-05	1077-09075-05	8581-01	8801X
1093-08258-03	1077-08257-03	8581-01	8801X	1093-09078-01	1077-09077-01	8581-01	8801X
1093-08266-01	1077-08265-01	8582-03	8801X	1093-09078-02	1077-09077-02	8581-01	8801X
1093-08266-02	1077-08265-02	8582-03	8801X	1093-09078-03	1077-09077-03	8581-01	8801X
1093-08266-03	1077-08265-03	8582-03	8801X	1093-09078-04	1077-09077-04	8581-01	8801X
1093-08266-04	1077-08265-04	8582-03	8801X	1093-09078-06	1077-09077-06	8581-01	8801X
1093-08266-05	1077-08265-05	8582-03	8801X	1093-09086-01	1077-09085-01	8581-01	8801X
1093-08266-06	1077-08265-06	8582-03	8801X	1093-09086-03	1077-09085-03	8581-01	8801X
1093-08268-01	1077-08267-01	8582-01	8801X	1093-09090-02	1077-09089-02	8581-01	8801X
1093-08268-02	1077-08267-02	8582-01	8801X	1093-09090-03	1077-09089-03	8581-01	8801X
1093-09011-01	1077-09010-01	8581-01	8801X	1093-09092-01	1077-09091-01	8581-01	8801X
1093-09013-01	1077-09012-01	8581-01	8801X	1093-09104-01	1077-09103-01	8581-01	8801X
1093-09013-02	1077-09012-02	8581-01	8801X	1093-09112-01	1077-09111-01	8581-01	8801X
1093-09013-04	1077-09012-04	8581-01	8801X	1093-09112-03	1077-09111-03	8581-01	8801X
1093-09016-01	1077-09015-01	8581-01	8801X	1093-09114-01	1077-09113-01	8581-01	8801X
1093-09016-02	1077-09015-02	8581-01	8801X	1093-09114-02	1077-09113-02	8581-01	8801X
1093-09016-03	1077-09015-03	8581-01	8801X	1093-09114-03	1077-09113-03	8581-01	8801X
1093-09016-04	1077-09015-04	8581-01	8801X	1093-09114-04	1077-09113-04	8581-01	8801X
1093-09018-01	1077-09017-01	8582-01	8801X	1093-09114-05	1077-09113-05	8581-01	8801X
1093-09020-01	1077-09019-01	8581-01	8801X	1093-09117-01	1077-09116-01	8582-02	8801X
1093-09020-02	1077-09019-02	8581-01	8801X	1093-09117-02	1077-09116-02	8581-01	8801X
1093-09020-03	1077-09019-03	8581-01	8801X	1093-09117-03	1077-09116-03	8581-01	8801X
1093-09020-04	1077-09019-04	8581-01	8801X	1093-09117-04	1077-09116-04	8581-01	8801X
1093-09020-05	1077-09019-05	8581-01	8801X	1093-09117-05	1077-09116-05	8582-01	8801X
1093-09022-01	1077-09021-01	8581-01	8801X	1093-09117-06	1077-09116-06	8582-02	8801X
1093-09022-02	1077-09021-02	8581-01	8801X	1093-09117-07	1077-09116-07	8582-02	8801X
1093-09022-03	1077-09021-03	8581-01	8801X	1093-09117-08	1077-09116-08	8582-02	8801X
1093-09022-04	1077-09021-04	8581-01	8801X	1093-09117-09	1077-09116-09	8582-02	8801X
1093-09022-05	1077-09021-05	8581-01	8801X	1093-09117-10	1077-09116-10	8582-02	8801X
1093-09022-06	1077-09021-06	8581-01	8801X	1093-09117-11	1077-09116-11	8582-02	8801X
1093-09026-01	1077-09025-01	8581-01	8801X	1093-09117-14	1077-09116-14	8581-01	8801X
1093-09054-01	1077-09053-01	8582-02	8801X	1093-09117-15	1077-09116-15	8582-02	8801X
1093-09054-02	1077-09053-02	8582-02	8801X	1093-09117-16	1077-09116-16	8582-01	8801X
1093-09054-03	1077-09053-03	8582-02	8801X	1093-09117-17	1077-09116-17	8582-01	8801X
1093-09056-01	1077-09055-01	8581-01	8801X	1093-09117-18	1077-09116-18	8581-01	8801X
1093-09058-01	1077-09057-01	8581-01	8801X	1093-09117-19	1077-09116-19	8581-01	8801X
1093-09060-01	1077-09059-01	8581-01	8801X	1093-09119-01	1077-09118-01	8582-02	8801X
1093-09060-02	1077-09059-02	8581-01	8801X	1093-09119-02	1077-09118-02	8581-01	8801X
1093-09060-03	1077-09059-03	8581-01	8801X	1093-09119-03	1077-09118-03	8581-01	8801X
1093-09060-04	1077-09059-04	8581-01	8801X	1093-09119-04	1077-09118-04	8582-02	8801X
1093-09060-05	1077-09059-05	8581-01	8801X	1093-09119-05	1077-09118-05	8582-02	8801X
1093-09060-06	1077-09059-06	8581-01	8801X	1093-09119-06	1077-09118-06	8582-02	8801X
1093-09060-07	1077-09059-07	8581-01	8801X	1093-09119-07	1077-09118-07	8582-02	8801X

KIT MASTERS HAS MOST 1077-XXXXX-XX RA HUBS AVAILABLE

Cross Reference - Rear Air

OEM PART #		KIT MASTERS PART #		OEM PART #		KIT MASTERS PART #	
HUB & CLUTCH PART #	HUB ONLY PART #	HUB BEARING KIT PART #	REMAN. FAN CLUTCH PART #	HUB & CLUTCH PART #	HUB ONLY PART #	HUB BEARING KIT PART #	REMAN. FAN CLUTCH PART #
1093-09119-08	1077-09118-08	8581-01	8801X	1093-09224-01	1077-09223-01	8582-01	8801X
1093-09119-09	1077-09118-09	8582-02	8801X	1293-09242-01	1077-09241-01	8581-01	8801X
1093-09119-10	1077-09118-10	8582-01	8801X	1293-09247-01	1077-09246-01	8581-01	8801X
1093-09121-01	1077-09120-01	8582-02	8801X	1293-09248-01	1077-09247-01	8581-01	8801X
1093-09121-02	1077-09120-02	8581-01	8801X	1293-09253-01	1077-09252-01B	8581-01	8801X
1093-09121-03	1077-09120-03	8582-02	8801X	1293-09253-02	1077-09252-02B	8581-01	8801X
1093-09121-04	1077-09120-04	8582-02	8801X	1293-09256-01	1077-09255-01	8581-01	8801X
1093-09121-05	1077-09120-05	8582-02	8801X	1293-09256-02	1077-09255-02	8581-01	8801X
1093-09121-06	1077-09120-06	8582-02	8801X	1293-09262-01	1077-09261-01	8581-01	8801X
1093-09121-07	1077-09120-07	8582-02	8801X	1293-09262-02	1077-09261-02	8581-01	8801X
1093-09121-08	1077-09120-08	8581-01	8801X	1293-09262-03	1077-09261-03	8581-01	8801X
1093-09123-01	1077-09122-01	8582-02	8801X	1293-09272-01	1077-09271-01	8581-01	8801X
1093-09123-02	1077-09122-02	8581-01	8801X	1293-09274-01	1077-09273-01	8581-01	8801X
1093-09123-03	1077-09122-03	8581-01	8801X	1293-09276-01	1077-09275-01	8581-01	8801X
1093-09123-04	1077-09122-04	8582-02	8801X	1293-09278-01	1077-09277-01	8581-01	8801X
1093-09123-05	1077-09122-05	8582-02	8801X	1293-09280-01	1077-09279-01	8582-02	8801X
1093-09123-06	1077-09122-06	8582-02	8801X	1293-09282-01	1077-09281-01	8581-01	8801X
1093-09123-07	1077-09122-07	8581-01	8801X	1293-09284-01	1077-09283-01	8581-01	8801X
1093-09123-08	1077-09122-08	8582-01	8801X	1293-09288-01	1077-09287-01	8581-01	8801X
1093-09125-01	1077-09124-01	8582-02	8801X	1293-09290-01	1077-09289-01	8581-01	8801X
1093-09125-02	1077-09124-02	8582-02	8801X	1293-09292-01	1077-09291-01	8581-01	8801X
1093-09125-03	1077-09124-03	8582-02	8801X	1293-09295-01	1077-09294-01	8581-01	8801X
1093-09125-04	1077-09124-04	8582-02	8801X	1293-09298-01	1077-09297-01	8581-01	8801X
1093-09127-01	1077-09126-01	8581-01	8801X	1293-09300-01	1077-09299-01	8581-01	8801X
1093-09127-04	1077-09126-04	8581-01	8801X	1293-09302-01	1077-09301-01	8581-01	8801X
1093-09127-05	1077-09126-05	8581-01	8801X	1293-09304-01	1077-09303-01	8581-01	8801X
1093-09127-06	1077-09126-06	8581-01	8801X	1293-09304-02	1077-09303-02	8581-01	8801X
1093-09129-01	1077-09128-01	8582-02	8801X	1293-09304-03	1077-09303-03	8581-01	8801X
1093-09129-02	1077-09128-02	8581-01	8801X	1293-09304-04	1077-09303-04	8581-01	8801X
1093-09129-03	1077-09128-03	8582-01	8801X	1293-09304-05	1077-09303-05	8581-01	8801X
1093-09129-04	1077-09128-04	8582-01	8801X	1293-09304-06	1077-09303-06	8581-01	8801X
1093-09129-09	1077-09128-09	8581-01	8801X	1293-09304-07	1077-09303-07	8581-01	8801X
1093-09129-10	1077-09128-10	8581-01	8801X	1293-09304-08	1077-09303-08	8581-01	8801X
1093-09129-12	1077-09128-12	8581-01	8801X	1293-09304-09	1077-09303-09	8581-01	8801X
1093-09132-01	1077-09131-01	8581-01	8801X	1293-09304-10	1077-09303-10	8581-01	8801X
1093-09160-01	1077-09159-01	8581-01	8801X	1293-09309-02	1077-09308-02	8581-01	8801X
1093-09160-02	1077-09159-02	8581-01	8801X	1293-09311-01	1077-09310-01	8581-01	8801X
1093-09163-01	1077-09162-01	8581-01	8801X	1293-09314-01	1077-09313-01	8581-01	8801X
1093-09173-01	1077-09174-01	8581-01	8801X	1293-09316-01	1077-09315-01	8581-01	8801X
1093-09177-01	1077-09176-01	8582-01	8801X	1293-09318-01	1077-09317-01	8581-01	8801X
1093-09177-02	1077-09176-02	8582-01	8801X	1293-09320-01	1077-09319-01	8582-02	8801X
1093-09177-03	1077-09176-03	8582-01	8801X	1293-09323-01	1077-09322-01	8581-01	8801X
1093-09177-04	1077-09176-04	8581-01	8801X	1293-09324-01	1077-09323-01	8581-01	8801X
1093-09177-06	1077-09176-06	8581-01	8801X	1293-09330-01	1077-09329-01	8582-01	8801X
1093-09180-01	1077-09179-01	8581-01	8801X	1293-09334-01	1077-09333-01	8582-01	8801X
1093-09189-01	1077-09188-01	8581-01	8801X	1293-09334-01	1077-09335-01B	8582-01	8801X
1093-09189-02	1077-09188-02	8581-01	8801X	1293-09339-01	1077-09338-01B	8582-01	8801X
1093-09189-03	1077-09188-03	8581-01	8801X	1293-09344-01	1077-09343-01	8581-01	8801X
1093-09193-01	1077-09192-01	8581-01	8801X	1293-09348-01	1077-09347-01	8582-01	8801X
1093-09208-01	1077-09207-01	8581-01	8802X	1293-09352-01	1077-09351-01	8581-01	8801X
1093-09210-01	1077-09209-01	8581-01	8801X	1293-09355-01	1077-09354-01	8581-01	8801X
1093-09210-0	1077-09209-02	8581-01	8801X	1293-09355-02	1077-09354-02	8581-01	8801X
1093-09213-01	1077-09212-01	8581-01	8801X	1293-09360-01	1077-09359-01	8581-01	8801X
1093-09215-01	1077-09214-01	8581-01	8801X	1293-09362-01	1077-09361-01	8581-01	8801X
1093-09219-01	1077-09218-01	8581-01	8801X	1293-09364-01	1077-09363-01	8581-01	8801X
1093-09219-02	1077-09218-02	8581-01	8801X	1293-09370-01	1077-09369-01	8581-01	8801X
1093-09221-01	1077-09220-01	8581-01	8801X	1293-09370-02	1077-09369-02	8581-01	8801X
1093-09221-02	1077-09220-02	8581-01	8801X	1293-09374-01	1077-09373-01	8581-01	8801X

KIT MASTERS HAS MOST 1077-XXXXX-XX RA HUBS AVAILABLE

Kit Masters Resources

Sales Flyers

Sales flyers are great way to get the word out about new products and specials. Get the information into your customer's hands today! Call for more program details.



On-Line

Visit www.kit-masters.com for part number lookups, product information, catalog downloads, video resources and installation instructions. Call or log on for more details.



In-Store

Show each product and display your inventory with our POP Display.

