



Ken-Tool®

WHEREVER TIRES ARE CHANGED™



Catalog KT0117

Supersedes Catalog No. KT0915

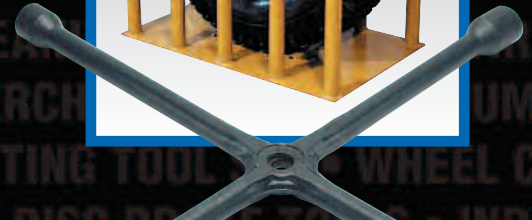



About Ken-Tool

Ken-Tool is the leading manufacturer of tire service tools in the world. Headquartered in Akron, Ohio, Ken-Tool has been providing the tire industry and automotive aftermarket with quality products for over 97 years.

A lot of change has occurred within Ken-Tool over the years. But its long-time tag-line, "Wherever Tires Are Changed", has held true. Ken-Tool's brand name and reputation remain the best in the tire-service industry, and it is the passion of the company's leaders to make sure that continues to be true in the years ahead.

Housed in a 70,000 square foot facility, Ken-Tool is a primary manufacturer of hand-tool products, with its manufacturing expertise centered on drop hammer, up-setter and press forgings. The company goes to market through the traditional aftermarket distribution network.

It is Ken-Tool's policy to deliver defect-free products to our customers on time, every time. Ken-Tool is committed to meeting these objectives, and satisfying applicable requirements, by continually improving our business operating system and processes. We expect to be identified by our customers as #1 in terms of quality and delivery performance.



Ken-Tool is proud to announce that they were re-certified on December 15, 2016 with the current ISO 9001:2015 standards for quality management systems. ISO is the world's most widely used quality assurance procedural guidelines, and lays the groundwork for an organization's development of a uniform set of procedures to establish, monitor and ultimately control product or service quality.



Throughout this catalog watch for YouTube symbols that indicate one or more videos are available for the product you are reviewing. Then go to www.youtube.com/kentoolvideomedia to find a selection of videos for our products. You can also scan the barcode with your Smartphone to get a link to our YouTube videos or details on how to Contact us at Ken-Tool.



768 E. North St., Akron, Ohio 44305 • Toll Free: 888-536-8665 • Fax: 800-872-4929 • Phone: 330-535-7177 • Fax: 330-535-1345

Visit our web site at: www.kentool.com



WARNING: Always wear safety goggles when using hand tools

New Products

Rust Hog™ Hub Cleaning Tool.....	3
Shark Fin™ Dual Wheel Separation Bag.....	5
Dual Wheel Separator.....	6
Tire Valve Installer.....	7
Air Brake Slack Adjusters.....	8
Axle Nut Sockets.....	9
MorTorq® Pro Socket Set.....	10
Deluxe Blue Cobra® Truck Tire Service Set.....	11, 15
TPMS Stem Repair Kit.....	12
8-IN-1 Wrench.....	13
ValveCapper® Pro.....	14

Bendix® Air Disc Brake Tools.....4

Tappet & Boot Replacement Tool Kit.....	4
Guide Pin / Pin Boot Service Tool Kit.....	4

Ken-Tool®

Aligning Bars.....	47
Aluminum Wheel Protector.....	11, 15, 16, 17, 18, 21
Axle Drain Pan.....	26
Ball Joint Separator.....	46
Bead Breakers	
ATV.....	25
Driving Iron.....	22
Floor Type.....	22
Impact.....	22
Portable.....	22
Truck/Farm/OTR.....	22
Wedges.....	11, 15, 23
Bead Expanders, Pneumatic.....	27
Bead Holders	
Aluminum Bead Holders.....	11, 15, 21
Bead Holder for 19.5" Aluminum Wheels.....	15, 21
Brass Bead Holding Device.....	15, 17, 18, 21
Bead Seaters.....	25, 27
C-Clamps.....	39
Chrome Lug Nut Cover Remover.....	28
Easy-Lift™ Bead Seating Stand.....	37
Front End Tools	
Ball Joint Separator.....	46
Heavy Duty Tie Rod End Tool.....	46
Impact Separator Tool.....	46
McPherson Strut Spring Compressor.....	46
Pitman Arm Wedge.....	46
Shock Link/Tie Rod Separator.....	46
Universal Tie Rod Adjusting Tool.....	46
Hammers	
Cross-Pein/Blacksmith.....	47
Dead Blow.....	47
Epoxy Kits.....	24
General Purpose.....	24
Heavy-Duty.....	11, 15, 24
New England Hand Drilling.....	47
Replacement Rubber Heads.....	24
Rubber Mallet.....	47
Sledge.....	47
Handles	
Aluminum, Fiberglass, Wood.....	24
Impact Separator Tool.....	46
Industrial Lock-Ring Tools.....	20
IronMan™ Ergonomic Wheel Lifting Bar.....	21
Leak Locator.....	26
Leverage Bar.....	22, 31
Lock Ring Tools.....	20
Lubricant	
Swab / Brush.....	11, 15, 26
Tire & Bead Lubricants.....	11, 15, 26
Manual Tire Changers for Small Tires.....	25
OSHA Tire Service Charts.....	26
Pro Super Hub-Shark® (7326).....	38
Rim Guard.....	31
17.5" Sidewinder™ Kit.....	16
Sockets	
Axle Nut Sockets.....	9
Budd Nut removers.....	45
Dual Wheel Stud Remover.....	45
Flip Sockets.....	43, 44, 45
Heavy-Duty Impact sockets.....	45
Heavy-Duty Wheel Stud Removers.....	45

Impact Extensions.....	44
MorTorq® Pro Socket Set.....	10
Socket Sets.....	40, 41, 42, 43, 44, 45
Twist Sockets.....	42, 43
Wheel Lock Remover.....	45
Specialty Sockets, Torque Sticks & Extensions.....	40, 41, 42, 43, 44, 45
Spring Compressor, McPherson Strut.....	46
Strap Winder.....	28
Super Single Axle Drain Pan.....	26
Tire & Wheel Service Center.....	33, 34
Tire Tool & Lug Wrench Merchandisers.....	33, 34
Tire Changing Stand.....	37
Tire Inflation Cages.....	35, 36
EZ Tire Rotator™.....	37
Magnum EZ Tire Rotator™ with Ramp.....	37
Tire Irons (Mount/Demount)	
Blue Cobra® Truck Tire Demount Tool & Sets.....	11, 15
European Style.....	19
Heavy-Duty Truck.....	16
Motorcycle/Small Wheel.....	19
Nineteen-Five™ Tire Mount/Demount Set.....	15
Serpent™ Mount & Demount Tools.....	17
Super Serpent™ Mount & Demount Tools.....	18
Tire Snakes®.....	25
Tubeless.....	11, 15, 16
Tire Knockers.....	47
Tire Mount/Demount Lubricant.....	11, 15, 26
Tire Spoons	
Curved.....	19
Curved w/Flat Tip.....	19
Drop-Center.....	19
Straight.....	19
Tire Spreaders.....	27
Torque Master® Torque Sticks & Extensions.....	40, 41
TPMS Sets	
reCore® TPMS Stem Repair Kit.....	12
reCore® TPMS Sensor Saver System.....	32
TPMS Sensor Hardware Service Set.....	32
Truck Wrench Handle	
Leverage Bar.....	31
Valve Breaker™.....	23
ValveCapper® Pro Cap & Core tool.....	14
Valve Repair Tools.....	27
Vises	
Pro Reversible Mechanic's Vises.....	39
Pro Mechanic's Vises.....	39
Wedges	
Bead Breaking.....	11, 15, 23
Wheel Cover Puller/Replacer.....	28
Wheel Lock Remover.....	45
Wheel Lock Remover Kit.....	42
Wheel Weight Hammers.....	27
Wheel Weight Tools.....	27
Wire Brush.....	27
Wrenches	
4-Way Lug Wrenches	
Folding.....	30
Heavy-Duty Truck.....	29
Light Truck/SUV.....	29, 30
OTR.....	29
Passenger Car.....	29, 30
Telescoping.....	30
8-IN-1 Wrenches.....	13
Cap Nut	
Combination.....	28
Heavy-Duty.....	28
Ken-Tool Porkchop™.....	28
Double-End Truck.....	31
Power Wrench.....	30
Extra Leverage 1-1/2" Lug Nut Wrench.....	31
Wrench Support Stand.....	31

Pro Super Hub-Shark® (7326)..... 38

NEW Look for this symbol beside individual product listings for exciting new tools from Ken Tool.

Top Seller Look for this symbol beside individual product listings to indicate top selling products.

All weights and measures are nominal. Variations in manufacture may occur.

NEW

Ken-Tool®

WHEREVER TIRES ARE CHANGED™



**WATCH THE
RUST HOG™
VIDEO**



HUB CLEANING TOOL

***Blasts away rust
and debris in seconds!***

***Eliminates risk of improper torque,
balancing issues, and wheel offs.***

- ***No more switching tools – compatible with all 1/2" drive impact guns – air and electric!***
- ***Super abrasive synthetic pads are tough, effective, and long lasting***
- ***5 piece replacement pack keeps you “rust hogging” all season!***

Item No.	Description	Weight
30167	4 Pc. Rust Hog™ Set Includes: Aluminum driver tool & 3 abrasive pads	.4 lbs (.18 kg)
30168	5 Pc. Rust Hog™ Replacement Pad Set Includes: 5 replacement pads	.2 lbs (.09 kg)

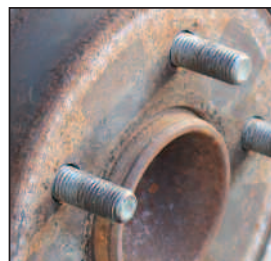

KEN-TOOL • 768 E. North Street, Akron, OH 44305

Toll Free: 888-536-8665 • Fax: 800-872-4929 • Phone: 330-535-7177 • Fax: 330-535-1345

E-mail: sales@kentool.com • www.kentool.com

KT101916

Bendix® ADB22X™ Air Disc Brake Tool Kits

These kits provide specialized tools for the replacement of Bendix® air disc brake tappet and boot assemblies, tappet inner seals, and guide pins and boots.

No. 80000 ADB22X Complete Kit (Bendix #K029164)
Juego completo No. 80000 ADB22X (Bendix No. K029164)
Kit complet ADB22X No. 80000 (Bendix #K029164)

Kit No. 80000 Weight: 22 Lbs (10 kg).
 Includes Kit No. 80001 and Kit No. 80002 listed below:

Top Seller

ALSO WORKS ON
BENDIX ADB22XL
AIR DISC BRAKES

Tappet & Boot Replacement Tool Kit (Bendix #K028829)
Juego de herramientas de reemplazo de balancines y capuchones (Bendix No. K028829)
Kit d'outillage de remplacement de poussoir et de démarrage (Bendix #K028829)

Kit No. 80001 Weight: 7 Lbs (3.2 kg).

7 Pc. Set Includes:

Bendix No.	Ken-Tool No.	Description
T01	80101	KT01 Cup
T02	80102	KT02 Handle for KT01 Cup
T03	80103	KT03 Swivel assy. made up of KT03-1 Short Body, KT03-2 Brass Disc, and KT03-3 Retaining Spring
T04	80104	KT04 Long Strut
T09	80109	KT09 Flange
T15	80115	KT15 Fork
T24	80124	KT24 Black Nylon Disc



See page 25 of Bendix Service Manual listed below*

Guide Pin / Pin Boot Service Tool Kit (Bendix #K029107)
Juego de herramientas para servicio del pasador guía/capuchón del pasador (Bendix No. K029107)
Kit d'outillage d'entretien de broche de démarrage / broche de guidage (Bendix #K029107)

Kit No. 80002 Weight: 15 Lbs (6.8 kg).

13 Pc. Set Includes:

Bendix No.	Ken-Tool No.	Description
T05	80105	KT05 1-3/8" Black Disc
T06	80106	KT06 1-1/2" Black Disc
T07	80107	KT07 2" Dia. Sleeve
T08	80108	KT08 2-1/8" Dia. Disc
T10	80110	KT10 8" Bolt
T12	80112	KT12 3-7/8" Long Sleeve
T13	80113	KT13 10" Bolt
T14	80114	KT14 Brass Nut
T16	80116	KT16 Dimpling Tool made up of KT16-1 Main Body, KT16-2 Crimper Screw, KT16-3 Expansion Ring, KT16-4 Plunger, KT16-5 Dimpling Pins, and KT16-6 Set Screw
T20	80120	KT20 8" Bolt
T21	80121	KT21 Half Sleeve
T26	80126	KT26 Cap Tool made up of KT26-1 Retaining Ring, KT26-2 Mandrel and KT26-3 Sleeve
T27	80127	KT27 Cap Tool made up of KT26-1 Retaining Ring, KT26-2 Mandrel and KT27-3 Sleeve



See page 30 of Bendix Service Manual listed below*

*For detailed instructions see the Bendix ADB22X service manual SD-23-7541 on the "Manuals and Parts Lists" link at www.kentool.com

NEW

Ken-Tool®

WHEREVER TIRES ARE CHANGED™



SHARK FIN™

Dual Wheel Separation Bag

The first wheel separation solution for steel, aluminum and chrome wheels!

No metal on metal contact!

- 5000 lbs of static pressing force!
- Works on 15" to 24.5" dual and single wheels and tires on trucks & trailers
- Kevlar inner inflation bag is industrial grade and nearly puncture proof
- Small but mighty – Portable, durable, and fast – Full inflation only takes a matter of seconds
- 3 foot inflation hose makes access easy and safe
- Deflation is controlled with a quick turn of the slotted valve cap
- 9.75" x 8" x 3/8" height deflated – 5.5" height when fully inflated
- 90 psi max pushing pressure – 150 psi maximum rated pressure

34555

Simply turn valve cap to deflate

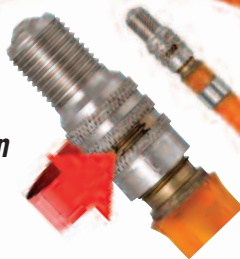

2.5 tons of force!



Shark Fin™ inflates to separate stuck or frozen dual wheels without damaging the wheel!

WATCH THE SHARK FIN™ VIDEO ON www.kentool.com



Item No.	Description	Weight
NEW 34555	Shark Fin™ Dual Wheel Separation Bag	1.31 lbs (.59 kg)

KEN-TOOL • 768 E. North Street, Akron, OH 44305

Toll Free: 888-536-8665 • Fax: 800-872-4929 • Phone: 330-535-7177 • Fax: 330-535-1345

E-mail: sales@kentool.com • www.kentool.com

KT092815

NEW

Ken-Tool®

WHEREVER TIRES ARE CHANGED™

DUAL WHEEL SEPARATOR

Quickly & easily remove stuck or frozen dual steel wheels!!



34549



Makes removing stuck or frozen dual steel wheels quick and easy. Ideal for use on nearly any truck, bus, van or trailer that has dual steel wheels.

- Innovative "One-piece" Pusher won't fall apart during use
- Pusher is ball bearing-driven for near-zero turning resistance
- Pusher is heat treated for long-lasting strength and durability
- Forcing Screw and Pullers have powerful 1-1/8" diameter x 11 threads for years of reliable service
- Includes two pullers to cover large truck, trailer and smaller light truck dual wheel applications
- Components have black oxide or bright nickel plating finish for rust and corrosion resistance
- Use with air or electric impact wrench
- Components are laser-etched for easy identification
- Comes in a sturdy, compact, easy to store case; 6.5" x 9.5" x 2.5", 5.3 lbs
- Proudly Made in USA
- Limited Lifetime Warranty



Dual Wheel Separator Demo Video #34549

Item No.	Description	Weight
34549	4 Pc. Dual Wheel Separator kit	5.3 lbs (2.4 kg)

Component parts available.

Top Seller

KEN-TOOL • 768 E. North Street, Akron, OH 44305
Toll Free: 888-536-8665 • Fax: 800-872-4929 • Phone: 330-535-7177 • Fax: 330-535-1345
E-mail: sales@kentool.com • www.kentool.com

Ken-Tool® 6
WHEREVER TIRES ARE CHANGED™

KT100212EB

NEW

Ken-Tool®

WHEREVER TIRES ARE CHANGED™

TIRE VALVE INSTALLER

Pulls tire valve into rim hole – Grips any standard tire valve!



YouTube



- **Robust and durable for fleet use**
- **Screws on to cap of threads on tire valve and handle is used as a lever to pull tire valve into rim hole**
- **Threaded installer securely grips any standard tire valve**
- **Steel construction provides leverage without bending**
- **Polymer rim guard doesn't mar or damage chrome or alloy wheels**
- **Slip resistant ergonomic handle feels great in hand**

- **Swivel head allows for ease of use at any angle**

Item No.	Description	Length	Weight
29850	Tire Valve Installer	12" (30.5 cm)	.6 lbs (.27 kg)

KEN-TOOL • 768 E. North Street, Akron, OH 44305

Toll Free: 888-536-8665 • Fax: 800-872-4929 • Phone: 330-535-7177 • Fax: 330-535-1345

E-mail: sales@kentool.com • www.kentool.com

KT110115

NEW

Ken-Tool®

WHEREVER TIRES ARE CHANGED™

AIR BRAKE SLACK ADJUSTERS



Slack Adjusters for Haldex®, Bendix®, and Meritor® Air Brake Systems

*Avoid costly fines and downtime –
make sure your brakes are always operating at their best!*

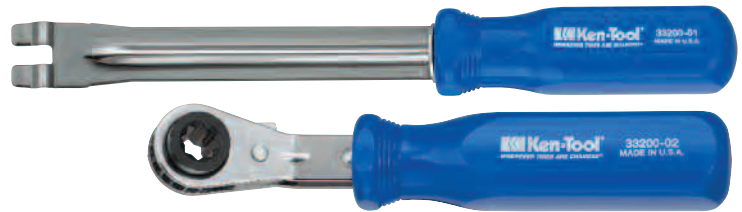

33200 Automatic Slack Adjuster Set (Meritor®)

- 5/16" ratchet size with double square offset reversible wrench
- Fork End Tool holds release of anti-reverse pin during adjustment
- No more prying and risking damaging the anti-reverse mechanism
- Ratchet allows more power with less fatigue
- Ergonomic slip resistant molded resin handles



33205 Haldex® Slack Adjuster Tool

- 7/16" ratchet size
- Extra long 14.5" handle adds leverage and makes overcoming the anti-reverse mechanism easier than ever
- Vinyl grip is slip resistant and protects ratchet head



33206 Bendix® Slack Adjuster Tool

- 9/16" ratchet size
- Deeper Hex allows reach to recessed slack adjusters
- A must have tool for owner / operators

Item No.	Description	Length	Weight
33200	2 Pc. Automatic Slack Adjuster Tool Set (Meritor®) Set Includes: 33200-01 Fork End Tool 33200-02 5/16" Dble. Sq. Offset Reversible Wrench	12" (30.5 cm)	.7 lbs (.3 kg)
33205	7/16" Haldex® Slack Adjuster Tool	14.5" (36.8 cm)	.65 lbs (.29 kg)
33206	9/16" Bendix® Slack Adjuster Tool	14.5" (36.8 cm)	1 lb (.5 kg)
33210	4 Pc. Automatic Slack Adjuster Tool Set Set Includes: 33200 2 Pc. Automatic Slack Adjuster Set (Meritor®), 33205 Haldex® Slack Adjuster Tool, 33206 Bendix® Slack Adjuster Tool		2.5 lbs (1.1 kg)



NEW

Ken-Tool®

WHEREVER TIRES ARE CHANGED™

AXLE NUT SOCKETS

The 5 most common axle nut sizes for Ford, Dodge, Toyota and GM vehicles!



30410
3.25" 8 Point



30411
3.5" 6 Point



30412
3.75" 8 Point



30413
4" 6 Point

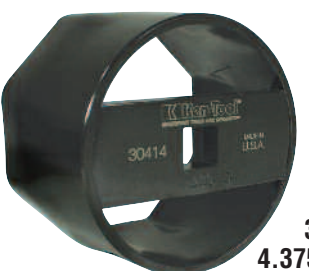
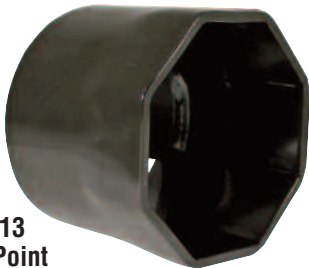

30414
4.375" 8 Point



*Available as individual sizes
and as a full set!*

- Each socket is made from cold pressed tool steel and made proudly in the USA
- 6 point and 8 point designs have tight tolerances that grip axle nuts firmly to resist rounding out
- 3/4" drive designed to be used with torque wrench and hand tools
- Stamped sizes are easy to read
- Black e-coat surface protects against corrosion and wear

Item No.	Description	Weight
30410	3.25" 8 pt. Axle Nut Socket	2.7 lbs (1.2 kg)
30411	3.5" 6 pt. Axle Nut Socket	2.95 lbs (1.3 kg)
30412	3.75" 8 pt. Axle Nut Socket	3.15 lbs (1.4 kg)
30413	4" 6 pt. Axle Nut Socket	3.35 lbs (1.5 kg)
30414	4.375" 8 pt. Axle Nut Socket	3.5 lbs (1.5 kg)
30415	5 Piece Axle Nut Socket Set* Set includes: 30410, 30411, 30412 30413, 30414, 30415	16 lbs (7.2 kg)

*Set ships in poly bags individually in a standard carton



KEN-TOOL • 768 E. North Street, Akron, OH 44305

Toll Free: 888-536-8665 • Fax: 800-872-4929 • Phone: 330-535-7177 • Fax: 330-535-1345

E-mail: sales@kentool.com • www.kentool.com

KT103015

NEW

Ken-Tool®

WHEREVER TIRES ARE CHANGED™

MorTorq® PRO 5 PIECE SOCKET SET

For use on O.E. fasteners on
Domestic, Import, and European vehicles

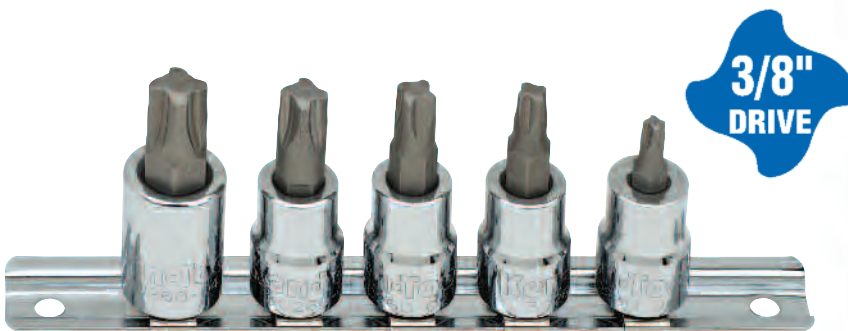

MorTorq® PRO 5 piece set includes:
3/8" Drive: M0, M1, M2, M3, M4
PLUS steel storage rail!

- Use the MorTorq® sockets to install and remove unique fasteners that are quickly becoming popular on all make and model vehicles including GM, Chrysler, BMW, Fiat, and other import vehicles
- Applications: Interior trim, seat mount bolts, brake rotors & calipers, bell housings, and body panels
- Hardened shock resistant tool bits with chrome plated alloy steel sockets designed for maximum durability and longevity
- Innovative 4-point design for high demand torquing requirements and increased contact area — decreases potential slippage and rounding out

Item No.	Description	Weight
30260	MorTorq® PRO 5 Pc. Socket Set	.55 lbs (.25 kg)



MorTorq® is a registered trademark of the Phillips Screw Co.



NEW

Ken-Tool®

WHEREVER TIRES ARE CHANGED™

DELUXE BLUE COBRA® TRUCK TIRE SERVICE SET

All the tools you need for changing most 22.5" & 24.5" tubeless truck tires in one convenient set!

WATCH OUR VIDEO ON
www.kentool.com
TO SEE 4 TRUCK TIRES
DEMOUNTED IN ABOUT A MINUTE!



Set No. 35444 Weight: 57 Lbs (26 kg).

10 Pc. Set Includes:

Item No.	Description	Length	Quantity
35440	Blue Cobra® Truck Tire Demount Tool; Demounts up to 425 Wide Tire	54" (137 cm)	1
34645	T45A Tubeless Tire Iron - Our Best Selling Bar!	37" (94 cm)	1
33052	Double-End Tire Spoon	30" (76 cm)	1
35330	T11ES Bead Breaking Wedge w/Safety Handle, Use with T35 Hammer	30" (76 cm)	1
35323	T35 H.D. Tire Hammer, With Replaceable Rubber Head	16.5" (42 cm)	1
35848	8 lb. Bucket Euro Paste Lube; Dries Tacky With Rust Preventative		1
30512	Euro-Style Lube Applicator Brush	11" (28 cm)	1
31713	Aluminum C-Lok™ Bead Holder	5.5" (14 cm)	2
31810	Leather Rim Protector - PATENTED!	6" (15 cm)	1

35444 set ships in 1 Box, weighing 57 lbs, UPS shippable

KEN-TOOL • 768 E. North Street, Akron, OH 44305

Toll Free: 888-536-8665 • Fax: 800-872-4929 • Phone: 330-535-7177 • Fax: 330-535-1345

E-mail: sales@kentool.com • www.kentool.com

KT073014EB

NEW

Ken-Tool®

WHEREVER TIRES ARE CHANGED™

TPMS STEM REPAIR KIT



Repairs damaged valve stems like these:



Easily repair damaged aluminum TPMS valve stems!
Patented repair solution now available to the consumer!

reCore®

TPMS Sensor Saver System

Available to the professional, now made for DIY!

- Each kit includes: 2 replacement stems, custom high-speed drill bit, tap and tap holder, thread locker, and a valve core torque tool
- Patented – this proven repair solution has been in the market since 2012 with millions of miles on repaired stems
- Stems are damaged by corrosion from weather, steel valve caps, and improper valve cores
- Consumers can “save” their TPMS sensors with this simple and economical repair kit – Without having to remove the wheel or demount the tire
- Repair 2 sensors for less than the cost of one replacement TPMS unit
- Easy to use and very fast – Repairs can be completed in 20 minutes
- The only additional tools needed are a high speed drill, needle nose pliers, and eye protection



Item No.	Description	Weight
NEW 29975	7 Pc. reCore® TPMS Stem Repair Kit	.55 lbs(.25kg)



TPMS Stem Repair Kit #29975



NEW

Ken-Tool®

WHEREVER TIRES ARE CHANGED™

8-IN-1 WRENCH

SAE OR METRIC

Eight of the most popular wrench sizes in one strong, professional, compact and convenient tool!



- *Designed by a professional auto technician for versatility, convenience and strength!*
- *Wrench engagement requires minimal clearance around the fastener!*
- *“Stud-Thru” design allows long threaded studs and fasteners to pass through the wrench opening!*
- *“12 Point” design requires only 30 degree swing arc re-engagement for close proximity work!*
- *Backed with Limited Lifetime Warranty*
- *7-1/2" slim profile that is easy to carry and store*

- *SAE sizes: 5/16", 3/8", 7/16", 1/2", 9/16", 5/8", 11/16", 3/4"*
- *Metric sizes: 10mm, 11mm, 12mm, 13mm, 14mm, 15mm, 16mm, 17mm*

Exceptional “Must Have” convenience tool for multiple markets:

- *Automotive, maintenance, farm equipment, DIY, home projects, sporting/recreational, all engine repair, electrical, plumbing, HVAC, bikes, motorcycles, furniture assembly*
- *Sold in a convenient 6 piece merchandising display, 5" W x 6" D x 8" H*
- *Meets 150% ANSI specifications*



35775 SAE



35776 METRIC

PATENTED



Item No.	Description	Weight
NEW 35775	SAE 8-IN-1 Wrench*	.55 lbs (.25 kg)
NEW 35776	METRIC 8-IN-1 Wrench*	.55 lbs (.25 kg)

**Standard Pack of 6 - Shipped in Countertop Display*

KEN-TOOL • 768 E. North Street, Akron, OH 44305

Toll Free: 888-536-8665 • Fax: 800-872-4929 • Phone: 330-535-7177 • Fax: 330-535-1345

E-mail: sales@kentool.com • www.kentool.com

KT060915RT

NEW

Ken-Tool®

WHEREVER TIRES ARE CHANGED™

VALVECAPPER® PRO

4 TOOLS IN 1

Cap and Core Remover/Installer



Makes it easier to check the inside dual tire!

- *Designed by a trucker to make a difficult job easier*
- *No more moving your rig to position valve stems just to get to the caps*
- *No more dropped caps — holds onto caps and valve cores for removing and replacing*
- *Longer valve cap grip works on flow-through, double seal valve caps*
- *At 11-3/4 inches it has enough reach to get the job done*
- *Unbreakable under normal use*
- *Designed for use on metal and plastic valve caps*



BETTER THAN EVER!

- *Patent pending design now holds on to core for easy removal and installation*
- *Shipped in convenient 25-piece counter display*



29999

Item No.	Description	Weight
29999	ValveCapper® Pro Cap & Core Tool	1.5 oz (.04kg)
29999M	25 Pc. ValveCapper® Counter Display Contains: 25 No. 29999 ValveCappers 1 Counter Display Unit	3 lbs (1.4 kg)

Top Seller

KEN-TOOL • 768 E. North Street, Akron, OH 44305

Toll Free: 888-536-8665 • Fax: 800-872-4929 • Phone: 330-535-7177 • Fax: 330-535-1345

E-mail: sales@kentool.com • www.kentool.com

KT102014

Ken-Tool® 14
WHEREVER TIRES ARE CHANGED™

BLUE COBRA® Truck Tire Demount Tool

Herramienta de desmontaje de neumáticos de camiones BLUE COBRA®

Outil de démontage de pneus de camion BLUE COBRA®

Quickly demount nearly any 22.5" and 24.5" tubeless truck tire, up to a 13" wide wheel. Ergonomic shaped steel handle with no-slip grip for optimum leverage while reducing back injuries. Solid steel Cobra head is press-fit into the steel handle — no fasteners to loosen or fall out. Allows demounting of the tire without lifting the entire wheel and tire off the ground — reduces back injuries. Aluminum bead support to grab the top bead of Super Single and Super Wide tires. 2 heavy-duty nylon rollers are easily replaced when worn, kit No. 35441 includes two rollers and two roll pins. **Imported.**

Item No.	Length	Weight
35440	54" (137 cm)	22 lbs (10 kg)

WATCH OUR VIDEO ON
www.kentool.com
TO SEE 4 TRUCK TIRES
DEMOUNTED IN ABOUT
A MINUTE!*



Special Bonus!
Ken-Tool's patented leather wheel protector No. 31810 included to help protect expensive alloy wheels!

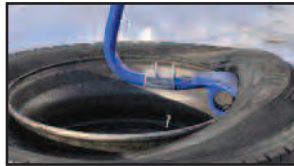

BLUE COBRA® Truck Tire Service Sets

Juego de servicio de neumáticos de camiones BLUE COBRA®

Ensemble d'entretien de pneus de camion BLUE COBRA®

● **Set No. 35442** Weight: 40 Lbs (18.2 kg).

● **Deluxe Set No. 35444** Weight: 57 Lbs (26 kg).



Deluxe Set
No. 35444

Set No.	Deluxe Set No.	Item No.	Description	Qty.
35442	35444	35440	Blue Cobra® Truck Tire Demount Tool	1
		34645	T45A Tubeless Tire Iron - <i>Our Best Selling Bar!</i>	1
		34645C	T45AC Classic Tubeless Tire Iron	1
		33052	Double-End Tire Spoon	1
		35330	T11ES Bead Breaking Wedge w/Safety Handle	1
		35323	T35 H.D. Tire Hammer	1
		35848	8 lb. Bucket Euro Paste Lube	1
		30512	Euro-Style Lube Applicator Brush	1
		31713	Aluminum C-Lok™ Bead Holder	2
		31810	Leather Rim Protector	1

The Blue Cobra® Truck Tire Service Sets contains all the tools you need to change most 22.5" & 24.5" tubeless truck tires quickly and easily.



*Blue Cobra®
Demounts 4
Truck Tires In
About A Minute



Blue Cobra®
Is So Easy To
Use Even a Girl
Can Do It

Nineteen-Five™ Tire Mounting & Demount Tool Set for 19.5" Tires

Juego de herramientas de montaje y desmontaje de neumáticos de 19.5" Nineteen-Five™

Jeu d'outils de montage - démontage de pneus de 19,5 po Nineteen-Five™

No. 33199 Mounting/Demounting Tool



No. 31710 Bead Holder for Steel Wheels



No. 31810 Aluminum Wheel Protector

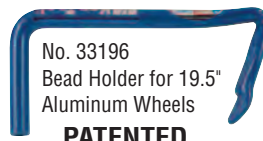
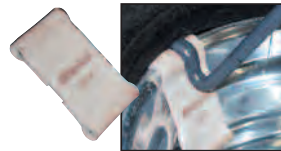

No. 33196
Bead Holder for 19.5"
Aluminum Wheels
PATENTED



Tire Bars For
19.5 Tires & Wheels



Nineteen-Five™ Tool Set:
How To Use It On A
19.5 Wheel

19.5" tires must be mounted and demounted with the wheel's Hub Side Up because the Drop Center of the wheel is closer to the hub! This makes changing the 19.5" tires notoriously difficult because the hub gets in the way of conventional bars and spoons. 19.5" tires are also stiffer with high ply ratings and thick beads. Nineteen-Five™ bars are specially designed to work on the hub side to make your job easier, faster and safer! New tire bar uniquely designed to work on hubside of wheel — where hub protrudes above rim. Specially designed ends manipulate tire with less effort. Tools are powder coated to protect from rust and corrosion. Forged from 3/4" diameter high-grade carbon steel and heat-treated for long-lasting strength and durability. **Patented** Bead Holder to hold bead on 19.5" aluminum wheels.

Set No. 33195 Weight: 9.35 Lbs (4.25 kg).

5 Pc. Set Includes:

Item No.	Description	Length	Weight	Quantity
33199	Tire Mounting/Demounting Tool	38" (97 cm)	7 lbs (3.2 kg)	2
33196	Bead Holder for 19.5" Aluminum Wheels	7-1/2" (19 cm)	1 lb (.5 kg)	1
31710	Bead Holder for Steel Wheels - Solid Brass	4-1/2" (11.5 cm)	1 lb (.5 kg)	1
31810	Aluminum Wheel Protector - Leather	6" (15 cm)	.35 lbs (.15 kg)	1



Bent end
For mounting
and demounting
bottom bead



Curved end
For mounting
and demounting
top bead

Tubeless Truck Tire Mount / Demount Irons

Barras para montaje/desmontaje de llantas de camiones sin cámara

Démonte-pneu de montage/démontage pour pneus de camion sans chambre à air



Ken-Tool manufactures the largest and most diverse selection of tire mount/demount irons in the world. From the T45A® and T45AC Classic for standard truck tires, to the Serpent™ and Super Serpent™ Tire Changing Systems for wide-base Super Singles, Ken-Tool makes a tire iron for all your tire changing needs. Use on truck, agricultural, and industrial tires. One-piece manufacturing process and design assures long life and superior performance. Heat-treated for strength. Use in pairs. T45A® is a registered trademark of Ken-Tool.

Ken-Tool® brings back an old favorite – T45AC Classic™

Ken-Tool's patented designs offer one-piece construction, and assure long life for many tire-changing applications. Tip ends insert easily and will not cut or rip bead or sidewall. These designs make it easier to mount and demount tires without changing the way the tool is used.

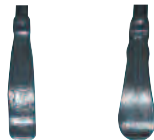

T45AC Classic™ T45A®



Mount end: Precision forged knob grips rim. New design won't slip during tire mounting. Special curve design always grabs the bead edge.

Demount end: Precision-forged angled tip slides between bead and rim easily. Forged design won't slip when demounting the second bead.

Model	Item No.	Length	Stock	Weight
○ T45A®	34645	37" (94 cm)	3/4" (19 mm)	4.6 lbs (2.1 kg)
○ T45AC™	34645C	37" (94 cm)	3/4" (19 mm)	4.6 lbs (2.1 kg)
NEW T45AS	34649	52" (132 cm)	7/8" (22mm)	9 lbs (4.1 kg)
○ T45HD	34647	41" (104 cm)	7/8" (22 mm)	7 lbs (3.2 kg)
○ T47A	34847	52" (132 cm)	1" (25 mm)	11 lbs (5 kg)

T45A-2000K™ Style Tubeless Tire Iron

Barra de hierro para montaje/desmontaje de neumáticos sin cámara estilo T45A-2000K™

Démonte-pneu pour pneus sans chambre à air T45A-2000K™

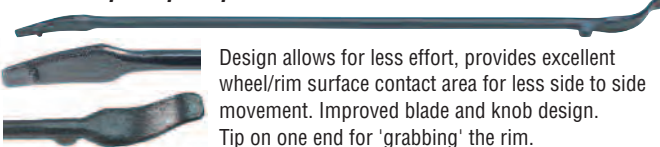

Design allows for less effort, provides excellent wheel/rim surface contact area for less side to side movement. Improved blade and knob design. Tip on one end for 'grabbing' the rim.

Model	Item No.	Length	Stock	Weight
○ T45A-2000K™	34644	37" (94 cm)	3/4" (19 mm)	5 lbs (2.2 kg)

Mount

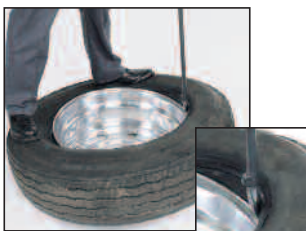

Demount



○ Top Seller

Tubeless Tire Irons & Sets

Juegos y barras para llantas sin cámara

Démonte-pneus individuels & en ensemble pour pneus sans chambre à air

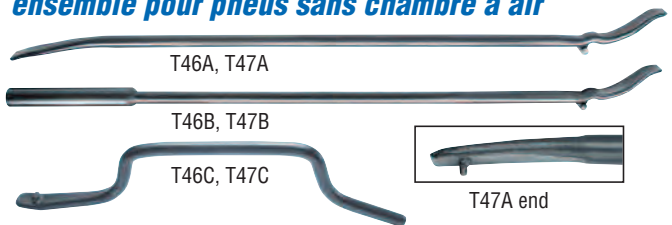

Sets provide all irons necessary for a variety of tire changing applications. Use "C" bar with the "B" extension bar for easier use on large, wide-base truck tires. Use on standard and large truck tires, including industrial, farm, buses, and tractors.

Standard • Estándar • Standard

Model	Item No.	Description	Length	Stock	Weight
T46	34746	Tire Iron Set includes: T46A, T46B, T46C		3/4" 19 mm	12 lbs 5.4 kg
○ T46A	34747	Straight Mount/Demount Tool	36" 91 cm	3/4" 19 mm	4.5 lbs 2 kg
T46B	34748	Straight Mount/Demount Tool "B" Extension for T46C	36" 91 cm	3/4" 19 mm	4.5 lbs 2 kg
T46C	34749	Offset Mount "C" Bar	22" 56 cm	3/4" 19 mm	3 lbs 1.4 kg

Heavy-Duty • De alta resistencia • Robuste

Model	Item No.	Description	Length	Stock	Weight
T47	34846	Tire Iron Set includes: T47A, T47B, T47C		1" 25 mm	29 lbs 13.1 kg
T47A	34847	Straight Mount/Demount Tool	52" 132 cm	1" 25 mm	11 lbs 5 kg
T47B	34848	Straight Mount/Demount Tool "B" Extension for T47C	49-1/2" 126 cm	1" 25 mm	11 lbs 5 kg
T47C	34849	Offset Mount "C" Bar	27" 69 cm	1" 25 mm	6.6 lbs 3 kg

17.5 Sidewinder™ Kit

Kit Sidewinder™ de 17.5

Kit Sidewinder™ 17,5 po



The first tire tools designed exclusively for 17.5" tires found on vehicle transporter moving vans and high volume trailers!

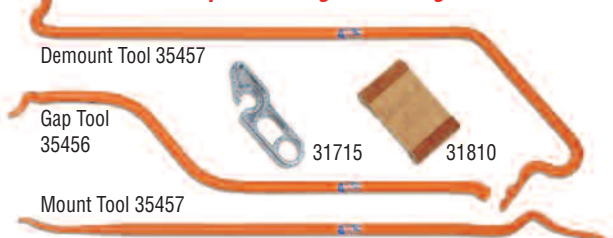

- Patent-Pending revolutionary SIDEWINDER™ demount bar demounts the tire from the wheel by pushing against the tire sidewall for leverage
- Unique Gap tool aids in demounting – makes mounting/demounting a 1-man job
- Innovative balanced aluminum bead holder specifically designed to stay in place when mounting the problematic bottom bead on 17.5's

Set No. 35459 Weight: 18.6 Lbs (8.43 kg).

5 Pc. Set Includes:

Item No.	Description	Length	Quantity
31715	17.5" Bead Holder	9" (23 cm)	1
31810	Leather Rim Protector	6" (15 cm)	1
35455	Demount Tool	38" (96 cm)	1
35456	Gap Tool	32" (81 cm)	1
35457	Mount Tool	38" (96 cm)	1



17.5" Sidewinder™ Demo Video #34549

35459 set ships in 1 Box, weighing 18.6 lbs, UPS shippable

For more information visit us at www.kentool.com

Serpent™ Mount & Demount Tire Irons

Take the struggle out of mounting and demounting truck tires...
Everything you need to change tires easily and effortlessly.



Serpent™
Tubeless Tire Mount/
Demount Tire Irons



Serpent™
Bar To Demount An
11R22.5 Truck Tire
At MATS 2010

Serpent™ Demount Tool Herramienta de desmontaje Outil de démontage

"Makes demounting easier than ever."

Demounts **both** beads on most truck tires without the need for lifting the tire/wheel assembly off the ground, and then dropping it. Made of heat-treated alloy steel for maximum durability and strength.

Model	Item No.	Length	Stock	Weight
T2001	35449	39" (99 cm)	3/4" (19 mm)	6.5 lbs (3 kg)



PATENTED



Serpent™ Mount Tool Herramienta para montar Outil d'assemblage

"Makes mounting easier than ever."

Designed to stop against the rim, and then remove itself effortlessly from between the rim and bead. The small end of the tool easily gets under the stretched bead for that last pull.

Model	Item No.	Length	Stock	Weight
T2002	35450	38" (96 cm)	11/16" (17.5 mm)	4 lbs (1.8 kg)



PATENTED

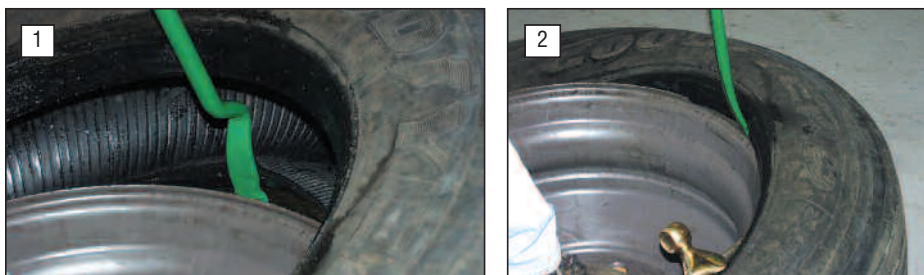

Serpent™ 4 Pc. Tire Changing Set Juego de 4 piezas para cambiar llantas Ensemble 4 pièces de changement de pneu

Set No. 35453

Weight: 12 Lbs (5.4 kg).

4 Pc. Set Includes:

Model	Item No.	Qty.	Description
T2001	35449	1	Serpent Demount Tool
T2002	35450	1	Serpent Mount Tool
	31710	1	Brass Bead Holding device
	31810	1	Aluminum Wheel Protector

WATCH OUR VIDEOS ON
www.kentool.com

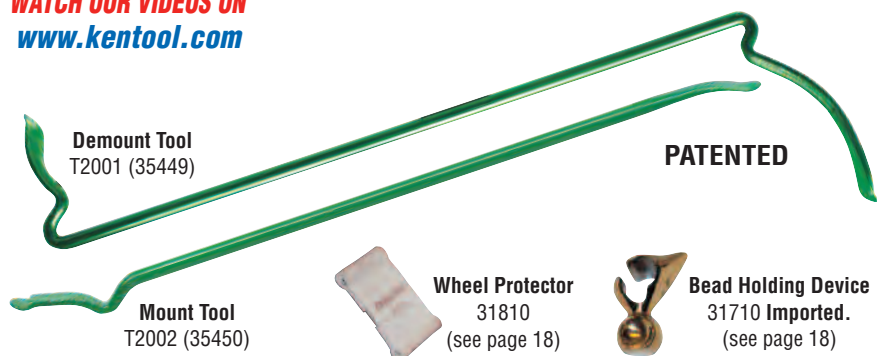

Demount Tool
T2001 (35449)

PATENTED

Mount Tool
T2002 (35450)

Wheel Protector
31810
(see page 18)

Bead Holding Device
31710 Imported.
(see page 18)

SUPER SERPENT™ Mount & Demount Tire Irons

Finally! Tools specially designed to handle big, big tires that actually work!
Now, mounting and demounting the biggest, heaviest truck tire is made easy.



Super Single Truck
Tire Mount/Dismount
Using Super Serpent™
Tire Tools



SuperSerpent™
Tbls Tire Mount/
Demount Tire
Irons

Super Serpent™ Mount Tool Herramienta para montar Outil d'assemblage

This mount tool for super singles only weighs about 6-1/2 pounds. It may seem "funny-looking", but every inch of this innovative design is purely serious. It makes interference of the second bead, while mounting the first, a thing of the past, and delivers **twice** the leverage of **any** "straight-type" tire mounting tool. It even has the small end that easily gets under the bead for that "last pull".



PATENTED



Super Serpent™
Mounting Tool
Used To Mount
21L-24 Backhoe

Model	Item No.	Length	Stock	Weight
T2005	35447	37" (94 cm)	3/4" (19 mm)	6.6 lbs (3 kg)



Super Serpent™ Demount Tool Herramienta de desmontaje Outil de démontage

Weighing in at only 5-1/2 pounds, this unique, lightweight demount tool for super singles can be lugged around on a fingertip, yet delivers the incredible leverage, right where it's needed, to easily pop those heavyweights right off their wheels.



PATENTED



Super Serpent™
Demounting Tool
Used To Demount
21L-24 Backhoe

Model	Item No.	Length	Stock	Weight
T2006	35448	37" (94 cm)	3/4" (19 mm)	5.5 lbs (2.5 kg)

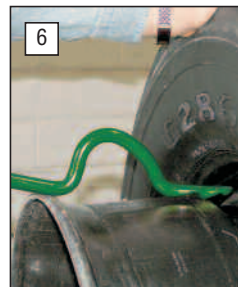
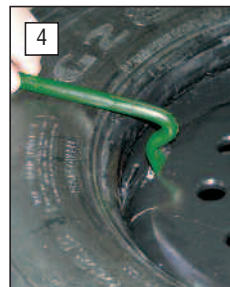
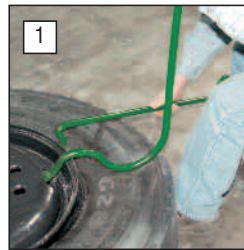

Super Serpent™ 5 Pc. Tire Changing Set Juego de 5 piezas para cambiar llantas Ensemble 5 pièces de changement de pneu

Set No. 35446

Weight: 19 Lbs (8.6 kg).

5 Pc. Set Includes:

Model	Item No.	Qty.	Description
T2005	35447	1	Super Serpent Mount Tool
T2006	35448	1	Super Serpent Demount Tool
	31710	2	Brass Bead Holding device
	31810	1	Leather Wheel Protector

Mount Tool
T2005 (35447)

WATCH OUR VIDEOS ON www.kentool.com



Wheel Protector
31810
(see page 18)



Bead Holding Device
31710 Imported.
(see page 18)

Demount Tool
T2006 (35448)

PATENTED

Tire Mount / Demount Spoons

Espátula para montaje/desmontaje de llantas Cuillères de montage/démontage de pneus

These tools are designed for fast and efficient tire changing. Use the 18" and 24" spoons to mount or demount passenger car, motorcycle, ATV, and light truck tires. The 30" spoons provide enough strength and leverage to work on large truck, bus, off-road vehicle, tractor, and aircraft tires.



Mount

Straight

Recta • Droite



Model	Item No.	Length	Stock	Weight
T1X	32101	18" (46 cm)	11/16" (17.5 mm)	1.8 lbs (.8 kg)
T19	32119	24" (61 cm)	11/16" (17.5 mm)	2.5 lbs (1.1 kg)
T19A	33219	30" (76 cm)	11/16" (17.5 mm)	3 lbs (1.4 kg)
T19M	33022	30" (76 cm)	3/4" (19 mm)	3.4 lbs (1.54 kg)
T38	33238	30" (76 cm)	7/8" (22 mm)	4.8 lbs (2.2 kg)

Drop-Center

Combinación con base con caída • Base creuse



Model	Item No.	Length	Stock	Weight
T21R	32121	18" (46 cm)	11/16" (17.5 mm)	1.8 lbs (.8 kg)
T21F	34121	24" (61 cm)	11/16" (17.5 mm)	2.5 lbs (1.1 kg)
T21A	33020	30" (76 cm)	11/16" (17.5 mm)	3.1 lbs (1.4 kg)
T21M	33024	30" (76 cm)	3/4" (19 mm)	3.4 lbs (1.54 kg)
T21HD	34122	30" (76 cm)	7/8" (22 mm)	4.5 lbs (2.0 kg)

Curved

Curva • Courbe



Model	Item No.	Length	Stock	Weight
T2X	32102	18" (46 cm)	11/16" (17.5 mm)	1.8 lbs (.8 kg)
T20	32120	24" (61 cm)	11/16" (17.5 mm)	2.4 lbs (1.1 kg)
T20A	33220	30" (76 cm)	11/16" (17.5 mm)	3.1 lbs (1.4 kg)
T20M	33023	30" (76 cm)	3/4" (19 mm)	3.4 lbs (1.54 kg)
T39	33239	30" (76 cm)	7/8" (22 mm)	4.5 lbs (2.0 kg)

Curved with Flat

Curva con punta plana • Courbe avec embout plat



Model	Item No.	Length	Stock	Weight
T22R	31820	18" (46 cm)	11/16" (17.5 mm)	1.8 lbs (.8 kg)
T22F	32420	24" (61 cm)	11/16" (17.5 mm)	2.5 lbs (1.1 kg)
T22A	33021	30" (76 cm)	11/16" (17.5 mm)	3.1 lbs (1.4 kg)
T22M	33025	30" (76 cm)	3/4" (19 mm)	3.4 lbs (1.54 kg)
T22HD	33026	30" (76 cm)	7/8" (22 mm)	3.4 lbs (1.54 kg)

Small Tire Mount/Demount Irons

Barras para montaje/desmontaje de llantas pequeñas

Leviers de montage/démontage de petits pneus

New designs are based on popular European styles. Extended length of the flat curved sliding surface provides mounting ability comparable to much longer traditional tire irons. Sizes available for motorcycle, passenger, truck, and heavy-duty tires. Designed for mounting and demounting tires. Best if used in pairs.



Motorcycle / Small Wheel

Ruedas pequeñas/de motocicleta • Motocycllette/Petites roues



Model	Item No.	Length	Stock	Weight
T43A	39805	15" (38 cm)	3/4" (19 mm)	1.8 lbs (.8 kg)

Mount / Demount Tire Tools - Small Tire

Herramientas para montaje y desmontaje de llantas - Llantas pequeñas

Outils de montage/démontage de pneus - Petits pneus



Tools are used in pairs to mount or demount small passenger, industrial, ATV, and motorcycle tires.

Model	Item No.	Length	Stock	Weight
T6A	32106	16-1/2" (42 cm)	5/8" (16 mm)	1.5 lbs (.7 kg)

Tire Irons - Small Tire

Barras para llantas - Llantas pequeñas

Démonte-pneus - Petits pneus



32109
32116

Pro tire changing tools for small tires. Ideal for mounting and demounting motorcycle, ATV, lawn tractor, golf cart, and small tires by hand. Rounded ends will not pinch tube.

Model	Item No.	Length	Stock	Weight
T9A	32109	9" (23 cm)	7/16" (11 mm)	.4 lbs (.16 kg)
T16A	32116	16" (41 cm)	7/16" (11 mm)	.7 lbs (.3 kg)
T9C	32110	2 pc. Carded Set - Contains: Qty. (2) T9A 9" Bars		
T16C	32117	2 pc. Carded Set - Contains: Qty. (2) T16A 16" Bars		

Tire Irons - Small Tire

Barras para llantas - Llantas pequeñas

Démonte-pneus - Petits pneus

Pro tire changing tools for small tires. Sturdy, comfortable plastic handles. Ideal for mounting and demounting motorcycle, ATV, lawn tractor, golf cart, and small tires by hand. Rounded ends will not pinch tube.



32115
32118

Model	Item No.	Length	Stock	Weight
T5	32115	16" (41 cm)	7/16" (11 mm)	.8 lbs (.36 kg)
T8	32118	16" (41 cm)	7/16" (11 mm)	.8 lbs (.36 kg)
32114	2 Pc. Small Tire Iron Set Contains: Qty. (1) T5 (32115) Qty. (1) T8 (32118)			1.6 lbs (.7 kg)

European Style Tools

Herramientas de estilo europeo Outils de style européen



Use on car, motorcycle, truck, and agricultural tires. Designed for mounting and demounting tires. Best if used in pairs.

Model	Item No.	Length	Stock	Weight
T43C	39806	21" (53 cm)	7/8" (22 mm)	3.1 lbs (1.4 kg)

Model	Item No.	Length	Stock	Weight
T43D	39810	30" (76 cm)	7/8" (22 mm)	4.5 lbs (2.0 kg)

Model	Item No.	Length	Stock	Weight
T44	39808	31" (79 cm)	7/8" (22 mm)	5.3 lbs (2.4 kg)

T44 illustration

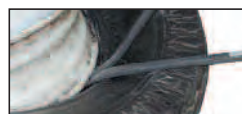

Cross Reference:	Ken-Tool No.	T43A	T43C	T43D	T44	T41
	CPM	Livraison Ref. 1547	Face 68 Ref.426/68	Force Ref. 1289	Halte Ref. 1060	Sayam Ref. 858

Lock Ring Tools

Herramientas para anillos de seguridad

Outils pour anneau verrouilleur

These tools are designed to remove most truck lock rings. A must-have for anyone mounting or demounting multi-piece rims. Use in pairs.

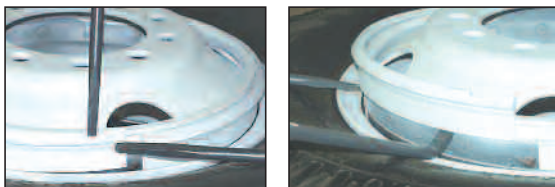

Truck Lock Ring Remover

Desmontador para anillos de seguridad para camiones

Dégageur d'anneau verrouilleur pour camions



Designed for smaller diameter wheels.

Model	Item No.	Length	Stock	Weight
T23 [®]	32123	24" (61 cm)	11/16" (17.5 mm)	2.4 lbs (1 kg)

Truck Lock Ring Remover

Desmontador para anillos de seguridad para camiones

Dégageur d'anneau verrouilleur pour camions



Designed for smaller diameter wheels.

Model	Item No.	Length	Stock	Weight
T23A [®]	33223	30" (76 cm)	11/16" (17.5 mm)	3.1 lbs (1.4 kg)

Combination Rim / Ring Tool

Herramienta para combinación de llantas/anillos

Deux en un pour jante/anneau



Flat tapered end ideal for all around ring and rim work.

Model	Item No.	Length	Stock	Weight
T23B	33224	23-1/2" (60 cm)	11/16" (17.5 mm)	2.4 lbs (1 kg)

Rim Lock Tool

Herramienta para anillos de seguridad de llantas

Bloque-talons



For servicing wide base rims.

Model	Item No.	Length	Stock	Weight
T25	32125	18" (46 cm)	11/16" (17.5 mm)	1.8 lbs (.8 kg)

Special Lock Ring Tool

Herramienta para anillos de seguridad especiales

Outil spécial pour anneau verrouilleur



Long tapered curved end for continuous side rings.

Model	Item No.	Length	Stock	Weight
T27	32127	18" (46 cm)	11/16" (17.5 mm)	1.8 lbs (.8 kg)

Top Seller

Lock Ring Tool

Herramienta para anillos de seguridad

Outil pour anneau verrouilleur

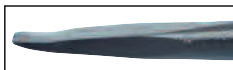

Removes continuous side rings on two-piece truck rims.

Model	Item No.	Length	Stock	Weight
T27A	32128	18" (46 cm)	11/16" (17.5 mm)	1.8 lbs (.8 kg)

Heavy-Duty Lock Ring Tool

Herramienta para anillos de seguridad de alta resistencia

Outil robuste pour anneau verrouilleur



Use for multi-piece wheels, especially hub type.

Model	Item No.	Length	Stock	Weight
T48A	34648	37" (94 cm)	3/4" (19 mm)	4.6 lbs (2.1 kg)

Industrial Wheel Lock Ring Set

Juego de anillos de traba para ruedas industriales

Jeu d'anneaux verrouilleurs de roues industrielles

32131
Demount
Prep Tool



Separator end separates split ring from solid flange ring

Pry-out end reaches behind slotted end of split ring to pry it out and over the flange of the wheel

32130
Mount /
Demount
Tool

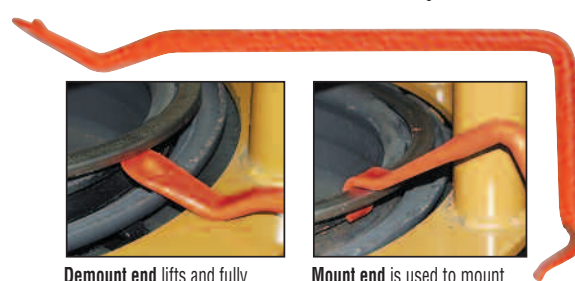

Demount end lifts and fully demounts split ring

Mount end is used to mount split ring

Specially designed to remove & replace lock rings on multi-piece industrial forklift wheels. Removing and replacing lock rings on multi-piece industrial wheels presents its own set of unique problems – these tools are specifically designed to make that job easier, faster, and safer. Helps prevent injury – easier to keep hands safely outside of press cage! Powder coated to protect from rust and corrosion; bright orange color helps prevent lost tools. Forged from high-grade carbon steel and heat-treated for long-lasting strength and durability.



PATENTED



Set No. 32129 Weight: 3.3 Lbs (1.5 kg).

Industrial Wheel Lock Ring Tool Set #32129

2 Pc. Set Includes:

Item No.	Description	Length	Stock	Weight
32130	Mount Demount Tool	15-3/4" (40 cm)	5/8" (16 mm)	1.8 lbs (.8 kg)
32131	Demount Prep Tool	15-1/2" (40 cm)	5/8" (16 mm)	1.5 lbs (.7 kg)

For more information visit us at www.kentool.com

DON'T RISK INJURY



IRONMAN™

Ergonomic Wheel Lifting Bar

Barra ergonómica para el levantamiento de neumáticos Ironman™

Barre ergonomique de levée de roue Ironman™

ERGONOMIC:
Use the leverage created by the tool – **NOT YOUR BACK!**



IronMan™
Wheel Lifting Bar



Specially designed forged ends work from either side of the wheel assembly as it lays flat

Reduces back strain. Easily and safely lift heavy, awkward truck tire and wheel assemblies. Extremely useful in outdoor conditions – when truck tire and wheel assemblies can become wet and slippery. Lift all sizes and types of small and large heavy truck wheels: Standard sizes including 22.5" and 24.5" wheels, plus European (which have 1" lug holes), Super Wide and even the Super Single (a 340 lb. assembly) size.

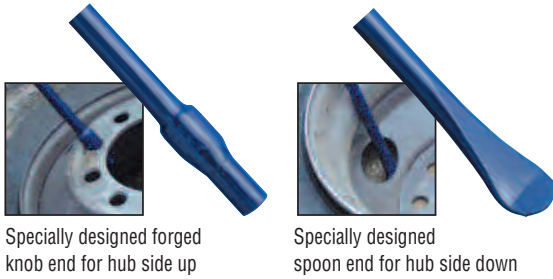

Specially designed forged knob end for hub side up

Specially designed spoon end for hub side down

Model	Item No.	Length	Stock	Weight
T950	34950	58" (147 cm)	1" (25 mm)	10 lbs (4.5 kg)

Aluminum Wheel Protector

Protector de cubiertas de aluminio
Protecteur pour roues en aluminium



PATENTED

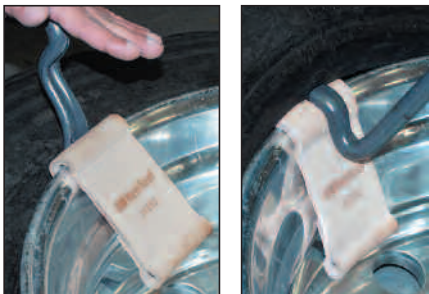

Protect expensive rims from damage during manual tire changing. Prevents tire tools from marring or scratching aluminum or steel rims when using Ken-Tool's manual tire changing tools. Durable leather protector fits on the rim and protects inside of the rim well. Use with an assortment of tire tools including: T45A® - style tire irons, Serpent™, tire spoons, other Ken-Tool tire changing tools. When one end wears out, flip it over and use the opposite end. Great for roadside service or in the shop.

Item No.	Description	Length	Weight
31810	Leather Rim Protector	6" (15 cm)	6 oz (.2 kg)

Bead Holding Devices

Dispositivos de fijación de talón
Dispositifs de retenue des talons

Bead Holding Device

Dispositivo para soporte de llantas
Dispositif de retenue des talons

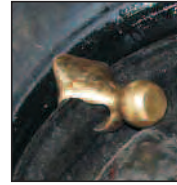

Now reaches over extra wide bead of super singles. Holds the bead in place against the wheel when mounting the tire on to the wheel. Do not use to pry. **Imported.**



Bead Holding Device



How to Properly Use Bead Holders #31710 on a 21L-24 Backhoe Tire and Wheel

Item No.	Description	Weight
31710	Solid Brass Bead Holding Device	1.8 lbs (.8 kg)

Aluminum Bead Holder For Steel & Aluminum Wheels

Sujetador de talón de aluminio para ruedas de acero y aluminio

Support de talon en aluminium pour roues en acier et en aluminium



31713



31714



Special C-Lok™ shape fits nearly all passenger, light truck, agriculture and truck wheels without slipping off. Aluminum design is lightweight but very strong and is less likely to mar alloy wheels. Great for super singles and super wide wheels — fits both steel and aluminum wheels. Available as a cabled pair No. 31714 for difficult wheels. **Imported.**



Newest Bead Holder - Made From Aluminum



Aluminum Bead Holder

Item No.	Description	Length	Weight
31713	Single Aluminum Bead Holder	5.5" (14 cm)	8 oz (.2 kg)
31714	32" Cabled Pair		1 lb (.5 kg)

Bead Holder For 19.5" Aluminum Wheels

Sujetador de talón para ruedas de acero y aluminio de 19.5"

Support de talon pour roues en aluminium de 19,5 po

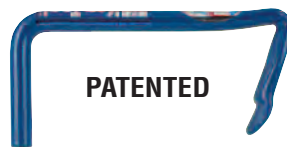

PATENTED



Steel bead holder for 19.5" aluminum truck wheels that fit 9/16" diameter studs. Always mount/demount 19.5" wheels with hub side up.

Item No.	Description	Weight
33196	Bead Holder for 19.5" Aluminum Wheels	1 lb (.5 kg)

Bead-Breaking Tools Truck / Farm / OTR

Herramientas desmontadoras de llantas para camiones/vehículos de granja/de carretera

Outils de décollage des talons pour camions/tracteurs/véhicules tout terrain



These lightweight, portable tools are a great alternative to handled bead breaking wedges or hydraulic bead breakers. One end is used to remove frozen or rusted beads from all types of rims. On the T52, the other end can be used as a leverage bar when inserted into the 35695 or 35697 Truck Lug Wrench.

Swan Neck Leverage Bar

Palanca de cuello de cisne

Barre de levage à col de cygne



Model	Item No.	Length	Stock	Weight
T41	33341	30" (76 cm)	7/8" (22 mm)	5.3 lbs (2.4 kg)

30" Bead Breaker

Desmontadora de llantas de 30 pulgadas

Démonte-talons de 30 po



Model	Item No.	Length	Stock	Weight
T42	33342	30" (76 cm)	7/8" (22 mm)	4.8 lbs (2.2 kg)

Bead Breaker Leverage Bar

Palanca desmontadora de llantas

Barre de levage pour démonte-talons



Also for use with the T95 wrenches.

Model	Item No.	Length	Stock	Weight
T52	34652	33" (84 cm)	7/8" (22 mm)	5.5 lbs (2.5 kg)

Portable Bead Breaker

Desmontadora de llantas portátil

Démonte-talons portatif



Portable bead-breakers are great for custom and foreign wheels. They break beads on most sizes of passenger tires and light trucks.

Model	Item No.	Handle Length	Weight
T100	34670	36" (91 cm)	5.2 lbs (2.3 kg)

Top Seller

Bead-Breaking Tool / Driving Iron

Herramienta desmontadora de llantas/ barra de hierro desmontadora

Outil de décollage des talons/Levier d'entraînement



Driving iron is used for loosening rusted truck and bus beads. Will speed truck tire repair work and save labor and time.

Model	Item No.	Length	Stock	Weight
T26A	32126	11-3/4" (30 cm)	1-1/4" (32 mm)	4.4 lbs (2 kg)

Impact Bead Breakers

Desmontadoras de llantas de impacto

Démonte-talons à chocs



Bead breaker loosens beads with bead-breaking foot and ram bar, but never cuts the bead of the tire. The wedge foot is forced between the bead and rim flange. Breaker is designed for shop or road use. No other bead breaking tools are necessary. Provides greater accuracy than other conventional bead breakers.

T26B has exclusive spring action design to reduce user fatigue associated with slide hammer kickback.

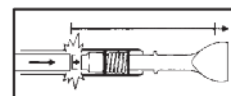

T24B Economy
1" Dia. Ram

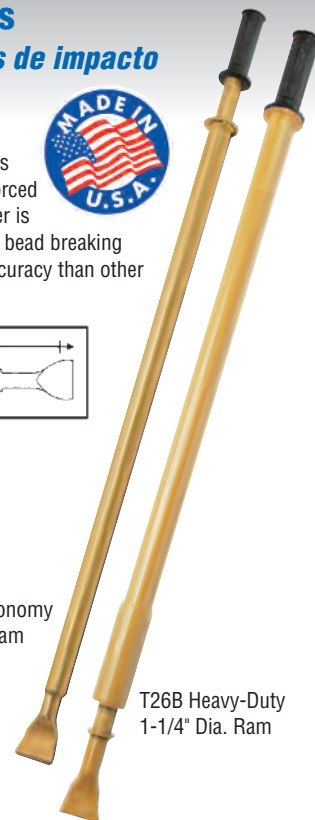

T26B Heavy-Duty
1-1/4" Dia. Ram

Model	Item No.	Description	Length	Length Ext.	Weight
T24B	35924	Economy	46" (117 cm)	72" (183 cm)	13.5 lbs (6.1 kg)
T26B	35926	Heavy-duty	50" (127 cm)	80" (203 cm)	23 lbs (10.4 kg)

Floor Type Bead Breaker

Desmontadoras de llantas con pie

Démonte-talons sur sol



Ideal for stubborn tires. Use to prevent the bending of wheels. A great solution for custom and foreign wheels.



For Passenger
and Light Truck.



Model	Item No.	Description	Tread Width	Weight
T98	35998	Deluxe	up to 11" (28 cm)	29.8 lbs (13.5 kg)

Valve Breaker™

Herramienta para romper válvulas

Valve Breaker™

Outil casse-valve Valve Breaker™



Valve Breaker Tool:
How To Use It



Solid ram bar (not hollow pipe)
drives more energy into valve

PATENTED



Valve Breaker
Repair Kit 35935



Metric Valve Breaker
Repair Kit 35937

Now Available in Steel and Alloy Models!

Quickly and easily remove valve stems from steel and alloy wheels! Made in USA from quality, high-grade steel. Heat-treated punch for top performance and long life. Pinch-preventing Safety Grip with vibration dampening tube grip. Long-lasting baked powder coat finish. T34B designed to fit into most 30" toolboxes. Simple to re-build — only 3 components.

Model	Item No.	Description	Length	Tip Diameter	Weight
T34B	35934	Valve Breaker	27" (69 cm)	.5" (14mm)	9 lbs (4.1 kg)
T36B	35936	Valve Breaker	45" (114 cm)	.5" (14mm)	16 lbs (7.2 kg)
T38B	35938	Metric Valve Breaker	45" (114 cm)	.35" (9mm)	16 lbs (7.2 kg)
	35935	3 Pc. Valve Breaker Repair Kit		.5" (14mm)	1 lb (.5 kg)
	35937	3 Pc. Metric Valve Breaker Repair Kit		.35" (9mm)	1 lb (.5 kg)

Duck-Billed Bead Breaking Wedges

Our most popular bead breakers.

Cuñas desmontadoras de llantas de boca plana

Coins d'écartement de talons en bec de canard



Wood Handled

Con mango de madera

Manche en bois



Increased contact area between the handle and the hammer head causes the handle to have a tighter fit when the head is seated on the handle. By increasing end-taper of the handle the hammer head cannot come off the end of the handle. No slits in the top of the handle minimizes the effect of Humidity/Climate (expansion & contraction) on the handle.

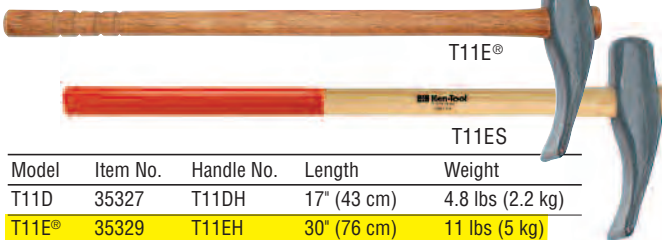

Model	Item No.	Handle No.	Length	Weight
T11D	35327	T11DH	17" (43 cm)	4.8 lbs (2.2 kg)
T11E®	35329	T11EH	30" (76 cm)	11 lbs (5 kg)

New T11ES orange safety grip handle. Specially formulated granulated handle coating provides extra grip for sure control of the steel bead breaking wedge.

Model	Item No.	Handle No.	Length	Weight
NEW T11ES	35330	T11EHS	30" (76 cm)	11 lbs (5 kg)

Fiberglass Handled

Con mango de fibra de vidrio

Manche en fibre de verre

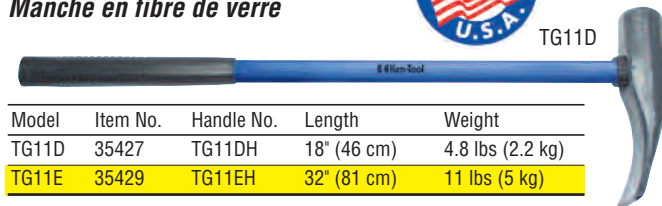

Model	Item No.	Handle No.	Length	Weight
TG11D	35427	TG11DH	18" (46 cm)	4.8 lbs (2.2 kg)
TG11E	35429	TG11EH	32" (81 cm)	11 lbs (5 kg)

Polymer Handled

Con mango de polímero

Manche en polymère

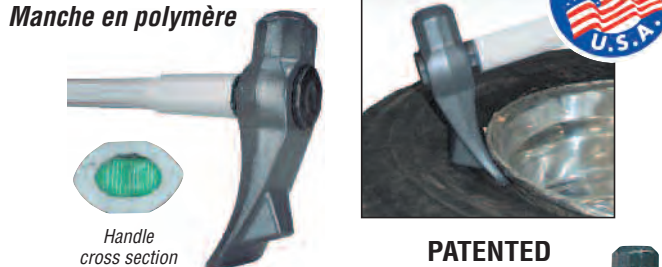

Handle
cross section

PATENTED

Hump Design prevents tool from wedging between rim and bead. Breaks the bead with little or no prying. New polymer handle design for longer lasting everyday use. Full length fiberglass core for greater strength. Coating on handle provides durability.

Model	Item No.	Replacement Handle	Length	Head Weight
T11K™	35460	T11KH (35230)*	32" (81 cm)	10.5 lbs (4.8 kg)

*New handle design T11KH (35230) will not work with old style T11E head



General Purpose Tire Hammers • Martillos para llantas universales • Masse à tout usage

Designed for tire service in a variety of sizes and styles. Use rubber head replacement T11RH (35104).

Wood Handled

Con mango de madera

Manche en bois

Model	Item No.	Handle No.	Length	Weight
T11B	35311	T11BH	14-1/2" (37 cm)	4.5 lbs (2.0 kg)

Model	Item No.	Handle No.	Length	Weight
T33R	35317	T11HN	14" (36 cm)	2.3 lbs (1.0 kg)

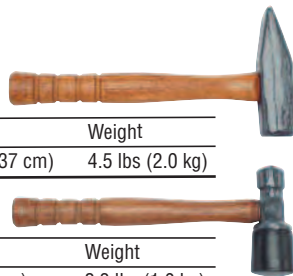

Fiberglass Handled

Con mango de fibra de vidrio

Manche en fibre de verre

Model	Item No.	Handle No.	Length	Weight
TG11B	35411	TG11BH	16" (41 cm)	4.8 lbs (2.1 kg)

Model	Item No.	Handle No.	Length	Weight
TG33R	35417	TG31H	16" (41 cm)	2.5 lbs (1.1 kg)

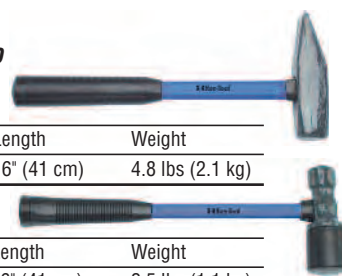

Heavy Duty Tire Hammers • Martillos para llantas de alta resistencia • Masses à pneu robuste

Hammers are used for mounting and demounting tires. They make tire changing faster and easier for passenger car, truck, bus, farm tractor, and aircraft tires. A variety of weights and sizes are offered to meet all your tire changing needs. Non-marring rubber end can be used for driving on lock rings. Use rubber head replacement T34RH (35105).

Wood Handled

Con mango de madera

Manche en bois

Model	Item No.	Handle No.	Length	Head Weight	Weight
T34	35321	T11CH	17"	4.8 lbs	5.4 lbs
			43 cm	2.2 kg	2.4 kg

Model	Item No.	Handle No.	Length	Head Weight	Weight
T35	35323	T11DH	16-1/2"	5.5 lbs	6.1 lbs
			42 cm	2.5 kg	2.7 kg

Model	Item No.	Handle No.	Length	Head Weight	Weight
T36	35325	T11CH	16-1/2"	5.8 lbs	5.3 lbs
			42 cm	2.6 kg	2.4 kg



Fiberglass Handled

Con mango de fibra de vidrio

Manche en fibre de verre

Model	Item No.	Handle No.	Length	Head Weight	Weight
TG34	35421	TG11CH	18"	5.5 lbs	6 lbs
			46 cm	2.5 kg	2.7 kg

Model	Item No.	Handle No.	Length	Head Weight	Weight
TG35	35423	TG11DH	18"	4.8 lbs	6.6 lbs
			46 cm	2.2 kg	3.0 kg

Model	Item No.	Handle No.	Length	Head Weight	Weight
TG36	35425	TG11CH	18"	5.8 lbs	6 lbs
			46 cm	2.6 kg	2.7 kg



Replacement Handles

Mangos de repuesto

Manches de remplacement

Top Quality U.S. Hickory

U.S. Hickory de máxima calidad • Qualité supérieur U.S Hickory

T11EHS

New T11EHS orange safety grip handle. Specially formulated granulated handle coating provides extra grip for sure control of the steel bead breaking wedge.

T11EH

Model	Item No.	For Hammer No.	Length	Weight
T11BH	35111	T11B	15" (38 cm)	.75 lbs (.3 kg)
T11HN	35113	T11R, T31, T33R	15" (38 cm)	.75 lbs (.2 kg)
T11CH	35119	T11C, T34, T36	17" (43 cm)	.75 lbs (.3 kg)
T11DH	35127	T11D, T35	17" (43 cm)	.75 lbs (.3 kg)
T11EH	35129	T11E®	30" (76 cm)	1.2 lbs (.5 kg)
T11EHS	35131	T11E®	30" (76 cm)	1.2 lbs (.5 kg)
80H-3H	37012	80H-3, 80H-4	10" (25 cm)	.5 lbs (.2 kg)
85H-3H	37023	85H-3, 84H-2, 84H-4	15" (38 cm)	.75 lbs (.3 kg)
84H-8H	37025	84H-8, 84H-10, 84H-12, 84H-16	36" (91 cm)	1.4 lbs (.6 kg)
84H-20H	37089	84H-20	36" (91 cm)	1.4 lbs (.6 kg)

Aluminum • Aluminio • Aluminium

T11AH

Model	Item No.	For Hammer No.	Length	Weight
T11AH	35529	T11E®, TG11E	32" (81 cm)	4.3 lbs (2 kg)

Polymer • Polímero • Polymère

PATENTED

T11KH

Model	Item No.	For Hammer No.	Length	Weight
T11KH	35230	T11K™	32" (81 cm)	2.3 lbs (1.0 kg)

Fiberglass • Fibra de vidrio • Fibre de verre

TG37H

Model	Item No.	For Hammer No.	Length	Weight
TG31H	35206	TG11R, TG31, TG33R	16" (41 cm)	1 lb (.5 kg)
TG11BH	35211	TG11B	16" (41 cm)	1.3 lbs (.6 kg)
TG11CH	35219	TG11C, TG34, TG36	18" (46 cm)	2.5 lbs (1.1 kg)
TG11DH	35227*	TG11D, TG35	18" (46 cm)	1.2 lbs (.5 kg)
TG11EH	35229*	TG11E	32" (81 cm)	2.3 lbs (1.0 kg)

* Nulok adapter (others use epoxy).

Replacement Rubber Heads

Cabezas de goma de repuesto

Tête de remplacement en caoutchouc

Model	Item No.	Description	For Hammer No.
T11RH	35104	Rubber Head	T11R, TG11R, T33R, TG31
T34RH	35105	Rubber Head	T34, TG34, T35, TG35, T36, TG36

Epoxy Kits • Equipos de epoxy • Ensembles en époxy

Model	Item No.	Description	For Hammer No.
T12B	35201	Epoxy Kit	TG11B, TG11R, TG31, TG33R
T12D	35202	Epoxy Kit	TG34, TG35, TG36, TG37

Top Seller

For more information visit us at www.kentool.com

Tire Snake®

'Snake®' para llantas / 'Snake®' Outil à pneu
Snake®



Tire Snake mounting and demounting tools for use with center post tire changers. Included with T600 Tire Changer, designed for wheels from 4" to 12". Included with T601 Tire Changer, designed for wheels from 4" to 15", the longer length provides greater leverage.



Model	Item No.	Length	Stock	Weight
TS72	34672	22" (56 cm)	5/8" (2 cm)	2 lbs (.9 kg)
TS74	34674	28" (71 cm)	5/8" (2 cm)	2.5 lbs (1.1 kg)
TS42	34678	42" (102 cm)	3/4" (19 mm)	5.3 lbs (2.4 kg)



Bead Seating Tool

Outil de portée de talon
Herramienta para calzado de talone



**RATED TO
165-PSI**

Used on Auto, ATV, and Truck Tires. Designed for use on tires up to 24-1/2 diameter. ASME-UM certified 5-gallon tank. Heavy-duty bar valve quickly releases air between bead and rim. Air pressure gauge and safety release valve included for operator convenience and safety. Plastic nose clip protects chrome and alloy wheels; replacements available.

Item No.	Description	Weight
31444	Bead Seating Tool with 5 Gallon Tank	33.1 lbs (15 kg)

Air Blast® Bead Seater for Small Tires

Calzador a chorro
de aire para
llantas pequeñas
Air comprimé pour
repos de talon de
petits pneus



Item No.	PSI	Weight	Capacity
31440	Rated to 150-PSI	5.6 lbs (2.5 kg)	3 Liters

ATV Bead Breaker Desmontadora de llantas para vehículos todo terreno Décolleur de talon pour VTT



PATENTED

Constructed of heavy-duty steel, the ATV Bead Breaker works with any center post tire changing machine and adjusts to sizes of 6 to 12 inch ATV rims without the hassle of clevis pins. No hammers, wrenches, or additional tools are required.

Item No.	Weight
38620	7 lbs (3.2 kg)

Manual Tire Changers

Cambiadores de llantas manuales
Démonteurs de pneus manuels



Floor Mount

Montaje de piso
Montage au sol



Threadscrew
has been
milled to fit
MTD wheels.

Mounts and demounts a full range of tires on rim diameters from 4 to 15 inches. Tapered bearing guide positively centers straight shaft hubs of all diameters. A built-in, infinitely adjustable bead breaker works on rims up to 15" in diameter and 24" in width without disassembly. Includes a Ken-Tool exclusive, 28" Tire Snake® mount/demount tire tool.

Model	Item No.	Height	Weight
T601	38601	32" (81 cm)	31 lbs (14 kg)



Small Tire
Changing Tools
Part 1



Small Tire
Changing Tool
Part 2

Bench / Rim Clamp Mount

Montaje de banco/
abrazadera de llantas
Montage sur
banc/crapaud



Threadscrew
has been
milled to fit
MTD wheels.

Mounts and demounts a full range of tires on rim diameters from 4 to 12 inches. Mounts easily to a bench or in any standard, four-position rim-clamp tire changer. A built-in, three fin centering device mounts standard lug-type rims with 2" and larger center hole. Square base prevents turning in the changer during use. Includes a Ken-Tool exclusive, 22" Tire Snake® mount/demount tire tool.

Model	Item No.	Height	Weight
T600	38600	16-1/2" (42 cm)	21.7 lbs (10 kg)

For additional small tire tools see page 19

Tire Mount / Demount Lubricants

Lubricantes para montaje/desmontaje de neumáticos

Lubrifiants de montage & démontage de pneus

Professional grade lubricants make tire mounting and demounting easier and more efficient.



Tiger Paste Lubricant

Lubricante Tiger Paste

Lubrifiant Tiger Paste

Superior formulation for use in mounting and demounting commercial, OTR and specialty equipment tires, with rust inhibitor.

Item No.	Weight
35837	7.5 lb. (3.4 kg)



Ultra Lube

Lubricante Ultra Lube

Lubrifiant Ultra Lube

Premium rim and rust retardant and tire mounting/demounting lubricant for demanding applications.

Item No.	Weight
35839	25 lb. (11.4 kg)



Euro Paste Lube

Lubricante Euro Paste Lube

Lubrifiant Euro Paste Lube

Premium tire mounting/demounting lubricant dries tacky to prevent rim slippage, with rust retardant.

Item No.	Weight
35848	8 lb. (3.6 kg)



Heavy Paste Lube

Lubricante Heavy Paste Lube

Lubrifiant Heavy Paste Lube

Concentrated economical tire mounting/demounting and bead packing lubricant, makes up to 15 gallons.

Item No.	Weight
35840	25 lb. (11.4 kg)



Bead-Eze® Tire Lubricant

Lubricante para neumáticos Bead-Eze®

Lubrifiant de pneu Bead-Eze®

Penetrating water-based lubricant for tire mounting/demounting, can be diluted for leak detection, six-pack.

Model	Item No.	Description	Weight
T147A	35847	One Gallon, 6-Pack	54 lbs (24.5 kg)



Bead-Eze® Tire Lubricant

Lubricante para neumáticos Bead-Eze®

Lubrifiant de pneu Bead-Eze®

Penetrating water-based lubricant for tire mounting/demounting, can be diluted for leak detection.

Model	Item No.	Description	Weight
T147A	35847S	One Gallon, single	9 lb. (4.1 kg)



Detecto Mist Leak Locator

Localizador de fugas Detecto Mist

Localisateur de fuites Detecto Mist

Spray on tire to instantly detect air leaks, concentrated formula dilutes with water.

Model	Item No.	Description	Weight
D105A	35805	One Quart	2.3 lb. (1 kg)



Lubricant Applicators

Aplicadores de lubricantes

Applicateurs de lubrifiant

Bead Lubricant Swab

Estropajo para lubricante de talones

Écouvillon pour lubrifiant de talon

Durable cotton applicator quickly holds and applies lube, twisted wire construction and wood handle.



Model	Item No.	Length	Weight
B111	30511	12" (30.5 cm)	3 oz (.1 kg)

Euro Style Lube Brush

Pincel para lubricante estilo europeo

Brosse de lubrification style européen

Designed to the ideal angle to fit between the tire bead and rim.



Imported.

Item No.	Length	Weight
30512	11" (28 cm)	10 oz (.3 kg)

Super Single Axle Drain Pan

Súper bandeja de drenaje de eje único

Bac de récupération pour essieu simple super



PATENTED

Extended applications: Fits most 10-hole Super Single and Dual Disc Wheels.

Lightweight molded plastic pan locks inside truck and trailer wheels to keep tire and wheel clean. Fits most steel and aluminum 22.5" and 24.5" 10-hole hub, and stud-piloted tubeless wheels. HDPE high density polyethylene design won't warp if oil is warm. 124 oz. capacity with self-draining shelves for hub and axle nuts. Flat bottom avoids spillage on workbench or floor. Two built-in drip-proof drainage spouts for easy waste disposal.

Item No.	Description	Weight
30600	Pro Super Single Axle Drain Pan	1.3 lbs (.6 kg)

OSHA Tire Service Charts

Cuadros de servicio de neumáticos OSHA

Diagrammes d'entretien des pneus OSHA



OSHA Tire Mount/Demount Safety Instructions & Charts. 24" x 70" High Quality posters. Suitable for wall mounting in service area per OSHA 29 CFR 1910.77.

Includes:

Demounting & Mounting Procedures for Tube-type Truck & Bus Tires Chart (OSHA 3402 10R-11)

Demounting & Mounting Procedures for Tubeless Truck & Bus Tires Chart (OSHA 3401 10R-11)

Multi-Piece Rim Matching Chart (OSHA 3403 10R-11)

Item No.	Description	Weight
39998	3 Poster Set	1 lb (.5 kg)



Tire Bead Seaters

Calzador para llantas
Cordons de talon de pneus

One-piece rubber tube for mounting hard-to-seat radial, bias-belted, or conventional truck tires. As tire is inflated, the lubricated bead seater forms a seal between the rim and tire, allowing the air pressure to force the beads into the rim flange. As proper pressure is reached, the bead seater slides out and over the rim. Use bead lubricant with bead seaters.



Passenger / Light Truck

Camión liviana/vehículo de pasajeros • Automobile/camion léger

Item No.	Fits Rim Sizes	Weight
31446	14-15" (36 - 38 cm)	1.5 lbs (.7 kg)

Truck • Camión • Camion

Item No.	Fits Rim Sizes	Weight
31437	16-1/2" to 17-1/2" (42 to 45 cm)	2 lbs (.9 kg)
31438	19-1/2" (50 cm)	2.3 lbs (1 kg)
31439	22-1/2" to 24-1/2" (57 to 62 cm)	2.3 lbs (1 kg)

Pneumatic Bead Expanders

Expansores neumáticos de llantas
Tubes d'extension de talon pneumatiques



Expanders fit most bias ply tubeless tires. A pliable neoprene rubber tube is encased in a tough, long-lasting nylon cover. Expanders slip easily over tire and withstand contact with oil, grease, solvents, and acids. Expands passenger and light truck beads by compressing tread. **T131** is for smaller tires, **T132** for belted bias ply tires and steel belted radials, and **T133** for standard bias ply tires. All models feature an over-pressure relief valve and external pressure quick release valve for safe operation.

Model	Item No.	Min / Max Tire O.D.	Tube Diameter	Weight
T131	31431	10 - 22" (26 - 56 cm)	2-1/4" (6 cm)	2 lbs (.9 kg)
T132	31432	24 - 34" (61 - 86 cm)	2-1/4" (6 cm)	2.8 lbs (1.2 kg)
T133	31433	22 - 32" (60 - 81 cm)	3/4" (2 cm)	.75 lbs (.3 kg)

Wheel Weight Hammers

Martillos de peso de rueda
Marteaux pour masses d'équilibrage

"The last wheel weight hammer you'll ever need!"

ANTI-MARRING Replaceable hammer face that is safe for use on STEEL, ALUMINUM, and CHROME! Replaceable chromoly steel hook removes all clip on wheel weights – lead, zinc, and steel, no modification needed to fit smaller weights. Fiberglass handle with ergonomic industrial grip is chemical resistant and 4X STRONGER THAN WOOD. Refurbish kit available to replace the hook and replace the anti-marring face.



Model	Item No.	Description	Length	Weight
B230	35354	Professional Wheel Weight Tool	10" (25.4 cm)	1 lb (.5 kg)
B232	35355	Standard Wheel Weight Tool	9.5" (24.1 cm)	1 lb (.5 kg)
35361		Automotive Wheel Weight Hammer	11" (28 cm)	1 lb (.5 kg)
35362		Hub Wheel Weight Hammer Refurbish Kit		.25 lbs (.11 kg)

Wire Brush

Cepillo de alambre • Brosse métallique

Cleans rust from rims and wheels.



Model	Item No.	Length	Weight
T15	30515	14" (36 cm)	5 oz. (.2 kg)

Tire Spreaders

Separadores de llantas • Écarte-pneus

Tire Spreader with Lock Pin

Separador de llanta con pasador de bloqueo
Écarte-pneu avec goupille de sécurité



Imported.

Model	Item No.	Spread Capacity	Weight
T51	31551	4" - 6" (10-15 cm)	3.9 lbs (1.7 kg)

Ratchet Action Truck Tire Spreader

Separador de llantas para camiones
Ratchet Action
Écarte-pneu à rochet pour camions



Model	Item No.	Spread Capacity	Weight
T54	31554	3-1/2" - 14" (9 - 36 cm)	7.3 lbs (3.3 kg)

Professional Wheel Weight Tool

Herramientas profesional para pesar ruedas
Outil professionnel pour masses d'équilibrage

Clip-claw crowbar, punch designed handles, and heavy hammerhead provide years of use. Imported.

Model	Item No.	Weight
B230	35354	1 lb (.5 kg)



Standard Wheel Weight Tool

Herramientas estándar para pesar ruedas
Outil standard pour masses d'équilibrage

This passenger car wheel weight tool is the industry standard. Imported.

Model	Item No.	Weight
B232	35355	1 lb (.5 kg)



Professional 4-Way Valve Core Tool

Herramienta profesional para núcleos de válvulas de 4 vías
Outil à valve professionnel 4 en 1 pour noyaux

Handy 4-in-1 standard valve tool repairs cap threads, repairs core threads, has special easy-out feature for removing damaged cores, and screwdriver for removing standard cores. Black, heavy-duty hardened steel. Imported.

Model	Item No.	Weight
T16P	30215	1 oz (.04 kg)



Cap Nut Wrenches

Llaves de tuercas ciegas
Clés à écrou borgne

Ken-Tool **Porkchop™**



Wrenches hold outer cap nut on dual wheels while the inner nut is turned. Lip fits in hole to secure wrench in place. Sizes offered fit standard and metric cap nuts.

Model	Item No.	Description	Size	Weight
TX9®	30609	SAE	1-1/2"	.7 lbs (.3 kg)
TX10	30610	Metric	35 mm	.7 lbs (.3 kg)
TX12	30612	Metric	41 mm	.7 lbs (.3 kg)

Combination Cap Nut Wrench

Llave de tuercas ciegas de combinación
Clé à écrou borgne deux en un



Offers the versatility of two wrenches in one unique product design. Fit one end onto the outer cap nut with the other end through the center hole. Wrench slides underneath center disc of wheel, reducing slipping during nut removal.



Combination Cap Nut Wrench

Model	Item No.	Description	Size	Weight
TX50	30620	SAE & Metric	41 mm, 1-1/2"	1.3 lbs (.6 kg)

Heavy-Duty Cap Nut Wrenches

Llaves de tuercas ciegas de alta resistencia
Clés robustes à écrou borgne

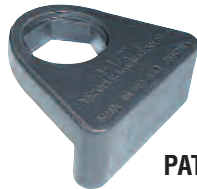

PATENTED



Heavy-duty design will not slip out of position. Wrench rests snugly against the center hole, reducing the possibility of rim damage. Ideal for aluminum wheels.



Heavy-Duty Cap Nut Wrenches

Model	Item No.	Description	Size	Weight
TX200	30618	SAE	1-1/2"	2.6 lbs (1.2 kg)
TX241	30619	Metric	41 mm	2.6 lbs (1.2 kg)

Professional Lug Nut Cover Remover

Desmontador profesional de cubierta con tuercas
Dégageur professionnel d'écrous d'enjoliveurs de roues

Special coating will not scratch or damage chrome, painted, or coated lug nut covers. Adjusts to fit larger lug nuts.

Item No.	Weight
30606	1.3 lbs (.6 kg)



Wheel Cover Puller / Replacers

Extractor/cambiadores de cubiertas
Extracteur de garde-roues/garde-roues d'échange



Removes wheel covers quickly and easily without gouging or scratching them. Rubber head **T11RH** prevents damage to hub cap and is replaceable.



Pro

Profesional
Professionnel



Model	Item No.	Length	Stock	Weight
T67	31567	17-1/2" (45 cm)	9/16" (14.3 mm)	1.8 lbs (.8 kg)

Standard

Estándar
Standard



Model	Item No.	Length	Stock	Weight
T68®	31568	14" (36 cm)	7/16" (11.1 mm)	1.3 lbs (.6 kg)

Strap Winder

Enrollador de correa
Enrouleur de sangles



Patented design makes strap winding quick and easy!



PATENTED

Three Tools In One!

Quick Wind

Quick Cheater Bar



Quick Tire Check



Patented design allows fast and easy strap winding with one hand. Use to quickly tighten ratchet straps. The perfect tire knocker. Makes it easier to check the inside dual tire. Steel construction is durable and provides long lasting service. Foam rubber grip is comfortable even after repeated use.



Strap Winder for Trailers #39760

Item No.	Length	Weight
39760	19"	2.7 lbs (1.2 kg)

Top Seller

For more information visit us at www.kentool.com



Four-Way Lug Wrenches

Llaves cruz

Clés à goujon à quatre têtes

Ken-Tool offers the world's largest selection of quality lug wrenches, available in sizes to fit all your tire changing needs - SAE and Metric.

Professional Lug Wrenches

Llaves profesionales

Clés à goujon professionnelles



T57
"Our Best"

These wrenches are America's premier professional lug wrenches for cars, light trucks, SUV's, RV's, and vans. Drop-forged centers for extra strength. Keep wrenches in trunk for emergencies or everyday use.

Model	Item No.	Description	Socket Sizes	Length	Stock	Weight
T56	35656	Passenger	17, 19, 21, 22 mm	23" 58 cm	5/8" 16 mm	4 lbs 1.8 kg
T57®	35657	Passenger	3/4", 13/16", 7/8", 15/16"	23" 58 cm	5/8" 16 mm	4.5 lbs 2 kg

Standard Lug Wrenches

Llaves estándar

Clés à goujon standard

Welded center construction for strength and durability. Premium grade, special bar quality steel for extra strength.



T59

Model	Item No.	Description	Socket Sizes	Length	Stock	Weight
T59	35659	Passenger	3/4", 13/16", 7/8", 15/16"	22" 56 cm	5/8" 16 mm	4.2 lbs 1.9 kg
T90	35690	Light Truck	7/8" deep well, 15/16", 1", 1-1/16"	25" 64 cm	3/4" 19 mm	7.2 lbs 3.2 kg

Economy Lug Wrenches

Llaves económicas

Clés à goujon économiques

These wrenches have fully welded centers which stand up to everyday use. 3/4" SAE is also 19 mm.

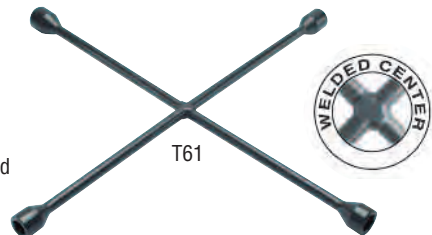

T61

Model	Item No.	Description	Socket Sizes	Length	Stock	Weight
T9520	35620	Passenger	3/4", 13/16", 7/8", 17 mm	20" 51 cm	9/16" 14 mm	3.4 lbs 1.5 kg
R23	35623	Passenger	3/4", 13/16", 7/8", 17 mm	20" 51 cm	9/16" 14 mm	3.8 lbs 1.7 kg
R24	35624	Passenger	17, 19, 21, 22 mm	20" 51 cm	9/16" 14 mm	3.8 lbs 1.7 kg
T61	35661	Passenger	3/4", 13/16", 7/8", 17 mm	22" 56 cm	9/16" 14 mm	3.8 lbs 1.7 kg
T62	35662	Passenger	3/4", 13/16", 7/8", 17 mm	18" 46 cm	9/16" 14 mm	3.2 lbs 1.5 kg
T63	35663	Passenger	17, 19, 21, 22 mm	18" 46 cm	9/16" 14 mm	3.2 lbs 1.5 kg
R20	35820	Passenger	17, 19, 21, 22 mm	20" 51 cm	9/16" 14 mm	3.5 lbs 1.6 kg

Heavy-Duty Truck Lug Wrenches

Llaves para camiones de alta resistencia

Clés à goujon pour camions lourds

Use on heavy-duty trucks, buses, and tractors. Drop-forged or welded center provides strength and durability. **T95, TM95, T95A, and TC95** wrenches have center hole for a leverage bar. Socket sizes provided fit most metric or SAE lug nuts on today's trucks. Stock: 1" (25 mm).



T95
"Our Best"

Model	Item No.	Socket Sizes	Length	Weight
T95	35695	1-1/16", 1-1/4", 1-1/2", 13/16" square	27-1/2" 70 cm	13.8 lbs 6.2 kg
TM95	35795	24, 27, 30, 33 mm	27-1/2" 70 cm	13.5 lbs 6.1 kg

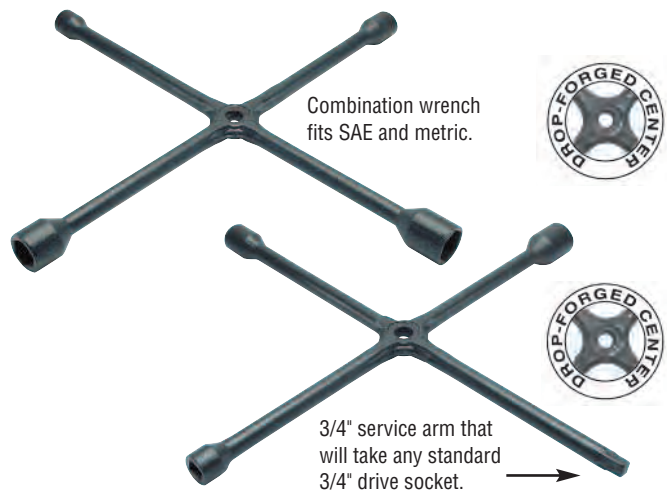

Combination wrench fits SAE and metric.

3/4" service arm that will take any standard 3/4" drive socket.

Model	Item No.	Socket Sizes	Length	Weight
TC95	35595	1-1/2", 13/16" square, 30, 33 mm	27-1/2" 70 cm	14.2 lbs 6.4 kg
T95A	35697	1-1/4", 1-1/2", 13/16" sq., 3/4" service arm	27-1/2" 70 cm	13.5 lbs 6.1 kg

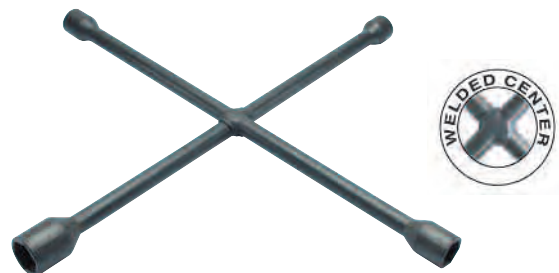

Model	Item No.	Socket Sizes	Length	Weight
T96	35696	1-1/16", 1-1/4", 1-1/2", 13/16" square	27-1/2" 70 cm	13.5 lbs 6.1 kg

Economy Four-Way Lug Wrenches for the Do-It-Yourselfer

LLaves cruz económicas para aficionados
Clés à goujon à quatre têtes économiques pour le bricoleur

A complete line of lug wrenches value priced and merchandised to maximize your DIY business... And they're all tough and dependable.

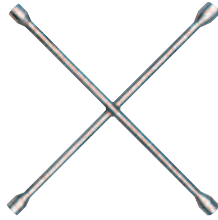

Passenger Car

Vehículo de pasajeros

Automobile

Chrome-plated finish, welded center. **Imported.**

Item No.	Socket Sizes	Length	Stock	Weight
35630	17 mm (11/16"), 19 mm (3/4"), 21 mm (13/16"), 22 mm (7/8")	20" 51 cm	5/8" 16 mm	3.7 lbs 1.7 kg
35635	17 mm (11/16"), 19 mm (3/4"), 21 mm (13/16"), 22 mm (7/8")	14" 36 cm	5/8" 16 mm	2.6 lbs 1.2 kg

Folding Passenger Car

Vehículo de pasajeros con asientos plegables

Voiture automobile, pliable

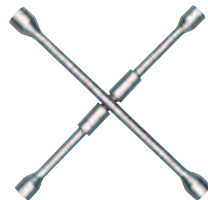

Chrome-plated finish. **Imported.**

Item No.	Socket Sizes	Length	Stock	Weight
35633	17 mm (11/16"), 19 mm (3/4"), 21 mm (13/16"), 22 mm (7/8")	14" 36 cm	9/16" 14 mm	2.7 lbs 1.2 kg

Telescoping Passenger Car

Automóvil de pasajeros con asientos extensibles

Voiture automobile, télescopique



Chrome-plated finish. **Imported.**

Item No.	Socket Sizes	Length	Weight
35634	17 mm (11/16"), 19 mm (3/4"), 21 mm (13/16"), 23 mm (7/8")	14" - 21" 36 cm - 53 cm	3 lbs 1.4 kg

Passenger Car

Vehículo de pasajeros

Automobile

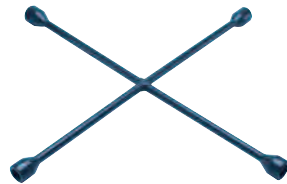

Painted finish, welded center.

Item No.	Socket Sizes	Length	Stock	Weight
35637	17 mm (11/16"), 19 mm (3/4"), 21 mm (13/16"), 22 mm (7/8")	18" 46 cm	9/16" 14 mm	3.6 lbs 1.6 kg

Light Truck/RV

Camión liviano/ vehículo de recreación

Camionnette/VR

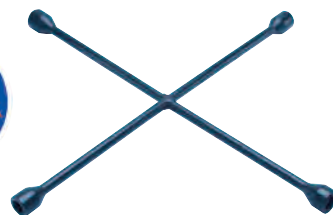

Painted finish, welded center.

Model	Item No.	Socket Sizes	Length	Stock	Weight
R90	35627	7/8", 15/16", 1", 1-1/16"	23" 58 cm	11/16" 17.5 mm	5.5 lbs 2.4 kg
	35638	22 mm (7/8"), 24 mm (15/16"), 25 mm (1"), 27 mm (1-1/16")	23" 58 cm	11/16" 17.5 mm	5.6 lbs 2.5 kg

Top Seller

Power Wrench

Llave eléctrica

Clé à chocs



TR44SW Set

Designed for dual nut systems. Has 13/16" sq. end to hold inner nut, with a 1-1/2" hex drive to spin outer nut off. Also adaptable to remove any nut size with a **TR55** adapter. 3-to-1 ratio provides mechanical power advantage necessary to remove any stubborn nut found on trucks, farm vehicles, buses, aircraft, and RV's. Tremendous power allows one man operation. Heat-treated portable components for extra strength. All sockets are 3/4" drive.



Set No. TR43 (34543) Basic Power Wrench Set

Juego de llaves eléctricas básicas

Jeu de clés à chocs de base

Weight: 19 lbs. (8.6 kg)

Set contains:

Power Drive

TR45 (34543-02) 20-1/2" (52 cm) Bar Handle

TR46 (34543-03) 20" (51 cm) Tube Handle

Set No. TR44X (34545) Budd-Wheel Power Wrench Set

Juego de llaves eléctricas para ruedas tipo Budd

Jeu de clés à chocs pour roues à disque

The 3/4" service adapter allows you to use any 3/4" drive socket.

Drive end is 1-1/2" hex. 13/16" square adapter for inner nut.

Weight: 20 lbs. (9.1 kg)

Set contains:

Power Drive

TR45 (34543-02) 20-1/2" (52 cm) Bar Handle

TR52 (34543-15) 13/16" Sq. Adapter

TR53 (34543-16) 36" (91 cm) Tube Handle

TR55 (34543-17) 3/4" Service Adapter

Set No. TR44SW (34547) Universal Power Wrench Set

Juego de llaves eléctricas universales

Jeu de clés à chocs universelles

Weight: 29 lbs. (13.2 kg)

Set contains:

Power Drive

TR45 (34543-02) 20-1/2" (52 cm) Bar Handle

TR53 (34543-16) 36" (91 cm) Tube Handle

TR52 (34543-15) 13/16" Square Adapter

TR55 (34543-17) 3/4" Service Adapter

Impact sockets:

S20 (30128) 7/8"

S24 (30136) 1-1/8"

S21 (30130) 15/16"

S25 (30138) 1-3/16"

S23 (30134) 1-1/16"

S33 (30133) 33 mm

For more information visit us at www.kentool.com

Double-End Truck Wrenches

Llaves dobles para camiones

Clés à double tête pour camions



Use on trucks, buses, farm, and off-road vehicles. Great for on-the-road service. Sizes available for all SAE and metric lug nuts. All wrenches are forged from 1" alloy steel for long lasting strength. Length: 16" (41 cm). Use **TR5** truck wrench handle.

SAE • SOCIEDAD DE INGENIEROS AUTOMOTRICES (SAE)

Model	Item No.	Sockets Sizes	Weight
TR1	32501	1-1/8" with 13/16" Sq. x 1-1/2"	4.6 lbs (2 kg)
TR2	32502	1" with 5/8" Sq. x 1-1/4"	4.3 lbs (1.9 kg)
TR3	32503	7/8" x 1-1/16"	4.5 lbs (2 kg)
TR3A	32505	1-1/16" x 1-1/8"	4.5 lbs (2 kg)
● TR3X	32506	1-3/16" x 1-1/16" 1-3/4" Stud Depth	4.6 lbs (2 kg)
TR98	32508	1-1/2" x 13/16" Sq.	4.5 lbs (2 kg)
TR9	32509	1-1/4" x 1-1/16"	4.4 lbs (2 kg)

Caterpillar and Bobcat equipment, and hub piloted wheels.

TR2A	32512	1" with 5/8" sq x 1-3/16"	4.5 lbs (2.0 kg)
-------------	--------------	---------------------------	------------------

METRIC • MÉTRICO • MÉTRIQUE

Model	Item No.	Sockets Sizes	Weight
TRM2	32552	24 mm x 33 mm	4.4 lbs (2 kg)
● TRM3	32553	27 mm x 30 mm 1-3/4" Stud Depth	4.6 lbs (2 kg)
TRM6	32556	21 mm sq. x 41 mm	4.5 lbs (2 kg)
● TRM7	32557	30 mm x 33 mm 1-3/4" Stud Depth	4.6 lbs (2 kg)

Metric inner and outer Budd nuts, and hub piloted wheels.

TRM6A	32559	33 mm with 21 mm sq x 41 mm	4.5 lbs (2 kg)
--------------	--------------	-----------------------------	----------------

● Updated with longer stud clearance – 1-3/4" stud depth

SAE / METRIC

SAE inner and outer Budd nuts, and hub piloted wheels.

Model	Item No.	Sockets Sizes	Weight
TR99	32519	33 mm with 13/16" sq x 1-1/2"	4.5 lbs (2 kg)

Heavy-Duty Truck Wrench

Llaves para camiones de alta resistencia

Clé robuste pour camions



Use for off-the-road Budd-type wheels. Use **TR11** handle. Long length provides extra leverage. Stock: 1-1/4" (3.1 cm)

Model	Item No.	Length	Socket Size	Weight
TR10	34401	29-1/2" (75 cm)	1-3/4" Hex & 15/16" sq.	12.2 lbs (5.5 kg)

Truck Wrench Handle

Mango de llave para camiones

Manche de clé pour camions



Heat-treated for strength and durability. Fits all Ken-Tool Double-end truck wrenches



Model	Item No.	Length	Stock	Weight
● TR5	32318	22" (56 cm)	3/4" Hex	3 lbs (1.4 kg)
TR11	34402	30" (76 cm)	1" Round	6.7 lbs (3 kg)
TR5A	32319	30" (76 cm)	3/4" Hex	4 lbs (1.8 kg)

Extra Leverage 1-1/2" Lug Nut Wrench

Llave de tuercas de rueda de 1-1/2"

con mayor palanca

Clé pour écrou de roue de 1,5 po à effet de levier supplémentaire

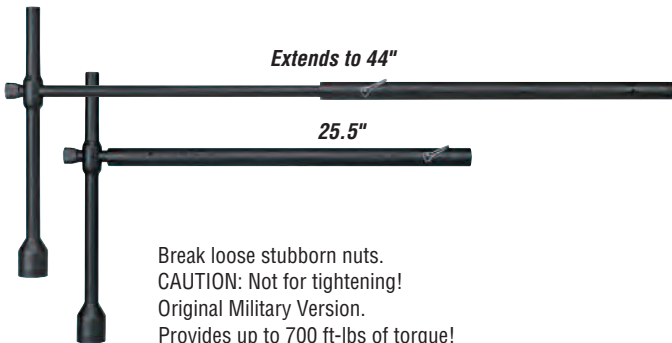

Extends to 44"

25.5"

Break loose stubborn nuts.
CAUTION: Not for tightening!
Original Military Version.
Provides up to 700 ft-lbs of torque!

Item No.	Length	Socket Size	Weight
NEW 34420	25.5" (64.7 cm)	1.5" Hex (3.8 cm)	14 lbs (6.4 kg)
	44" Extended (111.7 cm)	1.24" Depth (3.1 cm)	

Wrench Support Stand

Base de soporte para llave

Support de soutien pour clé



Commercial-duty stand used to support a double-end truck wrench, a 4-way lug wrench, or a torque wrench, when removing or replacing lug nuts. Adjusts from 14-1/2" to 22-1/2" high. Rated to 300 pounds.



Wrench Support Stand

Item No.	Weight
32610	5.5 lbs (2.5 kg)

No-Mar Rim Guard™

Tapa para llantas No-Mar

Protection de jante antimarque

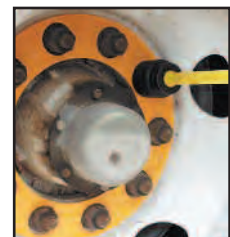
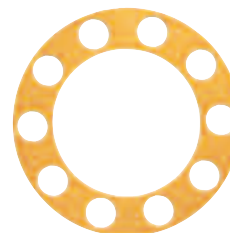

Protective cover prevents damage to chrome and aluminum rims and wheels when removing or replacing lug nuts. Imprinted with torque sequence number for proper torquing of disc wheels. **Imported from Canada.**

Item No.	Description	Weight
30605	Protective plastic cover	.5 lbs (.2 kg)

Ken-Tool®
WHEREVER TIRES ARE CHANGED™

TPMS Sensor Hardware Service Set

Juego de servicio de sensores TPMS

Ensemble d'entretien matériel des capteurs TPMS



NO MORE GUESSING!
All of the hardware needed to service most domestic and import TPMS sensors!

Versatile 150-pc assortment (15 unique kits) covers 90-95% of TPMS-fitted vehicles

Each Hardware Kit contains a valve core, valve cap, grommet ferrule nut, gaskets, washers and valve stem (contents specific to each application). **Plus 50 extra** TPMS approved nickel plated valve cores and **50 extra** approved plastic caps.

Replacement Hardware Kits Available From Ken-Tool.

Set No. 30001 Weight: 6 lbs (2.7 kg)

150 Pc. Set with 3" x 9" x 16" Portable Poly Case Includes:



Includes 30209 TPMS Sentry™ Sensor Service Tool

<p>30010</p> <p>Infiniti, Mitsubishi, Nissan</p> <p>Qty 10</p>	<p>30013</p> <p>Cadillac, Chevy, Chrysler, Dodge, Infinity, Isuzu, Jeep, Mitsubishi, Nissan, Subaru</p> <p>Qty 10</p>
<p>30019</p> <p>Audi, VW</p> <p>Qty 10</p>	<p>30021</p> <p>Acura, Honda, Hyundai, Kia</p> <p>Qty 10</p>
<p>30024</p> <p>GMC, Hummer, Lexus, Toyota, VW</p> <p>Qty 10</p>	<p>30026</p> <p>Buick, Cadillac, Chevy, Chrysler, Dodge, Ford, GM, GMC, Hummer, Jeep, Lincoln, Mazda, Mercury, Pontiac, Saturn, Subaru, Suzuki</p> <p>Qty 10</p>
<p>30041</p> <p>Saab, Saturn, Suzuki, Volvo</p> <p>Qty 10</p>	<p>30042</p> <p>Chrysler, Dodge, Infiniti, Jeep, Mercedes-Benz, Mitsubishi, Nissan, Smart Car</p> <p>Qty 10</p>
<p>30010</p> <p>Infiniti, Mitsubishi, Nissan</p> <p>Qty 10</p>	<p>30013</p> <p>Cadillac, Chevy, Chrysler, Dodge, Infinity, Isuzu, Jeep, Mitsubishi, Nissan, Subaru</p> <p>Qty 10</p>
<p>30019</p> <p>Audi, VW</p> <p>Qty 10</p>	<p>30021</p> <p>Acura, Honda, Hyundai, Kia</p> <p>Qty 10</p>
<p>30024</p> <p>GMC, Hummer, Lexus, Toyota, VW</p> <p>Qty 10</p>	<p>30026</p> <p>Buick, Cadillac, Chevy, Chrysler, Dodge, Ford, GM, GMC, Hummer, Jeep, Lincoln, Mazda, Mercury, Pontiac, Saturn, Subaru, Suzuki</p> <p>Qty 10</p>
<p>30041</p> <p>Saab, Saturn, Suzuki, Volvo</p> <p>Qty 10</p>	<p>30042</p> <p>Chrysler, Dodge, Infiniti, Jeep, Mercedes-Benz, Mitsubishi, Nissan, Smart Car</p> <p>Qty 10</p>

Also available separately: • También disponible por separado: • Également disponible séparément :



Item No.	Description	Torque Limit
30060	Valve Core Torque Driver	4 in-lbs
30070	1/4"-drive Variable Ratcheting Torque Wrench	30-150 in-lbs
30080	11mm Deep Socket, 1/4"-drive	
30081	12mm Deep Socket, 1/4"-drive	
30090	Torque Driver & T-10/T-15 TORX® bits	12 in-lbs

Over 3.5 million test miles!



reCore®

TPMS Sensor Saver System
Sistema de reparación de sensores TPMS
Système d'économiseur de capteurs TPMS



Galvanic corrosion causes TPMS failures.

Now you can repair TPMS Sensors without even taking the tires off the vehicle!

PATENTED

Ken-Tool's Patented reCore® Starter Kit (#29980) includes everything you need to service your TPMS Sensor replacement customers: 12 TPMS Sensor Savers, TPMS Valve Core Torque Tool (preset at 4-in-lbs), High Speed Dual Cutter Countersink Drill Bit, Tap, Tap Holder with T-handle, Bottle of Ken-Lok™ Thread Sealant, Easy to follow instructions, Blow-molded plastic storage case.

12-Piece Starter Kit #29980	If Your Per-Sensor Repair Fee Is:		
	\$39	\$49	\$59
Kit Cost	\$199	\$199	\$199
Revenue	\$468	\$588	\$708
Per kit Profit	\$269	\$389	\$509
Profit per Sensor	\$22.42	\$32.42	\$42.42
Your Profit % Is	57%	66%	72%

reCore®

TPMS Sensor Saver Refill Kit
Kit de repuestos para reparación de sensores TPMS
Kit de rechange pour économiseur de capteurs TPMS



Ken-Tool's Patented reCore® Refill Kit (#29981) includes 25 TPMS Sensor Savers plus a fresh Tap.

PATENTED

25-Piece Refill Kit #29981	If Your Per-Sensor Repair Fee Is:		
	\$39	\$49	\$59
Refill Set Cost	\$199	\$199	\$199
Revenue	\$975	\$1225	\$1475
Per Set Profit	\$776	\$1026	\$1276
Profit per Sensor	\$31.04	\$41.04	\$51.04
Your Profit % Is	80%	84%	87%



For product demo visit **Kentool.com/recore** or scan the QR code with your mobile device.

For a **FREE reCore System** training DVD, email us at reCoreDVD@kentool.com

Item No.	Description	Weight
29980	reCore™ TPMS Sensor Saver System	5 lbs (2.3 kg)
29981	reCore™ TPMS Sensor Saver Refill Kit	.5 lbs (.2 kg)

TIRE & WHEEL SERVICE CENTERS

Featuring Ken-Tool's most popular tire tool products!



**Eye-catching 15" x 17" full color display card with photos and descriptions!
Convenient mobile base makes positioning for optimum sales a breeze!**

Besides featuring Ken-Tool's most popular tire tool products, these new merchandisers attract attention! Featuring large 15" x 17" color display cards at eye level with high-res color photos and descriptions of some of our best selling products. Each photo has a box so that a 1" x 2.5" barcode price label can be added.

The sturdy 12" x 16" freestanding, powder-coated wire rack features bright color graphics to let your customers know they are buying Ken-Tool's professional quality tire tools and lug wrenches. Included at no extra cost is a 3" high 4-wheel dolly with strong and durable caster wheels to enable the loaded rack to be easily moved to different locations and to facilitate floor cleaning. The rack and dolly take up a small 15" x 16" footprint and can be placed on the floor or, without the dolly, on a standard 18" gondola base shelf.

Tire & Wheel Service Center No. 36047

Centro de mantenimiento para ruedas y llantas No. 36047

Centre de service pneus et roues no 36047

- **Set No. 36047** Weight: 125 Lbs (57 kg) Shipped in 5 boxes.

Set Includes:

Item No.	Description	Quantity
35110	18" 35110 USA Hickory Tire Knocker	2
32119	24" T19 Straight Tire Spoon	2
33220	30" T20A Curved Tire Spoon	2
34645	37" T45A® Tubeless Tire Iron	2
34645C	37" T45AC® Classic Tubeless Tire Iron	2
34647	41" T45HD HD Tubeless Tire Iron	2
34747	36" T46A Tubeless Tire Iron	2
35323	16-1/2" T35 HD Tire Hammer, Wood Handle	1
35429	32" TG11E Bead Breaking Wedge, Fiberglass Handle	1
35637	18" 35637 Passenger 4-Way Lug Wrench, SAE/Metric	2
35638	23" 35638 Light Truck/RV 4-Way Lug Wrench, SAE/Metric	2
35595	27" TC95 HD Truck Lug Wrench, Popular Lug Sizes	1
30721	Wire Rack with Roller Base	1
36047-98	Planogram Card with Tie Strap	1

Passenger Tire & Wheel Service Center No. 36049

Centro de mantenimiento para ruedas y llanta de automóviles No. 36049

Centre de service pneus et roues pour occupant no. 36049

- **Set No. 36049** Weight: 120 Lbs (54 kg) Shipped in 4 boxes.

Set Includes:

Item No.	Description	Quantity
33220	30" T20A Curved Tire Spoon	2
34645	37" T45A® Tubeless Tire Iron	2
35429	32" TG11E Bead Breaking Wedge, Fiberglass Handle	1
34645C	37" T45AC® Classic Tubeless Tire Iron	2
34747	36" T46A Tubeless Tire Iron	2
35110	18" 35110 USA Hickory Tire Knocker	2
35620	20" T9520 4-Way Lug Wrench	1
35657	23" T57 4-Way Lug Wrench	1
35659	22" T59 4-Way Lug Wrench	2
35663	18" T63 Metric 4-Way Lug Wrench	1
34647	41" T45HD HD Tubeless Tire Iron	2
30721	Wire Rack with Roller Base	1
36047-98	Planogram Card with Tie Strap	1

● **Top Seller**



Professional Tire Tool and Lug Wrench Merchandisers

Comerciantes de llaves y herramientas para llantas profesionales
Présentoirs de clés à goujon et de démonte-pneus professionnels



35648

Ken-Tool offers a simple, yet effective way to merchandise our top products. With assortment #36046 you get 15 of our best selling tools. Assortment #36045 offers a larger assortment of 20 equally fast-selling tire and wheel service tools. Both assortments come complete with a sturdy, freestanding wire rack (no assembly required). The graphics on the front of the rack let your customer know they're buying professional quality tire tools and lug wrenches from Ken-Tool while the userfriendly design of the rack lets you know you found the solution to displaying Ken-Tool products. Both the wire rack and planogram card can be purchased separately.

10 Piece Lug Wrench Assortment with rack No. 35649

10 piezas. Surtido de llaves para ruedas con soporte No. 35649
Jeu de clés à goujon avec râtelier de 10 pièces no 35649

Set No. 35648 Weight: 50 Lbs (23 kg). **Set Includes:**

Item No.	Description	Quantity
35620	20" T9520 4-Way Wrench	2
35636	23" T56 Deluxe Metric 4-Way Wrench	1
35657	23" T57 4-Way Lug Nut Wrench	2
35659	22" T59 4-Way Lug Nut Wrench	2
35663	18" T63 Metric 4-Way Wrench	1
35690	25" T90 4-Way Wrench - Truck	2
35649	Empty Display Stand	1



36045

Deluxe Tire & Wheel Service Center No. 36045

Centro de mantenimiento para ruedas y llantas de lujo No. 36045
Centre de service de luxe pneus et roues no 36045

Set No. 36045 Weight: 128 Lbs (58 kg). **Set Includes:**

Item No.	Description	Quantity
32318	22" TR5 Truck Wrench Handle/Leverage Bar	2
32501	16" TR1 1-1/8" Hex with 13/16" Sq. x 1-1/2" Hex Double-End Wrench	1
32508	16" TR98 1-1/2" Hex x 13/16" Sq. Double-End Wrench	1
32509	16" TR9 1-1/4" Hex x 1-1/16" Hex Double-End Wrench	1
32552	16" TRM2 24 mm x 33 mm Double-End Wrench"	1
33220	30" T20A Curved Tire Spoon	2
33223	30" T23A Truck Lock Ring Removal Tool	1
34645	37" T45A Truck Tire Mount/Demount Iron	2
34647	41" T45HD Truck Tire Mount/Demount Iron	1
35229	31" TG11EH Fiberglass Replacement Handle (fits 35429)	1
35323	16.5" T35 Hickory Handled Tire Hammer	1
35429	32" TG11E Fiberglass Handled Bead Breaking Wedge	1
35690	25" T90 Light Truck 4-Way, Welded - SAE	2
35595	27" TC95 Heavy-Duty Truck 4-Way, Drop-Forged - SAE	2
35924	46" T24B Slide-Action, Impact Bead Breaker	1
30720	Wire Rack	1
36045-10	Planogram Card with Tie Strap	1



36046

Tire & Wheel Service Center No. 36046

Centro de mantenimiento para ruedas y llantas No. 36046
Centre de service pneus et roues no 36046

Set No. 36046 Weight: 73 Lbs (33 kg). **Set Includes:**

Item No.	Description	Quantity
32116	16" Small Tire Mount/Demount Spoon	2
33220	30" T20A Curved Tire Spoon	1
33223	30" T23A Truck Lock Ring Removal Tool	1
34645	37" T45A Truck Tire Mount/Demount Iron	2
35129	30" T11EH Hickory Replacement Handle (fits 35329)	1
35229	31" TG11EH Fiberglass Replacement Handle (fits 35429)	1
35429	31" TG11E Fiberglass Handled Bead Breaking Wedge	1
35620	20" T9520 Economy Passenger Car 4-Way - SAE	1
35657	23" T57 Professional Gold Passenger Car 4-Way - SAE	1
35659	22" T59 Professional Passenger Car 4-Way - SAE	1
35663	18" T63 Economy Passenger Car 4-Way - Metric	1
35690	25" T90 Light Truck 4-Way, Welded - SAE	1
35695	27" T95 Heavy-Duty Truck 4-Way, Drop-Forged - SAE	1
30720	Wire Rack	1
36046-10	Planogram Card with Tie Strap	1

Tire Inflation Cages

Cajas para inflado de llantas

Cages de sécurité pour gonflement de pneus



Mandatory for any shop working with tubeless and multi-piece rims. Made from heavy-gauge steel tubing welded to a steel base. Guards against blown lock rings and rims. Follow OSHA regulation 29-CFR Part 1910.177. Read safety label on cage. Designed to meet OSHA regulation requirements for Medium, Heavy-Duty Truck, OTR, Tractor, and Super Singles.

Ken-Tool offers sizes and designs for all your needs. For additional safety labels or instructions, call Ken-Tool customer service.

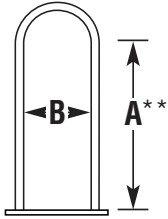

**** For reference only. Height A refers to the approximate height to the inside bend of the cage. May accommodate taller tires.**



Why Tire Cages are Important



Work safely. Always use an inflation cage when inflating tires. Follow OSHA regulation 29-CFR Part 1910.177 whenever changing tires.

Passenger and Light Truck Cage

Jaula para camión liviano y para pasajeros

Cabine passager et véhicule utilitaire léger

A must for run-flat, low-profile, and other tires that are difficult to seat.



Model	Item No.	Height A**	Width B	Base	Height	Max. PSI	Weight
T103	36003	30"	16"	21-1/2" x 22"	40-1/2"	130	80 lbs
		76 cm	41 cm	55 cm x 56 cm	103 cm		36.2 kg

Portable Wide Base and Standard 2-Bar Cages

Caja de dos barras con base amplia portátil

Cage portative à deux barres, à base large



Designed for wide base truck tires, the T101A portable inflation cage will hold super singles, and super wide radial tires. Fits comparable tires up to: 455/55R22.5. T101 fits standard truck tires.

Model	Item No.	Height A**	Width B	Base (closed)	Height	Max. PSI	Weight
● T101A	36007	43-1/2"	20-1/2"	7" x 27"	56-1/2"	130	72 lbs
		111 cm	52 cm	18 cm x 69 cm	143 cm		32.6 kg
● T101	36001	41"	16"	7" x 21-1/2"	51-1/2"	130	60 lbs
		104 cm	41 cm	18 cm x 55 cm	131 cm		27.2 kg

Truck and Off-Road Tire Inflation Cages

Jaulas para inflado de llantas de camiones y vehículos todo terreno

Cages de gonflage de pneu camion et tout-terrain



36002
4-Bar Cage
Caja de 4 barras
Cage à 4 barres

36005
5-Bar Cage
Caja de 5 barras
Cage à 5 barres

36006
3-Bar Cage
Caja de 3 barras
Cage à 3 barres

36008
NEW 7-Bar Cage
Caja de 7 barras
Cage à 7 barres



Item Model No.	Description	Height A**	Width B	Base	Height	Max. PSI	Weight
● T102	36002 4-Bar Cage	43-1/2" 111 cm	20-1/2" 52 cm	31-1/2" x 26" 80 cm x 66 cm	56-1/2" 143 cm	130	146 lbs 66.2 kg
T105	36005 5-Bar Cage	43-1/2" 111 cm	20-1/2" 52 cm	41" x 26" 104 cm x 66 cm	56-1/2" 143 cm	130	182 lbs 82.5 kg
T106	36006 3-Bar Cage	43-1/2" 111 cm	20-1/2" 52 cm	26" x 22" 66 cm x 56 cm	56-1/2" 143 cm	130	134 lbs 60.7 kg
● T108	36008 7-Bar Cage	46" 117 cm	29" 74 cm	34" x 56" 86 cm x 142 cm	63" 160 cm	130	485 lbs 220 kg

Tall 3-Bar Cage (OTR and Farm)

Caja de 3 barras (de carretera/vehículos de granja)

Cage à 3 barres (pneus tout terrain/tracteurs)



Model	Item No.	Height A**	Width B	Base	Height	Max. PSI	Weight
T104	36004	65" 165 cm	24" 61 cm	30" x 27" 76 cm x 69 cm	77-1/2" 197 cm	130	158 lbs 72.6 kg

Magnum™ Tire Inflation Cages

Jaulas para inflado de llantas Magnum™

Cages de gonflage de pneu Magnum™

Designed to accept the new generation of Super Single and Super Wide-Base truck tires with their higher inflation pressures and air volumes.

Magnum™ 5-Bar Cage

Caja de 5 barras Magnum

Cage à 5 barres Magnum

36009



Magnum™
EZ Tire
Rotator
with ramp.
(see page 37)

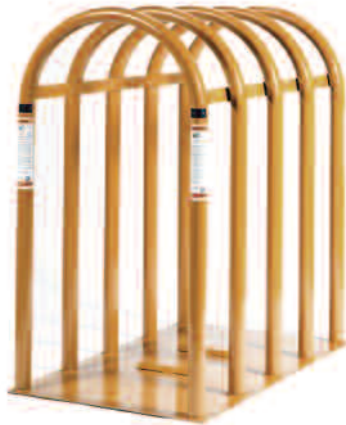

NEW SuperMagnum™ 5-Bar Cage

Caja de 5 barras SuperMagnum

Cage à 5 barres SuperMagnum

36010

*SuperMagnum™ Item No. 36010
with steel mesh diffuses 93% of
blast force from zipper rupture!*

Portable Magnum™ 2-Bar Cage

Caja de 2 barras portátil Magnum

Cage portative à 2 barres Magnum

36019



Magnum™ & SuperMagnum™
Zipper Explosion Tests



Earthmover Tire Inflation Cages

Jaula de inflado para neumáticos de excavadoras

Cage de gonflage de pneu d'engin de génie civil

HD all steel cages protect workers, equipment and facilities.
For large Earthmover & Agricultural tires.

NEW 10-Bar Cage

Caja de 10 barras

Cage à 10 barres

New patented design
with 10-bar construction.
Fits up to 29.5R25 L-3
Earthmover.

36011

PATENTED



NEW 12-Bar Cage

Caja de 12 barras

Cage à 12 barres

New 12-bar design fits
wheels 87" total height
by 48" wide!

36012



YouTube



Watch our
EXPLOSION
TESTING VIDEO
at 150-psi on
www.kentool.com



Item	Height	Width	Max.
Model No.	A**	B	PSI
T109 36009 5-Bar Magnum™	41-1/2" 105 cm	24-1/2" 62 cm	48" x 30" 122 cm x 76 cm
NEW T110 36010 5-Bar	41-1/2" 105 cm	24-1/2" 62 cm	48" x 30" 122 cm x 76 cm
SuperMagnum™	105 cm	62 cm	122 cm x 76 cm
T119 36019 2-Bar Portable Magnum™	49-1/2" 126 cm	24-1/2" 62 cm	7" x 30" closed 18 cm x 76 cm
			64" 163 cm
			80 lbs 36.2 kg

Model	Item No.	Height A**	Width B	Base	Height	Max. PSI	Weight
NEW T111 36011		77-1/2" 193 cm	42" 107 cm	72" x 48" 183 cm x 122 cm	90-1/2" 230 cm	100	820 lbs 372 kg
NEW T112 36012		80" 203 cm	60" 152 cm		99-1/2" 253 cm	100	1,100 lbs 499 kg

TIRE INFLATION CAGES:

WARNING: Tire changing can be dangerous, and should be done only by trained personnel using proper tools and equipment as directed by Federal OSHA Standard No. 29 CFR Part 1910.177. Tires may explode during inflation causing injury to operator or bystander. Wear safety goggles. Keep all parts of body outside cage. Use extension hose, clip-on chuck, and remote valve. See supervisor for safety procedures.

WARNING: Do not alter cage in any way. Cage must be freestanding and at least three feet from other objects. Discard cage if bent, cracked, or otherwise damaged. Always wear safety goggles.

Truck Tire Changing Stand

Soporte para cambio de llantas de camiones
Support de démontage pour pneus de camions



Stand handles wheels or open rims 16.5" to 24". Double-slide adjustment with locking device prevents twisting so it stays aligned with the wheel or rim. Stand is the ideal height for driving off beads or demounting tires. It must be used to be appreciated.

Model	Item No.	Weight
T115	36015	21 lbs (9.5 kg)

Easy-Lift™ Bead Seating Stand

Soporte para calzado de talón Easy-Lift™
Poste de portée de talon Easy-Lift™

SAFETY FIRST!

ERGONOMIC:
Easy operation with less back strain. Makes concentric bead seating safe and easy!



EasyLift™
Bead Seating Stand



PATENTED



Push tubeless assembly onto crown – tire and wheel will automatically fall onto center of stand and rest with bead centered on bottom wheel flange



After seating bead step around stand and easily lift assembly into vertical position

ERGONOMIC: Reduces back strain while handling 22.5" tubeless tire & wheel assemblies. Aligns beads concentrically on wheel for improved ride & longer tire life. Portable for field service, or can be bolted to the floor. Made of high grade steel. Length: 24" high x 26" wide x 27" long.

Model	Item No.	Description	Weight
T116	36016	Standard Crown for 8-3/4" diameter hubs	36 lbs (16.4 kg)
T117	36017	Large Crown for 11" Euro hubs	37 lbs (16.8 kg)

EZ Tire Rotator™

Rotador de neumáticos EZ Tire Rotator™
Rotateur de pneu EZ Tire Rotator™



Quickly rotate assembly inside cage for easy valve access
— no more hassle!

Reduces handling, back strain and user fatigue; increases safety. Easily installed or moved to another cage – no fastening required. No assembly required, simply place in the center of the cage. Works as a portable tread inspection and stone removal station outside of cage. Features heavy-duty 2" ball-bearing steel rollers and 1-1/4" thick steel stock for long service. Boxed and UPS shippable.

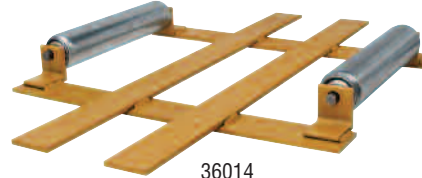

36014
PATENTED



Fits any Ken-Tool® 3-Bar, 4-Bar and 5-Bar Inflation Cage,
plus many competitive cages

Model	Item No.	Description	Length	Weight
NEW T114	36014	EZ Tire Rotator™	17-1/2" x 25-1/2" (44.5 cm x 64.8 cm)	16 lbs (7.3 kg)

EZ Tire Rotator™ with Ramp

Rotador de neumáticos EZ Tire Rotator™ con rampa
Rotateur de pneu EZ Tire Rotator™ avec rampe

Model	Item No.	Description	Length	Weight
NEW T118	36018	EZ Tire Rotator™ with Ramp	25" x 25" (64 cm x 64 cm) x 2-5/8" (6.6 cm)	21 lbs (9.5 kg)

Magnum EZ Tire Rotator™ with Ramp

Rotador de neumáticos Magnum EZ Tire Rotator™ con rampa
Rotateur de pneu Magnum EZ Tire Rotator™ avec rampe



36013
PATENTED

Fits Ken-Tool®

Magnum and SuperMagnum Inflation Cages
(see page 36)

Ramp lifts tire onto rollers with ease.



Model	Item No.	Description	Length	Weight
NEW T113	36013	Magnum EZ Tire Rotator™ with Ramp	25" x 28" (64 cm x 71 cm) x 2-5/8" (6.6 cm)	22 lbs (10 kg)

Have a new idea? E-mail sales@kentool.com



BEARING & ROTOR PULLING SYSTEM
SISTEMA DE TRACCIÓN DE ROTORES Y RODAMIENTOS
SYSTÈME D'EXTRACTION DE
ROTORS & DE COUSSINETS

Includes everything you need to do the job!



HubShark® Demo

Replace the front wheel bearings on front wheel drive vehicles without removing the steering knuckle from the vehicle – in about 20 minutes per wheel.

- **Keep more jobs in house - don't send bearings out to be machine pressed**
- **Save time and money with reduced down time**
- **Pull and press any hub or bearing on domestic and import vehicles**
- **Pull inner bearing race from the hub**
- **Done completely on vehicle - no need to remove the knuckle assembly and re-align the front end**
- **Always be sure the center screw thread is clean and well lubricated**
- **Always wear safety goggles**
- **See www.kentool.com for instruction manual and parts list**

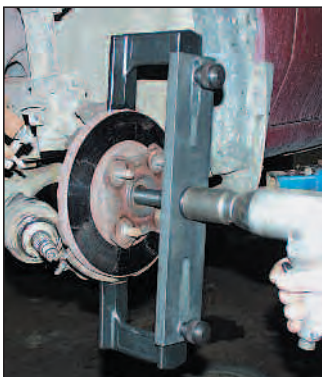
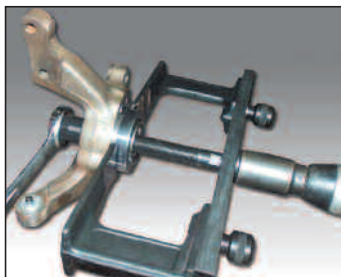
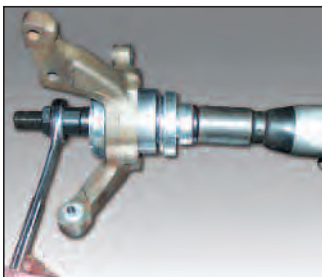

Item No.	Description	Weight
7326	Pro Super Hub-Shark System®	58 lbs (26.3 kg)

No. 7326U Upgrade Kit available for previous Hub-Shark™ owners (case included)

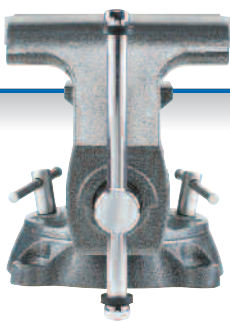

Vises

All of Ken-Tool's Professional Vises feature:

- 360° swivel base
- Machined base plate for smooth swivel
- Heavy-duty jaw beam covers screw
- Built-in anvils



- Jaw faces have "V" notches for vertical gripping



- Built-in pipe jaws

- "V" notched, replaceable/reversible jaws made of carbon steel and heat-treated for extra strength, diamond cut on one side - smooth on the other

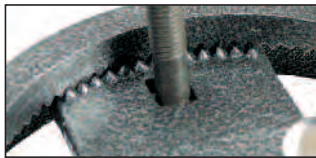

- Gear-type locking system with double lock-down bolts - locks vise securely in position

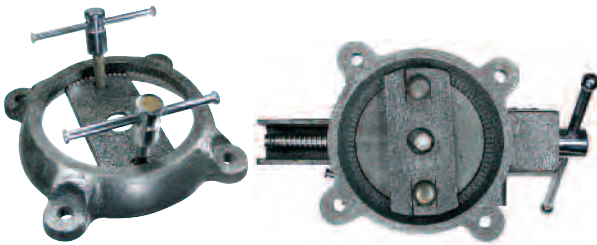

Professional Reversible Mechanic's Vises feature:

It's simple...Remove the jaw from the front of the base, swivel the base 180°, then re-insert the jaw:

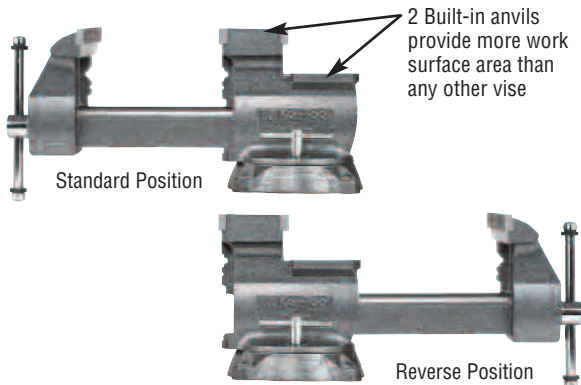

Professional Mechanic's Vises

Tornillos de banco para taller profesionales

Étaux pour ateliers professionnels



K65 6-1/2"

With high quality construction for extra durability and full-strength performance at any jaw opening, these vises are made for the professional - strong, durable, and built to last.

Model	Item No.	Jaw Width	Jaw Opening	Throat Depth	Pipe Jaw Capacity	Weight	Replacement Jaw Set No.
● K55	64055	5-1/2" 14 cm	7-1/2" 19.1 cm	3-1/4" 8.3 cm	1/8" - 2-1/2" .3 - 6.4 cm	27 lbs 12.3 kg	15505
● K65	64065	6-1/2" 16.5 cm	9" 22.9 cm	3-7/8" 9.8 cm	1/8" - 3-1/2" .3 - 8.9 cm	38 lbs 17.3 kg	16505

Professional Reversible Mechanic's Vises

Tornillos de banco reversibles para mecánicos profesionales

Étaux professionnels réversibles de mécanicien

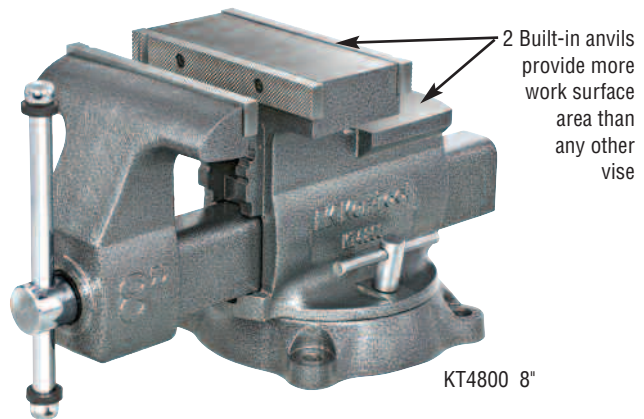

KT4800 8"

With our Reversible Vises you get all of the high quality features and rugged durability of the Pro Workshop Vises, and more! Significantly increase your gripping capacity when you reverse the position of the front jaw.

Model	Item No.	Jaw Width	Jaw Opening	Throat Depth	Pipe Jaw Capacity	Weight	Replacement Jaw Set No.
● KT4650	64650	6-1/2" 16.5 cm	9" - 12" 22.9 - 30.5 cm	4" 10.1 cm	1/8" - 4" .3 - 10.1 cm	52 lbs 23.6 kg	14655
● KT4800	64800	8" 20.3 cm	11 - 14" 28 - 35.6 cm	4-7/8" 12.4 cm	1/8" - 4-1/4" .3 - 10.8 cm	74 lbs 33.6 kg	14805

Professional C-Clamps

Abrazaderas en C profesionales

Serre-joints en C professionnels

This c-clamp is for the professional. Designed for strength and toughness, with sliding pin handle and acme-thread screw. **Imported.**

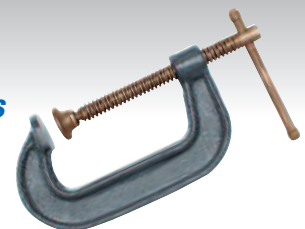

Model	Item No.	Jaw Opening	Depth	Screw Diameter	Weight
KT-4	39604	4" (10 cm)	2-1/16" (5 cm)	5/8" (1.5 cm)	1.8 lbs (.8 kg)
KT-6	39606	6" (15 cm)	2-3/4" (7 cm)	5/8" (1.5 cm)	2.5 lbs (1.1 kg)
KT-8	39608	8" (20 cm)	3-1/4" (8 cm)	3/4" (2 cm)	3.5 lbs (1.6 kg)



TORQUE MASTER® Torque Limiting Sockets

Llaves de tubo limitadoras del par motor principal • Douilles de limitation de couple TORQUE MASTER

For foreign and domestic cars and light trucks. Tighten nuts to factory specifications each time the wheels are replaced. Color and letter coded for quick size and torque reference. Converts any impact gun, including those with an extended anvil, into an instant torque wrench by bleeding torque off the impact gun. Application chart can be wall mounted. **Application Charts No. 30199 and No. 30299 are also available separately. Limited lifetime warranty.**



TORQUE MASTER®

Four Piece Starter Kit

Equipo básico de cuatro piezas

kit de base de quatre pièces

Set contains:

30181 - Brown (A)	100 ft/lbs.
30183 - Gray (C)	100 ft/lbs.
30185 - Blue (E)	80 ft/lbs.
30189 - White (I)	120 ft/lbs.

Item No.	Weight
30174	4.4 lbs (2 kg)



TORQUE MASTER® Six Piece Kit

Juego de seis piezas

Kit six pièces

Set contains:

30181 - Brown (A)	100 ft/lbs.
30183 - Gray (C)	100 ft/lbs.
30184 - Black (D)	60 ft/lbs.
30185 - Blue (E)	80 ft/lbs.
30186 - Yellow (F)	65 ft/lbs.
30189 - White (I)	120 ft/lbs.

Item No.	Weight
30176	6.9 lbs (3.1 kg)

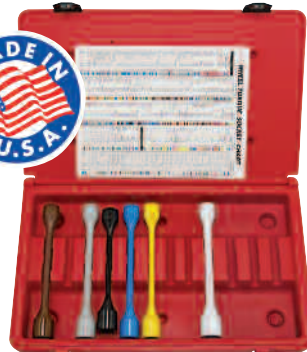

TORQUE MASTER® Nine Piece Kit

Juego de nueve piezas

Kit neuf pièces

Set contains:

30181 - Brown (A)	100 ft/lbs.
30182 - Orange (B)	80 ft/lbs.
30183 - Gray (C)	100 ft/lbs.
30184 - Black (D)	60 ft/lbs.
30185 - Blue (E)	80 ft/lbs.
30186 - Yellow (F)	65 ft/lbs.
30187 - Red (G)	80 ft/lbs.
30188 - Dark Green (H)	45 ft/lbs.
30189 - White (I)	120 ft/lbs.

Item No.	Weight
30179	8.75 lbs (4 kg)



TORQUE MASTER® Ten Piece Kit

Juego de diez piezas

Kit dix pièces

Set contains:

30181 - Brown (A)	100 ft/lbs.
30182 - Orange (B)	80 ft/lbs.
30183 - Gray (C)	100 ft/lbs.
30184 - Black (D)	60 ft/lbs.
30185 - Blue (E)	80 ft/lbs.
30186 - Yellow (F)	65 ft/lbs.
30187 - Red (G)	80 ft/lbs.
30188 - Dark Green (H)	45 ft/lbs.
30189 - White (I)	120 ft/lbs.
30200 - Aqua (Q)	140 ft/lbs.

Item No.	Weight
30180	9.5 lbs (4.3 kg)



TORQUE MASTER® Twelve Piece Kit

Juego de doce piezas

Kit douze pièces

Set contains:

30181 - Brown (A)	100 ft/lbs.
30182 - Orange (B)	80 ft/lbs.
30183 - Gray (C)	100 ft/lbs.
30184 - Black (D)	60 ft/lbs.
30185 - Blue (E)	80 ft/lbs.
30186 - Yellow (F)	65 ft/lbs.
30187 - Red (G)	80 ft/lbs.
30188 - Dark Green (H)	45 ft/lbs.
30189 - White (I)	120 ft/lbs.
30200 - Aqua (Q)	140 ft/lbs.
30202 - Navy Blue (Y)	100 ft/lbs.
30213 - Gold (NN)	90 ft/lbs.

Item No.	Weight
30190	10.5 lbs (4.8 kg)



TORQUE MASTER® Four Piece Torque Stick Set for SUV's Most Popular Sizes for Largest Growing Market

Juego de palancas de par motor de cuatro piezas para los tamaños más populares de vehículos todo terreno para el mayor mercado en crecimiento

Kit de quatre bras de torsion convenant aux VUS de dimensions les plus populaires idéal pour un marché de plus en plus grand

For domestic and foreign SUV's. Tighten lug nuts to factory specifications. Color and letter coded for quick size and torque reference.

Set contains:

30181 - Brown (A)	100 ft/lbs.
30183 - Gray (C)	100 ft/lbs.
30200 - Aqua (Q)	140 ft/lbs.
30204 - Turquoise (BB)	150 ft/lbs.

Item No.	Weight
30175	4.5 lbs (2 kg)



TORQUE MASTER® Torque Extension Kits

Juegos de extensiones para torque

Kits de rallonges de couple



Convert your own sockets into torque sockets.

TORQUE MASTER® Four Piece Extension Kit for Passenger Car - 1/2" Drive

Juego de extensión de cuatro piezas para automóviles de pasajeros - entrada de 1/2 pulgada

Kit de rallonge de quatre pièces pour automobiles - Prise 1/2 po

Set contains:

30223 - Gray (C)	100 ft/lbs
30225 - Blue (E)	80 ft/lbs
30226 - Yellow (F)	65 ft/lbs
30229 - White (I)	120 ft/lbs

Item No.	Weight
30234	3 lbs (1.3 kg)



TORQUE MASTER®

Five Piece Extension Kit for Passenger Car - 1/2" Drive

Juego de extensiones de cinco piezas para automóviles.

Cuadro de 1/2"

Kit (cinq pièces) de rallonges pour voitures - prise demi pouce

Set contains:

30220 - Aqua (Q)	140 ft/lbs.
30223 - Gray (C)	100 ft/lbs.
30225 - Blue (E)	80 ft/lbs.
30226 - Yellow (F)	65 ft/lbs.
30229 - White (I)	120 ft/lbs.

Item No.	Weight
30235	4 lbs (1.8 kg)



TORQUE MASTER®

Ten Piece Extension Kit for Passenger Car & Light Truck

Juego de extensiones de diez piezas para automóviles y camiones livianos

Kit (dix pièces) de rallonges pour voitures et camions légers

Set contains:

30220 - Aqua (Q)	140 ft/lbs.
30223 - Gray (C)	100 ft/lbs.
30224 - Black (D)	60 ft/lbs.
30225 - Blue (E)	80 ft/lbs.
30226 - Yellow (F)	65 ft/lbs.
30228 - Dark Green (H)	45 ft/lbs.
30229 - White (I)	120 ft/lbs.
30248 - Light Purple (K)	110 ft/lbs.
30249 - Neon Yellow (OO)	75 ft/lbs.
30247 - Gold (NN)	90 ft/lbs.

Item No.	Weight
30251	7.6 lbs (3.5 kg)



TORQUE MASTER®

Individual Sockets & Extensions

Dados y extensiones individuales

Douilles individuelles et rallonges

TORQUE MASTER®

Individual Sockets

Dados individuales

Douilles individuelles

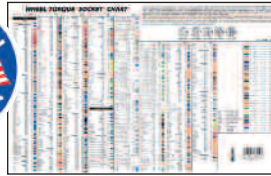

WC 30199

Item No.	Description	Socket Opening	Torque Limit	Weight
30181	Brown (A)	13/16"	100 ft-lbs	.5 lbs (.2 kg)
30182	Orange (B)	21 mm	80 ft-lbs	.5 lbs (.2 kg)
30183	Gray (C)	19 mm (3/4")	100 ft-lbs	.5 lbs (.2 kg)
30184	Black (D)	21 mm	60 ft-lbs	.5 lbs (.2 kg)
30185	Blue (E)	19 mm (3/4")	80 ft-lbs	.5 lbs (.2 kg)
30186	Yellow (F)	19 mm (3/4")	65 ft-lbs	.5 lbs (.2 kg)
30187	Red (G)	17 mm	80 ft-lbs	.5 lbs (.2 kg)
30188	Dark Green (H)	17 mm	45 ft-lbs	.5 lbs (.2 kg)
30189	White (I)	7/8"	120 ft-lbs	.5 lbs (.2 kg)
30195	Tan (J)	1"	140 ft-lbs	.5 lbs (.2 kg)
30196	Light Purple (K)	17 mm	110 ft-lbs	.5 lbs (.2 kg)
30197	Green (L)	1"	170 ft-lbs	.5 lbs (.2 kg)
30198	Crimson Red (V)	1-1/16"	140 ft-lbs	.5 lbs (.2 kg)
30200	Aqua (Q)	7/8"	140 ft-lbs	.5 lbs (.2 kg)
30201	Bright Green (T)	15/16"	135 ft-lbs	.5 lbs (.2 kg)
30202	Navy Blue (Y)	7/8"	100 ft-lbs	.5 lbs (.2 kg)
30203	Light Tan (Z)	7/8"	65 ft-lbs	.5 lbs (.2 kg)
30204	Turquoise (BB)	21 mm	150 ft-lbs	.5 lbs (.2 kg)
30205	Light Pink (CC)	17 mm	90 ft-lbs	.5 lbs (.2 kg)
30206	Sky Blue (DD)	21 mm	100 ft-lbs	.5 lbs (.2 kg)
30207	Safety Purple (EE)	22 mm	140 ft-lbs	.5 lbs (.2 kg)
30208	Yellow Gray (FF)	19 mm	180 ft-lbs	.5 lbs (.2 kg)
30211	Quartz Gray (KK)	19 mm	120 ft-lbs	.5 lbs (.2 kg)
30212	Fuchsia (LL)	22 mm	175 ft-lbs	.5 lbs (.2 kg)
30213	Gold (NN)	19 mm	90 ft-lbs	.5 lbs (.2 kg)
30214	Salmon (QQ)	22 mm	95 ft-lbs	.5 lbs (.2 kg)
30216	Deep Purple (UU)	14 mm	75 ft-lbs	.5 lbs (.2 kg)
30217	Vanilla (XX)	13/16"	160 ft-lbs	.5 lbs (.2 kg)
30218	Honey Yellow (JJ)	19 mm	145 ft-lbs	.5 lbs (.2 kg)
30222	Silver Sparkle (SS)	21 mm	110 ft-lbs	.5 lbs (.2 kg)
30199	11" x 17" Application Wall Chart (WC)			.5 lbs (.2 kg)
30299	22" x 24" Laminated Socket Torque Wall Chart			.5 lbs (.2 kg)

WARNING: Torque sockets and truck torque extensions cannot be used to take off wheel nuts. Calibrate your impact gun and follow all manufacturers' recommended procedures when using Torque Master products.

TORQUE MASTER®

Individual Torque Extensions

Extensiones de torsión individuales

Rallonges de couple individuelles



Item No.	Description	Drive Size Socket/Opening	Torque Limit	Weight
30255	Black Oxide (A)	3/8"	30 ft-lbs	.5 lbs (.2 kg)
30256	Black Oxide (B)	3/8"	40 ft-lbs	.5 lbs (.2 kg)
30257	Black Oxide (C)	3/8"	50 ft-lbs	.5 lbs (.2 kg)
30258	Black Oxide (D)	3/8"	60 ft-lbs	.5 lbs (.2 kg)
30219	Orange (B)	1/2"	160 ft-lbs	.7 lbs (.3 kg)
30220	Aqua (Q)	1/2"	140 ft-lbs	.7 lbs (.3 kg)
30221	Light Blue (S)	1/2"	55 ft-lbs	.7 lbs (.3 kg)
30223	Gray (C)	1/2"	100 ft-lbs	.7 lbs (.3 kg)
30224	Black (D)	1/2"	60 ft-lbs	.7 lbs (.3 kg)
30225	Blue (E)	1/2"	80 ft-lbs	.7 lbs (.3 kg)
30226	Yellow (F)	1/2"	65 ft-lbs	.7 lbs (.3 kg)
30227	Fuchsia (LL)	1/2"	175 ft-lbs	.7 lbs (.3 kg)
30228	Dark Green (H)	1/2"	45 ft-lbs	.7 lbs (.3 kg)
30229	White (I)	1/2"	120 ft-lbs	.7 lbs (.3 kg)
30243	Turquoise (G)	1/2"	150 ft-lbs	.7 lbs (.3 kg)
30244	Bright Green (T)	1/2"	135 ft-lbs	.7 lbs (.3 kg)
30247	Gold (NN)	1/2"	90 ft-lbs	.7 lbs (.3 kg)
30248	Light Purple (K)	1/2"	110 ft-lbs	.7 lbs (.3 kg)
30249	Neon Yellow (OO)	1/2"	75 ft-lbs	.7 lbs (.3 kg)
30250	Green (L)	1/2"	170 ft-lbs	.7 lbs (.3 kg)

TORQUE MASTER®

Individual Heavy-Duty Truck Torque Extensions

Extensiones de torsión individuales de alta resistencia para camiones

Rallonges individuelles robustes de couple pour camions

Convert your own sockets into torque sockets for use on commercial, heavy-duty trucks, and buses.



Item No.	Description	Drive Size Socket/Opening	Torque Limit	Weight
30230	Yellow (O)	3/4"	175 ft-lbs	.75 lbs (.3 kg)
30231	Yellow (N)	3/4"	250 ft-lbs	.75 lbs (.3 kg)
30232	Yellow (U)	3/4"	350 ft-lbs	.75 lbs (.3 kg)
30233	Yellow (M)	3/4"	475 ft-lbs	.75 lbs (.3 kg)
30236	Yellow (T)	1"	175 ft-lbs	1 lb (.5 kg)
30237	Yellow (R)	1"	250 ft-lbs	1 lb (.5 kg)
30238	Yellow (S)	1"	350 ft-lbs	1 lb (.5 kg)
30239	Yellow (P)	1"	475 ft-lbs	1 lb (.5 kg)
30240	Yellow (W)	1"	650 ft-lbs	1 lb (.5 kg)
30241	Yellow (Q)	1"	300 ft-lbs	1 lb (.5 kg)
30242	Yellow (Y)	1"	550 ft-lbs	1 lb (.5 kg)

Wheel Cover & Wheel-Lock Removal Kits

Juego de extracción de cubiertas y anillos de retención de ruedas

Kit d'outils de démontage des enjoliveur et bloqueur de roue

Nine Piece Kit

Juego de nueve piezas

Kit neuf pièces

Remove and replace GM, Ford, Chrysler hubcap locks and aftermarket wheel lug locks without the factory issued key.

Save time! Will not damage the lock or stud.

Set contains:

- 30170-10 Ford & Chrysler Hubcap Locks/Lg. GM Triangle Wheel locks
- 30170-20 GM Spline Hubcap Locks
- 30170-30 GM Hubcap Locks
- 30170-40 18 mm Lugs/GM Wheel Cover Locks/Ford Wheel Locks
- 30170-50 Corvette/GM "N" & "F" Body Wheel Locks
- 30170-60 Std. McGard-Style Wheel Locks/Lg. GM Wheel Cover
- 30170-70 Oversized McGard-Style Wheel Locks
- 30170-80 Punch
- 30170-90 Lg. Dia. Chrysler Lock



Item No.	Drive	Weight
30170	1/2"	3.1 lbs (1.4 kg)

Thirteen Piece Kit

Juego de trece piezas

Kit treize pièces

Set contains:

- 30170-10 Ford & Chrysler Hubcap Locks/Lg. GM Triangle Wheel Locks
- 30170-20 GM Spline Hubcap Locks
- 30115-02 3/4", 19mm Damaged Wheel Lug & Oversized Wheel Lock Remover
- 30170-30 GM Hubcap Locks
- 30115-05 7/8" Damaged Wheel Lug & Oversized Wheel Lock Remover
- 30170-40 18 mm Lugs/GM Wheel Cover Locks/Ford Wheel Locks
- 30171-45 18 mm Nut/Corvette GM Lock
- 30170-50 Corvette/GM "N" & "F" Body Wheel Locks
- 30170-60 Std. McGard-Style Wheel Locks/ Lg. GM Wheel Cover
- 30170-70 Oversized McGard-Style Wheel Locks
- 30170-80 Punch
- 30170-90 Lg. Dia. Chrysler Lock
- 30110-06 3" Impact Extension



Item No.	Drive	Weight
30171	1/2"	4.9 lbs (2.2 kg)

Twist Sockets & Twist Socket Sets

Dados giratorios y juegos de dados giratorios

Douilles de torsion & jeux de douilles de torsion

Twist sockets are specifically designed to easily remove damaged, rounded or corroded nuts, wheel lugs, bolts, pipes, pipe nipples or studs. Simply place the socket so it barely catches the head of the fastener and turn with an air ratchet, hand ratchet, or breaker bar. The unique spiral fluting bites onto the damaged fastener and won't let go. Designed for general automotive applications.

Five Piece Deep Twist Socket Set

Juego de dados giratorios profundos de cinco piezas

Jeu de cinq douilles profondes de torsion

Socket sizes:

- 30116-02 19 mm, 3/4" socket
- 30116-04 13/16" socket
- 30116-05 7/8" socket
- 30116-07 15/16" socket
- 30116-08 1" socket



Item No.	Description	Drive	Weight
30116	5 Pc. Set w/Organizer Bar	1/2"	2.5 lbs (1.1 kg)

Eight Piece Twist Socket Set

Juego de dados giratorios de ocho piezas

Jeu de huit douilles de torsion



Socket sizes:

- 30117-06 6 mm socket
- 30117-08 8 mm socket
- 30117-10 10 mm socket
- 30117-12 12 mm socket
- 30117-13 13 mm socket
- 30117-14 14 mm socket
- 30117-15 15 mm socket
- 30117-17 17 mm socket



Item No.	Description	Drive	Weight
30117	8 Pc. Set w/Organizer Bar	1/4"	.9 lbs (.4 kg)

Nine Piece Twist Socket Set

Juego de dados giratorios de nueve piezas

Jeu de neuf douilles de torsion



Socket sizes:

- 30106-05 10 mm socket
- 30106-07 7/16", 11 mm socket
- 30106-11 12 mm socket
- 30106-13 13 mm socket
- 30106-15 14 mm socket
- 30106-19 15 mm socket
- 30106-21 5/8", 16 mm socket
- 30106-25 17 mm socket
- 30106-27 3/4", 19 mm socket



Item No.	Description	Drive	Weight
30109	9 Pc. Set w/Organizer Bar	3/8"	2.8 lbs (1.2 kg)

Thirteen Piece Twist Socket Set

Juego de dados giratorios de trece piezas

Jeu de treize douilles de torsion



Socket sizes:

- 30106-01 3/8" socket
- 30106-05 10 mm socket
- 30106-07 7/16", 11mm socket
- 30106-09 1/2" socket
- 30106-11 12 mm socket
- 30106-13 13 mm socket
- 30106-15 14 mm socket
- 30106-17 9/16" socket
- 30106-19 15 mm socket
- 30106-21 5/8", 16 mm socket
- 30106-23 11/16" socket
- 30106-25 17 mm socket
- 30106-27 3/4", 19 mm socket



Item No.	Description	Drive	Weight
30108	13 Pc. Set w/Organizer Bar	3/8"	1.6 lbs (.7 kg)

Five Piece Twist Socket Set with Punch

Juego de dados giratorios de cinco piezas con punzón

Jeu de cinq douilles de torsion avec poinçon



Socket sizes:

- 30118-03 19 mm, 3/4" socket
- 30118-04 13/16" socket
- 30118-05 7/8" socket
- 30118-06 15/16" socket
- 30118-07 1" socket
- 30170-80 Punch



Item No.	Description	Drive	Weight
30118	5 Pc. Set w/Plastic Case	1/2"	2 lbs (.9 kg)

Nine Piece Twist Socket Set with Punch

Juego de dados giratorios de nueve piezas con punzón

Jeu de neuf douilles de torsion avec poinçon

Socket sizes:

- 30106-05 10 mm socket
- 30106-07 7/16", 11mm socket
- 30106-11 12 mm socket
- 30106-13 13 mm socket
- 30106-15 14 mm socket
- 30106-19 15 mm socket
- 30106-21 5/8", 16 mm socket
- 30106-25 17 mm socket
- 30106-27 3/4", 19 mm socket
- 30170-80 Punch



Item No.	Description	Drive	Weight
30107	9 Pc. Set w/Plastic Case	3/8"	1.5 lbs (.7 kg)

Thirteen Piece Twist Socket Set with Punch

Juego de dados giratorios de trece piezas con punzón

Jeu de treize douilles de torsion avec poinçon

Socket sizes:

- 30106-01 3/8" socket
- 30106-05 10 mm socket
- 30106-07 7/16", 11 mm socket
- 30106-09 1/2" socket
- 30106-11 12 mm socket
- 30106-13 13 mm socket
- 30106-15 14 mm socket
- 30106-17 9/16" socket
- 30106-19 15 mm socket
- 30106-21 5/8", 16 mm socket
- 30106-23 11/16" socket
- 30106-25 17 mm socket
- 30106-27 3/4", 19 mm socket
- 30170-80 Punch



Item No.	Description	Drive	Weight
30106	13 Pc. Set w/Plastic Case	3/8"	1.9 lbs (.9 kg)

Ten Piece Slim Twist Socket Set with External Hex

Juego de dados giratorios delgados con cuadro hexagonal externo

Jeu de dix douilles minces de torsion avec extérieur hexagonal

Quickly removes damaged or rounded nuts, bolts, studs, and socket head cap screws in tight quarters. The through hole design allows them to also be used on long studs. Fits SAE sizes 3/8" to 3/4" and metric sizes from 9mm up to 19mm. Used where standard twist sockets will not fit. Can be used with an open-end wrench, or with a socket.

Socket sizes:

- 30270-01 9 mm ; ext. hex 5/8" socket
- 30270-02 10 mm, 3/8" ; ext. hex 5/8" socket
- 30270-03 11 mm, 7/16" ; ext. hex 11/16" socket
- 30270-04 12 mm ; ext. hex 3/4" socket
- 30270-05 13 mm, 1/2" ; ext. hex 3/4" socket
- 30270-06 14 mm, 9/16" ; ext. hex 13/16" socket
- 30270-07 15 mm ; ext. hex 7/8" socket
- 30270-08 16 mm, 5/8" ; ext. hex 15/16" socket
- 30270-09 17 mm, 11/16" ; ext. hex 1" socket
- 30270-10 19 mm, 3/4" ; ext. hex 1-1/16" socket

Item No.	Description	Drive	Weight
30270	10 Pc. Set w/Organizer Bar	3/8"	1 lb (.5 kg)
30271	10 Pc. Set w/Plastic Case	3/8"	1 lb (.5 kg)

DISCONTINUED



Individual Twist Sockets - Fluted

Dados giratorios individuales, estriados

Douilles de torsion individuelles - cannelées



Item No.	Socket Sizes	Fluted	Drive	Weight
30151	3/4", 19 mm & 13/16", 21 mm	12	1/2"	.4 lbs (.18 kg)
30152*	3/4", 19 mm & 13/16", 21 mm	6	1/2"	.4 lbs (.18 kg)
30153	7/8" x 1"	12	1/2"	.4 lbs (.18 kg)
30154*	7/8" x 1"	6	1/2"	.4 lbs (.18 kg)

*Includes punch pin

Flip Sockets & Impact Socket Sets

Dados abatibles y juegos de dados impacto

Douilles inversées & jeux de douilles à choc

Three Piece 6-Fluted Twist Flip Socket Set

Juego de dados abatibles giratorios con 6 estrías, tres piezas

Jeu de trois douilles de torsion inversées à 6 cannelures

Socket sizes:

- 30152 19 mm & 13/16", 21 mm socket, 6-Fluted
- 30154 7/8" & 1" socket
- 30110-06 3" extension



Item No.	Description	Drive	Weight
30101	3 Pc. Set w/Plastic Case	1/2"	1.3 lbs (.6 kg)

Three Piece 12-Fluted Twist Flip Socket Set

Juego de dados abatibles giratorios con 12 estrías, tres piezas

Jeu de trois douilles de torsion inversées à 12 cannelures

Socket sizes:

- 30151 19 mm & 13/16", 21 mm socket
- 30153 7/8" & 1" socket
- 30110-06 3" extension



Item No.	Description	Drive	Weight
30102	3 Pc. Set w/Plastic Case	1/2"	1.3 lbs (.6 kg)

Three Piece 6-Pt. & 12-Fluted Twist Flip Socket Set

Juego de dados abatibles giratorios, 6 puntas y 12 estrías, tres piezas

Jeu de trois douilles de torsion inversées à 12 cannelures et 3 points

Socket sizes:

- 30103-01 17 mm socket
- 30103-02 19 mm socket
- 30110-06 3" extension



Item No.	Description	Drive	Weight
30103	3 Pc. Set w/Plastic Case	1/2"	1.3 lbs (.6 kg)

SOCKETS AND SOCKET SETS HAVE A LIMITED LIFETIME WARRANTY

WARNING: Always wear safety goggles when using hand tools

Six Piece Thick and Thin Flip Socket Set*

Juego de dados abatibles gruesos y delgados, seis piezas

Jeu de six douilles inversées fines et épaisses

For those ever changing aftermarket and manufacturers' wheels. One end is a standard 6-point socket for everyday use. Flip socket over and you have a thinwall socket of the same size for wheels with minimal clearance.

Socket sizes:

30112-01 17 mm socket	30112-04 13/16" socket
30112-02 19 mm, 3/4" socket	30112-05 7/8" socket
30112-03 21 mm socket	30110-06 3" extension

Item No.	Drive	Weight
30112	1/2"	3 lbs (1.3 kg)



Three Piece Thinwall Flip Socket Set

Juego de dados abatibles de pared delgada, tres piezas

Jeu de trois douilles inversées à paroi mince

One end is a standard 6-point socket for everyday use. Flip socket over and you have a 6-point socket of larger size.

Socket sizes:

30110-01 19 mm - 21 mm socket
30110-02 3/4" - 13/16" socket
30110-06 3" extension



Item No.	Drive	Weight
30110	1/2"	1.2 lbs (.54 kg)



Six Piece Deep Thinwall Impact Socket Set*

Juego de dados de impacto profundo de pared delgada, seis piezas

Jeu de six douilles profondes à choc à paroi mince

For the difficult aftermarket and manufacturers' wheels.

Socket sizes:

30113-01 17 mm socket	30113-04 13/16" socket
30113-02 19 mm, 3/4" socket	30113-05 7/8" socket
30113-03 21 mm socket	30110-06 3" extension

Item No.	Drive	Weight
30113	1/2"	3 lbs (1.3 kg)



Five Piece Thinwall Flip Socket Set*

Juego de dados abatibles de pared delgada, cinco piezas

Jeu de cinq douilles inversées à paroi mince

One end is a standard 6-point socket for everyday use. Flip socket over and you have a 6-point socket of larger size.

Socket sizes:

30110-01 19 mm - 21 mm socket
30110-02 3/4" - 13/16" socket
30119-03 7/8" - 15/16" socket
30119-04 17 mm - 19 mm socket
30110-06 3" extension

Item No.	Drive	Weight
30119	1/2"	2.1 lbs (1 kg)



Five Piece Double-Duty

Oil Drain Plug Removal Flip Socket Set

Juego de dados abatibles para extracción del tapón del cárter de aceite de doble servicio, cinco piezas

Jeu de cinq douilles inversées à double fonction d'extraction de bouchon de purge d'huile

One end is a standard 6-point socket for everyday use. Flip socket over and you have a twist socket damaged oil drain plug remover of the same size.

Socket sizes:

30114 17 mm socket
30114 19 mm, 3/4" socket
30114-03 14 mm socket
30114-04 15 mm socket
30114-05 16 mm, 5/8" socket

Item No.	Drive	Weight
30114	3/8"	3 lbs (1.3 kg)



Six Piece Double-Duty Flip Socket Set

Juego de dados abatibles de doble servicio, seis piezas

Jeu de six douilles inversées double action

One end is a standard 6-point socket for everyday use. Flip socket over and you have a 6-fluted twist socket for removing damaged or rounded wheel lugs.

Socket sizes:

30111-01 17 mm socket
30111-02 19 mm, 3/4" socket
30111-03 21 mm socket
30111-04 13/16" socket
30111-05 7/8" socket
30110-06 3" extension

Item No.	Drive	Weight
30111	1/2"	2.8 lbs (1.2 kg)



Three Piece Lug & Lock Flip Socket Set

Juego de dados abatibles para trabas/ruedas, tres piezas

Jeu de trois douilles de torsion inversées d'arrêt et de roue

One end is a standard 6-fluted twist socket for removing damaged wheel lugs. Flip socket over and you have a 12-fluted twist socket for removing wheel locks.

Socket sizes:

30115-02 19 mm, 3/4" socket
30115-05 7/8" socket
30110-06 3" extension

Item No.	Drive	Weight
30115	1/2"	1.6 lbs (.7 kg)



Impact Extensions

Extensiones de impacto

Rallonges à choc



	30245	30246
30110-06	1" sq. dr. male x 1" sq. dr. female 13" impact extension. Provides access to hard-to-reach areas with 1" impact socket applications.	3/4" sq. dr. male x 1" sq. dr. male 13" extension. Provides access to deep budd wheels.

Item No.	Description	Drive	Weight
30110-06	3" Impact Extension	1/2"	.4 lbs (.18 kg)
30245	1" Drive x 13" Impact Extension	1/2"	.4 lbs (.18 kg)
30246	3/4" Sq. Dr. Male x 1" Sq. Dr. Male 13" Impact Ext	1/2"	.4 lbs (.18 kg)

SOCKETS AND SOCKET SETS HAVE A LIMITED LIFETIME WARRANTY

*Thinwall sockets have a two-year warranty with proof of purchase

Deep, Thin Wall Flip Socket

Llave de tubo movable, de paredes finas y profundidad

Douille double tête profonde à paroi étroite

1/2" square drive, black impact socket is deep and thin walled to reach areas conventional sockets won't. Flip socket provides two socket sizes which cover virtually all SAE automotive wheel lug sizes. **Imported.**

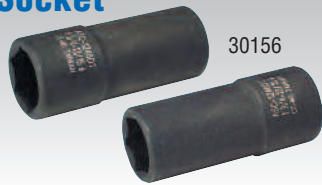

30156

Item No.	Socket Sizes	Drive	Weight
30156	3/4", 13/16"	1/2"	.4 lbs (.18 kg)
30158	19 mm, 21 mm	1/2"	.4 lbs (.18 kg)

Universal Emergency Wheel-Lock Remover

Desmontador universal para anillos de seguridad de ruedas de emergencia

Dégageur de bloqueur de roue universel de secours

Removes wheel locks when the key is lost or misplaced. 1" I.D. Tapered socket fits over most car wheel locks. Use soft-faced hammer to drive onto wheel lock. Limited use.



Item No.	Drive	Weight
30161	1/2"	1 lb (.5 kg)

Heavy-Duty Impact Sockets

Llaves de tubo de impacto de alta resistencia
Douilles résistantes aux chocs

Special Purpose Impact Sockets Off-Road Budd, Square, SAE, and Metric

Llaves de tubo de impacto especializados para todo terreno tipo Budd, cuadrados, de SAE y métricos

Douilles carrées, SAE, métrique ou pour roues à disques, spécialement conçues pour résister aux chocs

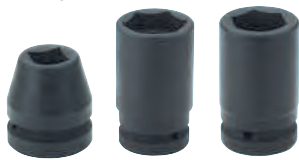

30120

30121

30356

Special 1-1/2" hex deep heavy-duty impact socket designed for outer cap nuts on Budd-style truck wheels. The 1-1/2" hex depth is limited to help prevent socket contact with the wheel. The socket is deep style to eliminate contact with the inner cap nut. **Imported.**

3/4" Drive		1" Drive		Weight
Item No.	Description	Item No.	Description	
30120	13/16" square	30149	13/16" square	1.4 lbs (.6 kg)

Combination Budd Wheel - SAE and Metric

Rueda de combinación tipo Budd- SAE y métrica
Deux en un pour roues à disques - SAE et métrique

3/4" Drive		1" Drive		Weight
Item No.	Description	Item No.	Description	
30121	1-1/2" x 13/16" square	30150	1-1/2" x 13/16" square	3.1 lbs (1.4 kg)

Deep Length Impact Sockets - SAE and Metric

Llaves de tubo de impacto de longitud profunda- SAE y métrica
Douilles de profonde longueur - SAE et métrique

6 point, 3/4" Drive		6 point, 1" Drive		Weight
Item No.	Description	Item No.	Description	
30356	33 mm deep	30366	33 mm deep	1.6 lbs (.7 kg)

Dual Wheel Lug Stud Remover

Desmontador de tuercas para ruedas dobles
Extracteur de goujons de roues de camions à prise double

Special self-tapping splines provide maximum grip to remove stripped lug studs. Use with **TR1**, **TR98** truck wrenches. Can also be used with an open end wrench. Use with soft faced hammer. (see pg. 21)

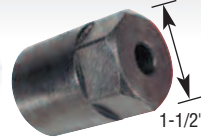

1-1/2"



Special self-tapping splines

Item No.	Description	Weight
30165	Fits 13/16" sq. inner nut	1 lb (.5 kg)

Four Piece Lug Nut Remover Socket Set

Juego de dados para extractor de tuercas de rueda, cuatro piezas
Jeu de douilles d'extracteur (4 pièces) d'écrou de roue

Use for removing wheel locks or damaged lug nuts. Made from chrome-moly steel. Made in Taiwan.

PATENTED

Socket Sizes:

30254-06 - 3/4" Socket	30254-08 - 1" Socket
30254-07 - 13/16" Socket	30254-09 - 1-1/8" Socket



Item No.	Description	Drive	Weight
30254	4 Pc. Lug Nut Remover Socket Set	1/2"	1.4 lbs (.6 kg)

Four Piece Heavy-Duty Wheel Stud Remover Set

Juego de extractores de pernos de ruedas de alta resistencia, cuatro piezas
Jeu d'extracteurs robustes (4 pièces) de goujon de roue

Inner Budd Nut & Wheel Stud Removal Set. Removes damaged wheel studs and inner Budd nuts. Internal tapered reverse Inner Budd Nut & Wheel Stud Removal Set threads lock onto damaged stud or nut and easily pulls off using impact wrench. Wheel Stud Removers are 3/4" hex drive. Budd Nut Removers are 1-1/8" hex drive. Made from chrome-moly steel. 90 PSI maximum. Made in Taiwan.



PATENTED

Impact Socket Sizes:

30649-01 - 5/8" Socket	30649-03 - Budd Wheel Inner Nut LH
30649-02 - 3/4" Socket	30649-04 - Budd Wheel Inner Nut RH

Item No.	Description	Weight
30649	4 Pc. H.D. Wheel Stud Remover Set	3.5 lbs (1.6 kg)

Seven Piece Thin-Wall Impact Socket Set

Juego de dados de impacto de pared delgada, siete piezas
Jeu de douilles à choc (sept pièces) à paroi mince

Non-Marring sockets for delicate wheels with minimal clearance for Car / Light Truck. Made from chrome-moly steel. Made in Taiwan.

Socket Sizes:

30259-03 - 13/16" Socket	30259-08 - 19 mm Socket
30259-04 - 7/8" Socket	30259-09 - 21 mm Socket
30259-05 - 1" Socket	
30259-07 - 17 mm Socket	



Item No.	Description	Drive	Weight
30259	7 Pc. Thin-Wall Impact Socket Set	1/2"	5 lbs (2.3 kg)

Impact Separator Tool

Impacto de la herramienta de separación • Outil impacteur



PATENT
PENDING



35939-01

35939-02

Heavy-duty impact front end service tool. Hits harder and straighter than a hammer, but no more misses or glancing blows. Two easily interchangeable hardened steel forks. Use the T39B-1 fork to separate shock absorber links and tie rods; Use the T39B-2 fork on spindle support arms to remove ball joints without damaging other suspension parts. Services compact cars and light duty trucks too. Made in USA. Includes impact separator tool with 2 forks:

35939-01 = T39B-1 Tie Rod Fork, Fork Opening: 5/8" (2 cm)

35939-02 = T39B-2 Ball Joint Fork, Fork Opening: 15/16" (2 cm)

Model	Item No.	Description	Length	Weight
T39B	35939	Impact Separator Tool w/2 forks	36-1/2" (92.71 cm)	9.8 lbs (4.5 kg)

Front End Service Tools

Herramientas para el mantenimiento delantero



Outils de service du train avant

These tools are manufactured from a single piece of alloy steel, forged, and heat-treated for long life. Essential when replacing suspension parts. Striking ends have been enlarged to provide a bigger and safer striking surface. Painted finish for rust resistance. Ken-Tool offers a size and design for all your needs.

Separator Tool • Herramienta separadora • Séparateur



Use to remove camber adjustment sleeves on Ford 4 x 2 and 4 x 4 pickups. Use as Pitman arm wedge on medium and heavy-duty trucks.

Model	Item No.	Length	Stock	Fork Opening	Weight
B36	32036	11" (28 cm)	7/8" (2 cm)	1-7/16" (4 cm)	1.9 lbs (.8 kg)

Pitman Arm Wedge

Cuña para la biela de mando de la dirección
Coin pour bielle pendante



Removes Pitman arms on cars and light trucks.

Model	Item No.	Length	Stock	Fork Opening	Weight
B37	32037	11" (28 cm)	7/8" (2 cm)	1- 1/8" (3 cm)	1.8 lbs (.8 kg)

Shock Link and Tie Rod Separator

Separador de la barra de acoplamiento y la unión del amortiguador
Fourche à barre d'accouplement et articulation d'amortisseur



Use to separate shock absorber links and tie rods.

Model	Item No.	Length	Stock	Fork Opening	Weight
B39	32039	16" (41 cm)	7/8" (2 cm)	5/8" (2 cm)	2.1 lbs (.9 kg)

Ball Joint Separator

Separador de juntas de rótulas • Séparateur de joint à rotule



Use on spindle support arms to remove ball joints without damaging other suspension parts. Services compact cars and light duty trucks.

Model	Item No.	Length	Stock	Fork Opening	Weight
B40	32040	16" (41 cm)	7/8" (2 cm)	15/16" (2 cm)	2.8 lbs (1.2 kg)

MacPherson Strut Coil Spring Compressor Set

Equipo compresor de resorte espiral de montante
MacPherson

Groupe compresseur de ressort hélicoïdal à jambe de suspension

Compressor works on most MacPherson Strut assemblies and is for use with replacements. Use the compressor when replacing bent strut or strut tube and damaged spindles. Use it on or off the car. Acme threaded screw for durability.

Do not use on General Motors "A", "C", "J", or "X" body cars. **Imported.**

Item No.	Weight
39730	7 lbs (3.1 kg)

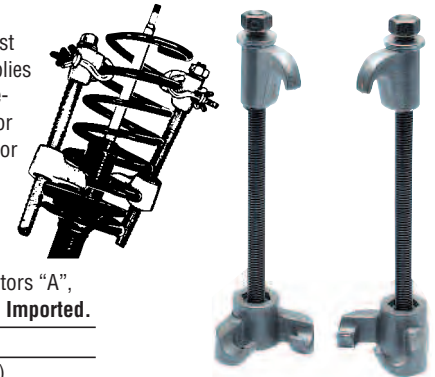

Universal Tie Rod Adjusting Tool

Herramienta universal de ajuste de la barra de acoplamiento



Outil universel pour réglage de barre d'accouplement

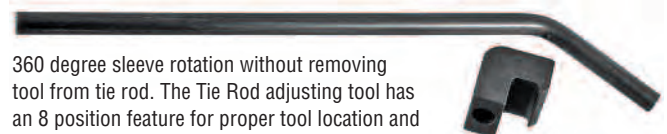

360 degree sleeve rotation without removing tool from tie rod. The Tie Rod adjusting tool has an 8 position feature for proper tool location and works on all car models including 1-ton pick-ups, midsized trucks and large vans.

Item No.	Length	Stock	Weight
32030	14-1/2" (37 cm)	1/2" (1.8 cm)	1.3 lbs (.6 kg)

Heavy Duty Tie Rod End Tool

Herramienta de servicio pesado para el extremo de la barra de acoplamiento



Outil robuste pour embout d'accouplement

The 3/4" square drive Tie Rod Socket is designed for use on 9,000 through 20,000 pound axles or classes 7 & 8. The U-shaped slot measures 1-7/8" x 1-1/2" with an inside diameter of 3" in the socket. The length is 3-1/2".

Item No.	Drive	Weight
32031	3/4" Square	4 lbs (1.8 kg)



Cross-Pein / Blacksmith Hammer

Martillo de mano/de peña

Marteau à panne de travers/de forgeron



High carbon steel with machine polished face.

Top Grade U.S. Hickory Handle

Mango U.S. Hickory de primera calidad

Manche de qualité supérieure U.S. Hickory



Model	Item No.	Length	Face	Eye Size	Head Weight
85H-3	37103	15" (38 cm)	1-5/8"	1 x 1-3/4"	3 lbs (1.4 kg)

85H-3H 37023 15" (38 cm) Replacement Handle

NEW

New England Pattern Hand-Drilling Hammers

Martillos perforadores de mano con patrones de Nueva Inglaterra

Perforateur manuel modèle 'New England'



Top grade U.S. hickory handle.

80H-4

Model	Item No.	Length	Face	Eye Size	Head Weight
80H-3	37003	10" (25 cm)	1-1/2"	1 x 3/4"	3 lbs (1.4 kg)
80H-4	37004	10" (25 cm)	1-5/8"	1 x 3/4"	4 lbs (1.8 kg)

80H-3H 37012 10" (25 cm) Replacement Handle for 80H-3, 80H-4

NEW

Tire Knockers

Golpeadores de llantas

Bâtons de vérification de pression des pneus



Item No.	Length	Weight
35110	18" (46 cm)	.7 lbs (.3 kg)

Double-Face Sledge Hammers

Mazas dobles

Masses à double-face



84H-4

Top Grade U.S. Hickory Handle

Mango U.S. Hickory de primera calidad

Manche de qualité supérieure U.S. Hickory

High carbon steel, heat treated. Machined, polished face.



Model	Item No.	Length	Face	Eye Size	Head Weight
84H-2	37302	15" (38 cm)	1-1/2"	3/4" x 1"	2.5 lbs (1.1 kg)
84H-4	37304	15" (38 cm)	1-3/4"	3/4" x 1"	4 lbs (1.8 kg)
84H-8	37308	36" (91 cm)	2"	1" x 1-3/8"	8 lbs (3.6 kg)
84H-10	37310	36" (91 cm)	2-1/8"	1" x 1-3/8"	10 lbs (4.5 kg)
84H-12	37312	36" (91 cm)	2-1/8"	1" x 1-3/8"	12 lbs (5.4 kg)
84H-16	37316	36" (91 cm)	2-3/8"	1" x 1-3/8"	16 lbs (7.2 kg)
84H-20	37320	36" (91 cm)	3"	2" x 1.5"	20 lbs (9 kg)

85H-3H 37023 15" (38 cm) Replacement Handle for 85H-3, 84H-2, 84H-4

84H-8H 37025 36" (91 cm) Replacement Handle for 84H-8, 84H-10, 84H-12, 84H-16

84H-20H 37089 36" (91 cm) Replacement Handle for 84H-20

NEW

NEW

NEW

2 lb. Rubber Mallet

Mazo de goma de 2 libras

Maillet en caoutchouc de 2 lb

Rubber head minimizes marring surfaces.



Model	Item No.	Handle Length	Head Weight
T32	35310	17" (43 cm)	2 lbs (.9 kg)

WARNING: Always wear safety goggles when using striking or struck tools. Never use one hammer to strike another hammer. Never use a tool with a loose or damaged handle. Discard any striking or struck tool if foot shows dents, cracks, chips, or mushrooming.

Aligning & Pry Bars

Alineación y palancas

Leviers & barras d'alignement



Aligning Bars

Barras de alineación • Barres d'alignement

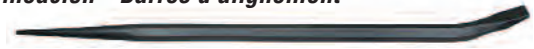

A forged, alloy steel, heat-treated bar that can be used for prying, aligning and positioning many heavier jobs in the shop. The finish is black oxide.

Item No.	Stock	Length	Weight
7025	5/8" (16 mm)	18" (45.7 cm)	1.4 lbs (.6 kg)
7026	3/4" (19 mm)	20" (50.8 cm)	2.3 lbs (1 kg)
7027	3/4" (19 mm)	24" (61 cm)	2.8 lbs (1.3 kg)
7028	7/8" (22 mm)	30" (76.2 cm)	5 lbs (2.3 kg)

Close Quarters Bars

Barras de cuartos cerrados • Barres à distance rapprochée



These bars are made of forged, alloy steel, and heat-treated. Designed for use in tight spots, their balanced construction provides very powerful leverage. The finish is black oxide.

Item No.	Stock	Length	Weight
7030	3/8" (10 mm)	9" (22.9 cm)	.31 lbs (.14 kg)
7031	1/2" (13 mm)	16" (40.6 cm)	.89 lbs (.4 kg)
7032	5/8" (16 mm)	18" (45.7 cm)	1.5 lbs (.7 kg)

Die Setter Bars

Barras troqueladoras • Barres de monteur de matrices



A practical and useful shop tool for the quick separation of punch and die holder. The bars are made of forged, alloy steel and heat-treated for strength. The finish is black oxide.

Item No.	Stock	Length	Weight
7035	5/8" (16 mm)	18" (45.7 cm)	1.7 lbs (.8 kg)
7037	3/4" (19 mm)	30" (76.2 cm)	4.2 lbs (1.9 kg)

Dead Blow Hammers

Martillos de golpe seco • Masse sans rebond

Head is shot filled for maximum force with no bounce effect. Safest non-marring, non-sparking hammers available. Great for tire changing and general shop use. High quality materials to withstand years of hard use.



Economy Strike Pro®

Económico • Économique

Dead blow action in high visibility colors.

T336



Model	Item No.	Color	Length	Nominal Weight
T335	35335	Safety Yellow	12" (31 cm)	1 lb (.5 kg)
T336	35336	Safety Orange	12" (31 cm)	1.5 lbs (.7 kg)

Professional Dead Blow

Martillo de golpe seco profesional

Masse professionnelle sans rebond

Power-drive fiberglass handle gives 20% more driving power, yet reduces user fatigue.

TG337 Steel face



Model	Item No.	Description	Length	Nominal Weight
TG332	35332	2 lb Head (.9 kg)	13-1/2" (34 cm)	1.9 lbs (.9 kg)
TG333	35333	3 lb Head (1.4 kg)	14-1/2" (37 cm)	2.7 lbs (1.2 kg)
TG334	35334	4 lb Head (1.8 kg)	15-1/2" (40 cm)	3.4 lbs (1.5 kg)
TG337	35337	Steel Face / Soft Face	13-1/2" (34 cm)	2.2 lbs (1 kg)



Ken-Tool®
 WHEREVER TIRES ARE CHANGED™



FREE ON-LINE VIDEO DEMOS

Easy access to on-line demonstrations and product information

Watch our products demonstrated in real world applications and see the importance and value of working with the right tools and equipment.



Check out our T111 Earth Mover tire test to see why every tire shop should invest, and use, their tire inflation cage.

36012 (see page 35)

Throughout this catalog watch for YouTube symbols that indicate one or more videos are available for the product you are reviewing. Then go to www.youtube.com/kentoolvideomedia to find a selection of videos for our products.

You can also scan the barcode with your Smartphone to get a link to our YouTube videos or details on how to Contact us at Ken-Tool.



www.kentool.com

www.youtube.com/kentoolvideomedia

CROSS-REFERENCE BY MODEL NUMBER

ITEM NO.	MODEL NO.	PAGE NO.	ITEM NO.	MODEL NO.	PAGE NO.	ITEM NO.	MODEL NO.	PAGE NO.	ITEM NO.	MODEL NO.	PAGE NO.	ITEM NO.	MODEL NO.	PAGE NO.	ITEM NO.	MODEL NO.	PAGE NO.
37003	80H-3	47	32118	T8	19	33025	T22M	19	34749	T46C	16	36015	T115	37	35795	TM95	29
37012	80H-3H	24, 47	32109	T9A	19	31820	T22R	19	34846	T47	16	36016	T116	37	32501	TR1	31
37004	80H-4	47	32110	T9C	19	32123	T23	20	34847	T47A	16	36017	T117	37	32502	TR2	31
37310	84H-10	47	35529	T11AH	24	33223	T23A	20	34848	T47B	16	36018	T118	37	32512	TR2A	31
37312	84H-12	47	35311	T11B	24	33224	T23B	20	34849	T47C	16	36019	T119	36	32503	TR3	31
37316	84H-16	47	35111	T11BH	24	35924	T24B	22	34648	T48A	20	31431	T131	27	32505	TR3A	31
37302	84H-2	47	35119	T11CH	24	32125	T25	20	31551	T51	27	31432	T132	27	32506	TR3X	31
37320	84H-20	47	35327	T11D	23	32126	T26A	22	34652	T52	22	31433	T133	27	32318	TR5	31
37304	84H-4	47	35127	T11DH	24	35926	T26B	22	31554	T54	27	35847	T147A	26	32319	TR5A	31
37308	84H-8	47	35329	T11E	23	32127	T27	20	35656	T56	29	35847S	T147A	26	32509	TR9	31
37025	84H-8H	24, 47	35129	T11EH	24	32128	T27A	20	35657	T57	29	35335	T335	47	34401	TR10	31
37089	84H-20H	24, 47	35131	T11EHS	24	35310	T32	47	35659	T59	29	35336	T336	47	34402	TR11	31
37103	85H-3	47	35330	T11ES	11, 15, 23	35317	T33R	24	35661	T61	29	38600	T600	25	34543	TR43	30
37023	85H-3H	24, 47	35113	T11HN	24	35321	T34	24	35662	T62	29	38601	T601	25	34547	TR44SW	30
30511	B111	26	35460	T11K	23	35934	T34B	23	35663	T63	29	34950	T950	21	34545	TR44X	30
35354	B230	27	35230	T11KH	24	35105	T34RH	24	31567	T67	28	35620	T9520	29	32508	TR98	31
35355	B232	27	35104	T11RH	24	35323	T35	11, 15, 24	31568	T68	28	35449	T2001	17	32519	TR99	31
32036	B36	46	35201	T12B	24	35325	T36	24	35690	T90	29	35450	T2002	17	32551	TRM1	31
32037	B37	46	35202	T12D	24	35936	T36B	23	35695	T95	29	35447	T2005	18	32552	TRM2	31
32039	B39	46	30515	T15	27	33238	T38	19	35697	T95A	29	35448	T2006	18	32553	TRM3	31
32040	B40	46	32116	T16A	19	35938	T38B	23	35696	T96	29	35595	TC95	29	32556	TRM6	31
35805	D105A	26	32117	T16C	19	33239	T39	19	35998	T98	22	35411	TG11B	24	32559	TRM6A	31
64055	K55	39	30215	T16P	27	35939	T39B	46	34670	T100	22	35211	TG11BH	24	32557	TRM7	31
64065	K65	39	32119	T19	19	33341	T41	22	36001	T101	35	35219	TG11CH	24	34678	TS42	25
39604	KT-4	39	33219	T19A	19	33342	T42	22	36007	T101A	35	35427	TG11D	23	34672	TS72	25
39606	KT-6	39	33022	T19M	19	39805	T43A	19	36002	T102	35	35227	TG11DH	24	34674	TS74	25
39608	KT-8	39	32120	T20	19	39806	T43C	19	36003	T103	35	35429	TG11E	23	30609	TX9	28
64650	KT4650	39	33220	T20A	19	39810	T43D	19	36004	T104	35	35229	TG11EH	24	30610	TX10	28
64800	KT4800	39	33023	T20M	19	39808	T44	19	36005	T105	35	35206	TG31H	24	30612	TX12	28
35820	R20	29	33020	T21A	19	34645	T45A	11, 15, 16	36006	T106	35	35417	TG33R	24	30620	TX50	28
35623	R23	29	34121	T21F	19	34644	T45A-2000K	16	36008	T108	35	35421	TG34	24	30618	TX200	28
35624	R24	29	34122	T21HD	19	34645C	T45AC	11, 15, 16	36009	T109	36	35423	TG35	24	30619	TX241	28
35627	R90	30	33024	T21M	19	34649	T45AS	16	36010	T110	36	35425	TG36	24			
32101	T1X	19	32121	T21R	19	34647	T45HD	16	36011	T111	36	35332	TG332	47			
32102	T2X	19	33021	T22A	19	34746	T46	16	36012	T112	36	35333	TG333	47			
32115	T5	19	32420	T22F	19	34747	T46A	16	36013	T113	37	35334	TG334	47			
32106	T6A	19	33026	T22HD	19	34748	T46B	16	36014	T114	37	35337	TG337	47			



Inventors Wanted!

*If you have an idea for a
new tool please let us know!
Your idea could earn you
cash or a royalty.*

*Just visit our website at
www.kentool.com/inventors
to submit your idea for
consideration!*



Throughout this catalog watch for YouTube symbols that indicate one or more videos are available for the product you are reviewing. Then go to www.youtube.com/kentoolvideomedia to find a selection of videos for our products. You can also scan the barcode with your Smartphone to get a link to our YouTube videos or details on how to contact us at Ken-Tool.

We believe all Ken-Tool customers should be satisfied with the performance, quality and workmanship of whatever product they buy. All Ken-Tool products are warranted against defects in materials and workmanship for one year from the date of purchase. Any Ken-Tool branded product that fails to perform its intended function, due to a defect in workmanship or materials will, at our option, be replaced or repaired free of charge. Warranty claims for items that have broken or are no longer useful due to normal wear, misuse, abuse, alteration, grinding, or heating, will not be honored. Proof of purchase including the purchase date is required for warranty consideration. Please contact Ken-Tool by phone or email if you have a warranty claim.

Distributed By:



768 E. North Street, P.O. Box 9320
Akron, Ohio 44305

Toll Free: 888-536-8665 • Fax: 800-872-4929

Phone: 330-535-7177 • Fax: 330-535-1345

E-mail: sales@kentool.com • www.kentool.com